



Beta



2024
TARIF

Valable jusqu'au 28/02/2025
Hors T.V.A.



R • PETER AG

BETA EST SYNONYME DE
AUDACE. ENGAGEMENT. HARMONIE. TALENT.



Chez Beta, il n'existe qu'une seule manière de faire les choses : les faire bien.

Le monde de Beta est guidé par le principe de labeur quotidien dans le monde entier, qui s'inspire de quatre valeurs :

L'AUDACE *d'investir et de rebooster constamment une entreprise créée par un artisan italien en 1923, qui s'est affirmée dans le monde et n'a cessé de croître depuis quatre générations.*

L'ENGAGEMENT *de peaufiner la qualité de nos produits jusque dans les moindres détails, car chaque revendeur sait qu'il peut compter sur un service efficace, et chaque utilisateur sur la précision, la fiabilité et la solidité des produits Beta.*

L'HARMONIE *des lignes pour un design d'excellence, car les choses bien faites expriment un équilibre parfait entre fonction et design.*

LE TALENT *notre plus grande ressource, celle qui distingue notre effectif et tous ceux qui choisissent Beta pour ne rien laisser au hasard, dans la réalisation passionnante de leurs idées et de leurs rêves.*

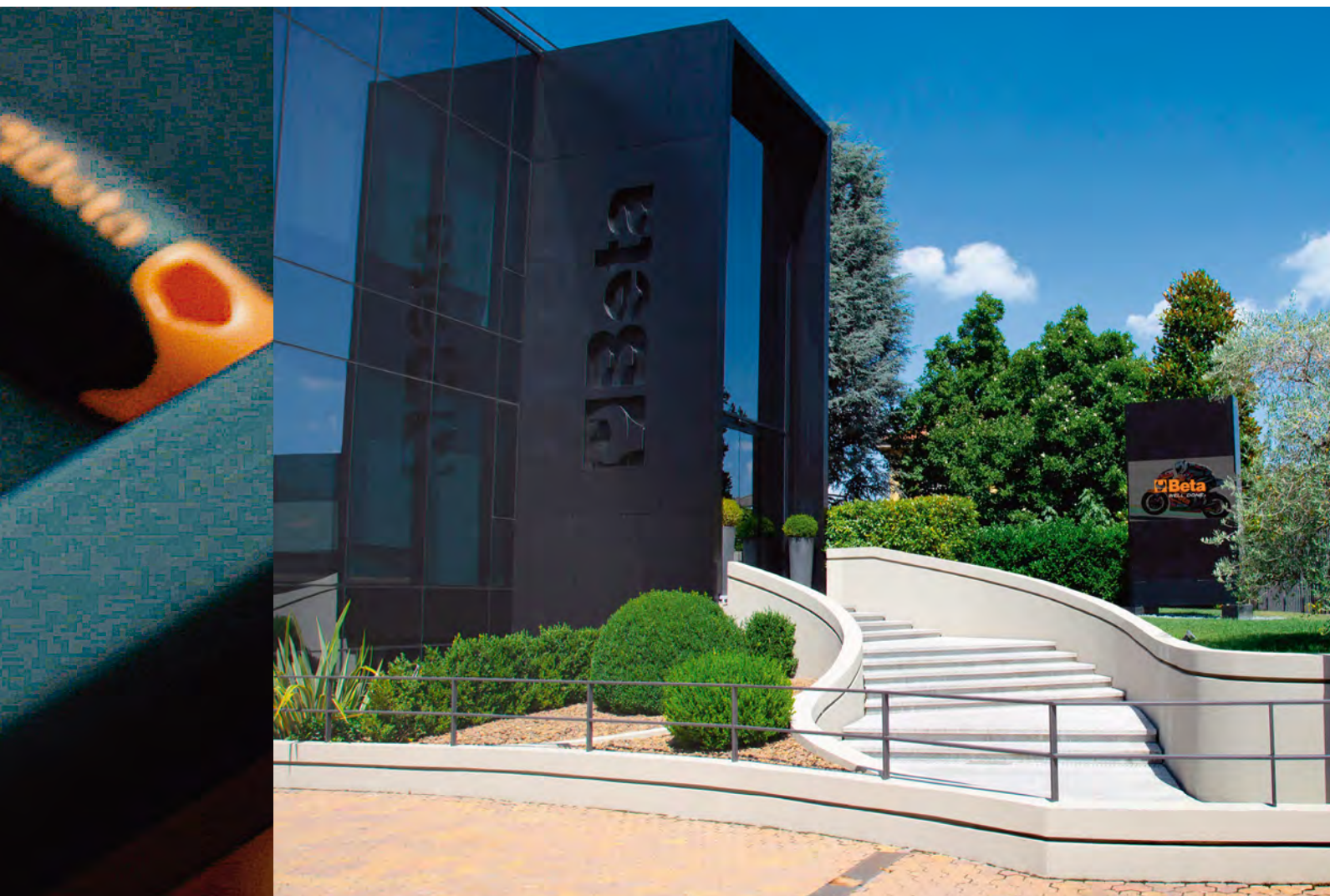

INDEX



Index.....	4
Guide de lecture.....	8
Champs d'utilisation clés dynamométriques	58-59
Tableau des servantes et compositions	351, 479-480
Articles supprimés = articles de remplacement/recommandés ..	727÷729
Index alphabétique	730÷734
Index alphabétique outils pour réparation automobile	735÷737
Index alphanumérique	738÷753
Numéros clés du Groupe Beta.....	754
L'histoire de l'outillage en Italie	755
Qualité certifiée	756
Contrôle et qualité.....	757
Logistique	758
Organiser le travail.....	759
Présence efficace	760

INDEX

AMEUBLEMENT DE L'ATELIER RSC55



RSC55

410÷435; 475÷478

AMEUBLEMENT DE L'ATELIER RSC50



Beta
RSC50

436÷453; 475÷478

AMEUBLEMENT DE L'ATELIER C45PRO



Beta
C45PRO

454÷478

MOBILIER D'ATELIER ET COMPOSITIONS D'OUTILS



351÷370



371÷400



383; 401÷409



479÷561

CLÉS DE SERRAGE



11÷17

23÷27

112÷117

DOUILLES ET ACCESSOIRES



69÷78

85÷112

CLÉS DYNAMOMÉTRIQUES ET MULTIPLICATEURS



54÷56

57÷69

TOURNEVIS, CLÉS MÂLES ET EMBOUTS POUR VISSEUSES



18÷23

78÷85

114÷117

145÷159

PINCES ET PINCES COUPANTES



127÷134

139÷142

236

MARTELLERIE ET FRAPPE



9-10

166÷170

217÷218

OUTILS POUR PERCER ET FILETER



36÷41

41÷43

44÷51

51÷53

EXTRACTEURS



171÷172

198÷204

OUTILS DE MESURAGE ET TRAÇAGE



210÷217

ÉCLAIRAGE



242÷247

ENROULEURS



247÷249; 347

PLOMBERIE



27÷35

ÉLECTRONIQUE ET MICROMÉCANIQUE



126-127

142÷144

148÷151

OUTILS DE COUPE ET D'ENTRETIEN DIVERS



122÷123

134÷136

158÷159

184



209

219÷228



238÷241

325÷326

MICROTECHNIQUE

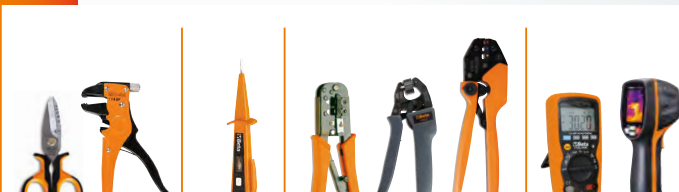

136÷139

150

585÷587

232÷236

SOUDEURS



250÷254

OUTILS AVEC POIGNÉE CONFORT EN 1000V



285÷291

OUTILS EN ACIER INOXYDABLE



299÷303

OUTILS ANTIDÉFLAGRANTS



304÷312

RÉPARATION AUTOMOBILE



118÷125

160÷166



170÷198; 204÷208

229÷232

232÷238

ÉQUIPEMENT D'ATELIER



254÷273

OUTILS POUR MOTOCYCLES



274÷279

OUTILS POUR VÉLOS



280÷284

OUTILLAGE ELECTROPORTEATIF



313÷324

OUTILLAGE PNEUMATIQUE ET ACCESSOIRES



327÷350

OUTILS ANTI-CHUTE



292÷298

BETA CHEMICAL



562÷567

CHAUSSURES DE SÉCURITÉ (ET CHAUSSETTES TECHNIQUES)



624÷649

BETA ABRASIVES



568÷584

WORKWEAR



650÷670

PRODUITS DE MARQUE BM : COLLIERS, BORNIER, RUBANS ISOLANTS



588÷594

GAMME BLISTER



595÷609

ACCESSOIRES POUR CÂBLES **ROBUR**



671÷714

SOLUTIONS POUR LE POINT DE VENTE



610÷623

BETA COLLECTION



715÷726

GUIDE DE LECTURE

référence de l'article

951GP

Clés en T avec extrémité mâle 6 pans

La clé 951GP de Beta permet un ajustement rapide et précis d'une vis. Elle a été conçue pour répondre à certaines exigences des sports mécaniques : faire un serrage rapide avec des couples élevées.

empreinte de l'outil



prix

★ article disponible sur demande

• mesure principale

○ bouche hexagonale

conditionnement

n.° of tools per box

nombre d'outils d'un jeu

présentation

contenu d'un jeu

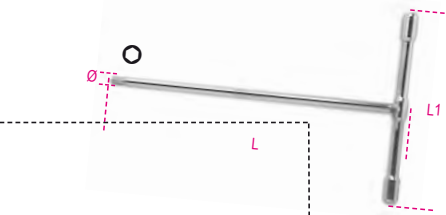

mm	L mm	L1 mm	Ø mm	CHF	
3	185	130	5	23.60	3 009511530
4	214	150	5	24.80	3 009511540
5	240	165	6	28.50	3 009511550
6	271	180	7	33.00	3 009511560
8	300	200	10	42.00	3 009511580
10	310	200	12	52.00	3 009511610

code commande

nouveauté 2024

951GP/S6	CHF	
3-4-5-6-8-10 mm	204.00	1 009511687

confection blister



outils pour motos



outils pour vélos



Interprétation des sigles les plus courants

Pour les jeux d'articles

Exemples	
B	= en trousse plastique 42/B9N
BV	= trousse vide 2002/BV9
C	= en coffret tôle 900/C11
D	= en emballage accrochable 1293/D6
S	= en boîte 42/S17
SP	= sur présentoir 42/SP25
SPV	= présentoir vide 42/SPV7
SC	= avec support compact 96/SC9
SCV	= support compact vide 96/SCV

Pour les compositions

AS	= avec des clés de dimensions en pouces 5915VU/AS
E	= version Électronique/Microtechnique 5980ET/A
I	= version hydraulique 5980ID
MT	= version engins de chantier 5902MT
U	= version générale 5915VU/3
SBK	= version Réparation Motos 5940SBK
VG	= version réparation automobile 5904VG/5T
VI	= version industrielle 5902VI

Pour les douilles

A	= empreinte 6 pans 910A
B	= empreinte 12 pans 910B
ES	= empreinte 6 pans cannelés 920ES
FTX	= empreinte TORX® 910FTX

Interprétation des sigles les plus courants

Exemples

PT	= vis en étoile à 5 pointes 910PT
X	= cliquet réversible en coffret 920A/C12X

Pour les tournevis et embouts pour visseuses

LP	= pour vis à fente 920LP
PE	= pour vis 6 fente creux 920PE
PH	= pour vis à empreinte PHILLIPS® 920PH
PZ	= pour vis à empreinte POZIDRIV® - SUPADRIV® 1299PZ
RTX	= pour vis à empreinte TAMPER RESISTANT TORX® 1298RTX
SP	= pour vis à empreinte SPANNER 861SP
TRW	= pour vis à empreinte TRI-WING® 861TRW
TQS	= pour vis à empreinte TORQ-SET® 861TQS
TX	= pour vis à empreinte TORX® 920TX
XZN	= pour vis à empreinte XZN® 920XZN

Génériques

AS	= dimensions en pouces 42AS
BA	= outillage anti-déflagrant 42BA
BM	= manche bi-matières 1150BM
C	= coffret métallique vide C25
HS	= outils anti-chute 42HS
INOX	= outils en acier inoxydable 42 INOX
L	= série longue 952L
MQ	= avec poignée confort en 1000V 1150MQ
MP	= finition polie chromée 42MP
R	= recharge 338R

Les renseignements et photos figurant dans ce chapitre sont donnés à titre indicatifs et n'ont aucune valeur contractuelle. Beta Utensili se réserve le droit de mettre à jour ou d'accroître sa gamme de produits sans préavis, et sans obligation d'effectuer les modifications sur les modèles vendus antérieurement.



Beta VOUS RECOMMANDE d'utiliser l'outil adapté à la tâche que vous devez effectuer tout en respectant les normes de protection individuelle.



CHASSE-GOUPILLES

Les outils de frappe Beta ont été conçus pour offrir des performances optimales et assurer la sécurité de l'opérateur.

Un type spécial d'acier, qui contient du chrome, du molybdène et du vanadium (65CrMoV2-2) est utilisé pour la production, ce qui donne des outils remarquablement durs et résistants. Les produits sont fabriqués – si leur géométrie le permet – avec des barres étirées, dans le cas contraire ils sont forgés à chaud dans une atmosphère contrôlée, pour éviter la formation de scories.

1 Les chasses-goupilles possèdent des profils hexagonaux empêchant l'outil de rouler.

2 De plus ils sont équipés de pointes extrêmement longues mais parfaitement droites permettant l'accès dans les espaces exigus.

3 Afin de garantir une plus grande efficacité de nos chasses-goupilles, chaque pièce est emboutie individuellement afin que la partie cylindrique soit uniforme et que son extrémité soit parfaitement plate.

4 Toutes les faces sont soumises à une trempe par induction, pour éviter l'éclatement. La déformation du point de frappe est une conséquence naturelle afin que la sécurité de l'opérateur soit assurée.



5 Les poinçons affûtés après avoir été chromés, améliore les performances de gravure et de coupe et élimine le dépôt galvanique des pointes. Les bavures doivent être éliminées pour éviter « l'arrondi » des coins et la fragilité dus à la quantité d'hydrogène produite lors de la galvanoplastie. Les zones travaillées sont protégées par une couche antirouille.



30

Chasse-clous



Ø mm	L mm	CHF	Hand	PC
2	125	9.35	10	000300020
3	125	9.35	10	000300030
4	150	12.50	10	000300040
5	150	12.50	10	000300050
6	150	13.20	10	000300060

31

Chasse-goupilles



Ø mm	L mm	L1 mm	CHF	Hand	PC
2	110	22	9.35	10	000310002
3	128	35	9.70	10	000310003
4	146	45	11.90	10	000310004
5	164	55	12.50	10	000310005
6	182	65	15.80	5	000310006
8	200	80	16.60	5	000310008
10	220	95	20.80	5	000310010



Model	CHF	Hand	PC
31/B6N 2-3-4-5-6-8 mm	87.00	1	000310024
2002/BV6	11.30	1	020020000
31/SP6 2-3-4-5-6-8 mm	103.00	1	000310030
31/SPV	26.00	1	000310031

31BM

Chasse-goupilles gainé confort



Ø mm	L mm	L1 mm	CHF	Hand	PC
2	168	42	19.20	2	000310402
3	180	52	19.70	2	000310403
4	191	62	21.60	2	000310404
5	200	72	22.70	2	000310405
6	221	82	26.00	2	000310406
8	235	94	27.50	2	000310408



Model	CHF	Hand	PC
31BM/D6 2-3-4-5-6-8 mm	136.50	1	000310420

31L

Chasse-goupilles long



Ø mm	L mm	L1 mm	CHF	Hand	PC
4	175	80	14.10	5	000310104
5	175	80	15.10	5	000310105
6	175	80	17.90	5	000310106

31SE

Chasse-goupilles pour goupilles élastiques



Ø mm	D mm	L mm	L1 mm	CHF	Hand	PC
4	2,4	175	80	14.10	5	000310204
5	3,0	175	80	15.10	5	000310205
6	3,6	175	80	17.90	5	000310206



Model	CHF	Hand	PC
31/B6N-LSE 31L: 4-5-6 mm 31SE: 4-5-6 mm	105.50	1	000310324
2002/BV6	11.30	1	020020000

32

Pointeau



Ø mm	L mm	L1 mm	CHF	Hand	PC
3	100	44	8.70	10	000320100
4	125	52	10.80	10	000320125
5	150	62	13.20	10	000320150

32AU

Pointeau automatique



Ø mm	L mm	L1 mm	CHF	Hand	PC
3	150	23	70.50	2	000320160

32AUR

Pointe pour 32AU



Ø mm	CHF	5	000320170
3	12.80		

33LT

Kit de lettres à frapper

- Permet de graver l'acier avec une résistance R jusqu'à 80 kg/mm²
- Kit de 27 poinçons : lettres A à Z + symbole "&"



H mm	L mm	A mm	CHF	1	000330023
3	60	6,35	79.50		
4	63	7,93	96.50		
5	61	7,93	96.50		
6	68	9,52	119.00		
8	70	12,7	178.50		

33NR

Kit de chiffres à frapper

- Permet de graver l'acier avec une résistance R jusqu'à 80 kg/mm²
- Kit de 27 poinçons : lettres A à Z + symbole "&"



H mm	L mm	A mm	CHF	1	000330003
3	61	6,35	28.00		
4	62	7,93	34.00		
5	62	7,93	34.00		
6	68	9,52	41.50		
8	71	12,7	60.50		

34

Burin plat



L mm	A mm	L1 mm	CHF	5	000340001
125	14,5	45	13.50		
150	17,0	58	17.70		
175	21,5	68	25.50		

35

Burin nervuré



L mm	A mm	CHF	5	000350001
100	14,5	15.90		
125	17,0	17.70		
150	20,5	22.10		
200	23,0	33.50		
250	28,5	47.50		
300	34,0	65.50		

35PM

Burin nervuré avec protecteur



L mm	A mm	CHF	2	000350014
200	23,0	50.00		
250	28,5	64.50		
300	34,0	83.00		

35PMR

Protecteur pour burin



L mm	CHF	1	000350024
200	16.60		
250	16.60		
300	17.50		

36

Bédane



L mm	A mm	L1 mm	CHF	5	000360001
125	4	44	14.10		
150	6	53	16.60		

37

Bédane nervuré



L mm	A mm	L1 mm	CHF	5	000370001
150	6	45	25.50		
200	8	55	36.50		

37PM

Bédane nervuré avec protecteur



L mm	A mm	CHF	2	000370012
200	8	54.00		

37PMR

Protecteur pour bédane



L mm	CHF	1	000370022
200	17.50		



38/B6N	38/SP6	CHF	1	000380016
38/B6N		88.50		
30: 2-3 mm				
32: 4 mm				
34: 125-150 mm				
36: 150 mm				
2002/BV6		11.30		020020000
38/SP6		104.50		000380009
30: 2-3 mm				
32: 4 mm				
34: 125-150 mm				
36: 150 mm				
38/SPV		29.50		000380019



LA CLÉ ICONIQUE DE BETA

Notre clé historique 42 opte pour un nouveau design.

Une forme élégante, rehaussée d'un profil élancé, et plus agréable au toucher. La résistance, et la conception ergonomique de cette nouvelle clé Beta atteignent des niveaux d'excellence, afin de fournir aux utilisateurs le meilleur outil possible. Son processus de fabrication est effectué dans nos usines de Sovico et Sulmona, sur la base d'une technologie d'automatisation de pointe et d'ouvriers expérimentés

FACILITE D'UTILISATION

Un angle de 15 degrés par rapport à l'axe, permet de réduire l'angle d'enroulement

RÉSISTANCE REMARQUABLE

en cas de mauvaise utilisation, la clé se déforme, sans se casser brutalement et dangereusement

HOMOGENEUS

Le pressage HOMOGENEUS est basé sur un produit semi-fini à section ronde, empêchant ainsi la formation de contraintes internes dangereuses

ACCESSIBLE

Épaisseur réduite pour une meilleure accessibilité

PROTÉGÉ

Le placage nickel-chrome offre une résistance durable aux agents extérieurs et répond aux exigences strictes des tests d'adhérence selon ISO 2819

OPTIMISÉ

La clé, plus longue que la plupart des concurrents, permet d'obtenir des couples élevés grâce à un effort moindre



ERGONOMIQUE

L'œil de la clé possède un angle de 15 degrés pour protéger la main



42

Clé mixte

Valeurs de couple de serrage plus que doublés par rapport aux exigences de la norme ISO 1711



DIN 3113 UNI-ISO 7738

mm	L mm	S1 mm	CHF	🔧	📦
5,5x5,5	95	3,4	10.00	5	000421005
6x6	95	3,4	10.10	5	000421006
7x7	105	3,6	10.20	5	000421007
8x8	116	3,9	10.50	5	000421008
9x9	127	4,2	11.10	5	000421009
10x10	137	4,5	11.40	5	000421010
11x11	148	4,8	12.20	5	000421011
12x12	158	5,1	12.40	5	000421012
13x13	169	5,6	12.40	5	000421013
14x14	180	5,7	14.30	5	000421014
15x15	190	6,0	15.80	5	000421015
16x16	201	6,3	16.30	5	000421016
17x17	212	6,8	17.10	5	000421017
18x18	222	7,0	18.10	5	000421018
19x19	233	7,5	18.70	5	000421019
20x20	243	7,7	21.00	3	000421020
21x21	254	7,9	22.60	3	000421021
22x22	264	8,3	23.30	3	000421022
23x23	275	8,5	25.00	3	000421023
24x24	285	8,7	26.50	3	000421024
25x25	296	8,7	28.00	2	000421025
26x26	307	8,9	30.00	2	000421026
27x27	317	9,1	33.00	2	000421027
28x28	328	9,3	33.50	2	000421028
29x29	338	9,5	37.00	2	000421029
30x30	349	9,7	38.50	2	000421030
32x32	370	10,1	42.00	2	000421032
34x34	391	10,5	80.50	1	000421034
35x35	412	10,7	87.00	1	000421035
36x36	412	10,7	90.50	1	000421036
38x38	433	11,3	100.00	1	000421038
41x41	465	12,0	111.00	1	000421041



	CHF	🔧	📦
42/B9N	131.50	1	000421074
6-7-8-10-11-13-14-17-19 mm			
2002/BV9	14.40	1	020020030



INFORMATION IMPORTANTE !

La forme de la nouvelle clé 42 est parfaitement compatible avec tous les supports et les modules de la clé historique 42.





	CHF		
42/S14	211.00	1	000421067
6-7-8-10-11-12-13-14 -15-16-17-19-22-24 mm			
42/S17	257.00	1	000421065
6-7-8-9-10-11-12-13-14-15 16-17-18-19-20-21-22 mm			
42/S15	293.00	1	000421066
6-7-8-10-11-12-13-14 17-19-22-24-27-30-32 mm			
42/S17X	305.00	1	000421068
6-7-8-10-11-12-13-14- 15-16-17-19-21-22- 24-27-30 mm			
42/S26	552.00	1	000421070
6-7-8-9-10-11-12-13-14 15-16-17-18-19-20-21 22-23-24-25-26-27-28 29-30-32 mm			

42/SC9I-E

Jeu de 9 clés mixtes avec support compact

Valeurs de couple de serrage plus que doublés par rapport aux exigences de la norme ISO 1711



	CHF		
42/SC9I	135.00	1	000421087
8-10-11-12-13-14-15-17-19 mm			
142/SCV9I	13.00	1	001420103
42/SC9E	139.50	1	000421088
8-10-11-12-13-16-17-18-19 mm			
142/SCV9E	13.00	1	001420104



	CHF		
42/SP25	593.00	1	000421085
6-7-8-9-10-11-12-13-14 15-16-17-18-19-20-21 22-23-24-25-26-27-28 30-32 mm			
42/SPV2	78.00	1	000420090



	CHF		
42/SP15	230.00	1	000421078
6-7-8-9-10-11-12-13-14-15 16-17-19-22-24 mm			
42/SPV7	9.25	1	000420097
42: 8-10-11-13-14-17-19 mm 55: 6x7-8x9-10x11-12x13 14x15-16x17-18x19 mm			
42/SPV11	13.00	1	000420100
42MP: 8-9-10-11-12-13 14-15-16-17-19 mm 142-142SN: 8-9-10-11-12-13 14-15-16-17-19 mm			
42/SPV15	17.60	1	000420102
42: 6-7-8-9-10-11-12-13-14 15-16-17-19-22-24 mm			

42AS

Clé mixte



"	L mm	CHF		
1/4x1/4	95	12.50	2	000420106
9/32x9/32	106	12.70	2	000420107
5/16x5/16	116	12.80	2	000420108
3/8x3/8	137	14.10	2	000420110
7/16x7/16	148	15.10	2	000420111
1/2x1/2	169	15.60	2	000420113
9/16x9/16	180	17.00	2	000420114
19/32x19/32	191	18.60	2	000420115
5/8x5/8	201	19.70	2	000420116
11/16x11/16	212	21.10	2	000420117
3/4x3/4	233	22.50	2	000420119
13/16x13/16	254	27.00	2	000420121
7/8x7/8	264	28.00	2	000420122
15/16x15/16	285	33.00	2	000420124
1x1	296	33.50	2	000420125
1.1/16x1.1/16	317	38.50	2	000420127
1.1/8x1.1/8	338	41.50	2	000420129
1.1/4x1.1/4	370	51.00	2	000420132
1.5/16x1.5/16	391	83.00	1	000420133
1.3/8x1.3/8	412	95.50	1	000420135
1.7/16x1.7/16	412	98.50	1	000420136
1.1/2x1.1/2	433	103.50	1	000420138



	CHF		
42AS/B9N	165.00	1	000420159
1/4-5/16-3/8-7/16-1/2 9/16-5/8-11/16-3/4			
2002/BV9	14.40	1	020020030



	CHF		
42AS/13	272.00	1	000420163
1/4-5/16-3/8-7/16-1/2-9/16-5/8 11/16-3/4-13/16-7/8-15/16-1			
42AS/16	403.00	1	000420166
1/4-5/16-3/8-7/16-1/2-9/16-5/8 11/16-3/4-13/16-7/8-15/16-1- 1.1/16-1.1/8-1.1/4			
42AS/17	383.00	1	000420168
1/4-9/32-5/16-3/8-7/16-1/2- 9/16-19/32-5/8-11/16-3/4- 13/16-7/8-15/16-1-1.1/16-1.1/8			

42MP

Clé mixte polie chromée



DIN 3113 UNI-ISO 7738

mm	L mm	CHF		
6x6	95	17.10	5	000420606
7x7	105	17.20	5	000420607
8x8	116	17.40	5	000420608
9x9	127	17.50	5	000420609
10x10	137	17.60	5	000420610
11x11	148	18.00	5	000420611
12x12	158	18.10	5	000420612
13x13	169	18.40	5	000420613
14x14	180	19.80	5	000420614
15x15	190	21.50	5	000420615
16x16	201	22.70	5	000420616
17x17	212	23.70	5	000420617
18x18	222	25.50	5	000420618
19x19	233	26.00	5	000420619
20x20	243	30.00	3	000420620
21x21	254	31.50	3	000420621
22x22	264	32.00	3	000420622
24x24	285	37.00	3	000420624
27x27	317	44.00	3	000420627
30x30	349	54.50	3	000420630
32x32	370	57.00	3	000420632



	CHF		
42MP/B9N	189.50	1	000420661
6-7-8-10-11-13-14-17-19 mm			
2002/BV9	14.40	1	020020030



	CHF		
42MP/S17	374.00	1	000420652
6-7-8-9-10-11-12-13-14-15 16-17-18-19-20-21-22 mm			
42MP/S21	567.00	1	000420653
6-7-8-9-10-11-12-13-14 15-16-17-18-19-20-21-22 24-27-30-32 mm			

42LMP

Clé mixte longue polie chromée



mm	L mm	CHF		
8x8	148	16.40	2	000420508
9x9	167	16.90	2	000420509
10x10	172	17.50	2	000420510
11x11	186	18.40	2	000420511
12x12	197	18.70	2	000420512
13x13	207	19.10	2	000420513
14x14	223	20.30	2	000420514
15x15	233	22.30	2	000420515
16x16	243	24.10	2	000420516
17x17	261	25.50	2	000420517
18x18	270	28.00	2	000420518
19x19	280	28.50	2	000420519
21x21	301	33.00	2	000420521
22x22	318	34.00	2	000420522
24x24	338	39.50	2	000420524
27x27	376	45.00	2	000420527
30x30	409	57.50	2	000420530
32x32	435	62.50	2	000420532



	CHF		
42LMP/S14 8-9-10-11-12-13-14 15-16-17-18-19-21-22 mm	322.00	1	000420551
42LMP/S18 8-9-10-11-12-13-14 15-16-17-18-19-21-22 24-27-30-32 mm	527.00	1	000420552

42SLIM

Clé mixte à tête slim affinée



DIN 3113 UNI-ISO 7738

mm	L mm	S1 mm	CHF		
8x8	116	3,4	11.50	5	000420408
10x10	137	3,8	12.50	5	000420410
11x11	148	3,8	13.30	5	000420411
12x12	158	4,2	13.50	5	000420412
13x13	169	4,4	13.60	5	000420413
14x14	180	4,6	15.60	5	000420414
15x15	190	4,7	17.00	5	000420415
16x16	201	4,7	17.60	5	000420416
17x17	212	5,1	18.20	5	000420417
18x18	222	5,1	19.60	5	000420418
19x19	233	5,6	20.00	5	000420419



	CHF		
42SLIM/B8NI 10-11-12-13-14-15-17-19 mm	138.00	1	000420478
42SLIM/B8NE 10-11-12-13-16-17-18-19 mm	142.50	1	000420479
2002/BV8	14.40	1	020020020



	CHF		
42SLIM/S11 8-10-11-12-13-14-15- 16-17-18-19 mm	172.50	1	000420471

45

Clé mixte série lourde



DIN 3113 UNI-ISO 7738

mm	L mm	CHF		
46x46	500	238.00	1	000450046
50x50	540	268.00	1	000450050
55x55	560	383.00	1	000450055
60x60	600	491.00	1	000450060
65x65	675	589.00	1	000450065
70x70	675	645.00	1	000450070
75x75	720	751.00	1	000450075
80x80	720	867.00	1	000450080

52

Clé à fourche



UNI 6733 DIN 3114

mm	L mm	CHF		
10	119	12.50	5	000520010
11	119	12.80	5	000520011
12	119	13.20	5	000520012
13	145	14.90	5	000520013
14	145	15.30	5	000520014
15	145	15.60	5	000520015
16	159	16.90	5	000520016
17	159	17.00	5	000520017
18	159	18.10	5	000520018
19	175	19.70	5	000520019
20	175	21.10	5	000520020
21	175	21.70	5	000520021
22	196	24.40	2	000520022
23	196	25.00	2	000520023
24	196	25.50	2	000520024
25	215	29.00	2	000520025
26	215	29.50	2	000520026
27	215	29.50	2	000520027
28	240	34.00	2	000520028
30	240	34.50	2	000520030
32	270	41.50	2	000520032
34	270	45.00	1	000520034
35	295	52.00	1	000520035
36	295	52.00	1	000520036
38	295	58.00	1	000520038
40	335	71.50	1	000520040
41	335	71.50	1	000520041
42	335	79.50	1	000520042
45	370	91.00	1	000520045
46	370	91.00	1	000520046
48	370	105.50	1	000520048
50	415	122.50	1	000520050
52	415	137.50	1	000520052
55	415	142.50	1	000520055
60	490	181.00	1	000520060
65	490	184.00	1	000520065
70	490	208.50	1	000520070

53

Clé à fourche gros effort DIN 894



mm	L mm	CHF		
36	317	38.50	1	000530036
38	320	42.00	1	000530038
41	342	49.50	1	000530041
46	396	60.00	1	000530046
50	412	94.00	1	000530050
55	457	108.00	1	000530055
60	492	133.50	1	000530060
65	528	158.00	1	000530065
70	572	183.00	1	000530070
75	608	229.50	1	000530075
80	645	281.00	1	000530080
85	690	341.00	1	000530085
90	690	404.00	1	000530090
95	847	564.00	1	000530095
100	847	596.00	1	000530100
105	1000	744.00	1	000530105
110	1000	805.00	1	000530110
115	1000	898.00	1	000530115
120	1000	1,018.00	1	000530120
125	1000	1,176.00	1	000530125
130	1000	1,260.00	1	000530130
135	1000	1,350.00	1	000530135

55

Clé à fourches



UNI-ISO 10102 DIN 3110

mm	L mm	CHF		
4x5	101	7.40	5	000550003
5x5,5	101	8.35	5	000550006
5,5x7	120	8.35	5	000550009
6x7	120	6.60	5	000550012
7x8	140	8.35	5	000550018
8x9	140	6.70	5	000550021
8x10	140	8.35	5	000550024
10x11	155	7.05	5	000550030
10x12	155	9.60	5	000550033
10x13	170	10.50	5	000550035
12x13	170	8.00	5	000550042
12x14	170	10.80	5	000550045
13x14	185	12.10	5	000550047
13x17	189	12.90	5	000550051
14x15	185	10.10	5	000550054
14x17	189	13.90	5	000550057
16x17	202	11.50	5	000550060
17x19	220	15.50	2	000550063
18x19	220	13.60	2	000550066
19x22	236	17.60	2	000550069
20x22	236	15.50	2	000550075
21x23	245	16.50	2	000550078
22x24	245	19.10	2	000550081
24x26	262	19.60	2	000550087
24x27	262	21.30	2	000550090
25x28	272	22.30	2	000550096
27x29	284	25.50	2	000550099
27x30	284	29.00	2	000550102
27x32	297	31.50	2	000550105
30x32	297	28.00	2	000550108
32x36	325	86.00	1	000550114
34x36	325	86.00	1	000550117
35x38	375	95.50	1	000550120
36x41	375	100.00	1	000550123
41x46	425	114.00	1	000550129
46x50	475	141.50	1	000550132
50x55	500	164.50	1	000550135
55x60	500	173.50	1	000550138



	CHF		
55/B8N	93.50	1	000550160
6x7-8x9-10x11-12x13 14x15-16x17-18x19 20x22 mm			
2002/BV8	14.40	1	020020020
55/B12N	189.00	1	000550164
6x7-8x9-10x11-12x13 14x15-16x17-18x19 20x22-21x23-24x26 25x28-30x32 mm			
2002/BV12	23.90	1	020020040



	CHF		
55/S8	78.50	1	000550174
6x7-8x9-10x11-12x13 14x15-16x17-18x19 20x22 mm			
55/S12	165.50	1	000550178
6x7-8x9-10x11-12x13 14x15-16x17-18x19 20x22-21x23-24x26 25x28-30x32 mm			
55/S12X	167.50	1	000550179
6x7-8x9-10x11-12x13 14x15-16x17-18x19 20x22-21x23-24x27 25x28-30x32 mm			
55/S13	191.00	1	000550182
6x7-8x9-10x11-12x13 14x15-16x17-18x19 20x22-21x23-24x26 25x28-27x29-30x32 mm			



55/SP7



55/SP13

	CHF		
55/SP7	67.00	1	000550167
6x7-8x9-10x11-12x13 14x15-16x17-18x19 mm			
42/SPV7	9.25	1	000420097
42: 8-10-11-13-14-17-19 mm			
55: 6x7-8x9-10x11-12x13			
14x15-16x17-18x19 mm			
55/SP13	237.00	1	000550186
6x7-8x9-10x11-12x13 14x15-16x17-18x19 20x22-21x23-24x26 25x28-27x29-30x32 mm			
55/SPV	46.00	1	000550190

55AS

Clé à fourches



mm	L mm	CHF		
1/4x9/32	120	8.80	2	000550203
1/4x5/16	120	8.80	2	000550206
5/16x11/32	140	9.50	2	000550209
5/16x3/8	140	9.50	2	000550212
3/8x7/16	155	10.20	2	000550215
7/16x1/2	170	11.30	2	000550218
1/2x9/16	170	12.10	2	000550221
9/16x5/8	185	13.30	2	000550224
19/32x11/16	189	16.30	2	000550227
5/8x11/16	202	16.30	2	000550230
5/8x3/4	202	18.20	2	000550233
11/16x13/16	220	19.00	2	000550242
3/4x7/8	236	20.50	2	000550245
25/32x13/16	236	20.50	2	000550244
7/8x15/16	245	22.10	2	000550251
15/16x1	262	28.00	1	000550257
1x1.1/8	272	29.50	1	000550259
1.1/16x1.1/4	284	38.50	1	000550267
1.1/8x1.5/16	297	38.50	1	000550266
1.5/16x1.1/2	325	101.50	1	000550269
1.3/8x1.1/2	375	112.00	1	000550272
1.7/16x1.5/8	375	112.00	1	000550275



	CHF		
55AS/5	68.00	1	000550290
5/16x11/32-3/8x7/16 1/2x9/16-5/8x11/16 3/4x7/8			
55AS/8	109.50	1	000550296
1/4x9/32-5/16x11/32-3/8x7/16- 1/2x9/16-9/16x5/8-5/8x11/16- 11/16x13/16-3/4x7/8			
55AS/12	225.50	1	000550298
1/4x9/32-5/16x11/32-3/8x7/16-1 /2x9/16-9/16x5/8-5/8x11/16- 11/16x13/16-25/32x13/16-3/4x7/8- 15/16x1-1x1.1/8-1.1/16x1.1/4			

55MP

Clé à fourches polie chromée



UNI-ISO 10102 DIN 3110

mm	L mm	CHF		
6x7	120	8.75	2	000550603
8x9	140	9.35	2	000550606
10x11	155	10.40	2	000550609
12x13	170	11.40	2	000550612
14x15	185	13.50	2	000550615
16x17	202	15.90	2	000550618
18x19	220	18.40	2	000550621
20x22	236	21.10	2	000550624
21x23	245	22.90	2	000550627
24x26	262	27.50	1	000550630
25x28	272	29.00	1	000550633
27x29	284	33.50	1	000550636
30x32	297	38.00	1	000550639



	CHF		
55MP/S8	108.50	1	000550650
6x7-8x9-10x11-12x13 14x15-16x17-18x19 20x22 mm			
55MP/S13	259.00	1	000550651
6x7-8x9-10x11-12x13 14x15-16x17-18x19 20x22-21x23-24x26 25x28-27x29-30x32 mm			
55MP/S12	225.50	1	000550653
6x7-8x9-10x11-12x13-14x15- 16x17-18x19-20x22-21x23-24x26- 25x28-30x32 mm			

58

Clé à fourche à frapper



DIN 133

mm	L mm	CHF		
24	177	39.50	1	000580024
27	180	41.50	1	000580027
30	190	46.00	1	000580030
32	190	47.50	1	000580032
34	200	60.00	1	000580034
36	215	62.00	1	000580036
41	235	73.50	1	000580041
46	255	98.50	1	000580046
50	275	110.50	1	000580050
55	300	132.50	1	000580055
60	320	145.00	1	000580060
65	342	190.50	1	000580065
70	375	245.50	1	000580070
75	375	268.00	1	000580075
80	408	392.00	1	000580080
85	408	439.00	1	000580085
90	445	506.00	1	000580090
95	445	521.00	1	000580095
100	485	720.00	1	000580100
105	485	813.00	1	000580105
110	510	890.00	1	000580110
115	510	1,014.00	1	000580115
120	545	1,045.00	1	000580120
125	545	1,197.00	1	000580125
130	575	1,620.00	1	000580130
135	575	1,700.00	1	000580135
*140	575	1,840.00	1	000580140
*145	640	2,520.00	1	000580145
*150	640	2,620.00	1	000580150
*155	640	2,870.00	1	000580155
*160	640	3,150.00	1	000580160
*165	715	3,370.00	1	000580165
*170	715	4,600.00	1	000580170
*175	715	4,860.00	1	000580175
*180	715	5,270.00	1	000580180
*185	715	5,420.00	1	000580185
*190	800	5,950.00	1	000580190
*195	800	6,250.00	1	000580195
*200	800	6,550.00	1	000580200
*210	800	8,170.00	1	000580210
*220	800	10,540.00	1	000580220
*230	800	12,870.00	1	000580230

73

Clé à fourches micromécanique



UNI 6737

mm	L mm	CHF		
4x4	78	11.00	5	000730040
4,5x4,5	78	11.00	5	000730045
5x5	78	11.00	5	000730050
5,5x5,5	86	12.00	5	000730055
6x6	86	12.00	5	000730060
7x7	86	12.00	5	000730070
8x8	97	12.50	5	000730080
9x9	97	12.50	5	000730090
10x10	108	13.50	5	000730100
11x11	108	13.50	5	000730110
12x12	124	15.60	5	000730120
13x13	124	15.60	5	000730130
14x14	124	15.60	5	000730140



	CHF		
73/B13N 4-4,5-5-5,5-6-7-8-9 10-11-12-13-14 mm	182.00	1	000730202
2002/BV13	14.40	1	020020050



	CHF		
73/S13 4-4,5-5-5,5-6-7-8-9 10-11-12-13-14 mm	168.00	1	000730210

78

Clé polygonale à frapper



DIN 7444

mm	L mm	CHF		
24	162	40.50	1	000780024
27	180	47.00	1	000780027
30	190	56.00	1	000780030
32	190	59.50	1	000780032
34	200	68.00	1	000780034
36	205	73.50	1	000780036
41	225	95.50	1	000780041
46	235	106.50	1	000780046
50	250	126.50	1	000780050
55	265	144.50	1	000780055
60	275	176.00	1	000780060
65	295	222.50	1	000780065
70	325	224.00	1	000780070
75	325	265.00	1	000780075
80	350	407.00	1	000780080
85	350	445.00	1	000780085
90	390	544.00	1	000780090
95	390	630.00	1	000780095
100	420	697.00	1	000780100
105	420	822.00	1	000780105
110	450	898.00	1	000780110
115	450	1,022.00	1	000780115
120	490	1,405.00	1	000780120
125	480	1,895.00	1	000780125
130	520	2,190.00	1	000780130
135	520	2,345.00	1	000780135
*140	520	2,670.00	1	000780140
*145	580	3,360.00	1	000780145
*150	580	3,520.00	1	000780150
*155	580	4,050.00	1	000780155
*160	650	4,150.00	1	000780160
*165	650	4,410.00	1	000780165
*170	650	5,290.00	1	000780170
*175	650	5,730.00	1	000780175
*180	650	6,290.00	1	000780180
*185	695	6,490.00	1	000780185
*190	695	7,090.00	1	000780190
*195	695	7,110.00	1	000780195
*200	695	7,200.00	1	000780200
*210	740	7,690.00	1	000780210
*215	740	8,610.00	1	000780215
*220	740	9,490.00	1	000780220
*230	740	11,760.00	1	000780230

78AS

Clé polygonale à frapper



mm	L mm	CHF		
*1.1/16	180	57.00	1	000780327
*1.1/8	190	57.00	1	000780329
*1.3/16	190	57.00	1	000780330
*1.1/4	197	62.00	1	000780332
*1.5/16	197	64.00	1	000780333
*1.3/8	223	68.00	1	000780335
*1.7/16	223	82.50	1	000780336
*1.1/2	223	85.00	1	000780338
*1.5/8	223	96.50	1	000780341
*1.11/16	225	101.00	1	000780343
*1.13/16	240	111.50	1	000780346
*1.7/8	250	113.00	1	000780348
*2	250	129.00	1	000780350
*2.1/16	250	133.50	1	000780352
*2.3/16	275	140.50	1	000780355
*2.3/8	270	190.50	1	000780360
*2.9/16	302	211.00	1	000780365

mm	L mm	CHF		
*2.3/4	350	229.50	1	000780370
*2.15/16	350	265.00	1	000780375
*3.1/8	354	438.00	1	000780380

80

Clé à douilles articulées



mm	L mm	CHF		
6x7	170	44.50	3	000800006
8x9	176	46.00	3	000800008
8x10	179	46.00	3	000800009
10x11	182	48.50	3	000800010
12x13	228	55.00	3	000800012
14x15	232	56.00	3	000800014
13x17	231	59.50	3	000800015
16x17	234	59.50	2	000800016
18x19	285	73.50	2	000800018
19x22	287	77.50	2	000800019
20x22	289	77.50	2	000800020
21x23	289	78.50	2	000800021
24x27	405	129.00	2	000800024
30x32	413	137.00	2	000800030



	CHF		
80/S8 6x7-8x9-10x11-12x13-14x15 16x17-18x19-20x22 mm	460.00	1	000800051
80/S11 6x7-8x9-10x11-12x13 14x15-16x17-18x19-20x22 21x23-24x27-30x32 mm	805.00	1	000800056

83

Clé polygonale demi-lune



ISO 3318

mm	L mm	CHF		
8x10	126	22.70	3	000830008
10x12	137	23.80	3	000830010
11x13	138	24.40	3	000830011
14x17	183	30.50	3	000830014
15x17	184	34.50	2	000830015
16x18	196	38.00	2	000830016
19x22	231	48.50	2	000830019



	CHF		
83/S3 11x13-14x17-19x22 mm	103.50	1	000830081
83/S5 10x12-11x13-15x17 16x18-19x22 mm	169.00	1	000830085



83AS

Clé polygonale demi-lune



mm	L mm	CHF	🔧	📦
7/16x1/2	138	29.00	2	000830111
9/16x5/8	183	34.50	2	000830114
3/4x7/8	230	54.50	2	000830119



mm	L mm	CHF	🔧	📦
83AS/3		118.50	1	000830181
7/16x1/2-9/16x5/8				
3/4x7/8				

88

Clé polygonale double droite, modèle extra-long



mm	L mm	CHF	🔧	📦
8x10	235	25.50	2	000880008
12x14	330	30.00	2	000880012
13x15	330	30.00	2	000880013
16x18	405	41.50	2	000880016
17x19	405	41.50	2	000880017
21x23	435	47.50	2	000880021
22x24	435	47.50	2	000880022



mm	L mm	CHF	🔧	📦
88/S7		263.00	1	000880107
8x10-12x14-13x15-16x18-17x19-21x23-22x24 mm				

90

Clé polygonale contre-coudée



DIN 838 ISO 10104

mm	L mm	CHF	🔧	📦
6x7	165	12.50	5	000900006
8x9	180	13.40	5	000900012
8x10	180	15.80	5	000900015
10x11	195	14.80	5	000900018
10x12	195	16.00	5	000900021
11x13	215	17.60	5	000900024
12x13	215	16.10	5	000900027
12x14	215	18.50	5	000900030
14x15	230	17.60	5	000900033
14x17	250	21.80	5	000900036
16x17	250	20.10	5	000900039
17x19	265	26.00	5	000900042
18x19	265	23.40	5	000900045
19x22	285	29.00	3	000900048
20x22	285	27.00	3	000900051
21x23	305	30.50	2	000900057
22x24	305	33.00	2	000900060
24x26	325	34.00	2	000900063
24x27	325	38.00	2	000900067
25x28	340	41.00	2	000900070
27x29	355	44.00	2	000900073
27x30	355	47.50	2	000900076
27x32	375	53.50	2	000900078
30x32	375	49.50	2	000900080
32x36	395	73.50	1	000900088
34x36	415	87.50	1	000900089
35x38	415	88.50	1	000900091
36x41	435	101.00	1	000900094
41x46	460	145.00	1	000900097
46x50	500	191.50	1	000900100



mm	L mm	CHF	🔧	📦
90/B8N		159.50	1	000900156
6x7-8x9-10x11-12x13-14x15-16x17-18x19-20x22 mm				
2002/BV8		14.40	1	020020020



mm	L mm	CHF	🔧	📦
90/S8		145.00	1	000900162
6x7-8x9-10x11-12x13-14x15-16x17-18x19-20x22 mm				

mm	L mm	CHF	🔧	📦
90/S12		300.00	1	000900166
6x7-8x9-10x11-12x13-14x15-16x17-18x19-20x22-21x23-24x26-25x28-30x32 mm				

mm	L mm	CHF	🔧	📦
90/S12X		304.00	1	000900167
6x7-8x9-10x11-12x13-14x15-16x17-18x19-20x22-21x23-24x27-25x28-30x32 mm				

mm	L mm	CHF	🔧	📦
90/S13		343.00	1	000900170
6x7-8x9-10x11-12x13-14x15-16x17-18x19-20x22-21x23-24x26-25x28-27x29-30x32 mm				



mm	L mm	CHF	🔧	📦
90/SP13		389.00	1	000900174
6x7-8x9-10x11-12x13-14x15-16x17-18x19-20x22-21x23-24x26-25x28-27x29-30x32 mm				
55/SPV		46.00	1	000550190

90AS

Clé polygonale contre-coudée



mm	L mm	CHF	🔧	📦
1/4x5/16	165	14.40	2	000900203
5/16x11/32	180	15.50	2	000900206
5/16x3/8	180	15.90	2	000900209
3/8x7/16	195	16.10	2	000900212
7/16x1/2	215	18.10	2	000900215
1/2x9/16	230	20.70	2	000900218
9/16x5/8	230	20.70	2	000900221
19/32x11/16	250	22.60	2	000900222
5/8x11/16	250	23.40	2	000900224
5/8x3/4	265	27.50	2	000900227
11/16x3/4	265	27.50	1	000900230
11/16x13/16	265	27.50	1	000900233
3/4x25/32	265	32.00	1	000900235
3/4x7/8	285	32.00	1	000900237
13/16x7/8	285	33.00	1	000900240
7/8x15/16	305	33.00	1	000900243
15/16x1	325	39.50	1	000900252
1.1/16x1.1/4	375	57.00	1	000900258
1.1/8x1.5/16	375	57.50	1	000900261



mm	L mm	CHF	🔧	📦
90AS/8		190.50	1	000900298
1/4x5/16-5/16x11/32-3/8x7/16-1/2x9/16-5/8x11/16-11/16x3/4-13/16x7/8-15/16x1				
90AS/10		305.00	1	000900300

mm	L mm	CHF	🔧	📦
90AS/10				
1/4x5/16-5/16x11/32-3/8x7/16-1/2x9/16-5/8x11/16-11/16x3/4-13/16x7/8-15/16x1-1.1/16x1.1/4-1.1/8x1.5/16				

91

Clé polygonale contre-coudée
gros effort



Ø mm	Ø mm	CHF		
24	38	72.00	1	000910024
27	41	74.50	1	000910027
30	48	80.00	1	000910030
32	49	86.00	1	000910032
36	54	98.50	1	000910036
41	62	117.00	1	000910041
46	69	137.00	1	000910046
50	76	156.00	1	000910050
55	81	175.00	1	000910055
60	90	218.00	1	000910060
65	98	244.00	1	000910065
70	105	275.00	1	000910070
75	110	315.00	1	000910075
80	125	361.00	1	000910080
85	125	377.00	1	000910085
90	140	675.00	1	000910090
95	140	738.00	1	000910095
100	143	782.00	1	000910100
105	146	874.00	1	000910105

92

Manche tubulaire pour 91



	L mm	91 mm	Ø mm	CHF		
92/1	460	24÷30	19	43.50	1	000920010
92/2	610	32÷41	22	66.50	1	000920020
92/3	760	46÷55	25	94.00	1	000920030
92/4	860	60÷105	30	125.00	1	000920040

93

Clé polygonale pour échafaudage



Ø mm	L mm	CHF		
21x22	310	51.50	3	000930021

93C

Clé à cliquet polygonale pour échafaudage



Ø mm	L mm	CHF		
17x19	310	58.00	1	000930117
19x22	310	62.50	1	000930119
19x24	365	77.00	1	000930120
21x22	310	70.00	1	000930121
36x38	445	118.00	1	000930136

94

Clé à tuyauter



DIN 3118

Ø mm	L mm	CHF		
8x10	140	21.80	2	000940008
9x11	153	22.70	2	000940009
10x11	153	23.90	2	000940010
11x13	175	24.70	2	000940011
12x14	175	26.00	2	000940012
13x15	175	26.00	2	000940013
14x15	175	30.50	2	000940014
14x17	195	31.50	2	000940015
17x19	212	32.00	2	000940017
19x22	228	34.00	2	000940019
22x24	242	42.00	2	000940022
24x27	260	46.00	2	000940024
30x32	300	59.50	2	000940030
36x41	320	101.50	1	000940036



	CHF		
94/S6	163.00	1	000940050
8x10-10x11-11x13-12x14 17x19-19x22 mm			
94/S10	334.00	1	000940052
8x10-9x11-10x11-11x13 12x14-17x19-19x22 22x24-24x27-30x32 mm			

95

Clé polygonale double droite



DIN 837 ISO 10103

Ø mm	L mm	CHF		
6x7	120	14.30	3	000950161
8x9	135	15.40	3	000950162
10x11	150	17.40	3	000950163
12x13	165	18.90	3	000950164
14x15	185	19.80	3	000950165
16x17	210	21.10	3	000950166
17x19	225	24.40	3	000950167
18x19	225	24.40	2	000950168
20x22	240	27.50	2	000950169
21x23	255	29.00	2	000950170
24x26	270	30.50	2	000950171
25x28	285	37.00	2	000950172
27x29	315	38.00	2	000950173
30x32	335	42.50	2	000950174



	CHF		
95/S8	158.50	1	000950177
6x7-8x9-10x11-12x13 14x15-16x17-18x19 20x22 mm			
95/S13	336.00	1	000950179
6x7-8x9-10x11-12x13 14x15-16x17-18x19 20x22-21x23-24x26 25x28-27x29-30x32 mm			

95FTX

Clé double droite pour écrous TORX®



Ø mm	L mm	CHF		
E6xE8	115	14.80	2	000950306
E10xE12	143	15.50	2	000950310
E14xE18	177	17.60	2	000950314
E20xE24	224	23.90	2	000950320



	CHF		
95FTX/S4	72.00	1	000950325
E6xE8-E10xE12 E14xE18-E20xE24			



Beta

CLÉS 6 PANS COUDÉES

Les clés 6 pans coudées Beta ont été conçues pour une durée de vie longue et une utilisation précise. La large gamme couvre toutes les utilisations : les clés sphériques, courtes, longues, extra-longues et en T avec poignées haute performance fait partie des produits incontournables de Beta et sont inégalées sur le marché.

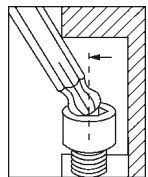

Les clés 6 pans coudées à tête sphérique permettent de travailler avec un angle maximum de 30° par rapport à l'axe de la vis.

Les clés sont emballées dans râtelier pour permettre une identification rapide de la taille requise. Lorsqu'il est fermé, il empêche les clés, même les plus petites, de sortir accidentellement.

La version Color combine les caractéristiques exceptionnelles des clés standard avec l'identification immédiate par couleur de la taille requise afin de faciliter le travail quotidien.



96

Clé mâle 6 pans coudée, chromée



ISO 2936

mm	L mm	L1 mm	CHF		
0,9	35	8	1.27	20	000960013
1,3	39	10	1.27	20	000960014
1,5	45	15	1.27	20	000960015
2	50	17	1.34	20	000960020
2,5	57	20	1.34	20	000960025
3	64	22	1.58	20	000960030
3,5	68	25	1.88	20	000960035
4	72	28	1.96	20	000960040
4,5	78	30	2.03	20	000960045
5	83	32	2.10	20	000960050
5,5	88	35	2.65	20	000960055
6	94	37	2.65	20	000960060
7	99	40	3.30	10	000960070
8	105	43	3.85	10	000960080
9	111	46	4.55	10	000960090
10	119	49	5.40	10	000960100
11	126	52	6.75	10	000960110
12	134	56	8.15	10	000960120
13	142	62	10.40	10	000960130
14	151	69	12.20	10	000960140
16	165	75	17.90	5	000960160
17	174	79	18.70	5	000960170
19	196	88	26.00	5	000960190
22	216	100	41.00	3	000960220
24	242	112	54.00	1	000960240
27	271	125	71.50	1	000960270
30	309	140	96.00	1	000960300
32	341	155	126.50	1	000960312
36	385	174	182.00	1	000960316



96/ST6
2,5-3-4-5-6-8 mm

CHF 18.20 3 000960370



96/BGS7
1,5-2-2,5-3-4-5-6 mm

CHF 40.50 1 000960367



96/BG7
2,5-3-4-5-6-8-10 mm

CHF 42.50 1 000960368



96/B8
2-2,5-3-4-5-6-8-10 mm

CHF 22.70 5 000960386

96/B10
1,5-2-2,5-3-4-5-6-8-10-12 mm

CHF 32.00 5 000960380

96N/BV 2.47 1 000960651



96/SC9
1,5-2-2,5-3-4-5-6-8-10 mm

CHF 27.00 1 000960374

96/SCV 5.50 1 000960985



96/SC12
2-2,5-3-3,5-4-4,5-5-6-7-8-9-10 mm

CHF 38.50 1 000960395

96/SCV12 6.60 1 000960975

96N

Clé mâle 6 pans coudée, brunie



ISO 2936

mm	L mm	L1 mm	CHF		
0,9	32	10	0.64	20	000960409
1,3	44	12	0.64	20	000960413
1,5	46	15	0.67	20	000960415
2	51	17	0.71	20	000960420
2,5	57	20	0.74	20	000960425
3	64	22	0.82	20	000960430
3,5	68	25	0.98	20	000960435
4	72	28	1.12	20	000960440
4,5	78	30	1.22	20	000960445
5	83	32	1.28	20	000960450
6	94	37	1.60	20	000960460
7	99	40	2.14	10	000960470
8	105	43	2.53	10	000960480
9	111	46	3.30	10	000960490
10	119	49	3.90	10	000960500
11	126	52	4.85	10	000960510
12	134	56	5.90	10	000960520
13	142	62	7.90	10	000960530
14	151	69	8.85	10	000960540
16	165	72	13.40	5	000960560
17	174	79	14.40	5	000960570
19	194	88	19.50	5	000960590
22	216	99	36.00	1	000960592
24	242	111	47.00	1	000960594



96N/ST6
2,5-3-4-5-6-8 mm

CHF 12.80 3 000960640



96N/G7
2,5-3-4-5-6-8-10 mm

CHF 33.50 3 000960645

96N/G7A
1,5-2-2,5-3-4-5-6 mm

CHF 23.40 3 000960643



96N/B10
1,5-2-2,5-3-4-5-6
8-10-12 mm

CHF 21.70 5 000960650

96N/BV
CHF 2.47 1 000960651



96N/SC9
1,5-2-2,5-3-4-5-6-8-10 mm

CHF 18.90 1 000960644

96N/SCV
CHF 5.50 1 000960986



96N/SC12
2-2,5-3-3,5-4-4,5-5
6-7-8-9-10 mm

CHF 27.00 1 000960661

96N/SCV12
CHF 6.60 1 000960976

96C/AS

Clé mâle 6 pans coudée,
chromée



"	L mm	L1 mm	g	CHF		
1/16	46	16	1,01	2.22	20	000961702
3/32	53	19	2,70	3.10	20	000961706
1/8	60	22	5,33	3.25	20	000961710
5/32	67	25	9,33	3.80	20	000961714
3/16	74	28	14,87	4.30	20	000961716
7/32	81	32	22,00	4.85	20	000961718
1/4	89	35	31,40	5.40	20	000961720
5/16	103	40	56,16	6.00	10	000961724
3/8	117	45	91,31	7.45	10	000961728



96C-AS/SC9
1/16-3/32-1/8-5/32-3/16-
7/32-1/4-5/16-3/8

CHF 46.00 1 000961753

96AS

Clé mâle 6 pans coudée, brunie



"	L mm	L1 mm	CHF		
1/30 (0,035")	44	14	1.13	20	000960698
1/20 (0,050")	44	15	1.13	20	000960701
1/16	46	16	1.22	20	000960702
5/64	50	18	1.51	20	000960704
3/32	53	19	1.73	20	000960706
7/64	57	21	1.78	20	000960708
1/8	60	22	1.80	20	000960710
9/64	64	24	2.15	20	000960712
5/32	68	25	2.22	20	000960714
3/16	75	29	2.47	20	000960716
7/32	82	32	2.77	20	000960718
1/4	89	35	3.25	20	000960720
5/16	103	40	4.05	10	000960724
3/8	117	44	4.90	10	000960728
7/16	132	49	7.15	10	000960730
1/2	149	54	9.00	10	000960732
9/16	151	69	14.80	2	000960734



96AS/SC9
1/16-3/32-1/8-5/32-3/16
7/32-1/4-5/16-3/8

CHF 30.00 1 000960743

96AS/SCV
CHF 5.50 1 000960744



96AS/T7
3/32-1/8-5/32
3/16-7/32-1/4-5/16

CHF 24.20 3 000960740



96AS/BG7
3/32-1/8-5/32-3/16
1/4-5/16-3/8

CHF 42.50 1 000960747



96AS/B11
1/20-1/16-5/64-3/32
1/8-5/32-3/16-7/32
1/4-5/16-3/8

CHF 29.50 1 000960749

96N/BV
CHF 2.47 1 000960651



96LC

Clé mâle 6 pans coudée série longue
chromée



ISO 2936

mm	L mm	L1 mm	CHF		
2	101	17	2.41	20	000960320
2,5	113	20	2.57	20	000960321
3	127	22	2.81	20	000960322
3,5	138	25	2.87	20	000960323
4	142	28	3.10	20	000960324
4,5	154	28	3.65	20	000960325
5	163	32	3.95	20	000960326
6	184	37	4.30	20	000960327
7	194	40	4.90	10	000960328
8	205	43	6.00	10	000960329
9	216	46	6.65	10	000960330
10	231	49	8.60	10	000960331
12	259	56	10.70	10	000960332





96LC/SC8 2-2,5-3-4-5-6-8-10 mm	CHF 39.00			1	000960334
96LC/SCV	5.50			1	000960983



96LC/SC12 2-2,5-3-3,5-4-4,5-5-6-7-8-9-10 mm	CHF 58.00			1	000960337
96LC/SCV12	6.60			1	000960977

96L
Clé mâle 6 pans coudée série longue
brunie



ISO 2936

mm	L mm	L1 mm	CHF		
2	99	15	1.70	20	000960820
2,5	110	17	1.77	20	000960825
3	124	19	2.00	20	000960830
3,5	135	21	2.15	20	000960835
4	138	24	2.39	20	000960840
4,5	150	25	2.77	20	000960845
5	158	27	2.92	20	000960850
6	178	31	3.30	20	000960860
7	187	33	4.20	10	000960870
8	197	35	5.35	10	000960880
9	207	37	5.95	10	000960890
10	221	39	7.95	10	000960900
12	247	44	10.20	10	000960920



96L/SC8 2-2,5-3-4-5-6-8-10 mm	CHF 33.00			1	000960924
96L/SCV	5.50			1	000960987



96L/SC12 2-2,5-3-3,5-4-4,5-5-6-7-8-9-10 mm	CHF 49.00			1	000960929
96L/SCV12	6.60			1	000960978

96BP-CL

Clé mâle 6 pans coudée à tête sphérique,
chromée,
colorée



mm	L mm	L1 mm	CHF		
1,5	91	16	3.80	5	000961600
2	102	17	4.20	5	000961601
2,5	113	21	4.65	5	000961602
3	128	23	5.20	5	000961603
4	143	28	5.75	5	000961604
5	163	33	6.25	5	000961605
6	185	37	8.00	5	000961606
8	206	43	10.90	2	000961608
10	231	50	14.40	2	000961610



96BP-CL/SC9 1,5-2-2,5-3-4-5-6-8-10 mm	CHF 69.00			1	000961619
96BP-CL/SCV	5.50			1	000961629

96BPC

Clé mâle 6 pans coudée
à tête sphérique, chromée

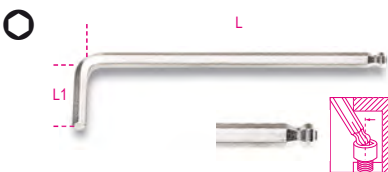

mm	L mm	L1 mm	CHF		
1,5	79	13	2.84	10	000960340
2	84	15	2.99	10	000960341
2,5	89	17	3.15	10	000960342
3	99	19	3.35	10	000960343
4	108	24	3.85	10	000960344
5	126	27	4.65	10	000960345
6	148	31	6.65	10	000960346
7	157	33	8.75	5	000960353
8	168	35	8.85	5	000960347
10	187	39	14.40	5	000960348
12	220	55	18.50	5	000960352



96BPC/SC9 1,5-2-2,5-3-4-5-6-8-10 mm	CHF 56.50			1	000960354
96BPC/SCV	5.50			1	000960984

96BP

Clé mâle 6 pans coudée
à tête sphérique, brunie

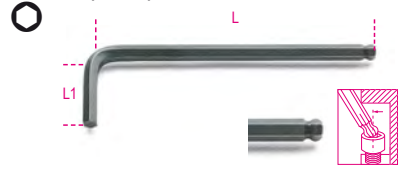

mm	L mm	L1 mm	CHF		
1,5	79	13	2.15	10	000960960
2	84	15	2.30	10	000960961
2,5	89	17	2.39	10	000960962
3	99	19	2.47	10	000960963
4	108	24	2.84	10	000960965
5	126	27	3.80	10	000960967
6	148	31	5.40	10	000960968
8	168	35	7.75	5	000960970
10	187	39	13.20	5	000960972
12	220	55	19.60	5	000960973



96BP/SC9 1,5-2-2,5-3-4-5-6-8-10 mm	CHF 47.50			1	000960974
96BP/SCV	5.50			1	000960988

96LBP

Clé mâle 6 pans
coudée à tête sphérique,
modèle extra long

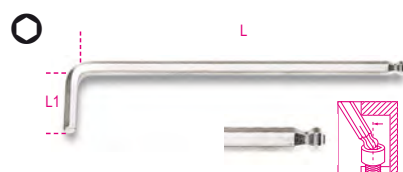

mm	L mm	L1 mm	CHF		
1,5	90	15	3.30	5	000961340
2	100	17	3.50	5	000961341
2,5	112	20	3.70	5	000961342
3	127	22	3.85	5	000961343
4	144	27	4.70	5	000961344
5	163	32	5.65	5	000961345
6	184	37	7.80	5	000961346
8	204	44	10.70	2	000961348
10	230	49	17.10	2	000961350



96LBP/SC9 1,5-2-2,5-3-4-5-6-8-10 mm	CHF 65.50			1	000961354
96LBP/SCV	5.50			1	000961984

96BP/AS

Clé mâle 6 pans coudée à tête sphérique, brunie

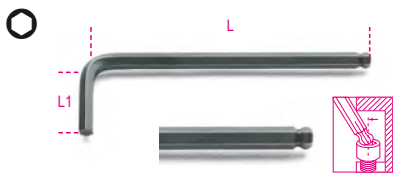

"	L mm	L1 mm	CHF		
3/32	89	17	2.61	10	000960989
1/8	98	18	2.77	10	000960990
5/32	108	24	3.30	10	000960991
3/16	126	26	3.80	10	000960992
7/32	139	28	5.45	10	000960993
1/4	152	31	5.95	10	000960994
5/16	168	34	7.90	5	000960995
3/8	190	39	13.00	5	000960996



	CHF		
96BP-AS/SC9	51.50	1	000961000
1/16-3/32-1/8-5/32-3/16			
7/32-1/4-5/16-3/8			
96BP-AS/SCV	5.50	1	000961001



	CHF		
96BP-AS/8	47.00	1	000960997
3/32-1/8-5/32-3/16-7/32			
1/4-5/16-3/8			
96BP-AS/BV	2.47	1	000960998

96BPA

Clé mâle 6 pans coudée à 110° à tête sphérique, modèle côté extra court



mm	L mm	L1 mm	CHF		
1,5	71	9	3.10	5	000961960
2	86	11	3.25	5	000961961
2,5	96	13	3.35	5	000961962
3	104	15	3.70	5	000961963
4	116	17	4.40	5	000961964
5	132	19	5.25	5	000961965
6	155	21	7.65	5	000961966
8	176	24	10.10	2	000961968
10	200	27	15.80	2	000961970



	CHF		
96BPA/SC9	62.00	1	000961974
1,5-2-2,5-3-4-5-6-8-10 mm			
96BPA/SCV	5.50	1	000961988

96T

CLÉS 6 PANS COUDÉES avec poignées hautes performances

Rapide et facile à manipuler

La poignée de taille réduite est parfaitement équilibrée afin de pouvoir pivoter rapidement dans la paume de la main.

La forme ergonomique permet d'appliquer des couples extrêmement élevés.

Les extrémités hexagonales ont été conçues pour transmettre le maximum de couple possible à la vis.

La lame ronde est homogène par rapport à la lame hexagonale ce qui offre une résistance accrue.



La lame passe intégralement à l'intérieur de la poignée

96T

Clé mâle 6 pans à poignée en T haute performance

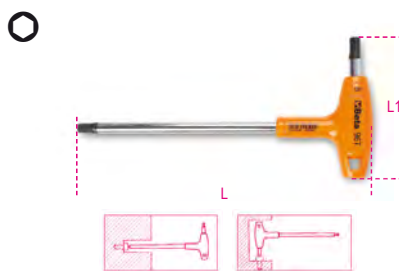

mm	L mm	L1 mm	CHF		
2	139	52	14.80	5	000960934
2,5	153	55	14.80	5	000960935
3	153	55	15.50	5	000960936
3,5	179	70	16.00	5	000960937
4	179	70	16.00	5	000960938
4,5	200	84	16.40	5	000960939
5	200	84	16.40	5	000960940
6	221	103	18.70	5	000960941
7	236	106	20.60	3	000960942
8	255	117	23.90	3	000960943
10	285	132	27.50	3	000960945



	CHF		
96T/S5P	81.00	1	000960946
2,5-3-4-5-6			
96T/S6	96.00	1	000960952
2-2,5-3-4-5-6 mm			
96T/S8	147.50	1	000960933
2-2,5-3-4-5-6-8-10 mm			
96T/S11	200.00	1	000960951
2-2,5-3-3,5-4-4,5-5-6-7-8-10 mm			



	CHF		
96T/SP11	250.00	1	000960957
2-2,5-3-3,5-4-4,5-5			
6-7-8-10 mm			
96T/SPV	56.00	1	000960958
96T/S11			
97TTX/S11			

96T/AS

Clé mâle 6 pans à poignée en T haute performance

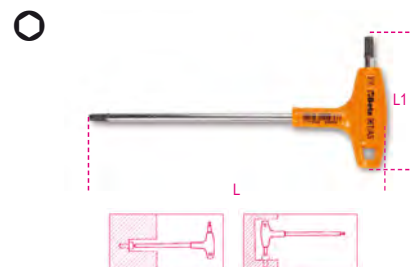

"	L mm	L1 mm	CHF		
3/32	153	55	18.40	2	000960669
7/64	153	55	18.40	2	000960670
1/8	179	70	18.60	2	000960671
9/64	179	70	19.50	2	000960672
5/32	200	84	19.50	2	000960673
3/16	200	84	19.50	2	000960674
7/32	221	103	21.70	2	000960675
1/4	236	106	24.20	2	000960676
5/16	255	117	27.50	2	000960678
3/8	285	132	33.00	2	000960680



	CHF		
96T/AS8	178.50	1	000960682
3/32-7/64-1/8-5/32-3/16-			
1/4-5/16-3/8			
96T/AS10	220.00	1	000960683
3/32-7/64-1/8-9/64-5/32			
3/16-7/32-1/4-5/16-3/8			

96TBP

Clé mâle 6 pans coudée
à tête sphérique et à poignée en T
haute performance



mm	L mm	L1 mm	CHF	🔧	📄
2,5	153	55	15.50	3	000960685
3	153	55	16.30	3	000960686
4	179	70	17.10	3	000960687
5	200	84	17.90	3	000960688
6	221	103	19.50	3	000960689
8	255	117	26.00	2	000960690
10	285	132	27.50	2	000960692



96TBP/S6		CHF	🔧	📄
2,5-3-4-5-6-8 mm		112.00	1	000960694

97TX

Clé mâle coudée pour vis TORX(R)



🔧	L mm	L1 mm	CHF	🔧	📄
T6	42	16	8.25	5	000970006
T7	48	16	8.25	5	000970007
T8	48	16	8.25	5	000970008
T9	48	16	9.05	5	000970009
T10	51	17	9.25	5	000970010
T15	54	18	9.25	5	000970015
T20	57	19	9.85	5	000970020
T25	60	20	10.10	5	000970025
T27	64	21	11.00	5	000970027
T30	70	24	11.00	5	000970030
T40	76	26	12.30	5	000970040
T45	83	29	14.80	5	000970045
T50	95	32	16.90	5	000970050
T55	108	35	21.50	5	000970055
T60	120	38	28.50	5	000970060



97TX/T8		CHF	🔧	📄
T9-T10-T15-T20-T25-T27-T30-T40		88.50	1	000970640



97TX/G8		CHF	🔧	📄
T9-T10-T15-T20-T25-T27-T30-T40		69.50	1	000970645



97TX/BG8		CHF	🔧	📄
T9-T10-T15-T20-T25-T27-T30-T40		55.00	1	000970368



97TX/SC8		CHF	🔧	📄
T9-T10-T15-T20-T25-T27-T30-T40		87.50	1	000970064
97TX/SCV		5.50	1	000970985



97TX/B13		CHF	🔧	📄
T6-T7-T8-T9-T10-T15-T20-T25-T27-T30-T40-T45-T50		140.50	1	000970650
96N/BV		2.47	1	000960651

97BTX

Clé mâle coudée à tête sphérique
pour vis TORX(R)

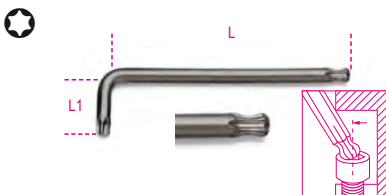

🔧	L mm	L1 mm	CHF	🔧	📄
T9	62	16	10.50	5	000970109
T10	71	17	10.50	5	000970110
T15	81	18	10.50	5	000970115
T20	92	19	11.30	5	000970120
T25	94	20	12.00	5	000970125
T27	105	21	12.80	5	000970127
T30	114	24	12.90	5	000970130
T40	129	26	14.90	5	000970140
T45	133	28	17.50	5	000970145



97BTX/SC8		CHF	🔧	📄
T9-T10-T15-T20-T25-T27-T30-T40		101.00	1	000970164
97BTX/SCV		5.50	1	000970983



97BTX/B8		CHF	🔧	📄
T9-T10-T15-T20-T25-T27-T30-T40		98.00	1	000970159
96N/BV		2.47	1	000960651

97BTX-C

Clé mâle coudée colorée
à tête sphérique pour vis Torx®

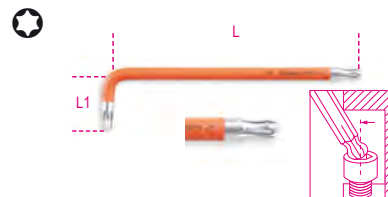

🔧	L mm	L1 mm	CHF	🔧	📄
T9	80	16	11.60	5	000971609
T10	86	17	11.60	5	000971610
T15	90	18	11.60	5	000971615
T20	95	19	12.70	5	000971620
T25	100	20	13.50	5	000971625
T27	105	21	14.30	5	000971627
T30	114	24	14.80	5	000971630
T40	124	26	16.30	5	000971640



97BTX-C/SC8		CHF	🔧	📄
T9-T10-T15-T20-T25-T27-T30-T40		111.50	1	000971658
97BTX-C/SCV		5.50	1	000971659



97BTLX

Clé mâle coudée à tête sphérique, série longue, pour vis Torx®



	L mm	L1 mm	CHF		
T9	80	15	11.00	3	000970309
T10	86	17	11.00	3	000970310
T15	100	18	11.00	3	000970315
T20	110	19	12.70	3	000970320
T25	126	20	13.90	3	000970325
T27	140	24	15.60	3	000970327
T30	160	28	16.30	3	000970330
T40	176	32	19.40	3	000970340



	CHF		
97BTLX/SC8 T9-T10-T15-T20- T25-T27-T30-T40	116.50	1	000970364
97BTLX/SCV	5.50	1	000970982

97RTX

Clé mâle coudée pour vis Tamper Resistant Torx®



	L mm	L1 mm	CHF		
T6	40	15	10.00	5	000970206
T7	45	15	10.00	5	000970207
T8	50	16	10.00	5	000970208
T9	56	16	10.00	5	000970209
T10	62	17	10.00	5	000970210
T15	72	17	10.00	5	000970215
T20	83	18	10.20	5	000970220
T25	90	18	10.50	5	000970225
T27	100	20	11.90	5	000970227
T30	105	24	12.00	5	000970230
T40	112	26	13.20	5	000970240
T45	118	26	15.50	5	000970245
T50	122	28	20.00	3	000970250
T55	128	30	22.90	3	000970255



	CHF		
97RTX/SC8 T9-T10-T15-T20-T25 T27-T30-T40	93.00	1	000970263
97RTX/SCV	5.50	1	000970984



	CHF		
97RTX/B8 T9-T10-T15-T20-T25 T27-T30-T40	90.00	1	000970260
96N/BV	2.47	1	000960651

97BRTLX/SC8

Jeu de 8 clés coudées longues à boisseau sphérique, pour vis Tamper Resistant Torx® inviolables



	CHF		
97BRTLX/SC8 T9-T10-T15-T20- T25-T27-T30-T40	118.00	1	000970464
97BRTLX/SCV	5.50	1	000970986

97TTX

Clé mâle pour vis TORX® à poignée en T haute performance



	L mm	L1 mm	CHF		
T6	130	52	15.30	3	000970706
T7	130	52	15.30	3	000970707
T8	139	52	15.40	3	000970708
T9	139	52	15.40	3	000970709
T10	179	70	15.80	3	000970710
T15	179	70	17.00	3	000970715
T20	179	70	17.60	3	000970720
T25	179	70	18.70	3	000970725
T27	200	84	20.60	3	000970727
T30	200	84	21.30	3	000970730
T40	221	103	25.50	3	000970740
T45	236	106	29.50	2	000970745
T50	255	117	38.00	2	000970750



	CHF		
97TTX/S6 T10-T15-T20-T25-T30-T40	116.00	1	000970791
97TTX/S8 T8-T10-T15-T20-T25- T27-T30-T40	152.00	1	000970808
97TTX/S11 T8-T9-T10-T15-T20-T25 T27-T30-T40-T45-T50	234.50	1	000970800
97TTX/S13 T6-T7-T8-T9-T10-T15-T20-T25 T27-T30-T40-T45-T50	265.00	1	000970813



	CHF		
97TTX/SP11 T8-T9-T10-T15-T20-T25 T27-T30-T40-T45-T50	284.00	1	000970840
96T/SPV 96T/S11 97TTX/S11	56.00	1	000960958

98KZN

Clé mâle coudée XZN®



DIN 65253

	L mm	L1 mm	CHF		
M5	83	25	7.15	5	000980005
M6	89	30	8.20	5	000980006
M8	97	32	10.40	5	000980008
M10	106	35	13.60	5	000980010
M12	116	37	17.20	5	000980012



	CHF		
98KZN/B5 M5-M6-M8-M10-M12	59.00	1	000980650
96N/BV	2.47	1	000960651

99

Clé à ergot pour écrous à encoches latérales UNI/ISO 2982, 2983



UNI 6752

	A mm	CHF		
12-14	1,5	13.80	3	000990012
16-18-20	1,8	13.80	3	000990016
22-25-28	1,8	18.40	3	000990022
30-32	2,1	18.40	3	000990030
34-36-38	2,4	22.30	3	000990034
40-42	2,4	22.30	3	000990040
45-50	2,5	27.50	3	000990045
52-55-58	2,5	27.50	3	000990052
62-65	3,1	34.50	3	000990062
68-70-75	3,1	34.50	3	000990068
80-85-90	3,8	46.50	2	000990080
92-95	4,3	46.50	2	000990092
98-100	4,3	46.50	2	000990098
105-110-115	4,4	73.50	1	000990105
120-125-130	4,9	73.50	1	000990120
135-145	6,0	108.50	1	000990135
155-165	6,0	108.50	1	000990155

99SQ

Clé à ergot articulée pour écrous à encoches latérales



mm	B mm	CHF		
15-35	2,7	37.00	2	000990215
35-50	3,5	42.00	2	000990235
50-80	4,7	55.00	2	000990250
80-120	6,2	75.50	2	000990280
120-180	7,8	101.00	2	000990290

99ST

Clé à ergot articulée pour écrous à trous latéraux



mm	Ø mm	B mm	CHF		
15-35	3,0	2,5	38.00	2	000990315
35-50	4,0	4,5	44.50	2	000990335
50-80	5,0	5,0	59.50	2	000990350
80-120	6,0	7,0	81.00	2	000990380
120-180	8,0	9,0	105.50	2	000990390

99 VN/...

Ergot pour 99ST

	mm	CHF		
99ST VN/15	15-35	10.40	1	000990295
99ST VN/35	35-50	12.00	1	000990296
99ST VN/50	50-80	14.80	1	000990297
99ST VN/80	80-120	17.00	1	000990298
99ST VN/120	120-180	22.30	1	000990299

100

Clé à ergots pour écrous à empreintes sur le dessus



Ø mm	L mm	Ø min-max mm	CHF		
4,8-5,8 6,9-7,9	250	18=100	194.00	1	001000001

100/KIT

Ergots pour art. 100



	CHF		
100/KIT	59.50	1	001000010

111E CLÉS À MOLETTE À OUVERTURE GRADUÉE

Les nouvelles clés à molette Beta 111XX permettent de visser et de dévisser des écrous et des boulons de différentes tailles grâce à la mâchoire mobile, l'ajustage se fait à l'aide de la molette située au centre. Tête inclinée à 15° permettant de l'utiliser dans les espaces les plus difficiles comme nos iconiques clés mixtes "42".



Ouverture de clé très large

Faible encombrement de la tête de la mâchoire lors de sa complète ouverture.

Double marquage laser en mm/pouces

L'étude de la nouvelle ergonomie permet d'obtenir la réduction de 20% de son poids. Fabriquée en acier allié haute performance pour une grande résistance mécanique à la torsion. Traitements thermiques dédiés pour une excellente résistance à l'usure. Orifice sur le manche de la clé permettant de l'accrocher.

111E

Clé à molette à ouverture graduée, chromée

- Rotation de la molette vers la droite
- Échelle millimétrique et en pouces



DIN 3117 ISO 6787

L mm	L "	A max mm	CHF		
100	4	15	32.00	3	001110110
150	6	24	33.50	3	001110115
200	8	29	41.00	3	001110120
250	10	34	49.50	3	001110125
300	12	40	65.50	3	001110130
380	15	45	129.00	3	001110138
450	18	54	214.50	2	001110145
600	24	62	297.00	1	001110160

111EN

Clé à molette à ouverture graduée, phosphatée

- Rotation de la molette vers la gauche
- Échelle millimétrique et en pouces



DIN 3117 ISO 6787

L mm	L "	A max mm	CHF		
100	4	15	29.50	3	001110410
150	6	24	31.00	3	001110415
200	8	29	36.00	3	001110420
250	10	34	44.50	3	001110425
300	12	40	60.00	3	001110430
380	15	45	119.00	3	001110438
450	18	54	202.50	2	001110445

111ER

Clé à molette à ouverture graduée et à mâchoire réversible, chromée

- Mâchoire réversible
- Rotation de la molette vers la droite
- Échelle millimétrique et en pouces



L mm	L "	A max mm	Ø max mm	CHF		
200	8	29	3/4	42.50	3	001110520
250	10	34	1	52.50	3	001110525
300	12	40	1.1/4	69.00	2	001110530

111CM

Clé à molette courte à ouverture majorée, chromée

- Ouverture majorée
- Rotation vers la droite
- Échelle millimétrique et en pouces



L mm	L "	A max mm	CHF		
170	6	32	49.00	2	001110770
220	8	38	59.50	3	001110722
270	10	46	78.50	3	001110727

120

Clé à tuyauter à cliquet

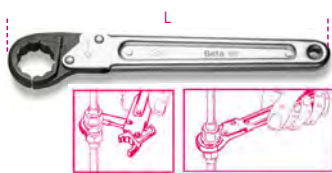

Ø mm	L mm	CHF	🔧	📄
10	135	61.50	1	001200010
11	135	61.50	1	001200011
12	135	61.50	1	001200012
13	135	61.50	1	001200013
14	135	69.50	1	001200014
17	185	75.00	1	001200017
19	185	80.00	1	001200019
22	230	108.50	1	001200022
24	230	116.50	1	001200024
27	230	148.00	1	001200027
30	320	168.00	1	001200030
32	320	178.00	1	001200032



Modèle	CHF	🔧	📄
120/B6N 10-11-13 17-19-22 mm	463.00	1	001200060
2002/BVL6	14.40	1	020020010

123E1/4

Adaptateur porte-embouts 1/4" pour clés à cliquet 10 mm



Ø mm	L mm	CHF	🔧	📄
10	20,6	8.05	1	001230010

123Q1/4

Adaptateur pour douilles 1/4" à déverrouillage rapide, pour clés à cliquet 10 mm



Ø mm	L mm	CHF	🔧	📄
10	17,5	11.20	1	001230310

123Q3/8

Adaptateur pour douilles 3/8" à déverrouillage rapide, pour clés à cliquet 13 mm



Ø mm	L mm	CHF	🔧	📄
13	22,5	11.30	1	001230313

123Q1/2

Adaptateur pour douilles 1/2" à déverrouillage rapide, pour clés à cliquet 19 mm



Ø mm	L mm	CHF	🔧	📄
19	30,5	12.00	1	001230319

123/K4

Kit de 4 adaptateurs pour clés à cliquet :
1 adaptateur porte-embouts
3 adaptateurs pour douilles à déverrouillage rapide



Modèle	CHF	🔧	📄
123/K4	42.50	1	001230504

141

Clé mixte droite à cliquet



ISO 21982:2020

Ø mm	L mm	CHF	🔧	📄
8x8	136	20.20	3	001410008
9x9	143	21.10	3	001410009
10x10	160	21.70	3	001410010
11x11	168	22.10	3	001410011
12x12	174	22.90	3	001410012
13x13	180	24.90	3	001410013
14x14	193	26.00	2	001410014
15x15	200	27.00	2	001410015
16x16	216	29.50	2	001410016
17x17	233	31.00	2	001410017
18x18	239	32.00	2	001410018
19x19	250	33.00	2	001410019



Modèle	CHF	🔧	📄
141/B6 8-10-13-14-17-19 mm	168.00	1	001410066
141/B9 8-10-11-12-13-14-15-17-19 mm	242.50	1	001410069



Modèle	CHF	🔧	📄
141/S12 8-9-10-11-12-13-14-15-16-17-18-19 mm	311.00	1	001410072

142

CLÉS À CLIQUET

Le cliquet rapide à 72 dents offre un angle de reprise de 5°, ce qui permet un serrage rapide et précis.

1 L'oeil fixe de la clé permet un serrage fort, calculé par rapport à la longueur de la clé.

2 Le bouton d'inversion intégré évite tout risque d'inversion accidentelle.



3 - 4 L'extrémité de l'œil de la clé est inclinée à 15° par rapport à l'axe ce qui réduit l'angle de reprise mais il permet également de protéger la main de l'utilisateur et de faciliter l'accès au travail de l'outil.



142

Clé mixte à cliquet réversible



ISO 21982:2020

Ø mm	L mm	CHF	🔧	📄
6x6	136	22.10	3	001420006
7x7	136	22.10	3	001420007
8x8	136	22.80	3	001420008
9x9	143	24.40	3	001420009
10x10	159	25.00	3	001420010
11x11	168	26.00	3	001420011
12x12	174	26.50	3	001420012
13x13	180	29.00	3	001420013
14x14	190	29.50	2	001420014
15x15	200	31.50	2	001420015
16x16	216	34.00	2	001420016
17x17	233	35.50	2	001420017
18x18	239	38.00	2	001420018
19x19	248	38.50	2	001420019
21x21	285	49.50	1	001420021
22x22	285	51.50	1	001420022
24x24	325	59.50	1	001420024
27x27	355	86.00	1	001420027
30x30	420	101.00	1	001420030
32x32	420	104.50	1	001420032
34x34	482	146.50	1	001420034
36x36	482	147.50	1	001420036
38x38	482	150.50	1	001420038



	CHF	🔧	📦
142/B6 8-10-13-14-17-19 mm	191.50	1	001420066
142/BV6	11.20	1	001420076
142/B9 8-10-11-12-13-14-15-17-19 mm	278.00	1	001420069
142/BV9	13.40	1	001420079



	CHF	🔧	📦
142/S15 6-7-8-9-10-11-12-13 14-15-16-17-18-19-22 mm	456.00	1	001420074
142/S17 6-7-8-10-11-12-13-14-15- 16-17-18-19-21-22-24-27 mm	627.00	1	001420068
142/S19 6-7-8-9-10-11-12 13-14-15-16-17-18 19-22-24-27-30-32 mm	808.00	1	001420075

142/SC9I-E

Jeu de 9 clés mixtes à cliquet réversible avec support compact



	CHF	🔧	📦
142/SC9I 8-10-11-12-13-14-15-17-19 mm	275.00	1	001420087
142/SCV9I	13.00	1	001420103
142/SC9E 8-10-11-12-13-16-17-18-19 mm	286.00	1	001420088
142/SCV9E	13.00	1	001420104

142MC

Clé mixte à cliquet réversible colorée



ISO 21982:2020

🔧	L	CHF	🔧	📦
mm	mm			
8x8	136	24.10	3	001422008
10x10	159	26.00	3	001422010
11x11	168	27.00	3	001422011
12x12	174	28.00	3	001422012
13x13	180	30.00	3	001422013
14x14	190	31.50	2	001422014
15x15	200	33.00	2	001422015
16x16	216	36.50	2	001422016
17x17	233	37.00	2	001422017
18x18	239	39.00	2	001422018
19x19	248	40.50	2	001422019



	CHF	🔧	📦
142MC/SC9I 8-10-11-12-13-14-15-17-19 mm	288.00	1	001422087
142MC/SC9E 8-10-11-12-13-16-17-18-19 mm	299.00	1	001422088

142AS

Clé mixte à cliquet réversible



🔧	L	CHF	🔧	📦
mm	mm			
5/16x5/16	136	27.00	2	001420308
3/8x3/8	159	27.50	2	001420310
7/16x7/16	168	29.00	2	001420311
1/2x1/2	180	33.00	2	001420313
9/16x9/16	190	33.50	2	001420314
5/8x5/8	216	37.00	2	001420316
11/16x11/16	233	38.00	2	001420317
3/4x3/4	248	41.50	2	001420319



	CHF	🔧	📦
142AS/8 5/16-3/8-7/16-1/2 9/16-5/8-11/16-3/4	267.00	1	001420330

142C

Clé mixte à cliquet - série courte droite



ISO 21982:2020

🔧	L	CHF	🔧	📦
mm	mm			
8x8	88	16.50	2	001420108
9x9	96	16.50	2	001420109
10x10	96	17.10	2	001420110
11x11	100	18.20	2	001420111
12x12	104	19.40	2	001420112
13x13	108	20.20	2	001420113
14x14	114	21.10	2	001420114
15x15	118	21.80	2	001420115
16x16	122	22.50	2	001420116
17x17	128	24.40	2	001420117
18x18	132	26.00	2	001420118
19x19	138	27.00	2	001420119



	CHF	🔧	📦
142C/A12 8-9-10-11-12-13-14 15-16-17-18-19 mm	284.00	1	001420175

142SN

Clé mixte à cliquet articulé



ISO 21982:2020

🔧	L	CHF	🔧	📦
mm	mm			
7x7	136	26.50	2	001420207
8x8	136	27.50	2	001420208
9x9	143	28.50	2	001420209
10x10	160	30.00	2	001420210
11x11	168	31.50	2	001420211
12x12	174	33.00	2	001420212
13x13	180	35.50	2	001420213
14x14	193	36.50	2	001420214
15x15	200	38.50	2	001420215
16x16	216	41.00	2	001420216
17x17	233	41.50	2	001420217
18x18	239	44.50	2	001420218
19x19	250	45.00	2	001420219
22x22	285	54.00	1	001420222
24x24	325	60.00	1	001420224



	CHF	🔧	📦
142SN/S13 7-8-9-10-11-12-13-14 15-16-17-18-19 mm	460.00	1	001420263



	CHF	🔧	📦
142SN/SC9 8-10-11-12-13-14-15-17-19 mm	330.00	1	001420259

186

Clé auto-serrante à reprise automatique pour 6 pans de 8 à 32 mm

Idéale pour vis à tête : à six pans, Spline, carrée, Torx® ; même abîmées.



L mm	CHF	🔧	📦
260	62.50	1	001860008

187

Clé ouvrable articulée



mm	L mm	CHF	🔧	📦
8x9	125	42.50	1	001870008
10x11	155	46.00	1	001870010
12x13	175	47.00	1	001870012
14x15	205	52.00	1	001870014
16x17	235	59.00	1	001870016



CHF	🔧	📦
187/B5	260.00	1 001870050
8x9-10x11-12x13		
14x15-16x17 mm		

188

Clé polygonale droite à cliquet pour poulies libres alternateurs



mm	L mm	CHF	🔧	📦
10	240	28.50	2	001880010
15	322	39.00	2	001880015

192

Clé polygonale double droite à cliquet réversible 4 en 1



mm	L mm	CHF	🔧	📦
8x10/12x13	160	36.50	1	001920008
16x17/18x19	230	46.50	1	001920016

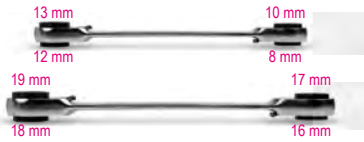

CHF	🔧	📦
192/S2	83.00	1 001920070
8x10/12x13 mm		
16x17/18x19 mm		

194

Clé à cliquet réversible porte-embouts



mm	L mm	CHF	🔧	📦
1/4x5/16	128	46.50	2	001940006

195

Clé polygonale double droite à cliquet



mm	L mm	CHF	🔧	📦
8x10	128	25.50	2	001950010
12x13	170	29.00	2	001950013
14x15	190	30.50	2	001950015
16x18	230	36.00	2	001950018
17x19	230	38.00	2	001950019



CHF	🔧	📦
195/B5	172.50	1 001950066
8x10-12x13-14x15		
16x18-17x19 mm		
195/BV5	13.40	1 001950070

195AS

Clé polygonale droite à cliquet



mm	L mm	CHF	🔧	📦
5/16x3/8	128	26.00	2	001950606
7/16x1/2	170	29.00	2	001950611
9/16x5/8	190	33.00	2	001950614
11/16x3/4	230	37.00	2	001950617



CHF	🔧	📦
195AS/B4	139.00	1 001950654
5/16x3/8 - 7/16x1/2 -		
9/16x5/8 - 11/16x3/4		
195FTX/BV4	13.40	1 001950520

195P

Clé 12 pans coudée à 15° à cliquet réversible



ISO 21982:2020

mm	L mm	CHF	🔧	📦
8x10	128	38.50	2	001950210
12x13	170	41.00	2	001950213
14x15	190	42.00	2	001950215
16x18	230	47.00	2	001950218
17x19	230	49.50	2	001950219



CHF	🔧	📦
195P/B5	232.00	1 001950266
8x10-12x13-14x15		
16x18-17x19 mm		
195/BV5	13.40	1 001950070

310

Fer à souder les tubes sanitaires PE, PP, PVC et PEHD

CE



230V-650 Watt
50 Hz±60Hz

Schuko (CEE 7/7)

mm	CHF	🔧	📦
310/2	498.00	1	003100002
Ø 16÷63			

310B

Embout pour 310



mm	CHF	🔧	📦
16	85.00	1	003100016
20	93.00	1	003100020
25	100.00	1	003100025
32	110.50	1	003100032
40	130.00	1	003100040
50	165.00	1	003100050
63	189.50	1	003100063



310/C8

Fer à souder avec composition de 7 matrices



310/C8
310/2+310B: Ø 16-20-25
32-40-50-63

CHF
1,118.00 1 003100108

440x270x120 mm - 7,7 kg

311

Fer à souder les tubes d'évacuation en PE

CE



	Ø mm	Watt	CHF		
311/1	120	300	444.00	1	003110001
311/2	190	900	494.00	1	003110002

DOMAINE D'UTILISATION DES COUPES TUBES BETA

Les coupe-tubes Beta couvrent un large éventail d'applications. Ils s'utilisent sur des tubes précis et lisses et l'avance effectuée par la vis télescopique permet des coupes précises et nettes sur tous les matériaux utilisés pour les tuyaux.

Le tableau ci-dessous présente les combinaisons coupe-tubes/molette de coupe prévu pour chaque matériau.

	TUYAUX DE GAZ EN ACIER			TUYAUX DE GAZ EN ACIER INOXYDABLE		
	10 mm 1/8"	60 mm 2"	115 mm 4"	10 mm 1/8"	60 mm 2"	115 mm 4"
330/2				330/2+330R/12		
330/4				330/4+330R/14		

	TUYAUX CUIVRE ET ALLIAGE LEGER							
	3 mm 1/8"	6 mm 1/4"	8 mm 5/16"	16 mm 5/8"	28 mm 1"1/8"	30 mm 1"1/2"	38 mm 1"1/2"	67 mm 2"5/8"
332								
334								
336								
338								

	TUYAUX MINCES EN ACIER INOXYDABLE							
	3 mm 1/8"	6 mm 1/4"	8 mm 5/16"	16 mm 5/8"	28 mm 1"1/8"	30 mm 1"1/2"	38 mm 1"1/2"	67 mm 2"5/8"
332 + 334R/1								
334 + 334R/1								
336 + 338R/1								
338 + 338R/1								

	TUYAUX EN PLASTIQUE							
	6 mm 1/4"	8 mm 5/16"	16 mm 5/8"	30 mm 1"1/8"	38 mm 1"1/2"	50 mm 2"	67 mm 2"5/8"	127 mm 5"
336 + 338RP								
338 + 338RP								
339A								

330

Coupe-tubes pour tubes acier



	Ø mm - "	L mm	CHF		
330/2	10÷60 1/8"÷ 2"	380	211.50	1	003300002
330/4	60÷115 2"÷ 4"	585	481.00	1	003300004

330R/A

Molette pour article 330 pour tubes en acier



	Ø mm	S mm	CHF		
330R/A2	32	7	20.30	1	003300012
330R/A4	42	9	52.50	1	003300014

330R/1

Molette pour article 330 pour acier inox



	Ø mm	S mm	CHF		
330R/12	32	7	45.00	1	003300024
330R/14	32	9	127.00	1	003300034

331C

Coupe-tubes de poche en forme de C pour tubes cuivre et alliages légers



	Ø mm	L mm	CHF		
15÷22	15	78	75.00	1	003310050

332

Mini coupe-tubes pour tubes cuivre et alliages légers



Ø mm - "	L mm	CHF		
3÷16 1/8"÷5/8"	59	30.50	2	003320001
3÷28 1/8"÷1"1/8"	63	34.00	2	003320003

334

Coupe-tubes pour tubes cuivre et alliages légers



Ø mm - "	L mm	CHF		
3÷30 1/8"÷1"1/8"	150	42.00	1	003340001

334R

Molette pour article 332 et 334 pour cuivre et alliages légers

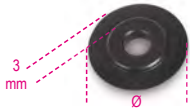

Ø mm	CHF		
334R 18	9.00	1	003340021

334R/I

Molette pour article 332 et 334 pour acier INOX



Ø mm	CHF		
334R/I 18	25.50	1	003340023

336

Coupe-tubes à avance télescopique rapide pour cuivre et alliages légers



Ø mm - "	L mm	CHF		
6÷38 1/4"÷1"1/2"	160	69.50	1	003360001

338

Coupe-tubes à avance télescopique rapide pour cuivre, alliages légers et plastiques



Ø mm - "	L mm	CHF		
6÷67 1/4"÷2"5/8"	290	173.00	1	003380001

338R

Molette pour article 331L, 336 et 338 pour cuivre et alliages légers



Ø mm	CHF		
338R 18,5	9.55	1	003380022

338R/I

Molette pour article 336 et 338 pour acier INOX

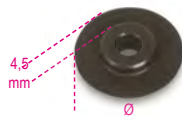

Ø mm	CHF		
338R/I 21,8	28.50	1	003380023

338RP

Molette pour article 336 et 338 pour plastiques



Ø mm	CHF		
338RP 21,9	10.40	1	003380025

339A

Coupe-tubes à avance télescopique rapide pour tube PVC



Ø mm - "	L mm	CHF		
50÷127 2"÷ 5"	345	370.00	1	003390011

339A/R

Molette pour 339A

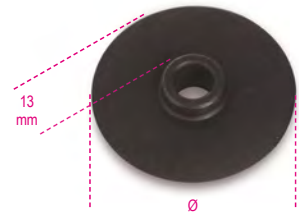

339A/R	Ø mm	CHF		
	42	25.50	1	003390061

340

Pince coupe-tubes pour tube multicouche Ø max 26 mm

Lame revêtue en PTFE
4 rouleaux d'appui pour faciliter la rotation du tube pendant la coupe
Système pour la coupe des tubes crantés intégré dans le manche

Corps léger en magnésium



Ø max mm	CHF		
340 26	144.00	1	003400001

340RL

Lame pour 340



340RL	CHF		
	41.00	1	003400010

340C

pincés de coupe de tuyaux ondulés

pincés en alliage d'aluminium et de magnésium · compact, format de poche, léger · lame supplémentaire pour la coupe longitudinale



Ø mm	L mm	CHF		
14-45	134	68.00	1	003400050

340C/KRL

kit de 3 lames de rechange pour 340C



340C/KRL	CHF			
	41.00	1	003400055	

341

Pince coupe-tubes en PVC



Ø mm	L mm	CHF		
0÷25	190	51.50	1	003410001

341RL

Lame pour 341



341RL	CHF			
	23.10	1	003410010	

341B

Coupe-tubes PVC à cliquet pour tubes plastiques



Ø mm	L mm	CHF		
0÷35	195	94.00	1	003410051

341B/RM

Ressort de rechange pour 341B

341B/RM	CHF			
	3.55	1	003410061	

341B/RL

Lame pour 341B



341B/RL	CHF			
	35.50	1	003410060	

342

Coupe-tubes PVC à cliquet pour tubes plastiques



Ø mm - "	L mm	CHF		
0÷42 1"5/8	200	69.00	1	003420030

342MOL

Ressort de rechange pour 342

342MOL	CHF			
	5.05	1	003420033	

342RL

Lame de rechange pour 342



342RL	CHF			
	31.50	1	003420032	

342A

Coupe-tubes PVC à cliquet pour tubes plastiques



Ø mm - "	L mm	CHF		
0÷50 2"	270	140.50	1	003420101

342A/MOL

Ressort de rechange pour 342A

342A/MOL	CHF			
	3.05	1	003420111	

342A/RL

Lame pour 342A



342A/RL	CHF			
	73.00	1	003420110	

342P

Coupe-tubes à cliquet en alliage de magnésium pour tubes plastiques



Ø mm - "	L mm	CHF		
0÷50 2"	260	152.50	1	003420121

342P/RL

Lame pour 342P



342P/RL	CHF			
	64.00	1	003420130	

Beta

345

Ébavureur tonneau corps en métal

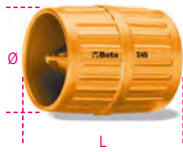

∅ mm - "	L mm	CHF	5	003450001
3÷42 1/8"÷1"5/8	58	37.00	5	003450001

345U

Ébavureur tonneau pour inox, acier, cuivre et alliages légers



∅ mm - "	L mm	CHF	1	003450050
4÷36 5/32÷1"7/16	60	98.00	1	003450050

345U/A

adaptateur pour aléuseur de tuyau 345U, Entraînement hexagonal 1/4 », pour pilotes d'alimentation



L mm	CHF	3	003450055
90	24.90	3	003450055

345C

Appareil d'étalonnage pour tuyaux multicouche



∅ mm	CHF	1	003450032
16-20-26-32	59.00	1	003450032

345SB

Ébavureur à lame tournante



L mm	CHF	5	003450010
150	30.50	5	003450010

345SB/R

Lame pour 345SB



CHF	3	003450015
10.80	3	003450015

345SB2

Ébavureur à lame fixe



L mm	CHF	5	003450022
140	15.30	5	003450022

345SC

Écouvillon 4 en 1 pour diamètres intérieurs et extérieurs 1/2" et 3/4"



L mm	L1 mm	L2 mm	CHF	2	003450060
195	28	32	17.90	2	003450060

345SI

Ébavureur interne à lame interchangeable tournante



L mm	∅ mm	CHF	1	003450040
168	16,5	58.00	1	003450040

345SI/R

Lame pour 345SI



CHF	1	003450045
40.50	1	003450045

349

Appareil à collets réglable pour cuivre et alliages légers



∅ mm - "	CHF	1	003490001
6-8-10-12-14-15-16-18 (1/8-3/16-1/4-5/16 3/8-1/2-5/8-3/4)	367.00	1	003490001

270x200x50 mm - 2,7 kg

349/SMM

Glissière métrique pour 349



∅ mm	CHF	1	003490011
6-8-10-12-14-15-16-18	108.00	1	003490011

349/SMAS

Glissière en pouces pour 349



∅ "	CHF	1	003490012
1/8-3/16-1/4-5/16 3/8-1/2-5/8-3/4	101.50	1	003490012

350

Appareil à collets pour cuivre et alliages légers



Ø mm	L mm	A mm	CHF	1	003500001
4-4,75-6-8-10-12-14	175	104	106.50		

351C

Coffret appareil à collets pour cuivre et alliages légers en coffret plastique



351C	CHF	1	003510010
	193.00		

334	Ø 3+30 mm (1/8"+1"1/8)
350	Ø 4+14 mm
351P	Ø 4-4,75-6-8-10-12-14 mm

225x150x45 mm - 1,6 kg

351P

Embout pour 350



351P	Ø mm	CHF	3	003510101
351P 4	4	8.80		
351P 4,75	4,75	8.80		
351P 6	6	8.80		
351P 8	8	8.80		
351P 10	10	8.80		
351P 12	12	8.80		
351P 14	14	8.80		

352U

Appareil à collets réglable pour cuivre et alliages légers

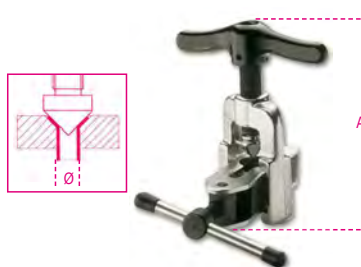

Ø mm -"	A mm	CHF	1	003520101
5÷16 3/16÷5/8	130	126.50		

352C/U

Composition articles 334, 345SB et 352U



352C/U	CHF	1	003520110
	248.50		

334	Ø 3+30 mm (1/8"+1"1/8)
345SB	
352U	Ø 5+16 mm (3/16"+5/8")

335x145x60 mm - 2120 g

355

Clé étagée pour radiateurs à cinq graduations



Ø"	L mm	CHF	2	003550001
3/8"-1/2" 3/4"-1"	90	50.00		

357F3

Gabarit à trois flacons pour l'installation de connexions sanitaires

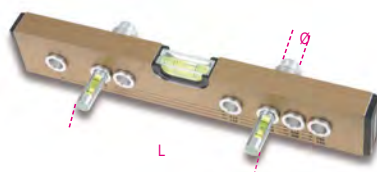

Ø"	L mm	CHF	1	003570100
3/8" / 1/2"	90÷220	159.50		

357R/F3

Flacon pour 357F3



357R/F3	CHF	1	003570101
	25.50		

358

Appareil pour couper et ébavurer les tubes PVC



358/1	Ø mm	CHF	1	003580001
358/2	16÷110	224.50		
	40÷250	224.50		

358RL

Lame pour 358/1 et 358/2



358RL	CHF	1	003580011
	41.50		

359

Clé à bondes



Ø"	L mm	A mm	CHF	1	003590001
1"÷1"1/4	160	140	110.50		

Beta

359CH

Adaptateur pour clé à bondes avec grattoir en croix pour 359



Ø "	L mm	CHF		
1"1/2	74	62.50	1	003590005

360

Clé serre-tubes modèle Stillson



L mm	Ø max "	Ø max mm	CHF		
250	1" gas	34	46.00	1	003600025
350	1"1/2 gas	49	60.50	1	003600035
450	2" gas	60	85.00	1	003600045
600	2"1/2 gas	76	130.00	1	003600060
900	3"1/2 gas	102	361.00	1	003600090

360R/...

Kit de rechange pour 360 composé de mâchoire mobile et molette.

	CHF		
360R 250	17.10	1	003600025
360R 350	23.60	1	003600035
360R 450	34.00	1	003600045
360R 600	50.00	1	003600060
360R 900	90.00	1	003600090

361N

Clé serre-tubes à une main avec mâchoire mobile



L mm	Ø max "	Ø max mm	CHF		
350	1" 1/2	49	95.00	1	003610014

362

Clé serre-tubes modèle américain



L mm	Ø max "	Ø max mm	CHF		
200	1" gas	34	40.50	1	003620020
250	1"1/2 gas	49	51.00	1	003620025
300	2" gas	60	60.50	1	003620030
350	2" gas	60	72.50	1	003620035
450	2"1/2 gas	76	104.50	1	003620045
600	3" gas	90	158.50	1	003620060
900	5" gas	140	194.50	1	003620090

362R/...

Kit pièces de rechange pour 362 composé de: mâchoire fixe, mâchoire mobile, molette, goupille de retenue.

	CHF		
362R 200	8.45	1	003620220
362R 225	12.00	1	003620225
362R 300	14.90	1	003620230
362R 350	17.10	1	003620235
362R 450	23.40	1	003620245
362R 600	31.50	1	003620260
362R 900	78.00	1	003620290

363

Clé serre-tubes modèle américain en alliages légers



L mm	Ø max "	Ø max mm	CHF		
350	2" gas	60	87.50	1	003630035
450	2"1/2 gas	76	118.00	1	003630045
600	3" gas	90	199.00	1	003630060
900	5" gas	140	373.00	1	003630090
1200	6" gas	165	396.00	1	003630120

363R/...

Kit pièces de rechange pour 363 composé de: mâchoire fixe, mâchoire mobile, molette, goupille de retenue.

	CHF		
363R 350	18.90	1	003630235
363R 450	25.00	1	003630245
363R 600	34.50	1	003630260
363R 900	68.00	1	003630290
363R 1200	105.50	1	003630320

365

Clé serre-tubes prise en bout en alliages légers



L mm	Ø max "	Ø max mm	CHF		
350	2" gas	60	109.00	1	003650035
450	2"1/2 gas	76	150.00	1	003650045

365R/...

Kit pièces de rechange pour 365 composé de: mâchoire fixe, mâchoire mobile, molette, goupille de retenue.

	CHF		
365R 350	82.00	1	003650235
365R 450	122.00	1	003650245

366

Clé étou



L mm	Ø max "	Ø max mm	CHF		
175	1" gas	34	41.50	1	003660017
225	1"1/2 gas	49	49.00	1	003660022
275	2" gas	60	59.50	1	003660027
300	2"1/2 gas	76	64.50	1	003660030
350	3" gas	90	72.50	1	003660035

374

Clé serre-tubes modèle suédois tête inclinée à 45°



DIN 5234

L mm	Ø max "	Ø max mm	CHF		
240	1/2" gas	21	47.50	1	003740024
320	1" gas	34	64.50	1	003740032
410	1"1/2 gas	49	84.50	1	003740041
550	2" gas	60	131.50	1	003740055
630	3" gas	90	235.00	1	003740063

375

Clé serre-tubes modèle suédois, tête inclinée à 45°



DIN 5234

L mm	Ø max "	Ø max mm	CHF		
320	1" gas	34	64.50	1	003750032
410	1"1/2 gas	49	84.50	1	003750041
550	2" gas	60	131.50	1	003750055

376

Clé serre-tubes modèle suédois tête inclinée à 90°



DIN 5234

L mm	Ø max "	Ø max mm	CHF		
320	1" gas	34	64.50	1	003760032
410	1"1/2 gas	49	84.50	1	003760041
550	2" gas	60	131.50	1	003760055
630	3" gas	90	238.50	1	003760063

378

Clé serre-tubes modèle suédois
tête inclinée à 45°, mâchoires fines



DIN 5234

L mm	Ø max "	Ø max mm	CHF		
250	1/2" gas	21	51.00	1	003780025
320	1" gas	34	67.50	1	003780032
410	1 1/2" gas	49	87.50	1	003780041
550	2" gas	60	144.50	1	003780055
650	3" gas	90	243.00	1	003780065

374R/...

KIT pièces de rechange complètes pour 374
- 375 - 376 - 378
composé de molette et bloque-molette

	CHF		
374R 240 x 374/240-378/250	2.86	1	003740724
374R 320 x 374/320-376/320-378/320	3.15	1	003740732
374R 410 x 374/410-375/410-376/410-378/410	3.90	1	003740741
374R 550 x 374/550-376/550-378/550	4.65	1	003740755
374R 630 x 374/630-378/650	7.05	1	003740763

383

Clé serre-tubes réversible à sangle



	Ø max "	Ø max mm	L mm	CHF		
383/1	3" gas	90	300	69.00	1	003830001
383/2	8" gas	220	300	72.50	1	003830002

383R

Sangle pour 383



	S mm	CHF		
383R/1	27	28.00	1	003830010
383R/2	27	29.50	1	003830015

384

Clé serre-tubes réversible à chaîne



Ø max "	Ø max mm	L mm	CHF		
4" gas	115	300	93.00	1	003840032

384RC

Chaîne pour 384



	CHF		
384RC	57.50	1	003840033

386A

Clé serre-tubes réversible
à chaîne gros effort



	Ø max gas	L mm	CHF		
386A/1	4" gas 115 mm	900	316.00	1	003860001
386A/2	6" gas 168 mm	900	585.00	1	003860002
386A/5	8" gas 220 mm	1100	754.00	1	003860005
386A/6	12" gas 324 mm	1300	1,305.00	1	003860006

386A/RC

Chaîne pour 386A



	CHF		
386A1/RC	98.50	1	003860011
386A2/RC	140.00	1	003860012
386A5/RC	186.00	1	003860015
386A6/RC	327.00	1	003860016

Beta

Beta

387

Pince à cintrer pour tubes cuivre et métaux
non ferreux
avec matrices interchangeables
3/16"-1/4"-5/16"-3/8"



L mm	Ø mm	CHF		
255	3/16"-1/4"-5/16"-3/8"	62.50	1	003870001

387R

Matrices pour 387



Ø "	CHF		
3/16"-1/4"	15.90	1	003870010
5/16"-3/8"	16.70	1	003870015

388

Pince à cintrer pour cuivre,
alliages légers et acier doux



Ø mm	L mm	R mm	CHF		
6	305	18,0	78.50	1	003880006
8	315	23,5	85.00	1	003880008
10	350	31,0	98.00	1	003880010
12	360	31,0	104.00	1	003880012
14	455	46,5	135.00	1	003880014
15	465	46,5	144.00	1	003880015
16	465	46,5	154.50	1	003880016

388A

Pince à cintrer pour tubes fins cuivre
et alliages légers



	Ø mm	L mm	CHF		
388A/1	6-8-10 mm	220	85.50	1	003880051
388A/2	1/4"-5/16"-3/8"	220	85.50	1	003880055

388C/C8

Cintreuse arbalète avec 7 matrices en aluminium pour tubes fins, cuivre recuit et alliages légers en coffret plastique



388C/C8	∅ mm	CHF	1	003880200
	10-12-14-16-18-20-22	624.00		

400x330x110 mm - 3,6 kg

389/K4

kit de ressorts de cintrage de tuyaux pour tuyaux en cuivre à usage externe



1/4-3/8-1/2-5/8	L mm	CHF	1	003890001
	290	26.50		

392C

Pince réglable pour siphons



∅ mm	L mm	CHF	1	003920100
25÷65	260	59.00		

392RG/C

Paire de mors pour 392C



392RG/C	CHF	1	003920101
	8.05		

Beta

393

Pince pour écrous de robinet



L mm	CHF	1	003930001
270	85.50		

395

Clé articulée pour écrous de robinet

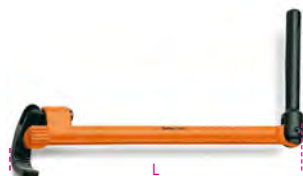

∅	L mm	CHF	1	003950001
15÷32 mm 5/8"÷1"1/4	240	56.50		

395T

Clé articulée télescopique pour écrous de robinet



∅	L mm	CHF	1	003950100
10÷32 mm 3/8"÷1"1/4	250÷430	75.50		

398

Étau à chaîne pour établi



∅	L mm	CHF	1	003980008
1/2÷8"	250	389.00		

399

Étau pour tubes



∅	L min mm	CHF	1	003990005
10÷60 mm 1/8÷2"	220	239.50		
10÷89 mm 1/8÷3"	290	429.00		

399R/...

Kit de rechange pour 399 composé de deux mâchoires inférieures et une supérieure



	CHF	1	003990105
399RG 1/8-2"	31.00		
399RG 1/8-3"	49.50		

Beta

Beta

TABLEAU POUR FORÊTS À MÉTAL TWIST

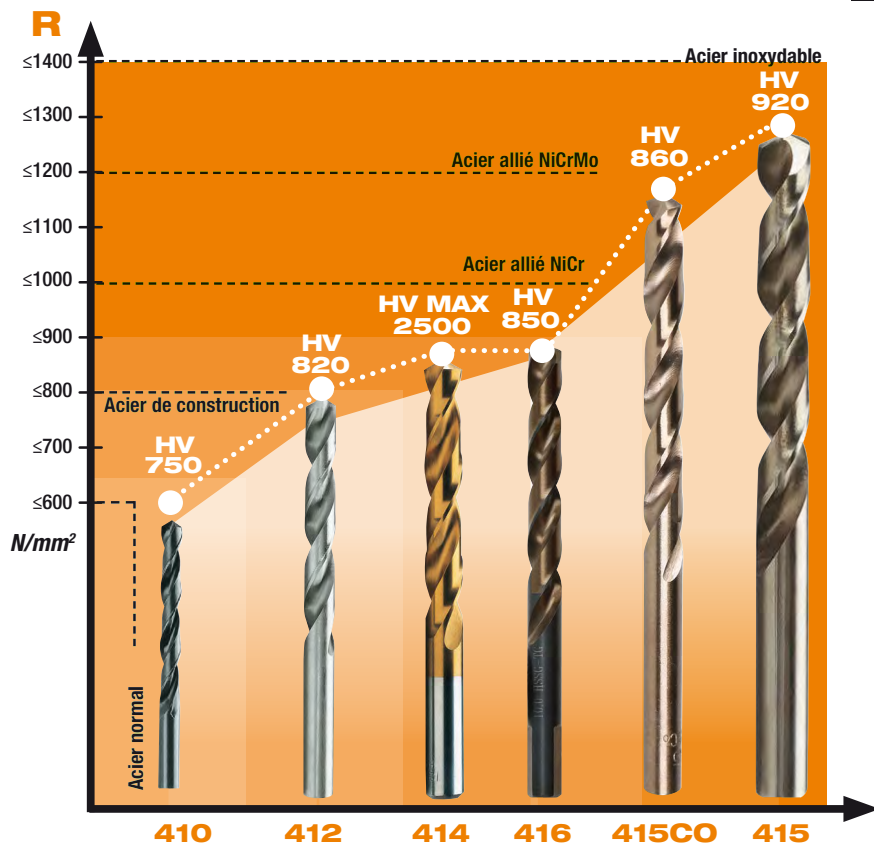

R N/mm² - C'est la résistance mécanique du matériau à percer.

HV - C'est la dureté du foret hélicoïdal selon l'échelle Vickers (plus la valeur est élevée, plus la dureté du matériau est élevée)

GUIDE DES FORÊTS DE PERCAGE A EMMENCHEMENT CYLINDRIQUE

Forets hélicoïdaux laminés – Les Forets hélicoïdaux laminés sont obtenus à partir d'un procédé de fabrication par laminage à chaud. Ils sont de bonne qualité, et s'utilisent pour des travaux légers, (exemples : perçage du fer, de l'acier doux, des alliages légers et des métaux non ferreux).

Forets hélicoïdaux rectifiés – Les Forets hélicoïdaux rectifiés sont obtenus à partir d'une barre d'acier traitée thermiquement. Ils sont utilisés pour des applications demandant des prestations hautes performances, comme le perçage de l'acier et des alliages légers. Ils sont d'une efficacité constante avec une évacuation des copeaux et une précision de perçage excellente.

HSS – L'Acier HSS est extrêmement dur et résistant aux hautes températures, ils est destinés aux outils de coupe, de taraudage et de filetage.

Cobalt (Co) – Le Cobalt est un matériau qui offre à l'acier une meilleure résistance à la chaleur et à l'usure (par exemple l'utilisation des forets hélicoïdaux à hautes températures). Plus la teneur en cobalt est élevée, meilleures sont les performances de l'outil. Les alliages les plus couramment utilisés ont une teneur en cobalt de 5% ou 8%.

HSS-Co – L'Acier HSS-Co possède une teneur en cobalt de 5% ou 8%.

TiN – Le revêtement ultrafin en nitrure de titane est utilisé pour sa dureté élevée et son faible facteur de friction, il permet une meilleure élimination des copeaux et offre une résistance accrue à l'usure et à l'oxydation.

Acier au chrome – Les outils en acier au chrome sont utilisés pour une utilisation manuelle comme le filetage sur du fer, des alliages légers, de l'acier non traité et de l'acier traité thermiquement à faible dureté. Ils sont largement utilisés pour le nettoyage et la réparation des filetages endommagés dans tous les travaux professionnels, industriel ou automobile.

Métal dur – Matériau à haute résistance à l'usure, utilisé dans les plaquettes des pointes des forets à béton.

Affûtage à 118° - C'est l'angle d'affûtage standard des forets hélicoïdaux pour métal. Il permet un perçage rapide, un centrage plus facile et une excellente dissipation de la chaleur dans les métaux.

Affûtage à 130° - C'est l'angle d'affûtage permettant d'offrir plus de précision dans les premières opérations de perçage et nécessitant moins de force de perçage.

Double affûtage à 115 °/135° – Ce double affûtage permet de combiner les avantages des deux angles, et possède une fonction « brise-copeaux », il est le meilleur choix pour les matériaux à copeaux longs.

SDS-Plus – Fixation rapide et sûre pour perforateurs et burineurs.

410

Foret laminé en acier HSS, série courte

R ≤ 650 N/mm²
HV ~ 750-820



DIN 338 ISO 235

Ø mm	L mm	L1 mm	CHF		
0,50	22	6	2.06	10	004100030
1,00	34	12	1.15	10	004100040
1,25	38	16	0.95	10	004100043
1,50	40	18	0.89	10	004100046
1,75	46	22	0.89	10	004100049
2,00	49	24	0.81	10	004100052
2,25	53	27	0.95	10	004100055
2,50	57	30	0.89	10	004100058
2,75	61	33	0.95	10	004100061
3,00	61	33	0.89	10	004100064
3,20	65	36	1.20	10	004100066
3,25	65	36	1.20	10	004100067
3,50	70	39	1.12	10	004100070
3,75	70	39	1.34	10	004100073
4,00	75	43	1.23	10	004100076
4,20	75	43	1.54	10	004100078
4,25	75	43	1.54	10	004100079
4,50	80	47	1.38	10	004100082
4,75	80	47	1.59	10	004100085
5,00	86	52	1.52	10	004100088
5,25	86	52	2.16	10	004100091
5,50	93	57	2.03	10	004100094
5,75	93	57	2.21	10	004100097
6,00	93	57	2.03	10	004100100
6,25	101	63	2.63	10	004100103
6,50	101	63	2.48	10	004100106
6,75	109	69	3.15	10	004100109
7,00	109	69	2.93	10	004100112
7,50	109	69	3.10	10	004100118
8,00	117	75	3.65	10	004100124
8,50	117	75	3.85	10	004100130
9,00	125	81	4.65	5	004100136
9,50	125	81	5.15	5	004100142
10,00	133	87	5.65	5	004100148
10,50	133	87	6.75	5	004100172
11,00	142	94	8.00	5	004100184
11,50	142	94	8.30	5	004100196
12,00	151	101	9.20	5	004100210
12,50	151	101	10.10	5	004100222
13,00	151	101	10.70	5	004100234
14,00	160	108	14.10	5	004100242
15,00	169	114	16.50	5	004100250
16,00	178	120	20.60	5	004100258
17,00	184	125	22.70	3	004100262
18,00	191	130	27.00	3	004100266
19,00	198	135	30.50	3	004100270
20,00	205	140	36.50	3	004100274



	CHF		
410/SP19 Ø 1÷10 x 0,5 mm	59.00	1	004100419
410/SPVP1	33.00	1	004100421
410/SP25 Ø 1÷13 x 0,5 mm	124.00	1	004100425
410/SPVP2	45.00	1	004100427



410/SEL19 CHF 46.00 1 004100418
 Ø 1=10 x 0,5 mm

410MIX/SEL19

Jeu de 13 forets 410 et 6 forets avec mise rapportée en métal dur



410MIX/SEL19 CHF 46.00 1 004100417



Ø 1-1,5-2-2,5-3-3,5-4
 4,5-5-5,5-6-8-10 mm

Ø 4-5-6-8-9-10 mm

410A

Foret laminé en acier HSS, série courte, avec support réduit

R ≤ 650 N/mm²
 HV ~ 750+820



DIN 338 ISO 235

Ø mm	L mm	L1 mm	CHF		
13,50	160	108	16.60	5	004100281
14,00	160	108	16.60	5	004100283
14,50	169	114	19.40	5	004100285
15,00	169	114	19.40	5	004100287
15,50	178	120	23.90	5	004100289
16,00	178	120	23.90	5	004100291
16,50	184	125	25.00	3	004100292
17,00	184	125	25.00	3	004100293
17,50	191	130	30.00	3	004100294
18,00	191	130	30.00	3	004100295
18,50	198	135	33.50	3	004100296
19,00	198	135	33.50	3	004100297
19,50	205	140	39.00	3	004100298
20,00	205	140	39.00	3	004100299

410AS

Foret laminé en acier HSS, série courte, en pouces

R ≤ 650 N/mm²
 HV ~ 750+820



ANSI B94

Ø"	L mm	L1 mm	CHF		
1/16	48	22	0.81	10	004100371
5/64	51	25	0.89	10	004100372
3/32	57	32	1.00	10	004100373
7/64	67	38	1.12	10	004100374
1/8	70	41	1.22	10	004100375
9/64	73	44	1.32	10	004100376
5/32	79	51	1.41	10	004100377
11/64	83	54	1.59	10	004100378
3/16	89	59	1.83	10	004100379
13/64	92	62	1.90	10	004100380
7/32	95	64	2.06	10	004100381
15/64	98	67	2.42	10	004100382
1/4	102	70	2.72	10	004100383
17/64	105	73	3.20	10	004100384
9/32	108	75	3.55	10	004100385
19/64	111	78	3.90	10	004100386
5/16	114	81	4.95	10	004100387
21/64	117	84	5.15	10	004100388
11/32	121	87	5.95	5	004100389
23/64	124	89	6.10	5	004100390
3/8	127	92	6.40	5	004100391



410AS/SP21 CHF 88.50 1 004100429

Ø 1/16-5/64-3/32-7/64
 1/8-9/64-5/32-11/64-3/16
 13/64-7/32-15/64-1/4
 17/64-9/32-19/64-5/16
 21/64-11/32-23/64-3/8

410AS/SPV1 CHF 33.50 1 004100430



410AS/SEL21 CHF 70.50 1 004100433

Ø 1/16-5/64-3/32-7/64
 1/8-9/64-5/32-11/64-3/16
 13/64-7/32-15/64-1/4
 17/64-9/32-19/64-5/16
 21/64-11/32-23/64-3/8

412

Foret taillé en acier HSS, rectifié poli, série courte

R ≤ 800 N/mm²
 HV ~ 750+820



DIN 338 ISO 235

Ø mm	L mm	L1 mm	CHF		
0,50	22	6	3.60	10	004120030
1,00	34	12	2.30	10	004120040
1,25	38	16	2.46	10	004120043
1,50	40	18	2.06	10	004120046
1,75	46	22	2.06	10	004120049
2,00	49	24	1.74	10	004120052
2,25	53	27	2.21	10	004120055
2,50	57	30	1.90	10	004120058
2,75	61	33	2.21	10	004120061
3,00	61	33	2.00	10	004120064
3,25	65	36	2.61	10	004120067
3,50	70	39	2.40	10	004120070
3,75	70	39	2.86	10	004120073
4,00	75	43	2.61	10	004120076
4,25	75	43	3.35	10	004120079
4,50	80	47	2.99	10	004120082
4,75	80	47	3.60	10	004120085
5,00	86	52	3.35	10	004120088
5,25	86	52	4.70	10	004120091
5,50	93	57	4.35	10	004120094
5,75	93	57	5.25	10	004120097
6,00	93	57	4.55	10	004120100
6,25	101	63	6.60	10	004120103
6,50	101	63	5.75	10	004120106
6,75	109	69	7.40	10	004120109
7,00	109	69	6.75	10	004120112
7,25	109	69	8.25	5	004120115
7,50	109	69	7.00	5	004120118
7,75	117	75	9.45	5	004120121
8,00	117	75	8.60	5	004120124
8,25	117	75	10.50	5	004120127
8,50	117	75	10.60	5	004120130
8,75	125	81	11.70	5	004120133
9,00	125	81	11.00	5	004120136
9,25	125	81	12.80	5	004120139
9,50	125	81	11.50	5	004120142
9,75	133	87	14.30	5	004120145
10,00	133	87	12.80	5	004120148
10,25	133	87	19.50	5	004120149
10,50	133	87	17.10	5	004120150
10,75	142	94	23.30	5	004120151
11,00	142	94	20.50	5	004120152
11,25	142	94	24.80	5	004120153
11,50	142	94	21.60	5	004120154
11,75	142	94	27.00	5	004120155
12,00	151	101	23.70	5	004120156
12,25	151	101	29.00	5	004120157
12,50	151	101	25.50	5	004120158
12,75	151	101	33.50	5	004120159
13,00	151	101	26.50	5	004120160



412/SP19 CHF 117.00 1 004120419

Ø 1=10 x 0,5 mm

410/SPVP1 CHF 33.00 1 004100421

412/SP25 CHF 243.00 1 004120425

Ø 1=13 x 0,5 mm

410/SPVP2 CHF 45.00 1 004100427

412/SP49 CHF 583.00 1 004120449

Ø 1=13 x 0,25 mm

412/SPV4 CHF 138.00 1 004120451



412/C150



412/C150 CHF 709.00 1 004120450

412	Ø 3 mm	n.
	Ø 1 - 1,5 - 2 - 2,5 - 3 - 3,5 - 4 - 4,5 - 5 mm	20
	Ø 5,5 - 6 - 6,5 - 7 - 7,5 - 8 - 8,5 - 9 - 9,5 - 10 mm	5

365x230x47 mm - 3,3 kg



412/SP91 CHF 756.00 1 004120452

Ø 1÷10 x 0,10 mm

412A

Foret taillé en acier HSS, série courte, rectifié bruni, avec support réduit

R ≤ 800 N/mm²
HV ~ 750÷820



DIN 338 ISO 235

Ø mm	L mm	L1 mm	CHF		
13,50	160	108	43.50	3	004120202
14,00	160	108	44.50	3	004120204
14,50	169	114	47.50	3	004120206
15,00	169	114	50.00	3	004120208
15,50	178	120	57.50	3	004120210
16,00	178	120	59.50	3	004120212
16,50	184	125	61.50	1	004120213
17,00	184	125	65.50	1	004120214
17,50	191	130	70.00	1	004120215
18,00	191	130	74.50	1	004120216
18,50	198	135	80.00	1	004120217
19,00	198	135	82.50	1	004120218
19,50	205	140	92.50	1	004120219
20,00	205	140	94.00	1	004120220

412L

Foret taillé en acier HSS, rectifié bruni, série longue

R ≤ 800 N/mm²
HV ~ 750÷820



DIN 340

Ø mm	L mm	L1 mm	CHF		
2,00	85	56	4.70	10	004120232
2,50	95	62	5.05	10	004120234
3,00	100	66	5.25	10	004120236
3,50	112	73	6.00	10	004120238
4,00	119	78	6.60	10	004120240
4,50	126	82	7.95	10	004120242
5,00	132	87	8.25	10	004120244
5,50	139	91	10.50	10	004120246
6,00	139	91	11.20	10	004120248
6,50	148	97	13.40	5	004120250
7,00	156	102	15.60	5	004120252
8,00	165	109	20.80	5	004120256
9,00	175	115	24.60	5	004120260
10,00	184	121	27.00	5	004120264

412XL

Foret taillé en acier HSS, rectifié, série extra-longue

R ≤ 800 N/mm²
HV ~ 750÷820



DIN 1869/1

Ø mm	L mm	L1 mm	CHF		
3,00	150	100	18.10	1	004120520
3,50	165	115	20.00	1	004120522
4,00	175	120	20.00	1	004120524
4,50	185	125	20.60	1	004120526
5,00	195	135	20.60	1	004120528
5,50	205	140	25.50	1	004120530
6,00	205	140	25.50	1	004120532
6,50	215	150	30.00	1	004120534
7,00	225	155	34.50	1	004120536
7,50	225	155	40.50	1	004120538
8,00	240	165	42.50	1	004120540
8,50	240	165	44.50	1	004120542
9,00	250	175	57.00	1	004120544
9,50	250	175	61.50	1	004120546
10,00	265	185	61.50	1	004120548
10,50	265	185	61.50	1	004120550
11,00	280	195	61.50	1	004120552
12,00	295	205	78.00	1	004120556
13,00	295	205	81.00	1	004120560



414

Foret taillé en acier HSS-TiN, rectifié, série courte

R ≤ 900 N/mm²
HV 0,05 ~ 2500



DIN 338 ISO 235

Ø mm	L mm	L1 mm	CHF		
1,00	34	12	3.10	10	004140040
1,25	38	16	3.60	10	004140042
1,50	40	18	2.78	10	004140046
1,75	46	22	3.60	10	004140048
2,00	49	24	2.93	10	004140052
2,25	53	27	3.65	10	004140054
2,50	57	30	3.10	10	004140058
2,75	61	33	4.20	10	004140060
3,00	61	33	3.45	10	004140064
3,25	65	36	4.45	10	004140066
3,50	70	39	4.20	10	004140070
3,75	70	39	4.65	10	004140072
4,00	75	43	4.20	10	004140076
4,25	75	43	5.15	10	004140078
4,50	80	47	4.65	10	004140082
4,75	80	47	5.85	10	004140084
5,00	86	52	5.45	10	004140088
5,25	86	52	7.55	10	004140090
5,50	93	57	6.50	10	004140094
5,75	93	57	7.95	10	004140096
6,00	93	57	7.25	10	004140100
6,25	101	63	9.20	10	004140102
6,50	101	63	8.05	10	004140106
6,75	109	69	11.00	10	004140108
7,00	109	69	8.85	10	004140112
7,25	109	69	12.20	5	004140114
7,50	109	69	10.90	5	004140118
7,75	117	75	14.30	5	004140120
8,00	117	75	12.80	5	004140124
8,25	117	75	14.90	5	004140125
8,50	117	75	13.30	5	004140130
8,75	125	81	18.50	5	004140132
9,00	125	81	16.50	5	004140136
9,25	125	81	21.10	5	004140138
9,50	125	81	18.50	5	004140142
9,75	133	87	22.10	5	004140144
10,00	133	87	19.60	5	004140148
10,50	133	87	22.90	5	004140150
11,00	142	94	24.80	5	004140152
11,50	142	94	27.00	5	004140154
12,00	151	101	28.50	5	004140156
12,50	151	101	33.50	5	004140158
13,00	151	101	34.50	5	004140160



414/SP19	CHF		
Ø 1÷10 x 0,5 mm	171.50	1	004140419
410/SPVP1	33.00	1	004100421
414/SP25	347.00	1	004140425
Ø 1÷13 x 0,5 mm			
410/SPVP2	45.00	1	004100427
414/SP49	764.00	1	004140429
Ø 1÷13 x 0,25 mm			
414/SPV4	138.00	1	004140430

414/C116



414/C116 CHF 699.00 1 004140450

414	Ø 1 - 1,5 - 2 - 2,5 - 3 - 3,5 - 4 - 4,5 - 5 mm	n.
	Ø 5,5 - 6 - 6,5 - 7 - 7,5 - 8 mm	3
	Ø 8,5 - 9 - 9,5 - 10 mm	2

365x230x47 mm - 2,7 Kg

415

Foret taillé en acier HSS-CO 8% rectifié, série courte

R ≤ 1400 N/mm²
HV ~ 850+920



DIN 338 ISO 235

Ø mm	L mm	L1 mm	CHF		
0,50	22	6	8.75	10	004150029
1,00	34	12	4.35	10	004150040
1,25	38	16	4.80	10	004150043
1,50	40	18	4.35	10	004150046
1,75	46	22	4.55	10	004150049
2,00	49	24	4.20	10	004150052
2,25	53	27	5.15	10	004150055
2,50	57	30	4.65	10	004150058
2,75	61	33	5.15	10	004150061
3,00	61	33	4.70	10	004150064
3,25	65	36	6.50	10	004150067
3,50	70	39	5.95	10	004150070
3,75	70	39	7.25	10	004150073
4,00	75	43	6.50	10	004150076
4,25	75	43	8.15	10	004150079
4,50	80	47	7.40	10	004150082
4,75	80	47	8.50	10	004150085
5,00	86	52	7.95	10	004150088
5,25	86	52	11.50	10	004150091
5,50	93	57	10.50	10	004150094
5,75	93	57	12.10	10	004150097
6,00	93	57	11.00	10	004150100
6,25	101	63	15.60	10	004150103
6,50	101	63	13.60	10	004150106
6,75	109	69	18.00	10	004150109
7,00	109	69	16.10	10	004150112
7,25	109	69	19.50	5	004150115
7,50	109	69	17.50	5	004150118
7,75	117	75	22.80	5	004150121
8,00	117	75	20.60	5	004150124
8,25	117	75	24.80	5	004150127
8,50	117	75	23.30	5	004150130
8,75	125	81	30.50	5	004150133
9,00	125	81	27.00	5	004150136
9,25	125	81	32.00	5	004150139
9,50	125	81	29.50	5	004150142
9,75	133	87	34.50	5	004150145
10,00	133	87	32.00	5	004150148
10,25	133	87	41.50	5	004150149
10,50	133	87	35.50	5	004150150
10,75	142	94	46.00	5	004150151
11,00	142	94	41.50	5	004150152
11,25	142	94	51.50	5	004150153
11,50	142	94	45.00	5	004150154
11,75	142	94	52.50	5	004150155

Ø mm	L mm	L1 mm	CHF		
12,00	151	101	49.00	5	004150156
12,25	151	101	62.50	5	004150157
12,50	151	101	52.50	5	004150158
12,75	151	101	69.00	5	004150159
13,00	151	101	56.50	5	004150160
14,00	160	108	99.00	3	004150164
15,00	169	114	117.00	3	004150168
16,00	178	120	144.00	3	004150172
17,00	186	125	163.50	1	004150174
18,00	194	130	181.50	1	004150176
19,00	202	135	209.00	1	004150178
20,00	210	140	235.00	1	004150180



415/SP19	CHF		
Ø 1÷10 x 0,5 mm	241.00	1	004150419
410/SPVP1	33.00	1	004100421
415/SP25	500.00	1	004150425
Ø 1÷13 x 0,5 mm			
410/SPVP2	45.00	1	004100427
415/SP49	1,240.00	1	004150431
Ø 1÷13 x 0,25 mm			
415/SPV4	138.00	1	004150432

415/C116



415/C116 CHF 1,054.00 1 004150450

415	Ø 1 - 1,5 - 2 - 2,5 - 3 - 3,5 - 4 - 4,5 - 5 mm	n.
	Ø 5,5 - 6 - 6,5 - 7 - 7,5 - 8 mm	3
	Ø 8,5 - 9 - 9,5 - 10 mm	2

365x230x47 mm - 2,7 kg



415/SP91 CHF 1,445.00 1 004150460
Ø 1÷10 x 0,10 mm

415CO

Foret taillé en acier HSS-CO 5 %, rectifié, série courte

R ≤ 1200 N/mm²
HV ~ 800+860



DIN 338 ISO 235

Ø mm	L mm	L1 mm	CHF		
1,00	34	12	2.21	10	004150310
1,50	40	18	2.21	10	004150312
2,00	49	24	2.21	10	004150314
2,50	57	30	2.30	10	004150316
3,00	61	33	2.30	10	004150320
3,50	70	39	2.86	10	004150322
4,00	75	43	3.35	10	004150324
4,50	80	47	3.85	10	004150326
5,00	86	52	3.95	10	004150328
5,50	93	57	5.05	10	004150330
6,00	93	57	5.60	10	004150332
6,50	101	63	6.65	10	004150334
7,00	109	69	8.20	10	004150336
7,50	109	69	8.95	5	004150338
8,00	117	75	10.60	5	004150340
8,50	117	75	11.00	5	004150342
9,00	125	81	13.50	5	004150344
9,50	125	81	14.30	5	004150346
10,00	133	87	16.50	5	004150348
10,50	133	87	20.00	5	004150350
11,00	142	94	22.10	5	004150352
11,50	142	94	24.30	5	004150354
12,00	151	101	26.50	5	004150356
12,50	151	101	29.00	5	004150358
13,00	151	101	31.50	5	004150360

415CO-A

Foret taillé en acier HSS-CO 5 %, rectifié, série courte

R ≤ 1200 N/mm²
HV ~ 800+860



DIN 338

Ø mm	L mm	L1 mm	CHF		
14,00	160	108	61.50	3	004150364
15,00	169	114	70.50	3	004150366
16,00	178	120	85.50	3	004150368
17,00	184	125	87.50	1	004150370
18,00	191	130	112.00	1	004150372
19,00	198	135	129.50	1	004150374
20,00	205	140	149.50	1	004150376



DIN 338

415CO/SP19 CHF 126.50 1 004150421
Ø 1÷10 x 0,5 mm
410/SPVP1 33.00 1 004100421

415L

Foret taillé en acier HSS-CO 5 %, rectifié, série longue

R ≤ 1200 N/mm²
HV ~ 800+860



DIN 340

Ø mm	L mm	L1 mm	CHF	🔧	📦
3,00	100	66	6.00	10	004150236
3,50	112	73	6.65	10	004150238
4,00	119	78	8.20	10	004150240
4,50	126	82	10.10	10	004150242
5,00	132	87	10.50	10	004150244
5,50	139	91	13.00	10	004150246
6,00	139	91	14.30	10	004150248
6,50	148	97	16.70	5	004150250
7,00	156	102	20.00	5	004150252
8,00	165	109	25.50	5	004150256
9,00	175	115	31.50	5	004150260
10,00	184	121	41.00	5	004150264

416

Foret cylindrique avec affûtage spécial à double paire de tranchants

R ≤ 900 N/mm²
HV ~ 820+850



VITESSE DE COUPE SUPÉRIEURE

DIN 338

Ø mm	L mm	L1 mm	CHF	🔧	📦
1,00	34	12	3.40	10	004160010
1,50	40	18	3.40	10	004160015
2,00	49	24	3.40	10	004160020
2,50	57	30	3.60	10	004160025
3,00	61	33	3.85	10	004160030
3,50	70	39	4.30	10	004160035
4,00	75	43	4.70	10	004160040
4,50	80	47	5.25	10	004160045
5,00	86	52	5.95	10	004160050
5,50	93	57	7.70	10	004160055
6,00	93	57	8.20	10	004160060
6,50	101	63	9.75	10	004160065
7,00	109	69	11.20	10	004160070
7,50	109	69	12.10	5	004160075
8,00	117	75	14.40	5	004160080
8,50	117	75	15.60	5	004160085
9,00	125	81	18.20	5	004160090
9,50	125	81	19.60	5	004160095
10,00	133	87	22.60	5	004160100



416/SP19	CHF	🔧	📦
Ø 1÷10 x 0,5 mm	170.50	1	004160419
410/SPVP1	33.00	1	004100421

416P/SP19

Jeu de 19 forets hélicoïdaux cylindriques en HSS, AISI M2, avec pointe réduite pour le centrage

Ø 1÷10 x 0,5 mm
VITESSE DE PERÇAGE SUPÉRIEURE
R ≤ 900 N/mm²
HV ~ 820+850

VITESSE DE COUPE SUPÉRIEURE



416P/SP19	CHF	🔧	📦
Ø 1÷10 x 0,5 mm	185.50	1	004160469

📏 115x170x40 mm

417

Foret béton en acier fraisé, avec plaquette en métal dur



DIN 8039

Ø mm	L mm	CHF	🔧	📦
3	70	4.55	10	004170003
4	75	4.55	10	004170004
5	85	4.80	10	004170005
5L	150	10.80	5	004170105
6	100	4.95	10	004170007
6L	150	10.80	5	004170106
7	120	5.60	10	004170009
8	120	6.15	10	004170010
8L	200	11.70	5	004170113
9	120	6.95	10	004170011
10	120	8.15	10	004170012
10L	200	14.00	5	004170120
12	150	10.60	10	004170014
12L	200	15.30	5	004170125
14	150	14.80	5	004170016
16	150	18.20	5	004170018



417/SP8	CHF	🔧	📦
Ø 3-4-5-6-8-9-10-12 mm	69.00	1	004170100

419

Foret pour marteau perforateur, corps fraisé avec plaquette en métal dur
HVA~ 1650



Ø mm	L mm	CHF	🔧	📦
4	110	9.30	10	004190002
5	110	9.30	10	004190004
5	160	10.30	10	004190006
6	110	9.10	10	004190012
6	160	10.10	10	004190014
6	210	13.40	10	004190016
7	160	11.00	10	004190028
8	110	9.85	10	004190030
8	160	10.60	10	004190032
8	210	12.80	10	004190034
8	260	17.40	10	004190036
8	310	21.30	10	004190038
8	460	39.00	10	004190042
9	160	13.00	5	004190044
10	160	13.40	5	004190050
10	210	15.50	5	004190052
10	260	19.40	5	004190054
10	310	27.00	5	004190056
10	460	42.50	5	004190060
12	160	14.90	5	004190064
12	210	20.20	5	004190066
12	260	21.70	5	004190068
12	460	44.50	5	004190074
14	160	20.60	3	004190086
14	260	24.80	3	004190090
14	310	35.50	3	004190092
14	460	46.00	3	004190096
16	210	30.50	3	004190112
16	260	32.00	3	004190114
16	310	39.00	3	004190116
16	460	51.50	3	004190120
18	260	41.50	1	004190124
20	310	41.50	1	004190128



419/SP7	CHF	🔧	📦
Ø 5 - 6 - 8 x 110 mm Ø 6 - 8 - 10 - 12 x 160 mm	95.50	1	004190507



419T

Foret pour marteau perforateur, corps fraisé à 4 hélices et 4 dents, support SDS Plus
HVA~ 1650

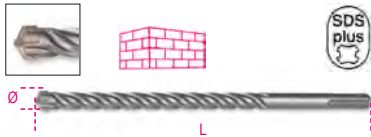

Ø mm	L mm	CHF		
5	110	6.35	5	004190604
5	160	7.05	5	004190606
6	110	6.65	5	004190612
6	160	7.80	5	004190614
6	210	10.60	5	004190616
7	160	7.95	5	004190628
8	110	7.25	5	004190630
8	160	8.20	5	004190632
8	210	10.90	5	004190634
8	260	12.40	5	004190636
8	310	15.30	5	004190638
9	160	8.70	3	004190644
10	160	8.75	3	004190650
10	210	11.70	3	004190652
10	260	12.70	3	004190654
10	310	18.10	3	004190656
10	460	24.60	3	004190660
12	160	9.80	3	004190664
12	210	12.80	3	004190666
12	260	13.50	3	004190668
12	460	25.50	3	004190674
14	160	13.30	2	004190686
14	260	15.50	2	004190690
14	310	22.00	2	004190692
14	460	24.60	2	004190696
16	210	17.60	2	004190712
16	260	23.30	2	004190714
16	310	25.00	2	004190716
16	460	26.00	2	004190720
18	260	28.50	1	004190724
20	310	34.50	1	004190728

421

Fraise à noyer pour têtes de vis cylindriques avec guide de centrage en acier HS



DIN 373

M	L mm	Ø mm	D1 mm	D mm	CHF		
3	71	6	3,2	5	34.00	1	004210003
4	71	8	4,3	5	34.00	1	004210004
5	80	10	5,3	8	34.00	1	004210005
6	80	11	6,4	8	34.50	1	004210006
8	100	15	8,4	12,5	56.50	1	004210008
10	100	18	10,5	12,5	67.00	1	004210010
12	100	20	13,0	12,5	72.50	1	004210012



421/SP6	CHF		
M 3-4-5-6-8-10	277.00	1	004210019
421/SPV	20.60	1	004210020

422

Foret à centrer rectifié avec angle de taraudage de 60° en acier HSS

• Exécution rapide et sûre des trous de centrage



DIN 333/A

Ø mm	D mm	L mm	CHF		
1,60	4,0	35,5	10.80	1	004220116
2,50	6,3	45,0	12.30	1	004220125
3,15	8,0	50,0	13.90	1	004220131

423

Foret à dépointer en acier HSS, rectifié



Ø mm	L mm	CHF		
6	66	21.30	5	004230006
7	74	26.00	5	004230007
8	79	28.50	5	004230008
10	89	33.50	5	004230010

423A

Fraise à dépointer en acier HSS, rectifiée



DIN 1412/E

Ø mm	L mm	CHF		
6,5	40	31.50	1	004230015
8,0	40	34.00	1	004230020

424

Foret conique en acier HSS

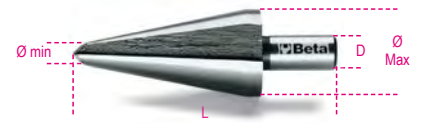

L mm	Ø mm	D mm	CHF		
424/1	58	3÷14	6	39.50	2 004240001
424/2	63	6÷20	8	66.50	2 004240002
424/3	60	16÷30	10	113.50	2 004240003
424/4	80	3÷22	8	139.00	1 004240004
424/5	102	3÷31	10	187.00	1 004240005
424/6	86	26÷40	13	238.00	1 004240006
424/7	89	36÷50	13	357.00	1 004240007
424/8	90	40÷61	13	591.00	1 004240008



424/SP3	CHF		
424/1+424/2+424/3	227.50	1	004240019
Ø 3÷30 mm			
424/SPV	31.50	1	004240020

425

Foret conique étagé en acier HSS



L mm	Ø mm	S mm	D mm	CHF		
425/1	70	4÷12	1 6	67.00	2	004250010
425/2	55	4÷12	2 6	70.50	2	004250012
425/3	85	4÷20	2 10	103.00	2	004250015
425/4	85	12÷20	1 10	157.00	1	004250016
425/5	97	20÷30	1 10	308.00	1	004250017
425/6	75	4÷30	2 10	214.50	1	004250020
425/7	97	30÷40	1 13	428.00	1	004250025
425/8	100	40÷50	1 13	596.00	1	004250029



425/SP3	CHF		
425/1+425/3+425/6	392.00	1	004250030
Ø 4÷30 mm			
425/SPV	31.50	1	004250035

426

Fraise à noyer
à 3 dents
en acier HSS



DIN 335-C

GR	Ø mm	L mm	Ø1 mm	CHF	1	004260001
1	4,3	44	4	22.30	3	004260001
2	5,3	44	4	22.30	3	004260002
3	6,3	44	5	23.30	3	004260003
4	7,3	44	6	27.00	3	004260004
5	8,3	50	6	27.00	3	004260005
6	9,4	50	6	30.50	3	004260006
7	10,4	54	6	34.00	3	004260007
8	12,4	54	8	36.50	3	004260008
9	15,0	56	10	41.50	3	004260009
10	16,5	60	10	44.00	3	004260010
11	20,5	63	10	60.00	3	004260011
12	25,0	66	10	95.50	3	004260012
13	28,0	71	12	128.50	3	004260013
14	31,0	71	12	135.50	3	004260014



DIN 335-C

426/SP6	CHF	1	004260030
GR 3-5-7-8-10-11 Ø 6,3÷20,5 mm	238.50		
426/SPV	31.50	1	004260035

426A/SP6

Jeu de 6 fraises à noyer
avec trois dents asymétriques et hélicoïdaux
en acier HSS

Ø 6,3 - 8,3 - 10,4 - 12,4 - 16,5 - 20,5 mm



426A/SP6	CHF	1	004260060
Ø 6,3-8,3-10,4-12,4-16,5-20,5 mm	249.00		
100x145x40 mm			

426T

fraise à noyer
à 3 dents
en acier HSS + TiN

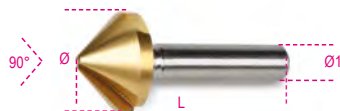

DIN 335-C

GR	Ø mm	L mm	Ø1 mm	CHF	3	004260061
1	4,3	44	4	29.00	3	004260061
2	5,3	44	4	29.00	3	004260062
3	6,3	44	5	29.50	3	004260063
4	7,3	44	6	33.50	3	004260064
5	8,3	50	6	33.50	3	004260065
6	9,4	50	6	35.50	3	004260066
7	10,4	54	6	41.50	3	004260067
8	12,4	54	8	43.50	3	004260068
9	15,0	56	10	48.50	3	004260069
10	16,5	60	10	54.50	3	004260070
11	20,5	63	10	70.50	3	004260071
12	25,0	66	10	107.00	3	004260072
13	28,0	71	12	134.00	3	004260073
14	31,0	71	12	144.00	3	004260074



DIN 335-C

426T/SP6	CHF	1	004260080
GR 3-5-7-8-10-11 Ø 6,3÷20,5 mm	273.00		
426/SPV	31.50	1	004260035

426SB

Fraise à noyer à 3 dents en acier HSS



GR	Ø mm	D mm	L mm	CHF	1	004260101	
426/SB1	1	2÷5	6	45	30.00	1	004260101
426/SB2	2	5÷10	8	48	37.00	1	004260102
426/SB3	3	10÷15	10	65	67.00	1	004260103
426/SB4	4	15÷20	12	85	129.00	1	004260104
426/SB5	5	20÷25	15	102	217.00	1	004260105
426/SB6	6	25÷30	15	115	367.00	1	004260106



426SB/SP4	CHF	1	004260130
426/SB1-426/SB2 426/SB3-426/SB4 Ø 2÷20 mm	299.00		
426SB/SPV1	31.50	1	004260135

426MD-3/CP3

Fraise lime rotative en métal dur

• Coupe croisée douce avec brise-copeaux



L mm	Ø mm	CHF	1	004260332
38,1	3	16.50		

426MD-3/CT3

Fraise lime rotative en métal dur

• Coupe croisée douce avec brise-copeaux



L mm	Ø mm	CHF	1	004260333
37,8	3	16.50		

426MD-3/F3

Fraise lime rotative en métal dur

• Coupe croisée douce avec brise-copeaux



L mm	Ø mm	CHF	1	004260334
38,3	3	16.50		

426MD-3/FA3

Fraise lime rotative en métal dur

• Coupe croisée douce avec brise-copeaux



L mm	Ø mm	CHF	1	004260339
38,2	3	16.50		

426MD-3/OG3

Mini foret rotatif en métal dur

• Coupe croisée douce avec brise-copeaux



L mm	Ø mm	CHF	1	004260337
38,1	3	16.50		

426MD-3/OV3

Fraise lime rotative en métal dur

• Coupe croisée douce avec brise-copeaux



L mm	Ø mm	CHF		
38,2	3	16.50	1	004260331

426MD-3/S3

Fraise lime rotative en métal dur

• Coupe croisée douce avec brise-copeaux



L mm	Ø mm	CHF		
38,0	3	16.50	1	004260338

426MD-3/T3

Fraise lime rotative en métal dur

• Coupe croisée douce avec brise-copeaux



L mm	Ø mm	CHF		
38,3	3	16.50	1	004260336

426MD-3/TA3

Fraise lime rotative en métal dur

• Coupe croisée douce avec brise-copeaux



L mm	Ø mm	CHF		
38,3	3	16.50	1	004260335



CHF		
148.00	1	004260349

426MD-3/A9
426MD-3/OV3 - 426MD-3/CP3
426MD-3/CT3 - 426MD-3/F3
426MD-3/TA3 - 426MD-3/T3
426MD-3/OG3 - 426MD-3/S3
426MD-3/FA3

426MD/CP

Fraise Lime rotative en métal dur

coupe croisée HM4



L mm	Ø mm	CHF		
50	6	46.00	1	004260532
63	8	51.00	1	004260512
63	9,5	57.00	1	004260542
69	12	80.50	1	004260522
69	16	115.50	1	004260552

426MD/CT

Fraise Lime rotative en métal dur

coupe croisée HM4



L mm	Ø mm	CHF		
50	6	46.00	1	004260533
63	8	51.00	1	004260513
63	9,5	57.00	1	004260543
69	12	80.50	1	004260523
69	16	111.50	1	004260553

426MD/F

Fraise Lime rotative en métal dur

coupe croisée HM4



L mm	Ø mm	CHF		
50	6	46.00	1	004260534
63	8	51.00	1	004260514
63	9,5	57.00	1	004260544
69	12	80.50	1	004260524
69	16	91.00	1	004260554

426MD/FA

Fraise Lime rotative en métal dur

coupe croisée HM4



L mm	Ø mm	CHF		
50	6	46.00	1	004260539
63	8	51.00	1	004260519
63	9,5	57.00	1	004260549
69	12	80.50	1	004260529
69	16	103.50	1	004260559

426MD/OG

Fraise Lime rotative en métal dur

coupe croisée HM4



L mm	Ø mm	CHF		
50	6	46.00	1	004260537
63	8	51.00	1	004260517
70	10	57.00	1	004260547
76	12	80.50	1	004260527
81	16	115.50	1	004260557

426MD/OV

Lime rotative en métal dur

coupe croisée HM4



L mm	Ø mm	CHF		
50	6	46.00	1	004260531
61	9,5	57.00	1	004260541
67	12	80.50	1	004260521
69	16	103.50	1	004260551

426MD/S

Fraise Lime rotative en métal dur

coupe croisée HM4



L mm	Ø mm	CHF		
50	6	46.00	1	004260538
51	8	51.00	1	004260518
53	9,5	57.00	1	004260548
56	12	80.50	1	004260528
59	16	91.00	1	004260558

426MD/T

Fraise Lime rotative en métal dur

coupe croisée HM4



L mm	Ø mm	CHF		
50	6	46.00	1	004260536
63	8	51.00	1	004260516
63	9,5	57.00	1	004260546
69	12	80.50	1	004260526
70	16	91.00	1	004260556

426MD/TA

Fraise Lime rotative en métal dur

coupe croisée HM4



L mm	Ø mm	CHF		
50	6	46.00	1	004260535
67	8	51.00	1	004260515
72	9,5	57.00	1	004260545
73	12	80.50	1	004260525
78	16	115.50	1	004260555



CHF		
594.00	1	004260510

426MD/SP10
426MD/CP-426MD/CT-426MD/F
426MD/T-426MD/S
Ø 8-12 mm

427

Chasse-cônes Morse



DIN 317

GR	L mm	A mm	CHF		
0	92	13	16.00	3	004270000
1-2	140	19	22.60	3	004270002
3	190	25	27.00	3	004270003
4	225	30	46.00	3	004270004
5-6	260	35	83.50	3	004270006

428FP

Tarands machine pour trous débouchants, pas gros, en acier HSS



ISO 529

M	■ mm	L mm	L1 mm	CHF		
3x0,5	2,7	56	11	21.80	10	004280003
4x0,7	3,4	63	13	21.80	10	004280004
5x0,8	4,9	70	16	21.80	10	004280005
6x1	4,9	80	19	22.90	10	004280006
8x1,25	6,2	90	22	27.50	10	004280008
10x1,5	8,0	100	24	33.00	10	004280010
12x1,75	9,0	110	29	42.50	5	004280012
14x2	9,0	110	30	52.00	5	004280014
16x2	9,0	110	30	62.50	5	004280016
18x2,5	11,0	125	34	80.50	3	004280018
20x2,5	12,0	140	34	90.50	3	004280020
22x2,5	14,5	140	34	109.00	3	004280022
24x3	14,5	160	38	118.50	3	004280024

428FC

Tarands machine pour trous borgnes, pas gros, en acier HSS



ISO 529

M	■ mm	L mm	L1 mm	CHF		
3x0,5	2,7	56	11	26.50	10	004280103
4x0,7	3,4	63	13	26.50	10	004280104
5x0,8	4,9	70	16	26.50	10	004280105
6x1	4,9	80	19	27.00	10	004280106
8x1,25	6,2	90	22	29.50	10	004280108
10x1,5	8,0	100	24	34.50	10	004280110
12x1,75	9,0	110	29	44.50	5	004280112
14x2	9,0	110	30	59.50	5	004280114
16x2	9,0	110	30	70.00	5	004280116
18x2,5	11,0	125	34	94.00	3	004280118
20x2,5	12,0	140	34	101.00	3	004280120
22x2,5	14,5	140	34	122.50	3	004280122
24x3	14,5	160	38	130.00	3	004280124

428/C14

Coffret de 14 tarands machine, 428FP et 428FC



428/C14	CHF		
428FP M3÷12	475.00	1	004280201
428FC M3÷12			
428/SPV	27.50	1	004280202

429FP

Tarand machine pour trous débouchants, pas gros, HSS-CO 5%



ISO 529

M	■ mm	L mm	L1 mm	CHF		
3x0,5	2,7	56	11	28.50	5	004290003
4x0,7	3,4	63	13	28.50	5	004290004
5x0,8	4,9	70	16	28.50	5	004290005
6x1	4,9	80	19	31.00	5	004290006
8x1,25	6,2	90	22	34.00	5	004290008
10x1,5	8,0	100	24	40.50	5	004290010
12x1,75	9,0	110	29	50.00	5	004290012
14x2	9,0	110	30	67.00	5	004290014

429FC

Tarands machine pour trous borgnes, pas gros, HSS-CO 5%



ISO 529

M	■ mm	L mm	L1 mm	CHF		
3x0,5	2,7	56	11	34.50	5	004290103
4x0,7	3,4	63	13	34.50	5	004290104
5x0,8	4,9	70	16	34.50	5	004290105
6x1	4,9	80	19	36.50	5	004290106
8x1,25	6,2	90	22	41.00	5	004290108
10x1,5	8,0	100	24	49.00	5	004290110
12x1,75	9,0	110	29	59.50	5	004290112
14x2	9,0	110	30	78.00	5	004290114

429/C14

Coffret de 14 tarands machine 429FP et 429FC



429/C14	CHF		
429FP M3÷12	583.00	1	004290201
429FC M3÷12			
428/SPV	27.50	1	004280202

430

Jeu de 3 tarands à main, pas gros, en acier au chrome

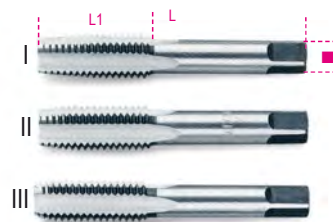

DIN 352 UNI 4535

M	■ mm	L mm	L1 mm	CHF		
2x0,4	2,5	36	11	19.00	5	004300002
3x0,5	2,5	40	12	13.40	5	004300003
4x0,7	3,0	45	14	13.40	5	004300004
5x0,8	4,0	48	16	13.90	5	004300005
6x1	5,0	50	18	14.00	5	004300006
7x1	4,5	50	18	18.00	5	004300007
8x1,25	5,0	56	22	18.10	3	004300008
9x1,25	5,5	63	22	24.60	3	004300009
10x1,5	6,0	70	25	23.30	3	004300010
11x1,5	7,0	70	25	30.00	3	004300011
12x1,75	7,0	75	30	30.00	3	004300012
14x2	8,0	80	32	38.00	3	004300014
16x2	10,0	80	32	44.50	3	004300016
18x2,5	11,0	95	40	59.50	1	004300018
20x2,5	12,0	95	40	71.50	1	004300020
22x2,5	14,5	100	40	87.00	1	004300022
24x3	14,5	110	50	103.00	1	004300024



430/SP21	CHF		
M 3-4-5-6-8-10-12	160.50	1	004300201
430/SPV	33.50	1	004300202

430ASW

Jeu de 3 tarauds à main, filetage Whitworth, en acier au chrome



DIN 352

BSW	mm	L	L1	CHF		
1/8x40	2,7	40	12	13.20	5	004300031
5/32x32	3,4	45	14	13.20	5	004300032
3/16x24	4,3	48	18	13.20	5	004300033
1/4x20	4,9	50	22	15.40	5	004300034
5/16x18	4,9	56	25	18.60	3	004300035
3/8x16	5,5	70	28	24.60	3	004300036
7/16x14	6,2	70	30	27.50	3	004300037
1/2x12	7,0	75	32	31.00	3	004300038
9/16x12	9,0	80	32	38.00	1	004300039
5/8x11	9,0	80	38	45.00	1	004300040
3/4x10	11,0	95	40	65.50	1	004300041
7/8x9	14,5	100	40	82.50	1	004300042
1"x8	16,0	110	50	106.50	1	004300043

430ASC

Jeu de 3 tarauds à main, filetage UNC en acier au chrome



ANSI B1.1

UNC	mm	L	L1	CHF		
1/4x20	4,9	70	30	19.60	5	004300051
5/16x18	4,9	70	30	25.50	5	004300052
3/8x16	5,5	75	35	28.50	3	004300053
7/16x14	6,2	80	40	37.00	3	004300054
1/2x13	7,0	85	45	46.50	3	004300055
9/16x12	9,0	90	45	57.00	3	004300056
5/8x11	9,0	100	47	65.50	3	004300057
3/4x10	11,0	110	50	88.50	3	004300058
7/8x9	14,5	120	60	102.50	1	004300059
1"x8	16,0	130	60	115.50	1	004300060

431

Jeu de 3 tarauds à main, pas gros en acier HSS



DIN 352 UNI 4535

M	mm	L	L1	CHF		
3x0,5	2,5	40	12	25.50	5	004310003
4x0,7	3,0	45	14	25.50	5	004310004
5x0,8	4,0	48	16	26.00	5	004310005
6x1	5,0	50	18	26.00	5	004310006
7x1	5,0	50	18	34.50	5	004310007

M	mm	L	L1	CHF		
8x1,25	5,0	56	22	31.50	3	004310008
10x1,5	6,0	70	25	39.00	3	004310010
12x1,75	7,0	75	30	59.00	3	004310012
14x2	9,0	80	32	82.50	1	004310014
16x2	9,0	80	32	93.00	1	004310016
18x2,5	11,0	95	40	139.50	1	004310018
20x2,5	12,0	95	40	149.50	1	004310020
22x2,5	12,0	100	40	214.00	1	004310022
24x3	14,5	110	50	241.00	1	004310024



	CHF		
431/SP21	293.00	1	004310201
M 3-4-5-6-8-10-12			
431/SPV	33.50	1	004310202

433

Jeu de 2 tarauds à main, pas fin, en acier au chrome



DIN 2181 UNI 4535

M	mm	L	L1	CHF		
6x0,75	4,5	48	16	11.70	5	004330201
7x0,75	4,5	56	18	14.50	5	004330202
8x0,75	5,0	50	16	14.50	5	004330203
8x1	5,0	56	16	14.50	5	004330204
9x0,75	6,0	63	22	19.00	5	004330205
9x1	6,0	63	22	19.00	5	004330206
10x0,75	6,5	63	18	19.00	5	004330207
10x1	6,5	63	18	19.00	5	004330208
10x1,25	6,5	63	18	19.00	5	004330209
11x0,75	7,0	70	25	25.50	3	004330210
11x1	7,0	70	25	25.50	3	004330211
11x1,25	7,0	70	25	25.50	3	004330212
12x0,75	7,0	70	20	24.80	3	004330213
12x1	7,0	70	20	24.80	3	004330214
12x1,25	7,0	70	20	24.80	3	004330215
12x1,5	7,0	70	20	24.80	3	004330216
14x1	8,0	80	32	33.00	1	004330217
14x1,25	8,0	80	32	33.00	1	004330218
14x1,5	8,0	80	32	33.00	1	004330219
16x1	10,0	80	32	38.50	1	004330220
16x1,5	10,0	80	32	38.50	1	004330221
18x1,5	11,0	95	40	45.00	1	004330222
18x2	11,0	80	25	59.00	1	004330223
20x1,5	14,5	80	22	67.00	1	004330224
22x1,5	14,5	80	22	80.00	1	004330225
24x1,5	14,5	80	22	93.00	1	004330226
24x2	14,5	80	22	92.50	1	004330227

Beta
Quality Tools

433ASF

Jeu de 2 tarauds à main, filetage UNF pas fin, en acier au chrome



ANSI B1.1

UNF	mm	L	L1	CHF		
1/4x28	4,9	70	30	14.80	5	004330301
5/16x24	4,9	70	30	17.60	5	004330302
3/8x24	5,5	75	35	20.00	3	004330303
7/16x20	6,2	80	40	25.50	3	004330304
1/2x20	7,0	85	45	32.00	3	004330305
9/16x18	9,0	90	45	40.50	3	004330306
5/8x18	9,0	100	47	45.00	3	004330307
3/4x16	11,0	110	50	61.50	3	004330308
7/8x14	14,5	120	60	79.50	1	004330309
1"x12	16,0	130	60	108.50	1	004330310

433ASG

Jeu de 2 tarauds à main, filetage GAS, en acier au chrome



DIN 5157

GAS	mm	L	L1	CHF		
1/8x28	5,5	65	18	21.10	1	004330401
1/4x19	9,0	70	24	27.00	1	004330402
3/8x19	9,0	75	25	33.00	1	004330403
1/2x14	12,0	80	31	46.00	1	004330405
3/4x14	16,0	90	33	75.50	1	004330408
1"x11	20,0	100	39	122.50	1	004330410

434

Jeu de 2 tarauds à main, pas fin, en acier HSS

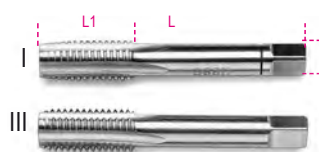

DIN 2181 UNI 4535

M	mm	L	L1	CHF		
6x0,75	4,5	48	16	33.50	5	004340001
8x0,75	5,0	56	16	39.00	5	004340003
8x1	5,0	56	16	39.00	5	004340004
10x0,75	6,5	63	18	49.00	5	004340007
10x1	6,5	63	18	49.00	5	004340008
10x1,25	6,5	63	18	49.00	5	004340009
12x1	7,0	70	20	52.50	3	004340014
12x1,25	7,0	70	20	52.50	3	004340015
12x1,5	7,0	70	20	52.50	3	004340016
13x1,5	9,0	70	20	110.50	1	004340017
14x1	9,0	70	20	65.50	1	004340018
14x1,25	9,0	70	20	65.50	1	004340019
14x1,5	9,0	70	20	56.50	1	004340020
15x1,5	9,0	70	20	110.50	1	004340021
16x1	9,0	70	20	70.50	1	004340022
16x1,5	9,0	70	20	60.50	1	004340023
18x1,5	11,0	80	22	78.50	1	004340024
18x2	11,0	90	25	95.50	1	004340025
20x1,25	12,0	80	22	135.00	1	004340026
20x1,5	12,0	80	22	83.50	1	004340027
20x2	12,0	90	25	103.50	1	004340028
22x1,5	14,5	80	22	120.00	1	004340029
24x1	14,5	80	22	160.50	1	004340030
24x1,5	14,5	80	22	135.00	1	004340031
24x2	14,5	80	22	141.50	1	004340032

435

Tourne-à-gauche extensible
corps en acier



DIN 1814

	□ mm	L mm	CHF		
435/0	2÷5 M1÷M8	170	22.70	3	004350007
435/1	2÷6 M1÷M10	200	27.00	2	004350009
435/1,5	2,5÷6 M1÷M12	200	29.00	2	004350011
435/2	3÷7 M4÷M12	260	41.00	2	004350013
435/3	4÷12 M5÷M20	345	68.00	1	004350020
435/4	5,5÷16 M9÷M27	430	106.00	1	004350027
435/5	7÷18 M13÷M32	770	240.00	1	004350032

435G

Tourne-à-gauche extensible
série légère



DIN 1814

	□ mm	L mm	CHF		
435G/0	2÷5 M1÷M8	130	16.10	5	004350108
435G/1	2÷6 M1÷M10	190	19.70	5	004350110
435G/1,5	2÷7 M2÷M12	175	20.60	5	004350112
435G/2	3,4÷7 M4÷M12	280	34.00	5	004350114
435G/3	4,9÷12 M5÷M20	380	54.50	2	004350121
435G/4	7÷16 M11÷M27	500	87.00	2	004350127
435G/5	7÷18 M13÷M32	700	137.00	1	004350132
435G/6	11÷24 M18÷M42	800	226.50	1	004350142

436

Porte-outils à cliquet réversible

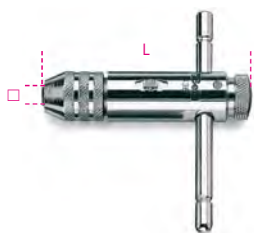

	□ mm	L mm	CHF		
436/1	2÷5 M3÷M8	85	38.00	5	004360002
436/2	4,6÷8 M5÷M12	110	47.50	5	004360004

436L

Porte-outils à cliquet réversible long



	□ mm	L mm	CHF		
436L/1	2÷5 M3÷M8	245	59.50	2	004360012
436L/2	4,6÷8 M5÷M12	295	69.50	2	004360014

436R

Etaux de rechange pour 436 et 436L

	CHF		
436R/1	7.00	1	004360022
436R/2	7.95	1	004360024

437P

Kit de réparation filetage interne et externe,
droite et gauche.

P 0,80±3,00 mm



L mm	CHF		
230	61.50	1	004370003

437C

Kit de réparation des filetages endommagés
de bougies, M14x1,25 mm

• hauteur hélicoïdes : 8,40 - 12,40 - 16,40 mm (5 pièces par mesure)



437C	CHF		
	160.00	1	004370100

437C/...

Hélicoïdes en acier inoxydable pour 437C



H mm	CHF		
8.4	41.00	1	004370108
12.4	41.00	1	004370112
16.4	41.00	1	004370116

Les prix indiqués sont pour 10 pièces

437C/RM14

Tarands pour filetages de bougies M14x 1,25



437C/RM14	CHF		
	132.50	1	004370124

437K/8

Kit de réparation filetages arbres de roues

• Permet de rétablir et de raviver le filetage original.
Compris dans le kit :

- mesures métriques :
20x1,25 - 20x1,5 - 22x1,00 - 22x1,5 - 24x1,5 - 24x2,00
- mesures en pouces :
3/4x20 - 13/16x20



○ 32 mm

437K/8	CHF		
	105.50	1	004370020

≡ 200x110x30 mm

437K/9

Kit de réparation pour filetages
mâle et femelle, vis fixation roues

Permet de rétablir et de raviver le filetage original

Compris dans le kit :

- tarauds :
M12x1,25 - M12x1,5 - M12x1,75 - M14x1,5
- filières :
M12x1,25 - M12x1,5 - M14x1,5



○ 12 - 24 mm

437K/9	CHF		
	111.00	1	004370029

≡ 161x123x50 mm

437K/12

Kit de réparation filetages arbres de roues

Permet de rétablir et de raviver le filetage original

Compris dans le kit:

• mesures métriques :

M16x1,0 - M16x1,5 - M20x1,0 - M20x1,5 - M22x1,5 - M24x1,5 - M24x2,0 - M27x2,0

• mesures en pouces :

3/4x16 - 3/4x20 - 13/16x20 - 27/32x20



⊙ 32 - 35 mm

437K/12 CHF 132.50 1 004370032
220x118x52 mm

437K/16

Kit de réparation des filetages endommagés sur les supports des étriers de freins M9x1,25



437K/16 CHF 149.00 1 004370016
210x150x50 mm

437K/33

Kit de réparation pour filetages endommagés de bougies de préchauffage

Filetages d'apport :

M8x1,0 - M10x1,0 - M10x1,25 - M12x1,25

Tarauds :

M8x1,0 - M10x1,0 - M10x1,25 - M12x1,0 - M12x1,25 - M14x1,25



437K/33 CHF 370.00 1 004370133
210x150x50 mm

437U/09

Kit de réparation des filetages endommagés M5-M6-M8-M10-M12



25 x M5, M6, M8, M10
10 x M12

437U/09 CHF 446.00 1 004370550
M5X0,8
M6X1,0
M8X1,25
M10X1,5
M12X1,75
370x230x55 mm - 2 Kg

437U/E-M...

Hélicoïdes en acier inoxydable



	H mm	CHF		
M5	7.5	23.80	1	004370555
M6	9	23.80	1	004370556
M8	12	33.00	1	004370558
M10	15	43.50	1	004370560
M12	18	27.00	1	004370562

Les prix indiqués se réfèrent à 25 pièces (10 pour la mesure M12)

437U/PM

Forets et tarauds mâles pour 437U/09



	CHF		
M5	44.50	1	004370565
M6	46.50	1	004370566
M8	62.50	1	004370568
M10	82.50	1	004370570
M12	103.00	1	004370572

438A

Jeu de forets pour percer, fileter et aléser, en acier HSS

• M3 - M4 - M5 - M6 - M8 - M10

• Avec poignée porte-embouts magnétique



1/4
S MAX mm = Ø mm

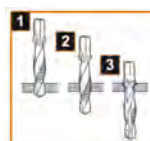

438A CHF 150.00 1 004380010

438...

Forets pour percer, fileter et aléser

en acier HSS, embout 1/4"

1/4



	S max mm	CHF		
M3	3	29.00	2	004380103
M4	4	29.00	2	004380104
M5	5	29.00	2	004380105
M6	6	29.00	2	004380106
M8	8	33.00	2	004380108
M10	10	33.00	2	004380110

440

Filière ronde, pas gros, en acier au chrome

R ≤ 600 N/mm²
HRC || 60+61



UNI 4535
DIN 223

M	Ø x S mm	CHF		
2x0,4	25,4 x 9	22.80	5	004400002
3x0,5	25,4 x 9	16.70	5	004400003
4x0,7	25,4 x 9	16.70	5	004400004
5x0,8	25,4 x 9	14.40	5	004400005
6x1	25,4 x 9	14.40	5	004400006
7x1	25,4 x 9	14.40	5	004400007
8x1,25	25,4 x 9	14.40	5	004400008
9x1,25	25,4 x 9	14.40	5	004400009
10x1,5	25,4 x 9	14.40	5	004400010
12x1,75	25,4 x 9	14.40	5	004400012

440A

Filière ronde, pas gros, en acier au chrome

R ≤ 600 N/mm²
HRC || 60+61



UNI 4535
DIN 223

M	Ø x S mm	CHF		
10x1,5	38,1 x 14	20.60	3	004400110
11x1,5	38,1 x 14	20.60	3	004400111
12x1,75	38,1 x 14	20.60	3	004400112
14x2	38,1 x 14	20.60	3	004400114
16x2	38,1 x 14	20.60	3	004400116
18x2,5	38,1 x 14	23.90	3	004400118
20x2,5	38,1 x 14	26.50	3	004400120

440B

Filière ronde, pas gros, en acier au chrome

R ≤ 600 N/mm²
HRC 60+61



UNI 4535
DIN 223

M	Ø x S mm	CHF		
18x2,5	50,8 x 16	36.50	3	004400122
20x2,5	50,8 x 16	38.50	3	004400124
22x2,5	50,8 x 16	41.50	3	004400126
24x3	50,8 x 16	42.00	3	004400128

440ASW

Filière ronde, filetage Whitworth, en acier au chrome

R ≤ 600 N/mm²



UNI EN 22568
DIN 223

BSW	Ø x S mm	CHF		
1/8x40	25,4 x 9	19.50	5	004400201
5/32x32	25,4 x 9	19.50	5	004400202
3/16x24	25,4 x 9	17.40	5	004400203
1/4x20	25,4 x 9	17.40	5	004400204
5/16x18	25,4 x 9	17.40	5	004400205
3/8x16	38,1 x 14	24.80	3	004400206
7/16x14	38,1 x 14	24.80	3	004400207
1/2x12	38,1 x 14	25.50	3	004400208
9/16x12	38,1 x 14	25.50	3	004400209
5/8x11	50,8 x 16	44.50	3	004400210
3/4x10	50,8 x 16	44.50	3	004400211
7/8x9	50,8 x 16	51.50	3	004400212
1"x8	50,8 x 16	51.50	3	004400213

440ASC

Filière ronde, filetage UNC, pas gros, en acier au chrome

R ≤ 600 N/mm²



UNI EN 22568
DIN 223

UNC	Ø x S mm	CHF		
1/4x20	25,4 x 9	17.20	5	004400221
5/16x18	25,4 x 9	17.20	5	004400222
3/8x16	38,1 x 14	23.90	3	004400223
7/16x14	38,1 x 14	23.90	3	004400224
1/2x13	38,1 x 14	23.90	3	004400225
9/16x12	38,1 x 14	23.90	3	004400226
5/8x11	50,8 x 16	50.00	3	004400227
3/4x10	50,8 x 16	50.00	3	004400228
7/8x9	50,8 x 16	50.00	3	004400229
1"x8	50,8 x 16	50.00	3	004400230

440ASF

Filière ronde, filetage UNF, pas fin, en acier au chrome

UNI EN 2258
DIN 223

UNF	Ø x S mm	CHF		
1/4x28	25,4 x 9	18.20	5	004400241
5/16x24	25,4 x 9	18.20	5	004400242
3/8x24	38,1 x 14	26.00	3	004400243
7/16x20	38,1 x 14	26.00	3	004400244
1/2x20	38,1 x 14	26.00	3	004400245
9/16x18	38,1 x 14	26.00	3	004400246
5/8x18	50,8 x 16	52.50	3	004400247
3/4x16	50,8 x 16	52.50	3	004400248
7/8x14	50,8 x 16	52.50	3	004400249
1"x12	50,8 x 16	52.50	3	004400250

440ASG

Filière ronde, filetage GAS, en acier au chrome

R ≤ 600 N/mm²



UNI EN 24231
DIN 223

GAS	Ø x S mm	CHF		
1/8x28	38,1 x 14	20.60	3	004400255
1/4x19	38,1 x 14	20.60	3	004400256
3/8x19	38,1 x 14	20.60	3	004400257
1/2x14	50,8 x 16	42.00	3	004400259
3/4x14	50,8 x 16	42.00	3	004400260
1"x11	63,5 x 19	82.50	3	004400261

441

Filière ronde, pas fin, en acier au chrome

R ≤ 600 N/mm²
HRC 60+61

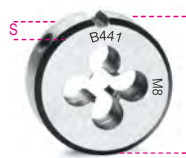

UNI 4535
DIN 223

M	Ø x S mm	CHF		
6x0,75	25,4 x 9	17.40	5	004410004
7x0,75	25,4 x 9	17.40	5	004410005
8x0,75	25,4 x 9	17.40	5	004410006
8x1	25,4 x 9	17.40	5	004410007
9x0,75	25,4 x 9	17.40	5	004410008
9x1	25,4 x 9	17.40	5	004410009

441A

Filière ronde, pas fin, en acier au chrome

R ≤ 600 N/mm²
HRC 60+61



UNI 4535
DIN 223

M	Ø x S mm	CHF		
10x0,75	38,1 x 14	26.00	3	004410100
10x1	38,1 x 14	26.00	3	004410101
10x1,25	38,1 x 14	26.00	3	004410102
11x0,75	38,1 x 14	26.00	3	004410103
11x1	38,1 x 14	26.00	3	004410104
11x1,25	38,1 x 14	26.00	3	004410105
12x0,75	38,1 x 14	26.00	3	004410106
12x1	38,1 x 14	26.00	3	004410107
12x1,25	38,1 x 14	26.00	3	004410108
12x1,5	38,1 x 14	26.00	3	004410109
14x1	38,1 x 14	26.00	3	004410110
14x1,25	38,1 x 14	26.00	3	004410111
14x1,5	38,1 x 14	26.00	3	004410112
16x1	38,1 x 14	26.00	3	004410113
16x1,5	38,1 x 14	26.00	3	004410114
18x1,5	38,1 x 14	26.00	3	004410115

441B

Filière ronde, pas fin, en acier au chrome

R ≤ 600 N/mm²
HRC 60+61



UNI 4535
DIN 223

M	Ø x S mm	CHF		
18x1,5	50,8 x 16	48.50	3	004410117
18x2	50,8 x 16	48.50	3	004410118
20x1,5	50,8 x 16	49.00	3	004410119
22x1,5	50,8 x 16	51.50	3	004410120
24x1,5	50,8 x 16	52.00	3	004410121
24x2	50,8 x 16	52.00	3	004410122



442

Filière ronde, pas gros, en acier HSS

HRC || 62+63
AISI M2



UNI EN 22568
DIN 223

M	ØxS mm	CHF		
3x0,5	20x5	20.20	3	004420003
4x0,7	20x5	20.20	3	004420004
5x0,8	20x7	20.60	3	004420005
6x1	20x7	20.60	3	004420006
7x1	25x9	22.90	3	004420007
8x1,25	25x9	22.90	3	004420008
10x1,5	30x11	26.00	3	004420010
12x1,75	38x14	44.00	3	004420012
14x2	38x14	56.50	1	004420014
16x2	45x18	71.50	1	004420016
18x2,5	45x18	75.50	1	004420018
20x2,5	45x18	75.50	1	004420020

443

Filière ronde, filetage UNF, pas fin, en acier HSS

HRC || 62+63
AISI M2



UNI EN 22568
DIN 223

M	ØxS mm	CHF		
6x0,75	20x7	34.50	1	004430107
8x0,75	25x9	38.50	1	004430110
8x1	25x9	36.50	1	004430111
10x0,75	30x11	47.00	1	004430113
10x1	30x11	42.00	1	004430114
10x1,25	30x11	42.00	1	004430115
12x1	38x10	69.00	1	004430116
12x1,25	38x10	69.00	1	004430117
12x1,5	38x10	69.00	1	004430118
13x1,5	38x10	82.00	1	004430119
14x1	38x10	69.00	1	004430120
14x1,25	38x10	69.00	1	004430121
14x1,5	38x10	69.00	1	004430122
15x1,5	38x10	91.50	1	004430123
16x1	45x14	101.50	1	004430124
16x1,5	45x14	101.50	1	004430125
18x1,5	45x14	101.50	1	004430127
20x1,25	45x14	104.50	1	004430129
20x1,5	45x14	104.50	1	004430130
20x2	45x14	104.50	1	004430131
22x1,5	55x16	126.50	1	004430132
24x1	55x16	131.00	1	004430133
24x1,5	55x16	131.00	1	004430135
24x2	55x16	138.00	1	004430136

444

Porte-filières, corps en acier



EN 22568
DIN 225

	Ø mm	L mm	CHF		
444	20x5	190	27.50	5	004440005
444/0	20x7	190	27.50	5	004440007
444/1	25,4x9,5	210	28.50	5	004440025
444/1A	25x9	215	29.50	5	004440027
444/1B	30x11	250	34.00	5	004440030
444/C	38x10	310	43.50	3	004440033
444/1C	38x14	310	43.50	3	004440035
444/2	38,1x12,7	300	44.50	3	004440038
444/1D	45x14	445	60.50	1	004440045
444/2D	45x18	445	60.50	1	004440046
444/3	50,8x15,9	520	87.50	1	004440050
444/4	55x16	495	87.50	1	004440055
444/5A	63,5x19	520	150.50	1	004440057

444G

Porte-filières, corps en alliages légers



UNI EN 22568
DIN 225

	Ø mm	L mm	CHF		
444G/A	16x5	160	12.90	5	004440103
444G	20x5	185	14.90	5	004440105
444G/0	20x7	185	14.90	5	004440107
444G/1	25,4x9,5	215	18.10	5	004440125
444G/1A	25x9	215	18.10	5	004440127
444G/1B	30x11	265	23.30	5	004440130
444G/C	38x10	315	34.00	3	004440133
444G/1C	38x14	315	34.00	3	004440135
444G/2	38,1x12,6	310	34.00	3	004440138
444G/1D	45x14	450	44.50	1	004440145
444G/2D	45x18	450	46.00	1	004440146
444G/3	50,8x16	485	47.50	1	004440150
444G/4	55x16	560	57.50	1	004440155
444G/5A	63,5x19	630	101.50	1	004440163
444G/6	65x18	630	108.00	1	004440165



446/C30

Composition de tarauds 430 et de filières 440 en acier au chrome, en coffret bois



446/C30 CHF 418.00 1 004460055
325x220x35 mm - 3,2 Kg

430 M mm	440 M mm		
3x0,5	3x0,5	435/1,5	444/1
4x0,7	4x0,7		
5x0,8	5x0,8		
6x1	6x1		
8x1,25	8x1,25		
10x1,5	10x1,5		
12x1,75	12x1,75		

446/C48

Composition de tarauds 430 et de filières 440 et 440A en acier au chrome, en coffret bois



446/C48 CHF 792.00 1 004460057
580x300x50 mm - 5 Kg

430 M mm	440 M mm	440A M mm		
3x0,5	3x0,5	10x1,5	435/1	444/1
4x0,7	4x0,7	12x1,75	435/3	444/2
5x0,8	5x0,8	14x2		
6x1	6x1	16x2		
8x1,25	8x1,25	18x2,5		
10x1,5		20x2,5		
12x1,75				
14x2				
16x2				
18x2,5				
20x2,5				

446/C110

Composition de tarauds 430 et 433
et de filières 440, 440A, 441, 441A
en acier au chrome "spéciale automobile"
en coffret bois



446/C110 CHF 1,146.00 1 004460060

500x337x60 mm - 8,1 Kg

430	433	440/440A	441/441A
M mm	M mm	M mm	M mm
2x0,4	6x0,75	2x0,4	6x0,75
3x0,5	7x0,75	3x0,5	7x0,75
4x0,7	8x0,75	4x0,7	8x0,75
5x0,8	8x1	5x0,8	8x1
6x1	9x0,75	6x1	9x0,75
7x1	9x1	7x1	9x1
8x1,25	10x0,75	8x1,25	10x0,75
9x1,25	10x1	9x1,25	10x1
10x1,5	10x1,25	10x1,5	10x1,25
11x1,5	11x0,75	11x1,5	11x0,75
12x1,75	11x1	12x1,75	11x1
14x2	11x1,25	14x2	11x1,25
16x2	12x0,75	16x2	12x0,75
	12x1		12x1
	12x1,25		12x1,25
	12x1,5		12x1,5
	14x1		14x1
	14x1,25		14x1,25
	14x1,5		14x1,5
	16x1		16x1
	16x1,5		16x1,5
	18x1,5		18x1,5



446ASF/C29

Composition de tarauds 433ASF
et de filières 440ASF
en acier au chrome, filetage UNF,
en coffret bois



446ASF/C29 CHF 908.00 1 004460070

660x410x50 mm - 6 Kg

433ASF	440ASF		
1/4	1/4	435/1,5	444/1
5/16	5/16	435/3	444/2
3/8	3/8		444/3
7/16	7/16		
1/2	1/2		
9/16	9/16		
5/8	5/8		
3/4	3/4		

446ASC/C37

Composition de tarauds 430ASC
et de filières 440ASC
en acier au chrome, filetage UNC
en coffret bois



446ASC/C37 CHF 972.00 1 004460080

660x410x50 mm - 6,7 Kg

430ASC	440ASC		
1/4	1/4	435/1,5	444/1
5/16	5/16	435/3	444/2
3/8	3/8		444/3
7/16	7/16		
1/2	1/2		
9/16	9/16		
5/8	5/8		
3/4	3/4		

446ASW/C36

Composition de tarauds 430ASW
et de filières 440ASW
en acier au chrome, filetage Whitworth
en coffret bois



446ASW/C36 CHF 671.00 1 004460075

525x310x50 mm - 3,4 Kg

430ASW	440ASW		
1/8	1/8	435/1,5	444/1
5/32	5/32	435/2	444/2
3/16	3/16		
1/4	1/4		
5/16	5/16		
3/8	3/8		
7/16	7/16		
1/2	1/2		

446ASG/C23

Composition de tarauds 433ASG
et de filières 440ASG
en acier au chrome, filetage GAS,
en coffret bois



446ASG/C23 CHF 1,415.00 1 004460085

700x430x70 mm - 9,8 Kg

433ASG	440ASG		
1/8	1/8	435/3	444/2
1/4	1/4	435/5	444/3
3/8	3/8		444/5A
1/2	1/2		
3/4	3/4		
1"	1"		

Beta

447/C37

Composition de tarauds 431 et de filières 442 en acier HSS en coffret métallique



447/C37 CHF 846.00 1 004470055

380x185x35 mm - 3,9 Kg

431 M mm	442 M mm		
3x0,5	3x0,5	435/0	444
4x0,7	4x0,7	435/2	444/0
5x0,8	5x0,8		444/1A
6x1	6x1		444/1B
8x1,25	8x1,25		444/1C
10x1,5	10x1,5		
12x1,75	12x1,75		

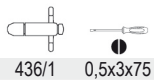

436/1 0,5x3x75

447/C53

Composition de tarauds 431 et de filières 442 en acier HSS en coffret métallique



447/C53 CHF 1,760.00 1 004470060

500x235x50 mm - 9 Kg

431 M mm	442 M mm			
3x0,5	3x0,5	435/1,5	444	436/1
4x0,7	4x0,7	435/3	444/0	436/2
5x0,8	5x0,8		444/1A	
6x1	6x1		444/1B	
8x1,25	8x1,25		444/1C	
10x1,5	10x1,5		444/2D	
12x1,75	12x1,75			
14x2	14x2			
16x2	16x2			
18x2,5	18x2,5			
20x2,5	20x2,5			

447/C70

Composition de tarauds 431, 434 et de filières 442, 443 en acier HSS en coffret bois



447/C70 CHF 2,215.00 1 004470065

510x340x70 mm - 7,5 Kg

431 M mm	434 M mm	442 M mm	443 M mm
3x0,5	8x1	3x0,5	8x1
4x0,7	10x1,25	4x0,7	10x1,25
5x0,8	12x1,25	5x0,8	12x1,25
6x1	12x1,5	6x1	12x1,5
7x1	14x1,25	7x1	14x1,25
8x1,25	14x1,5	8x1,25	14x1,5
10x1,5	16x1,5	10x1,5	16x1,5
12x1,75		12x1,75	
14x2		14x2	
16x2		16x2	

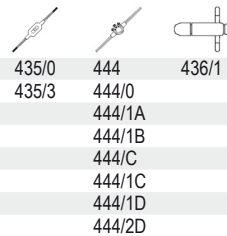

435/0 444 436/1
435/3 444/0
444/1A
444/1B
444/C
444/1C
444/1D
444/2D

450

Scies cloches trépan, bimétal, HSS-Co 8%



HSS-Co 8%

Ø mm	Ø	A mm	CHF		
16	(5/8)	57	22.30	1	004500016
17	(11/16)	57	22.30	1	004500017
19	(3/4)	51	22.30	1	004500019
20	-	51	22.30	1	004500020
21	(13/16)	51	22.30	1	004500021
22	(7/8)	51	22.30	1	004500022
24	(15/16)	51	22.30	1	004500024
25	(1")	51	24.60	1	004500025
27	(1 1/16)	51	25.50	1	004500027
29	(1 1/8)	51	25.50	1	004500029
30	(1 3/16)	51	25.50	1	004500030
32	(1 1/4)	51	25.50	1	004500032
33	(1 5/16)	51	26.00	1	004500033

Ø mm	Ø	A mm	CHF		
35	(1 3/8)	51	29.50	1	004500035
37	(1 7/16)	51	29.50	1	004500037
38	(1 1/2)	44	30.00	1	004500038
40	(1 9/16)	44	31.00	1	004500040
41	(1 5/8)	44	31.50	1	004500041
43	(1 11/16)	44	31.50	1	004500043
44	(1 3/4)	44	33.00	1	004500044
46	(1 13/16)	44	33.00	1	004500046
48	(1 7/8)	44	33.50	1	004500048
51	(2")	44	34.50	1	004500051
52	(2 1/16)	44	39.00	1	004500052
54	(2 1/8)	44	39.00	1	004500054
57	(2 1/4)	44	39.00	1	004500057
59	(2 5/16)	44	41.00	1	004500059
60	(2 3/8)	44	41.00	1	004500060
64	(2 1/2)	44	42.50	1	004500064
65	(2 9/16)	44	42.50	1	004500065
67	(2 5/8)	44	42.50	1	004500067
68	-	44	42.50	1	004500068
70	(2 3/4)	44	44.00	1	004500070
73	(2 7/8)	44	44.00	1	004500073
76	(3")	44	45.00	1	004500076
79	(3 1/8)	44	47.50	1	004500079
83	(3 1/4)	44	49.50	1	004500083
86	(3 3/8)	44	49.50	1	004500086
89	(3 1/2)	44	52.00	1	004500089
92	(3 5/8)	44	55.00	1	004500092
95	(3 3/4)	44	57.50	1	004500095
98	(3 7/8)	44	59.00	1	004500098
102	(4")	44	61.50	1	004500102
105	(4 1/8)	44	67.00	1	004500105
108	(4 1/4)	44	83.00	1	004500108
111	(4 3/8)	44	95.00	1	004500111
114	(4 1/2)	44	111.50	1	004500114
121	(4 3/4)	44	124.50	1	004500121
127	(5")	44	136.50	1	004500127
140	(5 1/2)	44	166.00	1	004500140
152	(6")	44	193.00	1	004500152

450AL

Mandrin et foret pilote pour 450



	Ø mm	L mm	CHF		
450AL/1	16÷30	54	27.00	1	004500210
450AL/2	32÷152	70	63.00	1	004500215

450AD

Adaptateur pour 450AL/1



	Ø mm	CHF		
450AD	32÷51	10.70	1	004500230

Beta
Quality Tools

450PA/1

Foret pilote HSS pour 450AL/1

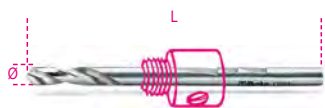

ØxL
mm
6,35x105

CHF
16.90

1 004500252

450PA/2

Foret pilote HSS pour 450AL/2

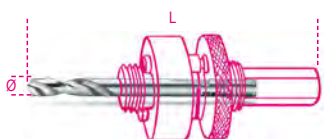

ØxL
mm
6,35x80

CHF
16.90

1 004500253

450PR

Rallonge pour 450



L
mm
305

CHF
46.00

1 004500255

450/C9

Composition «spéciale électricité»



HSS-Co 8%

450/C9

CHF
324.00

1 004500305

450 Ø 22 - 29 - 35 - 44 - 51 - 64 mm

450AL /1 - /2

450AD

220x160x60 mm - 1,6 Kg

450/C13

Composition
«spéciale métallerie-serrurerie»



HSS-Co 8%

450/C13

CHF
405.00

1 004500310

450 Ø 19 - 22 - 29 - 35 - 38
44 - 51 - 57 - 64 mm

450AL /1 - /2

450PA/1

450AD

215x180x65 mm - 1,8 Kg

450/C15

Composition de scies trépan
et accessoires pour électriciens



HSS-Co 8%

450/C15

CHF
529.00

1 004500313

450 Ø 16 - 20 - 25 - 32 - 40
51 - 60 - 65 - 70 mm

450AL /1 - /2

450PA /1 - /2

450PR

450AD

420x185x60 mm - 3,2 Kg

450/C21

Composition «spéciale industrie»



HSS-Co 8%

450/C21

CHF
925.00

1 004500315

450 Ø 19 - 22 - 29 - 35 - 38
44 - 51 - 57 - 64 - 76
83 - 92 - 95 - 105 - 114 mm

450AL /1 - /2

450PA /1 - /2

450PR

450AD

420x280x60 mm - 7 Kg

451

Fraise trépan en acier HSS
entièrement rectifiée



Ø mm	L mm	D mm	CHF		
12	85	8	33.50	1	004510012
13	85	8	33.50	1	004510013
14	85	8	34.00	1	004510014
15	85	10	34.00	1	004510015
16	85	10	34.00	1	004510016
17	85	10	34.00	1	004510017
18	85	10	34.00	1	004510018
19	85	10	34.50	1	004510019
20	85	10	36.50	1	004510020
21	85	10	39.50	1	004510021
22	85	10	41.50	1	004510022
23	85	10	43.50	1	004510023
24	85	10	44.50	1	004510024
25	85	10	46.00	1	004510025
26	90	10	48.50	1	004510026
27	90	10	49.50	1	004510027
28	90	10	51.00	1	004510028
29	90	10	52.50	1	004510029
30	90	10	53.50	1	004510030
31	90	10	56.50	1	004510031
32	90	10	57.50	1	004510032
33	90	10	59.50	1	004510033
34	90	10	61.50	1	004510034
35	90	10	63.00	1	004510035
36	85	10	65.50	1	004510036
37	85	10	67.00	1	004510037
38	85	10	68.00	1	004510038
39	85	10	70.00	1	004510039
40	85	10	71.50	1	004510040
41	85	10	73.00	1	004510041
42	85	10	77.00	1	004510042
43	85	10	79.50	1	004510043
44	85	10	80.50	1	004510044
45	85	10	82.50	1	004510045
46	85	10	82.50	1	004510046
47	85	10	85.00	1	004510047
48	85	10	89.00	1	004510048
49	85	10	91.50	1	004510049
50	85	10	91.50	1	004510050

451/C

Coffret contenant 8 fraises trépan HSS, entièrement rectifiées



451/C8	CHF		
430.00	1	004510308	

270x225x70 mm

451GA

Mandrin pour 451



M	Ø mm	L mm	D mm	CHF		
10x1,25	12÷14	57	8	19.10	1	004510101
12x1,25	15÷34	57	10	19.10	1	004510102
14x1,5	35÷50	57	10	23.30	1	004510105

451PA

Foret pilote pour 451 en acier HSS



Ø mm	L mm	CHF		
6	53	10.70	1	004510103

451PR

Rallonge pour 451



M	Ø mm	L mm	Ø1 mm	CHF		
12x1,25	15÷34	400	13	83.00	1	004510104
14x1,5	35÷50	400	13	83.00	1	004510108

Beta

452

Scie trépan à dents carbure

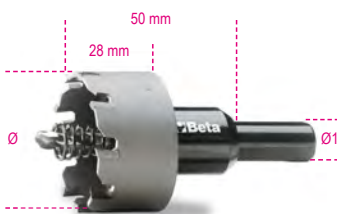

Ø mm	Ø1 mm	CHF		
15	10	137.00	1	004520015
16	10	137.00	1	004520016
17	10	137.00	1	004520017
18	10	137.00	1	004520018
19	10	137.00	1	004520019
20	10	137.00	1	004520020
21	10	137.00	1	004520021
22	10	137.00	1	004520022
23	10	137.00	1	004520023
24	10	137.00	1	004520024
25	10	137.00	1	004520025
26	10	154.50	1	004520026
27	10	154.50	1	004520027
28	10	154.50	1	004520028
29	10	154.50	1	004520029
30	10	154.50	1	004520030
31	10	186.00	1	004520031
32	10	186.00	1	004520032
33	10	186.00	1	004520033
34	10	186.00	1	004520034
35	10	186.00	1	004520035
36	10	215.50	1	004520036
37	10	215.50	1	004520037
38	10	215.50	1	004520038
39	13	215.50	1	004520039
40	13	215.50	1	004520040
41	13	243.50	1	004520041
42	13	243.50	1	004520042
43	13	243.50	1	004520043
44	13	243.50	1	004520044
45	13	243.50	1	004520045
46	13	274.00	1	004520046
47	13	274.00	1	004520047
48	13	274.00	1	004520048
49	13	274.00	1	004520049
50	13	274.00	1	004520050
55	13	311.00	1	004520055
60	13	413.00	1	004520060
65	13	413.00	1	004520065
70	13	481.00	1	004520070
75	13	525.00	1	004520075
80	13	569.00	1	004520080
85	13	642.00	1	004520085
90	13	681.00	1	004520090

452GA

Mandrin pour 452



	Ø mm	CHF		
452GA/1	15÷21	17.00	1	004520125
452GA/2	22÷38	19.80	1	004520126
452GA/3	39÷100	23.70	1	004520127

460

Scie trépan pour le secteur de la construction en bâtiment

- Pour béton armé, ciment, pierres naturelles et artificielles
- Profondeur maximale de perçage 60 mm



Ø mm	L mm	Z	CHF		
50	75	6	70.00	1	004600050
60	75	6	83.00	1	004600060
65	75	6	87.00	1	004600065
80	75	6	129.00	1	004600080
90	75	6	136.50	1	004600090
100	75	8	167.50	1	004600100
112	75	8	191.50	1	004600112
125	80	10	238.00	1	004600125
150	80	12	321.00	1	004600150

460PP

foret pilote pour scies trépan pour le secteur de la construction en bâtiment 460



Ø mm	L mm	CHF		
8	120	7.95	1	004600201

460G

Mandrin pour scies trépan 460



L mm	CHF		
220	43.50	1	004600222
370	60.00	1	004600237
460	95.50	1	004600246

MULTIPLICATEURS DE COUPLE

Les multiplicateurs de couple sont des outils essentiels pour serrer les écrous et les vis, car ils permettent de générer un couple plus élevé que celui que l'opérateur appliquerait normalement, dans des espaces restreints ou difficilement accessibles. Ils ne nécessitent pas de rallonges encombrantes, assurant ainsi une sécurité totale. **La gamme de multiplicateurs de couple Beta** offre une variété de solutions, de capacités (**jusqu'à 9 500 Nm**), et des rapports de multiplication de couple (jusqu'à 135:1). De nombreux modèles, en particulier les plus puissants, sont équipés d'un système anti-enroulement bidirectionnel, pour éviter les retours de tension dangereux sur l'opérateur. Tous les multiplicateurs de couple Beta sont accompagnés d'un **certificat** prouvant que l'outil a été testé à sa valeur maximale et dans des conditions optimales de fonctionnement.



Mode d'emploi

Le multiplicateur de couple doit être toujours **utilisé avec une clé dynamométrique** afin d'assurer le contrôle du couple de sortie, mais aussi avec des douilles à chocs.

Les rapports de chaque multiplicateur de couple déterminent le **facteur de multiplication** entre le couple d'entrée et le couple de sortie. Exemple : un multiplicateur de couple avec le rapport 5:1, si l'application du couple d'entrée est de 100 Nm, et défini par la clé dynamométrique, le couple de sortie sera de 500 Nm.

Il faut s'assurer obligatoirement que toutes les pièces impliquées dans le serrage sont correctement alignées.

Il faut également éviter d'utiliser des **rallonges** car elles se tordraient, produisant ainsi un effet ressort qui modifierait les valeurs de couple appliquées.

Il faut toujours vérifier que le **bras de réaction** du multiplicateur de couple a été fixé ou repose sur une structure solide, capable de résister à la force de réaction. En règle générale, on utilise des murs suffisamment rigides ou des points d'appuis à proximité. Le bras de réaction tourne toujours dans le sens **opposé** au sens de serrage.



Fonctionne en douceur et sans interruption.

La tension de serrage doit être relâchée en tournant le multiplicateur de couple dans l'autre sens, avant de le désengager. Si le multiplicateur de couple est équipé d'un système anti-enroulement, la tension de serrage doit être relâchée par le levier d'inversion.

Les instructions ci-dessus s'appliquent également aux opérations de **desserrage**.

560/C3

Multiplicateur de couple pour serrages à droite et gauche en coffret plastique rapport 3,8:1 avec système à cliquet anti-retour

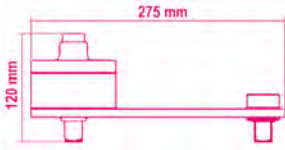

Nm	kgfm	lbf.ft	□	■	kg
1500	150	1110	1/2"	3/4"	3,9

CHF		Icon	Part No.
560/C3	1,128.00	1	005600030

400x260x110 mm

560/C3PLUS

Multiplicateur de couple pour serrages à droite et gauche en coffret plastique rapport 3,8:1 avec système à cliquet anti-retour

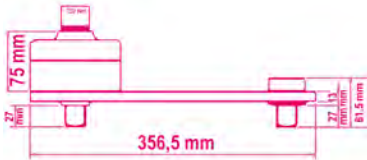

Nm	kgfm	lbf.ft	□	■	kg
2700	270	1991	3/4"	1"	7,5

CHF		Icon	Part No.
560/C3PLUS	1,315.00	1	005600038

470x240x160 mm

560/C2

Multiplicateur de couple et accessoires pour serrages à droite et à gauche rapport 5:1 en coffre plastique pour un usage intensif

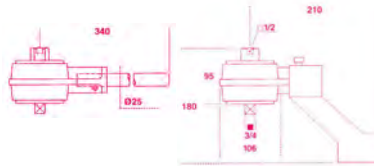

Nm	Kgfm	lbf.ft	□	■	kg
1300	130	960	1/2"	3/4"	3,8

CHF		Icon	Part No.
560/C2	2,295.00	1	005600020
560/2	1,705.00	1	005600002
560/18	54.00	1	005600018
560/19	114.00	1	005600019
560/22	396.00	1	005600022

310x275x120 mm

560/C4+

Multiplicateur de couple et accessoires pour serrages à droite et à gauche rapport 5:1 avec bras de réaction pour un usage intensif

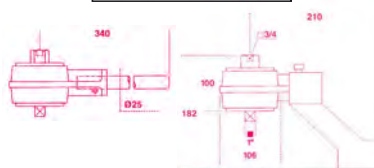

Nm	Kgfm	lbf.ft	□	■	kg
2700	270	2000	3/4"	1"	5

CHF		Icon	Part No.
560/C4PLUS	2,250.00	1	005600042
560/4	1,780.00	1	005600004
560/18	54.00	1	005600018
560/22	396.00	1	005600022

310x275x120 mm

560/C6

Multiplicateur de couple, pour serrage droite/gauche en coffret plastique Rapport 6,5:1



Nm	kgfm	lbf.ft	□	■	kg
1500	150	1106	1/2"	3/4"	6

CHF		Icon	Part No.
560/C6	1,174.00	1	005600160

400x260x110 mm

560/C12

Multiplicateur de couple, pour serrage droite/gauche en coffret plastique Rapport 12:1



Nm	kgfm	lbf.ft	□	■	kg
2500	250	1844	1/2"	1"	7

CHF		Icon	Part No.
560/C12	1,685.00	1	005600210

400x260x110 mm

561/1

Multiplicateur de couple, pour serrages à droite et gauche rapport 5:1 avec deux jambes de force

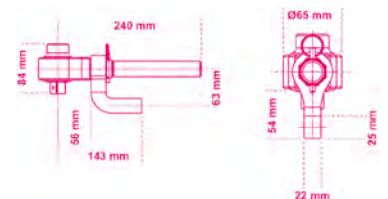

Nm	kgfm	lbf.ft	□	■	kg
1000	100	740	1/2"	3/4"	2,7

CHF		Icon	Part No.
561/1	1,645.00	1	005610010

270x210x70 mm

562-1/VA - 562-2/VA

multiplicateurs de couple pour le serrage à droite et à gauche rapport 5,2:1 en coffret 562VV-A



Nm	Kgfm	lbf.ft	□	■	D	A	L min	L max	⚖
1700	170	1250	3/4	1"	108	95	85	220	8,8

562-1/VA CHF 3,650.00 1 005620601

Nm	Kgfm	lbf.ft	□	■	D	A	L min	L max	⚖
3400	340	2500	3/4	1"	119	115	85	265	10,5

562-2/VA CHF 4,410.00 1 005620602

564-3R/V - 564-4R/V

Multiplicateurs de couple pour les serrages à droite et à gauche rapport 25:1 avec système anti-remorçant, en coffret



Nm	Kgfm	lbf.ft	□	■	D	A	L	⚖
4000	400	3000	1/2	1"	92	185	205	7,6

564-3R/V CHF 7,110.00 1 005640613

☞ 390x310x145 mm

Nm	Kgfm	lbf.ft	□	■	D	A	L	⚖
7000	700	5000	1/2	1 1/2"	120	200	210	13,2

564-4R/V CHF 8,390.00 1 005640614

☞ 500x435x170 mm

565-1R/VA - 565-2R/VA - 565-3R/VA

multiplicateurs de couple pour le serrage à droite et à gauche rapport 27:1 avec système anti-remorçant, en coffret 562VV-A



Nm	Kgfm	lbf.ft	□	■	D	A	L min	L max	⚖
1700	170	1250	1/2	1"	108	125	80	215	11,2

565-1R/VA CHF 5,900.00 1 005650611

Nm	Kgfm	lbf.ft	□	■	D	A	L min	L max	⚖
3400	340	2500	1/2	1"	119	145	85	265	13,6

565-2R/VA CHF 7,700.00 1 005650612

Nm	Kgfm	lbf.ft	□	■	D	A	L min	L max	⚖
3400	340	2500	1/2	1 1/2"	119	145	85	265	14,2

565-3R/VA CHF 8,130.00 1 005650613

565-4R/VB

multiplicateur de couple pour le serrage à droite et à gauche rapport 27:1 avec système anti-remorçant, en coffret 565VV-B

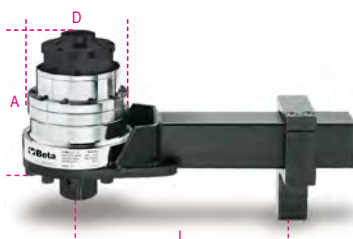

Nm	Kgfm	lbf.ft	□	■	D	A	L min	L max	⚖
6000	600	4500	1/2	1 1/2"	144	180	125	335	22,4

565-4R/VB CHF 9,190.00 1 005650614

565-5R/VB

multiplicateur de couple pour le serrage à droite et à gauche rapport 27:1 avec système anti-remorçant, en coffret 565VV-B



Nm	Kgfm	lbf.ft	□	■	D	A	L min	L max	⚖
9500	950	7000	3/4	1 1/2"	184	180	155	355	30,4

565-5R/VB CHF 15,640.00 1 005650615

567-4R/VB

multiplicateur de couple pour le serrage à droite et à gauche rapport 135:1 avec système anti-remorçant, en coffret 565VV-B

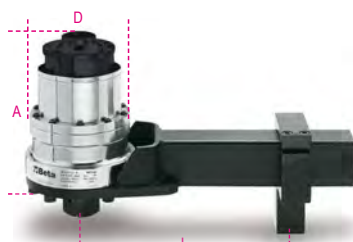

Nm	Kgfm	lbf.ft	□	■	D	A	L min	L max	⚖
6000	600	4500	1/2	1 1/2"	144	210	125	335	24,4

567-4R/VB CHF 10,210.00 1 005670614

567-5R/VB

multiplicateur de couple pour le serrage à droite et à gauche rapport 135:1 avec système anti-remorçant, en coffret 565VV-B

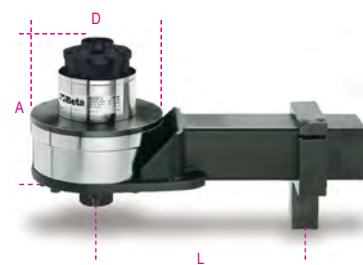

Nm	Kgfm	lbf.ft	□	■	D	A	L min	L max	⚖
9500	950	7000	1/2	1 1/2"	184	210	155	350	32,4

567-5R/VB CHF 17,520.00 1 005670615

562VV-A

Valise pour multiplicateurs, en polypropylène à haute résistance, avec éponge

Mesures intérieures 380x270x180 mm



562VV-A CHF 312.00 1 005620501

562/1-562/2-564/3R
564/4R-565/1R-565/2R
565/3R

☞ 410x340x205 mm - ⚖ 3,5 kg

565VV-B

Valise pour multiplicateurs, en polypropylène à haute résistance, avec éponge

Mesures intérieures 480x370x205 mm



565VV-B CHF 422.00 1 005650502

565/4R-565/5R
567/4R-567/5R

☞ 520x435x230 mm - ⚖ 5,4 kg



Les clés dynamométriques doivent toujours être tenues au milieu de la poignée, afin de ne pas modifier le rapport de levier. Elles doivent être utilisées en douceur et sans interruption, en évitant les à-coups.



Le couple de réglage doit être remis à zéro après utilisation, pour ne pas altérer la précision du serrage dans le temps. Cette opération n'est pas nécessaire avec les clés Zero-Reset.



Beta propose une large gamme de clés, avec **quatre types de fonctionnement différents**.

MODÈLES À LECTURE DIRECTE

Le couple de serrage appliqué est transmis directement à l'index de lecture par compression d'un ressort hélicoïdal. Le couple appliqué peut être lu en temps réel grâce à un pointeur. Un deuxième pointeur peut être positionné sur la valeur de couple cible. Lorsque la valeur de couple cible est atteinte, le deuxième pointeur sera accroché par le pointeur principal et enregistrera la valeur de crête. Les clés dynamométriques à lecture directe assurent une précision et une durabilité remarquables dans le temps.

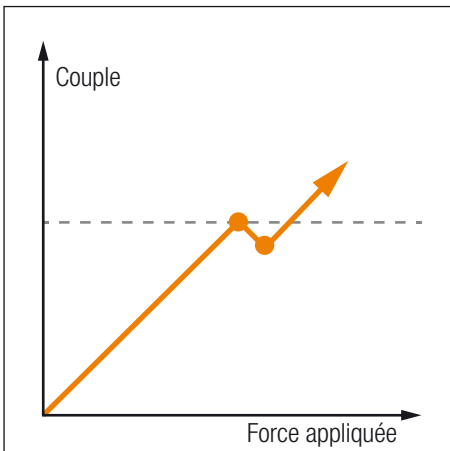

MODÈLES À CLIC

Les clés dynamométriques à clic sont les modèles les plus utilisés, car elles sont faciles d'utilisation. Elles permettent une présélection rapide du couple par charge de ressort. Lorsque la valeur de couple requise est atteinte, un desserrage soudain se produit et la clé n'applique plus aucune force de serrage pendant environ 3-5°. Si l'opérateur n'interrompt pas le mouvement, le couple continuera d'augmenter, dépassant ainsi les valeurs requises.

MODÈLES A DECLENCHEMENT

Les clés dynamométriques à déclenchement fonctionnent comme les modèles à clic, mais lorsque la valeur de couple requise est atteinte, un relâchement soudain du bras de levier se produit (environ 20°). Par conséquent, il est plus facile pour l'opérateur d'arrêter d'appliquer une force. Ils sont normalement utilisés pour des valeurs de couple élevées avec des bras de levier extrêmement longs.

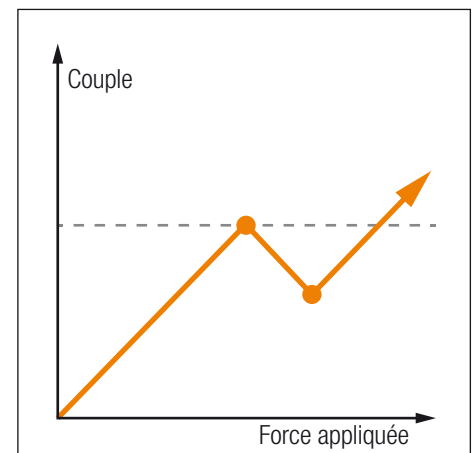
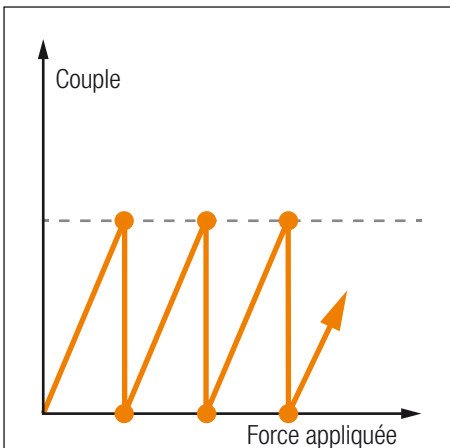

MODÈLES GLISSANTS

Lorsque la valeur de couple pré-réglée est atteinte, le mécanisme de glissement arrête l'application du couple, provoquant ainsi le ralenti de l'outil. Cela empêchera un serrage avec des valeurs de couple élevées par rapport à celles requises. Continuer à appliquer la force entraînera la répétition du même cycle. Elles sont idéales pour les opérations de série avec de faibles valeurs de couple (industries électroniques et micromécaniques), permettant d'éviter de casser des pièces délicates ou de petite taille.

CHAMPS D'UTILISATION CLÉS DYNAMOMÉTRIQUES

1 Nm = 0,10197 Kgfm = 0,7375 lbf.ft

		Nm																					
		0	10	20	30	40	50	60	70	80	90	100	200	300	400	500	600	700	800	900	1000	1500	2000
1/4"	590		0,8	4																			
	590/1		2,5	12																			
	603/5		1	5																			
	603/10		2	10																			
	605E/5		1	5																			
	605E/10		2	10																			
	666/2			5	25																		
	666 LBF.FT/2			4 LBF.FT	18 LBF.FT																		
3/8"	592/3			5	25																		
	592/4			8	40																		
	599DGT/6				12	60																	
	665/6				10	60																	
	665/10					20	100																
	665LB/6					7 LBF.FT	45 LBF.FT																
	665LB/10						15 LBF.FT	75 LBF.FT															
	666/2X			5	25																		
	666/5				10	50																	
	666/10					20	100																
	666 LBF.FT/2X					4 LBF.FT	18 LBF.FT																
	666 LBF.FT/5						7 LBF.FT	37 LBF.FT															
	666 LBF.FT/10						15 LBF.FT	75 LBF.FT															
	668RGC/6				12	60																	
	668RGC/10					20	100																
	1/2"	594/8				16	80																
594/21						40	200																
599DGT/10X						20	100																
599DGT/20							40	200															
599DGT/30								68	340														
599DGT-AN/10						20	100																
599DGT-AN/20							40	200															
606MQ/50				5	50																		
610/5									90	130													
610L/5										90	130												
610L/5L											120	200											
665/10X						20	100																
665/20							40	200															
665/30								60	330														
665LB/10X							15 LBF.FT	75 LBF.FT															
665LB/20								30 LBF.FT	150 LBF.FT														
665LB/30									45 LBF.FT	240 LBF.FT													
666/10X						20	100																
666/20							40	200															
666/30								60	300														
666 LBF.FT/10X							15 LBF.FT	75 LBF.FT															
666 LBF.FT/20								30 LBF.FT	150 LBF.FT														
666 LBF.FT/30									50 LBF.FT	230 LBF.FT													
667/20							40	200															
667/30								60	300														
668RGC/10X						20	100																
668RGC/20							40	200															

Kgfm 0 1 2 3 4 5 6 7 8 9 10 20 30 40 50 60 70 80 90 100 150 200

lbf.ft 0 10 20 30 40 50 60 70 100 200 300 400 500 600 700 1100 1500

Beta

581

Tournevis dynamométrique à débrayage mono-couple
Utilisable pour serrage droite
Précision de serrage : ±6%
(S'utilise avec les articles 588 - 682)



UNI EN ISO 6789

Nm	gfm	○	g
1,2÷6	120÷600	1/4"	275

581 CHF 368.00 1 005810001

583

Tournevis dynamométrique à débrayage
Utilisable pour serrage droite
Précision de serrage : ±6%



UNI EN ISO 6789

Nm	gfm	○	g	g
0,3÷1,5	30÷150	1/4"	240	0,05

583/1,5 CHF 414.00 1 005830015

Nm	gfm	○	g	g
0,6÷3	60÷300	1/4"	240	0,1

583/3 CHF 414.00 1 005830030

Nm	gfm	○	g	g
1,2÷6	120÷600	1/4"	350	0,2

583/6 CHF 414.00 1 005830060

583/C31

1 tournevis dynamométrique, 8 douilles 6 pans, 20 embouts pour visseuses et 2 accessoires

1/4



583/C31 CHF 578.00 1 005830931

- 583/6 1.2 - 6 Nm
- 900 4-5-5,5-6-7-8-9-10 mm
- 860LP 0,6x4,5 - 1x5,5 - 1,2x6,5 mm
- ⊕ 860PH PH1 - PH2 (x2) - PH3
- 860PE 2-2,5-3-4-5 mm
- ⊗ 860TX T9-T10-T15-T20-T25-T27-T30-T40
- 882P/80 80 mm
- 892/0 ● 1/4 ■ 1/4

270x120x45 mm - 1,2 kg

590-592

Clé dynamométrique à lecture directe
Utilisable pour serrage droite ou gauche
Précision de serrage : ±4%

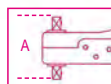

UNI EN ISO 6789

Nm	Kgfm	lbf.in	■	A mm	L mm	g	g
0,3÷4	0,03÷0,4	3÷35	1/4	60	253	0,52	0,1

590 CHF 977.00 1 005900001

Nm	Kgfm	lbf.in	■	A mm	L mm	g	g
0,5÷13,5	0,05÷1,35	4÷120	1/4	60	253	0,52	0,5

590/1 CHF 977.00 1 005900003

Nm	Kgfm	lbf.in	■	A mm	L mm	g	g
1÷27	0,1÷2,7	10÷240	3/8	70	253	0,52	1,0

592/3 CHF 971.00 1 005920005

Nm	Kgfm	lbf.in	■	A mm	L mm	g	g
3÷40	0,3÷4	20÷360	3/8	70	253	0,52	1,0

592/4 CHF 971.00 1 005920007

594

Clé dynamométrique à lecture directe
Utilisable pour serrage droite ou gauche
Précision de serrage : ±4%

1/2"

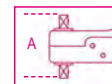

UNI EN ISO 6789

Nm	Kgfm	lbf.ft	■	A mm	L mm	g	g
6÷80	0,6÷8	5÷60	1/2	85	455	1,35	2,0

594/8 CHF 1,470.00 1 005940011

Nm	Kgfm	lbf.ft	■	A mm	L mm	g	g
20÷215	2÷21,5	15÷160	1/2	85	530	1,40	5,0

594/21 CHF 1,470.00 1 005940015

Service d'étalonnage dynamométrique à la fin du catalogue

596-598

Clé dynamométrique à lecture directe
Utilisable pour serrage droite ou gauche
Précision de serrage : ±4%

pourvue d'indicateurs lumineux et sonores qui se déclenchent lorsque le couple préfixé est atteint

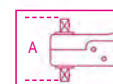

UNI EN ISO 6789

Nm	Kgfm	lbf.ft	■	A mm	L mm	g	g
80÷400	8÷40	60÷300	3/4	111	710	3,2	10

596/40SL CHF 2,430.00 1 005960010

Nm	Kgfm	lbf.ft	■	A mm	L mm	g	g
160÷800	16÷80	120÷600	3/4"	115	1025	4,85	20

596/80SL CHF 3,060.00 1 005960020

Nm	Kgfm	lbf.ft	■	A mm	L mm	g	g
200÷2000	20÷200	150÷1500	1"	135	1930	16,70	50

598/200SL CHF 6,370.00 1 005980022

Beta Quality Tools

Beta

599DGT

Clé dynamométrique électronique à cliquet réversible, pour serrages à droite et à gauche
précision de serrage +/- 2% à droite, +/- 3% à gauche

- Double indication d'approche et d'arrêt : crête et suivi
- L'obtention du couple programmé est indiquée par des témoins lumineux et par un signal sonore intermittent
- Alimentation : 2 piles - 1,5V fournies



UNI EN ISO 6789

Nm	Kgfm	lbf.ft	■	D	A	L	█	⚖
20÷60	1,2÷6	8÷44	3/8	30	33	413	0,9	0,1

599DGT/6	CHF 517.00	1	005990003
-----------------	-------------------	---	-----------

Nm	Kgfm	lbf.ft	■	D	A	L	█	⚖
20÷100	2÷10	15÷80	1/2	30	37	413	0,9	0,1

599DGT/10X	CHF 532.00	1	005990010
-------------------	-------------------	---	-----------

Nm	Kgfm	lbf.ft	■	D	A	L	█	⚖
40÷200	4÷20	30÷150	1/2	40	43	520	2	0,1

599DGT/20	CHF 553.00	1	005990020
------------------	-------------------	---	-----------

Nm	Kgfm	lbf.ft	■	D	A	L	█	⚖
68÷340	6,8÷34	58÷280	1/2	40	43	640	2,35	0,1

599DGT/30	CHF 596.00	1	005990030
------------------	-------------------	---	-----------

599DGT-AN

Clé dynamométrique électronique à lecture de couple et d'angle avec cliquet réversible, pour serrages à droite (précision +/- 2%) et à gauche (précision +/- 3%)

- Typologies de serrage : couple, renvoi d'angle, couple + renvoi d'angle
- Stratégie de serrage : couple + renvoi d'angle
- Double indication d'approche et d'arrêt : crête et suivi
- L'obtention du couple/angle programmé est indiquée par des témoins lumineux et par un signal sonore intermittent
- Mémorisation des données de serrage (jusqu'à 250 valeurs)
- 9 valeurs de couple/renvoi d'angle réglables à l'avance
- Possibilité de régler les limites de tolérance en fonction des exigences ; lorsque ces limites sont dépassées, la clé avertit l'utilisateur
- Blocage de sécurité des touches
- Possibilité d'associer la clé à 16 utilisateurs par le biais de l'ID utilisateur
- Traçabilité des données de serrage. Le logiciel permet de mémoriser la date et l'heure, le numéro de série de l'outil, la valeur de serrage programmé, la valeur atteinte, et de les associer à l'ID utilisateur
- Poignée bi-matériaux antidérapante
- Comprend : 2 batteries AA - 1,5V, câble USB et logiciel



UNI EN 26789
ISO 6789

Nm	Kgfm	lbf.ft	■	D	A	L	█	⚖
20÷100	2÷10	15÷80	1/2	30	33	413	0,9	0,1

599DGT-AN/10	CHF 971.00	1	005990610
---------------------	-------------------	---	-----------

Nm	Kgfm	lbf.ft	■	D	A	L	█	⚖
40÷200	4÷20	30÷150	1/2	40	43	520	1,3	0,1

599DGT-AN/20	CHF 1,024.00	1	005990620
---------------------	---------------------	---	-----------

Service d'étalonnage dynamométrie à la fin du catalogue

Beta

600

Clé de serrage angulaire

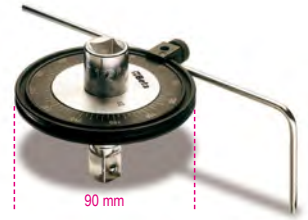

	□	■	CHF	⚖	📄
600/1	1/2	1/2	207.00	1	006000001
600/2	3/4	3/4	234.50	1	006000002

601C

Rapporteur numérique pour serrages angulaires

L'obtention de l'angle programmé est signalé par des témoins lumineux et un signal acoustique intermittent



601C	CHF 278.00	1	006010100
-------------	-------------------	---	-----------

85x80x87 mm - 70 g

601CA

Rapporteur numérique pour serrages couple et angulaires

L'obtention du couple ou de l'angle préfixés est indiquée par des signaux lumineux et par un son intermittent



□	■	Nm	⚖	CHF	⚖	📄
1/2"	1/2"	40÷200	0,1	492.00	1	006010120

120x90x120 mm - 240 g

603

Clé dynamométrique à débrayage
Précision de serrage : $\pm 6\%$



UNI EN ISO 6789

Nm	Kgfm	lbf.in	■	A	L	g	mm
1÷5	0,1÷0,5	10÷45	1/4	35	195	235	0,05

603/5 CHF 838.00 1 006030005

Nm	Kgfm	lbf.in	■	A	L	g	mm
2÷10	0,2÷1,0	18÷90	1/4	35	195	235	0,1

603/10 CHF 858.00 1 006030010

604B

Clé dynamométrique à cassure
Utilisable pour serrage droite ou gauche
Précision de serrage : $\pm 6\%$



UNI EN ISO 6789

Nm	kgfm	lbf.in	Ø	L	g	mm
1÷5	0,1÷0,5	10÷45	8	220	290	0,025

604B/5 CHF 544.00 1 006040015

Nm	Kgfm	lbf.in	Ø	L	g	mm
2÷10	0,2÷1,0	18÷90	8	220	300	0,05

604B/10 CHF 544.00 1 006040020

605E

Clé dynamométrique à déclenchement
avec cliquet réversible
Utilisable pour serrage droit ou gauche
Précision de serrage : $\pm 6\%$



UNI EN ISO 6789

Nm	Kgfm	lbf.in	■	A	L	g	mm
1÷5	0,1÷0,5	10÷45	1/4	20	190	180	0,05

605E/5 CHF 280.00 1 006050105

Nm	Kgfm	lbf.in	■	A	L	g	mm
2÷10	0,2÷1,0	18÷90	1/4	20	190	180	0,1

605E/10 CHF 292.00 1 006050110

605DGT/2

Clé dynamométrique électronique
avec cliquet réversible
pour serrage à droite ou à gauche
précision du couple $\pm 3\%$ (à droite) et $\pm 4\%$ (à gauche)

- Mode de mesure double : mode temps réel et mode crête
- Indicateurs lumineux et sonore informant l'utilisateur que le couple prédéfini est atteint.
- Alimentation : 1 pile AAA 1,5 V (fournie)



Nm	Kgcm	lbf.ft	■	D	A	L	g	mm
4÷20	10÷204	0,75÷14,75	1/4	20	20	210	175	0,01

605DGT/2 CHF 335.00 1 006050302

610/5

Clé dynamométrique à déclenchement
avec cliquet réversible
Utilisable pour serrage droit
avec 5 valeurs prééglées
Précision de serrage : $\pm 4\%$

Couples sélectionnables
90 - 100 - 110 - 120 - 130 Nm



UNI EN ISO 6789

Nm	■	D	A	L	g	mm
90÷130	1/2	42	39	490	1330	10

610/5 CHF 233.00 1 006100025

610L/5

Clé dynamométrique à déclenchement
avec levier en L
Utilisable pour serrage droit
avec 5 valeurs prééglées
Précision de serrage : $\pm 4\%$

Couples sélectionnables
90 - 100 - 110 - 120 - 130 Nm

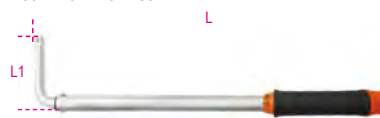

UNI EN ISO 6789

Nm	■	L	L1	g	mm
90÷130	1/2	470	80	1350	10

610L/5 CHF 207.00 1 006100125

610L/5L

Clé dynamométrique à déclenchement
avec levier en L

Utilisable pour serrage à droite
avec 5 valeurs prééglées
précision de serrage : $\pm 4\%$

Couples sélectionnables :
120 - 140 - 160 - 180 - 200 Nm



UNI EN ISO 6789

Nm	■	L	L1	g	mm
120÷200	1/2	470	80	1400	20

610L/5L CHF 213.00 1 006100150

611

Cliquet réversible
pour clés dynamométriques 604B/5 et
604B/10
avec entraînement 8 mm



611 CHF 196.00 1 006110001

Service d'étalonnage
dynamométrie
à la fin du catalogue

612 ÷ 614

Cliquet réversible



Les articles 612 et 612X ne doivent pas être
utilisés avec des couples de serrage
supérieurs à 100 Nm

	■	L	LA	CHF	■	mm
612	3/8	66	32	88.00	2	006120000
612X	1/2	66	32	93.00	2	006120010
614	1/2	71	32	101.50	2	006140000
614X	3/4	71	32	111.00	2	006140004

614/50

Cliquet réversible à glissière



mm	mm	L mm	LA mm	CHF		
614/50	1/2	71	32	93.00	2	006140002

Voir le tableau après la ref. 928/C8 pour les pièces détachées du mécanisme de la tête de la clé dynamométrique

615

Cliquet réversible pour clés dynamométriques avec entraînement rectangulaire



mm	mm	L mm	LA mm	CHF		
9x12	3/8	53	28,8	74.50	1	006150010
9x12	1/2	53	28,8	74.50	1	006150020
14x18	1/2	70	39,8	74.50	1	006150120

616 - 617 - 619

Carrés mâles



mm	mm	L mm	LA mm	CHF		
616	1/4	61	32	69.50	1	006160000
617	3/8	61	32	69.50	1	006170000
619	1/2	63	32	69.50	1	006190000

621

Accessoire porte-embouts pour clés dynamométriques avec entraînement rectangulaire



mm	mm	L mm	LA mm	CHF		
621P 1/4	9x12	1/4	43 28,8	88.50	1	006210000
* 621P 5/16	14x18	5/16	52,5 32,5	135.50	1	006210110

*Attention ! Recalculer la valeur de couple à programmer conformément aux indications du tableau en fin de catalogue des prix.

622

Cliquets réversibles pour clé dynamométrique série 674 avec entraînement rond de Ø 22 mm



mm	mm	L mm	LA mm	CHF		
622 3/4	3/4	110	56	247.50	1	006220019
622 1"	1	110	56	301.00	1	006220024

641

Clé à fourche pour clés dynamométriques 604B/5 et 604B/10 entraînement 8 mm



mm	L mm	CHF		
4	37	105.50	1	006410003
5	37	105.50	1	006410004
5,5	37	105.50	1	006410005
6	37	105.50	1	006410006
7	37	105.50	1	006410007
8	42	105.50	1	006410008
9	42	105.50	1	006410009
10	42	105.50	1	006410010

642

Clé à fourche



mm	L mm	LA mm	A mm	CHF		
8	54	32	22	75.00	1	006420008
10	57	32	26	75.00	1	006420010
12	58	32	30	75.00	1	006420012
13	58	32	30	75.00	1	006420013
14	59	32	32	75.00	1	006420014
15	59	32	35	75.00	1	006420015
16	59	32	38	75.00	1	006420016
17	60	32	39	75.00	1	006420017
18	61	32	42	75.00	1	006420018
19	61	32	43	75.00	1	006420019
20	61	32	50	116.50	1	006420020
21	62	32	53	116.50	1	006420021
22	62	32	53	127.50	1	006420022
23	65	32	53	127.50	1	006420023
24	63	32	53	127.50	1	006420024
25	64	32	53	156.00	1	006420125
26	64	32	59	156.00	1	006420026
27	65	32	59	156.00	1	006420027
28	66	32	64	156.00	1	006420028
30	66	32	66	156.00	1	006420030
32	67	32	66	156.00	1	006420032
* 36	76	42	80	214.00	1	006420036
* 40	77	52	95	214.00	1	006420040
* 41	78	52	95	214.00	1	006420041
* 46	90	52	95	258.00	1	006420046

*Attention ! Recalculer la valeur de couple à programmer conformément aux indications du tableau en fin de catalogue des prix.

643

Clé à fourche pour clés dynamométriques avec entraînement rectangulaire

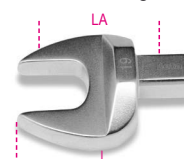

mm	mm	L mm	LA mm	CHF		
7	9x12	37	28,8	65.50	1	006430007
8	9x12	37	28,8	65.50	1	006430008
10	9x12	39	28,8	65.50	1	006430010
12	9x12	39	28,8	65.50	1	006430012
13	9x12	39	28,8	65.50	1	006430013
14	9x12	43	28,8	66.50	1	006430014
15	9x12	43	28,8	66.50	1	006430015
16	9x12	43	28,8	66.50	1	006430016
17	9x12	43	28,8	66.50	1	006430017
* 18	9x12	47	36,3	66.50	1	006430018
* 19	9x12	51	36,3	66.50	1	006430019
* 21	9x12	52	36,3	103.00	1	006430021
* 22	9x12	52	36,3	103.00	1	006430022

*Attention ! Recalculer la valeur de couple à programmer conformément aux indications du tableau en fin de catalogue des prix.

mm	mm	L mm	LA mm	CHF		
13	14x18	60	39,8	69.00	1	006430113
14	14x18	58	39,8	69.00	1	006430114
15	14x18	60	39,8	69.00	1	006430115
16	14x18	60	39,8	69.50	1	006430116
17	14x18	60	39,8	69.50	1	006430117
18	14x18	61	39,8	69.50	1	006430118
19	14x18	61	39,8	69.50	1	006430119
21	14x18	61	39,8	108.50	1	006430121
22	14x18	62	39,8	108.50	1	006430122
24	14x18	64	39,8	108.50	1	006430124
* 27	14x18	68	44,8	122.50	1	006430127
* 30	14x18	77	49,8	123.50	1	006430130
* 32	14x18	77	49,8	123.50	1	006430132
* 34	14x18	80	54,8	196.00	1	006430134
* 36	14x18	83	54,8	196.00	1	006430136
* 38	14x18	83	54,8	196.00	1	006430138
* 41	14x18	91	64,8	196.00	1	006430141

*Attention ! Recalculer la valeur de couple à programmer conformément aux indications du tableau en fin de catalogue des prix.

644

Clés à fourches pour clé dynamométrique série 674 avec entraînement rond de 22 mm



mm	L mm	LA mm	A mm	CHF		
22	91	56	52	127.50	1	006440022
24	91	56	52	127.50	1	006440024
27	94	56	64	156.00	1	006440027
30	94	56	64	156.00	1	006440030
32	97	56	75,5	156.00	1	006440032
34	97	56	75,5	156.00	1	006440034
36	97	56	75,5	214.00	1	006440036
41	103,5	56	94	214.00	1	006440041
46	115,5	56	94	258.00	1	006440046

650A

Clé à molette
pour clés dynamométriques
avec entraînement rectangulaire



A min-max mm	■ mm	L mm	LA mm	CHF	🔧	📄
* 5-27	9X12	93	74,3	120.00	1	006500027
* 5-30	9X12	106	85,3	120.00	1	006500030
* 5-30	14X18	115	89	122.50	1	006500130
* 10-41	14X18	127	100	126.50	1	006500141

650H

Clé à ergot
pour clés dynamométriques
avec entraînement rectangulaire



🔧 mm	■ mm	L mm	LA mm	CHF	🔧	📄
* 28-36	14X18	122	92	64.00	1	006500928
* 40-45	14X18	129	92	64.00	1	006500940
* 50-55	14X18	129	92	64.00	1	006500950
* 58-62	14X18	135	92	67.50	1	006500958
* 68-75	14X18	139	92	73.50	1	006500968
* 80-90	14X18	145	92	73.50	1	006500980

652

Clé polygonale



🔧 mm	L mm	LA mm	CHF	🔧	📄
8	58	32	81.00	1	006520008
10	58	32	81.00	1	006520010
12	58	32	81.00	1	006520012
13	58	32	81.00	1	006520013
14	58	32	81.00	1	006520014
15	62	32	81.00	1	006520015
16	63	32	81.00	1	006520016
17	64	32	81.00	1	006520017
18	65	32	81.00	1	006520018
19	65	32	81.00	1	006520019
21	67	32	122.00	1	006520021
22	68	32	129.00	1	006520022
24	69	32	154.50	1	006520024
26	71	32	173.50	1	006520026
27	71	32	173.50	1	006520027
30	73	32	173.50	1	006520030
32	74	32	173.50	1	006520032

653

Clé polygonale
pour clés dynamométriques
avec entraînement rectangulaire



🔧 mm	■ mm	L mm	LA mm	CHF	🔧	📄
7	9X12	40	28,8	70.00	1	006530007
8	9x12	40	28,8	70.00	1	006530008
10	9x12	43	28,8	70.00	1	006530010
12	9x12	44	28,8	70.00	1	006530012
13	9x12	44	28,8	70.00	1	006530013
14	9x12	45	28,8	70.00	1	006530014
15	9x12	46	28,8	70.00	1	006530015
16	9x12	47	28,8	70.50	1	006530016
17	9x12	47	28,8	70.50	1	006530017
18	9x12	48	28,8	70.50	1	006530018
19	9x12	49	28,8	70.50	1	006530019
21	9X12	51	28,8	73.50	1	006530021
22	9x12	51	28,8	73.50	1	006530022

🔧 mm	■ mm	L mm	LA mm	CHF	🔧	📄
13	14x18	61	39,8	77.50	1	006530113
14	14x18	61	39,8	77.50	1	006530114
15	14x18	62	39,8	77.50	1	006530115
16	14x18	63	39,8	78.00	1	006530116
17	14x18	64	39,8	78.00	1	006530117
18	14x18	64	39,8	78.00	1	006530118
19	14x18	66	39,8	78.00	1	006530119
21	14x18	66	39,8	113.00	1	006530121
22	14x18	67	39,8	113.00	1	006530122
24	14x18	69	39,8	140.50	1	006530124
* 27	14x18	76	44,8	140.50	1	006530127
* 30	14x18	77	44,8	140.50	1	006530130
* 32	14x18	79	44,8	140.50	1	006530132
* 34	14x18	80	44,8	199.50	1	006530134
* 36	14x18	80	44,8	199.50	1	006530136
* 38	14X18	90	49,8	204.00	1	006530138
* 41	14x18	90	49,8	204.00	1	006530141

*Attention ! Recalculer la valeur de couple à programmer conformément aux indications du tableau en fin de catalogue des prix.

654

Clés polygonales pour clé dynamométrique
série 674 avec entraînement rond, Ø 22 mm



🔧 mm	L mm	LA mm	A mm	CHF	🔧	📄
22	98,5	56	38	129.00	1	006540022
24	98,5	56	38	154.50	1	006540024
27	102,8	56	46,5	173.50	1	006540027
30	102,8	56	46,5	173.50	1	006540030
32	106,5	56	55	173.50	1	006540032
34	106,5	56	55	173.50	1	006540034
36	106,5	56	55	225.50	1	006540036
41	115,5	56	72	225.50	1	006540041
46	115,5	56	72	245.00	1	006540046

659/15

Raccord avec attache rectangulaire
femelle 14x18 mm et mâle 9x12 mm



L mm	□ mm	■ mm	LA mm	CHF	🔧	📄
* 56	14x18	9x12	39	102.50	1	006590815



Toujours appliquer la force de serrage
régulièrement et progressivement
afin d'éviter la rupture et de se protéger
contre un possible accident.

659/16

Raccord avec attache rectangulaire
femelle 9x12 mm et mâle 14x18 mm



L mm	□ mm	■ mm	LA mm	CHF	🔧	📄
* 52	9x12	14x18	31	87.00	1	006590816

665

Clé dynamométrique mécanique lecture
digitale avec cliquet réversible, pour serrages
à droite, précision de serrage ± 3 %

- Arrêt automatique après 10 secondes sous le seuil du couple minimum
- L'écran d'affichage reste éclairé avec la valeur de couple programmé
- Lecture du couple avec chiffre décimal
- Alimentation avec 1 pile de 3 V (comprise)

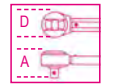

UNI EN ISO 6789

Nm	■	D mm	A mm	L mm	g	🔧
10=60	3/8	30	33	335	655	0,1

CHF		🔧	📄
665/6	310.00	1	006650006

Nm	■	D mm	A mm	L mm	g	🔧
20=100	3/8	30	33	375	725	0,1

CHF		🔧	📄
665/10	312.00	1	006650010

Nm	■	D mm	A mm	L mm	g	🔧
20=100	1/2	30	37	375	725	0,1

CHF		🔧	📄
665/10X	319.00	1	006650011

Nm	■	D mm	A mm	L mm	g	🔧
40=200	1/2	40	43	470	995	0,5

CHF		🔧	📄
665/20	340.00	1	006650020

Nm	■	D mm	A mm	L mm	g	🔧
60=330	1/2	40	43	590	1260	0,5

CHF		🔧	📄
665/30	386.00	1	006650030

665LB

Clé dynamométrique mécanique à écran digital avec cliquet réversible, pour serrages à droite, précision de serrage $\pm 3\%$

- Unité de mesure : pied-livre-force
- Réglage et lecture simple du couple par le biais de la valeur affichée sur l'écran
- L'écran d'affichage reste éclairé avec la valeur de couple programmée
- Lecture du couple avec nombre décimal
- Extinction automatique après 30 secondes avec réglage du couple inférieur au seuil minimum
- Alimentation avec 1 batterie de 3 V (incluse)



UNI EN ISO 6789

lbf.ft	mm	D	A	L	g	mm
7÷45	3/8	30	33	335	655	0,1

665LB/6 CHF 310.00 1 006650106

lbf.ft	mm	D	A	L	g	mm
15÷75	3/8	30	33	375	725	0,1

665LB/10 CHF 312.00 1 006650110

lbf.ft	mm	D	A	L	g	mm
15÷75	1/2	30	37	375	725	0,1

665LB/10X CHF 319.00 1 006650111

lbf.ft	mm	D	A	L	g	mm
30÷150	1/2	40	43	470	995	0,5

665LB/20 CHF 340.00 1 006650120

lbf.ft	mm	D	A	L	g	mm
45÷240	1/2	40	43	590	1260	0,5

665LB/30 CHF 386.00 1 006650130

665SW

Boîtier d'étalonnage

- Ce boîtier permet l'étalonnage des clés dynamométriques 665 avec l'aide des contrôleurs de couples 680 et 682, sans avoir à démonter la clé.
- L'étalonnage advient sur plusieurs points pour compenser le comportement non linéaire du ressort.
- Doté de prise Micro USB pour permettre d'éventuelles mises à jour du logiciel



665SW CHF 31.00 1 006650100

666-667 ZERO-RESET

LA NOUVELLE CLÉ DYNAMOMÉTRIQUE NE NECESSITANT PAS DE REMISE A ZERO.

Même si la clé n'est pas remise à zéro, son nombre d'opérations, sa durée de vie et la précision du serrage souhaité par la norme de référence est garantie. Pour arriver à ce résultat le département Recherche et Développement de Beta Utensili a effectué de nombreux tests dans ses laboratoires internes mais également auprès de centaines d'utilisateurs finaux. Ce résultat a été obtenu grâce :

- à l'utilisation d'alliages et de matériaux ultra-performants.
- aux traitements thermiques spéciaux des composants internes.

100% MADE IN ITALY

La clé dynamométrique Zero Reset a été entièrement conçue développée et fabriquée dans les usines Beta Utensili en Italie avec des composants 100 % Made in Italy.

Grâce aux nouveaux composants de la nouvelle clé dynamométrique BETA, l'opération de remise à zéro en fin d'utilisation n'est plus obligatoire.

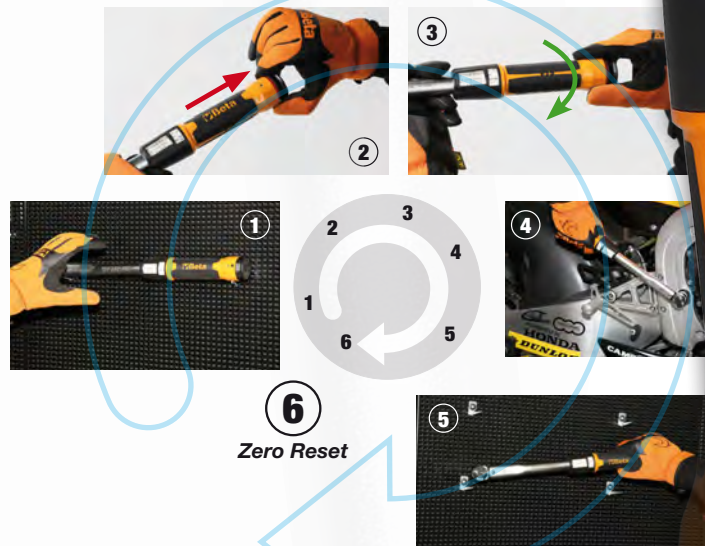

666

Clé dynamométrique à déclenchement ZERO-RESET

avec cliquet réversible pour serrage à droite
Précision de serrage : $\pm 3\%$
• Sans besoin d'être déchargée



UNI EN ISO 6789

Nm	D	A	L	g
5÷25	1/4	26	25	273

CHF 341.00 1 006660702

Nm	D	A	L	g
5÷25	3/8	26	29	273

CHF 341.00 1 006660703

Nm	D	A	L	g
10÷50	3/8	30	33	342

CHF 310.00 1 006660705

Nm	D	A	L	g
20÷100	3/8	30	33	385

CHF 312.00 1 006660710

Nm	D	A	L	g
20÷100	1/2	30	37	385

CHF 319.00 1 006660711

Nm	D	A	L	g
40÷200	1/2	42	43	471

CHF 340.00 1 006660720

Nm	D	A	L	g
60÷300	1/2	42	43	600

CHF 386.00 1 006660730

666 LBF.FT

Clé dynamométrique à déclenchement ZERO-RESET

avec cliquet réversible pour serrage à droite
Précision de serrage : $\pm 3\%$

- Sans besoin d'être déchargée
- Échelle en livres-force pieds



UNI EN ISO 6789

lbf.ft	D	A	L	g
4÷18	1/4	26	25	273

CHF 322.00 1 006660762

lbf.ft	D	A	L	g
4÷18	3/8	26	29	273

666 LBF.FT/2X CHF 322.00 1 006660763

lbf.ft	D	A	L	g
7÷37	3/8	30	33	342

666 LBF.FT/5 CHF 293.00 1 006660765

lbf.ft	D	A	L	g
15÷75	3/8	30	33	385

666 LBF.FT/10 CHF 295.00 1 006660780

lbf.ft	D	A	L	g
15÷75	1/2	30	37	385

666 LBF.FT/10X CHF 301.00 1 006660781

lbf.ft	D	A	L	g
30÷150	1/2	42	43	471

666 LBF.FT/20 CHF 321.00 1 006660782

lbf.ft	D	A	L	g
50÷230	1/2	42	43	600

666 LBF.FT/30 CHF 365.00 1 006660783

667

Clés dynamométriques à déclenchement ZERO-RESET

avec cliquets traversants, pour serrage à droite ou à gauche, précision du couple : $\pm 3\%$

- Ne nécessite pas la remise à zéro du couple de la clé après utilisation



UNI EN ISO 6789

Nm	D	A	L	g
40÷200	1/2	42	42	471

667/20 CHF 334.00 1 006670720

Nm	D	A	L	g
60÷300	1/2	42	42	600

667/30 CHF 372.00 1 006670730

Nm	D	A	L	g
80÷400	3/4	59	53	710

667/40 CHF 894.00 1 006670740

Voir le tableau après la ref. 928/C8 pour les pièces détachées du mécanisme de la tête de la clé dynamométrique

668N

Clé dynamométrique à attachement à déclenchement utilisable pour serrage droite ou gauche
Précision de serrage : $\pm 3\%$



UNI EN ISO 6789

Nm	Kgfm	lbf.ft	Ø	L	LB	LS	g
5÷25	0,5÷2,5	4÷18	16	220	148	32	300

668N/2 CHF 312.00 1 006680002

Nm	Kgfm	lbf.ft	Ø	L	LB	LS	g
10÷50	1÷5	7÷37	16	307	229	32	590

668N/5 CHF 306.00 1 006680005

Nm	Kgfm	lbf.ft	Ø	L	LB	LS	g
20÷100	2÷10	15÷75	16	376	269	32	670

668N/10 CHF 312.00 1 006680010

Nm	Kgfm	lbf.ft	Ø	L	LB	LS	g
40÷200	4÷20	30÷150	16	450	352,6	32	795

668N/20 CHF 340.00 1 006680020

Nm	Kgfm	lbf.ft	Ø	L	LB	LS	g
60÷300	6÷30	50÷220	16	588	475,9	32	1230

668N/30 CHF 386.00 1 006680030



668RG

Clé dynamométrique à attachement et déclenchement, non graduée, pour serrage à droite et à gauche
Précision du couple : $\pm 4\%$
(doit être utilisée avec les articles 680 - 682)



UNI EN ISO 6789

Nm	Kgfm	lbf.ft	Ø	L	W
8÷60	0,8÷6	6÷44	mm	mm	g
			16	288	550

668RG/6	CHF	252.00	1	006680206
----------------	------------	---------------	---	-----------

Nm	Kgfm	lbf.ft	Ø	L	W
20÷100	2÷10	15÷80	mm	mm	g
			16	315	600

668RG/10	CHF	259.00	1	006680210
-----------------	------------	---------------	---	-----------

Nm	Kgfm	lbf.ft	Ø	L	W
40÷200	4÷20	30÷150	mm	mm	g
			16	405	780

668RG/20	CHF	276.00	1	006680220
-----------------	------------	---------------	---	-----------

Nm	Kgfm	lbf.ft	Ø	L	W
60÷300	6÷30	50÷220	mm	mm	g
			16	645	1130

668RG/30	CHF	308.00	1	006680230
-----------------	------------	---------------	---	-----------

668RGC

Clé dynamométrique à déclenchement non graduée avec cliquet réversible permettant un serrage à droite, Tolérance du couple : $\pm 4\%$
(Doit être utilisé avec les références 680 et 682)



UNI EN ISO 6789

Nm	Kgfm	lbf.in	D	A	L	W
12÷60	1,2÷6	5÷45	mm	mm	mm	g
			3/8	30	33	295

668RGC/6	CHF	229.50	1	006680406
-----------------	------------	---------------	---	-----------

Nm	Kgfm	lbf.in	D	A	L	W
20÷100	2÷10	15÷75	mm	mm	mm	g
			3/8	30	33	335

668RGC/10	CHF	240.00	1	006680410
------------------	------------	---------------	---	-----------

Nm	Kgfm	lbf.in	D	A	L	W
20÷100	2÷10	15÷75	mm	mm	mm	g
			1/2	40	43	342

668RGC/10X	CHF	240.00	1	006680411
-------------------	------------	---------------	---	-----------

Nm	Kgfm	lbf.in	D	A	L	W
40÷200	4÷20	30÷150	mm	mm	mm	g
			1/2	40	43	425

668RGC/20	CHF	245.00	1	006680420
------------------	------------	---------------	---	-----------

669N

Clé dynamométrique à déclenchement avec entraînement femelle rectangulaire, permettant un serrage à droite et à gauche, tolérance du couple de serrage : $\pm 3\%$



UNI EN ISO 6789

Nm	Kgfm	lbf.ft	□	L	LB	LS	W
5÷25	0,5÷2,5	4÷18	mm	mm	mm	mm	g
			9x12	215	140	28,8	300

669N/2	CHF	445.00	1	006690202
---------------	------------	---------------	---	-----------

Nm	Kgfm	lbf.ft	□	L	LB	LS	W
10÷50	1÷5	7÷37	mm	mm	mm	mm	g
			9x12	307	226,8	28,8	590

669N/5	CHF	342.00	1	006690205
---------------	------------	---------------	---	-----------

Nm	Kgfm	lbf.ft	□	L	LB	LS	W
20÷100	2÷10	15÷75	mm	mm	mm	mm	g
			9x12	376	266,8	28,8	670

669N/10	CHF	368.00	1	006690210
----------------	------------	---------------	---	-----------

Nm	Kgfm	lbf.ft	□	L	LB	LS	W
40÷200	4÷20	30÷150	mm	mm	mm	mm	g
			9x12	450	345,6	28,8	795

669N/20	CHF	441.00	1	006690220
----------------	------------	---------------	---	-----------

Nm	Kgfm	lbf.ft	□	L	LB	LS	W
40÷200	4÷20	30÷150	mm	mm	mm	mm	g
			14x18	450	351	39,8	795

669N/20X	CHF	466.00	1	006690221
-----------------	------------	---------------	---	-----------

Nm	Kgfm	lbf.ft	□	L	LB	LS	W
60÷300	6÷30	50÷220	mm	mm	mm	mm	g
			14x18	588	468,5	39,8	1230

669N/30	CHF	492.00	1	006690230
----------------	------------	---------------	---	-----------

Nm	Kgfm	lbf.ft	□	L	LB	LS	W
80÷400	8÷40	60÷295	mm	mm	mm	mm	g
			14x18	664	563	39,8	2100

669N/40	CHF	567.00	1	006690240
----------------	------------	---------------	---	-----------



671B/C5

Clé dynamométrique 604B/5 et accessoires



671B/C5	CHF	1,245.00	1	006710001
----------------	------------	-----------------	---	-----------

604B/5	1÷5 Nm
611	1/4
641	5-6-7-8 mm
900	4-5-5,5-6-7-8-9-10 mm

270x120x45 mm - 1,3 kg

671B/C10

Clé dynamométrique 604B/10 et accessoires



671B/C10	CHF	1,245.00	1	006710002
-----------------	------------	-----------------	---	-----------

604B/10	2÷10 Nm
611	1/4
641	6-7-8-10 mm
900	4-5-5,5-6-7-8-9-10 mm

270x120x45 mm - 1,4 kg

671N/C10

Clé dynamométrique 668N/10 et accessoires



671N/C10	CHF	1,405.00	1	006710110
-----------------	------------	-----------------	---	-----------

668N/10	100 Nm
612	3/8
617	3/8
642	10-13-14-17-19 mm
652	10-13-14-17-19 mm
910A	3/8 8-10-11-13-14-17-19 mm
910/21	125 mm
910/22	250 mm

400x180x45 mm - 4,3 kg

671N/C20

Clé dynamométrique 668N/20
et accessoires



671N/C20 **CHF** 1,485.00 1 006710120

668N/20	200 Nm
614	■ 1/2
619	■ 1/2
642	10-13-14-17-19 mm
652	10-13-14-17-19 mm
○ 920A	□ 1/2 10-11-13-14-17-19-22 mm
920/20	75 mm
920/21	125 mm
920/22	255 mm

510x180x45 mm - 5,5 kg

671N/C30

Clé dynamométrique 668N/30
et accessoires



671N/C30 **CHF** 1,410.00 1 006710130

668N/30	300 Nm
614	■ 1/2
619	■ 1/2
642	13-14-17-19 mm
652	13-14-17-19 mm
○ 920A	□ 1/2 13-14-17-19-22-24-27 mm
920/20	75 mm
920/21	125 mm
920/22	255 mm

620x180x45 mm - 5,8 kg



674/C

Clé dynamométrique à déclenchement,
embout rond Ø 22 mm,
pour serrage à droite et à gauche,
précision du couple: ± 4%,



UNI EN ISO 6789

Nm	Kgfm	lbf.ft	Ø	L	LB	LS	kg	10
			mm	mm	mm	mm		
100÷500	10÷50	80÷400	22	786	725	56	3,4	1,25

674/C50 **CHF** 1,032.00 1 006740005

Nm	Kgfm	lbf.ft	Ø	L	LB	LS	kg	2,0
			mm	mm	mm	mm		
160÷800	16÷80	120÷600	22	997	915	56	4,5	2,0

674/C80 **CHF** 1,094.00 1 006740008

Nm	Kgfm	lbf.ft	Ø	L	LB	LS	kg	4,5	2,5
			mm	mm	mm	mm			
200÷1000	20÷100	150÷750	22	997	915	56	4,5	2,5	

674/C100 **CHF** 1,109.00 1 006740010

677

Clé dynamométrique à cassure
avec cliquet simple
Utilisable pour le serrage à droite et à gauche
Précision de serrage : ± 4 %

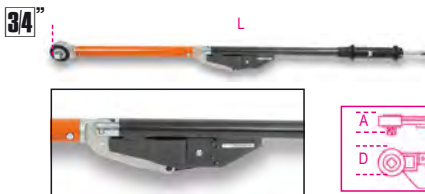

UNI EN ISO 6789

Nm	Kgfm	lbf.ft	D	A	L	kg	10
			mm	mm	mm		
120÷600	12÷60	100÷450	69	55	1059	6,0	10

677/600 **CHF** 1,156.00 1 006770006

Nm	Kgfm	lbf.ft	D	A	L	kg	10
			mm	mm	mm		
200÷800	20÷80	150÷600	69	55	1319	6,7	10

677/800 **CHF** 1,210.00 1 006770008

Nm	Kgfm	lbf.ft	D	A	L	kg	20
			mm	mm	mm		
300÷1000	30÷100	200÷750	69	55	1554	7,4	20

677/1000 **CHF** 1,295.00 1 006770010

677/C

Clé dynamométrique à cassure
avec cliquet réversible à glissière
utilisable pour serrage droite ou gauche
précision de serrage : ± 4%
en coffret



677/1500



UNI EN ISO 6789

Nm	Kgfm	lbf.ft	D	A	L	kg	10
			mm	mm	mm		
120÷600	12÷60	100÷450	69	55	1059	6,0	10

677/C600 **CHF** 1,365.00 1 006770607

Nm	Kgfm	lbf.ft	D	A	L	kg	10
			mm	mm	mm		
200÷800	20÷80	150÷600	69	55	1319	6,7	10

677/C800 **CHF** 1,420.00 1 006770612

Nm	Kgfm	lbf.ft	D	A	L	kg	20
			mm	mm	mm		
300÷1000	30÷100	200÷750	69	55	1554	7,4	20

677/C1000 **CHF** 1,505.00 1 006770616

Nm	Kgfm	lbf.ft	D	A	L	kg	25
			mm	mm	mm		
700÷1500	70÷150	500÷1000	69	55	1869	9,6	25

677/C1500 **CHF** 1,930.00 1 006770621

677/CP2000

clés dynamométriques à cassure avec cliquets
réversibles à glissière, utilisable pour serrage à
droite et à gauche,
Précision du couple : ± 4% en coffret



UNI EN ISO 6789

Nm	Kgfm	lbf.ft	D	A	L	kg	50
			mm	mm	mm		
900÷2000	90÷200	700÷1500	69	63	1940	12,75	50

677/CP2000 **CHF** 3,530.00 1 006770721



Beta

678/C

Clé dynamométrique à déclenchement avec cliquet réversible à glissière utilisable pour serrage droite ou gauche, précision de serrage : $\pm 4\%$ en coffret

• Modèles 678/C100 et 678/C150 fournis avec rallonge

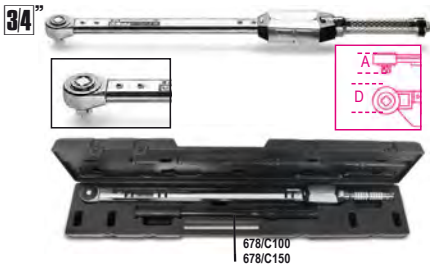

UNI EN ISO 6789

Nm	Kgfm	lbf.ft	D	A	L	kg
130÷650	13÷65	100÷480	63	55	885	3,9

678/C65	CHF	1	006780607
	2,130.00		

Nm	Kgfm	lbf.ft	D	A	L	kg
300÷1000	30÷100	220÷750	75	60	1250	6,0

678/C100	CHF	1	006780611
	2,830.00		

Nm	Kgfm	lbf.ft	D	A	L	kg
500÷1500	50÷150	370÷1100	75	60	1570	8,5

678/C150	CHF	1	006780615
	3,080.00		

677/CV - 678/CV

Coffret vide pour clé dynamométrique 677 et 678



677/CVN1	CHF	1	006770455
	210.00		

677/C600-677/C800-677/C1000	CHF	1	006770460
	276.00		

677/C1500-677/CP2000	CHF	1	006770460
	276.00		

678/CV1	CHF	1	006780455
	198.50		

678/C65	CHF	1	006780455
	198.50		

678/CV2	CHF	1	006780500
	223.00		

678/C100	CHF	1	006780500
	223.00		

678/CV3	CHF	1	006780415
	368.00		

677/C100-677/C150-678/C150	CHF	1	006780415
	368.00		

680

Couplemètre électronique numérique Dynatester 680 pour vérifier les étalonnages fonctionnement à droite et à gauche

- Précision de lecture : $\pm 1\%$ de la lecture
- Écran LCD couleur, 4 chiffres
- 3 unités de mesure : Nm - lbf.ft. - lbf.in



	Nm	kg	CHF	1	006800000
680/3	0,1÷3	1,4	3,620.00		
680/30	1,5÷30	1,4	3,570.00		1 006800003
680/350	10÷350	2,6	3,580.00		1 006800035
680/2100	200÷2100	3,5	5,330.00		1 006800210

682

Contrôleur de couple électronique digital Avec transducteur Dynatester 682 fonctionnant dans les 2 sens Haute précision de lecture Fourni avec sortie série RS 232



CARACTERISTIQUES TECHNIQUES

Précision de lecture $\pm 1\%$ de la valeur affichée
Unités de mesures possibles
Nm-dNm-cNm-lbf.ft-lbf.in-Ozf.in-Kgf.m-Kgf.cm-gf.cm
Alimentation de 90 à 264 Vc.a. à 50/60 Hz
Dimensions 235x185x185 mm
Test de tolérance selon la norme ISO 6789
Contrôle des clés suivant la norme ISO 6789
Définition de la tolérance selon la norme pour chaque type d'outil
Affichage
Menu disponible en 11 langues
Livré avec tous les certificats obligatoires
Certificats d'étalonnage avec traçabilité UKAS

	Nm	kg	CHF	1	006820006
682/60	1.2÷60	5,9	7,400.00		
682/400	8÷400	6,1	7,510.00		1 006820040
682/1500	30÷1500	6,4	7,750.00		1 006820150

DOUILLES À CHOCS



Les douilles à chocs sont surdimensionnées par rapport aux douilles à main, afin qu'elles puissent résister à des couples élevés tel que ceux développés par les clés à chocs et les multiplicateurs de couple.

Le profil hexagonal offre une durée de vie accrue après une utilisation intensive. Elles doivent être utilisées avec des goupilles et des bagues de sécurité afin d'empêcher le désaccouplement avec l'outil utilisé.

En plus des modèles classiques en versions standard et longue, une série longue et fine est également disponible. Elles sont utilisées dans les espaces où les vis ne sont pas accessibles avec les modèles standard. Il faut cependant être prudent lors de leur utilisation car elles sont plus fragile que les versions standards.



710

Douille à chocs, série normale



UNI/ISO 2725 DIN 3129

mm	Ø mm	L mm	Ø1 mm	CHF		
7	12,5	28	19	10.90	3	007100007
8	13,8	28	19	10.90	3	007100008
9	15,0	28	19	10.90	3	007100009
10	16,3	28	19	10.90	3	007100010
11	17,5	30	19	10.90	3	007100011
12	19,0	30	19	10.90	3	007100012
13	20,0	30	22	11.40	3	007100013
14	21,3	30	22	11.40	3	007100014
16	23,8	30	22	11.60	3	007100016
17	25,0	30	22	11.60	3	007100017
18	26,3	30	22	11.90	3	007100018
19	27,5	30	22	11.90	3	007100019
21	30,0	32	22	13.20	3	007100021
22	32,0	32	22	14.60	3	007100022

710/C10

10 douilles à chocs



CHF 165.00 1 007100910

710/C10
7-8-10-11-12-13
14-17-19-22 mm

130x55x40 mm - 800 g

710/16

Augmentateur carré femelle 3/8" et mâle 1/2"



CHF 29.50 3 007100810

L mm 32
Ø mm 22
3/8 1/2

710/20

Rallonge carrés mâle et femelle 3/8"



CHF 30.00 2 007100821

L mm 75
Ø mm 22

710/21

Rallonge carrés mâle et femelle 3/8"



CHF 33.00 2 007100823

L mm 125
Ø mm 22

710/22

Rallonge à chocs carrés mâle et femelle 3/8"



CHF 38.50 2 007100825

L mm 150
Ø mm 22

710/25

Cardan carrés mâle et femelle 3/8"



CHF 60.50 2 007100830

L mm 58
Ø mm 24

710/OR... - 710/SP...

Bague en caoutchouc et goupille de sécurité pour douille et accessoires à chocs



	710 mm	710/16 L mm	CHF		
710/OR1	7-12		0.91	10	007100921
710/OR2	13-22	32	0.91	10	007100922
710/SP1	7-12		1.67	10	007100911
710/SP2	13-22	32	1.67	10	007100912



720

Douille à chocs, série normale



UNI/ISO 2725 DIN 3129

mm	Ø mm	L mm	Ø1 mm	CHF		
8	15,0	38	25	13.00	5	007200008
9	16,0	38	25	13.00	5	007200009
10	17,0	38	25	13.30	5	007200010
11	18,5	38	25	13.30	5	007200011
12	20,0	38	25	13.30	5	007200012
13	21,0	38	25	13.30	5	007200013
14	22,5	38	25	13.30	5	007200014
15	23,0	38	30	14.90	5	007200015
16	25,0	38	30	14.90	5	007200016
17	26,0	38	30	14.90	5	007200017
18	27,5	38	30	14.90	5	007200018
19	28,5	38	30	14.90	5	007200019
20	30	38	30	16.40	5	007200020
21	31,0	38	30	16.40	5	007200021
22	32,5	38	30	16.60	5	007200022
23	34,0	38	30	18.10	5	007200023
24	35,0	38	30	18.10	5	007200024
27	38,5	45	30	21.10	3	007200027
29	41	47	30	23.10	3	007200029
30	42,0	50	30	23.10	3	007200030
32	44,0	50	30	26.50	3	007200032
36	50,0	50	30	38.00	3	007200036

720/C6

6 Douilles à chocs



CHF 134.50 1 007200910

720/C6
13-14-17-19-22-24 mm

195x80x55 mm - 1100 g

720/C12

12 Douilles à chocs



CHF 245.00 1 007200912

720/C12
10-11-12-13-14-17
19-22-24-27-30-32 mm

195x80x55 mm - 2000 g

720/C24

24 douilles à chocs



720/C24 CHF 523.00 1 007200904

720	10 - 12 - 13 - 14 - 15 - 16 - 17 - 18 - 19 - 21 - 22 - 24 - 27 - 30 - 32 mm
720L	13 - 17 - 19 - 21 - 22 - 24 mm
720LC	17 - 19 - 21 mm

420x185x60 mm - 6,2 kg

720MC

Douille à chocs, série normale, colorée



Ø mm	L mm	CHF	Q	Art.
10	17,0	13.80	3	007202010
11	18,5	13.80	3	007202011
12	20,0	13.80	3	007202012
13	21,0	13.80	3	007202013
14	22,5	13.80	3	007202014
15	23,0	15.50	3	007202015
16	25,0	15.50	3	007202016
17	26,0	15.50	3	007202017
18	27,5	15.50	3	007202018
19	28,5	15.50	3	007202019
21	31,0	17.20	2	007202021
22	32,5	17.20	2	007202022
24	35,0	18.90	2	007202024

720MC/C13

13 douilles à chocs colorées



720MC/C13 CHF 249.00 1 007202913

10-11-12-13-14-15
16-17-18-19-21-22
24 mm

335x145x60 mm - 2,4 kg

720B

Douille à chocs
12 pans



UNI/ISO 2725 DIN 3129

Ø mm	L mm	Ø1 mm	CHF	Q	Art.
10	17	38	25	13.30	5 007201010
11	18	38	25	13.30	5 007201011
12	19	38	25	13.30	5 007201012
13	20	38	25	13.30	5 007201013
14	22	38	25	13.30	5 007201014
15	23	38	30	14.90	5 007201015
16	24	38	30	14.90	5 007201016
17	26	38	30	14.90	5 007201017
18	27	38	30	14.90	5 007201018
19	28	38	30	14.90	5 007201019
21	30	38	30	16.40	5 007201021
22	31,8	38	30	16.60	5 007201022
23	31,8	38	30	18.10	5 007201023
24	33,8	40	30	18.10	5 007201024
27	37,8	43	30	21.10	3 007201027
30	41,8	43	30	23.10	3 007201030
32	43,8	43	30	26.50	3 007201032
36	49,8	50	30	38.00	3 007201036

720B/C12

12 douilles à chocs 12 pans



UNI/ISO 2725 DIN 3129

720B/C12 CHF 245.00 1 007201912
10-11-12-13-14-17
19-22-24-27-30-32 mm

195x80x55 mm - 2000 g

720AS

Douille à chocs, série normale



Ø mm	L mm	Ø1 mm	CHF	Q	Art.
3/8	17,0	38	25	21.50	2 007200210
7/16	18,2	38	25	21.50	2 007200211
1/2	20,7	38	25	21.50	2 007200213
9/16	22,0	38	25	21.50	2 007200214
5/8	24,5	38	30	23.10	2 007200216
11/16	25,7	38	30	23.10	2 007200217
3/4	28,2	38	30	23.10	2 007200219
13/16	30,7	38	30	24.40	2 007200221
7/8	32,0	38	30	24.40	2 007200222
15/16	34,5	38	30	26.00	2 007200224
1	35,7	38	30	28.00	2 007200225
1.1/16	38,2	40	30	31.00	1 007200227
1.1/8	40,7	42	30	34.50	1 007200229
1.1/4	44,5	42	30	38.50	1 007200232

720S

Douille à chocs,
série compacte



Ø mm	L mm	Ø1 mm	CHF	Q	Art.
13	20,0	28,0	23,8	8.30	3 007200113
15	23,0	28,0	23,8	8.30	3 007200115
17	25,8	28,0	25,8	9.05	3 007200117
19	27,8	28,0	27,8	9.85	3 007200119
22	31,8	28,0	30,0	10.70	3 007200122
24	33,8	28,0	30,0	11.70	3 007200124



720S/SB6 CHF 71.50 1 007200906
13-15-17-19-22-24 mm

720L

Douille à chocs longue



UNI/ISO 2725

Ø mm	L mm	Ø1 mm	CHF	Q	Art.
10	17,0	80	25	22.70	2 007200310
11	18,5	80	25	22.70	2 007200311
12	20,0	80	25	22.70	2 007200312
13	21,0	80	25	22.70	2 007200313
14	22,5	80	25	22.70	2 007200314
15	23,0	80	30	26.00	2 007200315
16	25,0	80	30	26.00	2 007200316
17	26,0	80	30	26.00	2 007200317
18	27,5	80	30	27.00	2 007200318
19	28,5	80	30	27.00	2 007200319
21	31,0	80	30	29.00	2 007200321
22	32,5	80	30	29.00	2 007200322
24	35,0	80	30	30.00	2 007200324
27	38,5	80	30	38.00	2 007200327
30	42,0	80	30	46.00	2 007200330
32	44,0	80	30	46.00	2 007200332
36	50,0	80	30	59.00	2 007200336

720L/S3

Jeu de 3 douilles à chocs 720L



720L/S3 CHF 82.00 1 007200355
17-19-21 mm

720LS

Douille à chocs, série longue et fine



mm	Ø mm	L mm	Ø1 mm	CHF	Icon	Icon
10	15,5	78	24	24.40	2	007200360
11	16,7	78	24	24.40	2	007200361
12	18,0	78	24	24.40	2	007200362
13	19,2	78	24	24.40	2	007200363
14	20,5	78	24	24.40	2	007200364
15	21,7	78	24	25.00	2	007200365
16	23,0	78	24	25.00	2	007200366
17	24,2	78	29	28.00	2	007200367
18	25,5	78	29	30.00	2	007200368
19	26,7	78	29	30.00	2	007200369
21	29,2	78	29	31.50	2	007200371
22	30,5	78	29	31.50	2	007200372
24	33,0	78	29	32.00	2	007200374
27	36,7	78	29	39.50	2	007200377
30	40,5	78	29	50.00	2	007200380
32	43,0	78	29	52.00	2	007200382
36	48,0	78	29	78.00	2	007200386

720LC

Douilles à chocs gainées pour écrous de roues en alliage léger



mm	Ø mm	CHF	Icon	Icon
17	26,5	16.40	2	007200637
19	28,5	16.40	2	007200639
21	30,3	17.00	2	007200641
22	32,4	17.70	2	007200642
24	34,6	19.20	2	007200644



720LC/C3	CHF	Icon	Icon
17-19-21 mm	49.50	1	007200653

148x132x44 mm - 860 g



720LC/S5	CHF	Icon	Icon
17-19-21-22-24 mm	87.00	1	007200645

12"



720LC/PM5	CHF	Icon	Icon
17-19-21-22-24 mm	145.50	1	007200646

PM 1/2-Q5

Rail magnétique porte douilles



PM 1/2-Q5	CHF	Icon	Icon
	59.00	1	088880233

720IC

Embout polymères colorés pour douilles à chocs 720LC-720LCL



720IC	mm	CHF	Icon	Icon
17	17	6.60	1	007200687
19	19	6.60	1	007200689
21	21	6.60	1	007200691
22	22	6.60	1	007200692
24	24	6.60	1	007200694

Beta
Quality Tools

720LCL

Douille à chocs colorées, série longue, avec embouts polymères pour écrous de roues



mm	Ø mm	CHF	Icon	Icon
17	26,5	27.00	1	007200737
19	28,5	27.00	1	007200739
21	30,3	27.00	1	007200741



720LCL/C3	CHF	Icon	Icon
17-19-21 mm	103.50	1	007200753

210x50x150 mm - 1,65 kg

720MRC

Douille à chocs avec embout polymère pour vis roue avec profil Mercedes

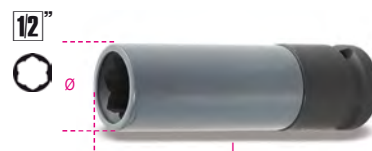

mm	Ø mm	L mm	CHF	Icon	Icon
17	27	85	26.50	1	007200631

720FRD

Douille à chocs pour écrous de roue Ford présentant un revêtement en aluminium endommagé

Indispensable quand la tête de l'écrou est endommagée par la clé à chocs



mm	L mm	CHF	Icon	Icon
18,5÷19,5	63	25.00	1	007200633

720RNG

Douille à chocs pour écrous de roue Jeep Renegade présentant un revêtement en aluminium endommagé

Indispensable quand la tête de l'écrou est endommagée par la clé à chocs



mm	L mm	CHF	Icon	Icon
16,5÷17,5	63	25.00	1	007200634

720TC

Douille à chocs colorée à contrôle de couple



Nm	L mm	CHF	Icon	Icon
90	200	28.50	1	007200769
100	200	28.50	1	007200770
110	200	28.50	1	007200771
120	200	28.50	1	007200772
135	200	28.50	1	007200773

12"



720TC/S5	CHF		
90-100-110-120-135 Nm	143.00	1	007200779
260x50x175 mm - 1,35 kg			

720FTX

Douille à chocs pour écrous Torx®

12"



	Ø mm	L mm	Ø1 mm	CHF		
E10	14,0	38	25	21.20	2	007200410
E12	15,9	38	25	21.20	2	007200412
E14	17,7	38	25	21.20	2	007200414
E16	20,0	38	25	21.20	2	007200416
E18	22,0	38	25	21.20	2	007200418
E20	25,0	40	25	22.60	2	007200420
E24	30,0	40	30	22.60	2	007200424

12"



720FTX/SB6	CHF		
E10-E12-E14 E16-E18-E20	142.00	1	007200450

720TX

Douille tournevis à chocs pour vis Torx®

12"



	Ø mm	L mm	L1 mm	CHF		
T30	25	78	54	18.60	3	007200460
T40	25	78	54	18.60	3	007200470
T45	25	78	54	19.00	3	007200472
T50	25	78	54	19.00	3	007200474
T55	25	78	54	21.50	3	007200476
T60	25	78	54	23.10	3	007200478

720TX/C6

Jeu de 6 douilles à chocs 720TX en coffret métallique

12"



720TX/C6	CHF		
T30-T40-T45 T50-T55-T60	157.00	1	007200483

275x120x65 mm - 5700 g

720ME

Douille tournevis à chocs pour vis 6 pans creux

12"

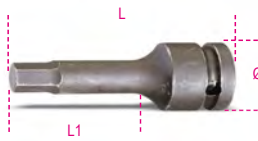

mm	Ø mm	L mm	L1 mm	CHF		
5	25	78	54	17.90	3	007200505
6	25	78	54	17.90	3	007200506
8	25	78	54	17.90	3	007200508
10	25	78	54	17.90	3	007200510
12	25	78	54	17.90	3	007200512
14	25	78	54	20.00	3	007200514
17	25	78	54	20.00	3	007200517
19	25	78	54	20.00	3	007200519

720ME/C8

Jeu de 8 douilles à chocs 720ME

12"



720ME/C8	CHF		
5-6-8-10-12 14-17-19 mm	192.00	1	007200525

270x120x45 mm - 1710 g

9899 720ME/C8	CHF		
Plateau thermoformé vide	17.20	1	098990130

720XZN

Douille mâle à chocs pour vis XZN®

12"



Ø mm	L mm	L1 mm	CHF			
M4	25	77	53	20.20	3	007201504
M5	25	77	53	20.20	3	007201505
M6	25	77	53	20.20	3	007201506
M8	25	77	53	20.20	3	007201508
M10	25	77	53	20.70	3	007201510
M12	25	77	53	21.20	3	007201512
M14	25	77	53	21.20	3	007201514
M16	25	77	53	21.70	3	007201516
M18	25	77	53	22.80	3	007201518

720XZN/C6

6 douilles à chocs pour vis XZN®

12"



720XZN/C6	CHF		
M8-M10-M12-M14 M16-M18	165.00	1	007201530

275x120x65 mm - 5700 g

720/SN

Douilles à chocs articulées

12"



mm	Ø mm	L mm	Ø1 mm	CHF		
17	25,7	69,6	30	93.00	2	007200087
19	28,2	73,6	30	93.00	2	007200089
24	34,5	75,6	30	104.00	2	007200094

720/15

Réducteur carré femelle 1/2" et mâle 3/8"

12"



L mm	Ø mm	CHF		
37,5	25	14.90	3	007200810



Toujours appliquer la force de serrage régulièrement et progressivement afin d'éviter la rupture et de se protéger contre un possible accident.

720/16

Augmentateur carré femelle 1/2" et mâle 3/4"

12"



L mm	Ø mm	CHF		
44	30	25.50	3	007200814

720/20

Rallonge carrés mâle et femelle 1/2"



L mm	Ø mm	CHF	3	007200818
75	25	26.50		

720/21

Rallonge carrés mâle et femelle 1/2"



L mm	Ø mm	CHF	3	007200822
125	25	28.50		

720/22

Rallonge à chocs carrés mâle et femelle 1/2"



L mm	Ø mm	CHF	3	007200824
250	25	33.50		

720/25

Cardan carrés mâle et femelle 1/2"



L mm	Ø mm	CHF	2	007200831
64	28	49.00		

720/OR... - 720/SP...

Bague en caoutchouc et goupille de sécurité pour douille et accessoires à choc



	720 Ø mm	720TX T30+T60	CHF	10	007200923
720/OR1	10+14	T30+T60	1.70		
720/OR2	15+36	T30+T60	1.70		
720/SP1	10+14	T30+T60	2.51		
720/SP2	15+36	T30+T60	2.51		

727PI/16 1/2

Douille porte-embouts à chocs pour 727/ES16, 727/ES16TX et 727/ES16XZN



Ø mm	L mm	Ø mm	1/2	CHF	2	007270015
28	42	16		44.00		

727PI/16

Douille porte-embouts à chocs pour articles 727/ES16 et 727/ES16TX



Ø mm	L mm	Ø mm	3/4	CHF	2	007270016
44	52	16		57.50		

727/ES16

Embout à chocs pour vis 6 pans creux avec entraînement 16 mm



mm	Ø mm	L mm	CHF	2	007270110
10	16	40	19.50		
12	16	40	19.50		
13	16	40	19.50		
14	16	40	19.50		
16	16	40	21.00		
17	16	40	21.00		
18	16	40	21.80		
19	16	40	21.80		
22	16	40	25.00		

727/ES16TX

Embout à choc pour vis Torx® avec entraînement 16mm



Ø mm	Ø mm	L mm	CHF	2	007270355
T55	16	50	29.50		
T60	16	50	29.50		
T70	16	50	29.50		

727/ES16XZN

Embout à chocs pour vis XZN®, entraînement 16 mm



Ø mm	Ø mm	L mm	CHF	2	007270606
M6	16	60	35.50		
M8	16	60	35.50		
M10	16	60	35.50		
M12	16	60	35.50		
M14	16	60	35.50		
M16	16	60	35.50		
M18	16	60	49.00		

Beta

Beta

727PI/22

Douille porte-embouts à chocs pour articles 727/ES22 et 727/ES22TX



Ø mm	L mm	Ø mm	CHF	Hand	Computer
54	70	22	89.00	2	007270022

727/ES22

Embout à chocs pour vis 6 pans creux avec entraînement 22 mm



mm	Ø mm	L mm	CHF	Hand	Computer
19	22	50	25.00	2	007270219
22	22	50	25.00	2	007270222
24	22	50	27.50	2	007270224
27	22	50	31.00	2	007270227
30	22	50	37.00	2	007270230
32	22	50	40.50	2	007270232

727/ES22TX

Embout à choc pour vis Torx® avec entraînement 22 mm



Ø	Ø mm	L mm	CHF	Hand	Computer
T80	22	60	41.00	2	007270480
T90	22	60	41.00	2	007270490
T100	22	60	41.00	2	007270500

727/C16

12 embouts à chocs et 4 accessoires



727/C16	CHF	Hand	Computer
	560.00	1	007270900

- 727PI/16
- 727/ES16 14-17-19 mm
- 727/ES16TX T55-T60-T70
- 727PI/22
- 727/ES22 22-24-27 mm
- 727/ES22TX T80-T90-T100
- 96BPC 3-4 mm

335x145x60 mm - 5,7 kg

727PI/32

Douille porte-embouts à choc pour article 727/ES32

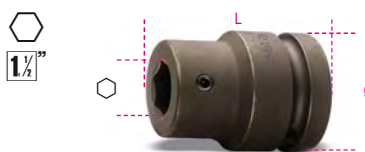

Ø mm	L mm	Ø mm	CHF	Hand	Computer
86	66	32	222.00	1	007270032

727/ES32

Embout à choc pour vis 6 pans creux, avec entraînement 32 mm



mm	Ø mm	L mm	CHF	Hand	Computer
19	32	44	57.00	2	007270519
22	32	44	57.00	2	007270522
24	32	44	57.00	2	007270524
27	32	44	57.00	2	007270527
30	32	44	57.00	2	007270530
32	32	44	57.00	2	007270532
36	32	44	64.00	2	007270536

728

Douille à chocs, série normale



UNI/ISO 2725 DIN 3129

Ø mm	Ø mm	L mm	Ø1 mm	CHF	Hand	Computer
17	30,0	51	44	33.00	2	007280017
18	31,0	51	44	33.00	2	007280018
19	32,5	51	44	33.00	2	007280019
21	35,0	51	44	33.00	2	007280021
22	36,0	51	44	33.00	2	007280022
23	37,5	51	44	33.50	2	007280023
24	38,5	51	44	33.50	2	007280024
27	42,5	53	44	33.50	2	007280027
28	44,0	53	44	34.00	2	007280028
30	46,0	53	44	35.50	2	007280030
32	48,5	57	44	37.00	2	007280032
33	50,0	57	44	39.50	2	007280033
34	51,0	57	44	39.50	2	007280034
35	52,5	57	44	41.00	2	007280035
36	53,5	57	44	42.00	2	007280036
38	56,0	57	44	47.00	1	007280038
40	58,5	58	44	50.00	1	007280040
41	60,0	58	44	51.00	1	007280041
44	64,0	62	44	55.00	1	007280044
45	65,0	62	44	59.50	1	007280045
46	66,0	62	44	60.00	1	007280046
50	71,0	68	54	70.50	1	007280050
55	77,5	71	54	78.50	1	007280055
60	83,0	73	54	90.00	1	007280060
65	88,0	78	54	100.00	1	007280065

728/C10

10 douilles à chocs



728/C10	CHF	Hand	Computer
17-19-22-24-27-30-32-36-41-46 mm	440.00	1	007280910

275x120x65 mm - 5,7 kg

728B

Douille à chocs 12 pans



UNI/ISO 2725 DIN 3129

Ø mm	Ø mm	L mm	Ø1 mm	CHF	Hand	Computer
17	28,5	50	38	33.00	2	007280117
19	30	52	38	33.00	2	007280119
21	32	52	38	33.00	2	007280121
22	34	52	38	33.00	2	007280122
23	35	52	38	33.50	2	007280123
24	36	52	38	33.50	2	007280124
27	40	52	40	33.50	2	007280127
29	42	52	42	34.50	2	007280129
30	44	52	44	35.50	2	007280130
32	48	52	44	37.00	2	007280132
33	50	56	44	39.50	2	007280133
34	51	56	44	39.50	2	007280134
35	52	56	44	41.00	2	007280135
36	53,5	56	44	42.00	2	007280136
38	56	56	44	47.00	1	007280138
41	60	58	44	51.00	1	007280141
46	67	63	44	60.00	1	007280146

728B/C10

10 douilles à chocs 12 pans



728B/C10	CHF	Hand	Computer
17-19-22-24-27-30-32-36-41-46 mm	440.00	1	007280930

275x120x65 mm - 5,7 kg

Beta
Quality Tools

728AS

Douille à chocs, série normale



"	Ø mm	L mm	Ø1 mm	CHF		
3/4	32,0	51	41	33.00	1	007280219
13/16	35,0	51	41	33.50	1	007280221
7/8	36,0	51	41	33.50	1	007280222
15/16	38,5	51	41	33.50	1	007280224
1	40,0	53	41	34.00	1	007280225
1.1/16	42,5	53	44	36.50	1	007280227
1.1/8	44,0	53	44	37.00	1	007280230
1.1/4	48,5	57	44	38.00	1	007280232
1.5/16	50,0	57	44	39.50	1	007280233
1.7/16	53,5	57	44	42.00	1	007280236
1.1/2	56,0	57	44	46.50	1	007280238
1.5/8	60,0	58	44	51.00	1	007280241

728FTX

Douille à chocs pour écrous Torx®



"	Ø mm	L mm	Ø1 mm	CHF		
E20	28,5	50	44	44.00	2	007280420
E22	30,0	50	44	44.00	2	007280422
E24	32,5	50	44	44.00	2	007280424

728ME

Douille mâle à chocs 6 pans

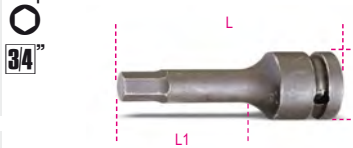

mm	Ø mm	L mm	L1 mm	CHF		
12	44	100	67	38.50	3	007280712
14	44	100	67	42.50	3	007280714
17	44	100	67	42.50	3	007280717
19	44	100	67	42.50	3	007280719
22	44	100	67	50.00	3	007280722
24	44	100	67	50.00	3	007280724

728ME/C6

6 douilles à chocs pour vis 6 pans creux



728ME/C6 CHF 316.00 1 007280906

12-14-17-19-22-24 mm

335x145x60 mm - 4,0 kg

728L

Douille à chocs, série longue



"	Ø mm	L mm	Ø1 mm	CHF		
17	30	90	44	52.00	2	007280317
19	32,5	90	44	52.00	2	007280319
21	35,0	90	44	52.00	2	007280321
22	36,0	90	44	52.00	2	007280322
24	38,5	90	44	52.00	2	007280324
26	41,0	90	44	52.00	2	007280326
27	42,5	90	44	52.00	2	007280327
30	46,0	90	44	54.00	2	007280330
32	48,5	90	44	57.00	2	007280332
33	50,0	90	44	60.50	1	007280333
34	51,0	90	44	64.50	1	007280334
36	53,5	90	44	67.00	1	007280336
38	56,0	90	44	78.00	1	007280338
41	60,0	90	44	80.00	1	007280341
44	64,0	90	44	91.50	1	007280344
46	66,0	90	44	91.50	1	007280346
50	71,0	90	44	109.50	1	007280350
55	77,5	100	54	144.50	1	007280355



728L/S3 CHF 178.00 1 007280393

30-32-36 mm

728LS

Douille à chocs, série longue et fine



"	Ø mm	L mm	Ø1 mm	CHF		
17	28,0	100	43	59.00	2	007280517
19	30,5	100	43	59.00	2	007280519
22	34,3	100	43	60.00	2	007280522
24	36,8	100	43	60.00	2	007280524
27	40,5	100	43	60.00	2	007280527
30	44,3	100	43	60.00	2	007280530
32	46,8	100	43	64.50	2	007280532
33	48,0	100	43	66.50	2	007280533
36	51,8	100	43	77.50	1	007280536

728LQ

Douille à chocs, série longue

(pour écrous de roues ISUZU)



"	L mm	Ø mm	Ø1 mm	CHF		
19	90	35	43,5	52.50	1	007280619
21	90	42	43,5	52.50	1	007280621

728/15

Réducteur carré femelle 3/4" et mâle 1/2"



L mm Ø mm CHF 58 38 3/4 1/2 41.00 2 007280810



Toujours appliquer la force de serrage régulièrement et progressivement afin d'éviter la rupture et de se protéger contre un possible accident.

728/16

Augmentateur carré femelle 3/4" et mâle 1"



L mm Ø mm CHF 62 44 3/4 1 49.50 2 007280813

728/21

Rallonge carrés mâle et femelle 3/4"



L mm Ø mm CHF 175 44 60.50 2 007280815

728/22

Rallonge carrés mâle et femelle 3/4"



L mm Ø mm CHF 250 44 70.00 2 007280825

728/22L

Rallonge à chocs carrés mâle et femelle 3/4"



L mm Ø mm CHF 330 44 90.00 1 007280826

728/25

Cardan carrés mâle et femelle 3/4"

3/4"



L mm	Ø mm	CHF	Unit	Part No.
107,5	44	118.50	1	007280830

728/OR - 728/SP

Bague en caoutchouc et goupille de sécurité pour douille et accessoires à chocs

3/4"



728/Ø mm	728/FTX	CHF	Unit	Part No.
728/OR-15	728/15	2.50	5	007280925
728/OR	17+46 E20+E24	2.66	10	007280926
728/SP	17+46 E20+E24	3.50	10	007280916

729

Douille à chocs, série normale

1"



UNI/ISO 2725 DIN 3129

Ø mm	Ø1 mm	L mm	CHF	Unit	Part No.
24	58	54	52.50	1	007290024
27	60	54	52.50	1	007290027
30	62	54	52.50	1	007290030
32	63	54	54.00	1	007290032
33	63	54	54.00	1	007290033
34	63	54	54.00	1	007290034
36	66	54	54.00	1	007290036
38	66	54	65.00	1	007290038
41	68	54	66.50	1	007290041
46	72	54	74.50	1	007290046
50	76	54	91.50	1	007290050
55	84	54	98.00	1	007290055
60	88	54	118.50	1	007290060
65	92	54	135.50	1	007290065
70	96	54	174.00	1	007290070
75	102	63	203.50	1	007290075
80	102	63	219.00	1	007290080

729L

Douille à chocs, série longue

1"



Ø mm	Ø1 mm	L mm	CHF	Unit	Part No.
24	58	54	93.50	1	007290324
27	60	54	93.50	1	007290327
30	62	54	93.50	1	007290330
32	63	54	93.50	1	007290332
33	63	54	95.00	1	007290333
34	63	54	95.00	1	007290334
36	66	54	95.00	1	007290336
41	68	54	113.00	1	007290341
46	72	54	131.00	1	007290346
50	76	54	146.50	1	007290350

Ø mm	Ø1 mm	L mm	CHF	Unit	Part No.
55	80,0	108	175.50	1	007290355
60	86,5	108	189.50	1	007290360
65	92,5	108	228.50	1	007290365
70	99,0	108	260.00	1	007290370
75	105,0	108	294.00	1	007290375
80	111,5	108	309.00	1	007290380

729LS

Douille à choc, série longue et fine

1"



Ø mm	Ø1 mm	L mm	CHF	Unit	Part No.
22	36,0	108	93.50	1	007290522
24	38,5	108	93.50	1	007290524
27	46,0	108	93.50	1	007290527
30	50,0	108	99.00	1	007290530
32	50,0	108	99.00	1	007290532
33	52,0	108	99.00	1	007290533
36	56,0	108	99.00	1	007290536

729T

Douille à choc à contrôle de couple

1"



Ø mm	Nm	L mm	CHF	Unit	Part No.
24	350	300	182.00	1	007290724
27	450	300	182.00	1	007290757
30	500	300	184.00	1	007290730
32	450	300	187.00	1	007290732
32	600	300	187.00	1	007290762
33	600	300	196.50	1	007290763
36	600	300	208.50	1	007290736

729/15

Réducteur carré femelle 1" et mâle 3/4"

1"



L mm	Ø mm	CHF	Unit	Part No.
66,5	54	62.50	1	007290810



Toujours appliquer la force de serrage régulièrement et progressivement afin d'éviter la rupture et de se protéger contre un possible accident.

729/16

Réducteur carré femelle 1" et mâle 1.1/2"

1"



L mm	Ø mm	CHF	Unit	Part No.
88	54,0	103.00	1	007290813

729/21

Rallonge carrés mâle et femelle 1"

1"



L mm	Ø mm	CHF	Unit	Part No.
175	54	96.00	1	007290815

729/21L

Rallonge à chocs carrés mâle et femelle 1"

1"



L mm	Ø mm	CHF	Unit	Part No.
250	54	117.00	1	007290826

729/22

Rallonge carrés mâle et femelle 1"

1"



L mm	Ø mm	CHF	Unit	Part No.
330	54	137.50	1	007290825

729/25

Cardan carrés mâle et femelle 1"

1"



L mm	Ø mm	CHF	Unit	Part No.
130	54	199.00	1	007290830

729/OR... - 729/SP...

Bague en caoutchouc et goupille de sécurité pour douille et accessoires à chocs

3/4"

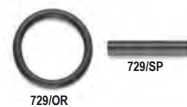

1"

1/2"

729/Ø mm	728/Ø mm	729-730/Ø mm	CHF	Unit	Part No.
729/OR1	50+60	24+70	2.72	5	007290927
729/OR2	75+125	24+70	4.20	5	007290928
729/SP1	50+60	24+70	2.56	5	007290917
729/SP2	75+125	24+70	4.20	5	007290918

730

Douille à chocs, série normale



UNI/ISO 2725 DIN 3129

Ø	L	Ø1	CHF		
mm	mm	mm			
50	81	87	274.00	1	007300050
55	88	90	281.00	1	007300055
60	94	95	310.00	1	007300060
65	100	100	340.00	1	007300065
70	106	105	402.00	1	007300070
75	113	110	466.00	1	007300075
80	119	115	533.00	1	007300080
85	125	120	590.00	1	007300085
90	132	125	672.00	1	007300090
95	138	125	782.00	1	007300095
100	144	130	909.00	1	007300100
105	150	135	1,013.00	1	007300105
110	157	140	1,101.00	1	007300110
115	163	140	1,184.00	1	007300115
120	169	145	1,325.00	1	007300120
125	175	145	1,380.00	1	007300125

730L

Douille à chocs, série longue



Ø	L	Ø1	CHF		
mm	mm	mm			
50	81	135	438.00	1	007300350
55	87	140	449.00	1	007300355
60	93	150	497.00	1	007300360
65	97	150	544.00	1	007300365
70	105	160	644.00	1	007300370
75	110	170	746.00	1	007300375
80	116	170	854.00	1	007300380
85	125	170	945.00	1	007300385
90	130	170	1,075.00	1	007300390
95	137	180	1,250.00	1	007300395
100	144	190	1,455.00	1	007300400
105	150	190	1,620.00	1	007300405
110	156	200	1,760.00	1	007300410
115	160	200	1,895.00	1	007300415
120	168	210	2,120.00	1	007300420

730/15

Réducteur



L	Ø	CHF		
mm	mm			
105	84,0	214.50	1	007300810

Toujours appliquer la force de serrage régulièrement et progressivement afin d'éviter la rupture et de se protéger contre un possible accident.

730/21

Rallonge à chocs carrés mâle et femelle 1.1/2"



L	Ø	CHF		
mm	mm			
250	86	784.00	1	007300822

730/25

Cardan à chocs carrés mâle et femelle 1.1/2"



L	Ø	CHF		
mm	mm			
150	86	822.00	1	007300830

733/15

Réducteur



L	Ø	CHF		
mm	mm			
156	127	754.00	1	007330810



EMBOUS

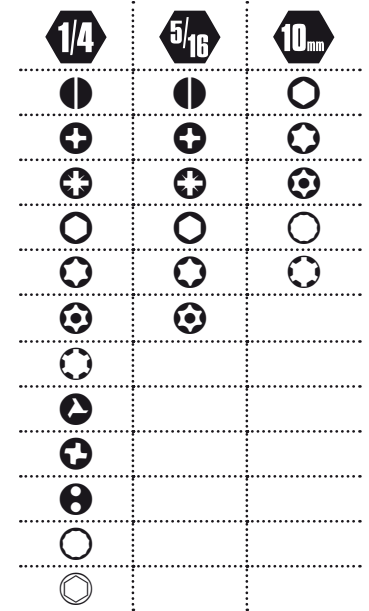

ISO 1173-C 6,3



emmenchement simple

ISO 1173-E 6,3



fente pour maintien embout

851

Poignée porte-embouts magnétique

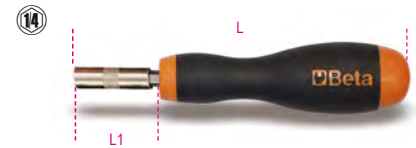

L1	L	CHF		
mm	mm			
45	165	21.10	2	008510165
125	245	24.40	2	008510245

851SR

Poignée porte-embouts à bague de déverrouillage rapide



L	L1	CHF		
mm	mm			
230	110	29.00	2	008510001

852

Porte-embouts à cardan

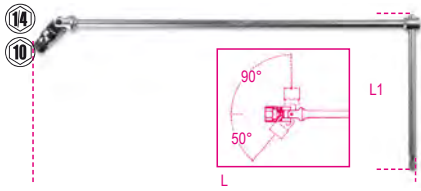

Ø	L mm	L1 mm	CHF	5	10
1/4"	400	160	60.00	2	008520006
10 mm	400	160	60.00	2	008520010

855P

Porte-embouts à cliquet réversible avec poignée articulée et 7 embouts incorporés

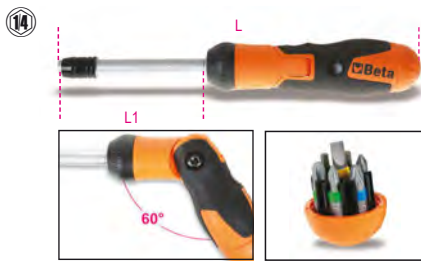

L mm	L1 mm	CHF	5	10
240	100	95.50	1	008550010

	860PH	PH1 - PH2
	860PZ	PZ1 - PZ2
	860LP	LP 0,8x5,5 mm
	860PE	4 - 5 mm

860LP

Embout coloré pour visseuses pour vis à fente



ISO 2351-1
ISO 1173 C 6,3

SxL mm	L mm	CHF	5	10
0,5x3	25	2.51	5	008600005
0,6x4,5	25	2.51	5	008600010
0,8x5,5	25	2.51	5	008600015
1x5,5	25	2.51	5	008600020
1,2x6,5	25	2.51	5	008600025

860PH

Embout coloré pour visseuses pour vis Phillips®

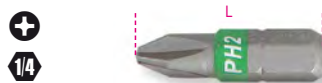

ISO 2351-2
ISO 1173 C 6,3

PH	L mm	CHF	5	10
0	25	2.51	5	008600220
1	25	2.51	5	008600225
2	25	2.51	5	008600230
3	25	2.51	5	008600245
4	25	3.65	5	008600250

860PZ

Embout coloré pour visseuses pour vis Pozidriv® - Supadriv®



ISO 2351-2
ISO 1173 C 6,3

PZ	L mm	CHF	5	10
1	25	2.51	5	008600320
2	25	2.51	5	008600325
3	25	2.51	5	008600330
4	25	3.65	5	008600335

860PE

Embout coloré pour visseuses pour vis 6 pans creux



ISO 2351-3
ISO 1173 C 6,3

mm	L mm	CHF	5	10
2	25	2.67	5	008600101
2,5	25	2.67	5	008600102
3	25	2.67	5	008600103
4	25	2.67	5	008600104
5	25	2.67	5	008600105
6	25	2.67	5	008600106
8	25	3.35	5	008600108
10	25	3.35	5	008600110

860TX

Embout coloré pour visseuses pour vis Torx®



ISO 1173 C 6,3

Ø	L mm	CHF	5	10
T6	25	3.35	5	008600704
T7	25	3.35	5	008600705
T8	25	3.35	5	008600710
T9	25	3.35	5	008600715
T10	25	2.67	5	008600720
T15	25	2.67	5	008600725
T20	25	2.67	5	008600730
T25	25	2.67	5	008600735
T27	25	2.67	5	008600740
T30	25	2.67	5	008600745
T40	25	2.67	5	008600750

860RTX

Embout coloré pour visseuses pour vis Tamper Resistant Torx®



ISO 1173 C 6,3

Ø	L mm	CHF	5	10
T9	25	3.65	5	008600550
T10	25	3.65	5	008600555
T15	25	3.65	5	008600560
T20	25	3.65	5	008600565
T25	25	3.65	5	008600570
T27	25	3.65	5	008600575
T30	25	3.65	5	008600580
T40	25	3.65	5	008600585

860/55

Cliquet réversible porte-embouts



L mm	Ø	CHF	5	10
100	1/4	42.50	3	008600870

860/58

Cliquet porte-embouts à manche rotatif

- L'embout peut être inséré sur les deux côtés pour visser ou dévisser
- Manche bi-matériaux



L mm	Ø mm	A mm	CHF	5	10		
860/58	126	1/4"	27	15	98.00	1	008600884

860/C27

Jeu de 25 embouts pour visseuses, 1 porte-douilles et 1 cliquet réversible en étui de poche



CHF	5	10	
860/C27	116.00	1	008600880

	860/55	100 mm
	860LP	0,5x3-1,0x5,5-1,2x6,5 mm
	860PH	PH1-PH2(x2)-PH3
	860PZ	PZ1-PZ2(x2)-PZ3
	860PE	2-2,5-3-4-5-6 mm
	860TX	T6-T8-T10-T15-T20-T25-T30-T40
	892/0	● 1/4 ■ 1/4

860PHZ/A10

Coffret de 11 pièces



CHF	5	10	
860PHZ/A10	48.50	1	008600910

	860PH	PH1	n.
		PH2	1
		PH3	3
	860PZ	PZ1	1
		PZ2	3
		PZ3	1
	882M1	○ 1/4 ● 1/4	

860PE/A10

Coffret de 11 pièces



860PE/A10 CHF 50.00 1 008600920

	860PE	2 - 2,5 mm	n.
	882M1	3 - 4 - 5 - 6 mm	1
		○ 1/4 ● 1/4	2

860TX/A10

Coffret de 11 pièces



860TX/A10 CHF 51.50 1 008600970

	860TX	T7 - T8 - T9 - T10 - T15 - T20	n.
	882M1	T25 - T27 - T30 - T40	1
		○ 1/4 ● 1/4	

860MIX/A10

Jeu de 10 embouts pour visseuses et 1 porte-douilles magnétique, en étui de poche



860MIX/A10 CHF 48.50 1 008600900

	860LP	0,5x3 - 1x5,5 - 1,2x6,5 mm	n.
	860PH	PH1	1
		PH2	2
		PH3	1
	860PZ	PZ1 - PZ2 - PZ3	1
	882M1	○ 1/4 ● 1/4	

860MIX/A31

Coffret de 31 pièces

Jeu de 31 embouts pour visseuses et 1 porte-douilles magnétique, en étui de poche



860MIX/A31 CHF 114.00 1 008600902

860LP	0,5x3 - 0,6x4,5 - 0,8x5,5 1,0x5,5 - 1,2x6,5 mm
860PE	2 - 2,5 - 3 - 4 - 5 - 6 8 - 10 mm
860PH	PH0 - PH1 - PH2 - PH3 - PH4
860PZ	PZ1 - PZ2 - PZ3 - PZ4
860RTX	T9 - T10 - T15 - T20 T25 - T27 - T30 - T40
882MSR 50	○ 1/4 ● 1/4

860/C38P

Composition de 1 poignée porte-embouts avec cliquet réversible, 27 embouts pour visseuses, 8 douilles 6 pans et 2 accessoires



860/C38P CHF 252.00 1 008600878

860LP	0,6x4,5-0,8x5,5-1,0x5,5-1,2x6,5 mm
860PE	2-2,5-3-4(x2)-5(x2) mm
860PH	PH1(x2)-PH2(x2)-PH3
860PZ	PZ1(x2)-PZ2(x2)-PZ3
860TX	T10-T15-T20-T25-T30-T40
900	5-5,5-6-7-8-9-10-13 mm
892/0	● 1/4 ■ 1/4
892/3	● 1/4 ■ 1/4
855P	240 mm

270x120x45 mm

861LP

Embout pour visseuses pour vis à fente



ISO 2351-1

ISO 1173 C 6,3

SxA mm	L mm	CHF		
0,5x3	25	1.63	10	008610005
0,6x4	25	1.63	10	008610007
0,6x4,5	25	1.63	10	008610010
0,8x5,5	25	1.63	10	008610015
1x5,5	25	1.63	10	008610020
1,2x6,5	25	1.63	10	008610025
1,2x8	25	3.10	10	008610028
1,6x8	25	3.10	10	008610030

861PH

Embout pour visseuses pour vis Phillips®



ISO 2351-2

ISO 1173 C 6,3

PH	L mm	CHF		
0	25	1.60	10	008610200
1	25	1.60	10	008610205
2	25	1.60	10	008610210
2L	50	3.10	10	008610213
3	25	1.60	10	008610215
4	25	4.30	10	008610220

861PH/C

Embout pour visseuses pour vis Phillips®



ISO 2351-2

ISO 1173 C 6,3

PH	L mm	CHF		
0	25	1.22	200	008610250
1	25	1.22	200	008610255
2	25	1.22	200	008610260
2L	50	2.35	100	008610263
3	25	1.22	200	008610265
4	25	3.15	100	008610270

861PZ

Embout pour visseuses pour vis Pozidriv® -Supadriv®



ISO 2351-2

ISO 1173 C 6,3

PZ	L mm	CHF		
1	25	1.60	10	008610300
2	25	1.60	10	008610305
2L	50	3.10	10	008610308
3	25	1.60	10	008610310
4	25	4.30	10	008610315

861PZ/C

Embout pour visseuses
pour vis Pozidriv® -Supadriv®



ISO 2351-2
ISO 1173 C 6,3

PZ	L mm	CHF		
1	25	1.22	200	008610350
2	25	1.22	200	008610355
2L	50	2.35	100	008610358
3	25	1.22	200	008610360
4	25	3.10	100	008610365

861PE

Embout pour visseuses
pour vis 6 pans creux



ISO 2351-3
ISO 1173 C 6,3

mm	L mm	CHF		
2	25	1.72	10	008610100
2,5	25	1.72	10	008610105
3	25	1.72	10	008610110
4	25	1.72	10	008610115
5	25	1.72	10	008610120
6	25	1.72	10	008610125
8	25	2.58	10	008610130
10	25	3.40	10	008610135

861TX

Embout pour visseuses
pour vis Torx®



ISO 1173 C 6,3

⊘	L mm	CHF		
T5	25	2.27	10	008610399
T6	25	2.27	10	008610400
T7	25	2.27	10	008610405
T8	25	2.27	10	008610410
T9	25	2.27	10	008610415
T10	25	1.79	10	008610420
T15	25	1.79	10	008610425
T20	25	1.79	10	008610430
T25	25	1.79	10	008610435
T27	25	1.79	10	008610440
T30	25	1.79	10	008610445
T40	25	1.79	10	008610450

861TX/C

Embout pour visseuses
pour vis Torx®



ISO 1173 C 6,3

⊘	L mm	CHF		
T10	25	1.38	200	008610470
T15	25	1.38	200	008610475
T20	25	1.38	200	008610480
T25	25	1.38	200	008610485
T27	25	1.38	200	008610490
T30	25	1.38	200	008610495
T40	25	1.38	200	008610499

861RTX

Embout pour visseuses
pour vis à Tamper Resistant Torx(R)



ISO 1173 C 6,3

⊘	L mm	CHF		
T6	25	3.35	10	008610537
T7	25	3.35	10	008610538
T8	25	3.35	10	008610540
T9	25	3.35	10	008610500
T10	25	3.35	10	008610505
T15	25	3.35	10	008610510
T20	25	3.35	10	008610515
T25	25	3.35	10	008610520
T27	25	3.35	10	008610525
T30	25	3.35	10	008610530
T40	25	3.35	10	008610535
T45	25	6.50	10	008610539

861RIBE

Embout pour visseuses
pour vis RIBE® multipans



ISO 1173 C 6,3

⊘	L mm	CHF		
M5	25	1.47	10	008610705
M6	25	1.47	10	008610706
M7	25	1.79	10	008610707
M8	25	1.79	10	008610708
M9	25	2.58	10	008610709

861TRW

Embout pour visseuses
pour vis Tri-Wing(R)



ISO 1173 C 6,3

GR	L mm	CHF		
1	25	2.84	10	008610601
2	25	2.84	10	008610602
3	25	2.84	10	008610603
4	25	2.84	10	008610604
5	25	2.84	10	008610605
6	25	4.15	10	008610606

861TQS

Embout pour visseuses
pour vis Torq-Set(R)



ISO 1173 C 6,3

GR	L mm	CHF		
0	25	2.84	10	008610620
1	25	2.84	10	008610621
2	25	2.84	10	008610622
3	25	2.84	10	008610623
4	25	2.84	10	008610624
5	25	2.84	10	008610625
6	25	2.84	10	008610626
8	25	2.84	10	008610628
10	25	2.84	10	008610630

861SP

Embout pour visseuses
pour vis Spanner



ISO 1173 C 6,3

SP	D mm	L mm	CHF		
4	1,5	25	2.35	10	008610650
6	2,4	25	2.35	10	008610653
8	2,8	25	2.35	10	008610656
10	3,3	25	2.35	10	008610658
12	3,9	25	2.35	10	008610660

1483KV-PT/S7



1483KV PT/S7

185

861XZN

Embout pour visseuses
pour vis XZN®



ISO 1173 C 6,3

⊘	L mm	CHF		
M5	25	1.47	10	008610725
M6	25	1.47	10	008610726
M8	25	1.88	10	008610728

861/C61P

Coffret de 61 embouts pour visseuses avec 1 porte-embouts à bague de déverrouillage rapide



861/C61P CHF 217.50 1 008610978

	861LP	0,5x3 - 0,6x4,5 - 0,8x5,5 - 1,0x5,5 1,2x6,5 - 1,2x8 - 1,6x8 mm
	861PE	2 - 2,5 - 3 - 4 - 5 - 6 - 8 - 10 mm
	861PH	PH0 - PH1 - PH2 - PH3
	861PZ	PZ1 - PZ2 - PZ3
	861TX	T6 - T7 - T8 - T9 - T10 - T15 T20 - T25 - T27 - T30 - T40
	861RTX	T9 - T10 - T15 - T20 - T25 T27 - T30 - T40
	861TRW	1 - 2 - 3 - 4 - 5 - 6
	861TQS	0 - 1 - 2 - 3 - 4 - 5 - 6 - 8 - 10
	861SP	4 - 6 - 8 - 10 - 12
	851SR	Ø 1/4"

270x120x45 mm - 975 g

862LP

Embout pour visseuses pour vis à fente



ISO 2351-1

ISO 1173 E 6,3

SxA mm	L mm	CHF	5	10
0,5x3	50	4.65	5	008620005
0,6x4,5	50	4.65	5	008620010
0,8x5,5	50	4.65	5	008620015
1x5,5	50	4.65	5	008620020
1,2x6,5	50	4.65	5	008620025
1,2x8	50	5.75	5	008620030
1,6x8	50	5.75	5	008620035

862PH

Embout pour visseuses pour vis Phillips®



ISO 2351-2

ISO 1173 E 6,3

PH	L mm	CHF	5	10
1	50	4.65	5	008620200
2	50	4.65	5	008620205
3	50	4.65	5	008620210

862PH/L

Embout pour visseuses pour vis Phillips®



ISO 2351-2

ISO 1173 E 6,3

PH	L mm	CHF	5	10
1	70	8.55	5	008620230
2	70	8.55	5	008620232
3	70	8.55	5	008620234

862PH-XL

Embout pour visseuses pour vis Phillips®



ISO 2351-2/ISO 1173 E 6,3

PH	L mm	CHF	5	10
1	100	8.80	5	008620250
2	100	8.80	5	008620252
3	100	8.80	5	008620254

862PZ

Embout pour visseuses pour vis Pozidriv® -Supadriv®



ISO 2351-2

ISO 1173 E 6,3

PZ	L mm	CHF	5	10
1	50	4.80	5	008620300
2	50	4.80	5	008620305
3	50	4.80	5	008620310

862PE

Embout pour visseuses pour vis 6 pans creux



ISO 2351-3

ISO 1173 E 6,3

mm	L mm	CHF	5	10
3	50	4.80	5	008620103
4	50	4.80	5	008620104
5	50	4.80	5	008620105
6	50	4.80	5	008620106
8	50	6.50	5	008620108

862TX

Embout pour visseuses pour vis Torx®



ISO 1173 E 6,3

T	L mm	CHF	5	10
T6	50	6.45	5	008620506
T7	50	6.45	5	008620507
T8	50	6.45	5	008620508
T9	50	6.45	5	008620509
T10	50	6.45	5	008620510
T15	50	6.45	5	008620515
T20	50	6.45	5	008620520
T25	50	6.45	5	008620525
T27	50	6.45	5	008620527
T30	50	6.45	5	008620530
T40	50	6.45	5	008620540

862TX/L

Embout pour visseuses pour vis Torx®



ISO 1173 E 6,3

T	L mm	CHF	5	10
T6	70	6.95	5	008620556
T7	70	6.95	5	008620557
T8	70	6.95	5	008620558
T9	70	6.95	5	008620559
T10	70	6.95	5	008620560
T15	70	6.95	5	008620565
T20	70	6.95	5	008620570
T25	70	6.95	5	008620575
T27	70	6.95	5	008620577
T30	70	6.95	5	008620580
T40	70	6.95	5	008620590

862TX-XL

Embout pour visseuses pour vis Torx®



ISO 1173 E 6,3

T	L mm	CHF	5	10
T9	100	7.65	5	008620659
T10	100	7.65	5	008620660
T15	100	7.65	5	008620665
T20	100	7.65	5	008620670
T25	100	7.65	5	008620675
T27	100	7.65	5	008620677
T30	100	7.65	5	008620680
T40	100	7.65	5	008620690



862F

Embout à douille magnétique pour visseuse



ISO 1173 E 6,3

mm	L mm	Ø mm	CHF		
5,5	65	11	8.75	5	008620405
6	65	11	8.75	5	008620406
7	65	11	8.75	5	008620407
8	65	13	8.75	5	008620408
10	65	15	9.50	5	008620410
12	65	18	10.50	5	008620412
13	65	18	11.10	5	008620413

862F/A7

Jeu de 7 embouts à douille magnétique pour visseuses en étui de poche



862F/A7 CHF 66.50 1 008620950

862F 5,5-6-7-8-10-12-13 mm

862XP/A16

Étui de poche comprenant 16 embouts "impacts"



862XP/A16 CHF 88.00 1 008620960

- PH2(x2)-PH3
- PZ2(x2)-PZ3
- T20-T25(x2)
- T30(x2)-T40(x2)
- Ø 4-5-6 mm

866LP

Embout pour visseuses pour vis à fente



ISO 2351-1
ISO 1173 C 8

SxA mm	L mm	CHF		
1x5,5	41	4.80	10	008660005
1,2x6,5	41	4.80	10	008660010
1,6x8	41	4.80	10	008660015
1,6x10	41	6.50	10	008660020
2x12	41	8.15	10	008660025

866PH

Embout pour visseuses pour vis Phillips®



ISO 2351-2
ISO 1173 C 8

PH	L mm	CHF		
1	32	3.90	10	008660200
2	32	3.90	10	008660205
3	32	3.90	10	008660210
4	38	5.85	10	008660215

866PZ

Embout pour visseuses pour vis Pozidriv® -Supadriv®



ISO 2351-2
ISO 1173 C 8

PZ	L mm	CHF		
1	32	4.10	10	008660300
2	32	4.10	10	008660305
3	32	4.10	10	008660310
4	38	6.10	10	008660315

866PE

Embout pour visseuses pour vis 6 pans creux



ISO 2351-3
ISO 1173 C 8

mm	L mm	CHF		
3	30	3.35	10	008660100
4	30	3.35	10	008660105
5	30	3.35	10	008660110
6	30	3.35	10	008660115
7	30	3.35	10	008660117
8	30	3.35	10	008660120
10	30	4.65	10	008660125
12	30	6.50	10	008660132
14	30	8.35	10	008660134

866TX

Embout pour visseuses pour vis TORX®



ISO 1173 C 8

	L mm	CHF		
T20	30	4.20	10	008660400
T25	30	4.20	10	008660405
T27	30	4.20	10	008660410
T30	30	4.20	10	008660415
T40	30	4.20	10	008660420
T45	30	4.20	10	008660425
T50	30	4.20	10	008660430
T55	30	6.00	10	008660435
T60	30	8.15	10	008660440
T70	30	9.00	10	008660445

866RTX

Embout pour visseuses pour vis à Tamper Resistant Torx(R)



ISO 1173 C 8

	L mm	CHF		
T40	30	4.80	10	008660520
T45	30	4.80	10	008660525
T50	30	4.80	10	008660530
T55	30	6.75	10	008660535
T60	30	8.75	10	008660540
T70	30	10.90	10	008660545

867PE

Embout avec entraînement hexagonal de 10mm pour vis 6 pans creux



mm	L mm	CHF		
4	30	2.20	5	008670104
5	30	2.20	5	008670105
6	30	2.20	5	008670106
7	30	2.20	5	008670107
8	30	2.20	5	008670108
10	30	2.20	5	008670110
12	30	3.25	5	008670112

867PE/L

Embout avec entraînement hexagonal de 10 mm pour vis 6 pans creux série longue



mm	L mm	CHF		
4	75	4.10	5	008670154
5	75	4.10	5	008670155
6	75	4.10	5	008670156
7	75	4.10	5	008670157
8	75	4.10	5	008670158
10	75	4.10	5	008670160
12	75	5.70	5	008670162

Beta

867XZN

Embout avec entraînement hexagonal de 10 mm pour vis XZN®



Ø	L mm	CHF	5	008670204
M4	30	2.75	5	008670204
M5	30	2.75	5	008670205
M6	30	2.75	5	008670206
M8	30	2.75	5	008670208
M10	30	2.75	5	008670210
M12	30	4.10	5	008670212

867XZN/L

Embout avec entraînement hexagonal de 10 mm pour vis XZN(R) - série longue



Ø	L mm	CHF	5	008670255
M5	75	4.45	5	008670255
M6	75	4.45	5	008670256
M8	75	4.45	5	008670258
M10	75	4.45	5	008670260
M12	75	6.10	5	008670262

867TX

Embout avec entraînement hexagonal de 10 mm pour vis Torx®



Ø	L mm	CHF	5	008670400
T20	30	2.20	5	008670400
T25	30	2.20	5	008670405
T30	30	2.20	5	008670410
T40	30	2.20	5	008670415
T45	30	2.20	5	008670420
T50	30	2.20	5	008670425
T55	30	2.20	5	008670430

867TX/L

Embout avec entraînement hexagonal de 10 mm pour vis Torx® série longue



Ø	L mm	CHF	5	008670450
T20	75	3.60	5	008670450
T25	75	3.60	5	008670455
T30	75	3.60	5	008670460
T40	75	3.60	5	008670465
T45	75	3.60	5	008670470
T50	75	3.60	5	008670475
T55	75	3.60	5	008670480

867RTX

Embout avec entraînement hexagonal de 10 mm pour vis Tamper Resistant Torx(R)



Ø	L mm	CHF	5	008670500
T20	30	2.45	5	008670500
T25	30	2.45	5	008670505
T30	30	2.45	5	008670510
T40	30	2.45	5	008670515
T45	30	2.45	5	008670520
T50	30	2.45	5	008670525
T55	30	2.45	5	008670530

867RTX/L

Embout avec entraînement hexagonal de 10 mm pour vis Tamper Resistant Torx® - série longue



Ø	L mm	CHF	5	008670550
T20	75	4.10	5	008670550
T25	75	4.10	5	008670555
T30	75	4.10	5	008670560
T40	75	4.10	5	008670565
T45	75	4.10	5	008670570
T50	75	4.10	5	008670575
T55	75	4.10	5	008670580

867RIBE

Embout pour visseuses pour vis RIBE®



Ø	L mm	CHF	5	008670705
M5	30	2.51	5	008670705
M6	30	2.51	5	008670706
M7	30	2.51	5	008670707
M8	30	2.51	5	008670708
M9	30	2.51	5	008670709
M10	30	2.51	5	008670710
M11	30	3.65	5	008670711
M12	30	3.65	5	008670712
M13	30	3.65	5	008670713

867RIBE/L

Embout pour visseuses pour vis RIBE®



Ø	L mm	CHF	5	008670755
M5	75	4.10	5	008670755
M6	75	4.10	5	008670756
M7	75	4.10	5	008670757
M8	75	4.10	5	008670758
M9	75	4.10	5	008670759
M10	75	4.10	5	008670760
M11	75	5.50	5	008670761
M12	75	5.50	5	008670762
M13	75	5.50	5	008670763

867/...

Douille porte-embouts pour 867



Ø	L mm	Ø	CHF	5	008670600		
867/1	10	3/8"	38	17	7.90	5	008670600
867/2	10	1/2"	38	22	8.85	5	008670601

867/C20

18 embouts pour visseuses pour vis RIBE® avec entraînement hexagonal 10 mm et 2 accessoires



867/C20	CHF	1	008670920
	155.50	1	008670920

	867RIBE	5-6-7-8-9-10-11-12-13 mm
	867RIBE/L	5-6-7-8-9-10-11-12-13 mm
	867/1	
	867/2	
	335x145x60 mm	1,7 kg

867/C38

38 embouts avec entraînement hexagonal de 10 mm et 1 porte-embouts à cardan



867/C38	CHF	1	008670938
	286.00	1	008670938

	852	10 mm
	867PE	4-5-6-7-8-10-12mm
	867PE/L	4-5-6-7-8-10-12mm
	867XZN	M5-M6-M8-M10-M12
	867XZN/L	M5-M6-M8-M10-M12
	867TX	T20-T25-T30-T40-T45-T50-T55
	867TX/L	T20-T25-T30-T40-T45-T50-T55
	882	
	420x185x60 mm	3 kg

867/C52

Coffret de 52 embouts avec entraînement hexagonal de 10 mm et 2 accessoires



867/C52 CHF 177.50 1 008670901

	○ 867PE	4-5-6-7-8-10-12 mm
	○ 867PE/L	4-5-6-7-8-10-12 mm
	○ 867XZN	M5-M6-M8-M10-M12
	○ 867XZN/L	M5-M6-M8-M10-M12
	⊕ 867TX	T20-T25-T30-T40-T45-T50-T55
	⊕ 867TX/L	T20-T25-T30-T40-T45-T50-T55
	⊕ 867RTX	T20-T25-T30-T40-T45-T50-T55
	⊕ 867RTX/L	T20-T25-T30-T40-T45-T50-T55
	867/1	○ 10 mm - □ 3/8"
	867/2	○ 10 mm - □ 1/2"

250x170x70 mm - 2,1 kg

852



852 1/4 79,116

882

Porte-embouts avec anneau de retenue pour visseuses



ISO 1173 E 6,3

L mm 57 1/4 1/4 11 CHF 21.80 5 008820001

882AN

Renvoi d'angle coupleur hexagonal 1/4"

- Pour perceuses électriques avec mandrin de 10 et 13 mm et clés à chocs avec coupleur de 1/4"
- Vitesse max. 3600 tours/mn
- Couple maximum 30 Nm
- Avec porte-embouts à changement rapide
- Rapport de transmission 1:1
- Connexion à l'outil par le biais de l'hexagone 1/4" D6.3



ISO 1173 E 6,3
ISO 1173 C 6,3

L mm 137 1/4 1/4 CHF 94.00 1 008820090

882M1

Porte-embouts magnétique pour visseuses



ISO 1173 E 6,3

L mm 50 1/4 1/4 11 CHF 23.10 5 008820006

882M

Porte-embouts magnétique pour visseuses



ISO 1173 E 6,3

L mm 75 1/4 1/4 11 CHF 28.00 5 008820005

882MSR

Porte-embouts magnétique à bague de verrouillage rapide pour visseuses



ISO 1173 E 6,3

L mm 50 75 1/4 1/4 11 CHF 24.90 29.00 5 008820205 5 008820207

882P

Rallonge porte-embouts magnétique



L mm 80 1/4 1/4 10 CHF 20.30 5 008820080



892

Porte-douille pour visseuses



	■	●	L mm	CHF	5	5
892/0	1/4	1/4	25	7.15	5	008920000
* 892/1	1/4	5,5	50	13.60	5	008920001
* 892/2	3/8	5,5	50	20.20	5	008920002
* 892/3	1/4	1/4	50	13.60	5	008920003
* 892/4	3/8	1/4	50	20.20	5	008920004
892/5	1/4	5/16	75	18.70	5	008920005
892/6	3/8	5/16	75	27.50	5	008920006
892/7	1/2	1/4	75	28.50	5	008920007

* ISO 1173 A 5,5
° ISO 1173 C 6,3

895

Douille porte-embouts pour 861, 862, 866



DIN 7427

	○	□	L mm	∅ mm	CHF	5	5
895/1	1/4	1/4	25,4	12	16.40	5	008950000
895/3	1/4	3/8	29	16,8	19.50	5	008950001
895/4	5/16	3/8	29	16,8	19.50	5	008950002
895/5	1/4	1/2	38	22	19.50	5	008950005
895/6	5/16	1/2	38	22	19.50	5	008950003

897

Tournevis porte-embouts flexible



L mm 280 L1 mm 154 CHF 37.00 2 008970010

897L

Tournevis porte-embouts flexible série longue



L mm 500 L1 mm 380 CHF 42.50 2 008970015

CLIQUETS 9XX/55

Tête compacte



Fonctionne dans les petits espaces avec un angle de reprise de 5°, et équipé de 72 dents



Ne glisse et ne se relâche pas sous tension

- L'appui de la main sur la tête du cliquet ne provoque pas l'inversion et permet toujours le retour libre du cliquet
- Inversion du sens du cliquet pouvant s'effectuer à une main
- Caractéristiques mécaniques exceptionnelles



Charge de travail répartie, 17 dents en prise de contact permanente avec l'engrenage

900

Douille 6 pans



UNI/ISO 2725 DIN 3124

mm	Ø mm	L mm	Ø1 mm	CHF	5	10
3,2	6,6	25	11,8	5.10	10	009000032
4	6,8	25	11,8	5.10	10	009000040
4,5	7,4	25	11,8	5.10	10	009000045
5	8,0	25	11,8	5.10	10	009000050
5,5	8,7	25	11,8	5.10	10	009000055
6	9,3	25	11,8	5.10	10	009000060
7	10,4	25	11,8	5.10	10	009000070
8	11,8	25	12,7	5.10	10	009000080
9	12,7	25	11,8	5.10	10	009000090
10	14,2	25	12,0	5.10	10	009000100
11	15,8	25	12,5	5.10	10	009000110
12	17,2	25	13,5	5.10	10	009000120
13	18,0	25	13,5	5.15	10	009000130
14	20,0	25	15,0	5.20	10	009000140



900/SB13
4-4,5-5-5,5-6-7-8-9
10-11-12-13-14 mm
CHF 90.00 1 009000150

900MC

Douille 6 pans, colorée

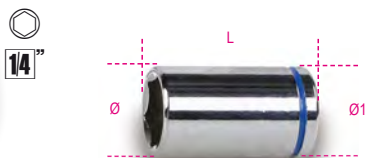

mm	L mm	Ø mm	Ø1 mm	CHF	5	10
4	24,8	6,7	11,8	5.45	5	009002040
5	24,8	8,0	11,8	5.45	5	009002050
6	24,8	9,2	11,8	5.45	5	009002060
7	24,8	10,7	11,8	5.45	5	009002070
8	24,8	11,8	11,8	5.45	5	009002080
9	24,8	12,8	12,8	5.45	5	009002090
10	24,8	14,8	14,8	5.45	5	009002100
11	24,8	15,8	15,8	5.45	5	009002110
12	24,8	16,8	16,8	5.45	5	009002120
13	24,8	17,8	17,8	5.60	5	009002130
14	24,8	19,5	19,5	5.65	5	009002140



900MB

Douille 12 pans



UNI/ISO 2725 DIN 3124

mm	Ø mm	L mm	Ø1 mm	CHF	5	10
4	6,7	22	11,2	9.85	5	009000160
5	7,7	25	11,2	9.85	5	009000161
5,5	8,3	25	11,2	9.85	5	009000162
6	9,0	25	11,2	9.85	5	009000163
7	10,2	25	11,2	9.85	5	009000164
8	11,3	25	12,0	9.85	5	009000165
9	13,0	25	12,0	9.85	5	009000166
10	14,3	25	12,9	9.85	5	009000167
11	16,0	25	14,3	9.85	5	009000168
12	17,4	25	16,0	9.85	5	009000169
13	18,0	25	16,4	10.90	5	009000170
14	19,3	25	17,9	11.50	5	009000171



900MB/SB12
4-5-5,5-6-7-8-9-10
11-12-13-14 mm
CHF 143.00 1 009000179

900L

Douille 6 pans série longue



UNI/ISO 2725 DIN 3124

mm	Ø mm	L mm	Ø1 mm	CHF	5	10
4	6,5	50	12,0	11.90	5	009000181
4,5	7,0	50	12,0	11.90	5	009000182
5	7,5	50	12,0	11.90	5	009000183
5,5	8,5	50	12,0	11.90	5	009000184
6	9,5	50	12,0	11.90	5	009000185
7	10,5	50	12,0	11.90	5	009000186
8	12,0	50	12,0	11.90	5	009000187
9	13,0	50	13,0	11.90	5	009000188
10	14,0	50	14,0	12.30	5	009000189
11	16,0	50	16,0	12.30	5	009000190
12	17,5	50	17,5	12.30	5	009000191
13	17,5	50	17,5	12.30	5	009000192
14	20,0	50	20,0	12.30	5	009000193



900L/SB13
4-4,5-5-5,5-6-7-8-9-10-11-12-13-14 mm
CHF 180.00 1 009000203

900MB/L

Douille 12 pans série longue



UNI/ISO 2725 DIN 3124

mm	Ø mm	L mm	Ø1 mm	CHF		
5	8,0	50	12,0	18.20	3	009000211
6	9,3	50	12,0	18.20	3	009000212
7	10,9	50	12,0	18.20	3	009000213
8	11,6	50	12,0	18.20	3	009000214
9	13,0	50	12,0	18.20	3	009000215
10	14,3	50	12,8	19.40	3	009000216
11	16,0	50	14,2	19.40	3	009000217
12	17,4	50	15,5	19.40	3	009000218
13	18,0	50	16,2	19.60	3	009000219
14	19,0	50	17,1	20.00	3	009000220

900AS

Douille 6 pans



mm	Ø mm	L mm	Ø1 mm	CHF		
5/32	8,8	25	11,9	5.60	5	009000349
3/16	7,7	25	11,9	5.60	5	009000340
7/32	8,8	25	11,9	5.60	5	009000345
1/4	9,6	25	11,9	5.60	5	009000350
9/32	10,2	25	11,9	5.60	5	009000355
5/16	11,3	25	11,9	5.60	5	009000360
11/32	12,7	25	11,6	5.60	5	009000365
3/8	14,0	25	12,9	5.60	5	009000370
7/16	15,3	25	14,5	5.60	5	009000375
1/2	17,5	25	16,4	5.65	5	009000380
9/16	19,0	25	17,9	5.70	5	009000385



		CHF		
900AS/SB11		82.50	1	009000389
3/16-7/32-5/32-1/4-9/32-5/16				
11/32-3/8-7/16-1/2-9/16				

900AS/MB

Douille 12 pans



SAE AS 954E

mm	Ø mm	L mm	Ø1 mm	CHF		
3/16	7,7	22	10,9	10.10	2	009000390
7/32	8,5	22	10,9	10.10	2	009000391
1/4	9,4	22	10,9	10.10	2	009000392
9/32	10,2	22	10,9	10.10	2	009000393
5/16	11,3	22	11,7	10.10	2	009000394
11/32	12,5	22	12,0	10.10	2	009000395
3/8	13,7	22	12,9	10.70	2	009000396

mm	Ø mm	L mm	Ø1 mm	CHF		
7/16	15,6	22	14,3	10.70	2	009000397
1/2	17,2	22	16,4	11.90	2	009000398
9/16	18,8	24	17,9	12.00	2	009000399

900AS/L

Douille 6 pans série longue



SAE AS 954E

mm	Ø mm	L mm	Ø1 mm	CHF		
3/16	7,0	50	12,0	12.40	2	009000301
7/32	8,5	50	12,0	12.40	2	009000303
1/4	9,8	50	12,0	12.40	2	009000305
9/32	10,5	50	12,0	12.40	2	009000307
5/16	12,0	50	12,0	12.40	2	009000309
11/32	13,0	50	13,0	12.40	2	009000311
3/8	14,0	50	14,0	12.40	2	009000313
7/16	16,0	50	16,0	12.40	2	009000315
1/2	17,5	50	17,5	12.40	2	009000317
9/16	20,0	50	20,0	13.30	2	009000319

900AS/MBL

Douille 12 pans série longue



mm	Ø mm	L mm	Ø1 mm	CHF		
5/32	6,8	50	12,0	19.20	2	009000325
3/16	8,0	50	12,0	19.20	2	009000326
7/32	8,5	50	12,0	19.20	2	009000327
1/4	9,8	50	12,0	19.20	2	009000328
9/32	10,9	50	12,0	19.20	2	009000329
5/16	11,6	50	12,0	19.20	2	009000330
11/32	13,0	50	12,0	19.20	2	009000331
3/8	14,3	50	12,8	20.60	2	009000332
7/16	16,0	50	14,2	20.60	2	009000333
1/2	18,0	50	16,2	20.60	2	009000334
9/16	19,0	50	17,1	20.60	2	009000335

900U

Douille multidents

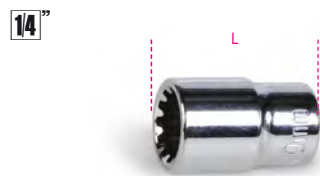

mm	"	Ø mm	Ø1 mm	CHF		
4	5/32	E5	M5	5.35	5	009001702
4,5	3/16	E6		5.35	5	009001703
5	13/64		M6	5.35	5	009001704
5,5	7/32	E7		5.35	5	009001705
6	1/4	E8	M8	5.35	5	009001706
7	9/32			5.35	5	009001707
8	5/16	E10	M10	5.35	5	009001708
9	11/32			5.35	5	009001709
10	3/8	E12	M12	5.35	5	009001710
11	7/16	E14	M14	5.35	5	009001711
12	15/32	E16		5.35	5	009001712
13	1/2		M16	5.40	5	009001713
14	9/16	E18	M18	5.45	5	009001714

14"



		CHF		
900U/SB13		93.00	1	009001750
4-4,5-5-5,5-6-7-8-9				
10-11-12-13-14 mm				

900FTX

Douille pour écrous Torx®

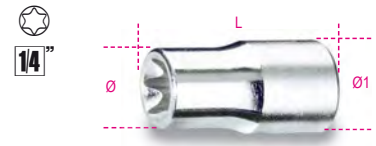

mm	Ø mm	L mm	Ø1 mm	CHF		
E4	5,4	22	11,2	9.45	5	009000404
E5	6,7	22	11,2	9.45	5	009000405
E6	7,7	22	11,2	9.45	5	009000406
E7	8,3	22	11,2	9.45	5	009000407
E8	9,6	22	11,2	9.45	5	009000408
E10	11,3	22	12,0	9.45	5	009000410
E11	12,1	22	12,5	12.90	5	009000411
E12	12,9	23	12,9	12.90	5	009000412
E14	14,0	25	14,0	12.90	5	009000414



		CHF		
900FTX/SB9		113.00	1	009000419
E4-E5-E6-E7-E8				
E10-E11-E12-E14				

900LP

Douille tournevis pour vis à fente

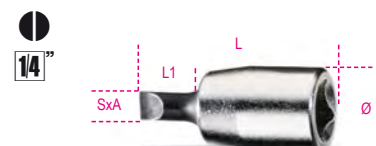

SxA mm	Ø mm	L mm	L1 mm	CHF		
0,8x4	12	28	9	11.40	5	009000605
1x5,5	12	28	9	11.40	5	009000610
1,2x6,5	12	28	9	11.40	5	009000615
1,2x8	13	28	8	11.40	5	009000620
1,6x10	14	28	8	11.40	5	009000625

900MC/LP

Douille tournevis pour vis à fente, colorée

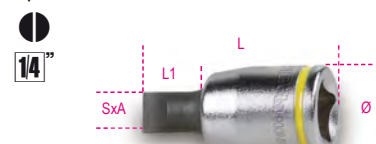

SxA mm	Ø mm	L mm	L1 mm	CHF		
0,8x4	12	28	9	17.90	3	009002605
1,2x6,5	12	28	9	17.90	3	009002615
1,2x8	13	28	8	17.90	3	009002620

900PH

Douille tournevis pour vis Phillips(R)



PH	Ø mm	L mm	L1 mm	CHF	📦	📄
1	12	28	12	12.40	5	009000701
2	12	28	12	12.40	5	009000702
3	12	28	12	12.40	5	009000703
4	13	28	11	12.40	5	009000704



900PH/SB4	CHF	📦	📄
PH1-PH2-PH3-PH4	60.00	1	009000708

900MC/PH

Douille tournevis pour vis Phillips®, colorée



PH	Ø mm	L mm	L1 mm	CHF	📦	📄
1	12	28	12	18.60	3	009002701
2	12	28	12	18.60	3	009002702
3	12	28	12	18.60	3	009002703

900PZ

Douille tournevis pour vis Pozidriv®-Supadriv®



PZ	Ø mm	L mm	CHF	📦	📄
1	12	28	13.00	3	009000711
2	12	28	13.00	3	009000712
3	12	28	13.00	3	009000713

900ME

Douille tournevis pour vis 6 pans creux



mm	Ø mm	L mm	L1 mm	CHF	📦	📄
2,5	12	25	4,5	10.70	5	009000502
3	12	25	5,0	10.70	5	009000503
4	12	25	5,6	10.70	5	009000504
5	12	25	6,3	10.70	5	009000505
6	12	25	7,6	10.70	5	009000506
7	13	25	7,2	10.70	5	009000507
8	13	25	8,0	10.70	5	009000508
10	13	25	8,7	13.30	5	009000510



900ME/SB8	CHF	📦	📄
2,5-3-4-5-6-7-8-10 mm	104.50	1	009000518

900PE/AS

Douille tournevis pour vis 6 pans creux



"	Ø mm	L mm	CHF	📦	📄
1/8	11,9	25	24.40	5	009000521
5/32	11,9	25	24.40	5	009000522
3/16	11,9	25	24.40	5	009000523
7/32	11,9	25	24.40	5	009000524
1/4	11,9	25	24.40	5	009000525
9/32	13,1	25	24.40	5	009000526
5/16	13,1	25	24.40	5	009000527

900PT

Douille tournevis pour vis en étoile à 5 pointes



PT	Ø mm	L mm	L1 mm	CHF	📦	📄
PT10	12	28	12	22.80	5	009000750
PT15	12	28	12	22.80	5	009000755
PT20	12	28	12	22.80	5	009000760
PT25	12	28	12	22.80	5	009000765
PT27	12	28	12	22.80	5	009000767
PT30	12	28	12	22.80	5	009000770

900TX

Douille tournevis pour vis Torx®



TX	Ø mm	L mm	L1 mm	CHF	📦	📄
T6	12	28	12	16.60	5	009000717
T7	12	28	12	16.60	5	009000718
T8	12	28	12	16.70	5	009000719
T9	12	28	12	16.70	5	009000720
T10	12	28	12	16.70	5	009000721
T15	12	28	12	16.70	5	009000722
T20	12	28	12	16.70	5	009000723
T25	12	28	12	16.70	5	009000724
T27	12	28	12	16.70	5	009000725
T30	12	28	12	16.70	5	009000726
T40	12	28	12	16.70	5	009000727



900TX/SB8	CHF	📦	📄
T9-T10-T15-T20 T25-T27-T30-T40	150.00	1	009000730

900MC/TX

Douille tournevis pour vis Torx®, colorée



TX	Ø mm	L mm	L1 mm	CHF	📦	📄
T10	12	28	12	19.20	3	009002721
T15	12	28	12	19.20	3	009002722
T20	12	28	12	19.20	3	009002723
T25	12	28	12	19.20	3	009002724
T27	12	28	12	19.20	3	009002725
T30	12	28	12	19.20	3	009002726
T40	12	28	12	19.20	3	009002727

900/16

Augmentateur carré femelle 1/4" et mâle 3/8"



UNI/ISO 3316 DIN 3123

L	Ø	CHF	📦	📄
28 mm	13,0 mm	8.75	5	009000814

900/...

Rallonge carrés mâle et femelle 1/4"

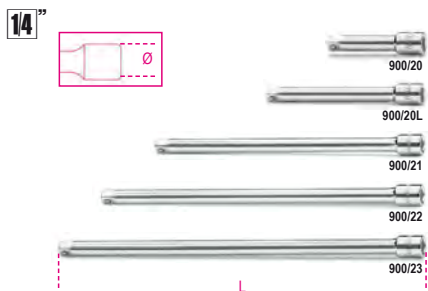

UNI/ISO 3316 DIN 3123

	L mm	Ø mm	CHF		
900/20	50	11,5	11.10	5	009000818
900/20L	100	11,5	11.40	5	009000819
900/21	150	11,5	11.90	5	009000822
900/22	250	11,5	17.50	5	009000823
900/23	350	11,5	21.00	5	009000824

900AN

Rallonge angulaire carrés mâle et femelle 1/4"

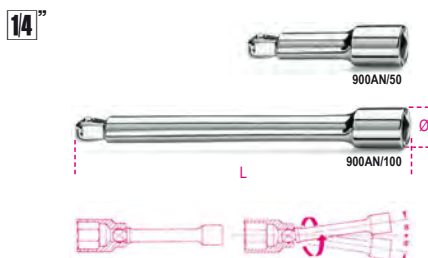

	L mm	Ø mm	CHF		
900AN/50	50	11,5	12.00	3	009000825
900AN/100	100	11,5	13.30	3	009000826

900FL

Rallonge flexible carrés mâle et femelle 1/4"

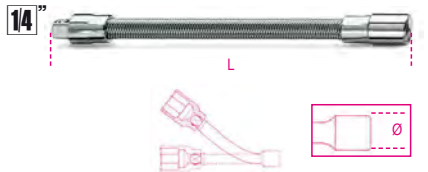

	L mm	Ø mm	CHF		
900FL	150	12	17.70	3	009000828

900/25

Cardan carrés mâle et femelle 1/4"



UNI/ISO 3316 DIN 3123

	L mm	Ø mm	CHF		
900/25	41	12,5	21.60	5	009000830

900BG/30C

Poignée emmanchée carré mâle 1/4"



UNI/ISO 3315 DIN 3122

L mm	L1 mm	CHF		
128	20	10.60	5	009000833

900BG/30

Poignée emmanchée carré mâle 1/4"



UNI/ISO 3315 DIN 3122

L mm	L1 mm	CHF		
176	68	11.10	5	009000834

900/32

Poignée emmanchée flexible carré mâle 1/4"



L mm	L1 mm	CHF		
280	154	25.50	2	009000839

900/35A

Poignée articulée carré mâle 1/4"



UNI/ISO 3315 DIN 3122

L mm	L1 mm	CHF		
148	84	36.50	5	009000840

900M/35

Poignée articulée carré mâle 1/4" avec manche métallique



UNI/ISO 3315
DIN 3122

L mm	CHF		
130	46.50	3	009000845



900/40

Poignée à béquille à cardan carré mâle 1/4"

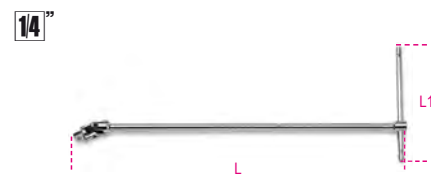

L mm	L1 mm	CHF		
390	145	49.00	3	009000843

900/42

Poignée coulissante carré mâle 1/4"

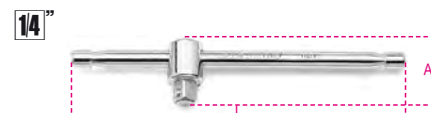

UNI/ISO 3315 DIN 3122

L mm	A mm	CHF		
115	22	12.20	5	009000854

900T/44

Poignée emmanchée coudée carré mâle 1/4"



L mm	L1 mm	CHF		
238	105	18.40	2	009000860

900/55

Cliquet réversible carré mâle 1/4" à 48 dents



UNI/ISO 3315 DIN 3122

L mm	Ø mm	A mm	CHF		
125	25	29	58.00	5	009000870

900/55Z

72



Le cliquet 900/55Z a été développé par le service technique de Beta sur la base d'un nouveau mécanisme à 72 dents, dont 15 dents sont en contact permanent avec l'engrenage.

Ce développement permet une meilleure répartition de la charge de travail et réduit donc l'usure des pièces entraînant un rallongement important de sa durée de vie.



De plus avec sa tête extrêmement compacte et ses 72 dents assurant un angle de reprise ne dépassant pas 5°, lui permet un accès rapide dans les espaces réduits.

La poignée ergonomique bi-matière de Beta permet à la fois une utilisation rapide du cliquet avec une force accrue.

900/55Z

Cliquet réversible carré mâle 1/4" mécanisme à 72 dents

72
1/4"



L	Ø	A	CHF		
mm	mm	mm			
126	25	23	58.00	3	009000882

900M/55

Cliquet réversible carré mâle 1/4" manche métallique

1/4"

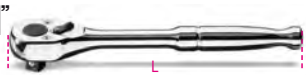

UNI/ISO 3315 DIN 3122			CHF		
L	Ø	A			
mm	mm	mm			
110	22	18	75.00	3	009000905

Voir le tableau après la ref. 928/C8 pour les pièces détachées du mécanisme de la tête de la clé dynamométrique

900/58

Cliquet réversible avec manche rotatif et carré mâle 1/4" mécanisme à 52 dents

- Système d'utilisation avec manche rotatif
- Touche de déverrouillage de la douille
- Système d'inversion à douille sur la tête du cliquet
- Manche bi-matériaux

1/4"

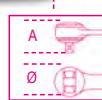

L	Ø	A	CHF		
mm	mm	mm			
126	28	28,5	88.50	2	009000884

900/C39N

Coffret compact composé de 11 douilles 6 pans, 21 embouts et 7 accessoires

1/4"

1/4"



900/C39N	CHF		
	262.00	1	009000947

861LP	0,6x4,5 - 1,2x6,5 - 1,2x8 mm
861PH	PH1-PH2-PH3
861PZ	PZ1-PZ2-PZ3
861PE	2,5-3-4-5-6 mm
861RTX	T10-T15-T20-T25-T27-T30-T40
900	5-5,5-6-7-8-9-10-11-12-13-14 mm
900/20	50 mm
900/20L	100 mm
900/25	
900BG/30C	128 mm
892/0	
895/1	
900/55Z	126 mm

900/C39U

Coffret compact composé de 11 douilles multi empreintes, 21 embouts et 7 accessoires

1/4"

1/4"



900/C39U	CHF		
	265.00	1	009001947

861LP	0,6x4,5 - 1,2x6,5 - 1,2x8 mm
861PH	PH1-PH2-PH3
861PZ	PZ1-PZ2-PZ3
861PE	2,5-3-4-5-6 mm
861RTX	T10-T15-T20-T25-T27-T30-T40
900U	Ø 5-5,5-6-7-8-9-10-11-12-13-14 mm * 3/16-13/64-7/32-1/4-9/32-5/16 11/32-3/8-7/16-15/32-1/2-9/16 Ø E6-E7-E8-E10-E12-E14-E16-E18 Ø M6-M8-M10-M12-M14-M16-M18
900/20	50 mm
900/20L	100 mm
900/25	
900BG/30C	128 mm
892/0	
895/1	
900/55Z	126 mm

900/C11

11 douilles 6 pans, 20 embouts pour visseuses et 8 accessoires

1/4"

1/4"



900/C11	CHF		
	285.00	1	009000971

861LP	0,5x3 - 0,8x5,5 1x5,5 - 1,2x6,5 mm
861PE	3 - 4 - 5 - 6 - 8 mm
861PH	0 - 1 - 2 - 3
861TX	T8 - T10 - T15 - T20 T25 - T30 - T40
895/1	
900	5 - 5,5 - 6 - 7 - 8 - 9 - 10 11 - 12 - 13 - 14 mm
900/16	□ 1/4 - ■ 3/8
900/20	50 mm
900/21	150 mm
900/25	
900BG/30	176 mm
900/42	
900/55	

270x120x45 mm - 1,2 kg

9899 900C11	CHF		
Plateau thermoformé vide	17.20	1	098990132

900/C11Z

11 douilles 6 pans,
20 embouts pour visseuses et 8 accessoires

14"
1/4"



900/C11Z CHF 285.00 1 009000984

	861LP	0,5x3 - 0,8x5,5 - 1x5,5 - 1,2x6,5 mm
	861PE	3 - 4 - 5 - 6 - 8 mm
	861PH	0 - 1 - 2 - 3
	861TX	T8 - T10 - T15 - T20 T25 - T30 - T40
	895/1	
	900	5 - 5,5 - 6 - 7 - 8 - 9 - 10 11 - 12 - 13 - 14 mm
	900/16	□ 1/4 - ■ 3/8
	900/20	50 mm
	900/21	150 mm
	900/25	
	900BG/30	176 mm
	900/42	
	900/55Z	

350x150x50 mm - 1,2 kg

9899 900C11 CHF 17.20 1 098990132
Plateau thermoformé vide

900/C12MR

Coffret métallique avec plateau en mousse compacte comprenant 1 cliquet avec 12 douilles 6 pans, 20 embouts pour visseuses et 7 accessoires

14"
14"



900/C12MR CHF 319.00 1 009000962

	900	4-5-5,5-6-7-8-9-10-11-12-13-14 mm
	900/20	50 mm
	900/21	150 mm
	900/25	
	900/42	115 mm
	900BG/30	128 mm
	900/58	
	895/1	
	861TX	T8-T10-T15-T20-T25-T30-T40
	861PH	PH0-PH1-PH2-PH3
	861LP	0,5-0,8-1-1,2 mm
	861PE	3-4-5-6-8 mm

350x150x50 mm 1,3 kg



900/C12MZ

12 douilles 6 pans,
20 embouts pour visseuses et 7 accessoires
en plateau en mousse compacte

14"
14"



900/C12MZ CHF 288.00 1 009000983

	900	4-5-5,5-6-7-8-9-10-11-12-13-14 mm
	900/20	50 mm
	900/21	150 mm
	900/25	
	900/42	115 mm
	900BG/30	176 mm
	900/55Z	
	895/1	
	861TX	T8-T10-T15-T20-T25-T30-T40
	861PH	PH0-PH1-PH2-PH3
	861LP	0,5x3 - 0,8x5,5 - 1x5,5 - 1,2x6,5 mm
	861PE	3-4-5-6-8 mm

350x150x50 mm - 1,2 kg

900/C13-5

13 douilles 6 pans et 5 accessoires

14"



900/C13-5 CHF 231.00 1 009000953

	900	4 - 4,5 - 5 - 5,5 - 6 - 7 - 8 - 9 10 - 11 - 12 - 13 - 14 mm
	900/21	150 mm
	900/25	
	900BG/30	
	900/42	
	900/55	

270x120x45 mm - 1 kg

9899 900/C13-5 CHF 17.20 1 098990131
Plateau thermoformé vide

900/C13-8

13 douilles 6 pans et 8 accessoires

14"



900/C13-8 CHF 280.00 1 009000954

	900	4 - 4,5 - 5 - 5,5 - 6 - 7 - 8 - 9 10 - 11 - 12 - 13 - 14 mm
	900/16	□ 1/4 - ■ 3/8
	900/20	50 mm
	900/21	150 mm
	900/25	
	900BG/30	
	900/35A	
	900/42	
	900/55	

270x120x45 mm - 1,1 kg

900MB/C19

11 douilles 12 pans et 8 accessoires

14"



900MB/C19 CHF 325.00 1 009000977

	900MB	5 - 5,5 - 6 - 7 - 8 - 9 - 10 - 11 12 - 13 - 14 mm
	900/16	□ 1/4 - ■ 3/8
	900/20	50 mm
	900/21	150 mm
	900/25	
	900BG/30	
	900/35A	
	900/42	
	900/55	

270x120x45 mm - 1,1 kg



900/C24

13 douilles 6 pans, 11 douilles tournevis et 6 accessoires

1/4"



900/C24 CHF 360.00 1 009000956

- 900 4 - 4,5 - 5 - 5,5 - 6 - 7 - 8 - 9
10 - 11 - 12 - 13 - 14 mm
- 900LP 0,8x4 - 1,2x6,5 - 1,2x8 mm
- ⊕ 900PH PH1 - PH2 - PH3
- 900ME 3 - 4 - 5 - 6 - 8 mm
- 900/20 50 mm
- 900/21 150 mm
- 900/25
- 900BG/30
- 900/42
- ⊗ 900/55

270x120x45 mm - 1,1 kg

900MB/C28

11 douilles 12 pans, 11 douilles tournevis et 6 accessoires

1/4"



900MB/C28 CHF 405.00 1 009000979

- 900MB 5 - 5,5 - 6 - 7 - 8 - 9 - 10 - 11
12 - 13 - 14 mm
- 900LP 0,8x4 - 1,2x6,5 - 1,2x8 mm
- ⊕ 900PH PH1 - PH2 - PH3
- 900ME 3 - 4 - 5 - 6 - 8 mm
- 900/20 50 mm
- 900/21 150 mm
- 900/25
- 900BG/30
- 900/42
- ⊗ 900/55

270x120x45 mm - 1,1 kg

900MC/C24

11 douilles 6 pans,
13 douilles tournevis colorées et 6 accessoires

1/4"



900MC/C24 CHF 474.00 1 009002960

- 900MC 4 - 5 - 6 - 7 - 8 - 9
10 - 11 - 12 - 13 - 14 mm
- ⊕ 900MC/PH PH1 - PH2 - PH3
- ⊗ 900MC/TX T10 - T15 - T20 - T25 - T27 - T30
- T40
- 900MC/LP 0,8x4 - 1,2x6,5 - 1,2x8 mm
- 900/20 50 mm
- 900/21 150 mm
- 900/25
- 900BG/30
- 900/42
- ⊗ 900/55

270x120x45 mm - 1 kg

900MC/C32

11 douilles colorées, 20 embouts colorés pour visseuses et 7 accessoires

1/4"



900MC/C32 CHF 299.00 1 009002963

- 900MC 4 - 5 - 6 - 7 - 8 - 9 - 10 - 11 - 12 - 13
- 14 mm
- 860LP 0,5x3 - 0,8x5,5 -
1,0x5,5 - 1,2x6,5 mm
- ⊕ 860PH 0 - 1 - 2 - 3
- 860PE 3 - 4 - 5 - 6 - 8 mm
- ⊗ 860TX T8 - T10 - T15 - T20 - T25 - T30 - T40
- 895/1
- 900/20
- 900/21
- 900/25
- 900BG/30
- 900/42
- ⊗ 900/55

270x120x45 mm - 1,2 kg

900U/C12M

Coffret 1/4 composé de 12 douilles multi empreintes, 20 embouts et 7 accessoires, dans un plateau en mousse.

1/4"

1/4"



900U/C12M CHF 291.00 1 009001792

- 900U ○ 4-5-5,5-6-7-8-9-10-11-12-13-14 mm
" 5/32-3/16-13/64-7/32-1/4-9/32-5/16
11/32-3/8-7/16-15/32-1/2-9/16
⊗ E5-E6-E7-E8-E10-E12-E14-E16-E18
○ M5-M6-M8-M10-M12-M14-M16-M18
- 900/20 50 mm
- 900/21 150 mm
- 900/25
- 900/42 115 mm
- 900BG/30 176 mm
- ⊗ 900/55 125 mm
- 895/1 ○ 1/4 - □ 1/4
- 861LP 0,5x3 - 0,8x5,5 - 1,0x5,5 - 1,2x6,5 mm
- 861PE 3-4-5-6-8 mm
- PH0-PH1-PH2-PH3
- ⊗ 861TX T8-T10-T15-T20-T25-T30-T40

350x150x50 mm - 1,2 kg

 **Beta**

900AS/C10 - /MB-C17

10 douilles et 7 accessoires

14"



900AS/C10 CHF 262.00 1 009000961

	○ 900AS	3/16 - 7/32 - 1/4 - 9/32 - 5/16 11/32 - 3/8 - 7/16 - 1/2 - 9/16
	900/20	50 mm
	900/21	150 mm
	900/25	
	900BG/30	
	900/35A	
	900/42	
	900/55	

≡ 270x120x45 mm - 1,1 kg

900AS/MB-C17 CHF 311.00 1 009000981

	○ 900AS/MB	3/16 - 7/32 - 1/4 - 9/32 - 5/16 11/32 - 3/8 - 7/16 - 1/2 - 9/16
	900/20	50 mm
	900/21	150 mm
	900/25	
	900BG/30	
	900/35A	
	900/42	
	900/55	

≡ 270x120x45 mm - 1,1 kg

900AS/C17-MBM

10 douilles 12 pans
et 7 accessoires
pour maintenance aéronautique

14"



900AS/C17-MBM CHF 337.00 1 009000982

	○ 900AS/MB	3/16 - 7/32 - 1/4 - 9/32 - 5/16 11/32 - 3/8 - 7/16 - 1/2 - 9/16
	900/20	50 mm
	900/21	150 mm
	900/25	
	900BG/30	
	900M/35	
	900/42	
	900M/55	

≡ 270x120x45 mm - 1,2 kg

900/C11HR

Coffret métallique avec plateau thermoformé
rigide comprenant 1 cliquet avec 11 douilles 6
pans, 20 embouts pour visseuses et 7
accessoires

• cliquet avec branche rotative

14"

14"



900/C11HR CHF 316.00 1 009000980

	● 861LP	0,5x3-0,8x5,5-1x5,5-1,2x6,5 mm
	⊕ 861PH	PH0-PH1-PH2-PH3
	○ 861PE	3-4-5-6-8 mm
	⊗ 861TX	T8-T10-T15-T20-T25-T30-T40
	895/1	
	○ 900	5-5,5-6-7-8-9-10-11-12-13-14 mm
	900/16	□ 1/4 - ■ 3/8
	900/20	50 mm
	900/21	150 mm
	900/25	
	900/42	
	900BG/30	
	900/58	

≡ 350x150x50 mm - 1,3 kg

902R/C6

Coffret de 6 augmentateurs / réducteurs
pour douilles



902R/C6 CHF 139.50 1 009020814

	900/16	□ 1/4 - ■ 3/8
	910/15	□ 3/8 - ■ 1/4
	910/16	□ 3/8 - ■ 1/2
	920/15	□ 1/2 - ■ 3/8
	920/16	□ 1/2 - ■ 3/4
	928/15	□ 3/4 - ■ 1/2

≡ 170x100x35 mm - 600 g

902A/C22

Coffret métallique comprenant 7 douilles 6
pans, 28 embouts, 1 porte-embouts à poignée
en T avec cliquet réversible et 1 accessoire

14"

12"



902A/C22 CHF 454.00 1 009020807

	○ 900	5-5,5-6-7-8-9-10-11-12-13 mm
	900/20	50 mm
	900/25	
	14" 900/55	
	○ 920A	10-13-14-15-17-18-19 22-24-27-30-32 mm
	920/21	125 mm
	920/25	
	12" 920/55	

≡ 420x185x60 mm - 3,5 kg

9899 902A/C22 CHF 17.20 1 098990133

Plateau thermoformé vide

910A

Douille 6 pans

38"



UNI/ISO 2725 DIN 3124

6 mm	Ø mm	L mm	Ø1 mm	CHF	
6	9,5	28	16,7	7.95	5 009100006
7	10,7	28	16,7	7.95	5 009100007
8	12,1	28	16,7	7.95	5 009100008
9	13,2	28	16,7	7.95	5 009100009
10	14,6	29	16,7	7.95	5 009100010
11	15,8	29	16,7	7.95	5 009100011
12	17,2	30	17,7	8.25	5 009100012
13	18,4	31	17,0	8.25	5 009100013
14	19,7	32	17,5	8.25	5 009100014
15	20,9	32	18,0	8.25	5 009100015
16	22,2	33	18,5	9.25	5 009100016
17	23,2	33	19,0	9.25	5 009100017
18	24,7	34	20,0	9.25	5 009100018
19	25,8	35	21,0	9.25	5 009100019
20	27,2	35	22,0	9.85	5 009100020
21	28,2	36	23,0	9.85	5 009100021
22	29,7	37	24,0	10.20	5 009100022

38"



910A/5B17 CHF 177.50 1 009100030

6-7-8-9-10-11-12
13-14-15-16-17
18-19-20-21-22 mm

910B

Douille 12 pans



UNI/ISO 2725 DIN 3124

mm	Ø	L	Ø1	CHF	🔧	📄
6	9,5	28	16,7	7.95	5	009100106
7	10,7	28	16,7	7.95	5	009100107
8	12,1	28	16,7	7.95	5	009100108
9	13,2	28	16,7	7.95	5	009100109
10	14,6	29	16,7	7.95	5	009100110
11	15,8	29	16,7	7.95	5	009100111
12	17,2	30	17,7	8.25	5	009100112
13	18,4	31	17,0	8.25	5	009100113
14	19,7	32	17,5	8.25	5	009100114
15	20,9	32	18,0	8.25	5	009100115
16	22,2	33	18,5	9.25	5	009100116
17	23,2	33	19,0	9.25	5	009100117
18	24,7	34	20,0	9.25	5	009100118
19	25,8	35	21,0	9.25	5	009100119
20	27,2	35	22,0	9.85	5	009100120
21	28,2	36	23,0	9.85	5	009100121
22	29,7	37	24,0	10.20	5	009100122



910B/SB17		CHF	🔧	📄
6-7-8-9-10-11-12	177.50	1	009100130	
13-14-15-16-17				
18-19-20-21-22 mm				

910AL

Douille 6 pans série longue



UNI/ISO 2725 DIN 3124

mm	Ø	L	Ø1	CHF	🔧	📄
8	12,0	55	17	17.00	3	009100158
9	13,0	55	17	17.00	3	009100159
10	14,5	55	17	17.00	3	009100160
11	16,0	55	17	17.00	3	009100161
12	17,0	55	17	17.00	3	009100162
13	18,0	55	17	18.60	3	009100163
14	20,0	55	18	18.60	3	009100164
15	21,0	55	20	18.60	3	009100165
16	22,0	55	20	18.60	3	009100166
17	23,5	55	22	18.60	3	009100167
18	24,5	55	23	20.30	2	009100168
19	25,0	55	24	20.30	2	009100169
21	27,0	65	26	21.80	2	009100171
22	29,0	65	28	21.80	2	009100172



910AL/SB14		CHF	🔧	📄
8-9-10-11-12-13-14	288.00	1	009100174	
15-16-17-18-19-21-22 mm				

910BL

Douille 12 pans série longue



UNI/ISO 2725 DIN 3124

mm	Ø	L	Ø1	CHF	🔧	📄
8	12,0	55	17	17.00	3	009100308
9	13,0	55	17	17.00	3	009100309
10	14,5	55	17	17.00	3	009100310
11	16,0	55	17	17.00	3	009100311
12	17,0	55	17	17.00	3	009100312
13	18,0	55	17	18.60	3	009100313
14	20,0	55	18	18.60	3	009100314
15	21,0	55	20	18.60	3	009100315
16	22,0	55	20	18.60	3	009100316
17	23,5	55	22	18.60	3	009100317
18	24,5	55	23	20.30	2	009100318
19	25,0	55	24	20.30	2	009100319
21	27,0	65	26	21.80	2	009100321
22	29,0	65	28	21.80	2	009100322



910BL/SB14		CHF	🔧	📄
8-9-10-11-12-13	288.00	1	009100340	
14-15-16-17-18				
19-21-22 mm				

910B/SN

Douille 12 pans à cardan



mm	Ø	L	Ø1	CHF	🔧	📄
10	14,5	48,5	19	44.00	2	009100230
11	15,8	49,5	19	44.00	2	009100231
12	17,0	50,0	19	44.00	2	009100232
13	18,3	51,0	19	44.00	2	009100233
14	19,5	51,0	19	49.00	2	009100234
15	20,8	53,5	19	49.00	2	009100235
16	22,0	53,5	19	49.00	2	009100236
17	23,3	54,5	19	49.00	2	009100237
18	24,5	54,5	19	49.00	2	009100238
19	25,8	56,5	19	49.00	2	009100239

910A/AS

Douille 6 pans



"	Ø	L	Ø1	CHF	🔧	📄
1/4	10,3	26	17,3	9.50	5	009100276
5/16	11,9	26	17,3	9.50	5	009100278
11/32	13,3	26	17,3	9.50	5	009100279
3/8	13,9	26	17,3	9.50	5	009100280
7/16	15,8	26	17,3	9.50	5	009100281
1/2	17,9	26	17,3	9.75	5	009100283
9/16	19,5	27	18,5	9.75	5	009100284
19/32	20,6	27	19,5	9.75	5	009100285
5/8	21,9	28	20,0	10.50	5	009100286
11/16	24,6	30	22,5	10.50	5	009100287
3/4	25,9	30	23,5	10.50	5	009100289
13/16	27,9	32	26,0	11.90	5	009100291
7/8	29,6	32	26,5	12.30	5	009100292



910A-AS/SB13		CHF	🔧	📄
1/4-5/16-11/32-3/8-7/16	156.00	1	009100295	
1/2-9/16-19/32-5/8-11/16				
3/4-13/16-7/8				

910AS

Douille 12 pans



"	Ø	L	Ø1	CHF	🔧	📄
1/4	9,5	28	16,7	9.50	5	009100201
5/16	12,1	28	16,7	9.50	5	009100202
11/32	13,2	28	16,7	9.50	5	009100203
3/8	14,6	29	16,7	9.50	5	009100204
7/16	15,8	29	16,7	9.50	5	009100205
1/2	18,4	31	17,0	9.75	5	009100206
9/16	19,7	32	17,5	9.75	5	009100207
19/32	20,9	32	18,0	9.75	5	009100208
5/8	22,2	33	18,5	10.50	5	009100209
11/16	24,7	34	20,0	10.50	5	009100210
3/4	25,8	35	21,0	10.50	5	009100211
13/16	28,2	36	23,0	11.90	5	009100212
7/8	29,7	37	24,0	12.30	5	009100213



910AS/SB13		CHF	🔧	📄
1/4-5/16-11/32-3/8-7/16	156.00	1	009100215	
1/2-9/16-19/32-5/8-11/16				
3/4-13/16-7/8				

910AS/L

Douille 12 pans série longue

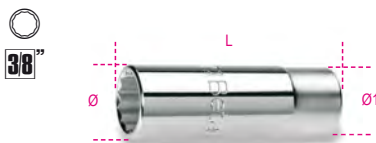

"	Ø mm	L mm	Ø1 mm	CHF		
1/4	10	55	17	21.50	3	009100350
5/16	12	55	17	21.50	3	009100351
3/8	14	55	17	21.50	3	009100352
7/16	16	55	17	21.50	3	009100353
1/2	18	55	17	23.80	3	009100354
9/16	20	55	18	23.80	3	009100355
19/32	21	55	20	24.40	3	009100356
5/8	22	55	20	24.40	3	009100357
11/16	23	55	22	24.40	3	009100359
3/4	25	55	24	26.00	3	009100360
13/16	27	65	26	30.00	3	009100362
7/8	29	65	28	30.00	3	009100363



		CHF		
910ASL/SB12		316.00	1	009100365
1/4-5/16-3/8-7/16				
1/2-9/16-19/32-5/8-11/16				
3/4-13/16-7/8				

910AS/SN

Douille 12 pans à cardan



* SAE AS 954E

"	Ø mm	L mm	Ø1 mm	CHF		
* 3/8	14,0	48,0	19	48.50	2	009100260
* 7/16	15,8	51,0	19	48.50	2	009100261
* 1/2	18,3	51,0	19	48.50	2	009100262
* 9/16	19,5	51,0	19	49.00	2	009100263
* 5/8	22,0	53,5	19	49.00	2	009100264
11/16	24,5	54,5	19	52.00	2	009100265
3/4	25,8	56,5	19	52.00	2	009100266

910FTX

Douille pour écrous Torx®



"	Ø mm	L mm	Ø1 mm	CHF		
E4	6,2	26	17,3	11.40	5	009100404
E5	7,0	26	17,3	11.40	5	009100405
E6	8,3	26	17,3	11.40	5	009100406
E7	8,9	26	17,3	11.40	5	009100407
E8	9,9	26	17,3	11.40	5	009100408
E10	12,0	26	17,3	11.40	5	009100410
E11	13,3	26	17,3	11.40	5	009100411
E12	14,5	26	17,3	11.40	5	009100412
E14	15,8	26	17,3	11.40	5	009100414
E16	18,0	26	17,3	11.40	5	009100416
E18	19,5	26	18,5	12.50	3	009100418
E20	21,9	26	20,0	12.50	3	009100420



		CHF		
910FTX/SB9		120.00	1	009100430
E4-E5-E6-E7-E8				
E10-E12-14-E16				

910FTX/L

Douille pour écrous à empreinte Torx®, série longue



"	Ø mm	L mm	Ø1 mm	CHF		
E4	6,2	55	17,3	25.50	3	009100440
E5	7,0	55	17,3	25.50	3	009100441
E6	8,3	55	17,3	25.50	3	009100442
E7	8,9	55	17,3	25.50	3	009100443
E8	9,9	55	17,3	25.50	3	009100444
E10	12,0	55	17,3	25.50	3	009100445



		CHF		
910FTX-L/SB6		167.50	1	009100449
E4-E5-E6				
E7-E8-E10				

910FTX/XL

Douille pour vis Torx®, série extra longue



"	Ø mm	L mm	Ø1 mm	CHF		
E6	8,0	200	18	23.10	2	009100766
E7	8,0	200	18	23.10	2	009100767
E8	10,0	200	18	23.10	2	009100768
E10	14,0	200	18	23.10	2	009100770
E11	14,0	200	18	23.10	2	009100771
E12	14,0	200	18	23.10	2	009100772

"	Ø mm	L mm	Ø1 mm	CHF		
E14	17,0	200	18	25.00	2	009100774
E16	18,6	200	18	25.00	2	009100776
E18	21,5	200	18	26.50	2	009100778
E20	21,5	200	18	26.50	2	009100780

910FTX-XL/C10

Jeu de 10 douilles pour écrous à empreinte Torx®, série longue, en coffret plastique



		CHF		
910FTX-XL-C10		242.00	1	009100976
E6-E7-E8-E10-E11-				
E12-E14-E16-E18-E20				

255x195x62 mm - 2,3 kg

910LP

Douille tournevis pour vis à fente

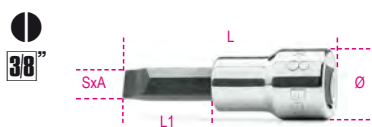

SxA mm	Ø mm	L mm	L1 mm	CHF		
1x5,5	18,5	54	24	20.10	2	009100452
1,2x6,5	18,5	54	24	20.10	2	009100453
1,2x8	18,5	54	24	20.10	2	009100454
1,6x9	18,5	54	24	20.10	2	009100456

910PH

Douille tournevis pour vis Phillips®



PH	Ø mm	L mm	L1 mm	CHF		
1	18,5	48	18	18.70	2	009100471
2	18,5	48	18	18.70	2	009100472
3	18,5	48	18	18.70	2	009100473
4	18,5	48	18	18.70	2	009100474



		CHF		
910PH/SB4		85.50	1	009100478
PH1-PH2-PH3-PH4				



910PE

Douille tournevis pour vis 6 pans creux



DIN 7422

mm	Ø mm	L mm	L1 mm	CHF	🔧	📄
3	18,5	50	20	16.40	5	009100490
4	18,5	50	20	16.40	5	009100492
5	18,5	50	20	16.40	5	009100494
6	18,5	50	20	16.40	5	009100496
7	18,5	50	20	16.40	5	009100497
8	18,5	50	20	16.40	5	009100498
9	18,5	50	20	16.40	5	009100499
10	18,5	50	20	16.40	5	009100500



910PE/SB7		CHF	🔧	📄
3-4-5-6-7-8-10 mm		129.50	1	009100503

910BP

Douille tournevis à tête sphérique pour vis 6 pans creux



mm	L mm	L1 mm	CHF	🔧	📄
4L	92	62	19.50	3	009100584
5L	92	62	19.50	3	009100585
6L	92	62	19.50	3	009100586
7L	92	62	19.50	3	009100587
8L	92	62	19.50	3	009100588
10L	132	102	21.10	3	009100590



910BP/SB6L		CHF	🔧	📄
4L-5L-6L-7L-8L-10L mm		132.00	1	009100596

910ME

Douille tournevis pour vis 6 pans creux



mm	Ø mm	L mm	L1 mm	CHF	🔧	📄
4	18	62	15	19.60	5	009100504
5	18	62	15	19.60	5	009100505
6	18	62	15	19.60	5	009100506
7	18	62	15	20.00	5	009100507
8	19	62	15	20.00	5	009100508
10	20	62	15	20.00	5	009100510
12	20	62	15	20.00	5	009100512



910ME/SB5		CHF	🔧	📄
4-5-6-8-10 mm		111.00	1	009100515

910PE/AS

Douille tournevis pour vis 6 pans creux



"	Ø mm	L mm	L1 mm	CHF	🔧	📄
1/8	18,5	50	20	28.00	2	009100531
5/32	18,5	50	20	28.00	2	009100532
3/16	18,5	50	20	28.00	2	009100533
7/32	18,5	50	20	28.00	2	009100534
1/4	18,5	50	20	28.00	2	009100535
5/16	18,5	50	20	28.00	2	009100536
3/8	18,5	50	20	31.00	2	009100537

910PT

Douille tournevis pour vis en étoile à 5 points



"	Ø mm	L mm	L1 mm	CHF	🔧	📄
PT40	20	50	20	26.00	3	009100540
PT45	20	50	20	26.50	3	009100545
PT50	20	50	20	31.50	3	009100550



910PT/SB8		CHF	🔧	📄
PT10-PT15-PT20-PT25 PT30-PT40-PT45-PT50		214.50	1	009100558

910TX

Douille tournevis pour vis Torx®



"	Ø mm	L mm	L1 mm	CHF	🔧	📄
T15	18,5	50	20	21.50	5	009100519
T20	18,5	50	20	21.50	5	009100520
T25	18,5	50	20	21.50	5	009100521
T27	18,5	50	20	21.50	5	009100522
T30	18,5	50	20	21.50	5	009100523
T40	18,5	50	20	21.50	5	009100524
T45	18,5	50	20	21.50	3	009100525
T50	18,5	50	20	21.50	3	009100526



910TX/SB6		CHF	🔧	📄
T15-T20-T25 T27-T30-T40		142.00	1	009100530

910XZN

Douille tournevis pour vis XZN®



"	L mm	CHF	🔧	📄
M4	50	23.10	3	009100559
M5	50	23.10	3	009100560
M6	50	23.10	3	009100561
M8	50	23.10	3	009100563
M10	50	24.40	3	009100565

910CF

Clé à fourche à patte de coq avec carré femelle 3/8"



"	A mm	L mm	CHF	🔧	📄
10	21,3	32,3	13.90	2	009100135
11	23,1	34,3	13.90	2	009100136
12	25,5	36,2	15.60	2	009100137
13	26,9	37,4	15.60	2	009100138
14	30,2	40,0	16.60	2	009100139
15	33,3	41,3	17.40	2	009100140
16	33,3	41,3	18.90	2	009100141
17	38,1	46,5	21.80	2	009100142
18	38,1	46,5	21.80	2	009100143
19	39,6	48,0	23.80	2	009100144



910CF/SB10		CHF	🔧	📄
10-11-12-13-14-15 16-17-18-19 mm		199.00	1	009100147

910/15

Réducteur carré femelle 3/8" et mâle 1/4"



UNI/ISO 3316 DIN 3123

L mm	Ø mm	CHF	🔧	📄
30	17,0	12.00	5	009100810



Toujours appliquer la force de serrage régulièrement et progressivement afin d'éviter la rupture et de se protéger contre un possible accident.

910/16

Augmentateur carré femelle 3/8" et mâle 1/2"



UNI/ISO 3316 DIN 3123

L mm	Ø mm	CHF	3	5
32	18,0	12.50	009100814	

910/20 - 910/21 - 910/22

Rallonge carrés mâle et femelle 3/8"

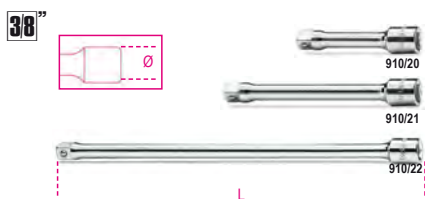

UNI/ISO 3316 DIN 3123

	L mm	Ø mm	CHF	3	5
910/20	75	17	10.30	009100820	
910/21	125	17	14.90	009100822	
910/22	250	17	19.60	009100826	

910AN

Rallonge angulaire carrés mâle et femelle 3/8"

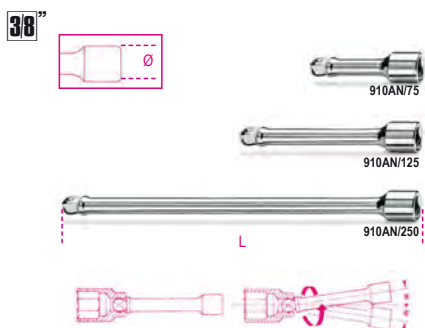

	L mm	Ø mm	CHF	3	5
910AN/75	75	17	14.60	009100827	
910AN/125	125	17	18.20	009100828	
910AN/250	250	17	27.00	009100829	

910/25

Cardan carrés mâle et femelle 3/8"



UNI/ISO 3316 DIN 3123

L mm	Ø mm	CHF	3	5
54,6	19	27.00	009100830	

910M/35

Poignée articulée carré mâle 3/8" avec manche métallique



UNI/ISO 3315 DIN 3122

L mm	CHF	3	5
250	74.50	009100839	

910/36A

Poignée articulée carré mâle 3/8"



UNI/ISO 3315 DIN 3122

L mm	L1 mm	CHF	3	5
255	154	52.00	009100845	

910/40

Poignée à béquille à cardan carré mâle 3/8"



L mm	L1 mm	CHF	3	5
420	175	56.00	009100850	

910/42

Poignée coulissante carré mâle 3/8"

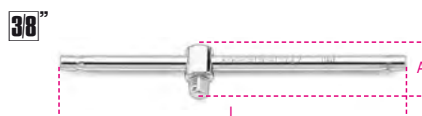

UNI/ISO 3315 DIN 3122

L mm	A mm	CHF	3	5
210	30,5	17.70	009100854	

910/46

Vibrequin carré mâle 3/8"

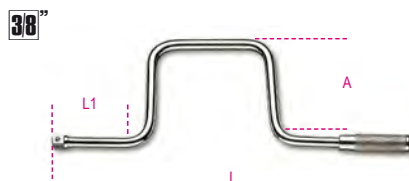

UNI/ISO 3315 DIN 3122

L mm	L1 mm	A mm	CHF	1	5
315	80	115	34.50	009100862	

910/55

Cliquet réversible carré mâle 3/8" à 72 dents



UNI/ISO 3315 DIN 3122

L mm	Ø mm	A mm	CHF	3	5
200	30	33	63.00	009100882	

910/55Q

Cliquet réversible carré mâle 3/8" à 48 dents



UNI/ISO 3315 DIN 3122

L mm	Ø mm	A mm	CHF	3	5
200	30	33	63.00	009100885	

Voir le tableau après la ref. 928/C8 pour les pièces détachées du mécanisme de la tête de la clé dynamométrique

910M/55

Cliquet réversible carré mâle 3/8" avec manche métallique



DIN 3122 - UNI ISO 3315

L mm	Ø mm	A mm	CHF	2	5
178	30	26	87.00	009100875	



910M/56

Cliquet réversible à cardan carré mâle 3/8" avec manche métallique



L mm	Ø mm	A mm	CHF	1	009100887
265	31	29	118.50	2	009100887

910/58

Cliquet réversible avec manche rotatif et carré mâle 3/8" mécanisme à 52 dents

- Système d'utilisation avec manche rotatif
- Touche de déverrouillage de la douille
- Système d'inversion à douille sur la tête du cliquet
- Manche bi-matières



L mm	Ø mm	A mm	CHF	1	009100884
222	37	38,5	97.50	1	009100884

910.../C10

10 douilles 6 pans et 2 accessoires



910A/C10	CHF	1	009100909
	204.00	1	009100909

910A	6 - 7 - 8 - 10 - 11 - 12 13 - 14 - 17 - 19 mm
910/21	125 mm
910/55	

270x120x45 mm - 1,3 kg

910B/C10	CHF	1	009100910
	204.00	1	009100910

910B	6 - 7 - 8 - 10 - 11 - 12 13 - 14 - 17 - 19 mm
910/21	125 mm
910/55	

270x120x45 mm - 1,3 kg

910A/C16...

16 douilles 6 pans et 5 accessoires



910A/C16	CHF	1	009100936
	330.00	1	009100936

910A	6 - 7 - 8 - 9 - 10 - 11 - 12 - 13 14 - 15 - 16 - 17 - 18 - 19 21 - 22 mm
910/21	125 mm
910/22	250 mm
910/25	
910/42	
910/55	

335x145x60 mm - 2,3 kg

9899 910C16	CHF	1	098990134
	17.20	1	098990134

Plateau thermoformé vide

910A/C16Q	CHF	1	009100932
	330.00	1	009100932

910A	6 - 7 - 8 - 9 - 10 - 11 - 12 - 13 14 - 15 - 16 - 17 - 18 - 19 21 - 22 mm
910/21	125 mm
910/22	250 mm
910/25	
910/42	
910/55Q	

335x145x60 mm - 2,3 kg

9899 910C16	CHF	1	098990134
	17.20	1	098990134

Plateau thermoformé vide

910B/C16...

16 douilles 6 pans et 5 accessoires



910B/C16	CHF	1	009100937
	330.00	1	009100937

910B	6 - 7 - 8 - 9 - 10 - 11 - 12 - 13 14 - 15 - 16 - 17 - 18 - 19 21 - 22 mm
910/21	125 mm
910/22	250 mm
910/25	
910/42	
910/55	

335x145x60 mm - 2,3 kg

9899 910C16	CHF	1	098990134
	17.20	1	098990134

Plateau thermoformé vide

910B/C16Q	CHF	1	009100933
910B	6 - 7 - 8 - 9 - 10 - 11 - 12 - 13 14 - 15 - 16 - 17 - 18 - 19 21 - 22 mm		
910/21	125 mm		
910/22	250 mm		
910/25			
910/42			
910/55Q			

335x145x60 mm - 2,3 kg

9899 910C16	CHF	1	098990134
	17.20	1	098990134

Plateau thermoformé vide

910A/C17

17 douilles 6 pans et 9 accessoires



910A/C17	CHF	1	009100938
	494.00	1	009100938

910A	6 - 7 - 8 - 9 - 10 - 11 - 12 - 13 14 - 15 - 16 - 17 - 18 - 19 - 20 21 - 22 mm
910/15	□ 3/8 - ■ 1/4
910/16	□ 3/8 - ■ 1/2
910/21	125 mm
910/22	250 mm
910/25	
910/36A	
910/42	
910/46	
910/55	

420x280x60 mm - 4,0 kg



910.../C29

17 douilles, 12 douilles tournevis
et 5 accessoires

38"



910A/C29 CHF 565.00 1 009100944

	910A	6 - 7 - 8 - 9 - 10 - 11 - 12 - 13 14 - 15 - 16 - 17 - 18 - 19 - 20 21 - 22 mm
	910LP	1x5,5 - 1,2x6,5 - 1,2x8 mm
	910PH	PH1 - PH2 - PH3
	910PE	3 - 4 - 5 - 6 - 8 - 10 mm
	910/21	125 mm
	910/22	250 mm
	910/25	
	910/42	
	910/55	

420x185x60 mm - 3,5 kg

910B/C29 CHF 565.00 1 009100945

	910B	6 - 7 - 8 - 9 - 10 - 11 - 12 - 13 14 - 15 - 16 - 17 - 18 - 19 - 20 21 - 22 mm
	910LP	1x5,5 - 1,2x6,5 - 1,2x8 mm
	910PH	PH1 - PH2 - PH3
	910PE	3 - 4 - 5 - 6 - 8 - 10 mm
	910/21	125 mm
	910/22	250 mm
	910/25	
	910/42	
	910/55	

420x185x60 mm - 3,5 kg

910AS/C13...

13 douilles 12 pans et 5 accessoires

38"



910AS/C13 CHF 334.00 1 009100925

	910AS	1/4 - 5/16 - 11/32 - 3/8 - 7/16 1/2 - 9/16 - 19/32 - 5/8 - 11/16 3/4 - 13/16 - 7/8
	910/21	125 mm
	910/22	250 mm
	910/42	
	910/25	
	910/55	

335x145x60 mm - 2,3 kg

910AS/MBM-C18

13 douilles 12 pans et 5 accessoires
pour maintenance aéronautique

38"



910AS/MBM-C18 CHF 347.00 1 009100926

	910AS	1/4 - 5/16 - 11/32 - 3/8 - 7/16 1/2 - 9/16 - 19/32 - 5/8 - 11/16 3/4 - 13/16 - 7/8
	910/21	125 mm
	910/22	250 mm
	910/25	
	910/42	
	910M/55	

335x145x60 mm - 2,5 kg

910A/C16HR

16 douilles 6 pans et 5 accessoires

• cliquet avec branche rotative

38"



910A/C16HR CHF 363.00 1 009100935

	910A	6 - 7 - 8 - 9 - 10 - 11 - 12 - 13 14 - 15 - 16 - 17 - 18 - 19 21 - 22 mm
	910/21	125 mm
	910/22	250 mm
	910/25	
	910/42	210 mm
	910/58	

335x145x60 mm - 2,4 kg



920A

Douille 6 pans

12"



UNI/ISO 2725 DIN 3124

mm	Ø mm	L mm	Ø1 mm	CHF		
8	12,4	38	21,7	8.05	10	009200008
9	13,5	38	21,7	8.05	10	009200009
10	14,9	38	21,7	8.05	10	009200010
11	16,1	38	21,7	8.05	10	009200011
12	17,5	38	21,7	8.05	10	009200012
13	18,7	38	21,7	8.35	10	009200013
14	20,1	38	21,7	8.35	10	009200014
15	21,5	38	22,5	8.35	10	009200015
16	22,7	38	23,7	9.35	10	009200016
17	24,1	38	23,1	9.35	10	009200017
18	25,3	39	24,0	9.35	10	009200018
19	26,6	39	24,0	9.35	10	009200019
20	27,8	40	25,0	10.20	5	009200020
21	28,8	40	25,0	10.20	5	009200021
22	29,9	41	26,0	10.20	5	009200022
23	30,8	42	26,0	11.90	5	009200023
24	32,2	43	27,0	11.90	5	009200024
25	33,2	44	27,0	11.90	5	009200025
26	34,7	45	28,0	12.30	5	009200026
27	36,2	46	29,0	12.30	5	009200027
28	37,2	47	30,0	12.30	5	009200028
29	38,6	48	31,0	12.80	5	009200029
30	40,2	48	32,0	12.80	5	009200030
32	42,3	49	34,0	13.50	5	009200032

12"



920A/SB13 CHF 141.50 1 009200040
10-11-12-13-14-15-16
17-18-19-20-21-22 mm

12"



920A/SB8 CHF 115.50 1 009200042
23-24-25-26-27-28-30-32 mm

920MC

Douille 6 pans, colorée

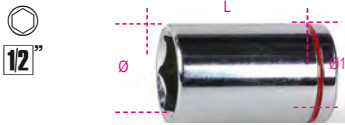

mm	Ø mm	L mm	Ø1 mm	CHF	Icon	Icon
8	13,2	38	22	8.75	5	009202008
10	15,3	38	22	8.75	5	009202010
11	16,5	38	22	8.75	5	009202011
12	17,8	38	22	8.75	5	009202012
13	19,0	38	22	9.20	5	009202013
14	20,3	38	22	9.20	5	009202014
15	21,6	38	22	9.20	5	009202015
16	23,0	38	23	10.20	5	009202016
17	23,9	38	24	10.20	5	009202017
18	25,0	38	25	10.20	5	009202018
19	26,5	38	24	10.20	5	009202019
21	28,8	38	27	11.10	3	009202021
22	29,9	40	28	11.10	3	009202022
24	32,8	40	30	12.90	3	009202024

920B

Douille 12 pans

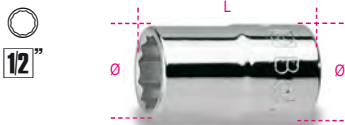

UNI/ISO 2725 DIN 3124

mm	Ø mm	L mm	Ø1 mm	CHF	Icon	Icon
8	12,4	38	21,7	8.05	10	009200108
9	13,5	38	21,7	8.05	10	009200109
10	14,9	38	21,7	8.05	10	009200110
11	16,1	38	21,7	8.05	10	009200111
12	17,5	38	21,7	8.05	10	009200112
13	18,7	38	21,7	8.35	10	009200113
14	20,1	38	21,7	8.35	10	009200114
15	21,5	38	22,5	8.35	10	009200115
16	22,7	38	23,7	9.35	10	009200116
17	24,1	38	23,1	9.35	10	009200117
18	25,3	39	24,0	9.35	10	009200118
19	26,6	39	24,0	9.35	10	009200119
20	27,8	40	25,0	10.20	5	009200120
21	28,8	40	25,0	10.20	5	009200121
22	29,9	41	26,0	10.20	5	009200122
23	30,8	42	26,0	11.90	5	009200123
24	32,2	43	27,0	11.90	5	009200124
25	33,2	44	27,0	11.90	5	009200125
26	34,7	45	28,0	12.30	5	009200126
27	36,2	46	29,0	12.30	5	009200127
28	37,2	47	30,0	12.30	5	009200128
29	38,6	48	31,0	12.80	5	009200129
30	40,2	48	32,0	12.80	5	009200130
32	42,3	49	33,9	13.50	5	009200132



920B/SB13
10-11-12-13-14-15-16
17-18-19-20-21-22 mm



920B/SB8
23-24-25-26-27
28-30-32 mm

920AL

Douille 6 pans série longue 1/2



UNI/ISO 2725 DIN 3124

mm	Ø mm	L mm	Ø1 mm	CHF	Icon	Icon
10	14,7	77	21	22.00	5	009200626
12	17,8	77	21	22.00	5	009200627
13	19,0	77	22	22.00	5	009200628
14	20,3	77	22	22.00	5	009200629
15	21,5	77	22	22.00	5	009200630
16	22,8	77	22	23.60	5	009200631
17	24,0	77	23	23.60	5	009200632
18	25,0	77	24	24.80	5	009200633
19	26,5	77	25	24.80	5	009200634
21	29,0	77	27	27.50	5	009200635
22	30,0	77	28	27.50	5	009200636
23	31,5	77	29	27.50	5	009200637
24	32,8	77	30	31.50	5	009200638
27	36,5	77	33	33.00	3	009200639
30	40,0	77	36	39.50	3	009200640
32	42,8	77	38	40.50	3	009200641
36	48,0	77	41	65.00	3	009200642



920AL/SB11
10-12-13-14-15-16
17-18-19-21-22 mm

920BL

Douille 12 pans série longue



UNI/ISO 2725 DIN 3124

mm	Ø mm	L mm	Ø1 mm	CHF	Icon	Icon
10	14,7	77	21	22.00	5	009200310
12	17,8	77	21	22.00	5	009200312
13	19,0	77	22	22.00	5	009200313
14	20,3	77	22	22.00	5	009200314
15	21,5	77	22	22.00	5	009200315
16	22,8	77	22	23.60	5	009200316
17	24,0	77	23	23.60	5	009200317
18	25,0	77	24	24.80	5	009200318
19	26,5	77	25	24.80	5	009200319
21	29,0	77	27	27.50	5	009200321
22	30,0	77	28	27.50	5	009200322
23	31,5	77	29	27.50	5	009200323
24	32,8	77	30	31.50	5	009200324
27	36,5	77	33	33.00	3	009200327
30	40,0	77	36	39.50	3	009200330
32	42,8	77	38	40.50	3	009200332
36	48,0	77	41	65.00	3	009200336



920BL/SB11
10-12-13-14-15-16-17-18
19-21-22 mm

920A/AS

Douille 6 pans



"	Ø mm	L mm	Ø1 mm	CHF	Icon	Icon
3/8	14,6	37	21	9.45	2	009200270
7/16	16,5	37	21	9.45	3	009200272
1/2	19,0	37	22	9.75	3	009200273
9/16	20,3	37	22	9.75	3	009200274
19/32	21,0	37	22	10.50	3	009200275
5/8	22,8	37	22	10.50	3	009200276
11/16	25,0	37	24	10.80	3	009200277
3/4	26,5	38	25	10.80	3	009200279
25/32	28,0	38	26	12.10	3	009200280
13/16	29,0	38	27	12.10	3	009200281
7/8	30,0	40	28	12.10	3	009200282
15/16	32,8	42	30	12.90	3	009200284
1	35,0	42	32	12.90	3	009200285
1.1/16	36,5	43	33	14.10	2	009200287
1.1/8	39,0	43	35	14.60	2	009200289
1.3/16	41,0	46	36	15.80	2	009200290
1.1/4	42,8	46	38	16.00	2	009200292



920A-AS/SB11
3/8-7/16-1/2-9/16-5/8
11/16-3/4-13/16-7/8
15/16-1

920AS

Douille 12 pans



"	Ø mm	L mm	Ø1 mm	CHF	Icon	Icon
3/8	14,9	38	21,7	9.45	3	009200201
7/16	16,1	38	21,7	9.45	3	009200202
1/2	18,7	38	21,7	9.75	3	009200203
9/16	20,1	38	21,7	9.75	3	009200204
5/8	22,7	38	22,5	10.50	3	009200206
19/32	21,5	38	23,7	10.50	3	009200207
11/16	25,3	39	24,0	10.80	3	009200208
3/4	26,6	39	24,0	10.80	3	009200209
25/32	27,8	40	25,0	12.10	3	009200210
13/16	28,8	40	25,0	12.10	3	009200211
7/8	29,9	41	26,0	12.10	3	009200212
15/16	32,2	43	27,0	12.90	3	009200214
1	34,2	45	28,0	12.90	3	009200216
1.1/16	36,2	46	29,0	14.10	2	009200217
1.1/8	38,6	48	31,0	14.60	2	009200218
1.3/16	40,2	48	32,0	15.80	2	009200219
1.1/4	42,3	49	33,5	16.00	2	009200220



920AS/SB11
3/8-7/16-1/2-9/16-5/8
11/16-3/4-13/16-7/8
15/16-1

920AS/L

Douille 12 pans série longue



"	Ø mm	L mm	Ø1 mm	CHF		
1/2	19,0	77	22	30.00	2	009200352
9/16	20,3	77	22	30.00	2	009200353
5/8	22,8	77	22	30.00	2	009200355
11/16	25,0	77	24	32.00	2	009200357
3/4	26,5	77	25	33.00	2	009200358
13/16	29,0	77	27	39.00	2	009200360
7/8	30,0	77	28	39.00	2	009200361
15/16	32,8	77	30	40.50	2	009200362
1	35,0	77	32	41.50	2	009200363
1.1/16	36,5	77	33,0	45.00	2	009200364
1.1/8	37,8	77	34	46.50	2	009200365



920ASL/SB11		CHF		
1/2-9/16-5/8-11/16		429.00	1	009200369
3/4-13/16-7/8-15/16				
1-1.1/8-1.1/16				

920U

Douille multi-empainte



mm	"	Ø	Ø1	L mm	CHF		
10	3/8	E12	M12	38	8.45	5	009201710
11	7/16	E14	M14	38	8.45	5	009201711
12	15/32	E16		38	8.45	5	009201712
13	1/2		M16	38	8.85	5	009201713
14	9/16	E18	M18	38	8.85	5	009201714
15	19/32			38	8.85	5	009201715
16	5/8	E20		38	9.80	5	009201716
17				38	9.80	5	009201717
18		E22		38	9.80	5	009201718
19	3/4	E24		38	9.80	5	009201719
20	25/32			38	10.90	3	009201720
21				38	10.90	3	009201721
22	7/8			38	10.90	3	009201722
24	15/16			38	12.40	3	009201724
27	1.1/16			42	13.00	3	009201727
30	1.1/8			44	13.80	3	009201730
32	1.1/4			44	14.30	3	009201732



920U/SB13		CHF		
10-11-12-13-14-15-16		148.00	1	009201740
17-18-19-20-21-22 mm				



920U/SB4		CHF		
24-27-30-32 mm		64.00	1	009201744

920FTX

Douille pour écrous Torx®

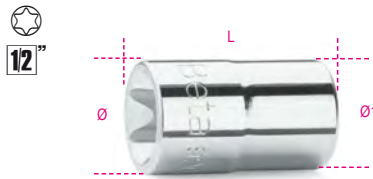

Ø mm	L mm	Ø1 mm	CHF			
E10	13,2	36	21	13.30	5	009200380
E12	15,0	37	21	13.30	5	009200381
E14	16,3	37	21	13.30	5	009200382
E16	18,8	37	22	13.30	5	009200383
E18	20,4	37	22	13.30	5	009200384
E20	22,9	37	22	14.50	5	009200385
E22	25,0	37	24	16.70	3	009200387
E24	26,5	40	25	19.00	3	009200388



920FTX/SB6		CHF		
E10-E12-E14		94.00	1	009200390
E16-E18-E20				



920FTX/C8		CHF		
E10-E12-E14-E16		159.50	1	009200391
E18-E20-E22-E24				

270X120X45 mm - 1 kg

920FTX/L

Douille pour écrous Torx®, série longue



Ø mm	L mm	Ø1 mm	CHF			
E10	13,2	77	21,0	28.00	5	009200400
E12	15,0	77	21,0	28.00	5	009200401
E14	16,3	77	21,0	28.00	5	009200402
E16	18,8	77	21,8	28.00	3	009200403
E18	20,4	77	21,8	28.00	3	009200404
E20	22,9	77	22,0	28.00	3	009200405



920FTX-LSB6		CHF		
E10-E12-E14		181.00	1	009200409
E16-E18-E20				

920LP

Douille tournevis pour vis à fente

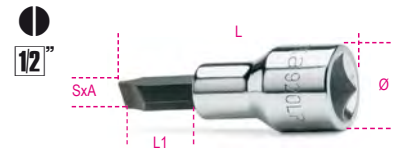

SxA mm	Ø mm	L mm	L1 mm	CHF		
1x5,5	22,5	62	24	21.70	3	009200452
1,2x6,5	22,5	62	24	21.70	3	009200453
1,2x8	22,5	62	24	21.70	3	009200454
1,6x9	22,5	62	24	21.70	3	009200456
2x12	22,5	62	24	21.70	3	009200458

920PH

Douille tournevis pour vis Phillips®



PH	Ø mm	L mm	L1 mm	CHF		
1	22,5	56	18	19.10	3	009200471
2	22,5	56	18	19.10	3	009200472
3	22,5	56	18	19.10	3	009200473
4	22,5	56	18	19.10	3	009200474



920PH/SB4		CHF		
PH1-PH2-PH3-PH4		87.00	1	009200479

920LH/SB7

Douille tournevis pour vis Phillips®



920LH/SB7		CHF		
		158.50	1	009200478
920LP	1,2x6,5 - 1,2x8			
	1,6x9 - 2x12 mm			
920PH	PH2 - PH3 - PH4			

920PE

Douille tournevis pour vis 6 pans creux

12"

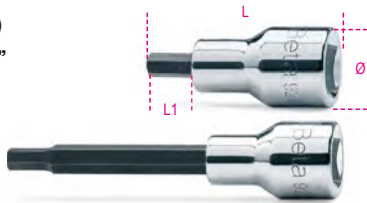

DIN 7422

mm	Ø mm	L mm	L1 mm	CHF	Icon
3	22,5	58	20	17.40	5 009200410
4	22,5	58	20	17.40	5 009200412
5	22,5	58	20	17.40	5 009200414
5L	22,5	100	62	19.00	5 009200415
6	22,5	58	20	17.40	5 009200417
6L	22,5	100	62	19.00	5 009200418
7	22,5	58	20	17.40	5 009200420
7L	22,5	100	62	19.00	5 009200421
8	22,5	58	20	17.40	5 009200423
8L	22,5	100	62	19.00	5 009200424
9	22,5	58	20	17.40	5 009200425
9L	22,5	140	102	20.00	5 009200426
10	22,5	58	20	17.40	5 009200428
10L	22,5	140	102	20.00	5 009200429
12	23,0	58	20	20.20	5 009200432
12L	22,5	140	102	23.10	5 009200433
14	23,0	58	20	20.20	5 009200434
14L	22,5	140	102	23.10	5 009200435
17	29,5	60	22	24.70	5 009200437
19	29,5	60	22	24.70	5 009200439

12"



920PE/SB9
4-5-6-8-10 mm
5L-6L-8L-10L mm
CHF 181.50 1 009200441

12"



920PE/C10
4-5-6-7-8-10
12-14-17-19 mm
Icon 270X120X45 mm - 1,5 kg
CHF 237.00 1 009200443

9899 920PE/C10
Plateau thermoformé vide
CHF 17.20 1 098990135

920PE/AS

Douille tournevis pour vis 6 pans creux

12"



"	Ø mm	L mm	L1 mm	CHF	Icon
1/8	22,5	58	20	20.30	2 009200460
3/16	22,5	58	20	20.30	2 009200461
1/4	22,5	58	20	20.30	2 009200463
3/8	22,5	58	20	20.30	2 009200464
1/2	22,5	60	20	22.20	2 009200465
3/4	22,5	60	20	23.80	1 009200468

12"



920PE-AS/SB6
1/8-3/16-1/4-3/8-1/2-3/4
CHF 140.50 1 009200469

920BP

Douille tournevis à tête sphérique pour vis 6 pans creux

12"

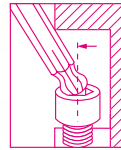
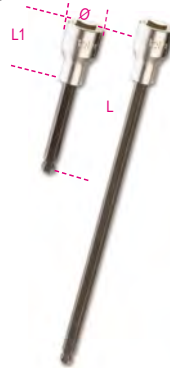

mm	Ø mm	L mm	L1 mm	CHF	Icon
5L	22,5	100	62	21.80	5 009200490
5XL	22,5	240	202	28.00	1 009200495
6L	22,5	100	62	21.80	5 009200491
6XL	22,5	240	202	28.00	1 009200496
7L	22,5	100	62	21.80	5 009200492
8L	22,5	100	62	21.80	5 009200493
8XL	22,5	240	202	28.00	1 009200497
10L	22,5	140	102	23.80	5 009200494

12"



920BP/SB8
5L-6L-7L-8L-10L mm
5XL-6XL-8XL mm
CHF 212.00 1 009200500

920ME

Douille tournevis pour vis 6 pans creux

12"



mm	Ø mm	L mm	L1 mm	CHF	Icon
5	21	75	15,5	20.30	5 009200505
6	21	75	15,5	20.30	5 009200506
7	21	75	15,5	20.30	5 009200507
8	21	75	15,5	20.30	5 009200508
10	23	75	15,5	21.20	5 009200510
12	24	75	15,5	24.40	5 009200512
14	24	75	15,5	25.00	5 009200514
17	24	75	15,5	25.00	5 009200517

12"



920ME/SB7
5-6-8-10-12-14-17 mm
CHF 171.50 1 009200519

12"



920ME/C7
5-6-8-10-12-14-17 mm
Icon 250X100X35 mm - 1,4 kg
CHF 194.00 1 009200518

920TX

Douille tournevis pour vis Torx®

12"



mm	Ø mm	L mm	L1 mm	CHF	Icon
T20	22,5	58	20	21.20	5 009200520
T20L	22,5	120	82	27.00	3 009200530
T25	22,5	58	20	21.20	5 009200521
T25L	22,5	120	82	27.00	3 009200531
T27	22,5	58	20	21.20	5 009200522
T27L	22,5	120	82	27.00	3 009200533
T30	22,5	58	20	21.20	5 009200523
T30L	22,5	120	82	27.00	3 009200534
T40	22,5	58	20	21.20	5 009200524
T40L	22,5	120	82	27.00	3 009200535
T45	22,5	58	20	21.20	5 009200525
T45L	22,5	120	82	27.00	3 009200537
T50	22,5	58	20	21.20	5 009200526
T50L	23,0	140	102	27.00	3 009200538
T55	23,0	58	20	28.50	3 009200527
T55L	23,0	140	102	38.50	3 009200539
T60	23,0	58	20	28.50	3 009200528
T60L	23,0	140	102	38.50	3 009200540
T70L	23,0	120	82	38.50	3 009200541

12"



920TX/SB9
T20-T25-T27-T30
T40-T45-T50-T55-T60
CHF 223.00 1 009200532

12"



920TX-L/SB10
T20L-T25L-T27L-T30L-T40L-
T45L-T50L-T55L-T60L-T70L
CHF 325.00 1 009200545

12"



920TX/C9
T20-T25-T27-T30-T40
T45-T50-T55-T60
Icon 270X120X45 mm - 1,2 kg
CHF 248.00 1 009200546

9899 920TX/C9
Plateau thermoformé vide
CHF 17.20 1 098990136

920RTX

Douille tournevis pour vis
Tampér Résistant Torx®



Ø mm	L mm	L1 mm	CHF	5	10
T20	22,5	58	22.70	5	009200370
T25	22,5	58	22.70	5	009200371
T27	22,5	58	22.70	5	009200372
T30	22,5	58	22.70	5	009200373
T40	22,5	58	22.70	5	009200374



CHF	5	10
920RTX/SB5	125.00	1 009200378

T20-T25-T27-T30-T40

920XZN

Douille tournevis pour vis XZN®

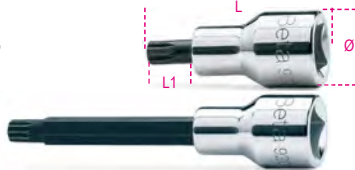

DIN 2324

Ø mm	L mm	L1 mm	CHF	3	5
M4	22,5	58	22.80	3	009200559
M5	22,5	58	22.80	3	009200560
M6	22,5	58	22.80	3	009200561
M6L	22,5	100	26.00	3	009200562
M8	22,5	58	22.80	3	009200563
M8L	22,5	100	26.00	3	009200564
M9	22,5	58	22.80	3	009200582
M9L	22,5	100	26.00	3	009200583
M10	22,5	58	23.10	3	009200565
M10L	22,5	100	26.00	3	009200566
M12	22,5	58	23.80	3	009200568
M12L	22,5	100	26.50	3	009200569
M14	23,0	58	23.80	3	009200571
M14L	23,0	100	26.50	3	009200572
M16	23,0	58	29.50	3	009200573
M18	23,0	58	30.00	3	009200574



CHF	5	10
920XZN/SB7	176.50	1 009200579

M4-M5-M6-M8
M10-M12-M14



CHF	5	10
920XZN/SB12	324.00	1 009200577

M5-M6-M8-M10-M12
M14-M16-M6L-M8L
M10L-M12L-M14L



CHF	5	10
920XZN-L/S5	131.50	1 009200578

M6L-M8L-M10L
M12L-M14L

920ES

Douille pour vis à 6 cannelures



UNI 9326

Ø mm	Ø mm	L mm	L1 mm	CHF	5	10
7	(6R)	58	20	31.50	5	009200587
7XL	(6R)	240	202	44.50	1	009200607
9	(8R)	58	20	31.50	5	009200589
9XL	(8R)	240	202	44.50	1	009200609
10	(8S)	58	20	31.50	5	009200590
10XL	(8S)	240	202	44.50	1	009200610
11	(10R)	58	20	31.50	5	009200591
11XL	(10R)	240	202	44.50	1	009200611
12L	(10S)	100	62	36.00	3	009200592
12XL	(10S)	240	202	49.00	1	009200612
14L	(12S)	100	62	36.00	3	009200594
14XL	(12S)	240	202	49.00	1	009200614
16L	(14R)	100	62	36.00	3	009200596
16XL	(14R)	240	202	49.00	1	009200616



CHF	5	10
920ES/SB7	249.00	1 009200598

7-9-10-11-12L-14L-16L



CHF	5	10
920ES-XL/SB7	341.00	1 009200618

7XL-9XL-10XL-11XL
12XL-14XL-16XL

PM 1/2-Q5



PM 1/2-Q5	72.560
-----------	--------

920/15

Réducteur carré femelle 1/2"
et mâle 3/8"



UNI/ISO 3316 DIN 3123

L mm	1/2"	3/8"	Ø mm	CHF	5	10
42			22,0	13.60	5	009200810



Toujours appliquer la force de serrage
régulièrement et progressivement
afin d'éviter la rupture et de se protéger
contre un possible accident.

920/16

Augmentateur carré femelle 1/2"
et mâle 3/4"



UNI/ISO 3316 DIN 3123

L mm	1/2"	3/4"	Ø mm	CHF	5	10
46			26	17.90	5	009200814

920/20+920/23

Rallonge carrés mâle et femelle 1/2"



UNI/ISO 3316 DIN 3123

L mm	Ø mm	CHF	5	10
920/20	75	22	16.60	5 009200818
920/21	125	22	20.30	5 009200822
920/22	255	22	23.10	5 009200826
920/23	375	22	31.00	2 009200827

920AN

Rallonge angulaire carrés mâle
et femelle 1/2"

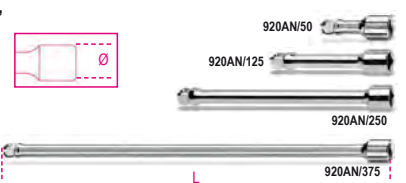

L mm	Ø mm	CHF	5	10
920AN/50	50	22	17.90	5 009200833
920AN/125	125	22	24.60	5 009200834
920AN/250	250	22	34.50	3 009200835
920AN/375	375	22	46.00	3 009200836

920/25

Cardan carrés mâle et femelle 1/2"

12"



UNI/ISO 3316 DIN 3123

L mm	Ø mm	CHF		
75	27	32.00	5	009200830

920/35A

Poignée articulée carré mâle 1/2"

12"



UNI/ISO 3315 DIN 3122

L mm	L1 mm	CHF		
285	160	64.50	3	009200846

920M/35

Poignée articulée carré mâle 1/2"
avec manche métallique

12"



UNI/ISO 3315 DIN 3122

L mm	CHF		
380	92.50	2	009200845

920M/35L

Poignée articulée carré mâle 1/2"
avec manche métallique, série longue

12"



L
mm

600	CHF		
	139.50	1	009200843



Toujours appliquer la force de serrage
régulièrement et progressivement
afin d'éviter la rupture et de se protéger
contre un possible accident.

920/36A

Poignée articulée carré mâle 1/2"

12"



UNI/ISO 3315 DIN 3122

L mm	L1 mm	CHF		
408	283	72.50	2	009200847

920/38

Poignée articulée extensible, carré mâle 1/2"

12"



L mm	L max mm	CHF		
262	402	109.50	1	009200839

920/40

Poignée à béquille à cardan
carré mâle 1/2"

12"



L mm	L1 mm	CHF		
490	230	75.50	2	009200850

920/42

Poignée coulissante carré mâle 1/2"

12"

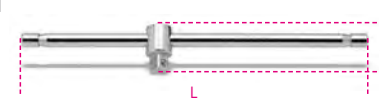

L mm	A mm	CHF		
305	42	22.80	5	009200854

920/44

Poignée coudée carré mâle 1/2"

12"



L mm	L1 mm	CHF		
230	60	33.50	3	009200858

920/46

Vilebrequin carré mâle 1/2"

12"

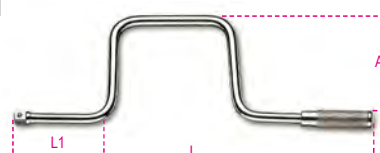

L mm	L1 mm	A mm	CHF	
385	110	160	41.50	1
				009200862

920/50

Cliquet réversible à glissière
carré mâle 1/2" à 72 dents

72

12"



UNI/ISO 3315 DIN 3122

L mm	Ø mm	A mm	CHF	
275	40	42	72.00	3
				009200871

920/50F

Cliquet avec carré femelle 1/2"
à 72 dents

72

12"

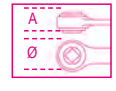

UNI/ISO 3315 DIN 3122

L mm	Ø mm	A mm	CHF	
275	40	27	66.50	2
				009200889

920/55

Cliquet réversible carré mâle 1/2"
à 72 dents

72

12"

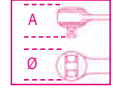

UNI/ISO 3315 DIN 3122

L mm	Ø mm	A mm	CHF	
275	40	43	77.00	3
				009200882

920/55Q

Cliquet réversible carré mâle 1/2"
à 48 dents

48

12"

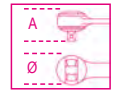

UNI/ISO 3315 DIN 3122

L mm	Ø mm	A mm	CHF	
275	40	43	77.00	3
				009200885

920/55X

Cliquet réversible carré mâle 1/2"
à 72 dents

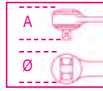

UNI/ISO 3315 DIN 3122

L	Ø	A	CHF		
mm	mm	mm			
200	30	33	65.50	3	009200895

920/55LC

Cliquet réversible carré mâle 1/2"
à 72 dents
avec système de verrouillage

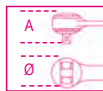

UNI/ISO 3315 DIN 3122

L	Ø	A	CHF		
mm	mm	mm			
275	40	43	89.00	2	009200896

920M/55

Cliquet réversible carré mâle 1/2"
avec manche métallique

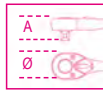

L	Ø	A	CHF		
mm	mm	mm			
253	38	35	99.00	1	009200893

920/56A

Cliquet réversible à cardan
carré mâle 1/2" à 72 dents

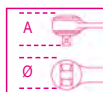

L	Ø	A	CHF		
mm	mm	mm			
315	40	43	126.50	1	009200911

920M/56

Cliquet réversible à cardan
carré mâle 1/2" avec manche métallique

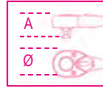

L	Ø	A	CHF		
mm	mm	mm			
330	38	35,7	132.00	2	009200894

920/58

Cliquet réversible
avec manche rotatif et carré mâle 1/2"
mécanisme à 52 dents

- Système d'utilisation avec poignée tournante
- Touche de déverrouillage de la douille
- Système d'inversion à douille sur la tête du cliquet
- Manche bi-matériaux

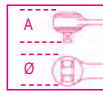

L	Ø	A	CHF		
mm	mm	mm			
281	42,5	45	116.00	1	009200926

Voir le tableau après la ref. 928/C8
pour les pièces détachées du mécanisme
de la tête de la clé dynamométrique



920.../C11

11 douilles et 2 accessoires



920A/C11	CHF		
	243.50	1	009200921

920A	10 - 12 - 13 - 14 - 15 - 16 17 - 18 - 19 - 21 - 22 mm
920/22	255 mm
920/50	
≡ 335x145x60 mm - 2,5 kg	

920B/C11	CHF		
	243.50	1	009200922

920B	10 - 12 - 13 - 14 - 15 - 16 17 - 18 - 19 - 21 - 22 mm
920/22	255 mm
920/50	
≡ 335x145x60 mm - 2,5 kg	

920.../C12...

12 douilles et 5 accessoires



920A/C12X	CHF		
	356.00	1	009200933

920A	10 - 11 - 12 - 13 - 14 - 17 - 19 22 - 24 - 27 - 30 - 32 mm
920/21	125 mm
920/22	255 mm
920/25	
920/42	
920/55	
≡ 420x185x60 mm - 4,2 kg	







9899 920C12	CHF		
Plateau thermoformé vide	17.20	1	098990116

920A/C12	CHF		
	351.00	1	009200931

920A	10 - 11 - 12 - 13 - 14 - 17 - 19 22 - 24 - 27 - 30 - 32 mm
920/21	125 mm
920/22	255 mm
920/25	
920/42	
920/50	
≡ 420x185x60 mm - 4,2 kg	

9899 920C12 CHF 17.20 1 098990116
Plateau thermoformé vide







920B/C12X CHF 356.00 1 009200934

	920B	10 - 11 - 12 - 13 - 14 - 15 - 16 22 - 24 - 27 - 30 - 32 mm
	920/21	125 mm
	920/22	255 mm
	920/25	
	920/42	
	920/55	

420x185x60 mm - 4,0 kg

9899 920C12 CHF 17.20 1 098990116
Plateau thermoformé vide

920B/C12 CHF 351.00 1 009200932

	920B	10 - 11 - 12 - 13 - 14 - 17 - 19 22 - 24 - 27 - 30 - 32 mm
	920/21	125 mm
	920/22	255 mm
	920/25	
	920/42	
	920/50	

420x185x60 mm - 4,0 kg







9899 920C12 CHF 17.20 1 098990116
Plateau thermoformé vide

920MC/C14

14 douilles 6 pans colorées et 5 accessoires



920MC/C14 CHF 374.00 1 009202964

	920MC	8 - 10 - 11 - 12 - 13 - 14 - 15 - 16 - 17 - 18 - 19 - 21 - 22 - 24 mm
	920/21	125 mm
	920/22	255 mm
	920/25	
	920/42	
	920/55	

420x185x60 mm - 4,2 kg







920.../C20...

20 douilles et 5 accessoires

12"









920A/C20X CHF 440.00 1 009200950

	920A	10 - 11 - 12 - 13 - 14 - 15 - 16 17 - 18 - 19 - 20 - 21 - 22 - 23 24 - 26 - 27 - 28 - 30 - 32 mm
	920/21	125 mm
	920/22	255 mm
	920/25	
	920/42	
	920/55	

420x185x60 mm - 5,1 kg

9899 920C20 CHF 17.20 1 098990121
Plateau thermoformé vide







920A/C20 CHF 435.00 1 009200948

	920A	10 - 11 - 12 - 13 - 14 - 15 - 16 17 - 18 - 19 - 20 - 21 - 22 - 23 24 - 26 - 27 - 28 - 30 - 32 mm
	920/21	125 mm
	920/22	255 mm
	920/25	
	920/42	
	920/50	

420x185x60 mm - 5,1 kg

9899 920C20 CHF 17.20 1 098990121
Plateau thermoformé vide







920A/C20Q CHF 440.00 1 009200955

	920A	10 - 11 - 12 - 13 - 14 - 15 - 16 17 - 18 - 19 - 20 - 21 - 22 - 23 24 - 26 - 27 - 28 - 30 - 32 mm
	920/21	125 mm
	920/22	255 mm
	920/25	
	920/42	
	920/55Q	

420x185x60 mm - 5,1 kg

9899 920C20 CHF 17.20 1 098990121
Plateau thermoformé vide







920B/C20 CHF 435.00 1 009200949

	920B	10 - 11 - 12 - 13 - 14 - 15 - 16 17 - 18 - 19 - 20 - 21 - 22 - 23 24 - 26 - 27 - 28 - 30 - 32 mm
	920/21	125 mm
	920/22	255 mm
	920/25	
	920/42	
	920/50	

420x185x60 mm - 5,0 kg

9899 920C20 CHF 17.20 1 098990121
Plateau thermoformé vide

920B/C20X CHF 440.00 1 009200951

	920B	10 - 11 - 12 - 13 - 14 - 15 - 16 17 - 18 - 19 - 20 - 21 - 22 - 23 24 - 26 - 27 - 28 - 30 - 32 mm
	920/21	125 mm
	920/22	255 mm
	920/25	
	920/42	
	920/55	

420x185x60 mm - 5,0 kg

9899 920C20 CHF 17.20 1 098990121
Plateau thermoformé vide







920.../C21...

21 douilles et 6 accessoires

12"









920A/C21 CHF 506.00 1 009200952

	920A	10 - 11 - 12 - 13 - 14 - 15 - 16 17 - 18 - 19 - 20 - 21 - 22 - 23 24 - 25 - 26 - 27 - 28 - 30 - 32 mm
	920/21	125 mm
	920/22	255 mm
	920/25	
	920/42	
	920/46	
	920/50	







420x280x60 mm - 6,5 kg

920A/C21X CHF 511.00 1 009200983

	920A	10 - 11 - 12 - 13 - 14 - 15 - 16 17 - 18 - 19 - 20 - 21 - 22 - 23 24 - 25 - 26 - 27 - 28 - 30 - 32 mm
	920/21	125 mm
	920/22	255 mm
	920/25	
	920/42	
	920/46	
	920/55	

420x280x60 mm - 6,4 kg

920B/C21 CHF 506.00 1 009200953

	920B	10 - 11 - 12 - 13 - 14 - 15 - 16 17 - 18 - 19 - 20 - 21 - 22 - 23 24 - 25 - 26 - 27 - 28 - 30 - 32 mm
	920/21	125 mm
	920/22	255 mm
	920/25	
	920/42	
	920/46	
	920/50	







420x280x60 mm - 6,4 kg



920B/C21X

CHF
511.00

1 009200984

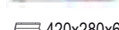
	○ 920B	10 - 11 - 12 - 13 - 14 - 15 - 16 17 - 18 - 19 - 20 - 21 - 22 - 23 24 - 25 - 26 - 27 - 28 - 30 - 32 mm
	920/21	125 mm
	920/22	255 mm
	920/25	
	920/42	
	920/46	
	920/55	

420x280x60 mm - 6,4 kg

920B/C30Q

30 douilles 12 pans et 5 accessoires

12"



920B/C30Q

CHF
722.00

1 009200975

	○ 920B	8 - 9 - 10 - 11 - 12 - 13 - 14 15 - 16 - 17 - 18 - 19 - 20 - 21 22 - 23 - 24 - 26 - 27 - 30 mm
	○ 920BL	12 - 13 - 14 - 17 - 19 - 21 22 - 24 - 27 - 30 mm
	920/21	125 mm
	920/22	255 mm
	920/25	
	920/42	
	920/55Q	

420x280x60 mm - 7,6 kg

Beta

920.../C3320 douilles, 13 douilles tournevis
et 5 accessoires









12"

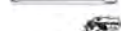

920A/C33

CHF
708.00

1 009200985







	○ 920A	10 - 11 - 12 - 13 - 14 - 15 - 16 17 - 18 - 19 - 20 - 21 - 22 - 23 24 - 26 - 27 - 28 - 30 - 32 mm
	● 920LP	1,2x8 - 1,6x9 - 2x12 mm
	⊕ 920PH	PH2 - PH3 - PH4
	○ 920PE	4 - 5 - 6 - 8 - 10 - 12 - 14 mm
	920/21	125 mm
	920/22	255 mm
	920/25	
	920/42	
	920/55	

420x280x60 mm - 6,7 kg

920B/C33

CHF
708.00

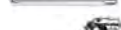
1 009200986

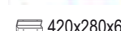
	○ 920B	10 - 11 - 12 - 13 - 14 - 15 - 16 17 - 18 - 19 - 20 - 21 - 22 - 23 24 - 26 - 27 - 28 - 30 - 32 mm
	● 920LP	1,2x8 - 1,6x9 - 2x12 mm
	⊕ 920PH	PH2 - PH3 - PH4
	○ 920PE	4 - 5 - 6 - 8 - 10 - 12 - 14 mm
	920/21	125 mm
	920/22	255 mm
	920/25	
	920/42	
	920/55	

420x280x60 mm - 6,7 kg

920A/C17M - 920A/C17MRCoffret métallique avec plateau en mousse
compacte comprenant 1 cliquet avec 17
douilles 6 pans et 4 accessoires







12"



920A/C17M

CHF
404.00

1 009200924

	○ 920A	10-11-12-13-14-15-16-17-18 19-20-21-22-24-27-30-32 mm
	920/21	125 mm
	920/22	255 mm
	920/25	
	920/42	305 mm
	920/55	

420x185x60 mm - 5 kg

9899 920C17

CHF
31.50

1 098990137

Module souple vide

920A/C17MR

CHF
443.00

1 009200937

	920/21	125 mm
	920/22	255 mm
	920/25	
	920/42	305 mm
	920/58	

420x185x60 mm 5,1 kg

920/C37

37 douilles 12 pans et 5 accessoires

12"



920/C37

CHF
661.00

1 009200988

	○ 920B	10 - 11 - 12 - 13 - 14 - 15 - 16 17 - 18 - 19 - 20 - 21 - 22 - 23 24 - 26 - 27 - 28 - 30 - 32 mm
	○ 920AS	3/8 - 7/16 - 1/2 - 9/16 - 19/32 5/8 - 11/16 - 3/4 - 25/32 - 13/16 7/8 - 15/16 - 1 - 1.1/16 - 1.1/8 1.3/16 - 1.1/4
	920/21	125 mm
	920/22	255 mm
	920/25	
	920/42	
	920/55	

420x280x60 mm - 7,5 kg

Beta

920AS/C10

10 douilles 12 pans et 2 accessoires

12^{''}



920AS/C10 CHF 252.00 1 009200919

- 920AS 3/8 - 7/16 - 1/2 - 9/16 - 5/8
11/16 - 3/4 - 13/16 - 7/8 - 15/16
 - 920/22 255 mm
 - 920/50
- 335x145x60 mm - 2,6 kg

920AS/C15

15 douilles 12 pans et 6 accessoires

12^{''}



920AS/C15 CHF 471.00 1 009200947

- 920AS 3/8 - 7/16 - 1/2 - 9/16 - 5/8 - 11/16
3/4 - 13/16 - 7/8 - 15/16 - 1
1.1/16 - 1.1/8 - 1.3/16 - 1.1/4
 - 920/21 125 mm
 - 920/22 255 mm
 - 920/25
 - 920/42
 - 920/46
 - 920/50
- 420x280x60 mm - 5,9 kg

920AS/C17X

17 douilles 12 pans et 5 accessoires

12^{''}



920AS/C17X CHF 439.00 1 009200942

- 920AS 3/8 - 7/16 - 1/2 - 9/16 - 19/32 - 5/8
11/16 - 3/4 - 25/32 - 13/16 - 7/8
15/16 - 1 - 1.1/16 - 1.1/8 - 1.3/16 - 1.1/4
 - 920/21 125 mm
 - 920/22 255 mm
 - 920/25
 - 920/42
 - 920/55
- 420x185x60 mm - 4,8 kg

920AS/MBM-C21

16 douilles 12 pans et 5 accessoires pour maintenance aéronautique

12^{''}



920AS/MBM-C21 CHF 448.00 1 009200944

- 920AS 3/8 - 7/16 - 1/2 - 9/16
19/32 - 5/8 - 11/16 - 3/4
25/32 - 13/16 - 7/8 - 15/16
1 - 1.1/16 - 1.3/16 - 1.1/4
 - 920M/55
 - 920/21 125 mm
 - 920/22 255 mm
 - 920/25
 - 920/42
- 420x185x60 mm - 5,0 kg

920TX/C17

Coffret spécial Torx®



12^{''}



920TX/C17 CHF 413.00 1 009200989

- 861TX T8 - T10 - T15 - T20 - T25 - T27
 - 897
 - 920TX T27 - T30 - T40 - T45 - T50
 - 920FTX E10 - E12 - E14 - E16 - E18 - E20
 - 920/20 75 mm
 - 920/22 255 mm
 - 920/55
- 420x185x60 mm - 2,9 kg

920A/C17HR

Coffret métallique avec plateau thermoformé rigide comprenant 1 cliquet avec 17 douilles 6 pans et 5 accessoires

• cliquet avec branche rotative

12^{''}



920A/C17HR CHF 454.00 1 009200939

- 920A 10-11-12-13-14-15-16-17-18
19-20-21-22-24-27-30-32 mm
 - 920/21 125 mm
 - 920/22 255 mm
 - 920/25
 - 920/42
 - 920/58
- 420x185x60 mm - 5,1 kg

Beta

920U/C17M

Coffret 1/2 composé de 17 douilles multi empreintes et 5 accessoires, dans un plateau en mousse

1/2"



920U/C17M CHF 413.00 1 009201797

- 920U ○ 10-11-12-13-14-15-16-17-18-19-20
21-22-24-27-30-32 mm
* 3/8-7/16-15/32-1/2-9/16-19/32-5/8-3/4
25/32-7/8-15/16-1.1/16-1.1/8-1.1/4
○ M12-M14-M16-M18
○ E12-E14-E16-E18-E20-E22-E24
- 920/21 125 mm
- 920/22 255 mm
- 920/25
- 920/42 305 mm
- 920/55 275 mm

420x185x60 mm - 5 kg

9899 920C17 CHF 31.50 1 098990137
Module souple vide

928A

Douille 6 pans

3/4"



UNI/ISO 2725
DIN 3124

Ø mm	Ø mm	L mm	Ø1 mm	CHF		
19	29,2	50	34	20.70	5	009280019
21	30,0	51	34	21.10	5	009280021
22	31,3	53	34	21.10	5	009280022
23	33,3	53	34	21.50	5	009280023
24	34,5	53	34	21.80	5	009280024
26	36,8	55	35	23.30	5	009280026
27	38,0	56	35	23.30	5	009280027
28	39,0	57	35	24.80	3	009280028
29	40,2	58	35	25.50	3	009280029
30	41,5	58	37	26.00	3	009280030
32	44,3	60	37	27.00	3	009280032
33	45,8	60	37	28.00	3	009280033
34	46,8	60	37	29.00	3	009280034
35	48,1	62	38	29.50	3	009280035
36	49,5	64	38	29.50	3	009280036
38	52,0	68	40	32.00	3	009280038
41	56,0	71	40	36.00	3	009280041
46	62,3	75	43	44.00	3	009280046
50	67,4	80	43	53.50	3	009280050
55	73,7	84	48	65.50	1	009280055
60	80,0	87	48	75.50	1	009280060

928B

Douille 12 pans

3/4"



UNI/ISO 2725
DIN 3124

Ø mm	Ø mm	L mm	Ø1 mm	CHF		
19	29,2	50	34	20.70	5	009280119
21	30,0	51	34	21.10	5	009280121
22	31,3	53	34	21.10	5	009280122
23	33,3	53	34	21.50	5	009280123
24	34,5	53	34	21.80	5	009280124
26	36,8	55	35	23.30	5	009280126
27	38,0	56	35	23.30	5	009280127
28	39,0	57	35	24.80	3	009280128
29	40,2	58	35	25.50	3	009280129
30	41,5	58	37	26.00	3	009280130
32	44,3	60	37	27.00	3	009280132
33	45,8	60	37	28.00	3	009280133
34	46,8	60	37	29.00	3	009280134
35	48,1	62	38	29.50	3	009280135
36	49,5	64	38	29.50	3	009280136
38	52,0	68	40	32.00	3	009280138
41	56,0	71	40	36.00	3	009280141
46	62,3	75	43	44.00	3	009280146
50	67,4	80	43	53.50	3	009280150
55	73,7	84	48	65.50	1	009280155
60	80,0	87	48	75.50	1	009280160

928AS

Douille 6 pans

3/4"



Ø mm	Ø mm	L mm	Ø1 mm	CHF		
7/8	32,0	53	34	23.80	1	009280202
15/16	34,5	53	34	23.80	1	009280203
1	36,2	55	35	25.00	1	009280204
1.1/16	38,0	56	35	26.00	1	009280205
1.1/8	40,2	58	35	26.50	1	009280206
1.1/4	44,2	60	37	29.00	1	009280208
1.5/16	45,8	60	37	30.00	1	009280209
1.3/8	48,1	62	38	31.50	1	009280210
1.7/16	49,5	64	38	33.00	1	009280211
1.1/2	52,0	68	40	36.00	1	009280212
1.5/8	56,0	71	40	39.00	1	009280214
1.11/16	58,8	74	40	44.50	1	009280215
1.13/16	62,3	75	43	50.00	1	009280217
1.7/8	65,0	78	43	54.00	1	009280218
2	68,3	80	43	62.00	1	009280219
2.1/16	71,5	83	48	72.00	1	009280220

928ME

Douille tournevis pour vis 6 pans creux

3/4"

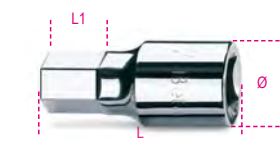

mm	Ø mm	L mm	L1 mm	CHF		
14	35	75	15,5	48.50	2	009280514
17	35	75	15,5	48.50	2	009280517
19	35	75	15,5	48.50	2	009280519
22	35	75	22,5	48.50	2	009280522

928/15

Réducteur carré femelle 3/4" et mâle 1/2"

3/4"



UNI/ISO 3316
DIN 3123

L mm Ø mm CHF 51,5 34 3/4 1/2 25.00 5 009280801



Toujours appliquer la force de serrage régulièrement et progressivement afin d'éviter la rupture et de se protéger contre un possible accident.

928/16

Augmentateur carré femelle 3/4" et mâle 1"

3/4"



UNI/ISO 3316
DIN 3123

L mm Ø mm CHF 65 34 3/4 1" 30.00 5 009280807

928/20 - 928/21 - 928/22

Rallonge carrés mâle et femelle 3/4"

3/4"

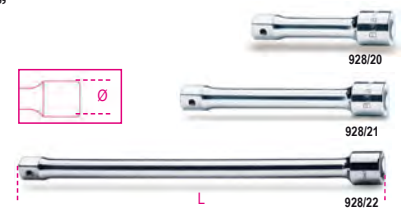

UNI/ISO 3316
DIN 3123

928/20	L mm	Ø mm	CHF		
928/20	100	34	29.50	3	009280810
928/21	200	34	39.50	3	009280815
928/22	380	34	58.00	3	009280825

928/25

Cardan carrés mâle et femelle 3/4"

3/4"



UNI/ISO 3316 DIN 3123

L mm Ø mm CHF 108 40 100.00 1 009280830

928/36A

Poignée articulée carré mâle 3/4"



DIN 3122 - UNI ISO 3315

L mm	CHF	1	009280844
545	119.50		

928/42

Poignée coulissante carré mâle 3/4"

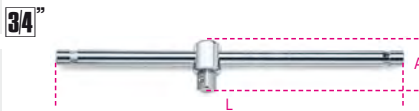

UNI/ISO 3315 DIN 3122

L mm	A mm	CHF	3	009280850
450	62,5	63.00		

928/55

Cliquet réversible carré mâle 3/4"
à 72 dents

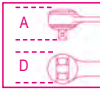

DIN 3122 - UNI ISO 3315

L mm	Ø mm	A mm	CHF	2	009280862
510	58	59	202.50		

Voir le tableau après la ref. 928/C8
pour les pièces détachées du mécanisme
de la tête de la clé dynamométrique

928.../C12

Coffret métallique comprenant 1 cliquet avec
12 douilles 6 pans et 4 accessoires



928A/C12	CHF	1	009280955
	1,075.00		

928A	22 - 24 - 27 - 30 - 32 - 34 - 36 38 - 41 - 46 - 50 - 55 mm
928/21	200 mm
928/22	380 mm
928/25	
928/42	
928/55	

530x220x80 mm - 13,5 kg

928B/C12	CHF	1	009280957
	1,075.00		

928B	22 - 24 - 27 - 30 - 32 - 34 - 36 38 - 41 - 46 - 50 - 55 mm
928/21	200 mm
928/22	380 mm
928/25	
928/42	
928/55	

530x220x80 mm - 13,5 kg

928AS/C12

Coffret métallique comprenant 1 cliquet avec
12 douilles 6 pans et 5 accessoires



928AS/C12	CHF	1	009280968
	1,115.00		

928AS	7/8-15/16-1.1/16-1.1/8-1.1/4 1.5/16-1.7/16-1.1/2-1.11/16 1.13/16-1.7/8-2.1/16
928/21	200 mm
928/22	380 mm
928/25	
928/42	
928/55	

530x220x80 mm - 13,5 kg

929

Douille 6 pans



UNI/ISO 2725 DIN 3124

Ø mm	L mm	Ø1 mm	CHF	1	009290036
36	51	65	44.00		
41	57	70	46.50		009290041
46	65	75	52.00		009290046
50	70	80	60.00		009290050
55	76	85	70.50		009290055
60	82	90	75.50		009290060
65	88	95	97.50		009290065
70	92	100	116.50		009290070
75	99	110	126.50		009290075
80	106	120	145.00		009290080

929/15

Réducteur carré femelle 1" et mâle 3/4"

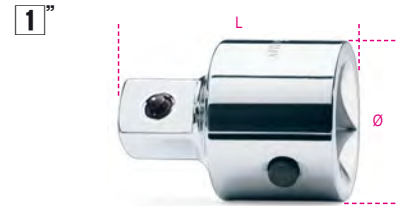

UNI/ISO 3316 DIN 3123

L mm	Ø mm	1"	3/4"	CHF	2	009290801
65	47			52.00		

Toujours appliquer la force de serrage
régulièrement et progressivement
afin d'éviter la rupture et de se protéger
contre un possible accident.

929/21 - 929/22

Rallonge carrés mâle et femelle 1"



UNI/ISO 3316 DIN 3123

929/21	L mm	Ø mm	CHF	1	009290815
	200	47	67.00		
929/22	400	47	97.50		009290825

929/42

Poignée coulissante carré mâle 1"



UNI/ISO 3315 DIN 3122

L mm	CHF	1	009290850
535	125.00		

929/55

Cliquet réversible carré mâle 1"
à 72 dents



UNI/ISO 3315 DIN 3122

L mm	Ø mm	A mm	CHF	1	009290860
770	62	63	270.00		

929/55PR

Rallonge pour cliquets 929/55



L mm	Ø mm	Ø1 mm	CHF	1	009290868
540	32	26	57.50	1	009290868

929/C8

8 douilles 6 pans et 5 accessoires

1"



929/C8	CHF	1	009290925
	1,575.00	1	009290925

	929	46 - 50 - 55 - 60 - 65 70 - 75 - 80 mm
	929/15	□ 1" - ■ 3/4
	929/21	200 mm
	929/22	400 mm
	929/42	
	929/55	

≡ 560x290x120 mm - 29 kg

9899 CV/A

coffret vide



9899 CV/A	CHF	1	098990001
	42.50	1	098990001

583/C31-671B/C5-671B/C10-720ME/C8
860/C38P-861/C61P-900/C11-900AS/C10-/MB-C17
900/C24-900/C13-8-900/C13-5-900MB/C19-900MB/C28
900/C11HR-900AS/C10-/MB-C17-900AS/C17-MBM
900/C11Z-900MC/C24-900MC/C32-910.../C10
971/C8-920TX/C-920PE/C-920FTX/C-910.../C10

≡ 270x120x45 mm

9899 CV/B

coffret vide



9899 CV/B	CHF	1	098990002
	49.50	1	098990002

352C/U-720MC/C13-727/C16-867/C20-900/C12MR
900/C12MZ-900U/C12M-910AS/C13...-910AS/MBM-C18
910A/C16...-910B/C16...-910A/C16HR
910A/C16...-910B/C16...-920AS/C10-920.../C11-1433/C11
1494/C14A-1529-1545/C5M

≡ 335x145x60 mm

9899 CV/C

coffret vide



9899 CV/C	CHF	1	098990003
	60.50	1	098990003

920A/C17HR-920A/C17MR-920.../C12...
920A/C17M-910.../C29-902A/C22-867/C38
720/C24-450/C15-353N/C6-960KPC-920MC/C14
920U/C17M-920TX/C17-920.../C20...
920AS/MBM-C21-920AS/C17X-1547/C6-1495/C6
1489/C14-1461/C11A-1608/C9-1606A/C9-1602/C9

≡ 420x185x60 mm

900/R55

14"

723



900/R55	CHF	1	009000871
	44.00	1	009000871

666N/2-900/55-666/2-666LBF.FT/2

900/R55-Z

14"

723



900/R55-Z	CHF	1	009000872
	44.00	1	009000872

666N/2-900/55-666/2-666LBF.FT/2

900M/R55

14"



900M/R55	CHF	1	009000888
	23.10	1	009000888

666N/2-900/55-666/2-666LBF.FT/2

910/R55

38"

723



910/R55	CHF	1	009100879
	42.50	1	009100879

599DGT/6-606/6-606/10-612-665/6-665/10-665LB/6
665LB/10-666N/5-666N/10-666N LBF.IN/5-666NLBF.IN/10
666/6-666/10-668RGC/6-668RGC/10-910/55-666/5
666HS/5-666HS/10-666 LBF.FT/5-666 LBF.FT/10

910M/R55

38"



910M/R55	CHF	1	009100888
	23.80	1	009100888

666N/2-900/55-666/2-666LBF.FT/2

910/R55Q

38"

723



910/R55Q	CHF	1	009100877
	42.50	1	009100877

666N/2-900/55-666/2-666LBF.FT/2

910/R55X

38"

723



910/R55X	CHF	1	009100877
	42.50	1	009100877

666N/2X-666/2X-666 LBF.FT/2X

920/R50

12"

723



920/R50	CHF	1	009200866
	42.00	1	009200866

614/50-667/20-667/30
667N/20-667N/30-920/50

920/R55

12"

723



920/R55	CHF	1	009200879
	51.50	1	009200879

606/20-606/30-666/20-666/30-920/55
920/56A- 599DGT/20-599DGT/30
599DGT-AN/20-665/20-665/30-665LB/20
665LB/30-666N/20-666N/30
666N LBF.IN/20-666N LBF.IN/30-668RGC/20
666 LBF.FT/20-666 LBF.FT/30

920M/R55

12"



920M/R55	CHF	1	009200888
	26.50	1	009200888

666N/2-900/55-666/2-666LBF.FT/2

920/R55Q

12"

723



920/R55Q	CHF	1	009200877
	51.50	1	009200877

666N/2-900/55-666/2-666LBF.FT/2

920/R55X

12^{pan}

77



CHF 42.00 1 009200878

920/R55X
606/10X-612X
666/10X-920/55X-599DGT/10X-599DGT-AN/10
665/10X-665LB/10X-666N10X-666N LBF.IN/10X
668RGC/10X-666 LBF.FT/10X
666HS/20LC-666HS/30LC

920/R55LC

12^{pan}

77



CHF 54.00 1 009200887

920/R55LC
920/55LC "Locking System"
666HS/20LC-666HS/30LC

928/R55

34^{pan}

77



CHF 85.50 1 009280859

928/R55
928/55

928/R55X

34^{pan}

77



CHF 54.50 1 009280858

928/R55X
614X

929/R55

1^{pan}

77



CHF 98.50 1 009290859

929/R55
929/55

930

Clé en tube droite 12 pans gros effort



UNI 6745

mm	L mm	Ø mm	Ø1 mm	CHF		
6x7	100	9,5	11,0	17.20	3	009300006
8x9	108	12,5	14,0	21.70	3	009300010
10x11	116	15,0	16,5	22.70	3	009300014
12x13	124	17,5	19,0	26.50	3	009300018
14x15	132	20,0	21,5	29.00	3	009300023
16x17	140	23,0	24,0	33.50	3	009300027

mm	L mm	Ø mm	Ø1 mm	CHF		
18x19	148	25,0	26,5	37.00	3	009300032
20x22	156	28,0	30,0	41.00	2	009300036
21x23	163	29,0	31,5	43.50	2	009300040
24x26	173	33,0	35,5	55.00	2	009300044
25x28	182	34,5	38,0	59.50	2	009300048
27x29	191	37,0	39,5	68.00	2	009300052
30x32	200	40,5	43,0	82.50	2	009300056



CHF 246.00 1 009300081

930/S8 6x7-8x9-10x11-12x13-14x15 16x17-18x19-20x22 mm 940/1 - /2	CHF 573.00	1	009300083
930/S13 6x7-8x9-10x11-12x13-14x15-16x17 18x19-20x22-21x23-24x26 25x28-27x29-30x32 mm 940/1 - /2 - /3	CHF 573.00	1	009300083



CHF 660.00 1 009300098

930/C13 6x7-8x9-10x11-12x13 14x15-16x17-18x19 20x22-21x23-24x26 25x28-27x29-30x32 mm 940/1 - /2 - /3	CHF 660.00	1	009300098
---	------------	---	-----------

932

Clé à pipe débouchée chromée polie

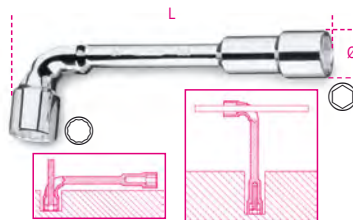

NF E 74.303

mm	Ø mm	L mm	CHF		
6x6	11,5	110	19.40	5	009320006
7x7	12,5	116	19.60	5	009320007
8x8	13,0	120	20.30	5	009320008
9x9	14,0	125	21.10	5	009320009
10x10	16,5	133	22.00	5	009320010
11x11	17,5	143	23.90	5	009320011
12x12	19,0	148	25.50	5	009320012
13x13	19,5	154	26.50	5	009320013
14x14	21,5	167	28.00	5	009320014
15x15	22,5	182	29.50	5	009320015
16x16	24,5	193	30.50	5	009320016
17x17	26,0	198	31.00	5	009320017
18x18	26,5	215	34.00	5	009320018
19x19	29,0	220	37.00	5	009320019
20x20	30,5	222	39.50	3	009320020
21x21	30,5	236	45.00	3	009320021
22x22	32,5	250	49.50	2	009320022
23x23	33,5	256	55.00	2	009320023
24x24	35,0	272	59.00	2	009320024
25x25	36,5	282	62.50	2	009320025

mm	Ø mm	L mm	CHF		
26x26	37,5	296	69.00	2	009320026
27x27	39,0	296	72.00	2	009320027
28x28	39,0	314	82.00	2	009320028
30x30	42,5	348	98.00	2	009320030
32x32	45,5	364	108.50	2	009320032



CHF 303.00 1 009320080

932/S11 6-7-8-10-11-12 13-14-17-19-22 mm	CHF 303.00	1	009320080
932/S17 6-7-8-9-10-11-12 13-14-15 16-17-18-19-20-21-22 mm	503.00	1	009320081
932/S25 6-7-8-9-10-11-12-13-14-15-16-17-18-19 20-21-22-23-24-25-26-27-28-30-32 mm	1,109.00	1	009320082

933

Clé à pipe débouchée chromée polie

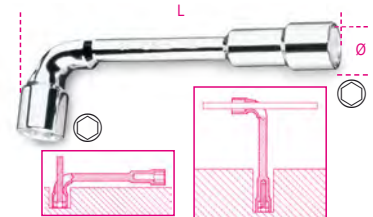

NF E 74.303

mm	Ø mm	L mm	CHF		
6x6	11,5	110	19.40	5	009330006
7x7	12,5	116	19.60	5	009330007
8x8	13,0	120	20.30	5	009330008
9x9	14,0	125	21.10	5	009330009
10x10	16,5	133	22.00	5	009330010
11x11	17,5	143	23.90	5	009330011
12x12	19,0	148	25.50	5	009330012
13x13	19,5	154	26.50	5	009330013
14x14	21,5	167	28.00	5	009330014
15x15	22,5	182	29.50	5	009330015
16x16	24,5	193	30.50	5	009330016
17x17	26,0	198	31.00	5	009330017
18x18	26,5	215	34.00	5	009330018
19x19	29,0	220	37.00	5	009330019
20x20	30,5	222	39.50	3	009330020
21x21	30,5	236	45.00	3	009330021
22x22	32,5	250	49.50	2	009330022
23x23	33,5	256	55.00	2	009330023
24x24	35,0	272	59.00	2	009330024
25x25	36,5	282	62.50	2	009330025
26x26	37,5	296	69.00	2	009330026
27x27	39,0	296	72.00	2	009330027
28x28	39,0	314	82.00	2	009330028
30x30	42,5	348	98.00	2	009330030
32x32	45,5	364	108.50	2	009330032



CHF 303.00 1 009330080

933/S11 6-7-8-10-11-12-13-14-17-19-22 mm	CHF 303.00	1	009330080
933/S17 6-7-8-9-10-11-12-13-14-15-16-17 18-19-20-21-22 mm	503.00	1	009330081
933/S25 6-7-8-9-10-11-12-13-14-15-16-17-18-19 20-21-22-23-24-25-26-27-28-30-32 mm	1,109.00	1	009330082

935

Clé en tube droite 6 pans, série légère



UNI 6746 DIN 896

Ø mm	L mm	CHF	🔧	📄
6x7	100	10.00	5	009350105
8x9	110	10.70	5	009350111
10x11	120	12.00	5	009350115
12x13	130	13.50	5	009350117
14x15	140	15.80	5	009350126
16x17	150	17.20	5	009350128
18x19	160	20.30	5	009350131
20x22	170	24.70	3	009350138
21x23	180	27.50	3	009350141
24x26	190	31.00	3	009350144
25x28	200	34.00	2	009350150
27x29	210	40.50	2	009350153
30x32	220	43.50	2	009350156

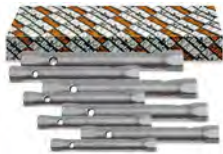

Ø mm	L mm	CHF	🔧	📄
935/S8 6x7-8x9-10x11-12x13-14x15-16x17-18x19-20x22 mm		141.50	1	009350181
940/1 - /2				
935/S13 6x7-8x9-10x11-12x13-14x15-16x17-18x19-20x22-21x23-24x26-25x28-27x29-30x32 mm		335.00	1	009350183
940/1 - /2 - /3				

937

Clé à pipe débouchée chromée

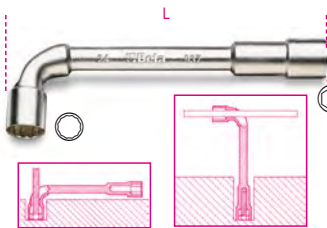

Ø mm	Ø mm	L mm	CHF	🔧	📄
6x6	11,5	110	10.70	5	009370006
7x7	12,5	116	11.20	5	009370007
8x8	13,0	120	11.60	5	009370008
9x9	14,0	125	12.30	5	009370009
10x10	16,5	133	12.90	5	009370010
11x11	17,5	143	13.50	5	009370011
12x12	19,0	148	15.10	5	009370012
13x13	19,5	154	15.50	5	009370013
14x14	21,5	167	17.00	5	009370014
15x15	22,5	182	18.70	5	009370015
16x16	24,5	193	20.20	5	009370016
17x17	26,0	198	21.00	5	009370017
18x18	26,5	215	21.50	5	009370018
19x19	29,0	220	22.30	5	009370019
20x20	30,5	222	25.50	3	009370020
21x21	30,5	236	27.50	3	009370021
22x22	32,5	250	29.00	2	009370022
23x23	33,5	256	32.00	2	009370023
24x24	35,0	272	33.50	2	009370024
25x25	36,5	282	42.50	2	009370025
26x26	37,5	296	44.00	2	009370026
27x27	39,0	296	44.50	2	009370027
28x28	39,0	314	54.00	2	009370028
30x30	42,5	348	57.50	2	009370030
32x32	45,5	364	65.00	2	009370032



Ø mm	L mm	CHF	🔧	📄
937/S11 6-7-8-10-11-12-13-14-17-19-22 mm		180.00	1	009370080
937/S17 6-7-8-9-10-11-12-13-14-15-16-17-18-19-20-21-22 mm		306.00	1	009370081

940

Broche pour 930-935



Ø mm	L mm	CHF	🔧	📄
940/1 6+13	100	7.45	5	009400001
940/2 14+22	170	9.75	5	009400002
940/3 21+32	290	17.60	5	009400003

941

Clé à douilles à poignée en T haute performance

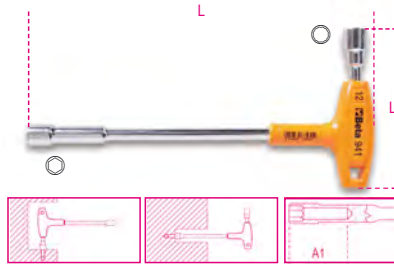

Ø mm	L mm	L1 mm	A1 mm	CHF	🔧	📄
7x7	200	91	35	36.00	2	009410107
8x8	220	107	50	39.50	2	009410108
9x9	220	109	50	39.50	2	009410109
10x10	236	111	50	40.50	2	009410110
11x11	236	114	50	42.00	2	009410111
12x12	255	122	50	46.50	2	009410112
13x13	255	124	55	47.00	2	009410113



Ø mm	L mm	CHF	🔧	📄
941/S7 7-8-9-10-11-12-13 mm		291.00	1	009410170

CLÉS À DOUILLES EMMANCHÉES AVEC POIGNÉE

Convient aux opérations de vissage rapides et répétées. L'épaisseur réduite des douilles 6 pans permet d'accéder aux espaces exigus. Le trou d'échappement intérieur facilite le travail sur les écrous sur tige filetées. C'est le cas, en particulier, des clés à douilles emmanchée série longue 944BX.

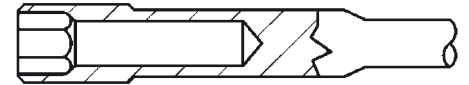

Le triple marquage sur la tête permet d'identifier plus facilement la taille souhaitée.

La lame flexible du modèle 943FL, qui est constituée d'acier protégé par une gaine, permet une transmission totale du couple en cas de décentrage avec la vis.

942BX

Clé à douille emmanchée, série courte



UNI 6750

Ø mm	L mm	L1 mm	A1 mm	CHF	🔧	📄
4	190	70	13,0	18.00	5	009420003
5	190	70	14,0	18.00	5	009420004
5,5	190	70	12,5	20.30	5	009420005
6	190	70	14,5	20.30	5	009420006
7	190	70	15,5	21.30	5	009420007
8	202	70	18,5	21.30	5	009420008
9	202	70	19,5	21.30	5	009420009
10	202	70	20,5	22.70	3	009420010
11	202	70	21,5	22.70	3	009420011
12	202	70	22,5	22.70	3	009420012
13	202	70	23,5	25.50	3	009420013
14	202	70	24,5	25.50	3	009420014



Ø mm	L mm	CHF	🔧	📄
942BX/S12 4-5-5,5-6-7-8-9-10-11-12-13-14 mm		260.00	1	009420030

943BX

Clé à douille emmanchée, série longue



ISO 2236 UNI 6750

mm	L mm	L1 mm	A1 mm	CHF		
4	270	150	13,0	20.00	5	009430003
5	270	150	14,0	20.00	5	009430004
5,5	270	150	12,5	21.50	5	009430005
6	270	150	14,5	21.50	5	009430006
7	270	150	15,5	22.90	5	009430007
8	282	150	18,5	22.90	5	009430008
9	282	150	19,5	22.90	5	009430009
10	282	150	20,5	25.00	3	009430010
11	282	150	21,5	25.00	3	009430011
12	282	150	22,5	25.00	3	009430012
13	282	150	23,5	26.50	3	009430013
14	282	150	24,5	26.50	3	009430014



943BX/S12 CHF 280.00 1 009430030
4-5-5,5-6-7-8-9
10-11-12-13-14 mm



943BX/D6 CHF 139.00 1 009430026
5-6-7-8-10-13 mm

943FL

Clé à douille emmanchée flexible série longue



mm	L mm	L1 mm	Ø mm	CHF		
5	265	150	8	28.00	2	009430304
5,5	265	150	8	28.00	2	009430305
6	265	150	9	28.00	2	009430306
7	265	150	11	28.00	2	009430307
8	265	150	12	29.00	2	009430308
10	290	175	14	31.50	2	009430310



943FL/S6 CHF 173.50 1 009430320
5-5,5-6-7-8-10 mm

944BX

Clé à douille emmanchée, série longue



ISO 2236 UNI 6750

mm	L mm	L1 mm	A1 mm	CHF		
4	245	125	20	20.70	3	009440003
5	245	125	25	20.70	3	009440004
5,5	245	125	30	25.50	3	009440005
6	245	125	35	25.50	3	009440006
7	245	125	35	25.50	3	009440007
8	257	125	50	27.00	3	009440008
9	257	125	50	27.00	3	009440009
10	257	125	50	28.50	3	009440010
11	257	125	50	28.50	3	009440011
12	257	125	50	31.00	3	009440012
13	257	125	55	31.00	3	009440013
14	257	125	55	31.00	3	009440014



944BX/S12 CHF 321.00 1 009440062
4-5-5,5-6-7-8-9
10-11-12-13-14 mm



944BX/D6 CHF 158.00 1 009440056
5-6-7-8-10-13 mm

949

Clé à béquille simple avec douille profonde 6 pans



mm	L mm	L1 mm	A1 mm	CHF		
8	220	160	50	38.00	2	009490008
10	230	160	50	39.50	2	009490010
12	240	175	50	41.00	2	009490012
13	244	175	55	42.00	2	009490013
14	250	190	55	44.50	2	009490014
17	264	200	60	51.50	2	009490017



949/S6 CHF 257.00 1 009490076
8-10-12-13-14-17 mm

950

Clé à béquille simple série longue

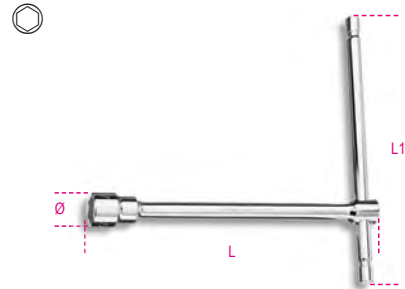

UNI 6742 DIN 3112

mm	L mm	Ø mm	L1 mm	CHF		
6	210	10,1	145	26.00	3	009500006
7	212	11,2	145	26.00	3	009500007
8	220	12,4	160	28.00	3	009500008
9	223	13,5	160	28.00	3	009500009
10	230	14,9	160	30.50	3	009500010
11	233	16,1	160	30.50	3	009500011
12	240	17,5	175	33.50	3	009500012
13	244	19,7	175	33.50	3	009500013
14	250	20,1	190	38.00	3	009500014
15	254	21,5	190	39.50	3	009500015
16	260	22,7	200	43.50	3	009500016
17	264	24,1	200	44.50	3	009500017
19	274	26,6	230	55.00	3	009500019
22	290	29,9	290	66.50	2	009500022
24	300	32,2	320	75.00	2	009500024
27	315	36,2	370	88.50	2	009500027



950/S9 CHF 320.00 1 009500079
7-8-10-11-12
13-14-17-19 mm

950/S14 CHF 523.00 1 009500082
6-7-8-9-10-11-12-13
14-15-16-17-19-22 mm



951 CLÉ EN T AVEC 3 EMBOUTS MALES



Lorsque cette clé a été lancée, en 1980, ce fut une révolution. Conçu pour fonctionner sur des vis à haute résistance, permettant une manipulation rapide, un ajustement précis et une utilisation polyvalente. La poignée hexagonale en T peut être ajustée selon les besoins. Les extrémités hexagonales sont conçues pour transmettre le couple maximal possible à la vis. La longueur de la tige permet d'appliquer sans effort des couples remarquables aux vis. Ses améliorations aux fils des années se traduisent par son marquage laser, des finitions sablées, des extrémités hexagonales à arêtes vives permettant un meilleur ajustement sur toutes les vis, y compris celles endommagées. Le marquage laser optimise la robustesse de la tige. Le nouveau modèle, 951GP, a été développé en collaboration avec des techniciens et des mécaniciens du MotoGP et du Superbike, dans le but d'améliorer la vitesse de vissage/dévisage

951 Clé mâle 6 pans en T



mm	L mm	L1 mm	Ø mm	CHF	📦	📄
2	125	63	4,0	23.90	5	009510521
2,5	150	63	4,0	23.90	5	009510525
3	150	63	4,0	23.90	5	009510530
3,5	175	76	5,5	24.70	5	009510535
4	175	76	5,5	24.70	5	009510540
4,5	195	87	6,5	27.00	5	009510545
5	195	87	6,5	27.00	5	009510550
6	215	99	8,0	31.00	5	009510560
7	230	109	9,0	33.50	5	009510570
8	250	122	10,0	33.50	5	009510580
9	265	132	11,0	42.00	5	009510590
10	280	142	12,0	42.00	5	009510610
12	305	160	15,0	57.00	3	009510620
14	330	178	17,0	68.00	3	009510640



	CHF	📦	📄
951/S6 2,5-3-4-5-6-8 mm	164.50	1	009510687
951/S8 2-2,5-3-3,5-4-4,5-5-6 mm	206.50	1	009510693
951/S14 2-2,5-3-3,5-4-4,5-5-6-7-8-9-10-12-14 mm	482.00	1	009510695



	CHF	📦	📄
951/SP6 3-4-5-6-8-10 mm	209.50	1	009510696
951/SPV	38.50	1	009510697



951AS Clé mâle 6 pans en T

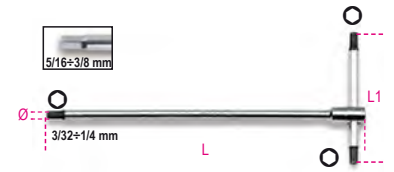

"	L mm	L1 mm	Ø mm	CHF	📦	📄
3/32	125	63	4,0	32.00	2	009510750
7/64	150	63	4,0	32.00	2	009510751
1/8	150	63	4,0	32.00	2	009510752
9/64	175	76	5,5	33.50	2	009510753
5/32	175	76	5,5	33.50	2	009510754
3/16	195	86	6,5	36.50	2	009510755
7/32	215	99	8,0	36.50	2	009510757
1/4	230	109	9,0	41.50	2	009510758
5/16	250	122	10,0	42.00	2	009510759
3/8	280	142	12,0	51.50	2	009510760



	CHF	📦	📄
951AS/S6X 1/8-3/16-7/32-1/4-5/16-3/8	240.50	1	009510771

951GP

Clés en T avec extrémité mâle 6 pans

La clé 951GP de Beta permet un ajustement rapide et précis d'une vis. Elle a été conçue pour répondre à certaines exigences des sports mécaniques : faire un serrage rapide avec des couples élevés.



mm	L mm	L1 mm	Ø mm	CHF	📦	📄
3	185	130	5	23.60	3	009511530
4	214	150	5	24.80	3	009511540
5	240	165	6	28.50	3	009511550
6	271	180	7	33.00	3	009511560
8	300	200	10	42.00	3	009511580
10	310	200	12	52.00	3	009511610

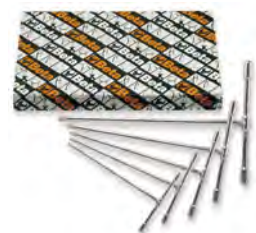

	CHF	📦	📄
951GP/S6 3-4-5-6-8-10 mm	204.00	1	009511687

951TX

Clé mâle pour vis à empreinte Torx® en T



Ø	L	L1	Ø	CHF		
mm	mm	mm	mm			
T6	125	63	4	29.50	3	009510806
T7	125	63	4	29.50	3	009510807
T8	125	63	4	30.50	3	009510808
T9	125	63	4	30.50	3	009510809
T10	150	63	4	31.00	3	009510810
T15	150	63	4	31.00	3	009510815
T20	175	76	5	33.00	3	009510820
T25	175	76	5	33.00	3	009510825
T27	195	87	6	34.50	3	009510827
T30	195	87	6	34.50	3	009510830
T40	215	99	7	40.50	3	009510840
T45	230	109	8	42.50	3	009510845
T50	250	122	9	46.00	3	009510850



	CHF		
951TX/S6 T8-T10-T15-T20-T25-T30	193.00	1	009510866
951TX/S13 T6-T7-T8-T9-T10-T15-T20-T25 T27-T30-T40-T45-T50	446.00	1	009510863

952 CLÉ EN T À DOUILLE À CARDAN

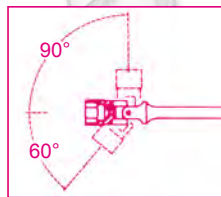
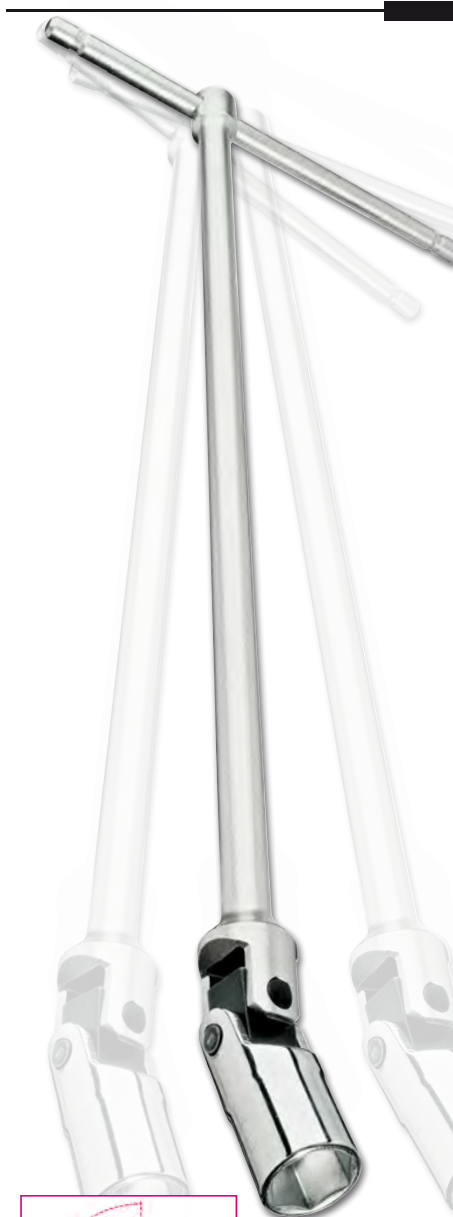

Un pré-positionnement fiable et précis est le secret du succès de cette clé. Le joint articulé conserve sa fonction au fil des années, aucun réglage n'étant nécessaire. Angle de rotation de la douille : 60°. Utilisable à 90° en position fixe. Poignée en T coulissante, peut être arrêtée dans la position requise sur toute sa longueur. Marquage triple taille sur la tête.

952

Clé à béquille à cardan

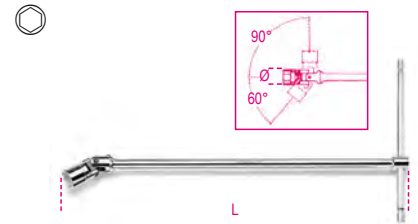

UNI 6743

Ø	Ø	L	CHF		
mm	mm	mm			
6	9,5	395	40.50	5	009520006
7	10,7	395	40.50	5	009520007
8	12,1	395	40.50	5	009520008
9	13,2	395	40.50	5	009520009
10	14,6	400	43.50	5	009520010
11	15,8	400	43.50	5	009520011
12	17,0	400	43.50	5	009520012
13	18,7	432	46.50	5	009520013
14	19,7	432	46.50	5	009520014
15	20,9	450	57.00	3	009520015
16	22,0	450	57.00	3	009520016
17	23,4	450	57.00	3	009520017
18	24,7	450	57.00	3	009520018
19	26,0	500	69.50	3	009520019
20	27,4	500	69.50	3	009520020
21	28,5	500	69.50	3	009520021
22	29,7	500	69.50	3	009520022
24	32,4	500	69.50	3	009520024



	CHF		
952/S7 8-10-11-13-14-17-19 mm	346.00	1	009520074
952/S10 7-8-10-11-12-13- 14-15-17-19 mm	487.00	1	009520080
952/S18 6-7-8-9-10-11-12 13-14-15-16-17 18-19-20-21-22-24 mm	960.00	1	009520083



	CHF		
952/D7 7-8-10-12-13-14-17 mm	317.00	1	009520079

852



852 1/4

79,85

Beta

952AS

Clé à béquille à cardan

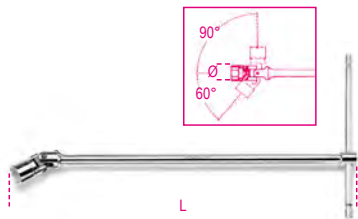

"	Ø mm	L mm	CHF		
1/4	9,5	395	44.00	2	009520256
5/16	12,1	395	44.00	2	009520258
3/8	14,6	400	47.00	2	009520260
7/16	15,8	400	47.00	2	009520261
1/2	18,7	432	53.50	2	009520263
9/16	19,7	432	57.00	2	009520264
5/8	22,0	450	60.50	2	009520266
11/16	23,4	450	60.50	2	009520267
3/4	26,0	500	75.50	2	009520269

952L

Clé à béquille à cardan série longue

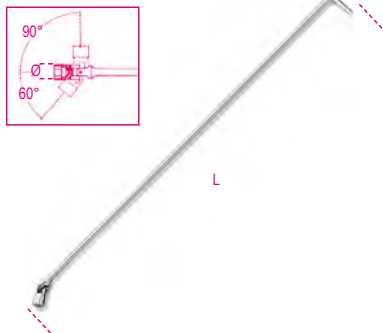

mm	Ø mm	L mm	CHF		
10	14,6	930	110.50	1	009520410
12	17,0	1063	110.50	1	009520412
13	18,7	1100	110.50	1	009520413
14	19,7	1100	110.50	1	009520414
15	20,9	1100	124.00	1	009520415
16	22,0	1100	124.00	1	009520416
17	23,4	1100	124.00	1	009520417
18	24,7	1100	124.00	1	009520418
19	26,0	1100	144.00	1	009520419

Beta

952FTX

Clé à béquille à cardan
pour écrou TORX®

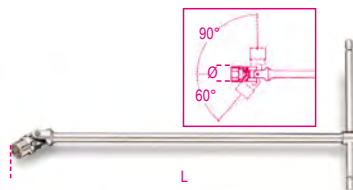

Ø mm	L mm	CHF		
E6	8	392	47.00	2 009520106
E7	9	392	47.00	2 009520107
E8	10	395	54.50	2 009520108
E10	13	400	56.00	2 009520110
E12	15	440	67.00	2 009520112
E14	17	490	82.00	2 009520114
E16	19	490	82.00	2 009520116
E18	21	490	82.00	2 009520118
E20	23	490	82.00	2 009520120



952FTX/S9	CHF		
E6-E7-E8-E10-E12 E14-E16-E18-E20	599.00	1	009520141

953

Clé mâle 6 pans à béquille à cardan

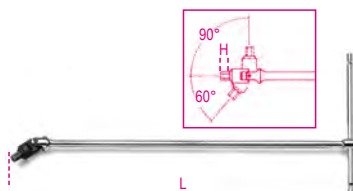

UNI 6754

mm	H mm	L mm	CHF		
3	5	395	41.50	5	009530130
3,5	6	395	41.50	3	009530135
4	6	395	41.50	5	009530140
4,5	7	395	41.50	3	009530145
5	7	395	41.50	5	009530150
6	9	400	44.50	5	009530160
7	10	425	49.50	3	009530170
8	11	425	49.50	5	009530180
10	13	440	59.00	5	009530200



953/S5	CHF		
3-4-5-6-8 mm	219.00	1	009530305
953/S9	410.00	1	009530301
3-3,5-4-4,5 5-6-7-8-10 mm			

953TX

Clé mâle à béquille à cardan
pour vis TORX®

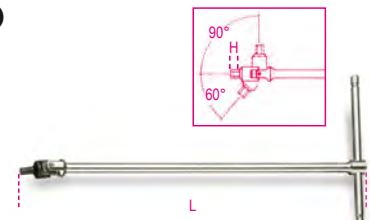

Ø	H mm	L mm	CHF		
T20	11	396	51.00	2	009530020
T25	11	396	51.00	2	009530025
T27	11	396	51.00	2	009530027
T30	13	400	56.00	2	009530030
T40	13	400	56.00	2	009530040
T45	13	426	57.00	2	009530045
T50	14	442	67.00	2	009530050
T55	14	442	67.50	2	009530055



953TX/S8	CHF		
T20-T25-T27-T30 T40-T45-T50-T55	455.00	1	009530060

Beta

Beta

REPARATION DE VEHICULES

Nos outils de réparation de véhicules qui sont utilisés par les professionnels les plus exigeants, sont développés et fabriqués pour répondre aux normes les plus élevées du monde, et régulièrement testés dans les conditions de fonctionnement les plus difficiles.

Depuis plus de 50 ans, nous travaillons fièrement et en collaboration les plus grands champions des sport mécaniques, nous aidant à améliorer continuellement nos produits et témoignant du niveau de qualité PREMIUM.

Les outils de réparations de véhicules se trouvent dans les sections:

Diagnostics	articles 1438 to 1499 articles 1758VT to 1760TMC
Moteur	articles 955 to 989A articles 1438 to 1499
Vidange	articles 1438 to 1499 articles 1877 to 1885
Système électrique	articles 1438 to 1499
Boosters de démarrage	articles 1498BC/12 to 1498/40A
Transmission	articles 1438 to 1499
Suspension	articles 1549 to 1569CP
Freins	articles 1438 to 1499
Roues	articles 955 to 989A
Carrosserie	articles 1302 to 1369 articles 1763 to 1767A
Autres équipements	articles 1875LT to 3067
Levage	articles 3029/2T to 3067/70-13T



955

Clé à bougies en tube



mm - "	D mm	L mm	CHF	🔧	🚗
16	21	86	20.60	3	009550016
5/8					
20,8	29	86	20.60	3	009550021
13/16					

956C

Douille à bougies



ISO 11168

mm - "	Ø mm	L mm	CHF	🔧	🚗
14	18,8	70	38.50	3	009560008
9/16					
16	21,4	70	38.50	3	009560010
5/8					
17,8	23,6	70	38.50	3	009560011
11/16					
20,8	27,0	70	38.50	3	009560012
13/16					

956E

Douille à bougies



ISO 11168

mm - "	Ø mm	L mm	CHF	🔧	🚗
14	18,8	70	42.00	3	009560018
9/16					
16	21,4	70	42.00	3	009560020
5/8					
17,8	23,6	70	42.00	3	009560021
11/16					
20,8	27,0	70	42.00	3	009560022
13/16					

956F

Douille à bougies



mm - "	Ø mm	L mm	CHF	🔧	🚗
14	18,8	70	47.00	1	009560114
9/16					
16	20,5	70	58.00	1	009560116
5/8					

Beta

956L

Douille 12 pans à bougies série longue



mm - "	Ø mm	L mm	CHF	🔧	🚗
14	19,0	250	78.50	2	009560214
9/16					
16	21,0	250	81.00	2	009560216
5/8					
17,8	24,0	250	85.50	2	009560217
11/16					

957

Clé à bougies à rotule

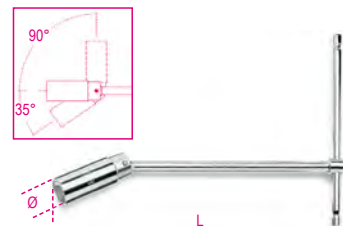

ISO 11168

mm - "	Ø mm	L mm	CHF	🔧	🚗
16	21,4	275	59.00	3	009570000
5/8					
20,8	27,0	275	69.50	3	009570001
13/16					

959

Clé à bougies à cardan

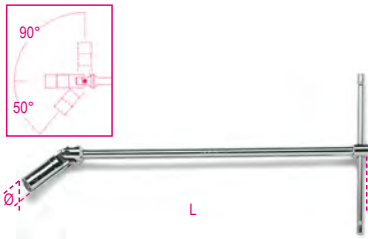

ISO 11168

mm -"	Ø mm	L mm	CHF		
14	18,8	483	69.00	3	009590009
9/16					
16	21,4	483	76.00	3	009590010
5/8					
20,8	27,0	527	101.50	3	009590011
13/16					

959R

Capsule en caoutchouc et ressort de recharge pour 956C - 956E - 957 - 959

	CHF		
959R/14 956C/14-956E/14	7.05	3	009590223
959R/16 956C/16-956E/16 957/16-959/16	7.05	3	009590224
959R/17,8 956C/17,8-956E/17,8	7.05	3	009590225
959R/20,8 956C/20,8-956E/20,8 957/20,8-959/20,8-959L	7.05	3	009590226

960

Douille pour injecteurs Diesel



mm	Ø mm	L mm	CHF		
27	36,5	77	44.50	2	009600027

960A

Douille pour injecteurs Diesel

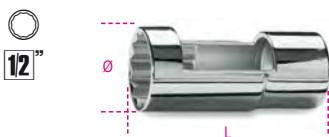

mm	Ø mm	L mm	CHF		
27	36,5	77	65.00	2	009600017

960BC/C5

coffret de 5 douilles pour injecteur

définir le contenu:

- 1 douille hexagonale ouverte, 25 mm
- 1 douille hexagonale ouverte, 27 mm
- 1 douille hexagonale ouverte, 29 mm
- 1 douille hexagonale ouverte, 30 mm
- 1 douille bi-hexagonale, 28 mm



12" 22 mm

960BC/C5	CHF		
	200.00	1	009600280

280x160x55 mm - 1,9 kg

960ER

Extracteur de joint d'injecteur avec marteau à inertie



L mm	CHF		
350	80.00	1	009600726

960F

Douille à encoches pour écrous porte-injecteurs



Ø mm	Ø1 mm	1 mm	2 mm	CHF		
28,3	22	32	22	51.50	1	009600148

960G

Douille longue pour écrous à encoches pour poids-lourds Mercedes-Benz



Ø mm	Ø1 mm	mm	L mm	CHF		
28,5	22	32	122	54.50	1	009600151

960L

Douille à encoches pour écrous porte-injecteurs



Ø mm	Ø1 mm	L mm	CHF		
30	22	122	59.00	1	009600153

960M

Douille à encoches pour écrous porte-injecteurs

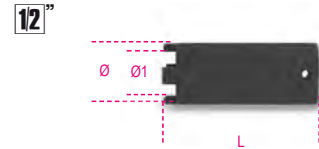

Ø mm	Ø1 mm	L mm	CHF		
28,5	22	72	43.50	1	009600154

960H/C4

Jeu de douilles à encoches pour écrous porte-injecteurs



960H/C4	CHF		
	155.50	1	009600152

960SL

Douille pour sonde Lambda

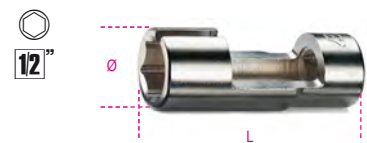

	Ø mm	CHF		
960SL 85	33	77.50	2	009600085
○ 22xL= 85 mm				
960SL 110	33	88.00	2	009600110
○ 22xL= 110 mm				

960SN

Douille à cardan pour bougies de préchauffage des moteurs diesel



mm	Ø mm	mm	L mm	CHF		
8	12,0	1/4	60	65.50	2	009600834
9	13,3	1/4	60	65.50	2	009600835
10	14,5	3/8	70	78.00	2	009600836

960T/C11

Jeu de douilles
pour élimination/installation
capteurs

Compris dans le kit :

- 1 douille 6 pans double mesure 1"-11/16" pour capteurs de pression huile
- 1 douille 6 pans ouverte 29 mm pour capteurs oxygène
- 1 douille 12 pans ouverte 27 mm pour injecteurs
- 1 douille 6 pans ouverte 22 mm pour vacuomètre
- 1 douille 6 pans ouverte 22 mm longueur 80 mm pour capteurs oxygène
- 1 douille 6 pans ouverte 22 mm longueur 90 mm pour capteurs oxygène
- 1 douille 6 pans ouverte 22 mm compacte longueur 30 mm pour capteurs oxygène
- 1 douille 6 pans ouverte 22 mm compacte longueur 50 mm pour capteurs oxygène
- 1 douille 6 pans et 12 pans ouverte 22 mm compacte longueur 34 mm, pour capteurs oxygène
- 1 douille 6 pans ouverte 22 mm avec géométrie à tube
- 1 taraud M18x1,5



○ 22 - 29 mm

960T/C11 CHF 257.00 1 009600031
≡ 330x270x25 mm

960T/A

Douille 6 pans ouverte 29 mm
pour capteurs oxygène



960T/A CHF 30.00 1 009600032
mm L
29 90

960T/B

Douille 13 pans ouverte 27 mm
pour injecteurs

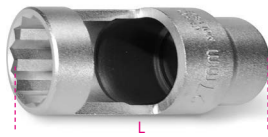

960T/B CHF 26.50 1 009600033
mm L
27 85

960T/C

douille 6 pans ouverte 22 mm
pour vacuomètre

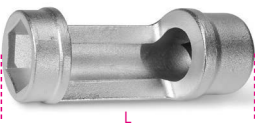

960T/C CHF 23.40 1 009600034
mm L
22 88

960T/F

Douille 6 pans double mesure 1" - 1 1/16"
pour capteurs de pression huile



960T/F CHF 18.40 1 009600037
1 - 1 1/16 mm L
28 74

960T/G

douille 6 pans ouverte 22 mm
avec géométrie à tube



960T/G CHF 52.00 1 009600038
mm mm L
22 25 98

960T/H

Douille 6 pans et 12 pans ouverte 22 mm
compacte longueur 34 mm, pour capteurs
oxygène

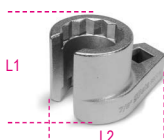

960T/H CHF 19.50 1 009600039
mm L1 L2
22 34 55

960/22EP

Clé à chaîne à double empreinte
pour sondes Lambda

Grande versatilité d'utilisation grâce à la double empreinte
hexagonale/polygonale et à l'articulation à 180°



960/22EP CHF 70.00 1 009600052
L mm mm
300 22 22

960/C6

Douille 6 pans avec carré femelle 3/8"
pour retirer et/ou installer les capteurs de
température de gaz d'échappement

Le kit comprend :

- 3 tailles en version courte 13, 14, 17 mm
- 3 tailles en version longue 13, 14, 17 mm



960/C6 CHF 108.50 1 009600055
≡ 170x120x50 mm

960/D

Clé 6 pans ouverte version longue
pour retrait/installation capteurs de
température gaz d'échappement



960/D CHF 16.90 1 009600073
mm
13 16.90 1 009600074
14 16.90 1 009600077
17 20.30 1 009600077

960YP

Clé 6 pans ouverte coudée pour retrait/installation capteurs de température de gaz d'échappement

38"



mm	CHF	1	009600063
13	17.90	1	009600063
14	18.50	1	009600064
17	24.70	1	009600067

960AVE

Outil pour le contrôle des injecteurs électroniques Diesel Common Rail



960AVE	CHF	1	009600245
	346.00	1	009600245

3 430x310x50 mm - 2,0 kg

960EPC/L

Jeu d'outils pour l'extraction de la pointe électrode des bougies de préchauffage M8x1 - M9x1 - M10x1 - M10x1,25



ZONA DI ROTTURA

960EPC/L	CHF	1	009600890
	1,137.00	1	009600890

3 270x230x80 mm - 2 kg

960E-PI/P

Extracteur de joints d'injecteurs

• Filet mâle M10 pour utilisation avec masse à inertie



960E-PI/P	CHF	1	009600706
	89.00	1	009600706

3 300x90x60 mm

960KC-M8/M9/M10

Composition d'outils pour le démontage des bougies de préchauffage cassées ou endommagées

• Pour bougies avec filetage M8-M9-M10



960KC-M8/9/10	CHF	1	009600801
	575.00	1	009600801

3 380x290x50 mm - 2,3 kg

960KPC

Extracteur réversible à (vibration) "percussion" à couple réglable pour bougies de préchauffage Couple réglable à 4 positions 10-20-30-40 Nm

14"

CE



960KPC	CHF	1	009600780
	414.00	1	009600780

3 8-9-10-11-12 mm
3 420x185x60 mm - 2,8 kg

960UC

Composition d'outils pour l'extraction des bougies bloquées avec crayon déformé M8-M9-M10



960UC	CHF	1	009600900
	660.00	1	009600900

3 270x230x80 mm - 2,6 kg

960P

Testeur de contrôle pression/dépression avec accessoires et adaptateurs



960P	CHF	1	009600777
	341.00	1	009600777

3 350x320x95 mm - 1,9 kg

960PI

Composition d'alésoires pour le nettoyage des sièges des injecteurs en coffret plastique

Pour éliminer les résidus présents dans les sièges des injecteurs

- Alésoir plat de Ø 19 - 15 mm pour injecteurs universels
- Alésoir plat de Ø 17 - 17 mm pour injecteurs Delphi/Bosch (BMW/PSA/Renault/Ford)
- Alésoir plat de Ø 19 - 17 mm pour injecteurs Bosch (Mercedes CDI).
- Alésoir d'angle de Ø 21 - 17 mm pour injecteurs Fiat/Iveco.
- Poignée



960PI	CHF	1	009600215
	158.50	1	009600215

3 250x130x50 mm - 600 g

960PI/C19

Composition de 19 outils pour le nettoyage des sièges des injecteurs

Compris dans le kit:

- 11 alésoirs plats de Ø: 14/14 mm - 15,5/15,5 mm - 15/19 mm - 17/19 mm - 17/17,5 mm - 17/19 mm - 17/19,5 mm - 17/20 mm - 18/21 mm - 19 mm - 20/21 mm
- 4 alésoirs d'angle de Ø: 15,5/15,5 mm - 17/17 mm - 17,5/20,5 mm - 17/21 mm
- Poignée et accessoires pour l'utilisation des forets



960PI/C19 CHF 398.00 1 009600217
360x230x60 mm

960PI/K36

Kit de brosses de nettoyage des sièges d'injecteurs



DIN 3126 E6,3

960PI/K36 CHF 250.00 1 009600218
350x255x74 mm 1253 g

960PI/S

Kit de nettoyage des sièges injecteurs

Compris dans le kit :

- 3 brosses en acier Ø 18, 22, 25 mm pour le nettoyage du siège des injecteurs
- 2 brosses Ø 14 et 16 mm pour le nettoyage du fond du siège des injecteurs
- 6 bouchons pour occlusion orifice de connexion chambre de combustion
- 1 écouvillon pour nettoyage orifice connexion chambre de combustion
- 1 porte-embouts flexible avec branche



960PI/S CHF 210.00 1 009600214
360x140x50 mm - 700 g

960VTC

Instrument de contrôle des fuites des cylindres sur moteurs à essence

Suite à l'introduction d'air comprimé dans le cylindre, le manomètre permet de vérifier la présence d'éventuelles fuites de compression.



960VTC CHF 366.00 1 009600261
373x295x70,6 mm - 2,3 kg

960RPI

Souffleur pneumatique pour le nettoyage des conduits d'injecteurs

Pour moteurs avec bougies M8x1 - M9x1 - M10x1 - M10x1.25



960RPI CHF 254.00 1 009600940

960PMC

Pompe à tarer les injecteurs Diesel



Bar Max. 600 CHF 1,001.00 1 009600200

961P6

Vidéoscope électronique avec sonde flexible



- Possibilité d'utiliser des Cartes SD (8 Go)
 - Supporte mémoires Flash (8 Go)
 - Mémoire interne de 128 Mo
 - Sortie TV-OUT
 - Supporte les formats vidéo (MP4, AVI, 3GP)
 - 4 Leds d'éclairage
 - Alimentation par prise USB (pile incorporée)
- CARACTÉRISTIQUES TECHNIQUES**
- Pixels du capteur : 640x480
 - Résolution maximum : 320x240
 - Longueur sonde : 1 m
 - Diamètre chambre : 6 mm
 - Formats vidéo : MPEG4, 3GP, AVI, ASF
 - Formats photos : JPEG
 - Angle de prise de vue : 0 ± 180°
 - Sortie données : câble USB et carte SD
 - Alimentation : pile 3,7 V - 2000 mAh

961P6 CHF 986.00 1 009610000

961P6/S

Sonde flexible, 6 mm



	L mm	CHF		
961P6/S 1	1000	427.00	1	009610006
961P6/S 2	2000	477.00	1	009610262
961P6/S 3	3000	539.00	1	009610263

962

Levier démonte-pneus



L mm	A mm	CHF		
300	21	31.50	5	009620003
400	25	38.00	5	009620004
500	27	49.00	3	009620005
600	27	64.00	3	009620006

962C



962C 277

Beta

962P

Levier démonte-pneus avec protection en caoutchouc anti-rayures



L mm	A mm	CHF	1	009620049
490	25	119.00		

962M

Outil pour démontage/montage pneus

particulièrement indiqué pour Runflat et modèles

avec épaules abaissées

- Mâchoires antirayures pour blocage sur jantes
- Siège pour installation levier démonte-pneus



962M	CHF	1	009620501
	427.00		

963

Pince levier à broche et palette



L mm	A mm	CHF	5	009630001
400	23	48.50		

964

Pince levier à broche et à bec



L mm	A mm	CHF	5	009640001
400	46	44.00		

965

Levier plat coudé



L mm	A mm	L1 mm	CHF	2	009650013
300	16	185	22.50		
450	20	312	31.50		
600	20	462	37.00		



965/S3	CHF	1	009650019
	91.00		

966/C3

Jeu de 3 leviers avec une tête articulée courbe



966/C3	CHF	1	009660103
L=200-250-300 mm	168.00		

355x140x65 mm - 1,8 kg

720LS

Douille à chocs, série longue et fine

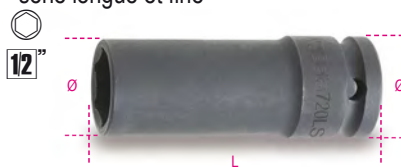

720LS 36	Ø mm	L mm	Ø1 mm	CHF	2	007200386
	36	48,0	78	29		

969B

Douilles de serrage pour écrous de moyeux



Ø mm	Ø mm	L mm	CHF	1	009690124
24	36,0	76	28.50		
27	36,0	76	29.00		
30	40,0	76	30.00		
31	42,0	76	30.50		
32	42,5	76	33.00		
34	45,0	76	36.50		
35	46,0	76	37.00		
36	49,0	76	42.50		

969/C5

Jeu de 5 douilles de serrage pour écrou de moyeu en coffret plastique

12"



969/C5	CHF	1	009690201
	179.00		

969B 30-32-34-35-36

970B

Douille de serrage pour écrou de moyeu Fiat Daily

1"

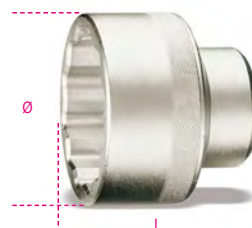

Ø mm	Ø mm	L mm	CHF	1	009700010
65	88	75	139.00		

970IVECO

Douille à ergot pour écrous de moyeu Iveco Daily

Pour les versions à partir de l'année 2014

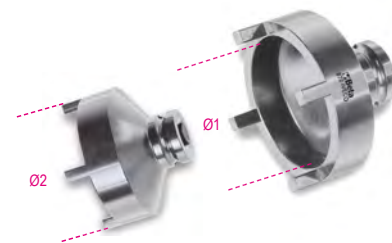

Ø1 mm	Ø2 mm	CHF	1	009700011
61,5	74,8	83.50		

Beta
Quality Tools

Beta

971/C8

Kit d'intervention pour valves de roues pilotées TPMS



971/C8 CHF 528.00 1 009710108

	583/6	1,2+6 Nm
	892/0	
	862TX	T10-T15-T20
	900L	11-12 mm
	986 78	

972/C4BMW

Coffret de démontage d'écrous antivol BMW et Mini



972/C4 BMW CHF 305.00 1 009720004

516x145x66 mm - 3,8 kg

972/C10

coffret de démontage d'écrous antivol ou de roue endommagés

Pour une utilisation sur les écrous antivol et conventionnels



972/C10 CHF 386.00 1 009720010

290x250x60 mm - 2,4 kg

973

Kit de 4 housses de protection en nylon pour roues

Apte pour jantes de :
14" à 18" code 009730014
19" à 22" code 009730019



- conserve et protège la roue contre les éventuelles rayures et contre la poussière ;
- pendant le stockage, prévient la détérioration précoce des polymères du pneumatique d'été ou d'hiver ;
- au moyen d'une icône d'identification, permet de trouver aisément la position de la roue (avant droite/gauche ou arrière droite/gauche) ;
- dotées de poignée pour un transport aisé ;
- tissu : nylon, lavable.

973 14-18 CHF 134.50 1 009730014
973 19-22 CHF 149.50 1 009730019

978 - 979

Clé en croix pour écrous de roues

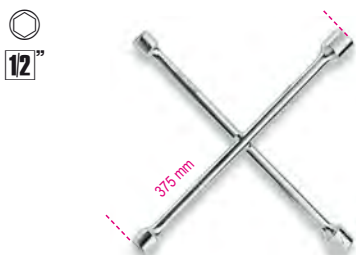

UNI/ISO 6788 DIN 3119

978 CHF 85.50 2 009780001
17x19x21x22 mm
979 CHF 85.50 2 009790001
17x19x22x1/2 mm

982

Clé en croix pour écrous de roues

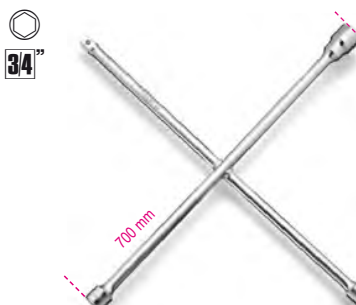

UNI/ISO 6788 DIN 3119

24x27x32x3/4 mm CHF 207.00 1 009820001

983PM

Brosse abrasive pour le nettoyage des moyeux



Ø1 90 mm
Ø2 150 mm
CHF 100.00 1 009830010

983 PM/R-DA

Paire de disques abrasifs pour 983PM



Ø mm 150
CHF 92.50 1 009830050

984

Pince pour caches-écrous de roues



L mm 195
H mm 4
CHF 34.00 1 009840005

985/B7

Assortiment de 7 pivots guide pour montage roues

Mesures comprises :

- M12x1,25 mâle
- M12x1,25 femelle
- M12x1,5 mâle
- M12x1,5 femelle
- M14x1,25 mâle
- M14x1,5 mâle
- M16x1,5 mâle



C985/B7 CHF 132.50 1 009850007



985M

Pivot guide mâle pour montage roues



	L mm	CHF		
985M M12X1,25	150	17.20	1	009850101
985M M12X1,50	150	17.20	1	009850102
985M M14X1,25	150	17.90	1	009850103
985M M14X1,50	150	17.90	1	009850104
985M M16X1,50	150	19.60	1	009850105

985F

Pivot guide femelle pour montage roues



	L mm	CHF		
985F M12X1,25	150	23.10	1	009850106
985F M12X1,50	150	24.40	1	009850107

986 48

Tournevis pour valves pneus modèle court

Retenue automatique de la valve



L mm	L1 mm	CHF		
18	48	19.60	1	009860048

986 78

Tournevis pour valves de pneus

Retenue automatique de la valve



L mm	L1 mm	CHF		
18	78	19.60	1	009860078

986PT

Tournevis pré-étalonné 0,4 Nm pour vanes pneumatiques

Retenue automatique de la vanne

Le mécanisme de glissement permet de ne pas endommager le joint du centre de la vanne



L mm	L1 mm	CHF		
19	120	69.00	1	009860140

987

Levier pour valves pneus avec protection en caoutchouc



L mm	CHF		
310	40.50	1	009870001

987AR

Levier pour vanes pneumatiques avec centre anti-rayures

- Centre en caoutchouc et nylon pour jantes en alliage et en fer
- Branchement rapide de la vanne, ne nécessite pas de vissage

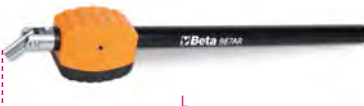

L mm	CHF		
305	132.50	1	009870021

987P

Levier pour valves pneus en plastique

Tournevis dans le manche pour agir sur le mécanisme présent à l'intérieur de la valve



L mm	CHF		
335	33.50	1	009870011

988/K4

Jeu de 4 burins en plastique anti-rayures



	CHF		
988/K4	35.50	1	009880104

A= 19-21-25-38 mm

989

Pince à masses d'équilibrage



L mm	CHF		
250	64.00	2	009890001

989A

Pince pour retrait des plombs adhésifs équilibrage des roues



Profil des becs expressément étudié pour extraire les plombs sans contact avec la jante

	L mm	CHF		
989A	220	43.50	1	009890011

989B

Pince pour masse d'équilibrage

les fonctions:

- suppression des poids adhésifs pour les jantes en alliage
- suppression des poids pour les jantes en fer
- marteau avec revêtement PE-HD amovible pour poids adhésifs et jantes en fer
- mâchoires de poids pour jantes en fer



L mm	CHF		
230	82.50	1	009890015

Beta
Quality Tools

990

Bruelles à becs droits pointes fines arrondies striées finition polie en acier inoxydable



L mm 130 CHF 15.80 5 009900001

991

Bruelles à becs coudés pointes fines arrondies striées finition polie en acier inoxydable



L mm 130 CHF 19.00 5 009910001

992

Bruelles à becs droits avec guide pointes fines arrondies striées finition polie en acier inoxydable



L mm 150 CHF 20.00 5 009920001

993

Bruelles à becs coudés avec guide pointes fines arrondies striées finition polie en acier inoxydable



L mm 145 CHF 21.50 5 009930001

993PL

Bruelles à becs coudés gainées PVC pointes fines arrondies striées finition polie en acier inoxydable



L mm 150 CHF 21.50 3 009930010

993G

Bruelles à becs coudés avec guide pointes arrondies striées finition polie en acier inoxydable



L mm 160 CHF 19.60 3 009930030

994

Bruelles à becs droits arrondis pointes larges striées finition polie en acier inoxydable



L mm 150 CHF 16.40 5 009940001

994PL

Bruelles à becs droits arrondis gainées PVC pointes larges striées en acier inoxydable



L mm 150 CHF 19.60 3 009940010

994TF

Bruelles à becs droits arrondis résistant aux acides, antimagnétique pointes larges striées finition semi-polie en acier inoxydable



L mm 150 CHF 26.00 3 009940020

996

Bruelles à becs spatulés pointes droites lisses finition polie en acier inoxydable



L mm 150 CHF 17.40 5 009960001

998

Bruelles à becs droits auto-serrants, pointes larges becs croisés striés finition polie en acier inoxydable



L mm 155 CHF 30.00 5 009980001

999

Bruelles à becs plats arrondis résistant aux acides, antimagnétique pointes lisses finition semi-polie en acier inoxydable



L mm 115 CHF 23.80 3 009990011

999A

Bruelles à becs courts type aiguille résistant aux acides, antimagnétique pointes lisses finition semi-polie en acier inoxydable



L mm 120 CHF 20.60 3 009990015

999B

Bruelles à becs droits puissants résistant aux acides, antimagnétique pointes lisses finition semi-polie en acier inoxydable



L mm 120 CHF 21.10 3 009990017

999C

Bruelles à becs droits type aiguille résistant aux acides, antimagnétique pointes lisses finition semi-polie en acier inoxydable



L mm 110 CHF 23.10 3 009990019

999D

Brucelles à becs coudés dégagés type aiguille résistant aux acides, antimagnétique pointes lisses finition semi-polie en acier inoxydable



L mm 115 CHF 25.50 3 009990021

999E

Brucelles à becs coudés type aiguille résistant aux acides, antimagnétique pointes lisses finition semi-polie en acier inoxydable



L mm 120 CHF 23.10 3 009990023

999G

Brucelles à becs droits avec blocage type aiguille résistant aux acides, antimagnétique becs croisés lisses finition semi-polie en acier inoxydable



L mm 140 CHF 23.10 3 009990027

999/B6N

ensemble de 6 pinces à épiler, résistant aux acides et au magnétisme



999/B6N CHF 148.00 1 009990060
999-999A-999B
999C-999D-999E

1002

Pince à anneaux auto-bloquante, becs arrondis striés, en acier inoxydable



L mm 160 CHF 37.00 2 010020001

1008

Pince à becs plats longs striés branches gainées avec double couche de PVC antidérapant

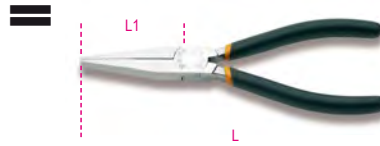

ISO 5745

L mm 160 L1 mm 51,5 CHF 34.00 5 010080006

1008BM

Pince à becs plats longs striés branches gainées confort bi-matières



ISO 5745

L mm 160 L1 mm 51,5 CHF 41.50 3 010080036

1009

Pince extra-longue à becs demi-ronds striés, branches gainées avec double couche de PVC antidérapant



ISO 5745

L mm 160 L1 mm 56,5 CHF 34.00 2 010090006

1009L/A

Pince extra-longue à becs demi-ronds striés branches gainées avec double couche de PVC antidérapant



L mm 283 L1 mm 80 CHF 41.50 2 010090008

1009L/B

Pince extra-longue à becs demi-ronds striés coudés à 45° branches gainées avec double couche de PVC antidérapant



L mm 273 L1 mm 73 CHF 42.00 2 010090009

1009L/C

Pince extra-longue à becs demi-ronds striés coudés à 90° branches gainées avec double couche de PVC antidérapant



L mm 253 L1 mm 45 CHF 44.50 2 010090010

Beta

Beta

1009L/D

Pince extra-longue à becs demi-ronds striés avec double articulation, branches gainées avec double couche de PVC antidérapant



1009L/DP

Pince extra-longue à becs demi-ronds striés soudés à 45°, avec double articulation, branches gainées avec double couche de PVC antidérapant



1009L/DP-S2

Jeu de 2 pinces extra-longues à becs demi-ronds striés avec double articulation



1009L/DP-S2

CHF 99.00

1 010090060

1010

Pince à becs ronds long striés branches gainées avec double couche de PVC antidérapant

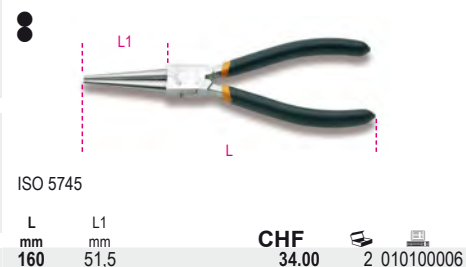

1010BM

Pince à becs ronds long striés branches gainées confort bi-matières



PINCES CIRCLIPS (TYPE SEEGER)

ALIGNEMENT PARFAIT

Des tests ont montré que les pinces circlips de type Seeger de Beta offrent une excellente résistance à l'usure grâce à la géométrie spéciale des pointes obtenue grâce à la technologie du formage à froid.



RUPTURE DE POINTE RÉDUITE

Les pinces Beta sont équipées de pointes pressées à froid, qui permettent d'offrir une longévité accrue lors de son utilisation ou en cas de chute accidentelle.



1031/S4

Jeu de 4 pinces pour circlips



1031/S4

1032 180 ○ 19 ÷ 60 mm

1034 170 ○ 19 ÷ 60 mm

1036 175 ● 19 ÷ 60 mm

1038 175 ● 19 ÷ 60 mm

CHF 145.50

1 010310000

1032

Pince pour circlips intérieurs à becs droits



UNI 7914 DIN 5256

L mm 140x0,9
L mm 140x1,3
L mm 180
L mm 225
L mm 300

Ø mm 8÷12
Ø mm 12÷25
Ø mm 19÷60
Ø mm 40÷100
Ø mm 85÷200

CHF 32.00
CHF 31.50
CHF 34.00
CHF 42.00
CHF 59.00

5 010320013
5 010320014
5 010320017
3 010320021
2 010320028

1033

Pince pour circlips intérieurs à becs soudés à 45°



UNI 7914 DIN 5256

L mm 140x0,9
L mm 140x1,3
L mm 180
L mm 225

Ø mm 8÷12
Ø mm 12÷25
Ø mm 19÷60
Ø mm 40÷100

CHF 36.50
CHF 35.50
CHF 37.00
CHF 46.00

5 010330013
5 010330014
5 010330017
3 010330021

1034

Pince pour circlips intérieurs à becs soudés à 90°



UNI 7914 DIN 5256

L mm 130x0,9
L mm 130x1,3
L mm 170
L mm 210
L mm 290

Ø mm 8÷12
Ø mm 12÷25
Ø mm 19÷60
Ø mm 40÷100
Ø mm 85÷200

CHF 36.50
CHF 35.50
CHF 37.00
CHF 46.00
CHF 65.00

5 010340013
5 010340014
5 010340017
3 010340021
2 010340028

1034L

Pince pour circlips intérieurs
à becs longs coudés à 90°



L mm	∅ mm	CHF	Hand icon	Computer icon
190	40÷100	93.50	2	010340320

1036

Pince pour circlips extérieurs
à becs droits



UNI 7915 DIN 5254

L mm	∅ mm	CHF	Hand icon	Computer icon
140x0,9	3÷10	34.50	5	010360013
140x1,3	10÷25	34.00	5	010360014
175	19÷60	35.50	5	010360017
225	40÷100	44.50	3	010360021
300	85÷200	70.00	2	010360028

1037

Pince pour circlips extérieurs
à becs coudés à 45°



UNI 7915 DIN 5254

L mm	∅ mm	CHF	Hand icon	Computer icon
140x0,9	3÷10	39.00	5	010370013
140x1,3	10÷25	37.00	5	010370014
175	19÷60	39.00	5	010370017
225	40÷100	47.50	3	010370021

1038

Pince pour circlips extérieurs
à becs coudés à 90°



UNI 7915 DIN 5254

L mm	∅ mm	CHF	Hand icon	Computer icon
135x0,9	3÷10	39.00	5	010380013
135x1,3	10÷25	37.00	5	010380014
175	19÷60	39.00	5	010380017
220	40÷100	47.50	3	010380021
300	85÷200	75.50	2	010380028

Beta

1039

Pince pour circlips réversible
à becs droits



L mm	∅ mm	∅ mm	CHF	Hand icon	Computer icon
150	10÷15	6÷25	82.00	2	010390015

1558/C4

Outil pour circlips de moyeux intérieurs et extérieurs
avec actionnement à vis

Le coupleur carré 3/8" permet d'appliquer une force élevée dans les deux conditions d'utilisation

Ergots fournis :
∅ 2,5-3-3,5 mm



∅ mm	∅ mm	CHF	Hand icon	Computer icon
1558/C4 5,5 ÷ 77	5,5 ÷ 77	220.50	1	015580100

330x220x50 mm - 900 g

1044N

Pince multiprise en traitement phosphatée à crémaillère, avec branches munies d'une protection PVC antidérapante

· Modèle 8 positions



L mm	A max mm	L1 mm	CHF	Hand icon	Computer icon
250	46	48	32.00	5	010440025

1047

Pince multiprise entrecroisée avec bouton de réglage, poignées recouvertes de 2 couches de PVC antiglisse

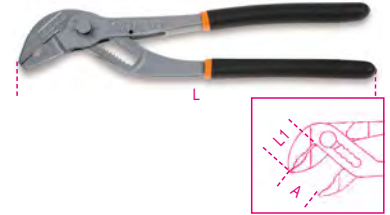

L mm	A max mm	L1 mm	CHF	Hand icon	Computer icon
180	30	29	55.00	2	010470180
240	36	35	59.00	2	010470240
300	50	48	85.00	1	010470300

1047BM

Pince multiprise entrecroisée avec bouton de réglage, branches bi-matière

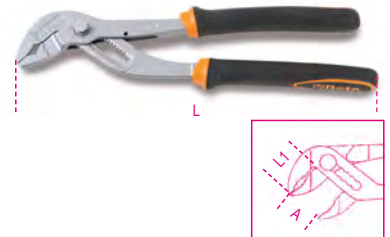

L mm	A max mm	L1 mm	CHF	Hand icon	Computer icon
240	36	35	67.50	2	010470340

Beta

1048N - POLIGRIP PINCE MULTIPRISE ENTREPASSÉE

ADHÉRENCE EXCEPTIONNELLE ET
AGREABLE MANIABILITÉ

- Géométrie et angle des dents conçue pour une prise efficace et sûre sur les profils hexagonaux et cylindriques
- Dents soumises à un processus de trempe par induction pour améliorer la durée de vie.
- Largeur supérieure de l'angle tête-branche pour une meilleure ergonomie
- Butée du manche afin d'éviter toute blessure accidentelle de la main
- Branches en PVC antidérapant innovant
- Manipulation et confort extraordinaires grâce à la surface de contact améliorée de la branche



1048N

Pinces multiprise entrepassées
branches gainées avec PVC antidérapant



ISO 8976

L mm	A max mm	L1 mm	S mm	CHF	🔧	📦
175	36	31	11	34.50	3	010480910
250	46	38	13	36.50	5	010480915
300	60	44	14.8	54.50	2	010480920
400	96	81	19	100.50	1	010480940

1048N/D3

Jeu de pinces multiprise entrepassées

Tête phosphatée



1048N/D3
175-250-300 mm

CHF 126.00 1 010480923

1048BM

Pinces multiprise entrepassées branches
bimatières

• nouveau modèle neuf positions



ISO 8976

L mm	A max mm	L1 mm	CHF	🔧	📦
250	48	39	58.00	3	010480215

1048VN

Pinces multiprise entrepassées
vernies orange

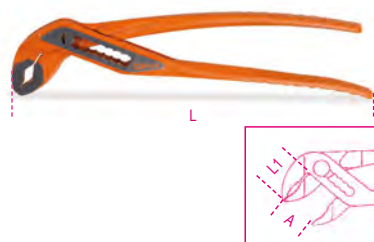

ISO 8976

L mm	A max mm	L1 mm	CHF	🔧	📦
175	36	31	34.00	3	010480111
250	46	38	39.00	5	010480116
300	60	44	57.00	2	010480121

1050

Pinces-étau à becs courts



L mm	CHF	🔧	📦
220	103.50	2	010500022

1051

Pinces-étau à becs longs



L mm	CHF	🔧	📦
255	113.00	2	010510025

1051GM

Pinces-étau à becs longs articulés

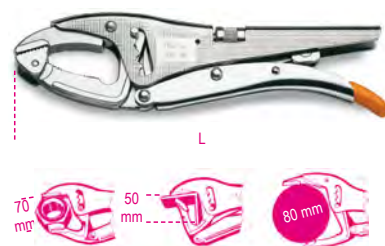

L mm	CHF	🔧	📦
255	121.00	2	010510250

1051L

Pinces-étau à becs longs
grande capacité



L mm	CHF	🔧	📦
270	129.00	2	010510100

1051XL

Pinces-étau à becs extra-longues
grande capacité



L mm	CHF	🔧	📦
270	155.00	2	010510140

1052

Pinces-étau universelle
à mâchoires concaves



L mm	A1 max mm	CHF	🔧	📦
140	22	34.50	3	010520014
190	36	39.00	3	010520019
240	42	42.00	3	010520024
300	55	70.00	2	010520030

1053

Pince-étau à bec inférieur pivotant

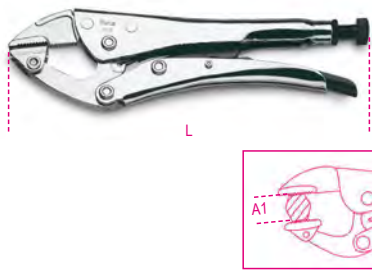

L mm	A1 max mm	CHF		
240	35	59.00	2	010530024

1054

Pince-étau à becs droits

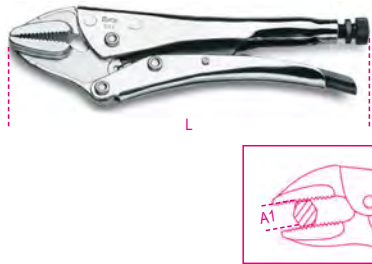

L mm	A1 max mm	CHF		
235	40	51.50	2	010540022

1055

Pince-étau à becs arrondis

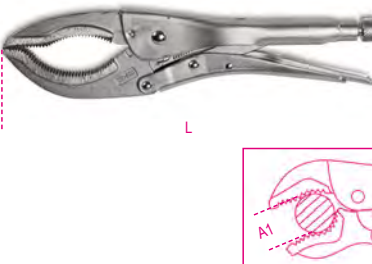

L mm	A1 max mm	CHF		
270	75	46.00	2	010550027

1055D

Pince-étau pour écrous et profilés cylindriques

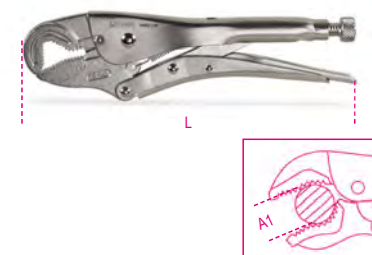

L mm	A1 max mm	CHF		
195	22	36.00	2	010550119
235	43	40.50	2	010550123

1056

Pince-étau pour frigoristes pour frigoristes

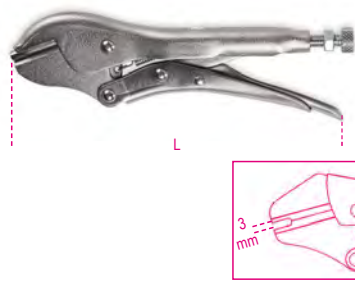

L mm	CHF		
195	35.50	2	010560017

1057A

Pince-étau automatique avec réglage de la force



L mm	CHF		
240	72.50	2	010570124

1058

Pince-étau à becs longs et fins

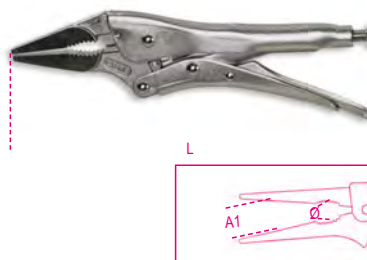

L mm	A1 max mm	Ø max mm	CHF		
175	34	26	44.00	2	010580017
225	46	31	52.50	2	010580025

1059

Pince-étau serre-joints

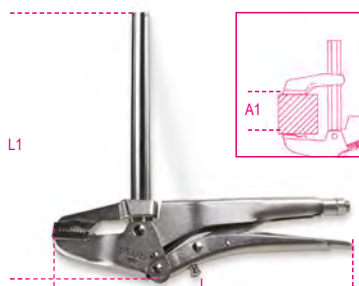

L1 mm	L mm	A1 mm	CHF		
160	255	120	78.50	1	010590016
270	255	220	82.50	1	010590027

1060

Pince-étau pour cornières

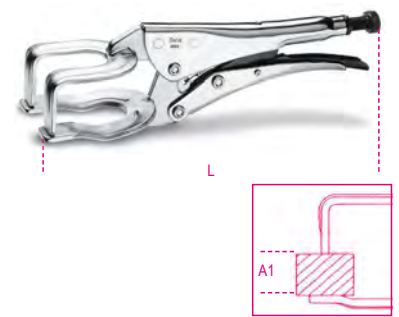

L mm	A1 max mm	CHF		
200	50	56.00	2	010600020
280	80	70.50	2	010600028

1061

Pince-étau pour tubes

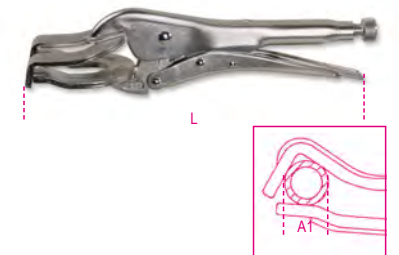

L mm	A1 max mm	CHF		
275	80	60.50	2	010610027

1062

Pince-étau col de cygne

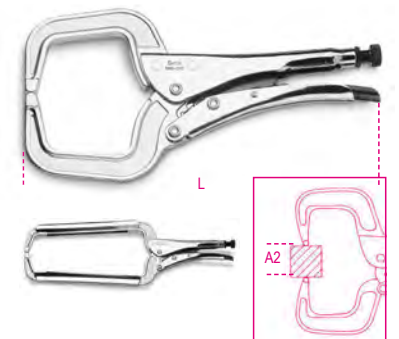

L mm	A2 max mm	CHF		
170	50	43.50	2	010620017
290	120	57.50	2	010620029
460	255	82.00	1	010620045



1062AL

Pince-étau col de cygne "soudure à l'arc" en aluminium

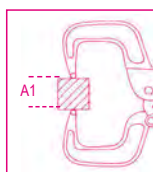

L mm	A1 max mm	CHF	Icon	Icon
275	88	76.00	2	010620327

1062GM

Pince-étau col de cygne à mâchoires orientables

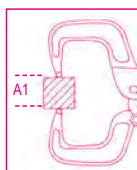

L mm	A1 max mm	CHF	Icon	Icon
170	45	47.00	2	010620217
290	88	67.00	2	010620229
460	255	94.00	1	010620245

1063

Pince-étau de tôlier

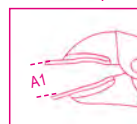

L mm	A1 max mm	CHF	Icon	Icon
200	31	56.50	2	010630021

1064

Pince-étau à chaîne



L mm	Ø mm	CHF	Icon	Icon
230	150	80.50	2	010640023

1065F

Pince à poinçonner



Ø mm	L mm	CHF	Icon	Icon
5	228	154.50	1	010650010
6	228	155.50	1	010650015

1065P

Pince à plier

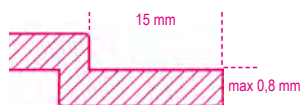

L mm	CHF	Icon	Icon
228	158.50	1	010650020

1066

Pince-étau verrouillage à 90°

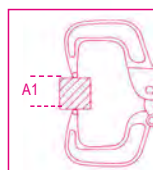

L mm	A1 max mm	g	CHF	Icon	Icon
210	55	500	106.50	1	010660021

1067

Pince-étau pour tubes, mâchoires bloque-tube articulées

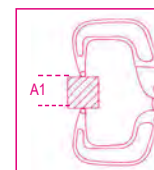

L mm	A1 max mm	CHF	Icon	Icon
285	76	67.50	1	010670285
380	89	69.50	1	010670380

1077

Pince à becs larges droits pour tôlier, branches gainées PVC



L mm	A mm	L1 mm	CHF	Icon	Icon
280	60	53	69.50	1	010770026

1078

Pince à becs larges coudés à 45° pour tôlier, branches gainées PVC



L mm	A mm	L1 mm	CHF	Icon	Icon
280	60	77	70.50	1	010780026

1080D

Pince coupante diagonale branches gainées avec double couche de PVC antidérapant

Pour la coupe des matériaux tendres



α	L mm	L1 mm	CHF	Icon	Icon
15°	160	22	37.00	3	010800015
45°	160	22	44.50	3	010800045

1081

Pince coupante semi-rase
branches gainées avec double couche
de PVC antidérapant

• Pour micromécanique et électronique contraignantes



L	L1	CHF	Hand	Computer
mm	mm			
125	16	38.50	3	010810130

1082

Pince coupante diagonale,
chromée,
branches gainées avec double couche de
PVC antidérapant



L	L1	mm	CHF	Hand	Computer
mm	mm	mm			
140	20	1,6	33.50	5	010820004
160	22	1,6	34.50	5	010820006

1082G

Pince coupante diagonale,
branches gainées avec
double couche de PVC antidérapant,
 finition industrielle



L	L1	mm	CHF	Hand	Computer
mm	mm	mm			
140	20	1,6	28.50	5	010820064
160	22	1,6	30.00	5	010820066

1082BM

Pince coupante diagonale,
branches gainées confort bi-matières



L	L1	mm	CHF	Hand	Computer
mm	mm	mm			
140	20	1,6	41.50	3	010820034
160	22	1,6	45.00	3	010820036

1082GBM

Pince coupante diagonale,
branches gainées confort bi-matières,
 finition industrielle



L	L1	mm	CHF	Hand	Computer
mm	mm	mm			
140	20	1,6	36.50	3	010820264
160	22	1,6	41.00	3	010820266

1084

Pince coupante diagonale
à faible effort de coupe,
chromée,
branches gainées avec double couche de
PVC antidérapant



L	L1	mm	CHF	Hand	Computer
mm	mm	mm			
160	22	1,6	39.00	5	010840006
200	28	2,0	48.50	3	010840010

1084G

Pince coupante diagonale
à faible effort de coupe,
branches gainées avec double couche
de PVC antidérapant,
 finition industrielle



L	L1	mm	CHF	Hand	Computer
mm	mm	mm			
160	22	1,6	34.00	5	010840066
200	28	2,0	42.00	3	010840070

1084BM

Pince coupante diagonale
à faible effort de coupe,
chromée,
branches gainées confort bi-matières



L	L1	mm	CHF	Hand	Computer
mm	mm	mm			
160	22	1,6	47.00	3	010840036
200	28	2,0	60.50	3	010840040

1084GBM

Pince coupante diagonale
à faible effort de coupe,
branches gainées confort bi-matières,
 finition industrielle



L	L1	mm	CHF	Hand	Computer
mm	mm	mm			
160	22	1,6	52.00	3	010840266
200	28	2,0	67.00	3	010840270

1088

Pince coupante frontale
à faible effort de coupe
branches gainées avec double couche
de PVC antidérapant

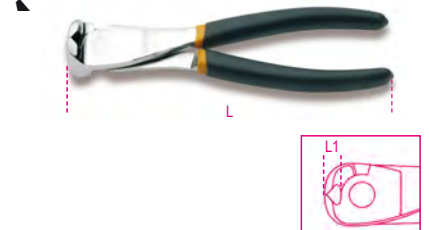

L	L1	mm	CHF	Hand	Computer
mm	mm	mm			
160	9	1,6	47.50	2	010880006
200	11	2,0	62.50	2	010880010

1088BM

Pince coupante frontale à faible effort
de coupe branches gainées confort bi-
matières



L	L1	mm	CHF	Hand	Computer
mm	mm	mm			
160	9	1,6	58.00	2	010880036
200	11	2,0	80.00	2	010880040



1092V

Pince coupante frontale articulée

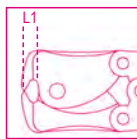

UNI/ISO 5748

L mm	L1 mm	$\frac{R}{mm}$	CHF		
180	8	2,0	191.00	2	010920280
200	9	2,5	201.50	2	010920310

1094V

Pince coupante diagonale articulée



UNI/ISO 5749

L mm	L1 mm	$\frac{R}{mm}$	CHF		
200	23	2,5	191.00	2	010940200

1095N

Pince coupante diagonale articulée



L mm	L1 mm	$\frac{R}{mm}$	CHF		
195	26	1,6	67.50	2	010950010

1096

Tenaille de menuisier



ISO 9243

L mm	L1 mm	CHF		
160	21	25.50	5	010960016
200	23	30.00	5	010960020
250	30	40.50	5	010960025

1098

Tenaille type russe



ISO 9242 DIN 5242

L mm	L1 mm	CHF		
190	12	25.50	5	010980190
220	13	29.00	5	010980220
250	15	34.50	5	010980250
280	18	38.50	5	010980280

1098PL

Tenaille type russe, branches gainées PVC



ISO 9242 DIN 5242

L mm	L1 mm	CHF		
220	13	32.00	5	010980320
250	15	37.00	5	010980350
280	18	41.00	5	010980380

1101

Coupe-boulons, poignées en caoutchouc et bras en acier tubulaire



L mm	L mm	CHF		
300	12	76.00	2	011010030
350	14	93.00	2	011010035
450	18	114.00	1	011010045
600	24	156.00	1	011010060
750	30	201.50	1	011010075
900	36	270.00	1	011010090

L mm	R = 80 Kgf=mm ² Ø mm	R = 140 Kgf=mm ² Ø mm	g	
300	5	4	745	
350	6	5	1043	
450	7	6	1537	
600	9	7	2540	
750	11	8	3870	
900	12	9	6170	

1101R

Lames pour 1101



mm	1101	CHF		
300	300	45.00	1	011010130
350	350	52.50	1	011010135
450	450	67.50	1	011010145
600	600	91.00	1	011010160
750	750	113.00	1	011010175
900	900	149.50	1	011010190

1102

Mini-coupe boulons

R= $\frac{R}{mm}$ 80 Kg/mm²



L mm	$\frac{R}{mm}$	CHF		
230	4	56.50	3	011020020

1103

Coupe-treillis à tête plate pour tiges, boulons et treillis électrosoudés à béton

Ø max. = 12 mm
Ø max. (HRC 48) = 6 mm



L mm	CHF		
950	202.50	1	011030090

1103R

Tête pour 1103



1103R 950	CHF		
	120.00	1	011030190



1104

Coupe-câbles gros effort pour câbles flexibles en acier branches en matière plastique



L mm	mm	CHF		
420	12	196.00	1	011040004
600	16	286.00	1	011040006

1104R

Lames pour 1104



mm	CHF		
420	121.50	1	011040014
600	169.00	1	011040016

1105

Emporte-pièces en acier



D mm	L mm	CHF		
2	27	19.60	1	011050002
3	27	19.60	1	011050003
4	27	19.60	1	011050004
5	27	19.60	1	011050005
6	27	19.60	1	011050006
7	27	19.60	1	011050007
8	27	19.60	1	011050008
9	27	19.60	1	011050009
10	27	19.60	1	011050010
12	27	24.10	1	011050012
14	27	24.10	1	011050014
16	27	24.10	1	011050016
18	27	24.10	1	011050018
20	27	24.10	1	011050020
22	32	30.00	1	011050022
24	32	30.00	1	011050024
26	32	30.00	1	011050026
28	32	30.00	1	011050028
30	32	30.00	1	011050030
32	37	39.00	1	011050032
34	37	39.00	1	011050034
36	37	39.00	1	011050036
38	37	39.00	1	011050038
40	37	39.00	1	011050040
42	42	46.00	1	011050042
44	42	46.00	1	011050044
46	42	46.00	1	011050046
48	42	46.00	1	011050048
50	42	46.00	1	011050050

1105T20

Poignée pour emporte-pièces 1105, 2-20 mm



L mm	CHF		
110	97.50	1	011050200

1105T30

Poignée pour 1105, 3-30 mm



L mm	CHF		
175	209.50	1	011050205

1105T50

Poignée pour 1105, 2-50 mm



L mm	CHF		
175	207.00	1	011050207

1105AD-50

Adaptateur pour 1105T50



Ø mm	CHF		
57	131.00	1	011050210

1105/C10T

Assortiment de 10 emporte-pièces, 3-20 mm, et 1 accessoire



	CHF		
1105C/10T	217.50	1	011050250

	1105		
		3 - 4 - 6 - 8 - 10 - 12 - 14 - 16 - 18 - 20 mm	

1105T20

135x92x32 mm

1105/C16T

assortiment de 15 emportes pièces , 3 à 30 mm, et 1 accessoire



	CHF		
1105C/16T	393.00	1	011050255

	1105		
		3 - 4 - 6 - 8 - 10 - 12 - 14 - 16 - 18 - 20 - 22 - 24 - 26 - 28 - 30 mm	

1105T30

240x210x60 mm

1105/C32T

assortiment de 29 emportes pièces, 2 à 50 mm, et 3 accessoires



	CHF		
1105C/32T	768.00	1	011050257

	1105		
		2 - 3 - 4 - 5 - 6 - 7 - 8 - 9 - 10 - 12 - 14 - 16 - 18 - 20 - 22 - 24 - 26 - 28 - 30 - 32 - 34 - 36 - 38 - 40 - 42 - 44 - 46 - 48 - 50 mm	

1105T50

1105AD-50

455x380x115 mm

1112

Cisaille type américain coupe droite

R= 60 Kg/mm²



L mm	L1 mm	S mm	A mm	CHF		
200	50	0,5	26	34.00	2	011120020
250	62	0,8	33	41.00	2	011120025
300	76	1,0	37	52.50	2	011120030
375	76	1,2	44	77.50	1	011120037

1114

Cisaille type américain bichantourneuse bec de canard

R = 60 Kgf/mm²



L	L1	S	A	CHF		
mm	mm	mm	mm			
250	58	0,5	15	36.50	1	011140265
350	76	1	22	47.50	1	011140340

1118

Cisaille anti-accidents pour feuillard

Fe = acier normal

Inox = acier inoxydable



L	L1	Fe	Inox	CHF		
mm	mm	S mm	S mm			
310	42	1	0,8	59.50	2	011180001

1120A

Cisaille grignoteuse

Fe = acier normal



L	Fe	CHF		
mm	S mm			
280	1,2	95.50	1	011200101

1120ARL - ARG

Lames pour article 1120A



	CHF		
1120ARL	23.80	1	011200110
1120ARG	30.00	1	011200120

1122

Cisaille bichantourneuse coupe droite «Type Aviation»

Inox = acier inoxydable



L	L1	Inox	A	CHF		
mm	mm	S mm	mm			
250	40	1	24	46.00	2	011220020

1123

Cisaille chantourneuse coupe droite «Type Aviation»

Inox = acier inoxydable



L	L1	Inox	A	CHF		
mm	mm	S mm	mm			
250	40	1	24	46.00	2	011230020

1124

Cisaille chantourneuse coupe à gauche «Type Aviation»

Inox = acier inoxydable



L	L1	Inox	A	CHF		
mm	mm	S mm	mm			
250	40	1	24	46.00	2	011240020

1125

Cisaille chantourneuse démultipliée coupe droite et à droite

Inox = acier inoxydable

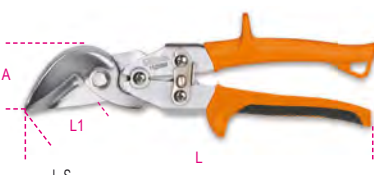

L	L1	Inox	A	CHF		
mm	mm	S mm	mm			
250	35	1	46	72.00	2	011250020

1126

Cisaille chantourneuse démultipliée coupe droite et à gauche

Inox = acier inoxydable

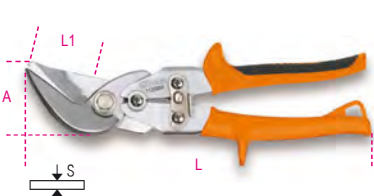

L	L1	Inox	A	CHF		
mm	mm	S mm	mm			
250	35	1	46	72.00	2	011260020

1122 - 1125MOL



		CHF		
1122 MOL	1122 - 1124	2.06	1	011220010
1123 MOL	1123	1.75	1	011230010
1125 MOL	1125 - 1126	1.75	1	011250040

1127

Ciseaux de téléphoniste, lames droites



L	L1	CHF		
mm	mm			
150	35	20.00	5	011270001

1128BAX

Ciseaux d'électriciens à double effet, avec profils à foret en acier inoxydable revêtu en DLC

Coupe à double effet : à travers une came spéciale sur le point d'appui, l'on obtient un déplacement longitudinal des lames qui, lors de la phase de fermeture, en augmente la puissance de coupe.

Profil et foret : étudiés pour élargir les orifices sur plastique de 13 à 25 mm.

Revêtement DLC : le carbone de type diamant (DLC - diamond-like carbon) est un revêtement innovant à base de carbone : la grande dureté et le faible coefficient de frottement sont dus à la présence simultanée de carbone déposé sur la surface en forme de graphite et diamant.

- Grande dureté superficielle des lames (résistance à l'abrasion et maintien de l'affûtage dans le temps)
- Faible coefficient de frottement (glissement et puissance de coupe)
- Embout excentrique anti-ralentissement
- Branches amples avec gorges auto-serrantes
- Fournis avec étui en plastique articulé



L	L1	S	CHF		
mm	mm	mm ²			
150	50	50	44.00	5	011280088

1128BMX

Ciseaux d'électricien lames droites en acier inoxydable, avec micro-denture



L	L1	CHF		
mm	mm			
147	58,2	23.40	5	011280051

1128BMX/F

Étui plastique articulé pour 1128BMX



	CHF		
1128BMX/F	2.37	1	011280059

1128FXS CISEAU D'ÉLECTRICIEN AVEC ÉVASEUR

Pour repenser nos ciseaux d'électricien, nous avons observé le travail quotidien des utilisateurs. Nous en avons fait un outil universel, intégrant les 4 fonctionnalités principales dans un seul outils.

COUPE Rapide et nette, pour câbles jusqu'à 50 mm², avec une gorge coupe-câble et une lame micro-dentée, pour une meilleure prise.

DENUDAGE La sensibilité de l'embout anti-desserrement permet de dénuder avec précision les câbles les plus fins.

SERTISSAGE Sûr et résistant pour les cosses de tubulaires.

ÉVASEMENT Le profil à fraise permet d'élargir les orifices des de dérivation de manière précise et nette.



1128BAX CISEAUX D'ÉLECTRICIEN À DOUBLE EFFET AVEC ÉVASEUR EN ACIER INOXYDABLE ET REVÈTEMENT DLC

Les ciseaux 1128BAX se distinguent par leurs lames au revêtement DLC. Le DLC (diamond-like carbon)

est un revêtement innovant à base de carbone dont la dureté élevée et le faible coefficient de frottement résultent de la présence simultanée de carbone à la surface sous forme de graphite et de diamant.

- Dureté élevée de la surface de la lame - résistance à l'abrasion et à l'usure
- Faible coefficient de frottement - et anti-adhérent

Profil de fraisage : conçu pour agrandir les trous sur du plastique, de 13 mm à 25 mm.



+DE DURETÉ
-DE COEFFICIENT DE FRICTION



1128BSX

Ciseaux d'électricien avec évaseur

conçus pour élargir les trous sur le plastique et pour fermer les tuyaux plissés



L mm	L1 mm	CHF	5	011280061
148	58,2	40.50		

1128FX

Ciseaux d'électricien lames droites en acier inoxydable avec micro-denture, gorge coupe-câble et pince à sertir pour cosses tubulaires

- Étui articulé accrochable à la ceinture
- Branches bi-matières
- Embout anti-dévissage



L mm	L1 mm	mm ²	CHF	5	011280090
145	52	50	42.50		

1128FXS

Ciseaux d'électricien avec évaseur, lames droites en acier inoxydable avec micro-denture, gorge coupe-câble et pince à sertir pour cosses tubulaires

- Étui articulé accrochable à la ceinture
- Branches bi-matières
- Embout anti-dévissage

• Profil et foret : conçus pour élargir les trous sur plastique de 13 à 21 mm



L mm	L1 mm	mm ²	CHF	5	011280095
145	52	50	51.00		

1128BM

Ciseaux d'électricien, lames droites



L mm	L1 mm	CHF	5	011280000
145	50	20.30		

1129BM

Ciseaux d'électricien, lames courbées



L mm	L1 mm	CHF	5	011290000
145	44	21.70		

1130BMX

Ciseaux multifonctions lames droites en acier inoxydable avec micro-denture



L mm	L1 mm	CHF	1	011300002
185	60	26.00		

1131CK

Ciseaux pour Kevlar® et fibres optiques

en acier, spécialement conçus pour travailler sur les matériaux anti-coupure tels que les fibres d'aramides, p. ex. Kevlar®
Egalement pour fibres optiques



L mm	L1 mm	CHF	1	011310001
203	75	105.50		

1132

Coupe-câbles branches gainées avec double couche de PVC antidérapant



UNI 8791

L	mm	mm ²	CHF	🔧	📦
170	14	50	65.00	2	011320107
230	18	95	80.00	2	011320113

1132BM

Coupe-câbles branches gainées confort bi-matières



UNI 8791

L	mm	mm ²	CHF	🔧	📦
170	14	50	80.00	2	011320137
230	18	95	98.00	2	011320143

1133

Coupe-câbles pour câbles en cuivre flexible

jusqu'à 325 mm²



L	mm	mm ²	CHF	🔧	📦
600	30	325	222.50	1	011330001

1133RL

Lames pour 1133



1133RL	CHF	🔧	📦
	167.50	1	011330011

1134

Coupe-câbles à cliquet



L	mm	mm ²	CHF	🔧	📦
260	35	400	649.00	1	011340032

1134RL

Lames pour 1134



1134RL	CHF	🔧	📦
	294.00	1	011340132

1134A

Coupe câble à cliquet



L	mm	mm ²	CHF	🔧	📦
240	45	500	986.00	1	011340045

1142BM

Pince à dénuder branches gainées confort bi-matières



UNI 7923

L	mm	mm ²	mm	CHF	🔧	📦
160	0,5÷6	0-2,8		52.50	3	011420036

1143

Pince à dénuder automatique latérale



L	mm	mm ²	mm	CHF	🔧	📦
165	0,5÷6	1-3,2		103.50	1	011430001

1143R

Lames pour 1143

1143R	CHF	🔧	📦
	26.00	1	011430011

1144D

Dénudeur



L	mm	mm ²	mm	CHF	🔧	📦
170	4,5÷240	2,5-18		124.50	1	011440010

1144D/RG

Crochet de rechange pour 1144D



1144D/RG	CHF	🔧	📦
	41.50	1	011440012

1144D/RL

Lames pour 1144D

1144D/RL	CHF	🔧	📦
	64.00	1	011440011

1144G

Dénudeur

Avec lame réglable pour coupes transversales et longitudinales



L	mm	mm ²	mm	CHF	🔧	📦
140	6÷75	2.8-12		69.50	1	011440004



Beta

1144G/RL

Lame pour 1144G



1144G/RL	CHF 15.40	1	011440005
----------	--------------	---	-----------

1144L

Dénudeur avec lame réglable pour coupes transversales et longitudinales

Avec lame rétractile lisse et à crochet



L mm	 mm ²	 mm	CHF		
145	6-150	4-28	40.50	1	011440050

1144T

Dénudeur de poche réglable, avec dispositif de coupe



L mm	 mm	 g	CHF		
112	3,5 ÷ 9	40	28.00	1	011440060

1148A

Pince à dénuder automatique

10 mm² (8 AWG) câbles flexibles
1,5 mm² (16 AWG) câbles rigides



L mm	 mm ²	 mm	CHF		
190	0,02 ÷ 10	0-4	212.50	1	011480100

1148A/R

Paire de mors pour 1148A



1148A/R	CHF 91.00	1	011480102
---------	--------------	---	-----------

Beta

1148B

Pince à dénuder automatique



L mm	 mm ²	 mm	CHF		
190	4 ÷ 16	2-5	250.00	1	011480200

1148B/R

Paire de mors pour 1148B



1148B/R	CHF 114.00	1	011480202
---------	---------------	---	-----------

1148P

Pince à dénuder automatique



L mm	 mm ²	 mm	CHF		
165	0.2-6	0-3.5	59.50	1	011480300

1149F

Pince à dénuder frontale autoréglable, avec dispositif de coupe



L mm	 mm ²	CHF			
175	0,2 ÷ 6	23.10	1	011490010	

1150

Pince universelle chromée polie branches gainées avec double couche de PVC antidérapant

• L'embout décentré augmente l'effet de levier tout en réduisant l'effort, pour un coupe de grande puissance.



ISO 5746

L mm	L1 mm	 mm	CHF		
160	42	1,6	29.50	5	011500046
180	46	1,8	32.00	5	011500048
200	50	2,0	34.50	5	011500050
220	50	2,0	38.50	2	011500052

1150G

Pince universelle, branches gainées avec double couche de PVC antidérapant, modèle grande capacité, finition industrielle

• Excellent rapport qualité/prix
• L'embout décentré augmente l'effet de levier tout en réduisant l'effort, pour un coupe de grande puissance.



ISO 5746

L mm	L1 mm	 mm	CHF		
160	42	1,6	27.50	5	011500066
180	46	1,8	30.00	5	011500068
200	50	2,0	33.50	5	011500070
220	50	2,0	34.50	2	011500072

Beta

1150HPC PINCE UNIVERSELLE HYPERCUT À GRANDE FORCE DE COUPE AVEC TRANCHANTS EN ACIER FRITTÉ M2

- L'axe décentré permet au point d'appui d'être plus proche du point de coupe, ce qui améliore l'effet de levier.
- L'alignement parfait des becs et le profil affiné garantissent une prise sûre même dans les espaces réduits.
- Le corps de la pince est constitué d'un acier au molybdène qui a subi un traitement thermique afin d'apporter flexibilité et résistance pour garantir une prise en main sûre.

Contrainte de cisaillement - essai statique =	-73%
Durée de vie moyenne des arêtes de coupe (test ISO 5744) =	+127%
Dureté des tranchants en acier M2 =	65HRC

RÉVOLUTIONNAIRE

FINITION CHROMÉE PERLÉE

CAPACITÉ DE COUPE REMARQUABLE

1150HPC

Pince universelle à grande force de coupe avec tranchant à insert et embout décentré
Chromée satinée avec branches gainées bi-matières et joint ouvert

Tranchant à insert
Acier : M2
Épaisseur : 0,20 mm
Angle : 62°
Dureté : 63+65 HRC



ISO 5746

L mm	L1 mm	mm	CHF		
180	42	1,8	80.50	2	011500618

1150BM

Pince universelle chromée polie branches gainées confort bi-matières

- L'embout décentré augmente l'effet de levier tout en réduisant l'effort, pour un coupe de grande puissance.



ISO 5746

L mm	L1 mm	mm	CHF		
160	42	1,6	36.50	3	011500146
180	46	1,8	40.50	3	011500148
200	50	2,0	44.00	3	011500150
220	50	2,0	47.00	2	011500152

1150GBM

Pince universelle, branches gainées confort bi-matières, modèle grande capacité, finition industrielle

- L'embout décentré augmente l'effet de levier tout en réduisant l'effort, pour un coupe de grande puissance.
- Excellent rapport qualité/prix



ISO 5746

L mm	L1 mm	mm	CHF		
160	42	1,6	34.00	3	011500266
180	39	1,8	36.50	3	011500268
200	50	2,0	41.50	3	011500270
220	50	2,0	44.00	2	011500272

1153

Pince universelle réglable "mécanicien", branches gainées PVC



UNI ISO 9343

L mm	L1 mm	mm	CHF		
200	34		33.50	2	011530120

1162

Pince à becs plats longs striés, chromée, branches gainées avec double couche de PVC antidérapant



ISO 5745

L mm	L1 mm	mm	CHF		
160	58	1,6	34.50	5	011620006
200	86	1,6	40.50	5	011620010



1162G

pince à becs plats longs striés,
branches gainées avec double couche
de PVC antidérapant,
 finition industrielle

• Excellent rapport qualité/prix



ISO 5745

L mm	L1 mm	Ø mm	CHF	Hand	ISO
160	58	1,6	29.50	5	011620066
200	86	1,6	34.00	5	011620070

1162BM

Pince à becs plats
longs striés,
chromée,
branches gainées confort bi-matières



ISO 5745

L mm	L1 mm	Ø mm	CHF	Hand	ISO
160	58	1,6	42.00	3	011620036
200	86	1,6	47.00	3	011620040

1162GBM

Pince à becs plats
longs striés,
branches gainées confort bi-matières,
 finition industrielle

• Excellent rapport qualité/prix



ISO 5745

L mm	L1 mm	Ø mm	CHF	Hand	ISO
160	58	1,6	36.50	3	011620266
200	86	1,6	42.50	3	011620270

1164

Pince à becs coudés plats longs striés
branches gainées avec double couche
de PVC antidérapant



ISO 5745

L mm	L1 mm	Ø mm	CHF	Hand	ISO
160	54	1,6	38.00	5	011640006
200	76	1,6	42.00	5	011640010

1164BM

Pince à becs coudés plats longs striés
branches gainées confort bi-matières



ISO 5745

L mm	L1 mm	Ø mm	CHF	Hand	ISO
160	54	1,6	46.00	3	011640036
200	76	1,6	52.00	3	011640040

1166

Pince à becs demi-ronds
longs striés,
chromée,
branches gainées avec double couche de
PVC antidérapant



ISO 5745

L mm	L1 mm	Ø mm	CHF	Hand	ISO
160	56	1,6	34.50	5	011660006
200	76	1,6	40.50	5	011660010

1166G

Pince à becs demi-ronds longs striés,
branches gainées
avec double couche
de PVC antidérapant,
 finition industrielle

• Excellent rapport qualité/prix

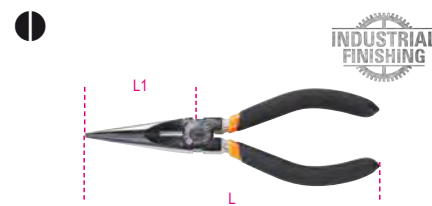

ISO 5745

L mm	L1 mm	Ø mm	CHF	Hand	ISO
160	56	1,6	29.50	5	011660066
200	76	1,6	34.00	5	011660070

1166BM

Pince à becs demi-ronds
longs striés,
chromée,
branches gainées confort bi-matières



ISO 5745

L mm	L1 mm	Ø mm	CHF	Hand	ISO
160	56	1,6	42.00	3	011660036
200	76	1,6	47.00	3	011660040

1166GBM

Pince à becs demi-ronds longs striés,
branches gainées confort bi-matières,
 finition industrielle

• Excellent rapport qualité/prix



ISO 5745

L mm	L1 mm	Ø mm	CHF	Hand	ISO
160	56	1,6	36.50	3	011660266
200	76	1,6	42.50	3	011660270

1168

Pince à becs coudés demi-ronds
longs striés,
chromée,
branches gainées avec double couche de
PVC antidérapant



ISO 5745

L mm	L1 mm	Ø mm	CHF	Hand	ISO
160	54	1,6	38.00	5	011680006
200	76	1,6	42.00	5	011680010

1168G

Pince à becs coudés demi-ronds
longs striés,
branches gainées avec double couche
de PVC antidérapant,
 finition industrielle

• Excellent rapport qualité/prix



ISO 5745

L mm	L1 mm	Ø mm	CHF	Hand	ISO
160	54	1,6	32.00	5	011680066
200	76	1,6	36.50	5	011680070

1168BM

Pince à becs coudés demi-ronds longs striés, chromée, branches gainées confort bi-matières



ISO 5745

L mm	L1 mm	mm	CHF		
160	54	1,6	46.00	3	011680036
200	70	1,6	52.00	3	011680040

1168GBM

Pince à becs coudés demi-ronds longs striés, branches gainées confort bi-matières, finition industrielle

• Excellent rapport qualité/prix



INDUSTRIAL FINISHING

ISO 5745

L mm	L1 mm	mm	CHF		
160	54	1,6	41.00	3	011680266
200	70	1,6	46.00	3	011680270

1169/D3

Jeu de 1 pince universelle, 1 pince à becs demi-ronds longs et 1 pince coupante diagonale



1169/D3	CHF		
1082 160mm	101.50	1	011690053
1150 180mm			
1166 160mm			

1169G/D3

Jeu de 1 pince universelle, 1 pince à becs demi-ronds longs et 1 pince coupante, branches gainées avec double couche de PVC antidérapant, finition industrielle

• Excellent rapport qualité/prix



INDUSTRIAL FINISHING

1169G/D3	CHF		
1082G 160mm	90.00	1	011690073
1150G 180mm			
1166G 160mm			

1169BM/D3

Jeu de 1 pince universelle, 1 pince à becs demi-ronds longs et 1 pince coupante diagonale



1169BM/D3	CHF		
1082BM 160mm	127.50	1	011690133
1150BM 180mm			
1166BM 160mm			

1169GBM/D3

Jeu de 1 pince universelle, 1 pince à becs demi-ronds longs et 1 pince coupante, branches gainées confort bi-matières, finition industrielle

• Excellent rapport qualité/prix



INDUSTRIAL FINISHING

1169GBM/D3	CHF		
1082GBM 160mm	114.00	1	011690273
1150GBM 180mm			
1166GBM 160mm			

1169N/D4

Jeu de 1 pince universelle grande capacité, 1 pince à becs demi-ronds longs, 1 pince coupante chromée et 1 pince multiprise entrepassé phosphatée



1169N/D4	CHF		
1082 160 mm	138.00	1	011690024
1150 180 mm			
1166 160 mm			
1048N 250 mm			

1171BM

Pince de précision à becs plats courts lisses branches gainées confort bi-matières



ISO 9655

L	L1 mm	A mm	B mm	CHF		
130	18	12	8	57.50	2	011710101

1172BM

Pince de précision à becs plats longs lisses branches gainées confort bi-matières

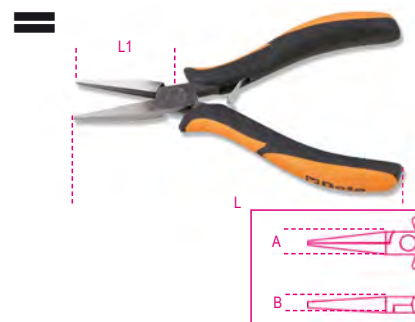

ISO 9655

L	L1 mm	A mm	B mm	CHF		
140	40	12	8	57.50	2	011720101

Beta

1172BM/P

Pince de précision
à becs plats coulés longs lisses
branches gainées confort bi-matières

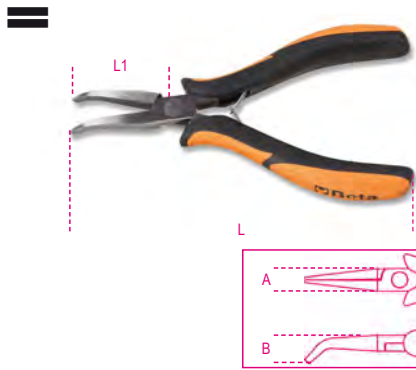

L	L1	A	B	CHF	2	011720102
~ 140	mm 38	mm 12	mm 13	66.50		

1173BM

Pince de précision
à becs ronds courts
branches gainées confort bi-matières



L	L1	A	B	CHF	2	011730101
~ 125	mm 22	mm 12	mm 8	57.50		

1175BM

Pince de précision
à becs demi-ronds courts lisses
branches gainées confort bi-matières



L	L1	A	B	CHF	2	011750101
~ 140	mm 29	mm 12	mm 8	57.50		

1177BM

Pince de précision
à becs demi-ronds longs lisses
branches gainées confort bi-matières

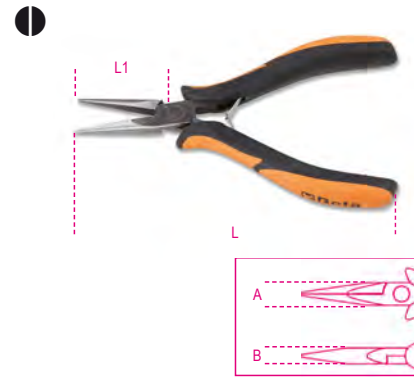

L	L1	A	B	CHF	2	011770101
~ 140	mm 38	mm 12	mm 8	57.50		

1177BM/Z

Pince de précision
à becs demi-ronds longs striés
branches gainées confort bi-matières



L	L1	A	B	CHF	2	011770113
~ 140	mm 39	mm 12	mm 8	66.50		

1178BM

Pince de précision
à becs demi-ronds longs lisses effilés
branches gainées confort bi-matières

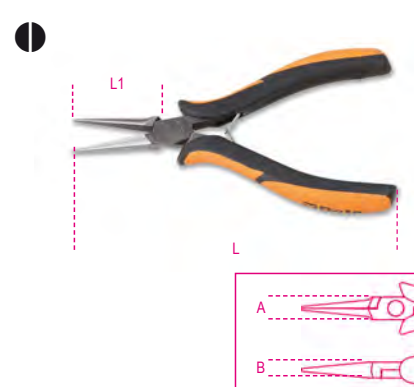

L	L1	A	B	CHF	2	011780101
~ 140	mm 37	mm 12	mm 8	66.50		

1178BM/P

Pince de précision
à becs coulés demi-ronds longs lisses effilés
branches gainées confort bi-matières



L	L1	A	B	CHF	2	011780102
~ 140	mm 36,5	mm 12	mm 12	66.50		

À suivre pinces coupantes pour cuivre.
Pour des utilisations plus contraignantes,
consulter l'article 1081

1182BM

Pince coupante diagonale de précision
à becs effilés, coupe semi-rase,
branches gainées confort bi-matières



L	L1	A	Cu	CHF	2	011820101
mm 120	mm 11	mm 10	mm 1	66.50		



1183BM

Pince coupante diagonale de précision à becs arrondis, coupe semi-rase, branches gainées confort bi-matières



ISO 9654

L mm	L1 mm	A mm	Cu mm	CHF	QTY	ARTICLE
120	11	10	1	66.50	2	011830101
130	13	12,5	1,25	66.50	2	011830102

1184BM

Pince coupante diagonale de précision à becs arrondis, coupe à ras, branches gainées confort bi-matières



ISO 9654

L mm	L1 mm	A mm	Cu mm	CHF	QTY	ARTICLE
120	11	10	1	66.50	2	011840101
130	13	12,5	1,25	66.50	2	011840102

1185BM

Pince coupante diagonale de précision à becs effilés, coupe à ras, branches gainées confort bi-matières



ISO 9654

L mm	L1 mm	A mm	Cu mm	CHF	QTY	ARTICLE
120	11	10	1	66.50	2	011850101
130	13	12,5	1,25	66.50	2	011850102

1186BM

Pince coupante diagonale de précision à becs effilés avec dégagement, coupe à ras branches gainées confort bi-matières



ISO 9654

L mm	L1 mm	A mm	Cu mm	CHF	QTY	ARTICLE
120	11	10	1	66.50	2	011860101
130	13	12,5	1,25	66.50	2	011860102

1188BM

Pince coupante diagonale de précision coupe axiale branches gainées confort bi-matières



ISO 9654

L mm	L1 mm	A mm	Cu mm	CHF	QTY	ARTICLE
125	12	12	1,25	66.50	2	011880101
130	17	15	2	66.50	2	011880102

1190BM

Pince coupante frontale de précision coupe semi-rase branches gainées confort bi-matières



ISO 9654

L mm	L1 mm	A mm	Cu mm	CHF	QTY	ARTICLE
120	12	12	1,25	66.50	2	011900113

1191BM

Pince coupante frontale de précision tête inclinée à 70°, coupe à ras branches gainées confort bi-matières



ISO 9654

L mm	L1 mm	A mm	Cu mm	CHF	QTY	ARTICLE
130	8	12	0,8	66.50	2	011910101

1191BM/L

Pince coupante frontale de précision tête inclinée à 70°, coupe à ras branches gainées confort bi-matières



ISO 9654

L mm	L1 mm	A mm	Cu mm	CHF	QTY	ARTICLE
130	18	12	1	66.50	2	011910110

1191R/5-M

Kit ressorts de rechange pour pinces et pinces coupantes, 5 couples (Articles : 1171...1191)

1191R/5-M	CHF	QTY	ARTICLE
	13.00	1	011910995

1200MS

Magnétiseur/démagnétiseur

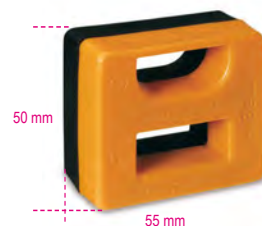

1200MS	CHF	QTY	ARTICLE
	20.70	5	012000000

Beta **EVOLX**

L'ÉVOLUTION DU TOURNEVIS !

Son design ergonomique s'adapte parfaitement à la paume de la main. La vaste surface de contact de la poignée qu'il propose permet de transmettre la plus grande force possible avec un minimum d'effort.

Les lames Beta, dont leurs preuves ne sont plus à démontrer, offrent élasticité, dureté et résistance à l'usure et se positionne dans la catégorie PREMIUM des tournevis professionnels.

La poignée octogonale évite que l'outil ne roule sur le plan de travail.

L'ergonomie précise du manche permet au tournevis de tourner rapidement entre les doigts.

La nouveauté est la possibilité d'accrocher le tournevis par l'orifice présent sur le manche.

La nouvelle gamme de manche thermoplastique octroie un confort supérieur à chaque utilisation, même la plus compliquée.

L'empreinte et la mesure écrite sur la partie sphérique du manche contribuent à une identification rapide.

● Les lames Beta, dont leurs preuves ne sont plus à démontrer, offrent élasticité, dureté et résistance à l'usure et se positionne dans la catégorie PREMIUM des tournevis professionnels.

● Son design ergonomique s'adapte parfaitement à la paume de la main. La vaste surface de contact de la poignée qu'il propose permet de transmettre la plus grande force possible avec un minimum d'effort.

● La poignée octogonale évite que l'outil ne roule sur le plan de travail.

● La nouveauté est la possibilité d'accrocher le tournevis par l'orifice présent sur le manche.



● L'empreinte et la mesure écrite sur la partie sphérique du manche contribuent à une identification rapide.

● L'ergonomie précise du manche permet au tournevis de tourner rapidement entre les doigts.



1201E

Tournevis pour vis à fente



ISO 2380

SxAxL mm	L1 mm	Ø mm	CHF		
0,4x2,5x50	146	2,5	5.15	5	012011003
0,4x2,5x75	166	2,5	5.35	5	012011006
0,5x3x75	171	3,0	5.40	5	012011009
0,5x3x100	196	3,0	5.85	5	012011012
0,6x3,5x75	171	3,5	5.85	5	012011018
0,6x3,5x100	196	3,5	5.95	5	012011021
0,8x4x100	196	4,0	6.00	5	012011030
0,8x4x125	221	4,0	6.40	5	012011033
0,8x4x150	246	4,0	6.90	5	012011036
1,0x5,5x100	209	5,0	7.55	5	012011039
1,0x5,5x125	234	5,0	7.95	5	012011040
1,0x5,5x150	259	5,0	8.05	5	012011042
1,2x6,5x100	220	6,0	9.00	5	012011048
1,2x6,5x125	234	6,0	9.30	5	012011050
1,2x6,5x150	270	6,0	9.50	5	012011051
1,2x8x150	282	8,0	12.20	3	012011057
1,2x8x200	332	8,0	13.20	3	012011060
1,6x10x200	332	9,5	15.30	3	012011066



1201E/S6	CHF		
0,5x3x75-0,6x3,5x100 0,8x4x100-1,0x5,5x100 1,2x8x150-1,6x10x200 mm	52.00	1	012011206

1201EN

Tournevis à lame courte pour vis à fente



ISO 2380

SxAxL mm	L1 mm	Ø mm	CHF		
0,8x4x30	86,5	4	7.40	3	012011103
1,2x6,5x30	86,5	6	7.80	3	012011106

1201E/DZ

Tournevis pour vis Dzus®



L mm	L1 mm	CHF		
53	173	18.20	2	012011501

1202E

Tournevis pour vis Phillips®



UNI-ISO 8764

PHxDxL mm	L1 mm	CHF		
0x3x60	156	5.35	5	012021003
0x3x100	200	5.95	5	012021006
1x4,5x80	189	6.80	5	012021009
1x4,5x120	229	7.75	5	012021012
2x6x100	220	9.30	5	012021018
2x6x150	270	10.00	5	012021021
3x8x150	282	12.80	3	012021024
4x9,5x200	332	16.70	3	012021027



	CHF		
1202E/S4 PH0x3x60-PH1x4,5x120 PH2x6x150-PH3x8x150 mm	36.00	1	012021204

1202EN

Tournevis à lame courte
pour vis Phillips®



UNI-ISO 8764

PHxDxL mm	L1 mm	CHF		
1x4,5x30	86,5	7.40	3	012021103
2x6x30	86,5	7.80	3	012021106

1202EL

Tournevis à lame longue
pour vis Phillips®

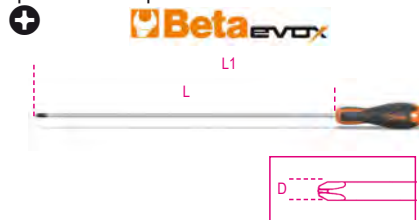

UNI-ISO 8764-1

PHxDxL mm	L1 mm	CHF		
0x3x300	400	9.50	3	012021303
1x4,5x300	400	10.40	3	012021305
1x4,5x400	508	12.70	3	012021306
2x6x400	519	14.50	3	012021309

1203E/D

Jeu de tournevis



	CHF		
1203E/D5	39.50	1	012031001

1201E 0,6x3,5x100-1,0x5,5x150
1,2x6,5x150 mm
1202E PH1x4,5x80-PH2x6x100 mm

	CHF		
1203E/D5PZ	38.50	1	012031003

1201E 0,5x3x75-0,8x4x125
1,0x5,5x150 mm
1209E/PZ PZ1x4,5x80-PZ2x6x100 mm

	CHF		
1203E/D6	41.00	1	012031006

1202E PH1x4,5x80-PH2x6x100 mm
1204E 0,4x2,5x60-0,5x3x100
0,8x4x100-1,0x5x125 mm

	CHF		
1203E/D7	49.50	1	012031007

1201E 0,5x3x75-0,8x4x100
1,0x5,5x100-1,2x6,5x150 mm
1202E PH0x3x60-PH1x4,5x80
PH2x6x100 mm

	CHF		
1203E/D8	63.00	1	012031008

1201E 0,5x3x75-0,8x4x125
1,0x5,5x150-1,2x6,5x150 mm
1202E PH0x3x60-PH1x4,5x80
PH2x6x100-PH3x8x150 mm

	CHF		
1203E/D8P	55.00	1	012031018

1201E 2,5x50-3x75-4x100
5,5x100-6,5x150 mm
1202E PH0x60-PH1x80-PH2x100 mm

	CHF		
1203E/D10	80.00	1	012031010

1201E 0,4x2,5x50-0,5x3x75
0,8x4x100-1,0x5,5x100
1,2x6,5x150-1,2x8x150 mm
1202E PH0x3x60-PH1x4,5x80
PH2x6x100-PH3x8x150 mm

	CHF		
1203E/D10N	70.00	1	012031019
1201E	0,4x2,5x50-0,5x3x75-0,8x4x100- 1,0x5,5x150-1,2x6,5x150 mm		
1201EN	0,8x4x30 mm		
1202E	PH0x3x60 - PH1x4,5x80 - PH2x6x100 mm		
1202EN	PH1x4,5x30 mm		

1203E/S



	CHF		
1203E/S8	55.00	1	012031009

1201E 2,5x50-3x75-4x100
5,5x125-6,5x150 mm
1202E PH0x3x60-PH1x4,5x80
PH2x6x100 mm

	CHF		
1203E/S10	80.50	1	012031021

1201E 0,4x2,5x50-0,5x3x75
0,8x4x125-1,0x5,5x150
1,2x6,5x150-1,2x8x150 mm
1202E PH0x3x60-PH1x4,5x80
PH2x6x100-PH3x8x150 mm

1204E

Tournevis à lame fraisée
pour vis à fente



ISO 2380

SxDxL mm	L1 mm	CHF		
0,4x2,5x60	156	5.25	5	012041003
0,6x3x75	175	5.40	5	012041006
0,5x3x100	196	5.50	5	012041009
0,8x4x100	196	6.20	5	012041012
0,8x4x125	233	6.50	5	012041015
1x5x125	234	7.65	5	012041018
1x5x150	258	8.25	5	012041021
1,2x6,5x150	270	9.00	5	012041024



	CHF		
1204E/S5	33.50	1	012041205
0,4x2,5x60-0,5x3x100 0,8x4x100-1x5x125 1,2x6,5x150 mm			

1204EL

Tournevis à lame longue fraisée pour vis à feinte

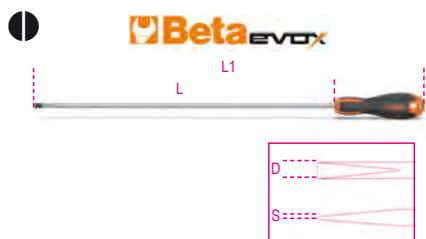

ISO 2380

SxDxL mm	L1 mm	CHF		
0,5x2,5x200	300	7.80	3	012041303
0,5x3x300	400	9.30	3	012041306
0,8x4x400	508	11.40	3	012041309
1x5x400	508	12.20	3	012041315
1,2x6,5x400	519	15.60	3	012041318

1205E/ES



mm	L mm	L1 mm	CHF		
1,5	100	200	6.65	3	012051315
2	100	200	6.80	3	012051320
2,5	100	200	6.90	3	012051325
3	100	200	7.15	3	012051330
4	100	208	8.20	3	012051340
5	100	219	9.80	3	012051350
6	125	244	10.10	3	012051360
8	150	277	13.40	2	012051380



1205E/ES-S8	CHF		
1,5-2-2,5-3-4-5-6-8 mm	69.00	1	012051408

1206E/BP

Clé mâle emmanchée à tête sphérique pour vis 6 pans



mm	L mm	L1 mm	Ø mm	CHF		
2	100	198	2,5	7.45	3	012061320
2,5	100	198	3,0	7.55	3	012061325
3	100	198	3,5	7.70	3	012061330
4	100	209	5,0	8.60	3	012061340
5	100	220	6,0	10.40	3	012061350
6	125	245	7,0	10.70	3	012061360
8	150	287	9,5	14.30	2	012061380



1206E/BP-S7	CHF		
2-2,5-3-4-5-6-8 mm	66.50	1	012061407

1207E/TX

Tournevis pour vis Torx®



	L mm	L1 mm	Ø mm	CHF		
T5	50	150	3	7.95	5	012071005
T6	60	156	4	8.45	5	012071006
T7	60	156	4	8.60	5	012071007
T8	60	156	4	8.75	5	012071008
T9	60	156	4	9.20	5	012071009
T10	80	189	5	10.40	5	012071010
T15	80	189	5	10.50	5	012071015
T20	100	209	5	10.70	5	012071020
T25	100	209	5	11.00	5	012071025
T27	100	220	6	11.70	5	012071027
T30	100	220	6	11.80	5	012071030
T40	130	262	7	14.00	2	012071040
T45	130	262	8	15.40	2	012071045



1207E/TX-D7	CHF		
T6-T8-T10-T15 T20-T25-T30	71.50	1	012071207
1207E/TX-S13	138.00	1	012071213
T5-T6-T7-T8-T9-T10-T15 T20-T25-T27-T30-T40-T45			

1208E/RTX

Tournevis pour vis Tamper Resistant Torx®



	L mm	L1 mm	Ø mm	CHF		
T9	60	156	4	9.30	5	012081009
T10	80	189	5	10.40	5	012081010
T15	80	189	5	11.00	5	012081015
T20	100	209	5	11.20	5	012081020
T25	100	209	5	11.40	5	012081025
T27	100	220	6	12.40	5	012081027
T30	100	220	6	13.00	5	012081030
T40	130	262	7	15.50	2	012081040



1208E/RTX-D7	CHF		
T9-T10-T15-T20 T25-T27-T30	78.50	1	012081207

1209E/PZ

Tournevis pour vis Pozidriv®-Supadriv®



UNI-ISO 8764

PZ	L mm	L1 mm	CHF		
0	60	156	6.20	5	012091000
1	80	189	8.05	5	012091003
2	100	220	10.40	5	012091006
3	150	282	15.90	3	012091009
4	200	327	17.40	3	012091012



1209E/PZ-S4	CHF		
PZ0-PZ1-PZ2-PZ3	40.50	1	012091204

1209EN/PZ

Tournevis à lame courte pour vis Pozidriv®-Supadriv®



ISO 8764

PZ	L mm	L1 mm	CHF		
1	30	87	7.40	3	012091103
2	30	87	7.80	3	012091106

TOURNEVIS ELECTRIQUE BETA EVOX-E

Le tournevis électrique Beta Evox-E est idéal pour réaliser des travaux de haute précision avec un minimum d'effort et une rapidité maximale.



MANIABILITÉ

Dimensions réduites pour une utilisation dans des espaces restreints et LED frontales permettant une excellente visibilité sur le point de travail.

CONCEPTION ERGONOMIQUE

Le poignée s'ajuste parfaitement à la paume de la main, pour une prise sûre et confortable

1/4



Autonomie de la batterie

Batterie au lithium longue durée 3,7 V 2 300 mAh, permettant de faire jusqu'à 1000 vissages avec un cycle de charge.

Il est disponible en deux variantes:

- Tournevis électrique 1210E/GE avec embouts



- Tournevis électrique 1211E/GE avec embouts isolés 1000V



⚠ 1000 V



1210E/GE

Tournevis électrique Evox-E



L
mm
150

CHF
218.00

1 012110701

1211E/GE

Tournevis électrique Evox-E



L
mm
150

CHF
232.50

1 012110701



1229LP/A6
1,2-1,4-1,8-2-2,4-3 mm

CHF
33.50

1 012290300

1229LPH/A6

Jeu de 6 micro-tournevis 1229LP-1229PH



1229LPH/A6
1229LP 1,4-2,0-2,4-3 mm
1229PH PH0-PH1

CHF
33.50

1 012290310

1236B

Tournevis coudé pour vis à fente

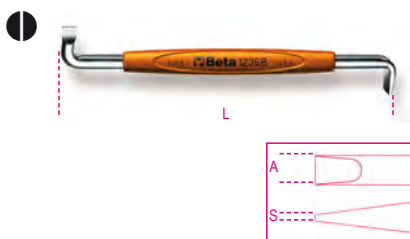

UNI 7079 DIN 5200

SxA	L	CHF		
mm	mm			
0,8x4	100	9.50	5	012360201
1x5,5	125	11.10	5	012360202
1,2x8	150	13.80	5	012360204

1238B

Tournevis coudé pour vis Phillips®



UNI 7083 DIN 5208

PH	L	CHF		
	mm			
1-2	125	11.30	5	012380201
3-4	200	18.40	5	012380203

1241

Tournevis à zone de frappe pour vis à fente



ISO 2380

SxAxL	L1	CHF		
mm	mm			
1x5,5x100	202	14.90	5	012410039
1,2x6,5x125	240	16.50	5	012410050
1,2x8x150	268	20.10	3	012410057
1,6x10x175	300	25.00	2	012410065
1,6x10x200	325	25.50	2	012410066
2,0x12x200	325	27.00	2	012410067
2,5x14x250	375	29.50	2	012410076

1242

Tournevis avec tête en acier pour vis Phillips®



UNI/ISO 8764

PHxDxL	L1	CHF		
mm	mm			
1x4,5x100	202	14.60	5	012420209
2x6x100	215	17.40	5	012420218
3x8x150	268	22.20	3	012420221
4x11x200	325	29.00	2	012420224

1243LP/D6

Jeu de 6 tournevis à zone de frappe pour vis à fente



	CHF		
1243LP/D6	133.50	1	012430016
1241			
			1x5,5x100-1,2x6,5x125
			3x8x150-1,6x10x175
			2,0x12x200-2,5x14x250 mm

1243/D7

Jeu de 7 tournevis à zone de frappe



	CHF		
1243/D7	131.50	1	012430017
1241			1x5,5x100-1,2x6,5x125
			1,2x8x150-1,6x10x200 mm
1242			PH1x4,5x100-PH2x6x100
			PH3x8x150 mm

1243/S11

Jeu de 11 tournevis à zone de frappe



	CHF		
1243/S11	242.00	1	012430021
1241			1x5,5x100-1,2x6,5x125
			3x8x150-1,6x10x175
			1,6x10x200-2,0x12x200
			2,5x14x250 mm
1242			PH1x4,5x100-PH2x6x100
			PH3x8x150-PH4x11x200 mm

1250

Tournevis pose-vis à fente



SxDxL	L1	CHF		
mm	mm			
0,5x3x125	190	21.20	5	012500030
0,6x4x125	225	22.80	5	012500040
0,7x5x150	255	27.00	5	012500050

1251

Tournevis pose-vis Phillips®



PHxDxL	L1	CHF		
mm	mm			
0x4x125	225	23.80	5	012510000
1x5x125	225	27.50	5	012510010
2x6x175	280	31.50	5	012510020

1252/S5



	CHF		
1252/S5	130.00	1	012520001
1250			0,5x3x125-0,6x4x125
			0,7x5x150 mm
1251			PH1x5x150-PH2x6x175 mm



1253

Tournevis détecteur de tension 150/250V

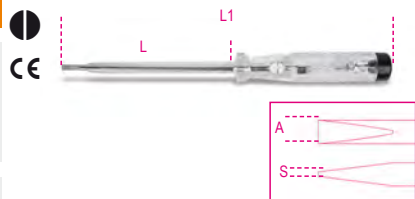

SxAxL mm	L1 mm	CHF	5	012530001
0,5x3,5x100	190	12.80		

1253A

Tournevis détecteur de tension 125/250V à double isolation



SxAxL mm	L1 mm	CHF	5	012530010
0,5x3x15	150	9.05		

1254

Tournevis détecteur de tension à pince crocodile 6/24 V

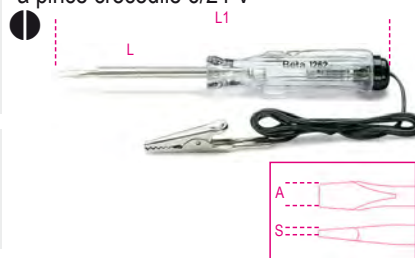

SxAxL mm	L1 mm	CHF	5	012540001
0,5x3x44	123	14.00		

1256/C36-2

Micro-tournevis avec 36 embouts interchangeables de 4 mm et rallonge magnétique



1256/C36-2	CHF	1	012560100
	90.00		

	1256TX	T3 - T4 - T5 - T6 - T7 T8 - T9 - T10 - T15
	1256RTX	T6 - T7 - T8 - T9 - T10
	1256LP	0,8 - 1,2 - 1,5 - 1,8 - 2 - 2,5 3 - 3,5 - 4 mm
	1256PE	0,7 - 0,9 - 1,3 - 1,5 - 2 mm
	1256PH	PH000 - PH00 - PH0 - PH1
	1256PZ	PZ000 - PZ00 - PZ0 - PZ1
	1256/20	
	1256/30	

130x60x35 mm - 200 g

1256LP

Embout 4 mm pour vis à fente

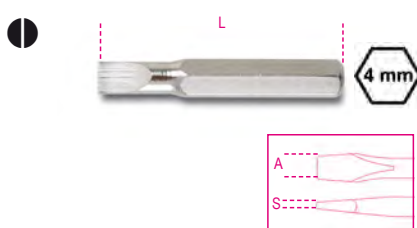

SxA	L	CHF	5	012560001
0,25x0,8	27	1.75		
0,25x1,2	27	1.75		
0,3x1,5	27	1.75		
0,35x1,8	27	1.75		
0,4x2,0	27	1.75		
0,4x2,5	27	1.75		
0,5x3,0	27	1.75		
0,6x3,5	27	1.75		
0,8x4,0	27	1.75		

1256PH

Embout 4 mm pour vis Phillips®



PH	L	CHF	5	012560011
000	27	1.75		
00	27	1.75		
0	27	1.75		
1	27	1.75		

1256PZ

Embout 4 mm pour vis Pozidriv® - Supradriv®



PZ	L	CHF	5	012560061
000	27	1.75		
00	27	1.75		
0	27	1.75		
1	27	1.75		

1256PE

Embout 4 mm pour vis 6 pans



mm	L	CHF	5	012560021
0,7	27	1.75		
0,9	27	1.75		
1,3	27	1.75		
1,5	27	1.75		
2,0	27	1.75		

1256TX

Embout 4 mm pour vis Torx®



	L	CHF	5	012560041
T3	27	1.83		
T4	27	1.83		
T5	27	1.83		
T6	27	1.83		
T7	27	1.83		
T8	27	1.83		
T9	27	1.83		
T10	27	1.83		
T15	27	1.83		

1256RTX

Embout 4 mm pour vis à Tamper Resistant Torx®



	L	CHF	5	012560051
T6	27	2.19		
T7	27	2.19		
T8	27	2.19		
T9	27	2.19		
T10	27	2.19		

1256/20

Rallonge avec entraînements hexagonaux mâle et femelle de 4 mm



1256/20	CHF	5	012560092
	11.00		

1256/30

Poignée porte-embouts de 4 mm



L	CHF	2	012560097
110	13.00		

1257LP

Micro-tournevis pour vis à fente

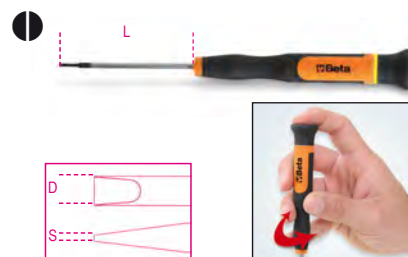

SxD	L	CHF	5	012570012
0,25x1,2	60	6.95		
0,23x1,5	60	6.95		
0,3x1,8	60	6.95		
0,4x2	60	6.95		
0,4x2,5	60	6.95		

SxD mm	L mm	CHF		
0,5x3	60	6.95	5	012570030
0,6x3,5	60	6.95	5	012570035
0,8x4	60	6.95	5	012570040



1257LP/S8		CHF		
		87.50	1	012570200
0,2x1,2-0,25x1,5				
0,3x1,8-0,4x2-0,4x2,5				
0,5x3-0,6x3,5-0,8x4 mm				

1257PH

Micro-tournevis pour vis Phillips®



PH	L mm	CHF		
00	60	6.95	5	012570060
0	60	6.95	5	012570063
1	60	6.95	5	012570066

1257LPH/S8

Coffret de 8 micro-tournevis (art. 1257LP, 1257PH) en coffret



1257LPH/S8		CHF		
		87.50	1	012570210
1257PH	PH00-PH0-PH1			
1257LP	0,4x2-0,4x2,5-0,5x3			
	0,6x3,5-0,8x4 mm			

1257ES

Micro-clé mâle emmanchée pour vis 6 pans



mm	L mm	CHF		
0,9	60	7.80	5	012570045
1,3	60	7.80	5	012570046
1,5	60	7.80	5	012570047
2	60	7.80	5	012570048
2,5	60	7.80	5	012570049
3	60	7.80	5	012570050

1257ESB/S8

Coffret de 8 micro-tournevis (art. 1257ES, 1257BE) en coffret



1257ESB/S8		CHF		
		99.00	1	012570230
1257ES	0,9-1,3-1,5-2-2,5-3 mm			
1257BE	4-5 mm			

1257TX

Micro-tournevis pour vis Torx®



	L mm	CHF		
T5	60	8.25	5	012570075
T6	60	8.25	5	012570076
T7	60	8.25	5	012570077
T8	60	8.25	5	012570078
T9	60	8.25	5	012570079
T10	60	8.25	5	012570080
T15	60	8.25	5	012570081
T20	60	8.25	5	012570082



1257TX/S8		CHF		
		97.50	1	012570220
T5-T6-T7-T8				
T9-T10-T15-T20				

1257BE

Micro-clé à douille emmanchée



mm	L mm	CHF		
3,2	60	10.30	5	012570085
4	60	10.30	5	012570086
5	60	10.30	5	012570087
5,5	60	10.30	5	012570088



Beta

Beta

Les tournevis BetaGrip sont le fruit de la longue expertise de Beta dans la conception des tournevis et d'une étroite collaboration avec les mécaniciens des équipes de course automobile. De nouvelles solutions techniques uniques, capables de satisfaire les exigences des professionnels les plus exigeants, ont été utilisées dans le but d'atteindre les plus hauts standards en matière d'ergonomie, de résistance et de qualité des matériaux.

- La **lame** est en acier spécial à haute teneur en silicium, chrome et vanadium, pour garantir des performances améliorées en termes de résistance à la torsion et à la flexion. Une finition chromée mate antireflet a été choisie.
- La **géométrie de la pointe** a été conçue pour assurer un couplage parfait entre la lame et la tête de vis. La finition phosphatée empêche la pointe de s'oxyder, tout en conservant des profils précis.
- La **matière antidérapante** a été inspirée des bandes de roulement des pneus Racing, développées pour maximiser l'adhérence sur différents terrains. Par conséquent, il garantit un maintien efficace du tournevis dans toutes les conditions de travail, pour une précision et un contrôle améliorés lors du vissage.



1260

Tournevis pour vis à fente



ISO 2380

SxAxL mm	L1 mm	Ø mm	CHF	🔧	📦
0,4x2,5x50	150	2,5	7.15	5	012600003
0,4x2,5x75	175	2,5	7.45	5	012600006
0,5x3x75	175	3,0	7.65	5	012600009
0,5x3x100	200	3,0	7.90	5	012600012
0,6x3,5x75	175	3,5	8.15	5	012600018
0,6x3,5x100	200	3,5	8.25	5	012600021
0,8x4x100	208	4,0	9.00	5	012600030
0,8x4x125	233	4,0	9.35	5	012600033
0,8x4x150	258	4,0	9.75	5	012600036
1x5,5x100	208	5,0	10.30	5	012600039
1x5,5x125	233	5,0	10.50	5	012600040
1x5,5x150	258	5,0	11.50	5	012600042
1,2x6,5x100	219	6,0	12.40	5	012600048
1,2x6,5x125	244	6,0	12.90	5	012600050
1,2x6,5x150	269	6,0	13.40	5	012600051
1,2x8x150	277	8,0	16.40	3	012600057
1,2x8x200	327	8,0	16.90	3	012600060
1,6x10x200	327	9,5	20.50	3	012600066
2x12x250	377	10	24.30	3	012600069
2x14x250	377	10	25.50	2	012600073



CHF	🔧	📦
1260/S6 66.50	1	012600306

0,4x2,5x75-0,5x3x75-0,8x4x125
1x5,5x150-1,2x6,5x150-1,2x8x200 mm

1260N

Tournevis à lame courte pour vis à fente



ISO 2380

SxAxL mm	L1 mm	Ø mm	CHF	🔧	📦
0,8x4x30	87	4	9.50	5	012600103
1,2x6,5x30	87	6	10.50	5	012600106

1260E

Tournevis 6 pans pour vis à fente



ISO 2380

SxAxL mm	L1 mm	Ø mm	CHF		
1,2x6,5x150	269	6,0	17.40	3	012600156
1,2x8x175	301	8,0	21.30	3	012600157
1,6x10x200	327	9,5	24.70	2	012600159
2x12x250	377	9,5	28.50	2	012600162

1260MC

tournevis pour vis à fente, avec repère de couleur



SxAxL mm	L1 mm	Ø mm	CHF		
0,4x2,5x50	150	2,5	7.75	3	012602003
0,6x3,5x75	175	3,5	8.00	3	012602018
0,8x4x100	208	4,0	9.50	3	012602030
1x5,5x150	233	5,0	12.20	5	012602040
1,2x6,5x150	269	6,0	14.00	5	012602051

1262

Tournevis pour vis Phillips®



UNI/ISO 8764

PHxDxL mm	L1 mm	CHF		
0x3x60	160	7.65	5	012620003
0x3x100	200	8.05	5	012620006
1x4,5x80	188	10.00	5	012620009
1x4,5x120	228	10.90	5	012620012
2x6x100	219	12.30	5	012620018
2x6x150	269	13.50	5	012620021
3x8x150	277	18.10	3	012620024
4x10x200	327	23.10	3	012620027



1262/S4	CHF		
PH0x3x60-PH1x4,5x80 PH2x6x100-PH3x8x150 mm	47.50	1	012620304

1262N

Tournevis à lame courte pour vis Phillips®



UNI/ISO 8764

PHxDxL mm	L1 mm	CHF		
1x4,5x30	87	9.50	5	012620103
2x6x30	87	10.50	5	012620106

1262E

Tournevis 6 pans pour vis Phillips®



UNI/ISO 8764

PHxDxL mm	L1 mm	CHF		
2x6x150	269	17.40	3	012620153
3x8x175	302	21.10	3	012620156
4x10x200	327	26.50	2	012620159

1262L

Tournevis à lame longue pour vis Phillips®



UNI/ISO 8764-1

PHxDxL mm	L1 mm	CHF		
0x3x300	400	13.20	3	012620203
1x4,5x300	400	15.80	3	012620205
1x4,5x400	508	18.20	3	012620206
2x6x400	519	23.80	3	012620209

1262MC

tournevis pour vis cruciformes Phillips®, avec repère de couleur



PHxDxL mm	L1 mm	CHF		
0x3x60	160	8.00	3	012622003
1x4,5x80	188	10.40	3	012622009
2x6x100	219	12.90	3	012622018

1263/D...

Jeu de tournevis



1263/D6	CHF		
1260 0,5x3x75-0,8x4x100 1x5,5x125-1,2x6,5x150 mm 1262 PH1x4,5x80-PH2x6x100 mm	62.50	1	012630006



1263/D7	CHF		
1262 PH0x3x60 PH1x4,5x80 PH2x6x100 mm 1264 0,5x2,5x60-0,6x3x100 0,8x4x125-1x5x125 mm	64.50	1	012630017



1263/D7PZ	CHF		
1260 0,5x3x75-0,8x4x100 1x5,5x150-1,2x6,5x150 mm 1269PZ PZ0 - PZ1 - PZ2	75.00	1	012630007



1263/D8	CHF		
1260 0,4x2,5x50-0,5x3x75 0,8x4x100-1x5,5x125 1,2x6,5x150 mm 1262 PH0x3x60-PH1x4,5x80 PH2x6x100 mm	77.50	1	012630008



1263/D10	CHF		
1260 0,5x3x75-0,6x3,5x100 0,8x4x125-1x5,5x150 1,2x6,5x150 mm 1260N 0,8x4x30 1262 PH0x3x60-PH1x4,5x80 PH2x6x100 mm 1262N PH1x4,5x30	99.00	1	012630010

1263/S12

Jeu de 12 tournevis



1263/S12 CHF 141.50 1 012630112

1260	0,4x2,5x50-0,5x3x75 0,6x3,5x100-0,8x4x125 1x5,5x125-1,2x6,5x150 1,2x8x200-1,6x10x200 mm
1262	PH0x3x60-PH1x4,5x80 PH2x6x100-PH3x8x150 mm

1263MC/D8

Jeu de 8 tournevis colorés



1263MC/D8 CHF 82.50 1 012632008

1260MC	0,4x2,5x50-0,5x3x75 0,8x4x100-1x5,5x125 1,2x6,5x150 mm
1262MC	PH0x3x60-PH1x4,5x80 PH2x6x100 mm

1264

Tournevis à lame fraisée pour vis à fente

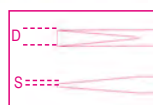

SxDxL mm	L1 mm	CHF		
0,5x2,5x60	160	7.15	5	012640003
0,6x3x75	175	7.65	5	012640006
0,6x3x100	200	7.90	5	012640009
0,8x4x100	208	9.00	5	012640012
0,8x4x125	233	9.35	5	012640015
1x5x125	233	10.50	5	012640018
1x5x150	258	11.10	5	012640021
1,2x6,5x150	269	13.40	5	012640024



1264/S5 CHF 47.50 1 012640305

0,5x2,5x60-0,6x3x75 0,8x4x100-1x5x125-1,2x6,5x150 mm

1264L

Tournevis à lame longue fraisée pour vis à fente

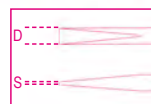

SxDxL mm	L1 mm	CHF		
0,5x2,5x200	300	10.70	3	012640203
0,6x3x300	400	12.50	3	012640206
0,8x4x400	508	16.40	3	012640209
1x5x400	508	18.20	3	012640215
1,2x6,5x400	519	22.20	3	012640218

1265ES

Clé mâle emmanchée pour vis 6 pans



mm	L mm	L1 mm	CHF		
1,5	100	200	8.75	3	012650015
2	100	200	8.95	3	012650020
2,5	100	200	9.25	3	012650025
3	100	200	9.75	3	012650030
4	100	208	10.70	3	012650040
5	100	219	12.40	3	012650050
6	125	244	14.00	3	012650060
8	150	277	18.60	2	012650080



1265ES/S8 CHF 92.50 1 012650308

1,5-2-2,5-3-4-5-6-8 mm

1266BP

Clé mâle emmanchée à tête sphérique pour vis 6 pans



mm	L mm	L1 mm	CHF		
2	100	200	9.50	3	012660020
2,5	100	200	9.85	3	012660025
3	125	225	10.30	3	012660030
4	125	233	11.50	3	012660040
5	120	239	13.40	3	012660050
6	140	259	15.50	3	012660060
8	160	287	19.50	2	012660080
10	160	287	23.40	2	012660100



1266BP/S8 CHF 113.00 1 012660308

2-2,5-3-4-5-6-8-10 mm

1267TX

Tournevis pour vis Torx®



Ø	L mm	L1 mm	Ø mm	CHF		
T5	50	150	3	10.70	5	012670005
T6	50	150	3	11.10	5	012670006
T7	50	150	3	11.50	5	012670007
T8	60	160	3	12.00	5	012670008
T9	60	167	4	12.50	5	012670009
T10	80	188	4	13.00	5	012670010
T15	80	188	4	13.80	5	012670015
T20	100	208	4,5	14.50	5	012670020
T25	100	208	5	15.80	5	012670025
T27	115	234	6	16.40	5	012670027
T30	115	234	6	17.20	5	012670030
T40	130	257	7	20.00	2	012670040
T45	130	257	8	22.00	2	012670045



1267TX/D7
T6-T8-T10-T15
T20-T25-T30

CHF 97.50 1 012670307



1267TX/S13
T5-T6-T7-T8-T9
T10-T15-T20-T25
T27-T30-T40-T45

CHF 190.50 1 012670312

1267MC/TX

tournevis pour vis à tête Torx®, avec repère de couleur



Ø	L mm	L1 mm	Ø mm	CHF	5	1
T6	50	150	3	11.70	5	012672006
T8	60	160	3	12.40	5	012672008
T10	80	188	4	13.60	5	012672010
T15	80	188	4	14.50	5	012672015
T20	100	208	4,5	15.50	5	012672020
T25	100	208	5	16.30	3	012672025
T30	115	234	6	17.90	3	012672030



1267MC/TX-D7
T6-T8-T10-T15
T20-T25-T30

CHF 101.50 1 012672307

1268RTX

Tournevis pour vis Tamper Resistant Torx®



Ø	L mm	L1 mm	Ø mm	CHF	5	1
T9	60	167	4,0	13.60	3	012680009
T10	80	188	4,0	14.10	3	012680010
T15	80	188	4,0	14.50	3	012680015
T20	100	208	4,5	15.80	3	012680020
T25	100	208	5,0	16.10	3	012680025
T27	115	234	6,0	17.20	3	012680027
T30	115	234	6,0	17.50	3	012680030
T40	130	257	7,0	20.20	2	012680040



1268RTX/S8
T9-T10-T15-T20
T25-T27-T30-T40

CHF 129.00 1 012680307

1269PZ

Tournevis pour vis Pozidriv®-Supadriv®



UNI/ISO 8764

PZ	L mm	L1 mm	CHF	5	1
0	60	160	8.70	5	012690000
1	80	188	11.30	5	012690001
2	100	219	13.60	5	012690002
3	150	277	19.50	3	012690003
4	200	327	24.90	3	012690004



1269PZ/S4
PZ0-PZ1-PZ2-PZ3

CHF 53.50 1 012690304

1269N/PZ

Tournevis à lame courte pour vis Pozidriv®-Supadriv®



UNI/ISO 8764

PZ	L mm	L1 mm	CHF	5	1
1	30	87	9.50	5	012690011
2	30	87	10.50	5	012690012

1281BG

Poignée porte-lames



L mm 118
mm 10

CHF 16.00 5 012810280

1281PM

Porte-embouts magnétique



L mm 165

CHF 27.00 5 012810292

1281PB

Porte-douilles carré 1/4"



L mm 175

CHF 21.80 5 012810293

1281LP

Lame réversible pour vis à fente



1281LP/1
0,8x4-1,2x6,5 mm

1281LP/2
1x5,5-1,2x6,5 mm

CHF 14.00 5 012810302

CHF 14.00 5 012810304

1281PH

Lame réversible pour vis Phillips®



PH	CHF	5	012810310
1-2	14.00		
2-3	14.00		012810312

1281LPH

Lame réversible pour vis à fente et Phillips®



	CHF	5	012810321
1281LPH/1 PH0-0,8x4 mm	14.00		
1281LPH/2 PH1-1x5,5 mm	14.00		012810322
1281LPH/3 PH2-1,2x6,5 mm	14.00		012810323

1281PZ

Lame réversible pour vis Pozidriv®-Supadriv®



PZ	CHF	5	012810330
1-2	14.00		
2-3	14.00		012810332

1281PE

Lame réversible pour vis à empreinte 6 pans



mm	CHF	5	012810342
2,5	13.80		
3	13.80		012810343
4	13.80		012810344
5	13.80		012810345
6	13.80		012810346

1281TX

Lame réversible pour vis Torx®



	CHF	5	012810349
1281TX/1 T6-T8	15.40		
1281TX/2 T7-T9	15.40		012810350
1281TX/3 T10-T15	15.40		012810351
1281TX/4 T20-T25	15.40		012810352
1281TX/5 T30-T40	15.40		012810353

1281RTX

Lame réversible pour vis Tamper Resistant Torx®



	CHF	5	012810361
1281RTX/3 T10-T15	15.60		
1281RTX/4 T20-T25	15.60		012810362
1281RTX/5 T30-T40	15.60		012810363

1281BG/A9

Jeu de 9 lames réversibles et 1 accessoire en étui



1281BG/A9	CHF	1	012810520
-----------	-----	---	-----------

1281BG	
1281LPH/1 PH0-0,8x4 mm	
1281LPH/2 PH1-1x5,5 mm	
1281LPH/3 PH2-1,2x6,5 mm	
1281PZ/1 PZ1-PZ2	
1281PE 2,5 mm	
1281PE 3 mm	
1281PE 4 mm	
1281PE 5 mm	
1281PE 6 mm	

1281BG-TX/A8

Jeu de 8 lames réversibles et 1 accessoire en étui



1281BG-TX/A8	CHF	1	012810530
--------------	-----	---	-----------

1281BG	
1281LPH/1 PH0-0,8x4 mm	
1281LPH/2 PH1-1x5,5 mm	
1281LPH/3 PH2-1,2x6,5 mm	
1281TX/1 T6-T8	
1281TX/2 T7-T9	
1281TX/3 T10-T15	
1281TX/4 T20-T25	
1281TX/5 T30-T40	

1281BG/B28NA

assortiment de 16 lames réversibles, 9 douilles 1/4 », 2 accessoires et 1 poignée, dans un trousseau en polyester durable



1281BG/B28NA	CHF	1	012810511
--------------	-----	---	-----------

900	4 - 4,5 - 5 - 5,5 6 - 7 - 8 - 9 - 10 mm
1281BG	
1281PB	■ 1/4
900/25	
1281LP/1	0,8x4 - 1,2x6,5 mm
1281LP/2	1,0x5,5 - 1,2x6,5 mm
1281PH/1	PH1 - PH2
1281PH/2	PH2 - PH3
1281PZ/1	PZ1 - PZ2
1281PZ/2	PZ2 - PZ3
1281PE	2,5 - 3 - 4 - 5 - 6 mm
1281TX/1	T6 - T8
1281TX/2	T7 - T9
1281RTX/3	T10 - T15
1281RTX/4	T20 - T25
1281RTX/5	T30 - T40

2002/BV7-ZIP	CHF	1	020020060
--------------	-----	---	-----------

Les **tournevis BetaMax** s'appuient sur plusieurs caractéristiques techniques pour rendre les opérations de travail encore plus faciles.

- La poignée s'inspire de la section triangulaire, qui assure un vissage optimal, basé sur une plage de 120 °, en ligne avec une rotation maximale du poignet.
- La conception offre des propriétés ergonomiques remarquables, à la fois lors des opérations de vissage et de serrage rapides.
- La pointe sans chromage assure un couplage parfait avec la vis et est protégée de l'oxydation par un traitement phosphaté.

1290

Tournevis pour vis à fente



ISO 2380

SxAxL mm	L1 mm	Ø mm	CHF		
0,4x2,5x50	146	2,5	9.20	5	012900003
0,4x2,5x75	171	2,5	9.50	5	012900006
0,5x3x75	171	3,0	9.70	10	012900009
0,5x3x100	196	3,0	10.20	10	012900012
0,6x3,5x75	171	3,5	11.00	10	012900018
0,6x3,5x100	196	3,5	11.20	10	012900021
0,8x4x100	196	4,0	11.30	10	012900030
0,8x4x125	221	4,0	11.60	10	012900033
0,8x4x150	246	4,0	12.40	10	012900036
1x5,5x100	209	5,0	12.70	10	012900039
1x5,5x150	259	5,0	14.00	10	012900042
1,2x6,5x100	220	6,0	15.80	10	012900048
1,2x6,5x150	270	6,0	16.60	10	012900051
1,2x8x150	282	7,0	20.80	3	012900057
1,2x8x200	332	7,0	22.10	3	012900060
1,6x10x200	332	8,0	26.00	3	012900066
2x12x250	382	10	34.50	2	012900069

1290/S

Jeu de tournevis



	CHF		
1290/S5	72.50	1	012900305
1290			0,5x3x75-0,8x4x100 -1x5,5x150 1,2x6,5x150 -1,2x8x150 mm

	CHF		
1290/S9X	135.50	1	012900319
1290			0,4x2,5x75 - 0,5x3,5x100 0,8x4x125 - 1x5,5x150 1,2x6,5x150 - 1,2x8x200 1,6x10x200 mm
1290N			0,8x4x30 -1,2x6,5x30 mm

1290N

Tournevis à lame courte pour vis à fente



ISO 2380

SxAxL mm	L1 mm	Ø mm	CHF		
0,8x4x30	86	4	11.90	5	012900103
1,2x6,5x30	86	6	13.30	5	012900106

1292

Tournevis pour vis Phillips®



UNI/ISO 8764

PHxDxL mm	L1 mm	CHF		
0x3x60	156	8.75	10	012920003
0x3x100	196	10.00	5	012920006
1x4,5x80	189	12.00	10	012920009
1x4,5x120	229	13.40	10	012920012
2x6x100	220	16.00	10	012920018
2x6x150	270	17.10	10	012920021
3x8x150	282	21.80	3	012920024
4x10x200	332	30.00	3	012920027



	CHF		
1292/S4	58.00	1	012920304
			PH0x3x60-PH1x4,5x80 PH2x6x100-PH3x8x150 mm

1292N

Tournevis à lame courte pour vis Phillips®



UNI/ISO 8764

PHxDxL mm	L1 mm	CHF		
1x4,5x30	86	11.40	5	012920103
2x6x30	86	12.50	5	012920106

1292L

Tournevis à lame longue pour vis à empreinte Phillips®



UNI/ISO 8764-1

PHxDxL mm	L1 mm	CHF		
0x3x300	396	19.50	3	012920203
1x4,5x400	509	24.10	3	012920206
2x6x400	520	29.50	3	012920209



1293/D...

Jeu de tournevis

Betamax
MAXIMUM PERFORMANCE



1293/D6 CHF 78.00 1 012930401

1290 0,6x3,5x75-1x5,5x150
1,2x6,5x150 mm
1292 PH0x3x60 -PH1x4,5x80
PH2x6x100 mm

1293/D8 CHF 109.00 1 012930403

1290 0,5x3x75-0,8x4x100
1x5,5x150-1,2x6,5x150
1,2x8x150 mm
1292 PH0x3x60 -PH1x4,5x80
PH2x6x100 mm

1293/S...

Jeu de tournevis

Betamax
MAXIMUM PERFORMANCE



1293/S8 CHF 97.50 1 012930208

1290 2,5x50-3x75-4x100-5,5x150
6,5x150 mm
1292 PH0x3x60-PH1x4,5x80
PH2x6x100 mm

1293/S10 CHF 155.00 1 012930201

1290 0,4x2,5x50 -0,6x3,5x100
1x5,5x100-1,2x6,5x150
1,2x8x150-1,6x10x200 mm
1292 PH0x3x60 -PH1x4,5x80
PH2x6x100-PH3x8x150 mm

1293/S12 CHF 168.50 1 012930203

1290 0,5x3x75-0,8x4x125
1x5,5x150-1,2x6,5x150
1,2x8x200 mm
1290N 0,8x4x30 mm
1292 PH0x3x60 -PH1x4,5x80
PH2x6x100-PH3x8x150 mm
1292N PH1x4,5x30-PH2x6x30 mm

1293/S7 CHF 80.00 1 012930207

1292 PH0x3x60 -PH1x4,5x80
PH2x6x100 mm
1294 0,5x2,5x60-0,6x3x75
0,8x4x100-1x5x125 mm



1293ES

Clé mâle emmanchée pour vis 6 pans



mm	L mm	L1 mm	Ø mm	CHF	1	5
2	100	196	3	12.40	5	012930001
2,5	100	196	4	12.40	5	012930002
3	100	196	4	12.80	5	012930003
4	100	196	5	14.40	5	012930004
5	100	209	6	16.00	5	012930005
6	125	245	7	18.10	5	012930006
8	150	282	10	24.10	2	012930008



1293ES/S7 CHF 110.50 1 012930057
2-2,5-3-4-5-6-8 mm

1293BP

Clé mâle emmanchée à tête sphérique pour vis 6 pans



mm	L mm	L1 mm	CHF	1	5
2	100	196	12.50	5	012930501
2,5	100	196	12.50	5	012930502
3	100	196	12.90	5	012930503
4	100	196	14.40	5	012930506
5	100	209	16.00	5	012930509
6	125	245	18.50	5	012930512
8	150	282	25.00	2	012930515



1293BP/S7 CHF 112.00 1 012930558
2-2,5-3-4-5-6-8 mm

1294

Tournevis à lame fraisée pour vis à fente



SxDxL mm	L1 mm	CHF	1	5
0,5x2,5x60	156	8.55	5	012940003
0,6x3x75	171	9.05	5	012940006
0,6x3x100	196	9.30	5	012940009
0,8x4x100	196	11.30	5	012940012
0,8x4x150	246	14.80	5	012940015
1x5x125	234	14.10	5	012940018
1,2x6,5x150	282	16.70	5	012940027



1294/S5 CHF 60.00 1 012940305

0,5x2,5x60-0,6x3x100
0,8x4x100-1x5x125
1,2x6,5x150 mm

1294L

Tournevis à lame longue fraisée pour vis à fente



SxDxL mm	L1 mm	CHF	1	3
0,6x3x300	396	18.70	3	012940206
0,8x4x400	496	22.10	3	012940209
1x5x400	509	27.00	3	012940215
1,2x6,5x400	532	30.00	3	012940218

1295

Tournevis à frapper



1295 L mm 130 CHF 80.00 1 012950001

Beta
Quality Tools

1295/C14

Tournevis à frapper
avec 14 embouts et 1 douille porte-embouts



1295/C14 **CHF** 210.00 1 012950108

	866LP	1,2x6,5 - 1,6x10 mm
	866PH	PH2 - PH3
	866PZ	PZ2 - PZ3
	866PE	5 - 6 mm
	866TX	T27 - T30 - T40 - T45 - T50 - T55
	895/6	□ 1/2 - ○ 5/16
	1295	■ 1/2

170x100x35 mm - 1,3 kg

1297TX

Tournevis pour vis Torx®



Ø	L	L1	Ø	CHF		
mm	mm	mm	mm			
T6	50	146	3,0	16.30	5	012970006
T7	50	146	3,0	16.50	5	012970007
T8	60	156	3,0	16.60	5	012970008
T9	60	169	4,0	17.20	5	012970009
T10	80	189	4,0	18.40	5	012970010
T15	80	189	4,0	18.50	5	012970015
T20	100	209	4,5	19.00	5	012970020
T25	100	209	5,0	19.60	5	012970025
T27	115	235	6,0	20.20	5	012970027
T30	115	235	6,0	21.30	5	012970030
T40	130	262	7,0	23.70	2	012970040
T45	130	262	8,0	27.00	2	012970045



1297TX/S12 **CHF** 234.50 1 012970312
T6-T7-T8-T9-T10
T15-T20-T25-T27
T30-T40-T45



Betamax



1297TX/D6 **CHF** 117.00 1 012970409
T10-T15-T20
T25-T27-T30

1297TX/L

Tournevis à lame longue pour vis Torx®



Ø	L	L1	Ø	CHF		
mm	mm	mm	mm			
T15	210	319	4,0	20.60	2	012970115
T20	210	319	4,5	21.20	2	012970120
T25	210	319	5,0	21.80	2	012970125
T30	210	330	6,0	23.40	2	012970130
T45	210	342	8,0	25.50	2	012970145



Betamax



1297TX/L-S5 **CHF** 112.00 1 012970325
TX/L15-TX/L20-TX/L25-
TX/L30-TX/L45

1298RTX

Tournevis pour vis Tamper Resistant Torx®



Ø	L	L1	Ø	CHF		
mm	mm	mm	mm			
T9	60	169	4,0	19.00	5	012980009
T10	80	189	4,0	19.40	5	012980010
T15	80	189	4,0	20.60	5	012980015
T20	100	209	4,0	20.70	5	012980020
T25	100	209	4,5	21.20	5	012980025
T27	115	235	5,5	22.80	5	012980027
T30	115	235	6,0	23.70	5	012980030
T40	130	262	7,0	25.50	2	012980040



Betamax



1298RTX/S8 **CHF** 173.00 1 012980308
T9-T10-T15-T20
T25-T27-T30-T40

1299PZ

Tournevis pour vis Pozidriv®-Supadriv®



UNI/ISO 8764

PZ	L	L1	CHF		
	mm	mm			
0	60	156	12.70	5	012990000
1	80	189	14.90	5	012990003
2	100	220	20.20	5	012990006
3	150	282	29.00	2	012990009
4	200	332	41.50	2	012990012



Betamax



1299PZ/S6 **CHF** 107.00 1 012990306
1299PZ PZ0-PZ1-PZ2-PZ3
1299N/PZ PZ1-PZ2

1299N/PZ

Tournevis à lame courte
pour vis Pozidriv®-Supadriv®



UNI/ISO 8764

PZ	L	L1	CHF		
	mm	mm			
1	30	86	14.40	5	012990021
2	30	86	16.00	5	012990024

Beta
Quality Tools

REPARATION DE VEHICULES

Nos outils de réparation de véhicules qui sont utilisés par les professionnels les plus exigeants, sont développés et fabriqués pour répondre aux normes les plus élevées du monde, et régulièrement testés dans les conditions de fonctionnement les plus difficiles.

Depuis plus de 50 ans, nous travaillons fièrement et en collaboration les plus grands champions des sport mécaniques, nous aidant à améliorer continuellement nos produits et témoignant du niveau de qualité PREMIUM.

Les outils de réparations de véhicules se trouvent dans les sections:

Diagnostique

articles 1438 to 1499
articles 1758VT to 1760TMC

Moteur

articles 955 to 989A
articles 1438 to 1499

Vidange

articles 1438 to 1499
articles 1877 to 1885

Système électrique

articles 1438 to 1499

Boosters de démarrage

articles 1498BC/12 to 1498/40A

Transmission

articles 1438 to 1499

Suspension

articles 1549 to 1569CP

Freins

articles 1438 to 1499

Roues

articles 955 to 989A

Carrosserie

articles 1302 to 1369
articles 1763 to 1767A

Autres équipements

articles 1875LT to 3067

Levage

articles 3029/2T to 3067/70-13T



1302

Tas à main ronde bombée et panne.



g 770 CHF 124.00 1 013020001

1303

Tas virgule



g 1350 CHF 93.50 1 013030001

1304

Tas semelle



g 875 CHF 118.00 1 013040001

1305

Tas à courbure



g 1190 CHF 75.00 1 013050001

1305Z

Tas à courbure quadrillée



g 1065 CHF 88.50 1 013050002

1306

Tas talon



g 1040 CHF 70.00 1 013060001

1307

Tas américain

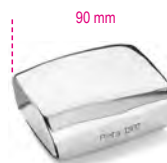

g 1100 CHF 137.50 1 013070001

1308

Tas œuf



g 1100 CHF 128.50 1 013080001

1310

Tas universel



g 1225 CHF 79.50 1 013100001

1312

Tas enclume



g 1220 CHF 170.00 1 013120001

1314

Tas à tête ronde convexe et plate "diabolo"



g 760 CHF 75.50 1 013140001

1326

Palette simple étroite bombée



g 560 CHF 67.50 1 013260001

1327

Palette simple longue bombée



g 1075 CHF 94.00 1 013270001

1328

Palette simple courte bombée



g 935 CHF 85.50 1 013280001

1329

Palette double à tables larges



g 1800 CHF 261.00 1 013290001

1330

Palette double col de cygne à tables larges



g 2125 CHF 278.00 1 013300001

1331

Fer à cintrer



g 1100 CHF 154.50 1 013310001

1335BM

Lime à planer, poignée en matériau thermoplastique



g 500 CHF 45.00 2 013350010

1337/S5

Jeu de 5 spatules de carrossier en acier inox

japonaises (25-50-75-100-125 mm)



L mm CHF 17.40 1 013370015

1338A - 1338B

Monture plate et flexible avec lime fraisée



1338A 9 360 127.50 2 013380001
1338B 12 360 134.50 2 013380002

1338

Monture sans lime



1338 CHF 69.50 2 013380003

1338R9 - 1338R12

Lime fraisée pour 1338A-B



1338R9 9 58.00 2 013380004
1338R12 12 65.00 2 013380005

1342

Burin plat de carrossier coupe en bout



L mm CHF 40.50 5 013420001

1342PM

Burin plat de carrossier coupe en bout avec protecteur

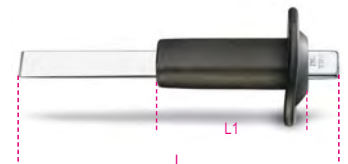

L mm L1 mm CHF 57.00 2 013420002

1342PMR

Protecteur pour 1342



1342PMR CHF 16.60 1 013420003

1343

Burin plat de carrossier coupe latérale



L mm CHF 42.00 5 013430001

1344

Paire de jauges d'épaisseur pour carrossiers à 10 lames avec ventouse de fixation

Indiqués pour :

- positionnement lunettes arrière
- maintien de la position pendant les montages



1344 CHF 48.50 1 013440010

1344A/VW

Outil de démontage de poignée de porte VW



L mm 260 CHF 22.20 1 013440100

1345

Marteau à planer tête ronde bombée et panne coudée, manche en bois



1345 CHF 59.50 2 013450010

1351

Marteau tête plate et panne ronde, manche en bois



1351 CHF 59.50 2 013510010

1353

Marteau tête ronde bombée et panne pointue, manche en bois



1353 CHF 59.50 2 013530010

1357Z/45

Marteau à rétreindre, manche en bois



1357Z/45 CHF 97.50 2 013570045

1359T

Marteau tête ronde plate et panne horizontale, manche en bois



1359 T CHF 59.50 2 013590010

1360G

Marteau en caoutchouc souple sans rebond, pour montage joints et composants délicats

L'extrême souplesse du maillet permet de ne pas abîmer les parties usinées, car il absorbe le choc en se déformant.



L mm 280 Ø mm 72 CHF 98.00 1 013600000

1360/K6

Marteau en aluminium avec tête ronde plate, embouts en plastique interchangeables et pointeau

Fourni avec :

- 4 embouts de plastique
- 1 pointeau réglable en 2 longueurs différentes applicable au marteau



L mm 320 Ø mm 34 CHF 113.00 1 013600006

1360/KP3

Marteau avec tête sphérique et panne pointue avec poinçon, en matière plastique

Le kit comprend :

- 1 marteau de 210 g avec tête Ø 30 mm
- 1 marteau de 290 g avec tête Ø 40 mm
- 1 poinçon de 75 g avec pointe de 5 mm



1360/KP3 CHF 108.50 1 013600503

1361/C12

Jeu d'embouts en Teflon® pour carrosserie



1361/C12 CHF 170.00 1 013610012

275x160x57 mm

1361/K9

Kit de 8 ventouses de débosselage de carrosserie

Le kit comprend :

- levier à rotule ronde Ø 31 mm longueur 110 cm
- levier avec pointe longueur 62 cm
- levier avec pointe en queue de baleine longueur 112 cm
- levier avec pointe de crochet longueur 27 cm
- levier à tête plate ronde longueur 50 cm
- levier à rotule ronde Ø 19 mm longueur 52 cm
- levier avec tête en queue de baleine longueur 27 cm
- levier avec tête en queue de baleine arrondie longueur 28 cm
- sac en tissu avec poignées

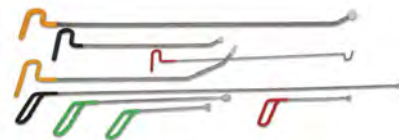

1361/K9 CHF 401.00 1 013610030

1362B

Disque de réflexion flexible pour la détection des bosses

- Surface entièrement revêtue de matériau anti-rayures
- Fourni en étui



1362B	Ø mm 755	CHF 103.00	1	013620011
-------	----------------	---------------	---	-----------

1364SE

Support extensible pour élément de carrosserie

Caractéristiques techniques :

- 4 roues pivotantes dont 2 équipées de frein
- pantographe extensible jusqu'à 1400 mm
- hauteur réglable jusqu'à 1315 mm
- blocage des positions
- surface d'appui revêtue de caoutchouc amovible

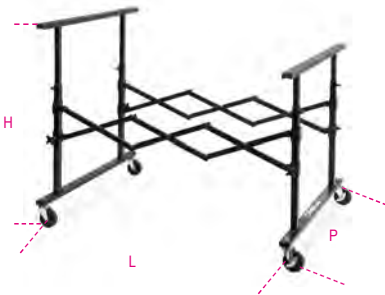

	L mm 215÷1400	H mm 780÷1315	P mm 890	CHF 529.00	1	013640001
--	---------------------	---------------------	----------------	---------------	---	-----------

1364SV

Support de peinture pour carrosserie avec plateau central

Caractéristiques techniques :

- surface d'appui revêtue de polyéthylène
- taille du plateau : 340x845x40 mm
- pliable



	H mm 1000	CHF 301.00	1	013640002
--	-----------------	---------------	---	-----------

1364SCP

Support de peinture ajustable et orientable pour éléments de carrosserie

Particulièrement adapté aux capots, ailes et portières équipé de 4 roues dont 2 pivotantes équipées de frein
Orientable à 180°



	H mm 1300	L mm 1100	P mm 680	CHF 482.00	1	013640003
--	-----------------	-----------------	----------------	---------------	---	-----------

1364SP

Chevalet avec ventouses pour les vitres et les pare-brises automobile

Idéal pour les vitres et les pare-brises automobile équipé de 4 ventouses Ø 95 mm
extension réglable grâce à une chaîne tubulaire revêtu de polyéthylène



	H mm 1250	L mm 950	CHF 240.50	1	013640004
--	-----------------	----------------	---------------	---	-----------

1364SR

Distributeur roulant pour rouleaux de papier de masquage

Caractéristiques techniques :

- équipé de 2 roues pour la manutention
- 3 tiges porte-rouleaux avec lame intégrée pour couper le papier
- support bande de papier intégrée
- Dimension max. des rouleaux : 350 - 650 -1050 mm



	L mm 1530	P mm 520	H mm 1080	H1 mm 960	CHF 308.00	1	013640005
--	-----------------	----------------	-----------------	-----------------	---------------	---	-----------

1365/K13

Coffret vérin carrossier 10 tonnes sur roulettes pour travaux de redressement de châssis et de carrosserie

Compris dans le kit:

- pompe oléohydraulique 10 tonnes avec tuyau flexible de 1,5 m branchement 1/2"
- piston
- pince écarte pare-chocs capacité 500 kg
- plaque d'appui 150x90 mm
- base en "L" 50x50 mm
- chasse-clous à 4 points
- chasse-clous strié rond Ø 50 mm
- chasse-clous en coin 43 mm
- rallonge 170 mm
- rallonge 300 mm
- rallonge 400 mm
- rallonge 530 mm
- tête en caoutchouc
- raccord mâle mâle pour montage accessoires



1365/K13	CHF 1,043.00	1	013650013
----------	-----------------	---	-----------

900x420x180 mm

1365P10

Pompe oléohydraulique

Tuyau de 1,5 m, branchement 1/2"



1365P10	CHF 465.00	1	013650110
---------	---------------	---	-----------

1366A

Kit de débosselage avec jeu de 19 ventouses en plastique

Idéal pour :

- bosselage dû à la grêle
- coups de portière
- petits défauts en général



1366A	CHF 117.00	1	013660200
-------	---------------	---	-----------

1366B

Marteau coulissant en T pour débosselage sans peinture

Poids du marteau: 500 g



L
mm 440 CHF 65.50 1 013660250

1366KF

Kit de 19 ventouses en plastique pour 1366A



1366/KF CHF 42.50 1 013660205

1366/K5

Ventouse de débosselage pneumatique avec masse à inertie de 1,1 kg

Compris dans le kit :

- 1 ventouse Ø 75 mm
- 1 ventouse Ø 100 mm
- 1 ventouse Ø 125 mm
- 1 crochet



1366/K5 CHF 308.00 1 013660010

610x240x90 mm

1366SH

Spotter multifonctions pour la réparation de la carrosserie

- Microprocesseur pour la gestion des paramètres de soudage
- Démarrage du cycle de soudage par contact et manuel
- Possibilité de régler le temps de pointage automatique
- Pistolet fourni avec raccord rapide et câble de masse de 2,2 m

Kit d'accessoires composé de :

- marteau extracteur
- tête pour rondelles à trois pointes
- 10 rondelles à 3 pointes
- électrode en carbone
- électrode pour écrasage



- Données techniques :
- Alimentation : 230 V
 - Puissance 50 % : 2,5 KVA
 - Pic de puissance : 13 KVA
 - Amp. Out : 2850 (2 %) A
 - Amp Out Max : 3200 A

1366SH CHF 2,630.00 1 013660400

1366SH/C

Chariot pour spotter 1366SH



1366SH/C CHF 513.00 1 013660410

1366SL

Levier à tirer pour réparation des tôles

Embout multi-crochets articulé pour utilisation avec fil ondulé



L
mm 700 CHF 310.00 1 013660002

1366ST

Barre de tirage pour réparation tôles

Embout multi-crochets articulé pour utilisation avec fil ondulé



L
mm 850 CHF 782.00 1 013660003

1366S/R1

Mandrin pour rondelles à 3 points



1366S/R1 CHF 30.50 1 013660501

1366S/R2

Rondelle à 3 points pour tirage de tôles



1366S/R2 CHF 30.50 1 013660502

Les prix indiqués se réfèrent à 20 pièces

1366S/R3

Électrode pour rondelles Ø 8x16x1,5 mm



1366S/R3 CHF 37.00 1 013660503

Beta

1366S/R4

Crochet pour rondelles Ø 8x16x1,5 mm



1366S/R4 CHF 32.00 1 013660504

1366S/R5

Rondelles Ø 8x16x1,5mm



1366S/R5 CHF 17.70 1 013660505

Les prix indiqués se réfèrent à 100 pièces

1366S/R6

Électrode pour vis M5-M6



1366S/R6 CHF 35.50 1 013660506

1366S/R7

100 embouts autotaraudeurs 5x18 mm



1366S/R7 CHF 30.50 1 013660507

1366S/R8

100 embouts autotaraudeurs 5x25 mm



1366S/R8 CHF 42.00 1 013660508

1366S/R9

100 embouts filetés M5 x 18 mm



1366S/R9 CHF 28.50 1 013660509

1366S/R10

10 rondelles à œillet



1366S/R10 CHF 19.60 1 013660510

1366S/R11

Électrode pour rondelles à œillet



1366S/R11 CHF 100.00 1 013660511

1366S/R12

10 rondelles à œillet à 90°



1366S/R12 CHF 39.00 1 013660512

1366S/R13

Électrode au carbone pour revenu tôles



1366S/R13 CHF 72.00 1 013660513

Les prix indiqués se réfèrent à 5 pièces

1366S/R14

Électrode pour soudure par point du fil



1366S/R14 CHF 34.50 1 013660514

1366S/R21

Fils ondulés pour utilisation levier et barre de tirage

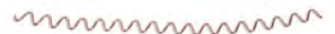

1366S/R21 CHF 24.30 1 013660551

Les prix indiqués sont pour 10 pièces

1366S/R22

Support magnétique pour fil ondulé



1366S/R22 CHF 83.50 1 013660552

1366S/R24

Anneau de tirage M4



1366S/R24 CHF 96.50 1 013660554

Les prix indiqués sont pour 5 pièces

1366S/R25

Anneau de tirage M5



1366S/R25 CHF 96.50 1 013660555

Les prix indiqués sont pour 5 pièces

1366S/R26

Anneau de tirage M6



1366S/R26 CHF 96.50 1 013660556

Les prix indiqués sont pour 5 pièces

1367/S4

Jeu d'emporte-pièces pour la pose des capteurs de stationnement

Dimensions : 23 - 24 - 27 - 28

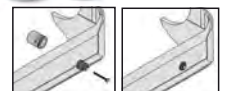

1367/S4 CHF 283.00 1 013670104



1367/K4

Kit comprenant 4 étriers carrosserie pour d'aligner le passage de roue avec la porte.



Ouverture maximale de la mâchoire : 6.5 mm

	L	H	S	CHF		
	mm	mm	mm			
1367/K4	62	40±58	15,7	87.00	1	013670010

1367/K10

Kit d'emporte-pièces pour la pose des capteurs de stationnement

Compris dans le kit:

• mesures : 17 - 18 - 18,2 - 19 - 20 - 22,5 - 24 - 26 - 26,7 - 32 mm



∅ 12 mm



	CHF		
1367/K10	238.00	1	013670200

190x130x58 mm



Beta



1368

Kit de réparation des pièces en plastique

• permet de réparer rapidement les fissures et les ruptures des pièces en plastique

Alimentation: 220+240 V avec prise Schuko
Longueur câble pistolet thermique: 3,5 m
Longueur câble alimentation: 1,35 m
2 réglages de puissance : 35-75 W
Pistolet thermique avec bouts en cuivre à 2 angles d'introduction de l'agrafe: 0°-90°
Protection input : disjoncteur thermique
Protection output : fusible 10 A
Gaine métallique pour ranger le pistolet

CE



	CHF		
1368	557.00	1	013680001

1368G/K400

Assortiment de 400 agrafes pour 1368



	CHF		
1368G/K400	95.50	1	013680140

1368G/OD

Agrafes ondulées droites pour 1368



	CHF		
1368G/OD	23.80	1	013680100

Les prix indiqués sont pour 100 pièces

1368G/SD

Agrafes à serpentín droites pour 1368



	CHF		
1368G/SD	23.80	1	013680110

Les prix indiqués sont pour 100 pièces

1368G/CV

Agrafes pour angles convexes pour 1368



	CHF		
1368G/CV	23.80	1	013680120

Les prix indiqués sont pour 100 pièces

1368G/C2U

Agrafes pour angles creux pour 1368



	CHF		
1368G/C2U	23.80	1	013680130

Les prix indiqués sont pour 100 pièces

MANCHES DE MARTEAU

L'Hickory est une essence de bois aux excellentes propriétés qui convient parfaitement aux manches de marteau. Sa structure en fibres longues absorbe les vibrations et le rend extrêmement résistant à la rupture. Dans le cas peu probable où certaines fibres se briseraient, le risque que la tête se détache soudainement est infime. Les poignées en bois peuvent être remplacées lorsqu'elles sont usées. Le bois étant un matériau naturel, il doit conserver sa propre humidité. Par conséquent, il est déconseillé de stocker le marteau dans un endroit excessivement sec.

Manches en **fibre de verre**

Les manches fibre de verre sont à la fois durables et robustes ; le risque de casse et de blessures est infime. Ils sont étanches et résistent aux produits chimiques standard.

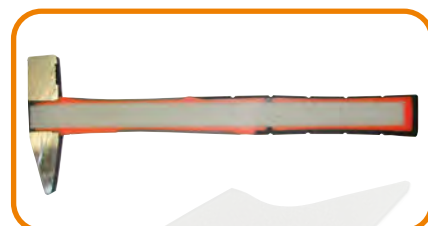

• **Fibre de verre quasi-indestructible**

• **Manche ergonomique en polypropylène**

• **Revêtement élastomère antidérapant et confortable**

1369/C11

Composition de 11 outils



1369/C11 CHF 1,111.00 1 013690033



470x340x70 mm - 15,2 kg

1370

Marteau de mécanicien, manche en bois



UNI 7778 DIN 1041

HICKORY

g	A mm	L mm	L1 mm	CHF		
100	15	260	82	15.80	5	013700051
200	19	280	95	17.70	5	013700052
300	23	300	105	20.20	5	013700053
400	25	310	112	22.90	5	013700054
500	27	320	118	24.70	5	013700055
600	30	330	122	28.50	5	013700056
800	33	350	130	32.00	4	013700058
1000	36	360	135	38.50	4	013700060
1500	42	380	145	44.00	2	013700065
2000	47	400	155	52.00	1	013700070

1370/MR...

Manche pour 1370



	CHF		
1370MR 100 1370/100	7.05	4	013700081
1370MR 200 1370/200	7.90	4	013700082
1370MR 300 1370/300	8.55	4	013700083
1370MR 400 1370/400	9.20	4	013700084
1370MR 500 1370/500	10.10	4	013700085
1370MR 600 1370/600	11.10	4	013700086
1370MR 800 1370/800	11.60	4	013700088
1370MR 1000 1370/1000	12.40	4	013700090
1370MR 1500 1370/1500	14.00	4	013700095
1370MR 2000 1370/2000	15.80	4	013700100

1370T

Marteau de mécanicien, manche en fibre



g	A mm	L mm	L1 mm	CHF		
200	19	280	95	27.00	5	013700620
300	23	300	105	30.00	5	013700630
500	27	320	118	33.00	5	013700650
800	33	350	130	34.50	4	013700680
1000	36	360	135	44.00	4	013700700
1500	42	365	145	51.50	2	013700750

1370F

Marteau de mécanicien tête rivoir, manche en bois



NF E 71.014

A mm	L mm	L1 mm	CHF		
24	260	77	280	27.50	2 013700424
26	260	80	310	29.00	2 013700426
28	280	86	400	30.50	2 013700428
30	280	92	450	32.00	2 013700430
32	300	100	550	34.00	2 013700432
36	300	104	720	44.00	2 013700436
40	330	110	1065	48.50	2 013700440
42	330	116	1080	51.50	2 013700442
50	380	138	1760	54.00	2 013700450
60	380	160	2585	67.00	2 013700460

1370F/MR...

Manche pour 1370F



	CHF		
1370F/MR 24 1370F/24-26	6.95	2	013700474
1370F/MR 28 1370F/28-30	7.55	2	013700478
1370F/MR 32 1370F/32-36	8.75	2	013700482
1370F/MR 40 1370F/40-42	11.00	2	013700490
1370F/MR 50 1370F/50	12.40	2	013700495
1370F/MR 60 1370F/60	15.00	2	013700496

1370FT

Marteau de mécanicien tête rivoir, manche en fibre



A mm	L mm	L1 mm	CHF		
28	280	86	530	44.50	1 013700528
30	280	92	625	46.50	1 013700530
32	300	100	750	48.50	1 013700532
36	300	104	930	57.50	1 013700536
40	330	110	1150	60.50	1 013700540
42	330	116	1250	62.50	1 013700542
50	380	138	2100	70.50	1 013700550
60	380	160	2750	76.00	1 013700560

1374F

Marteau de menuisier tête rivoir, manche en bois



NF E 71.012

A mm	L mm	L1 mm	CHF		
16	250	80	180	22.00	2 013740416
20	270	86	250	24.40	2 013740420
22	290	92	335	25.00	2 013740422
26	290	103	425	28.50	2 013740426
28	310	108	510	30.00	2 013740428
30	310	117	580	31.50	2 013740430

1374F/MR...

Manche pour 1374F



	CHF		
1374F/MR 16 1374F/16	6.45	2	013740456
1374F/MR 20 1374F/20	6.60	2	013740460
1374F/MR 22 1374F/22-26	6.70	2	013740462
1374F/MR 28 1374F/28	7.55	2	013740468
1374F/MR 30 1374F/30	8.15	2	013740470

1375

Marteau de charpentier,
manche en bois



g	L1 mm	Ø mm	L mm	CHF	Icon	Icon
300	95	25	300	25.00	2	013750000

1375/MR

Manche pour 1375



CHF	Icon	Icon
11.50	2	013750003

1375A

Marteau de charpentier,
manche en plastique et fibre de verre



oz	g	L mm	L1 mm	CHF	Icon	Icon
16	450	330	130	36.50	3	013750016
20	570	330	130	38.50	3	013750020

1375B

Marteau de charpentier,
manche en acier



oz	g	L mm	L1 mm	CHF	Icon	Icon
16	450	330	130	33.50	3	013750026
20	570	330	130	34.00	3	013750030

1376X

Marteau de charpentier
avec porte-clous aimanté,
manche en bois



g	A mm	L1 mm	L mm	CHF	Icon	Icon
250	20	125	450	24.10	3	013760125
300	25	130	450	25.50	3	013760130
400	27	132	450	28.00	3	013760140

1376X/MR

manche pour 1376X



CHF	Icon	Icon
13.50	2	013760161

1376XT

Marteau de charpentier
avec porte-clous aimanté,
manche en plastique



g	A mm	L1 mm	L mm	CHF	Icon	Icon
250	20	125	500	29.00	3	013760525
300	25	130	500	30.50	3	013760530
400	27	132	500	33.00	3	013760540

1376XT/MR

Manche pour 1376XT



CHF	Icon	Icon
15.60	2	013760585

1377

Marteau américain, manche en bois



g	L mm	L1 mm	CHF	Icon	Icon
340	330	95	36.50	2	013770134
450	350	102	38.50	2	013770145
570	350	110	44.00	2	013770157
680	360	116	46.00	2	013770168
900	380	120	47.50	2	013770190

1377/MR...

Manche pour 1377



CHF	Icon	Icon
8.00	2	013770234
9.20	2	013770245
10.20	2	013770257
10.30	2	013770268
12.90	2	013770290

1377T

Marteau américain,
manche en fibre



g	L mm	L1 mm	CHF	Icon	Icon
340	330	95	34.00	2	013770534
450	350	102	41.00	2	013770545
570	350	110	44.50	2	013770557
680	360	116	47.50	2	013770568
900	380	120	54.50	2	013770590

1378

Marteau américain, manche en bois



g	L mm	L1 mm	Ø mm	CHF	Icon	Icon
340	330	100	27	33.50	2	013780134
570	350	115	32	44.00	2	013780157

1378/MR...

Manche pour 1378



CHF	Icon	Icon
7.55	2	013780234
10.50	2	013780257

1379F

Marteau d'électricien tête rivoir,
manche en bois



A mm	L mm	L1 mm	CHF	Icon	Icon
16	250	126	21.80	2	013790416
18	250	135	23.80	2	013790418
20	260	142	25.00	2	013790420

1379F/MR...

Manche pour 1379F



	CHF		
1379F/MR 16	6.80	2	013790426
1379F/16-18			
1379F/MR 20	7.55	2	013790430
1379F/20			

1380

Massette, manche en bois



HICKORY

UNI 7777 DIN 6475

g	A mm	L mm	L1 mm	CHF		
800	38	260	90	28.00	2	013800208
1000	40	260	95	30.00	2	013800210
1250	43	260	100	31.50	2	013800212
1500	45	280	110	36.50	2	013800215
2000	50	300	120	47.00	2	013800220

1380/MR...

Manche pour 1380



	CHF		
1380MR 800	8.85	2	013800238
1380/800-1000-1250			
1380MR 1500	9.50	2	013800245
1380/1500			
1380MR 2000	10.90	2	013800250
1380/2000			

1380S

Massette avec collerette de protection, manche en bois



g	A mm	L mm	L1 mm	CHF		
800	36	260	90	30.50	2	013800400
1000	39	260	95	34.00	2	013800405
1250	43	260	100	36.50	2	013800410
1500	45	260	110	41.00	2	013800415

1380S/MR...

Manche pour 1380S



	CHF		
1380S/MR 800	9.20	2	013800417
1380S/800-1000-1250			
1380S/MR 1500	10.10	2	013800419
1380S/1500			

1380T

Massette, manche en fibre



g	A mm	L mm	L1 mm	CHF		
800	35	260	85	42.50	2	013800308
1000	40	260	100	43.50	2	013800310
1250	42	260	110	46.00	2	013800312
1500	45	260	120	49.00	2	013800315
2000	49	295	120	59.50	1	013800320

1381

Masse gros effort avec manche en hickory



g	A mm	L mm	L1 mm	CHF		
3000	55	800	142	114.00	1	013810030
4000	60	900	152	127.00	1	013810040
5000	70	900	162	144.50	1	013810050
8000	80	900	185	250.00	1	013810080

* = Manche en frêne

1381/MR...

Manche pour 1381



	CHF		
1381MR 3-4	56.50	2	013810730
1381/3000-4000			
1381MR 5	59.00	2	013810750
1381/5000			
1381MR 8	59.00	2	013810780
1381/8000			

1381T

Masse gros effort avec manche en fibre



g	A mm	L mm	L1 mm	CHF		
3000	55	900	142	124.00	1	013810330
4000	60	900	152	135.50	1	013810340
5000	70	900	162	155.00	1	013810350
8000	82	920	180	286.00	1	013810380

1385

Massette en cuivre, manche en bois



g	A mm	L mm	L1 mm	CHF		
400	26	260	75	43.50	2	013850404
600	32	270	80	62.50	2	013850406
800	34	280	90	82.50	2	013850408
1000	37	280	100	102.50	2	013850410
1500	43	280	110	150.50	2	013850415
2000	48	300	120	202.50	1	013850420

1385/MR

Manche pour 1385



	CHF		
1385MR 400	12.40	2	013850464
1385 400			
1385MR 600	12.80	2	013850466
1385 600			
1385MR 800	13.20	2	013850468
1385 800			
1385MR 1000	14.10	2	013850470
1385 1000			
1385MR 1500	15.80	1	013850475
1385 1500			
1385MR 2000	16.10	1	013850480
1385 2000			

1390

Maillet à embouts nylon, manche en bois



UNI 7784

Ø mm	L mm	L1 mm	CHF		
22	260	70	24.70	5	013900022
28	280	85	30.50	5	013900028
35	310	95	41.50	5	013900035
45	320	107	66.50	4	013900045
60	380	128	112.00	2	013900060

1390/MR...

Manche pour 1390



	CHF		
1390MR 22	6.00	2	013900222
1390 22			
1390MR 28	6.95	2	013900228
1390 28			
1390MR 35	8.25	2	013900235
1390 35			
1390MR 45	10.10	2	013900245
1390 45			
1390MR 60	12.40	2	013900260
1390 60			

1390R

Embout en nylon pour 1390



Ø mm	CHF		
22	3.90	4	013900122
28	5.95	4	013900128
35	8.00	4	013900135
45	13.50	4	013900145
60	23.40	4	013900160

1390N

Maillet à embouts nylon, manche en bois

Embouts mi-durs : 75 Shore
Résistant à l'huile et à l'usure
Particulièrement adapté pour travailler tôles et métaux



UNI 7784

Ø mm	L mm	L1 mm	CHF		
22	260	70	24.70	3	013900522
28	280	85	30.50	3	013900528
35	310	95	41.50	3	013900535
45	320	107	66.50	2	013900545
60	380	128	112.00	2	013900560

1390NR

Embout en nylon pour 1390N



Ø mm	CHF		
22	3.90	4	013900622
28	5.95	4	013900628
35	8.00	4	013900635
45	13.50	4	013900645
60	23.40	4	013900660

1391

Maillet sans rebond monobloc



Ø mm	L mm	L1 mm	CHF		
35	280	90	38.00	2	013910135
50	320	105	49.00	2	013910150
55	355	110	58.00	2	013910155
65	380	130	80.00	2	013910165

1391A

Maillet de carreleur, entièrement gainée en caoutchouc



g	Ø mm	L mm	L1 mm	CHF		
500	45	290	100	35.50	2	013910205
1000	60	300	120	47.00	2	013910210

1392

Maillet sans rebond à poignée surmoulée grand confort, manche en acier



Ø mm	L mm	L1 mm	CHF		
30	300	105	64.00	2	013920030
35	305	115	68.00	2	013920035
40	310	125	78.50	2	013920040
50	325	135	92.50	2	013920050
60	385	155	142.50	2	013920060

1392R

Embout en nylon pour 1392



Ø mm	CHF		
30	8.55	4	013920230
35	12.50	4	013920235
40	19.00	4	013920240
50	25.50	4	013920250
60	38.00	4	013920260

1393

Massette avec tête en caoutchouc dur



Ø mm	L mm	L1 mm	CHF		
50	315	90	16.70	3	013930050
60	340	110	19.00	3	013930060
70	370	130	22.80	2	013930070

REPARATION DE VEHICULES

Nos outils de réparation de véhicules qui sont utilisés par les professionnels les plus exigeants, sont développés et fabriqués pour répondre aux normes les plus élevées du monde, et régulièrement testés dans les conditions de fonctionnement les plus difficiles.

Depuis plus de 50 ans, nous travaillons fièrement et en collaboration les plus grands champions des sport mécaniques, nous aidant à améliorer continuellement nos produits et témoignant du niveau de qualité PREMIUM.

Les outils de réparations de véhicules se trouvent dans les sections:

Diagnostique

articles 1438 to 1499
articles 1758VT to 1760TMC

Moteur

articles 955 to 989A
articles 1438 to 1499

Vidange

articles 1438 to 1499
articles 1877 to 1885

Système électrique

articles 1438 to 1499

Boosters de démarrage

articles 1498BC/12 to 1498/40A

Transmission

articles 1438 to 1499

Suspension

articles 1549 to 1569CP

Freins

articles 1438 to 1499

Roues

articles 955 to 989A

Carrosserie

articles 1302 to 1369
articles 1763 to 1767A

Autres équipements

articles 1875LT to 3067

Levage

articles 3029/2T to 3067/70-13T



1410/M

Crochet pour traction des ressorts



Ø mm	CHF	Hand	Part No.
3,5	24.20	2	014100051

1428

Extracteur d'écrous endommagés avec carrés 3/8" et 1/2"



Ø mm	□ mm	L mm	Ø mm	CHF	Hand	Part No.
8	3/8	36	17	24.10	2	014280008
10	3/8	36	17	24.10	2	014280010
11	3/8	36	17	24.10	2	014280011
12	3/8	36	19	24.10	2	014280012
13	3/8	36	19	24.10	2	014280013
14	3/8	36	19	24.10	2	014280014
15	1/2	38	21	25.50	2	014280015
16	1/2	38	21	25.50	2	014280016
17	1/2	38	21	25.50	2	014280017
18	1/2	38	26	25.50	2	014280018
19	1/2	38	26	25.50	2	014280019
20	1/2	38	26	28.00	2	014280020
21	1/2	38	26	28.00	2	014280021
22	1/2	38	26	30.50	2	014280022
24	1/2	38	26	30.50	2	014280024
27	1/2	38	26	32.00	2	014280027

1428L

Douille extractrice d'écrous endommagés, série longue, avec carrés 3/8" et 1/2"



Ø mm	CHF	Hand	Part No.
17	60.50	1	014280217
19	62.50	1	014280219
21	67.50	1	014280221



Part No.	CHF	Hand	Part No.
1428L/B3 17-19-21 mm	191.00	1	014280303



Part No.	CHF	Hand	Part No.
1428/SB11 8-10-11-12-13-14 15-16-17-18-19 mm	293.00	1	014280111
1428/SB5 20-21-22-24-27 mm	162.50	1	014280115

1429

Extracteur de vis et goujons cassés avec carrés 3/8" et 1/2"



mm	□	L mm	CHF	Hand	Part No.
2	3/8	60	15.90	3	014290002
3	3/8	60	15.90	3	014290003
4	3/8	60	15.90	3	014290004
5	3/8	60	16.70	2	014290005
6	3/8	60	16.70	2	014290006
8	1/2	70	18.20	2	014290008
10	1/2	70	18.60	2	014290010



Part No.	CHF	Hand	Part No.
1429/SB7 2-3-4-5-6-8-10 mm	132.50	1	014290107

1430/...

Extracteur de goujons cassés en acier allié

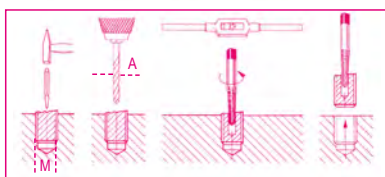

Part No.	M	A mm	CHF	Hand	Part No.
1430/1	3+6	2,5	4.45	10	014300006
1430/2	6+8	3,0	4.95	10	014300008
1430/3	8+11	4,5	5.95	10	014300011
1430/4	11+14	6,0	7.90	10	014300014
1430/5	14+18	8,0	8.85	10	014300018
1430/6	18+24	11,0	17.40	5	014300024
1430/7	24+33	14,0	26.00	5	014300033
1430/8	33+50	21,0	33.50	5	014300050



Part No.	CHF	Hand	Part No.
1430/S5 1430/1-1430/2-1430/3 1430/4-1430/5	33.50	1	014300105
1430/S6 1430/1-1430/2-1430/3 1430/4-1430/5-1430/6	47.50	1	014300106
1430/S8 1430/1-1430/2-1430/3 1430/4-1430/5-1430/6 1430/7-1430/8	107.00	1	014300108

1431/...

Extracteur de vis et goujons cassés

Pour enlever les vis et les goujons sans possibilité de prise insertion à percussion

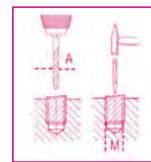

Part No.	M	A mm	L mm	□ mm	CHF	Hand	Part No.
1431/3	3+6	2,5	59	5	8.00	10	014310051
1431/5	6+8	5,0	68	5	8.00	10	014310052
1431/6	8+11	6,0	72	6	9.50	10	014310053
1431/8	11+14	8,0	77	8	10.30	10	014310054
1431/9	14+18	9,0	82	9	11.10	10	014310055

1431/C5

Extracteurs coniques pour vis et goujons brisés

Insertion à percussion

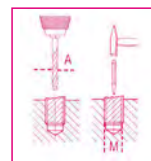

Part No.	M mm	A mm	CHF	Hand	Part No.
1431/C5 3+6 8+11	3+6	2,5+9	47.00	1	014310055

1433

Extracteur à rouleaux pour goujons

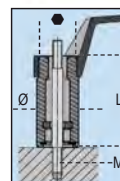

M mm	Ø mm	L mm	● mm	□	CHF	Hand	Part No.
5	21	60	19	3/8	17.70	2	014330005
6	24	60	21	1/2	17.70	2	014330006
7	24	60	21	1/2	17.70	2	014330007
8	24	60	21	1/2	17.70	2	014330008
9	28	70	21	1/2	21.10	2	014330009
10	28	70	21	1/2	21.10	2	014330010
10,5	28	70	21	1/2	21.10	2	014330021
11	28	70	21	1/2	21.10	2	014330011
12	28	70	21	1/2	21.10	2	014330012
14	36	72	24	-	33.50	2	014330014
16	36	72	24	-	33.50	2	014330016

1433/C11

Extracteur à rouleaux pour goujons avec carré femelle 1/2"

38

12



1433/C11 CHF 343.00 1 014330311
M5 - M6 - M7 - M8 - M9 - M10 - M10,5
M11 - M12 - M14 - M16
340x135x56 mm - 3,0 kg

1435

Extracteur de goujons à molette

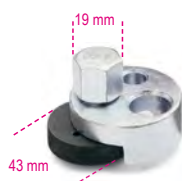

Ø mm 4÷20 CHF 129.00 1 014350001

1435R

Molette pour 1435



1435R CHF 40.50 1 014350010

1435/1

Extracteur de goujons à molette



Ø mm 19÷26 CHF 160.00 1 014350002

1435/1R

Molette pour 1435/1

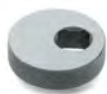

1435/1R CHF 41.50 1 014350011

1437/C12

Composition de 12 outils pour enlever les airbags



1437/C12 CHF 128.50 1 014370001
260x160x55 mm - 1,0 kg

1438

Centreur universel d'embrayage avec 3 cônes extensibles



1438 CHF 69.50 1 014380001

1438R

Embouts pour 1438



Ø mm CHF 5 014380101
14÷18 4.70 5 014380102
18÷21 4.70 5 014380103
22÷25 4.70 5 014380103

1438EVO

Kit universel pour le centrage des embrayages

Composants entièrement en métal



1438EVO CHF 309.00 1 014380011
290x200x60 mm - 2 kg

1438DSG

Levier pour blocage/déblocage des boîtes de vitesses DSG à double embrayage du groupe VAG



1438DSG CHF 42.00 1 014380200

1438K/DSG-2

Kit d'outils pour l'alignement des embrayages DSG, 6 et 7 vitesses à partir de 2003

Pour utilisation avec DSG 6 rapports et transmission manuelle, DSG à 7 rapports (séries 1 et 2) et S-tronic.



1438K/DSG-2 CHF 777.00 1 014380260
350x370x117 mm - 10 kg

1438K/PWR

Kit d'outils de dépose / d'installation pour transmission sèche à double embrayage Ford et Volvo



1438K/PWR CHF 532.00 1 014380270
440x400x85 mm - 10 kg

1438DCT/S

Kit d'outils pour aligner les doubles embrayages à secs Ford

pour l'alignement de l'embrayage après l'exécution des travaux comme le remplacement du joint d'huile d'embrayage



1438DCT/S	CHF 404.00	1	014380305
440x400x85 mm - 8 kg			

1439/K7

Coffret tournevis long à renvoi d'angle 90° avec lames



Composition coffret:
- Tournevis à renvoi d'angle
- 1 embout pour vis à fente
- 1 douille porte-embouts
- 1 embout pour lames spéciales
- 7 lames spéciales

1439K7	CHF 258.00	1	014390101
500x120x60 mm - 825 g			

1440/...

Collier à segments



	Ø mm	L mm	CHF		
1440/0	40÷75	50	38.50	1	014400000
1440/1	57÷125	80	50.00	1	014400010
1440/1A	57÷125	100	57.00	1	014400011
1440/2	90÷175	80	60.50	1	014400020
1440/2A	90÷175	100	64.00	1	014400021
1440/3	90÷175	165	93.00	1	014400030

1445/1 - 1445/2

Pince à segments



	Ø mm	CHF		
1445/1	50÷100	52.50	1	014450001
1445/2	90÷150	67.50	1	014450002

1452K

Lève-soupapes avec trois brides

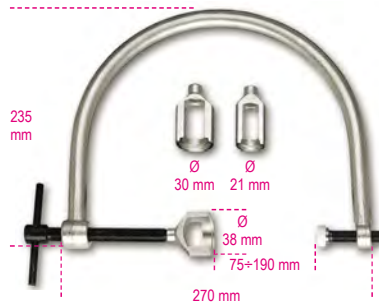

1452K	CHF 200.00	1	014520100
-------	---------------	---	-----------

1452PN/K

Démonte soupapes pneumatique

Pression de poussée 1400 N



Ø mm	L mm	L1 mm	CHF		
16-19-23	230	185	427.00	1	014520110
25-30-42					

1454P

Grattoir pour enlever les résidus de mastic et d'emballage

Particulièrement recommandé pour le nettoyage des têtes et surfaces planes à coupler



L mm	L1 mm	± mm	CHF		
210	32	3,3	56.00	1	014540010

1455SVP

Rodoir de soupapes pneumatique

• Pression d'alimentation: 6 bars



1455SVP	CHF 487.00	1	014550001
---------	---------------	---	-----------

1455SVP/R...

Ventouses en caoutchouc pour 1455SVP



	CHF		
1455SVP/R1	8.75	5	014550501
1455SVP/R2	8.75	5	014550502
1455SVP/R3	8.75	5	014550503

1457/B4

Jeu d'outils pour le déblocage des connecteurs Rilsan

Mesures comprises :

- 6x8
- 10x12
- 15x16
- 18x1/2



1457/B4	CHF 65.00	1	014570024
---------	--------------	---	-----------

1458

Pince à joncs extérieurs



DIN 5417

Ø mm	CHF		
30÷100	95.50	2	014580001

1460F

Pince pour joints d'étanchéité de soupapes



1460F CHF 82.00 1 014600010

1462CF/C6

Jeu de 6 clés polygonales ouvertes pour raccords d'injecteurs

Dimensions:
12-14-16-17-18-19 mm

12"



1462CF/C6 CHF 127.00 1 014620006

260x145x60 mm - 1,2 kg

1462CF

Clé polygonale ouverte pour raccords d'injecteurs

12"



mm	CHF		
12	20.20	1	014620012
14	20.50	1	014620014
16	20.80	1	014620016
17	21.30	1	014620017
19	22.50	1	014620019
18	21.80	1	014620018

1462CF-SN/C6

Jeu de 6 clés 6-pans articulées ouvertes pour raccords d'injecteurs

Mesures :
12-14-16-17-18-19

38"



1462CF-SN/C6 CHF 184.00 1 014620026

275x182x64 mm

1462CF-SN

clés hexagonales articulées à une extrémité pour connecteurs d'injecteur de carburant

38"



mm	CHF		
12	32.00	1	014620032
14	33.00	1	014620034
16	34.50	1	014620036
17	35.50	1	014620037
18	36.00	1	014620038
19	38.00	1	014620039

1462/KI

Composition d'outils pour extraction injecteurs Diesel Common Rail

Permet d'enlever les injecteurs DELPHI-BOSCH-SIEMENS-DENSO



1462/KI CHF 3,300.00 1 014620235

530x470x140 mm - 2,0 kg

1462/KU

Composition universelle d'outils pour l'extraction des injecteurs Diesel Common Rail

Incluant pince et extracteur à inertie



1462/KU CHF 986.00 1 014620100

390x290x100 mm - 4,5 kg

1462/MB

Kit de face de marteau pour retirer les injecteurs

Contenu du kit :

- 1 face de marteau de 4 kg avec tige de 400 mm
- 1 adaptateur articulé, mâle M10x1.5, femelle M22x1.5 mm
- 1 adaptateur, mâle M22x1.5, femelle M13x1.4 mm
- 1 adaptateur, mâle M14x1.5, femelle M27x1 mm
- 1 adaptateur, mâle M14x1.5, mâle M25x1 mm
- 1 adaptateur, mâle M14x1.5, mâle M27x1 mm
- 1 adaptateur, mâle M14x1.5, femelle M14x1.5 mm
- 1 adaptateur, mâle M14x1.5, mâle M20x1 mm
- 1 adaptateur, mâle M14x1.5, mâle M17x1 mm



1462/MB CHF 397.00 1 014620110

500x250x80 mm - 7,2 kg

1462AD/BSC

Adaptateur pour l'extraction des injecteurs Bosch Common Rail

À utiliser avec les articles Beta 960KI et Beta 1462/KU



1462AD/BSC CHF 286.00 1 014620435

1462AD/SMN

Kit d'adaptateurs pour l'extraction des injecteurs

Siemens et Denso

À utiliser avec l'article Beta 960KI/1462KI



1462AD/SMN CHF 428.00 1 014620436

1462/EI

Outil universel à vibrations pour extraction des injecteurs

- Favorise l'extraction d'injecteurs fortement grippés de leur logement, sans abimer la tête et en évitant d'éventuelles ruptures.

- Utilisable avec tous kits d'extraction d'injecteurs avec ou sans extracteur à inertie

- L'outil agit directement avec ses vibrations et percussions sur le tirant d'extraction qui est accouplé avec l'injecteur

- Au moyen de la vanne de réglage, il est possible d'adapter l'intensité de la vibration en fonction du type d'intervention à effectuer.

CE



1462/EI CHF 872.00 1 014620240

 **Beta**
Quality Tools

1463/KIT

Kit outillage pour blocage des poulies de distribution



1463/KIT CHF 532.00 1 014630001
☞ 280x140x75 mm - 📦 1,2 kg

1464T

Testeur de pression digital

CARACTÉRISTIQUES

- Écran tactile de 5"
- Batterie au lithium polymère rechargeable
- Capteur de 80 bars (basses pressions) et câble USB



Avec kit 960AD/TP2, il permet de vérifier :

- compression moteurs essence et diesel
- pression huile moteur
- basse pression common rail
- pression injection essence

Avec kit 1464AP, il permet de vérifier :

- pression réelle circuit common rail
- pression pompe haute pression

1464T CHF 1,159.00 1 014640050

1464T/SP80

Capteur de pression de 80 bars pour 1464T et 960TP



1464T/SP80 CHF 398.00 1 014640053

960AD/TP2

Jeu d'adaptateurs pour 1464T, en coffret plastique



960AD/TP2 CHF 687.00 1 009600510
☞ 430x310x50 mm - 📦 3,2 kg

1464CBD

Jeu complet d'adaptateurs pour le contrôle de la compression dans les moteurs essence et Diesel avec 1464T

Permet de se connecter au moteur pour le contrôle de la compression essence et Diesel au moyen de l'instrument 1464T.

Comprend :

- 8 fausses bougies avec vanne de non-retour
- 44 fausses petites bougies avec vanne de non-retour
- 1 faux injecteur réglable universel pour voitures, camions, moteurs marins et machines agricoles
- 1 adaptateur à 90°, soupape de sécurité et tuyau de branchement
- espace pour loger l'instrument 1464T à l'intérieur du coffret



1464CBD CHF 946.00 1 014640300
☞ 510x410x140 mm - 📦 5,5 kg

1464IC

Kit complet de faux injecteurs et de fausses bougies, pour 1464T

Permet de se brancher au moteur pour le contrôle de la compression des moteurs diesel avec le testeur numérique 1464T

Comprend :

- 22 fausses bougies
- 5 faux injecteurs
- 1 kit faux injecteur universel pour voitures, camions, bateaux et machines agricoles



1464IC CHF 777.00 1 014640350
☞ 559x312x50 mm - 📦 4,5 kg

1464IC/RK

Kit faux injecteur universel pour voitures, camions, bateaux et machines agricoles

Fourni avec art. 1464IC



1464IC-RK CHF 251.00 1 014640377
☞ 200x110x30 mm - 📦 885 g

1464AP

Kit pour le contrôle du système haute pression des moteurs diesel common rail, avec 1464T

Éléments fournis :

- jeu de tuyaux haute pression
- raccords de branchement
- capteur de 2.000 bars



1464AP CHF 1,047.00 1 014640450
☞ 430x310x50 mm - 📦 1,8 kg

1464AP T

Tuyau haute pression pour 1464AP et 960TAP



1464AP T12X12 CHF 82.00 1 014640453
1464AP T12X14 82.00 1 014640454
1464AP T14X12-M1,0 82.00 1 014640455

1464AP T16X12



1464AP T16X12 CHF 96.50 1 014640456

1464FG

Jeu de faux régulateurs pour le contrôle du système Diesel common rail (à utiliser avec les articles 1464T-1464AP)

Utilisé avec le testeur et les adaptateurs dédiés, permet de comprendre si le problème se situe au niveau de la pompe haute pression ou du régulateur en cas d'absence de pression dans le circuit de haute pression dans les moteurs Diesel common rail. Indiqué pour les régulateurs de pression Bosch, Delphi, Denso et Siemens



1464FG CHF 404.00 1 014640470

350x250x80 mm - 1,8 kg

1464FG/CP4

Faux régulateur pour pompe Bosch CP4 non inclus dans 1464FG



1464FG/CP4 CHF 59.00 1 014640475

1464APB

Kit de contrôle du système essence haute pression des moteurs FSI, à utiliser avec 1464T

Comprend un capteur de 200 bars et raccords de branchement



1464APB CHF 515.00 1 014640500

240x210x50 mm - 0,5 kg

1464PB

Jeu de 9 connecteurs pour le contrôle de la basse pression carburant (à utiliser avec 1464T)

A travers les connexions rapides reliées au testeur 1464T effectue rapidement le contrôle de la basse pression carburant pour moteurs Diesel et essence



1464PB CHF 717.00 1 014640700

530x440x120 mm - 3,8 kg

1464ADB

Kit pour le contrôle de la pression du système AdBlue® pour 1464T

Fourni avec adaptateurs à utiliser avec le capteur standard de 80 bar présent dans le 1464T



1464ADB CHF 119.00 1 014640620

240x210x50 mm - 0,5 kg

1464FAP

Kit pour le contrôle de la pression du filtre à particules DPF pour 1464T

Fourni avec :

- capteur de 500 mbar
- adaptateur de 8 mm avec attache rapide et raccord en T
- câble RJ45 de 3 mètres



DONNÉES TECHNIQUES
test de pression : 0+500 mbar
résolution : 1 mbar

1464FAP CHF 255.00 1 014640610

240x210x50 mm - 0,5 kg

1464PT

Kit pour le contrôle de la pression du turbo à utiliser avec 1464T

Comprend capteur et câble de branchement



1464PT CHF 225.00 1 014640550

240x210x50 mm - 380 g

1464TDI

Kit pour le contrôle de la pression de la pompe à injection des moteurs TDI à utiliser avec 1464T

Comprend raccord de branchement



1464TDI CHF 161.00 1 014640600

240x210x50 mm - 400 g

1464VD

Kit pour contrôle dépression/vide pour 1464T

Permet de mesurer et mémoriser la valeur maximum de la dépression

Fourni avec :

- capteur de 800 mbar
- adaptateurs de 6 et 8 mm
- câble RJ45 de 3 mètres

DONNÉES TECHNIQUES
Test de vide : 0+800 mbar
Résolution : 1 mbar
Mémorisation de la valeur maximale



1464VD CHF 255.00 1 014640570

240x210x50 mm

 **Beta**

1464PF

Kit pour le contrôle de la pression dans le système de freinage
à utiliser avec 1464T
Comprend adaptateurs et raccords



1464PF CHF 923.00 1 014640650
400x280x60 mm - 3 kg

1465

Outil de contrôle de l'efficacité moteur

Permet de vérifier en quelques secondes la compression des moteurs endothermiques sans devoir se connecter au moteur en prélevant l'alimentation de la batterie du véhicule, au moyen d'un logiciel dédié



1ère phase : calcul tours/moteur
2ème phase : analyse situation tension batterie à chaque tour
3ème phase : affichage puissance électrique absorbée et compression correspondante calculée au moyen de l'action du démarreur pour chaque piston
4ème phase : contrôle état de chargement et efficacité de la batterie
DONNÉES TECHNIQUES
Tension de fonctionnement : 12V DC (batterie véhicule)
Dimensions : 140x75x30 mm
Longueur câble pinces : 1300 mm

1465 CHF 1,550.00 1 014650010

1466/C5

Jeu de 5 clés pour la purge des freins

Le jeu comprend :
• 5 clés de dimensions 7-8-9-10-11 mm
• 1 tuyau de purge avec clapet anti-retour



1466/C5 CHF 170.00 1 014660100
260x170x50 mm - 600 g

1466L 11

Clé 11 mm pour purge freins, version longue



1466L 11 CHF 42.00 1 014660211
11 mm L 60 mm

1466TLF

Bidon pour la collecte d'huile de freins capacité 1,5 litres

Attache rapide pour tuyau de purge Ø 5,5 mm



1466TLF CHF 60.50 1 014660201

1467

Purgeur de freins pneumatique par dépression



Pression min. 5 bar, max. 11,5 bar

1467 CHF 453.00 1 014670001

1467/RK1

Kit tuyau pour 1467



1467/RK1 CHF 34.00 1 014670501

1467/RK2

Flacon de remplissage pour 1467



1467/RK2 CHF 130.00 1 014670502

1467LF/2

purgeur de freins électronique

Avec "pulsation"



- Arrêt automatique lorsque le bidon est vide, ce qui évite l'introduction d'air
- Volume maximum bidon : 20 l
- Pression de service : 0,4-3,5 bars
- Alimentation : 230V

Équipement fourni :

- Bidon de collecte de l'huile des freins
- 1 bouchon E20 standard

1467LF/2 CHF 2,360.00 1 014670099

1467LF/RC

Bidon de collecte avec tuyau pour 1467LF



1467LF RC CHF 143.00 1 014670125

1467TU

Bouchon pour cuves
liquide freins

- Adaptable sur 90 % des cuves du parc
- Utilisable avec article Beta 1467LF



1467TU CHF 88.50 1 014670090

1467T/C6

Jeu de 6 bouchons d'adaptation pour
réservoirs de liquide de frein,
à utiliser avec les articles BETA 1467LF et
1467LF / 2

Contenu du set:

- 1 bouchon pour les véhicules Toyota
- 1 bouchon pour les véhicules Ford, Hyundai, Mazda, Mitsubishi, Nissan, Subaru
- 1 bouchon pour les véhicules Honda
- 1 bouchon pour les véhicules Mazda et Suzuki
- 1 bouchon pour les véhicules Nissan
- 1 bouchon adaptateur de purge des freins pour véhicules européens



1467T/C6 CHF 360.00 1 014670080

350x240x85 mm - 1,8 kg

1470

Pince pour garniture de frein



L mm	CHF	1	014700001
210	52.50	1	014700001
330	67.50	1	014700002
540	202.50	1	014700010

1470FT

Pince pour garniture de frein à tambour

Becs inclinés à 40°
Accessibilité dans les endroits difficiles



L mm CHF 56.00 1 014700000

1470PF

Outil pour le remplacement des cylindres
dans les freins à tambour

Les mâchoires restent ouvertes et le cylindre est facilement
remplacé.

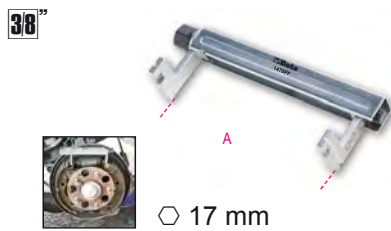

A mm CHF 101.50 1 014700200

1471

Pince pour garniture de frein



L mm CHF 103.00 1 014710001

1471A

Pince pour frein à main



A max mm B mm CHF 125.00 2 014710010

1471GF

Paire de crochets modelables pour le soutien
de la pince frein



Max kg CHF 19.00 1 014710310

Beta

1471M/C22

Outil pneumatique pour positionner les pistons
des freins à disque, avec tourne à gauche
et tourne à droite et accessoires



1471M/C22 CHF 404.00 1 014710101

350x310x85 mm - 3,5 kg

1471M/50

Coffret repousse-pistons pneumatique pour
positionner les pistons de freins à disque, avec
tourne à droite et tourne à gauche et
accessoires



Ø mm Kg Bar CHF 222.50 1 014710069

1471M/P

Adaptateur pour plaquettes usées et étriers
TRW-Mégane



1471M/P CHF 34.50 1 014710080

1471M/W50

Adaptateur pour frein de stationnement VW Passat ≥ 2005

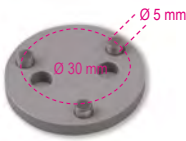

1471M/W50	CHF	12.20	1	014710079
-----------	-----	-------	---	-----------

1471PN/B1

Adaptateur pour frein de stationnement Ford

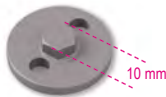

1471PN/B1	CHF	12.20	1	014710081
-----------	-----	-------	---	-----------

1471PN/B2

Adaptateur pour frein de stationnement Daily



1471PN/B2	CHF	16.90	1	014710082
-----------	-----	-------	---	-----------

1471PN/B3

Adaptateur pour frein de stationnement BMW



1471PN/B3	CHF	12.20	1	014710083
-----------	-----	-------	---	-----------

1471PN/B4

Adaptateur pour frein de stationnement BMW



1471PN/B4	CHF	12.20	1	014710084
-----------	-----	-------	---	-----------

1471PN/B5

Adaptateur pour frein de stationnement Mini/ BMW



1471PN/B5	CHF	10.50	1	014710085
-----------	-----	-------	---	-----------

1471CF

Douilles 5 pans pour écrous étriers de frein



mm	CHF			
14	23.80	1	014710314	
19	23.80	1	014710319	

1471CM

Douille mâle 5 pans pour vis étriers de frein



mm	CHF			
10	23.80	1	014710360	

1471CM/E11

Douille mâle 6 pans 11 mm pour vis des étriers de frein Mercedes ML (Série 166)



mm	Ø	L	L1	CHF			
11	24	75	15,5	25.00	1	014710361	

1471PT/C5

Kit douilles à chocs pour écrous d'étriers de frein

Pour les voitures du groupe Volkswagen, Audi et Porsche

- 3 douilles à 10 dents : 11,5 mm - 15 mm - 20 mm
- 2 douille à 7 dents: Ø 14 mm - 22 mm



1471PT/C5	CHF	96.50	1	014710367
-----------	-----	-------	---	-----------



1471D2

Outil pour le recul des pistons de freins à disque

avec pinces fermées

double couple de plaques pour travailler sur pinces à 2 et 4 pistons



mm	CHF			
10	104.00	1	014710301	

250x170x60 mm - 1,5 kg

1471T/C5

Jeu de 5 clés pour étriers de frein de camion

Peut être utilisé avec des clés dynamométriques pour les opérations de serrage tailles incluses:

- clés Torx femelles E18, E20, E24
- clés polygonales M24, M26



1471T/C5	CHF	335.00	1	014710400
----------	-----	--------	---	-----------

275x220x60 mm - 3,1 kg

1472

Pince pour colliers auto-serrants



1472	CHF	59.00	1	014720001
------	-----	-------	---	-----------

1472AU

Pince automatique pour colliers auto-serrants



mm	CHF			
18+53	172.50	1	014720100	

1472R/AU

Embout pour pince 1472AU



1472AU/R CHF 66.50 1 014720101

1472AU/P

Pince automatique à prise déportée pour colliers auto-serrants



∅ mm 18+54 L mm 630 CHF 152.00 1 014720105

1472AU/RP

Câble pour pince 1472AU/P



1472AUP/R CHF 37.00 1 014720106

1472B/RNLT

Douille à double tête, spécialement conçue pour les colliers de serrage d'aspiration installés sur les moteurs Renault



9 mm CHF 24.10 1 014720250

1472FC

Pince à têtes pivotantes, pour colliers CLIC(R)



1472FC CHF 54.50 1 014720090

1472FC/GE

Pince grande-amplitude pour colliers Clic (R)

Particulièrement indiquée pour les colliers de grandes dimensions



L mm 230 CHF 95.50 1 014720093

1472FC/L

Pince avec rallonge flexible, pour colliers Clic®



L mm 630 CHF 145.50 1 014720095

1472FCL/RP

Câble pour pince 1472FC/L



1472FCL/RP CHF 65.00 1 014720096

1472FCA

Pince pour démonter les colliers avec crémaillère type Visa®



1472FCA CHF 82.50 1 014720041

1472H

Outil pour démonter les colliers Henn



L mm 100 CHF 32.00 1 014720000

1472MT/VW

Paire d'agrafes de décrochage des collecteurs d'aspiration pour les moteurs du Groupe VAG

Utilisable sur moteurs turbo essence 1.0 - 1.2 - 1.4



1472MT/VW CHF 15.60 1 014720500

1472TM

Pince pour débrancher les raccords rapides des filtres Multijet



230 mm CHF 38.50 1 014720200

1472VW

Pince à têtes pivotantes, pour colliers auto-serrants Pour voitures Volkswagen et Mercedes



200 mm CHF 61.50 1 014720051

1473

Pince pour colliers OETIKER®



1473 275 CHF 170.00 1 014730001

1473A

Pince pour colliers OETIKER®



1473A CHF 129.00 1 014730010

1473P

Pince pour colliers OETIKER® pinçables à profil bas



1473P CHF 47.50 1 014730020

1473FN

Outil de serrage et coupe des colliers en acier inox

Utilisable avec colliers Panduit(R) et similaires



1473FN CHF 88.50 1 014730501

1473T

Pince coupante pour enlever les colliers de cardan en acier

Permet de couper les colliers sans risque d'endommagement du soufflet



1473T CHF 80.50 1 014730582

1474/C4

Kit 4 outils pour extraction bobines de bougies Volkswagen



1474/C4 CHF 134.50 1 014740100

290x190x50 mm - 1 kg

1474E/VW

Extracteur à expansion pour bobines de bougies groupe Volkswagen



1474E/VW CHF 37.00 1 014740120

1474E/VW2

Extracteur pour bobines de bougies groupe VAG

Utilisable sur moteurs 1.0 - 1.2 - 1.4 - 2.0



1474E/VW2 CHF 45.00 1 014740150

1474L

Pince pour connecteurs de bougies à becs long coudés à 15°

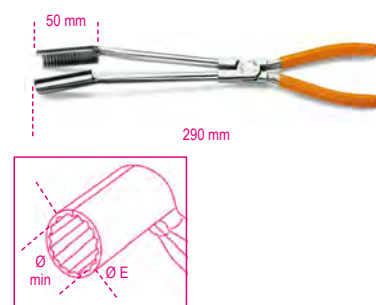

1474L CHF 108.50 2 014740010

1474DL

Pince pour connecteurs de bougies à becs long, branches gainées par 2 couches de PVC



1474DL CHF 52.00 1 014740015

1474G

Pince à becs longs coudés pour capuchons des bougies de préchauffage



1474G CHF 58.00 1 014740200

1475U

Pince universelle chromée polie avec prise type "pistolet", branches gainées par 2 couches de PVC



1475U CHF 54.50 1 014750010

1476

Pince-étau coupe-tubes d'échappement



225 mm

Ø min mm	Ø max mm	L mm	CHF		
19	75	225	104.00	1	014760002

1476/RC

Chaîne pour 1476



1476RC	CHF		
	51.50	1	014760012

1476A

Pince coupe-tubes d'échappement



230 mm

Ø min mm	Ø max mm	CHF		
30	95	132.50	1	014760005

1476A/RC

Chaîne pour 1476A



1476A/RC	CHF		
	114.00	1	014760015

1476C/1

Expandeur de tube d'échappement



1476C/1	CHF		
Ø 30=42 mm	50.00	1	014760101
L = 131 mm			
L1 = 51 mm			

1476GT

Pince pour l'extraction des supports en caoutchouc pour tubes d'échappement



L mm	A Max mm	\pm mm	CHF		
280	58	3	46.00	1	014760050

1476PSA

Pince coupe-tubes d'échappement avec pivot, groupe PSA

La forme des becs et le blocage automatique de la crémaillère permet d'intervenir sans ôter l'embout



L mm	A Max mm	S mm	CHF		
309	60	12,2	56.50	1	014760060

1476T

Clé pour démontage/montage turbines sur moteurs Diesel, groupe Volkswagen Audi



105 mm

Ø mm	CHF		
12	51.50	1	014760200

1477/C10

Clé coudée avec 9 embouts pour écrous tendeur de courroie

1 clé coudée avec entraînements pour embouts
4 embout 12 pans doubles : 12x14 - 13x15 - 16x17 - 18x19 mm
5 embouts pour vis Torx® : E10 - E12 - E14 - E16 - E18



1477/C10	CHF		
	218.00	1	014770310
530x110x55 mm			

1477D

Clés 12 pans pour écrous tendeurs de courroie



555 mm

Ø mm	CHF		
13	39.00	1	014770113
15	39.00	1	014770115
16	39.00	1	014770116
17	39.00	1	014770117
19	39.00	1	014770119

1477D/S5

Jeu de 5 clés 12 pans pour écrous tendeurs de courroie



1477D/S5	CHF		
13-15-16-17-19 mm	195.50	1	014770200
600x200x70 mm - 2,2 kg			

1477K/7

Kit clé à cliquet coudée réversible avec embouts



- 2 embouts TORX T40-T45
- 1 embout XZN 10
- 1 embout 6 pans 8 mm
- 3 embout 12 pans 10-12-13 mm

1477K/7	L mm	CHF		
	250	191.00	1	014770051

1478

Pince d'extraction de clips



265 mm

1478	CHF		
	75.50	1	014780001

1478NSS

Pince pour clips plastique avec 3 points de déblocage



L mm 180 CHF 54.50 1 014780163

1478T

Pince à tête pivotante pour clips en plastique avec clips à pression

Tête pivotante à 90°



S mm 4,5 CHF 59.00 1 014780101

1478/K3

Lot de pinces pour clips avec assortiment de clips plastique

Le kit comprend :

- 1 pince à becs droits
- 1 pince à becs coudés à 90°
- 625 clips en plastique de 16 tailles différentes
- clips contenus dans 3 boîtes en PPL empilables



L mm 180 L1 mm 170 CHF 137.00 1 014780160

1478SP

Assortiment de 625 clips en plastique

16 modèles différents



CHF 33.00 1 014780201

1479

Spatule d'extraction de clips

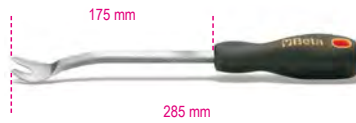

1479 CHF 33.50 2 014790001

1479/B27

Kit de 27 outils en nylon pour le démontage des plastiques intérieurs. Aucun endommagement des éléments au démontage. Dans un sac pouvant être suspendu



1479/B27 CHF 104.00 1 014790407

1479LB/C5

Kit de 5 spatules d'extraction de clips en métal



1479LB/C5 CHF 142.00 1 014790150

215x165x50 mm

1479L/S2

Paire de leviers multifonctions en Teflon®



1479L/S2 CHF 47.50 1 014790510

1479LV/S3

Kit de 3 leviers multifonctions en métal

Mesures :

- 1479LV/1 : 10x12 mm
- 1479LV/2 : 4,8x9,6 mm
- 1479LV/3 : 2,8x6 mm



1479LV/S3 CHF 40.50 1 014790100

1479L/K4

Kit de 4 spatules pour le démontage du tableaux de bord et des pièces délicates



1479L/K4 CHF 45.00 1 014790604

1479ML/B17

Kit de 17 leviers multifonctions en matière plastique

Particulièrement indiqués pour les travaux de précision



1479ML/B17 CHF 85.50 1 014790700

1479ML/S3

Kit de 3 leviers multifonctions en matière plastique

Particulièrement indiqués pour les travaux de précision



1479ML/S3 CHF 14.60 1 014790603

1479N/S5

Kit de 5 spatules d'extraction de clips pour carrossiers en nylon



1479N/S5 CHF 54.00 1 014790251

1479RB/1

Grattoir à ébarber droit



1479RB/1 CHF 37.00 1 014790315

1479RB/2

Grattoir à ébarber coudé



1479RB/2 CHF 37.00 1 014790320

1479RB/3

Grattoir à ébarber plat



1479RB/3 CHF 42.00 1 014790310

1479U/13

Spatule d'extraction de clips pour carrossiers en acier inoxydable



1479U/13 CHF 34.00 2 014790010

1479U/32

Spatule d'extraction de clips pour carrossiers en acier inoxydable



1479U/32 CHF 40.50 2 014790015

1480

Kit de remplissage pour filtres gazoil pour voiture sans pompe électrique
• Utilisable également avec pistolet de gonflage des pneumatiques

- Le kit comprend :
- attaches rapides GM
 - attaches rapides Renault, GM, Fiat Ø interne 6 mm
 - attaches rapides Renault, GM, Fiat Ø interne 7 mm
 - attaches rapides Ford
 - attaches rapides PSA Ø interne 6 mm
 - attaches rapides PSA Ø interne 7 mm
 - attaches



1480 CHF 506.00 1 014800010

410x320x70 mm

1481/C12

Kit de 6 paires de pinces à durites

- 2 différentes paires de pinces dimensions 1/4"
- 2 différentes paires de pinces dimensions 3/8"
- 2 différentes paires de pinces dimensions 5/16"
- 3 paires de bouchons en caoutchouc



1481/C12 CHF 160.00 1 014810312

370x270x59 mm

1481K/S4

Kit de 4 presses auto-serrantes pour occlusion lignes

Mesures : 5/16" - 3/8" - 1/2" et passant



1481K/S4 CHF 40.50 1 014810400

1481PL/A

Pince à durites

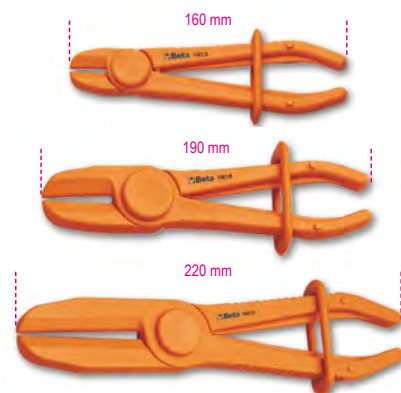

Ø mm	CHF		
1481PL/A 8÷15	27.50	3	014810110
1481PL/B 15÷25	30.50	3	014810120
1481PL/C 25÷45	41.50	3	014810130

1481PL/S3

Jeu de 3 pinces à durites



1481PL/S3 CHF 100.00 1 014810200

1481PL-A Ø 8÷15 mm
1481PL-B Ø 15÷25 mm
1481PL-C Ø 25÷45 mm



1481T/C12

Ensemble de bouchons pour conduite de carburant

3 paires de fiches avec raccords rapides mâle / femelle pour fermer les conduites de carburant



1481T/C12	CHF 165.50	1	014810212
275x220x45 mm - 540 g			

1482

Clé réglable autoserrante pour bouchon de trappe de réservoirs



Ø mm	CHF		
89÷170	149.00	1	014820001
89÷200	155.50	1	014820002

1482A/1

Clé à 3 pattes pour bouchon de trappe de réservoir avec bouchon en aluminium

Pour agir sur le bouchon en aluminium monté depuis 2011 sur les automobiles des groupes Fiat, Volkswagen, Opel, Chevrolet, Mercedes et BMW



Ø mm	CHF		
185	103.00	1	014820005

1482A/3

Clé pour bouchons de trappe de réservoir groupe PSA

Le dessin permet d'intervenir sur l'axe décentré en enlevant le bouchon, sans endommager le délicat flotteur



Ø mm	CHF		
157	117.00	1	014820007

1482A/5

Clé pour bouchons de trappe de réservoir à 22 secteurs

Pour agir sur le bouchon en plastique monté sur les automobiles du group VAG

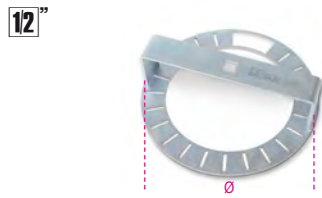

Ø mm	CHF		
180	90.00	1	014820015

1482/8 - 1482/10

Pince pour raccords d'essence Renault



Ø mm	CHF		
1482/8	51.50	2	014820008
1482/10	51.50	2	014820010

1482B

Pince pour raccords d'essence



1482B	CHF 61.50	1	014820021
-------	-----------	---	-----------

1482SN

Pince pivotante à mâchoires articulées pour les raccords rapides des conduites de carburant



L mm	CHF		
260	78.50	1	014820110

1482C

2 couples de coins pur décrochage raccords filtres gasoil groupes Fiat, Volkswagen, Jeep, Chrysler et Volvo

Remplacement rapide du filtre sans endommager irrémédiablement les raccords



1482C	CHF 82.00	1	014820022
-------	-----------	---	-----------

1482D

Pince avec rallonge flexible pour raccords rapides tuyaux carburant



1482D	CHF 112.00	1	014820026
-------	------------	---	-----------

1483K/12

Kit de démontage des soupapes installation de climatisation avec séries d'embouts à cinq pointes

Compris dans le kit :
 • 2 douilles femelles 8 pans Ø 12 et 15 mm pour soupapes haute pression
 • 2 douilles mâles à cliquet section 2,2 et 3,2 mm pour soupapes papillon
 • 1 série d'embouts à cinq pointes taille : PT10, PT15, PT20, PT25, PT27, PT30, PT40



1483K/12	CHF 54.00	1	014830012
120x80x35 mm			

1483KV-PT/S7

Jeu d'embouts à cinq pointes

Mesures comprises : PT10 - PT15 - PT20 - PT25 - PT27 - PT30 - PT40



1483KV PT/S7	CHF 16.40	1	014830117
--------------	-----------	---	-----------

1483K/22

Kit pour la séparation des raccords sur installations de climatisation, alimentation et lubrification



CHF
1483K/22 185.50 1 014830022
300x230x55 mm - 1 kg

1484

Jeu de 2 outils pour la dépose et le montage des courroies élastiques
Facilite la dépose et assure un montage correct de la courroie élastique sans risque d'endommagement



CHF
1484 164.50 1 014840010

1484PSA

Outil pour le montage de la courroie élastique de la pompe d'eau sans tendeurs de courroie

Utilisable pour groupe PSA et Opel moteurs 1.0 - 1.2



CHF
1484PSA 21.50 1 014840012

1485BP

Outil en demi-lune pour bloquer les poulies d'arbre à cames

Manche réglable, serre et bloque la poulie de l'extérieur en évitant les dommages aux capteurs environnants



CHF
A Max mm 130
1485BP 293.00 1 014850000

1485BPM

Outil en demi-lune avec mâchoires en aluminium pour blocages des poulies multi-gorges

Réglable par le manche rotatif, serre et bloque la poulie de l'extérieur, évitant ainsi les dommages des capteurs environnants



CHF
A Max mm 180
1485BPM 252.00 1 014850002

1485FCA/K2

Paire d'outils pour la précharge des galets tendeurs de distributions du groupe FCA

Indiqués pour moteurs 1.2, 1.4 8/16 V et 1.4 Multiair

- 1 outil longueur 175 mm avec embouts de 13,5 mm
- 1 outil longueur 305 mm articulé avec embouts de 13,5 mm



CHF
1485FCA/K2 134.00 1 014850220

1485FCA/T

Outil tendeur long pour roulements distribution avec embouts de 13,5 mm



CHF
L mm P mm 175 13,3
1485FCA/T 48.50 1 014850210

1485FCA/TS

Tendeur articulé pour roulements distribution avec embouts de 13,5 mm



CHF
L mm P mm 305 13,5
1485FCA/TS 85.50 1 014850215

1485FRD/T

Levier pour la dépose des courroies d'accessoire montées sur moteurs Ford
Utilisable pour le retrait des poulies des alternateurs



CHF
L mm Q mm 450 12,80
1485FRD/T 104.00 1 014850310

1485MRC/T

Levier pour la dépose des courroies d'accessoires, montées sur moteurs Mercedes
Utilisable pour moteurs M133 - M270

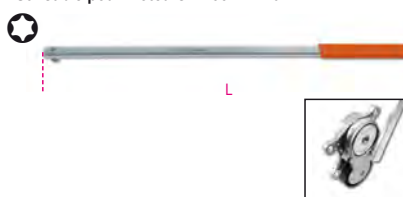

CHF
L mm O mm 510 T55
1485MRC/T 42.50 1 014850315

1485VLV/T

Levier pour la dépose des courroies accessoire, montées sur moteurs Volvo

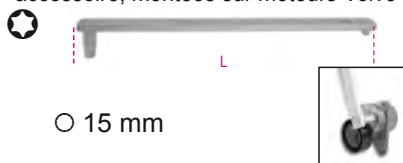

CHF
L mm O mm 420 T50-T60 15
1485VLV/T 88.00 1 014850320

1485TC

Levier pour la dépose des courroies d'accessoire, montées sur moteurs Ford, PSA, FCA

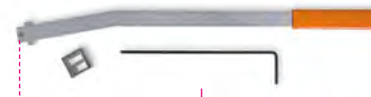

CHF
L mm 475
1485TC 64.00 1 014850330

1485/KIT

Kit de tensiomètres de courroie de distribution



CHF
1485/KIT 237.50 1 014850100
230x140x75 mm - 580 g

1485MJ

Outil de blocage de l'arbre à came des moteurs 1.3 16V Multijet

2 têtes avec 3 profils pour intervenir sur tous les moteurs 1.3 16V Multijet
montés par le groupe FCA, Opel, Ford et Suzuki

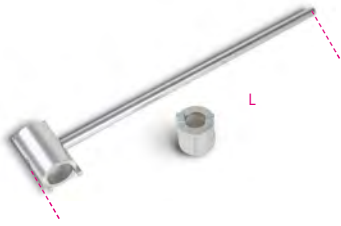

1485MJ	L mm 500	CHF 164.50	1	014850150
--------	----------------	---------------	---	-----------

1485PMTJ

Levier d'immobilisation pour les poulies d'arbre à came des moteurs Multijet
Géométrie expressément étudiée pour bloquer l'arbre moteur pendant les opérations de retrait de la poulie



1485PMTJ	L mm 450	CHF 171.00	1	014850190
----------	----------------	---------------	---	-----------

1485R

Outil pour la rotation de poulies de distribution en acier forgé
fourni avec 2 paires d'embouts



1485R	Ø mm 30÷120	Ø1 mm 10 - 17	L mm 500	CHF 204.50	1	014850025
-------	-------------------	---------------------	----------------	---------------	---	-----------

1485R/P10

Paire d'embouts



1485R/P10	CHF 22.00	1	014850035
-----------	--------------	---	-----------

1485R/P17

Paire d'embouts



1485R/P17	CHF 22.00	1	014850038
-----------	--------------	---	-----------

1485VAG/K2

Clés pour précharger les galets-tendeurs de distribution

- Tête orientable en 3 positions
- 1 outil avec tête profonde 12,5 mm
- 1 outil avec tête profonde 21,5 mm



1485VAG/K2	CHF 101.50	1	014850080
------------	---------------	---	-----------

1485VAG

Clé pour précharger les galets-tendeurs de distribution

- Tête orientable en 3 positions



1485VAG/12,5	L mm 190	P mm 12,5	CHF 50.00	1	014850062
1485VAG/21,5	L mm 195	P mm 21,5	CHF 51.50	1	014850071

1487/K2

Jeu de 2 prises pour bouchons de vidange de radiateur



1487/K2	CHF 36.50	1	014870100
---------	--------------	---	-----------

1488 - 1488L

Clé à chaîne pour filtres à huile



1488	Ø mm 60÷110	CHF 121.50	1	014880001
1488L	Ø mm 60÷160	CHF 133.50	1	014880050

1488/1

Clé à chaîne pour filtres à huile



1488/1	Ø mm 60÷110	CHF 140.50	1	014880010
--------	-------------------	---------------	---	-----------

1488R...

Chaîne de rechange



1488RC	1488	350	CHF 50.00	1	014880101
1488R/L	1488/L	520	CHF 80.50	1	014880150
1488RC/1	1488/1		CHF 69.50	1	014880110

1489/31T

Clé pour les poulies libres des alternateurs



1489/31T	CHF 51.50	1	014890016
----------	--------------	---	-----------

1489/33

Clé pour le remplacement des poulies d'alternateur



1489/33	CHF 21.80	1	014890010
---------	--------------	---	-----------

1489/33P

Clé pour le remplacement de la poulie
nouvel alternateur Bosch
FIAT Grande Punto



M	mm	mm	CHF		
10	15	31	65.00	1	014890015

1489/E

Clé pour les poulies libres des alternateurs



mm	mm	CHF		
10	15	44.00	1	014890025

1489R

Clé pour le remplacement des poulies
d'alternateur

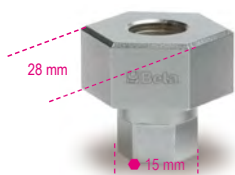

CHF			
21.80	1	014890020	

1489/Y

Clé pour le remplacement des poulies
alternateurs Nippondenso



mm	CHF		
32	25.00	1	014890040



1489/C14

Composition de 14 outils pour les poulies
libres des alternateurs



1489/C14	CHF		
	389.00	1	014890100

- 867PE 8 mm
- 867PE/L 8 mm
- 867XZN/L M10
- 867TX/L T50
- 867/2 □1/2"
- 920B 10 mm
- 1489/33
- 1489/33P M10
- 1489R
- 1489/Y
- 1489/31T T50
- 1489/E 10 mm
- 188 10 mm
- 188 15 mm

420x250x45 mm - 1,9 kg

1490

Clé à sangle pour filtres à huile

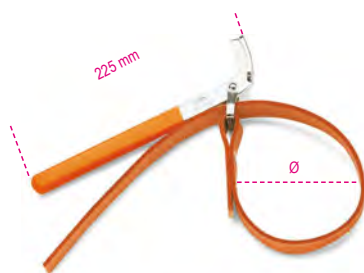

	Ø max mm	CHF		
1490/1	160	48.50	1	014900001
1490/2	240	52.00	1	014900002

1490/R1 - 1490/R2

Sangle en tissu pour 1490



	Ø mm	CHF		
1490R/1	160	23.60	1	014900101
1490R/2	240	28.50	1	014900102

1490F

Clé à sangle pour filtres



Ø Max mm	CHF		
200 50	35.50	1	014900201

1491

Clé à sangle pour filtres à huile



Ø mm	CHF		
65÷110	62.50	2	014910001

1491R

Sangle pour 1491



1491R	CHF		
	11.50	10	014910010

1491A

Pince réglable pour filtres à huile

Réglage de précision par crémaillère



L	Ø min - Max mm	CHF		
345	55 ÷ 140	42.50	1	014910040

1491T

Pince réglable pour filtres à huile des poids
lourds

Réglage de précision par crémaillère
Utilisable pour filtres dessiccateurs



L	Ø min - Max mm	CHF		
500	70÷200	100.00	1	014910050

1492/1 - 1492/2

Clé réglable pour filtres à huile

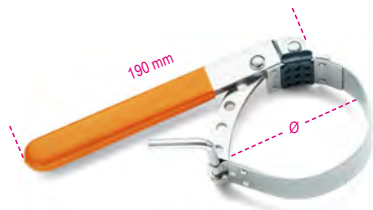

	Ø mm	CHF		
1492/1	60÷80	59.50	1	014920001
1492/2	80÷110	62.00	1	014920002

1492T

Clé pour filtres sécheurs



	Ø mm	H mm	CHF		
1492T 40	125÷145	40	46.00	1	014920540
1492T 75	120÷140	75	80.50	1	014920575

1493B

Clé polygonale pour cartouches des filtres à huile difficiles d'accès



mm	±0.5 mm	CHF		
24	8	26.00	1	014930524
27	8	27.00	1	014930527
32	8	27.50	1	014930532
36	8	29.50	1	014930536
38	8	30.00	1	014930538

1493B/S5

Jeu de 5 clés polygonales pour cartouches des filtres à huile difficiles d'accès

Dimensions : 24-27-32-36-38 mm



	CHF		
1493B/S5	106.50	1	014930599

1493

Clé pour filtres à huile



Ø mm	N	CHF		
65	14	14.60	1	014930200
73	14	14.60	1	014930208
74	14	14.60	1	014930209
74	15	14.60	1	014930210
76	14	14.60	1	014930218
76-74	15	15.90	1	014930220
78	15	15.90	1	014930224
80	15	16.30	1	014930226
82-80	15	16.30	1	014930228
86	16	17.20	1	014930230
90	15	17.20	1	014930234
92	10	17.20	1	014930236
93	15	17.20	1	014930238
100	15	19.60	1	014930248
106	15	20.30	1	014930250
108	15	20.30	1	014930252
135	18	33.00	1	014930256

1493/PF

Clé pour filtres à huile spéciale Purflux®



Ø mm	N	CHF		
66	6	14.60	1	014930202
76	12	14.60	1	014930216
76	30	15.90	1	014930222
86	18	17.20	1	014930232
93	36	17.20	1	014930240
93	45	17.20	1	014930242
96	18	17.20	1	014930246
108	18	22.00	1	014930254



1493/C30

Jeu de 28 clés pour filtres à huile



Mesures incluses dans le kit (Ø mm / n° de côtes)
1493:
65/14 - 67/14 - 68/14 - 73/14 - 74/15
76/15 - 75.77/15 - 76/14 - 76/8 - 78/15 - 80/15
82/15 - 86/16 - 90/15 - 92/10 - 93/15 - 95/15
100/15 - 106/15 - 108/15

1493PF (Purflux)
66/6 - 76/12 - 76/30 - 86/18
93/36 - 93/45 - 96/18 - 108/18

- Avec 1 clé réglable universelle
Ø 65÷120 mm

	CHF		
1493/C30	355.00	1	014930000

530x400x110 mm - 4 kg

1493AL

Clé pour filtres à huile

N = N côtés

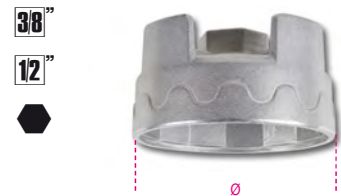

Ø mm	N	●	□	CHF		
64	14	27	1/2"	22.00	1	014930310
66,5	14	27	1/2"	19.60	1	014930315
74	14	27	1/2"	23.80	1	014930320
79	15	27	3/8"	22.00	1	014930325
84	14	27	3/8"	23.80	1	014930330
87	16	27	1/2"	29.50	1	014930335
92	15	27	3/8"	23.80	1	014930340
100,5	15	27	3/8"	23.80	1	014930350

1493AL 4S

Clé pour filtres à huile pour les automobiles asiatiques Profil à 4 ergots

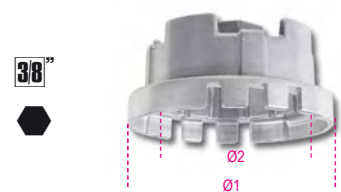

Ø1 mm	Ø2 mm	CHF		
70	64,5	27	23.80	1 014930304
80	64,5	27	22.00	1 014930305

1493AL CF

Douille 6 pans pour cartouches filtrantes d'huile



Ø mm	H mm	●	CHF	📦	🖨️
24	34	27	14.10	1	014930424
30	34	27	14.10	1	014930430
32,5	34	27	14.60	1	014930432
36	34	27	14.60	1	014930436
38	34	27	14.60	1	014930438

1493/C19

Jeu de 18 clés pour filtres à huile. Particulièrement indiquées pour les automobiles asiatiques

Ø mm	N côtés
63-64	14
66,5	14
74	14
79	15
84	14
87	16
92	15
94,5	15
100,5	15
64,5	14 à ergot pour Toyota
64,5	14 à ergot pour Lexus

6 douilles 6 pans taille 24-27-30-32,5-36-38 mm pour cartouches filtrantes
Le kit comprend 1 clé universelle réglable Ø 58+93 mm



1493/C19	CHF	📦	🖨️
	310.00	1	014930019

490x450x60 mm - 4 kg

1493DSG

Clé pour démontage/montage filtre à huile boîte de vitesse DSG



Ø mm	CHF	📦	🖨️
24	49.00	1	014930800

1493FF

Clé pour démontage/montage de la pièce en plastique des filtres à huile Ford Peugeot Citroën moteurs : TDCi-HDi

Permet de serrer correctement la pièce en plastique avec clés dynamométriques à 25 Nm



Ø mm	CHF	📦	🖨️
27	40.50	1	014930127

1493FT

Clé pour filtres gasoil Ford Transit

Utilisable sur toutes les versions Transit, Transit Custom et Tourneo Custom depuis 2012

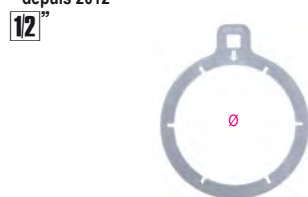

Ø mm	CHF	📦	🖨️
115	34.00	1	014930085

1493J

Clé pour filtres diesel Multijet

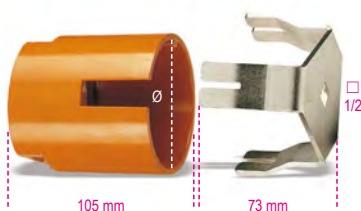

Ø mm	CHF	📦	🖨️
90	155.50	1	014930080

1493VW

Clé pour filtres diesel groupes VAG et Volvo



Ø mm	CHF	📦	🖨️
82,5	22.70	1	014930086

1493HK

Clé de filtre à huile diesel pentadécagonale pour Hyundai Kia



1493HK	CHF	📦	🖨️
	36.50	1	014930087

1493/C7

Clé autoréglable à trois bras pour filtres à huile, serrage à droite-gauche, avec bras interchangeables

Finition diamantée antiglisse

- 2 séries de bras :
- 1 série avec longueur utile 20 mm
- 1 série avec longueur utile 38 mm



1493/C7	Ø mm	Ø mm	CHF	📦	🖨️
	50+100	16	150.50	1	014930079

210x150x50 mm

1493H

Clé autoréglable à trois bras pour filtres à huile, serrages à droite-gauche

Griffes moletées

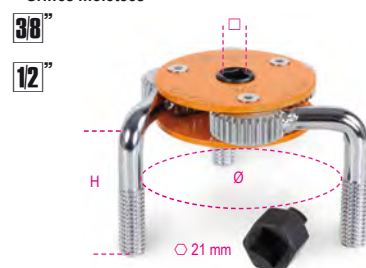

1493H	Ø mm	H mm	CHF	📦	🖨️
	72+127	62	37.00	1	014930077



1493/S-U

Clé auto-serrante à 3 bras pour filtres à huile (serrages et desserrages)



	□	∅ mm	CHF	🛠️	📄
1493/S	3/8-1/2	80-115	113.00	1	014930074
1493/U	1/2	105-165	246.50	1	014930076

1493X

Clé auto-serrante pour filtres à huile, serrages à gauche



	∅ mm	± mm	CHF	🛠️	📄
1493X/1	60÷80	2,9	42.50	1	014930105
1493X/2	80÷98	2,9	42.50	1	014930110

1493Y

Clé auto-serrante pour filtres à huile, serrages à droite et gauche, pour poids-lourds.

L'article 1493Y/2 est utilisable également pour les filtres sécheurs



	∅ mm	± mm	CHF	🛠️	📄
1493Y/1	80÷110	7,3	145.50	1	014930120
1493Y/2	104÷145	7,3	222.50	1	014930122

1493C/ADB

Douille pour ouvrir les bouchons AdBlue®, des véhicules du groupe PSA



	CHF	🛠️	📄
1493C/ADB	22.20	1	014930900

1493U/ADB

Clé pour ouvrir les bouchons de vidange AdBlue®



	CHF	🛠️	📄
1493U/ADB	16.00	1	014930910

1494T/C5

Jeu de 4 douilles spéciales pour bouchons de vidange d'huile en plastique + 1 clé en "T"

- Contenu du set:
- 1 douille pour bouchons de vidange d'huile groupe VAG
 - 1 douille pour bouchons de vidange d'huile BMW
 - 1 douille pour bouchons de vidange d'huile PSA et groupe Ford
 - 1 douille pour bouchons de vidange d'huile Mercedes
 - 1 clé à poignée en "T"



	CHF	🛠️	📄
1494T/C5	96.50	1	014940350

173x125x50 mm - 360 g

1494BMW

Clé spéciale pour bouchons à huile en plastique moteurs BMW



	CHF	🛠️	📄
1494BMW	18.70	1	014940315

1494FPC

Clé spéciale pour bouchons à huile en plastique moteurs Ford, Peugeot, Citroën



	CHF	🛠️	📄
1494FPC	21.20	1	014940320

1494VW

Clé spéciale pour bouchons à huile en plastique moteurs groupe Volkswagen

Permet d'ôter et d'installer le bouchon en plastique de la cuve à huile. Spécifique pour les automobiles du groupe Volkswagen avec moteurs TFSI et TDI



	CHF	🛠️	📄
1494VW	29.50	1	014940305

1494MRC

Douille spéciale pour les bouchons de vidange d'huile en plastique, spécifique moteurs Mercedes



	CHF	🛠️	📄
1494MRC	20.60	1	014940325

1494MAN

Douille spéciale pour les bouchons de vidange d'huile en plastique, spécifique moteurs DAF et MAN



	CHF	🛠️	📄
1494MAN	20.60	1	014940330

1494

Douille carrée pour bouchons de vidange moteur

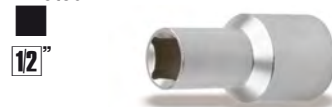

mm	CHF	🛠️	📄
10	12.30	1	014940280

1494E

Douille mâle 6 pans pour bouchons de vidange moteur



mm	CHF	🛠️	📄
8	12.30	1	014940208
9	12.30	1	014940209
10	12.30	1	014940210
11	12.30	1	014940211
12	12.30	1	014940212
14	12.30	1	014940214
17	12.30	1	014940217



1494Q

Douille mâle carrée pour bouchons de vidange moteur

12"



mm	CHF		
8	12.30	1	014940258
9,5	12.30	1	014940259
12	12.30	1	014940262
13	12.30	1	014940263

1494T

Douille mâle triangulaire pour bouchons de vidange moteur

12"



mm	CHF		
9,5	12.30	1	014940289

1494XZN

Douille mâle bouchons pour vidange moteur XZN®

12"



M	CHF		
16	14.60	1	014940296

1494VW/K

Kit pour le remplacement de l'huile des moteurs du Groupe VAG



Le kit comprend :

- 1 clé spéciale pour bouchons en plastique
- 6 bouchons en plastique pour coupe

1494VW/K	CHF		
	38.50	1	014940310

1494VW/KT

Kit de 6 bouchons plastiques pour 1494VW/K



1494VW/KT	CHF		
	33.50	1	014940311

1494/C14A

Composition de 14 outils pour vidange

12"



1494/C14A	CHF		
	175.00	1	014940150

- 1494E 8-9-10-11-12-14-17
- 1494Q 8-9,5(3/8")-12-13
- 1494 10
- △ 1494T 9,5(3/8")
- 1494XZN M16

380x305x40 mm - 1,7 kg

1494M

Outil pour bouchons à huile hexagonaux magnétique et flexible

Permet de dévisser le bouchon sans risques de brûlure et sans salissures



L mm	F kg	Ø mm	CHF		
293	2,5	19	31.50	1	014940401

1495/C6

Composition d'outils pour la réparation des filetages du carter d'huile



• Le filet endommagé est éliminé par le foret taraudeur et élargi d'une mesure
• Répare le carter d'huile et évite ainsi de le remplacer
Contenu:

- 1 taraud mâle M13x1.25 + 6 vis + 12 rondelles
- 1 taraud mâle M13x1.5 + 6 vis + 12 rondelles
- 1 taraud mâle M15x1.5 + 6 vis + 12 rondelles
- 1 taraud mâle M17x1.5 + 6 vis + 12 rondelles
- 1 taraud mâle M20x1.5 + 6 vis + 12 rondelles
- 1 taraud mâle M22x1.5 + 6 vis + 12 rondelles

1495/C6	CHF		
	379.00	1	014950500

420x185x60 mm - 2,1 kg

1495M

Taraud mâle pour filetages bouchons d'huile



M	CHF		
13x1,25	22.80	1	014950553
13x1,50	18.70	1	014950563
15x1,50	20.30	1	014950565
17x1,50	22.80	1	014950567
20x1,50	25.00	1	014950570
22x1,50	33.00	1	014950572

1495T

Kit de 6 bouchons d'huile et rondelles



M	CHF		
13x1,25	26.50	1	014950503
13x1,50	26.50	1	014950513
15x1,50	26.50	1	014950515
17x1,50	29.50	1	014950517
20x1,50	33.50	1	014950520
22x1,50	43.50	1	014950522

1496/C

Clé de vidange



■ 8 x ■ 10 mm	CHF		
	29.00	3	014960010

1497D

Pince à becs droits pour extraction relais



A min+Max mm	CHF		
15÷50	44.00	1	014970150

1497BS

Pince à becs droits et fins pour extraction relais et fusibles

Les becs longs et très fins permettent le prélèvement du relais et du fusible dans les espaces limités.



L	L1	A	CHF		
mm	mm	min	30.50	1	014970190
230	45	14			

1497P

Pince à becs coudés à 60° pour extraction relais



1497P	A	CHF		
	min+Max	45.00	1	014970160
	mm			
	15÷50			

1497SS

Pince-étau pour le soudage de fils d'étain

Les clips supérieurs permettent de bloquer et rapprocher les fils à souder. La crémaillère intégrée permet de positionner les fils de six manières différentes.



L	A	CHF		
mm	min+Max	27.50	1	014970195
245	mm			
	14÷70			

1497TE

Pince pour déconnecter les connecteurs électriques

Le nez extrêmement fin permet de libérer les clips sans endommager les connecteurs



1497TE	L	A	Ø	CHF	
	mm	Max	mm	31.50	1
	215	63	4		014970180

1497/C23

Composition de 23 outils pour déblocage des connecteurs électriques



1497/C23	CHF		
	296.00	1	014970200

440x250x70 mm - 1,7 kg

1497/C94

Assortiment de 94 connecteurs pour test sur automobiles utilisables avec les principaux instruments de diagnostic

- 2 aiguilles de prise de tension
- 2 potentiomètres
- 2 voyants d'avertissement
- 2 connecteurs SRS
- 2 pinces crocodile
- 2 sondes à aiguilles
- 2 embouts
- 2 fiches banane 2 en 1
- 4 fiches banane 1 en 1
- 24 embouts mâle plats 0.6÷6 mm
- 12 embouts mâle ronds 1.6÷3.9 mm
- 24 embouts femelle plats 0.6÷6 mm
- 12 embouts femelle ronds 1.6÷3.9 mm



1497/C94	CHF		
	522.00	1	014970300

430x390x100 mm - 3 kg

1497RC

Paire de pique-fils pour prise de tension

- section câbles : 1,5÷3,5 mm
- voltage : 0÷330V
- courant maximum : 5A



1497RC	CHF		
	99.00	1	014970351

1497KB/S3

Kit de 3 outils pour élimination connecteurs électriques Knorr et Bremse

- 1 outil pour connecteurs à baïonnette
- 1 outil avec empreinte pour connecteurs à 2 pôles
- 1 outil avec double empreinte pour connecteurs à 4 ou 6 pôles et 12 pôles



1497KB/S3	CHF		
	109.00	1	014970050

1497/S3

Jeu de 3 câbles pour lectures signaux électriques

- 1 pce droite
- 1 pce 45°
- 1 pce 90°



1497/S3	CHF		
	24.60	1	014970400

1498

Testeur de tension

CE

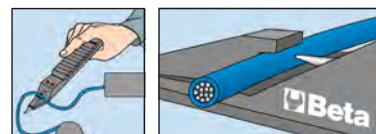

3÷48V	CHF		
	65.50	2	014980100



REPARATION DE VEHICULES

Nos outils de réparation de véhicules qui sont utilisés par les professionnels les plus exigeants, sont développés et fabriqués pour répondre aux normes les plus élevées du monde, et régulièrement testés dans les conditions de fonctionnement les plus difficiles.

Depuis plus de 50 ans, nous travaillons fièrement et en collaboration les plus grands champions des sport mécaniques, nous aidant à améliorer continuellement nos produits et témoignant du niveau de qualité PREMIUM.

Les outils de réparations de véhicules se trouvent dans les sections:

Diagnostique	articles 1438 to 1499 articles 1758VT to 1760TMC
Moteur	articles 955 to 989A articles 1438 to 1499
Vidange	articles 1438 to 1499 articles 1877 to 1885
Système électrique	articles 1438 to 1499
Boosters de démarrage	articles 1498BC/12 to 1498/40A
Transmission	articles 1438 to 1499
Suspension	articles 1549 to 1569CP
Freins	articles 1438 to 1499
Roues	articles 955 to 989A
Carrosserie	articles 1302 to 1369 articles 1763 to 1767A
Autres équipements	articles 1875LT to 3067
Levage	articles 3029/2T to 3067/70-13T



1498BC/12

Booster de démarrage portable multifonction 12V

Données techniques :

- courant de démarrage : 600A
- courant de décollage : 1500A
- type de batterie : 4 cellules LifePo4
- capacité de la batterie : 2500mAh
- Dispositif de protection contre l'inversion de polarité, court-circuit, surintensité, surcharge et surtension thermique



Équipement :

- Étui de protection
- Câble avec pince de démarrage
- Sorties USB pour charger des appareils électroniques
- Indicateur LED de charge de la batterie
- Câble USB et USB-C
- Alimentation secteur
- Torche LED multifonction

	L	P	H	CHF		
	mm	mm	mm	434.00	1	014980040

1498MN/12-C

Câble de démarrage avec pinces pour 1498BC/12



	CHF		
1498MN/12-C	77.50	1	014980005

1498MN/12-R

Alimentation secteur mini booster de démarrage 1498BC/12



	CHF		
1498MN/12-R	57.00	1	014980003

1498MN/12-P

Alimentateur prise auto mini booster de démarrage 1498BC/12



	CHF		
1498MN/12-P	34.50	1	014980004

1498MN/12-U

Câble USB avec adaptateur universel U



	CHF		
1498MN/12-U	25.00	1	014980009

1498LT/12

Booster de démarrage portatif ultra léger hautes performances



Le microprocesseur permet une protection complète contre :

- inversion de polarité
- court-circuit
- voltage erroné
- surcharge
- sous-charge
- sur-décharge
- échauffement

DONNÉES TECHNIQUES

Tension d'utilisation : 12 V
Ampérage continu : 800 A
Ampérage maximum de mise en marche : 2000 A
Ampérage de pic : 4000 A
Longueur câbles : 500 mm
Type batterie : 4 cellules LifePo4
Fonction sauve-mémoire : SI
Dimensions : 260 x 135 x 72 mm
Poids net : 2,5 kg
Doté d'alimentateur de recharge 12 V 1,3A

	CHF		
1498LT/12	1,105.00	1	014980012

1498LT/12-SF

Étrier de fixation mural pour booster de démarrage 1498LT/12



	CHF		
1498LT/12-SF	183.50	1	014980013

1498LT/12-R7

Chargeur secteur pour booster de démarrage 1498LT/12



	CHF		
1498LT/12-R7	80.00	1	014980067

1498LT/12-24

Booster de démarrage portable ultra-léger à hautes performances, 12-24 V

Convient parfaitement pour une utilisation sur les voitures, les véhicules utilitaires et les Poids Lourds.



Le microprocesseur offre une protection totale contre:

- inversion de polarité
- des courts-circuits
- tension incorrecte
- surcharges
- sous-déchargement
- surcharge
- surchauffe

DONNÉES TECHNIQUES

- tension de fonctionnement: 12 / 24V
- ampérage continu: 2000/1000 A
- ampérage maximum de démarrage: 5000/2500 A
- ampérage de crête: 10000/5000 A
- ampérage de la pince: 1000 A
- longueur du câble: 160 cm
- section de câble: 25 mm²
- alimentation automatique: 4 Amp
- fonction d'économie de mémoire
- dimensions: 350x240x140 mm
- poids: 5 kg

1498LT/12-24 CHF 2,195.00 1 014980014

1498/12

Booster de démarrage 12 V portable



CARACTÉRISTIQUES TECHNIQUES :

- Courant de décollage 2200A
- Bandoulière de transport fournie
- Batterie hermétique au plomb, électrolyte solide (AGM)

1498/12 CHF 924.00 1 014980480

13 kg

1498/24

Booster de démarrage 12-24 V portable



CARACTÉRISTIQUES TECHNIQUES :

- Courant de décollage 4200A (12V) - 2100A (24V)
- Bandoulière de transport fournie
- Batterie hermétique au plomb, électrolyte solide (AGM)

1498/24 CHF 1,860.00 1 014980490

1498B12/R02

Batterie de recharge 12V pour boosters de démarrage 12-24V



1498B12-R02 CHF 402.00 1 014980502

1498/12-24 R20

Alimentation réseau pour boosters de démarrage

1498/12 et 1498/24



1498/12-24 R20 CHF 96.50 1 014980520

1498/2A

Chargeur de batterie électronique 12V pour motos

Permet la recharge de tous les types de batteries au Pb Wet, Agm, Gel, Mf, Vrla et des batteries au Lithium LiFePo4



- Deux types spécifiques de chargeur de batteries au Lithium et au Plomb
- Cycle de recharge multiphase automatique
- Protection contre l'inversion de polarité et les courts-circuits
- Degré de protection IP65
- Comprend câble avec pinces et câble avec embouts
- Tension d'alimentation : 220-240V

DONNÉES TECHNIQUES

- Courant de recharge : 1A
- Capacité de recharge : 2Ah-40Ah
- Fréquence : 50-60 Hz
- Tension de la batterie : 12V
- Dimensions : 180x80x40 mm
- Poids : 0,5 kg

1498/2A CHF 171.00 1 014980102

1498/4A

Chargeur de batterie électronique 6-12 V auto-moto



- Protection contre l'inversion de polarité et les courts-circuits
- Sélection automatique de la tension à 6 ou 12 Volts
- Sélection automatique du type de batterie
- Écran numérique et fond d'écran lumineux
- Crochet de fixation inclinable

DONNÉES TECHNIQUES

- Tension d'alimentation : 220V-240V
- Fréquence : 50-60 Hz
- Courant nominal (min-max) : 1-4 Amp
- Tension de la batterie : 6V/12V
- Capacité de la batterie : 4Ah-80Ah
- Temps de charge : 12 heures
- Degré de protection : IP65

1498/4A CHF 207.00 1 014980104

1498SA/2A-4A

Câble avec prise allume-cigares pour 1498/2A et 1498/4A



1498SA/2A-4A CHF 43.50 1 014980120



1498/8A

Chargeur de batterie électronique 12V auto / véhicules utilitaires



- charge lente et rapide (2A-8A)
- fonction récupération batteries déchargées
- fonction alimentateur 13,8V-5A
- protection contre l'inversion de polarité et les courts-circuits
- sélection manuelle du type de batterie
- écran numérique et fond d'écran lumineux
- crochet de fixation inclinable

DONNÉES TECHNIQUES

Tension d'alimentation : 220V - 240V
 Fréquence : 50-60 Hz
 Courant nominal (min-max) : 2-8 Amp
 Tension de la batterie : 12V
 Capacité de la batterie : 5Ah-160Ah
 Fonction Memory Saver: 13,8V - 5A
 Degré de protection : IP65

1498/8A CHF 293.00 1 014980108

1498/4A-8A CO

Câble à œillets pour 1498/4A et 8A



1498/4A-8A-CO CHF 21.00 1 014980114

1498/4A-8A CP

Câble avec pinces pour 1498/4A et 8A



1498/4A-8A-CP CHF 27.00 1 014980118

1498/2A-8A-PR

Rallonge pour 1498/2A/4A/8A



1498/2A-8A-PR CHF 50.00 1 014980119

1498/16A

Chargeur de batterie électronique 12-24V multifonction



- Écran d'affichage graphique rétroéclairé
- Courant maximum de charge 16A en continu
- Charge et maintien
- Protection contre l'inversion de polarité, court-circuit
- 9 phases de recharge
- Floating system
- Fonction SHOW ROOM (13,8V - 12A)
- Fonction SUPPLY (14V - 12A)
- Fonction de sauvegarde de mémoire (13,8V - 12A)
- Fonction de récupération batteries
- Porte-pinces
- Crochet de fixation inclinable
- Accessoires inclus : câble avec pince, câble avec œillets

DONNÉES TECHNIQUES

Alimentation : 220-240V
 Puissance : 240W
 Courant de charge : 4-16A
 Type batterie : Agm - Wet - Lithium (LiFePo4)
 Capacité de charge : 5-360Ah
 Capacité de maintien : 5-550Ah
 Tension en sortie : 12-24V
 Tension minimum batterie : 0,8V
 Indice de protection : IP20

1498/16A CHF 615.00 1 014980126

1498/25A

Chargeur de batteries électronique 12-24 V multifonction



- Caractéristiques :
- Écran d'affichage graphique rétroéclairé
 - Courant maximum de charge 25A en continu
 - Charge et maintien
 - Protection contre les inversions de polarité et les court-circuits
 - 9 phases de charge
 - Floating system
 - Fonction SHOW ROOM (13,8V - 21A)
 - Fonction SUPPLY (14V - 21A)
 - Fonction de sauvegarde de mémoire (13,8V - 21A)
 - Fonction de récupération batteries
 - Porte-pinces
 - Crochet de fixation inclinable
 - Accessoires inclus : câble avec pince

Données techniques :

Alimentation : 220-240V
 Puissance : 390W
 Courant de charge : 5-25A
 Type batterie: Agm - Wet - Lithium (LiFePo4)
 Capacité de charge : 5-550Ah
 Capacité de maintien : 5-800Ah
 Tension en sortie : 12-24V
 Tension minimum batterie : 0,8V
 Indice de protection : IP20

1498/25A L mm H mm P mm CHF 724.00 1 014980125



1498/120A

Chargeur de batteries électronique
12 Volts multifonction

Permet la charge des batteries et le maintien de l'alimentation stabilisée pendant toutes les phases de reprogrammation et de diagnostics.



- courant maximum de charge 30 A continus
- charge et maintien avec microprocesseur CPU
- fonction récupération des batteries
- reprogrammation et alimentation ECU
- protection contre l'inversion des polarités, les courts-circuits, les voltages erronés et les surcharges

DONNÉES TECHNIQUES

Alimentation : 90-260V
 Puissance : 1500W
 Courant de charge: 10-120A
 Types de batteries : Agm - Wet - Lithium (LifePo4)
 Capacité de charge : 10-1200Ah
 Capacité de maintien : 5-3600Ah
 Tension en sortie : 12 Volts
 Longueur câbles avec pinces : 2700 mm
 Dimensions: 310 x 150 x 350 mm
 Peso: 8,5 Kg

1498/120A CHF 3,820.00 1 014980142

1498/40A

Chargeur démarreur multifonction 12-24V

Ne disposant pas de batterie interne, la fonction de démarrage (max. 350A) ne remplace pas celle d'un booster de démarrage spécifique type 1498LT/12 (2000A).



- 3 cycles de charge programmés et 1 cycle manuel
- potentiomètre de réglage électronique
- processus spécifiques de charge WET-SPIRAL/GEL-AGM
- système de contrôle et de protection électronique
- processus de charge à 10 phases
- fonction désulfuration et récupération batterie
- fonction supply
- double tension 12-24V
- également indiqué pour batteries Start&Stop
- pinces professionnelles en cuivre isolées en caoutchouc

DONNÉES TECHNIQUES

Alimentation : 230V
 Tension en sortie : 12-24V
 Courant de charge : 1-40A
 Courant de mise en marche : 350A max cc
 Capacité de charge : 4-450Ah

1498/40A CHF 1,550.00 1 014980140

330x250x792

1498SM

Appareil de sauvegarde de mémoire 12 V

Évite la perte des données mémorisées par l'ordinateur de bord des véhicules automobiles lors des opérations de maintenance ou de remplacement de la batterie.



- Caractéristiques techniques :
- auto-alimenté
 - batterie interne Pb 5 Ah
 - 12 Volts
 - connexion professionnelle avec prise OBD

1498SM CHF 331.00 1 014980020

1498SM-C

Câble mémoire auto OBD II 12V pour 1498SM/C



1498SM-C CHF 98.00 1 014980021

1498SM-CP

Câble mémoire auto pince 12V 1498SM/CP



1498SM-CP CHF 33.50 1 014980022

1498SM-A

Alimentateur de sauvegarde de mémoire 1498SM/A



1498SM-A CHF 37.00 1 014980023

1498TB/6-12

Testeur de batterie analogique 6-12 V

Permet l'analyse des batteries 6 V et 12 V jusqu'à 1000 CCA



Longueur des câbles : 500 mm

1498TB/6-12 CHF 77.00 1 014980420

Beta

1498TB/12-24

Testeur numérique pour batteries 12V, analyseur du système de démarrage et du circuit de charge en 12-24V

- Permet d'effectuer les tests suivants : batteries, alternateurs, démarreurs, circuits de régulation et contrôles des masses défaillantes
- Equipé d'un logiciel permettant d'imprimer les tests sur PC
- Afficheur rétro-éclairé
- Structure compacte et antichoc
- Logiciel en 10 langues
- Equipé d'un port dédié pour le branchement d'une mini imprimante extractible (accessoire en option Beta 1498ST/TB)



CE

DONNÉES TECHNIQUES :

- Applications : Test batteries 12V - Test alternateur 12-24V charge - Test systèmes de démarrage
- Intervalle de fonctionnement : 100-2000 CCA
- Normes de référence : CCA, SAE, DIN, EN, IEC, JIS
- Batteries supportées : PB, WET, GEL, AGM, AGM FLAT, EFB
- Voltmètre : 9V-36V
- Longueur câbles : 1600 mm
- Langues : Italien, Anglais, Français, Allemand, Espagnol, Polonais, Roumain, Hollandais, Suédois et Finlandais
- Accessoires compris : câble USB et logiciel

1498TB/12-24 **CHF** 885.00 1 014980401

1498ST/TB

Mini imprimante thermique pour testeur 1498TB/12

- Possibilité de brancher la mini imprimante directement sur le testeur
- Permet d'imprimer les résultats du test effectué



CE

1498ST/TB **CHF** 317.00 1 014980410

1498ST/TB ROT

Rechange papier pour imprimantes 1498ST/TB



1498ST/TB ROT **CHF** 15.40 2 014980411

1498PC

Stabilisateur de tension 12-24 V

Indispensable pour protéger les centrales en phase de soudure et mises en marche avec booster



1498PC **CHF** 131.50 1 014980801

1499

Autoscope



1499 **CHF** 132.50 1 014990001

1500/...

Extracteur à 2 griffes coulissantes

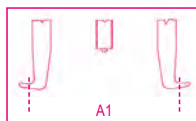

	L mm	CHF		
1500/1	100	111.00	1	015000301
1500/2	100	116.00	1	015000302
1500/3	150	193.00	1	015000303
1500/4	150	265.00	1	015000304
1500/5	205	481.00	1	015000305
1500/6	205	564.00	1	015000306
1500/7	205	844.00	1	015000307
1500/8	230	1,350.00	1	015000308

	A min+Max mm	A1 min+Max mm	CHF	
1500/1	25÷80	70÷130		
1500/2	25÷130	80÷180		
1500/3	50÷160	105÷220		
1500/4	60÷200	120÷270		
1500/5	80÷250	160÷330		
1500/6	80÷350	160÷420		
1500/7	110÷520	195÷600		
1500/8	170÷640	260÷715		



1500/SP5 **CHF** 1,245.00 1 015000325
1500/1-1500/2-1500/3
1500/4-1500/5
1500/SPV **108.50** 1 015000001

1500G/...

Paire de griffes série normale pour 1500 et 1580/81



	mm	1500	CHF	
1500G/1	35	/1-2	71.50	1 015000311
1500G/3	35	/3-4	105.50	1 015000313
1500G/5	35	/5-6-7	214.00	1 015000315
1500G/8	50	/8	263.00	1 015000317
		1580/81		

1500N/...

Extracteur universel à 2 griffes coulissantes

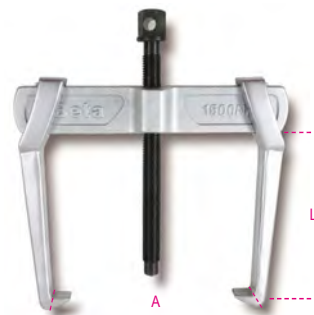

	A min+Max mm	L mm	CHF	
1500N/0	18÷65	70	99.00	1 015000600
1500N/1	23÷70	100	103.50	1 015000601
1500N/2	23÷100	100	112.00	1 015000602
1500N/3	35÷140	150	186.50	1 015000603
1500N/4	35÷190	150	201.00	1 015000604
1500N/5	43÷250	205	387.00	1 015000605
1500N/6	43÷320	205	419.00	1 015000606



	CHF		
1500N/SP6	1,089.00	1	015000626
1500N/0-1500N/1-1500N/2-1500N/3			
1500N/4-1500N/5			
1500N/SPV	131.50	1	015000006

1500N/G...

Griffe pour 1500N



	mm	1500N	CHF		
1500N/G0	10	/0	33.00	2	015000650
1500N/G1-2	12	/1-2	34.50	2	015000651
1500N/G3-4	17	/3-4	61.50	2	015000653
1500N/G5-6	23	/5-6	121.00	2	015000655

1501/1-2-3

Extracteur à 2 griffes fines coulissantes

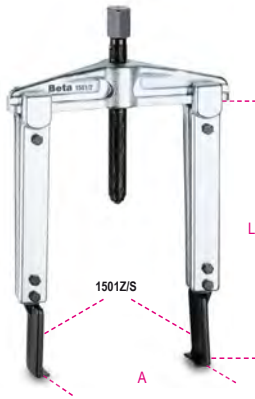

	L mm	CHF		
1501/1	100	250.00	1	015010101
1501/2	200	265.00	1	015010102
1501/3	250	278.00	1	015010103

	A min+Max mm
1501/1	25÷130
1501/2	25÷130
1501/3	25÷130



1501G/1-2-3

Griffe pour 1501



	L mm	CHF		
1501G/1	100	137.50	1	015010111
1501G/2	200	160.00	1	015010112
1501G/3	250	173.50	1	015010113

1501Z/S - P - R

Embout pour griffe 1501G



	mm	D mm	CHF		
1501Z/S	2.0	27	49.00	2	015010211
1501Z/P	3.6	27	50.00	2	015010212
1501Z/R	3.6	14	56.50	2	015010213

1502/...

Extracteurs universels à deux griffes équipés d'un système de verrouillage rapide

Spécifications:

- Pour usage interne et externe
- Les pieds peuvent être déplacés le long de la traverse
- Les pieds sont verrouillés au moyen d'un mécanisme permettant le déverrouillage rapide

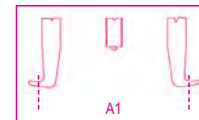
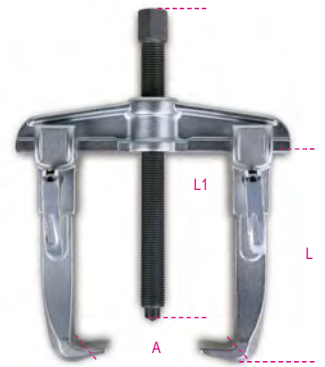

	L mm	L1 mm	CHF		
1502/0	100	166	164.50	1	015020000
1502/1	100	166	178.50	1	015020001
1502/2	150	247	283.00	1	015020002
1502/3	150	247	314.00	1	015020003
1502/4	200	321	538.00	1	015020004

	A min+Max mm	A1 min+Max mm
1502/0	40÷90	80÷130
1502/1	50÷130	90÷170
1502/2	65÷150	115÷210
1502/3	65÷190	125÷260
1502/4	70÷235	170÷335

1505V

Extracteur de bras d'essuie-glace et essuie-glace arrière

Embout en cuivre foré extractible pour extraction de bras avec buse lave-verre intégrée



	A Max mm	L mm	CHF		
1505V	43	37	57.50	1	015050001



1505/C5

Kit pour extraction essuie-glace

1 extracteur à 2 griffes Ø 25÷40 mm
4 demi-lunes Ø 25 mm, Ø 30 mm, Ø 35 mm, Ø 41 mm



mm **CHF**
12 194.00 1 015050300

320x150x60 mm - 1,2 kg

1506

Extracteur auto-serrant à 2 griffes

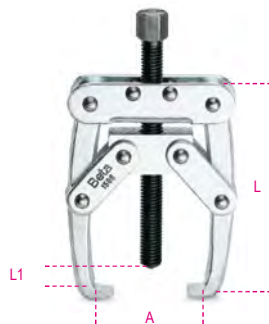

A min=Max mm L mm L1 mm **CHF**
1506 10÷50 80 40 59.50 1 015060001

1508/1 - 1508/2

Extracteur à 2 griffes larges



L mm **CHF**
1508/1 105 199.00 1 015080001
1508/2 130 237.00 1 015080002

A min=Max mm L1 mm
1508/1 6÷100 85
1508/2 10÷140 120

1511/1 - 2 - 3

Extracteur à 2 griffes réversibles à prise extérieure

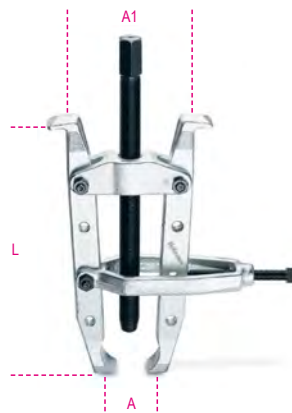

L mm **CHF**
1511/1 235 337.00 1 015110001
1511/2 330 422.00 1 015110002
1511/3 405 523.00 1 015110003

A min=Max mm A1 min=Max mm
1511/1 20÷100 65÷95
1511/2 40÷150 103÷190
1511/3 40÷150 103÷175

1515/1 - 2 - 3

Extracteur à 2 griffes articulées



L mm **CHF**
1515/1 85 44.00 1 015150101
1515/2 85 46.50 1 015150102
1515/3 105 70.00 1 015150103

A Max mm L1 mm
1515/1 60 105
1515/2 70 105
1515/3 90 105

1516/1 - 2 - 3

Extracteur à 3 griffes articulées



L mm **CHF**
1516/1 85 64.00 1 015160001
1516/2 85 68.00 1 015160002
1516/3 105 96.50 1 015160003

A Max mm L1 mm
1516/1 60 85
1516/2 70 85
1516/3 90 105

1517

Extracteur auto-serrant à 3 griffes

- Pour charges d'extraction élevées.
- Effet autoserrant.

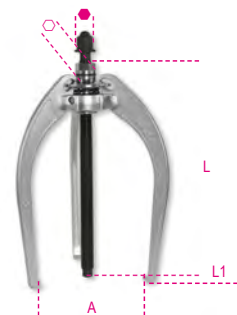

L mm L1 mm Ø mm **CHF**
1517/90 182 60 22 346.00 1 015170000
1517/150 242 115 22 355.00 1 015170010
1517/200 307 150 22 409.00 1 015170020
1517/260 395 180 30 475.00 1 015170030

● mm A mm kg N
1517/90 19 18÷90 6000 59000
1517/150 19 25÷150 6000 59000
1517/200 19 40÷200 6000 59000
1517/260 27 50÷260 8000 78500



Beta

1517C EXTRACTEUR AUTO-SERRANT À 3 GRIFFES

L'extracteur Beta 1517C fonctionne avec serrage automatique des griffes grâce au ressort sur la traverse.

Cette caractéristique facilite le positionnement et le verrouillage de l'extracteur sur la pièce à extraire. Une fois positionnées, les griffes peuvent être verrouillées à l'aide de la bague.

La traverse particulière du 1517C dispose de 4 emplacements permettant d'utiliser l'extracteur soit avec 2 griffes, pour un travail plus facile et plus rapide, soit avec 3 griffes pour une plus grande stabilité de travail.

La goupille de sécurité positionnée en tête de vis casse lorsque le couple maximum autorisé est dépassé, protégeant ainsi l'extracteur des surcharges.

1517C/...

extracteurs autobloquants combinés à deux / trois griffes

- pour une utilisation avec 2 ou 3 griffes
- effet autobloquant



	L mm	L1 mm	CHF		
1517C/0	145	250	293.00	1	015170500
1517C/1	200	300	360.00	1	015170501
1517C/2	270	300	446.00	1	015170502

	A mm	● mm
1517C/0	12÷140	18
1517C/1	20÷180	18
1517C/2	30÷280	18

1518/...

Extracteur à 3 griffes articulées
«grande capacité»



	L mm	CHF		
1518/1	105	107.00	1	015180001
1518/2	135	137.00	1	015180002
1518/3	235	242.50	1	015180003
1518/4	270	361.00	1	015180004
1518/5	270	424.00	1	015180005
1518/6	270	444.00	1	015180006

	A min+Max mm	L1 mm
1518/1	24÷100	105
1518/2	32÷160	150
1518/3	40÷220	220
1518/4	80÷250	240
1518/5	80÷300	350
1518/6	80÷350	400

1518U/...

extracteurs universels à trois griffes

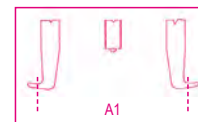
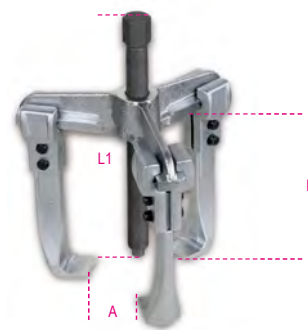

	L mm	L1 mm	CHF		
1518U/0	100	166	202.00	1	015180500
1518U/1	100	166	216.50	1	015180501
1518U/2	150	247	329.00	1	015180502
1518U/3	150	247	343.00	1	015180503
1518U/4	200	321	496.00	1	015180504

	A min+Max mm	A1 min+Max mm	● mm
1518U/0	40÷90	80÷130	17
1518U/1	50÷130	90÷170	17
1518U/2	65÷150	115÷210	22
1518U/3	65÷190	125÷260	22
1518U/4	70÷235	170÷335	27

1519/...

Extracteurs universels à trois pieds
avec système de verrouillage rapides des griffes

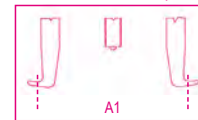
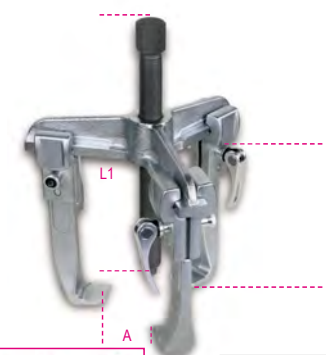

	L mm	L1 mm	CHF		
1519/0	100	166	233.00	1	015190000
1519/1	100	166	247.50	1	015190001
1519/2	150	247	353.00	1	015190002
1519/3	150	247	374.00	1	015190003

	A min+Max mm	A1 min+Max mm	● mm
1519/0	40÷90	80÷130	17
1519/1	50÷130	90÷170	17
1519/2	65÷150	115÷210	22
1519/3	65÷190	125÷260	22



1520/1 - 1520/2

Extracteur à 2 griffes réversibles



	L mm	CHF		
1520/1	135	101.50	1	015200101
1520/2	235	173.50	1	015200102

	A Max mm	L1 mm
1520/1	110	85
1520/2	160	140

1521/1 - 1521/2

Extracteur à 3 griffes réversibles



	L mm	CHF		
1521/1	135	131.50	1	015210101
1521/2	235	231.00	1	015210102

	A Max mm	L1 mm
1521/1	110	90
1521/2	160	140

1528

Extracteur autoserrant pour disques frein



∅ 19 mm

	A min+Max mm	CHF		
	170÷ 380	234.50	1	015280000

260x210x60 mm - 2,6 kg

1529

Extracteur pour poulies à gorges multiples

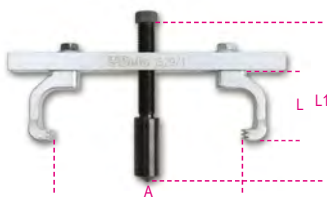

	A min+Max mm	L min+Max mm	L1 min+Max mm	CHF		
	24÷240	60÷95	90÷135	343.00	1	015290000

260x210x60 mm - 2,6 kg

1529/C7

Extracteur pour poulies

Comprises dans le kit :

- 2 griffes avec double pied épaisseur 4,7 mm
- 2 griffes à pied unique épaisseur 4,3 mm
- 1 griffe avec double pied épaisseur 2,3 mm
- 1 griffe à pied unique épaisseur 2,3 mm

Le couple de griffes est modulaire en fonction de l'exigence opérationnelle



	L mm	L1 mm	A min+Max mm	CHF		
1529/C7	50	72,5	53÷114	200.00	1	015290100

285x155x50 mm - 2 kg

1529PI

Extracteur universel pour poulie pompe à injection

- Permet un démontage rapide et précis de la poulie pompe à injection carburant.
- Particulièrement indiqué pour Fiat, Ford, Volkswagen, Citroën et Peugeot

Comprend 3 vis pour serrer l'extracteur à la poulie :

- M6 x 1,0 x 49 mm
- M7 x 1,0 x 75 mm
- M8 x 1,25 x 76 mm



	CHF		
1529PI	143.00	1	015290051

1529/PG

Extracteur pour pompe haute pression gasoil automobiles groupe VAG



	mm	CHF		
15-24		88.00	1	015290010

1530/C5

Kit d'extraction de moyeu et roulements de roues à 3, 4, 5 trous

Le kit comprend :

- 1 bride universelle 96÷138 mm
- 1 vis hydraulique de 12 tonnes
- 1 masse battante de 2,8 kg indispensable pour les moyeux sans boulon de fixation central



	CHF		
1530/C5	723.00	1	015300300

760x320x120 mm - 11,5 kg

1530/C16

Kit extracteur à inertie avec petites colonnes d'écartement, pour l'extraction des moyeux et roulements de roues à 3, 4 et 5 trous

Idéal pour moyeux avec anneau de centrage saillant

Compris dans le kit :

- 1 bride universelle 90÷130 mm
- 1 masse battante de 5 kg
- 4 petites colonnes coupleur M12
- 4 petites colonnes coupleur M14



	CHF		
1530/C16	889.00	1	015300316

760x310x100 mm - 13,5 kg

1531/C7

Kit extracteur pour bagues intérieures de roulement de roue

tailles incluses:

- 1 pince Ø 40 ÷ 45 mm
- 1 pince Ø 45 ÷ 51 mm
- 1 pince Ø 50 ÷ 55 mm
- 1 pince Ø 55 ÷ 61 mm



1531/C7 CHF 977.00 1 015310107

390x315x96 mm - 4,3 kg

1532

Outil pour extraire les joints et des déflecteurs d'huile



1532 CHF 22.70 2 015320001

1533/...

Potence pour 1534



L mm	CHF		
1533/2 150	147.50	1	015330002
1533/3 210	281.00	1	015330003
1533/4 315	445.00	1	015330004
1533/5A 305	538.00	1	015330006

A min+Max mm	L1 mm
1533/2 45÷140	110
1533/3 55÷205	175
1533/4 90÷260	175
1533/5A 100÷360	235

1533PR/1-2-3

Rallonge pour 1533



	CHF		
1533PR/1	32.00	1	015330011
1533/2			
1533PR/2	34.50	1	015330012
1533/3			
1533PR/3	36.50	1	015330013
1533/4			
1533PR/5A	36.50	1	015330016
1533/5A			

1534/...

Décolleur

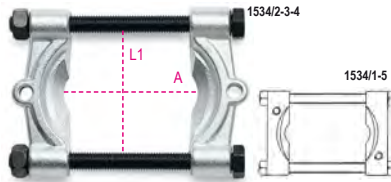

		CHF		
1534/1	1533/2	128.50	1	015340001
1534/2	1533/2	152.00	1	015340002
1534/3	1533/3	252.00	1	015340003
1534/4	1533/4	424.00	1	015340004
1534/5A	1533/5A	873.00	1	015340006

	A min+Max mm	L1 mm
1534/1	5÷60	63
1534/2	12÷75	75
1534/3	22÷115	118
1534/4	25÷155	154
1534/5A	30÷220	180

1535/C...

Composition d'extracteurs



1535/C1 CHF 412.00 1 015350001

	1533/2		
	1533PR/1		
	1534/1		

260x180x40 mm - 2,5 kg

1535/C2 CHF 435.00 1 015350002

	1533/2		
	1533PR/1		
	1534/2		

260x180x40 mm - 2,8 kg

1535/C3 CHF 714.00 1 015350003

	1533/3		
	1533PR/2		
	1534/3		

380x280x55 mm - 8,0 kg

1535/C4 CHF 1,104.00 1 015350004

	1533/4		
	1533PR/3		
	1534/4		

420x380x65 mm - 14,8 kg

1535/C5A CHF 1,675.00 1 015350006

530x510x85 mm - 27,2 kg

1539

Tire-tôles à inertie



1539 CHF 224.50 1 015390001

1540

Masse à inertie

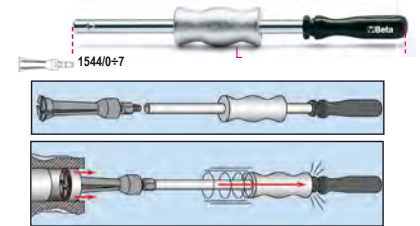

1540 CHF 126.00 1 015400001



Beta

1542/1 - 1542/2

Extracteur pour griffes



	A	min+Max	1544	CHF		
	mm	mm				
1542/1	35÷75	0÷7		108.50	1	015420001
1542/2	60÷130	9C-10C		163.00	1	015420002

	L	L1
	mm	mm
1542/1	140	140
1542/2	175	160

1544/...

Extracteur à pince à prise intérieure

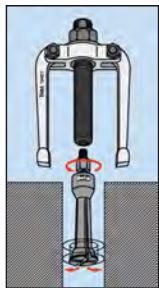

	C	M	CHF		
	mm	M			
1544/0	0,25	M10	95.50	1	015440100
A= 5÷7					
1544/A	0,80	M10	99.00	1	015440105
A= 7÷9					
1544/1	0,80	M10	101.50	1	015440110
A= 9÷12					
1544/2	1,15	M10	104.00	1	015440120
A= 13÷17					
1544/2B	1,00	M10	106.50	1	015440121
A= 14÷19					
1544/3	1,70	M10	109.50	1	015440130
A= 16÷21					
1544/4	1,65	M10	121.50	1	015440140
A= 20÷25					
1544/5	2,00	M10	130.00	1	015440150
A= 25÷30					
1544/6	3,00	M10	163.00	1	015440160
A= 30÷37					
1544/7	3,80	M10	184.50	1	015440170
A= 38÷45					
1544/9C	2,60	G 3/8"	268.00	1	015440189
A= 40÷75					
1544/10C	7,30	G 3/8"	370.00	1	015440199
A= 70÷115					

1545/C5M

Coffret d'extracteur 1542/1 avec 5 extracteurs à pinces 1544



1545/C5M	CHF		
	725.00	1	015450011

1542/1	● 24 mm
1544/1	9÷12 mm
1544/2	13÷17 mm
1544/3	16÷21 mm
1544/4	20÷25 mm
1544/5	25÷30 mm

265x180x45 mm - 2,4 kg

1547/C6

Extracteurs pour roulements à fausses billes en coffret métallique



1547/C6	CHF		
	373.00	1	015470006

420x185x60 mm - 3 kg

1547KP

Jeu de 3 paires d'extracteurs pour roulements à billes



	∅	CHF		
	mm			
1547KP/1	9-11-12,5	59.00	1	015470106
1547KP/2	5-6-8	41.00	1	015470206

1547P

Rallonge 6 pans



	L	CHF		
	mm			
1547P/1	205	1547/1	12.80	1 015470101
1547P/2	102	1547/2	8.15	1 015470201

1547PC/2

Rallonge ronde courte



	L	CHF		
	mm			
1547PC/2	42	1547/2	6.60	1 015470202

1547PL/2

Rallonge ronde longue



	L	CHF		
	mm			
1547PL/2	106	1547/2	7.30	1 015470203

1549

Kit pour démontage et montage amortisseurs à double effet avec retour pneumatique

Permet de maintenir la tige en extension pendant le montage des ressorts



1549	CHF		
	515.00	1	015490001

310x270x110 mm - 3 kg



1550U

Compresseurs de ressort pneumatique pour automobiles, SUV et véhicules commerciaux

CE

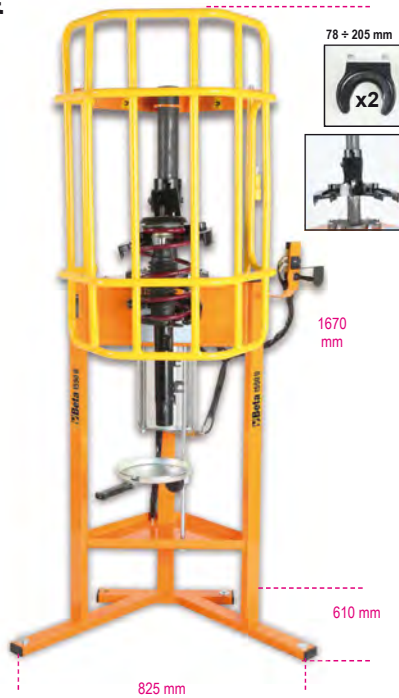

PUISSANCE PLUS ÉLEVÉE : puissance poussée maximum 2 tonnes (10 bars).
SYSTÈME UNIVERSEL DE PRISE SUPÉRIEURE : permet avec une plaque unique adaptable supérieure de comprimer tous les diamètres de ressort pour serrage et desserrage.
SYSTÈME DE SÉCURITÉ ACTIVE SUR LE RESSORT : par le biais du crochet de sécurité et des 3 soupapes de blocage, le positionnement/logement correct du ressort est garanti en maintenant cette position pendant toute l'opération de compression.
 En cas de positionnement "non conforme" du ressort, le système arrête la machine.
GRILLE DE PROTECTION "FULL BODY" : garantit la plus haute sécurité et couverture de la zone de travail.
ACTIONNEMENT AVEC LEVIER DE COMMANDE : plus grande précision et sensibilité lors de la phase de compression.
POSITION DE TRAVAIL : hauteur de travail sur l'étrier arrière élevé jusqu'à 875 mm.
 Fourni avec 2 étriers inférieurs pour diamètres 78-205 mm
DONNÉES TECHNIQUES :
 Puissance poussée : 2 tonnes (10 bars) - 1,6 tonnes (8 bars) - 1,2 tonnes (6 bars)
 Course de compression ressort : 335 mm

1550U CHF 3,920.00 1 015500010

1550U/CGS-R

Couple d'étriers supérieurs abaissés pour 1550U



1550U/CGS-R CHF 754.00 1 015500035

1550U/MRC-ABE

Étriers spéciaux pour 1550U pour Mercedes Classe A-B-E



1550U/MRC-ABE CHF 777.00 1 015500031

1550U/MRC-C

Étriers spéciaux pour 1550U pour Mercedes Classe C



1550U/MRC-C CHF 683.00 1 015500032

1550U/S...

Étrier inférieur pour 1550U



	Ø mm	CHF		
1550U/S 130	78÷130 mm	495.00	1	015500014
1550U/S 182	105÷182 mm	495.00	1	015500015
1550U/S 205	125÷205 mm	495.00	1	015500016

1550U/SS187

Coupelle de desserrage pour 1550U

Particulièrement indiquée pour les ressorts avec profil gauche type Nissan Qashqai et Renault Koleos



1550U/SS 187 CHF 495.00 1 015500018

1550U/M

Étau pour démontage amortisseurs 1550U

Permet de bloquer la tige de l'amortisseur



1550U/M CHF 470.00 1 015500021

1551/C20

Kit pour démontage têtes amortisseurs

Compris dans le kit :

- 7 douilles 6 pans mesures : 16 - 17 - 18 - 19 - 21 - 22 - 24
- 1 rallonge porte-douille longueur 120 mm
- 3 embouts femelle mesures : 8x5 - 8x6 - 11x8
- 1 embout femelle pour vis 6 pans creux mesure : 10 mm
- 1 embout mâle XZN(R) mesure : M10
- 1 embout mâle Torx(R) mesure : T50
- 4 embouts mâle pour vis 6 pans mesures : 5-6 - 7 - 8
- 1 rallonge porte-embouts longueur 95 mm
- 1 rallonge porte-embouts longueur 190 mm



1551/C20 CHF 207.00 1 015510020

320x245x71 mm - 2,6 kg

1552/C9

Kit pour écarter les joints des amortisseurs, bras oscillants et volant

Il est possible de travailler avec tête à simple ou double écarteur, de sorte à pouvoir intervenir également sur les joints doubles type groupe VAG.



1552/C9 CHF 164.50 1 015520020

195x140x40 mm - 1,0 kg



1555/Q

Compresseur pour ressorts d'amortisseurs MacPherson ou équivalents

Poussée maximum : 1500 kg

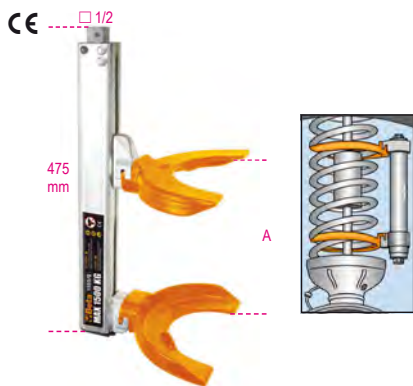

A	Ø	CHF		
min+Max	min+Max			
mm	mm			
65+354	80+195	1,071.00	1	015550006

1555/QS

Compresseur pour ressorts d'amortisseurs MacPherson ou équivalents

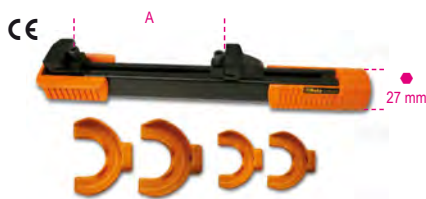

A	Ø	CHF		
min+Max	min+Max			
mm	mm			
70+300	80+200	1,320.00	1	015550005

1555S/BMW-RNT

Coupelle pour amortisseurs BMW E39, E46 et Renault Mégane II pour 1555Q et 1555/QS



1555S/BMW-RNT	CHF			
	414.00	1	015550303	

1555C

Compresseur des ressorts télescopique avec 2 jeux de coupelles et barre de torsion



A	Ø	N	t	CHF		
min+Max	min+Max					
mm	mm					
80+225	90+160	25000	8,5	1,270.00	1	015550202

1556/1A

Compresseur de ressorts

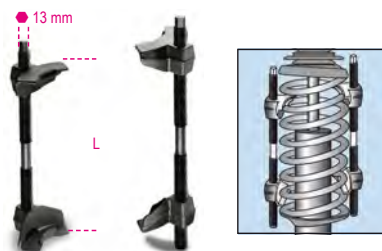

min L	Max	CHF		
mm	mm			
65+320		309.00	1	015560101

1556/2A

Compresseur de ressorts

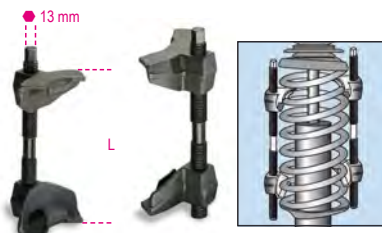

min L	Max	CHF		
mm	mm			
65+200		305.00	1	015560102

1557

Douilles à chocs pour axes de ressort à lames Truck



L	L1	CHF		
mm	mm			
37	28	114.50	1	015570137
46	34	117.00	1	015570146
56	34	127.00	1	015570156

1557V

Douille à chocs pour axes de ressort à lames Truck Volvo



mm	CHF		
27	59.50	1	015570299

1557/S3

Jeu de 3 clés à ergots pour écrous de tige d'amortisseur

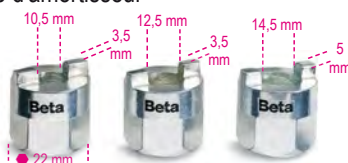

1557/S3	CHF		
	89.00	1	015570010

1558/C4

Outil pour circlips de moyeux intérieurs et extérieurs avec actionnement à vis

Le coupleur carré 3/8" permet d'appliquer une force élevée dans les deux conditions d'utilisation

Ergots fournis : Ø 2,5-3-3,5 mm



1558/C4	CHF		
5,5+77 5,5+77	220.50	1	015580100

330x220x50 mm - 900 g

1558P

Couple ergots circlips de moyeux pour 1558



Ø	CHF		
mm			
2,5	11.20	1	015580125
3,0	11.20	1	015580130
3,5	11.20	1	015580135

1558/C13

Outil pour circlips de moyeux intérieurs et extérieurs avec actionnement à vis

Le coupleur carré 3/8" permet d'appliquer une force élevée dans les deux conditions d'utilisation

Ergots fournis :

- droits : Ø 2,5 - 3 - 3,5 - 3,8 mm
- 45° : Ø 2,5 - 3 - 3,5 - 3,8 mm
- 90° : Ø 2,5 - 3 - 3,5 - 3,8 mm



1558/C13	CHF		
5,5+77 5,5+77	296.00	1	015580200

330x220x45 mm - 1,6 kg

1559

Extracteur de rotules, type léger



	A Max mm	Ø mm	CHF		
1559/22	50	18÷22	114.00	1	015590001
1559/36	90	36	525.00	1	015590036
1559/45	115	45	786.00	1	015590045

1559V/8T

Vis hydraulique pour extracteur de rotules 1559/36 et 1559/45

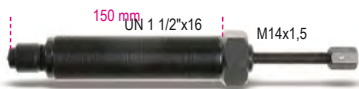

Nm	t	CHF		
80000	8	397.00	1	015590145

1560/2

Extracteur de rotules, modèle professionnel



	A min+Max mm	Ø mm	CHF		
1560/2	60÷85	20	244.00	1	015600002

1560A

Extracteur de rotules



	CHF		
1560A	327.00	1	015600601

1561/...

Chasse-rotules



	L mm	A mm	Ø mm	CHF		
1561/1	39	36,6	18	88.50	1	015610001
1561/2	47	45,7	25	116.00	1	015610002
1561/3	63	62	30	168.50	1	015610003
1561/4	75	63	40	214.00	1	015610004

1562D

Extracteur de rotules

Fourni avec 2 vis pour l'extraction de joints à rotule de suspension et de direction



A max mm	Ø mm	● mm	L mm	CHF		
50	39	26	155	445.00	1	015620239

1563/C4

Jeu de 4 douilles pour le démontage des rotules

A utiliser avec un marteau pneumatique

définir le contenu:

- 1 douille M12x1,25 mm
- 1 douille M12x1,5 mm
- 1 douille M14x1,5 mm
- 1 douille M16x1,5 mm



1563/C4	CHF		
	64.00	1	015630010

1565/1-2-3

Chasse-rotules à frapper



	Ø mm	L1 mm	CHF		
1565/1	18	65	101.00	1	015650001
1565/2	23	65	114.00	1	015650002
1565/3	30	88	119.00	1	015650003

1566N

Extracteur de rotules axiales de direction



Ø x L mm	□ mm	CHF		
28÷35 x 400	27	161.00	1	015660005
35÷45 x 190	27	161.00	1	015660008
35÷45 x 400	27	181.00	1	015660010

1566R

Extracteur de rotules axiales de direction



Ø mm	CHF		
27÷43	31.00	1	015660015

1566/G01

Extracteur pour joints homocinétiques

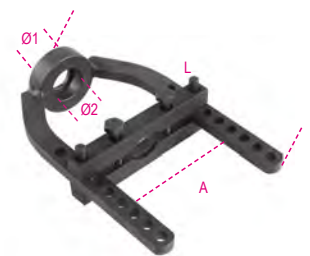

L mm	A mm	Ø1 mm	Ø2 mm	CHF		
250	115	29	36	192.00	1	015660052

1566P

Pince pour circlips antidérapant pour arbres de roue

La pince comprime le circlip et simplifie ainsi l'insertion de l'arbre de roue dans le joint homocinétique.



L mm	A Max mm	CHF		
280	36	87.50	1	015660091

1567

Lever dépose brides d'amortisseur

Utilisable par un seul opérateur



A mm	B min+Max mm	CHF		
1060	100÷300	441.00	1	015670001

1568

Expandeur pneumatique pour le montage des soufflets de cardan

8 bras d'écartement
écartement maximal des bras: 145 mm

CE



L mm	L1 mm	CHF		
420	195	315.00	1	015680001

1569/F

Composition d'outils pour le montage et le démontage des silentblocks avant et arrière des Fiat Panda, Fiat 500 et Ford Ka



1569/F	CHF		
	582.00	1	015690021

1569/SB

Composition d'outils pour l'extraction et l'introduction des silentbloks pont arrière, déflecteurs d'huile arbre moteur et roulements de roue

• Les douilles peuvent être utilisées aussi bien directement sur le véhicule qu'à la presse hydraulique



1569/SB	CHF		
	326.00	1	015690016

425x365x100 mm - 13 kg

1569CP

Injecteur à percussion pour roulements coniques et déflecteurs d'huile

Réglage rapide



	Ø min+Max mm	L mm	CHF		
1569CP/50	9,5÷50	130	172.50	1	015690750
1569CP/90	18÷90	145	214.00	1	015690790

1570/3

Vérin hydraulique pour extracteurs



t	L mm	L1 mm	mm	CHF		
30	243	36	19	317.00	1	015700003

1580/8I

Extracteur hydraulique 2 griffes

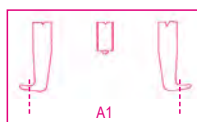
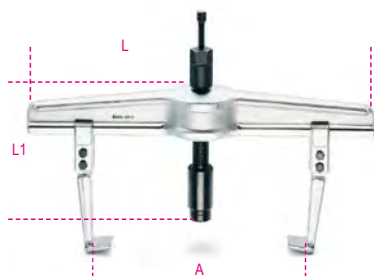

1580/8I	CHF		
	2,035.00	1	015800008

	A min+Max mm	L mm	L1 mm	A1 min+Max mm	N Max
1580/8I	170÷640	715	280	260÷715	180000

1580GL

Griffe longue pour extracteurs 1580/8I



	L mm	CHF		
1580GL/8A	300	229.50	1	015800227
1580GL/8B	400	255.00	1	015800228
1580GL/8C	500	326.00	1	015800229

1585/5I - 6I - 7I

Extracteur hydraulique 3 griffes

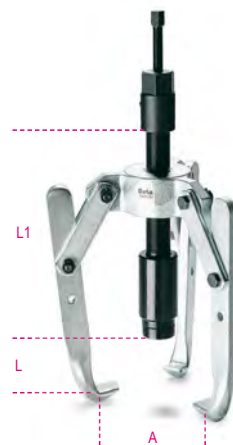

	CHF		
1585/5I	1,415.00	1	015850005
1585/6I	1,485.00	1	015850006
1585/7I	1,530.00	1	015850007

	A min+Max mm	L1 mm	L mm	N Max
1585/5I	50÷350	135	280	150000
1585/6I	50÷350	235	280	150000
1585/7I	50÷350	335	280	150000

1585GI/5 - 6 - 7

Griffe pour 1585/I-1585/6I-1585/7I

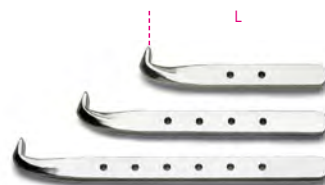

	L mm	CHF		
1585GI/5	135	128.50	1	015850205
1585GI/6	235	152.00	1	015850206
1585GI/7	335	184.00	1	015850207

1589VI

Vis hydraulique pour 1580/8I et 1585/5I-1585/6I-1585/7I



1589VI	CHF		
	833.00	1	015890001

1589PI/50 - 100 - 150

Rallonge pour vis hydraulique



	L mm	L1 mm	CHF		
1589PI/50	50	70	75.50	1	015890005
1589PI/100	100	120	83.00	1	015890010
1589PI/150	150	170	90.50	1	015890015

1590

Presse d'assemblage



A max mm	L1 mm	CHF		
60	55	34.50	2	015900305
100	65	56.00	2	015900310
150	95	92.50	2	015900315

1591

Presse à vis

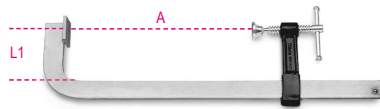

A ~	A max mm	L1 mm	CHF		
200	200	80	36.50	2	015910020
300	310	85	44.50	2	015910030
400	410	85	48.50	2	015910040
500	500	95	65.00	2	015910050
600	600	95	66.50	2	015910060
800	800	95	80.50	2	015910080
1000	1000	110	101.00	2	015910100

1593

Serre-joints à vis avec poignée

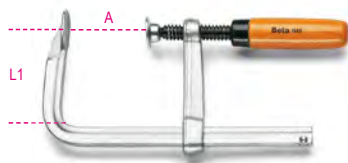

A ~	A max mm	L1 mm	CHF		
160	170	80	43.50	2	015930016
200	240	100	66.50	2	015930020
300	320	145	93.00	2	015930030

1594

Serre-joints à levier



A ~	A max mm	L1 mm	CHF		
200	240	145	144.50	1	015940020
250	290	145	150.00	1	015940025
300	340	145	160.50	1	015940030
400	430	150	168.00	1	015940040
500	530	150	176.50	1	015940050
600	630	150	185.50	1	015940060

1595

Serre-joints à vis zingué

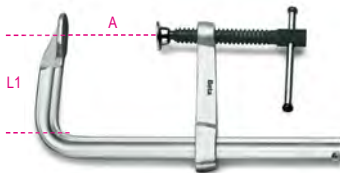

A ~	A max mm	L1 mm	CHF		
200	230	100	69.00	2	015950020
250	270	120	75.00	2	015950025
300	330	120	95.50	2	015950030
400	420	120	107.00	2	015950040
500	520	125	116.50	2	015950050
600	620	125	123.50	2	015950060
800	820	125	146.50	1	015950080
1000	1030	125	162.50	1	015950100

1599F

Étau parallèle d'établi, forgé

Entièrement en fonte d'acier. Mâchoires fraisées et trempées en surface.

Ouverture avant. Grande profondeur de serrage



L1 mm	BxH mm	Ø mm	A MAX mm	CHF		
100	92x46	11	125	428.00	1	015990100
125	108x54	13	150	547.00	1	015990125
150	125x62	13	200	768.00	1	015990150
175	140x70	15	220	1,048.00	1	015990175

1599GI

Étau parallèle d'établi à mâchoires interchangeables

- Avec guide carré pour les travaux difficiles
- Mâchoires interchangeables avec surface trempée

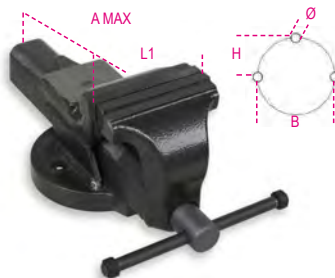

L1 mm	BxH mm	Ø mm	A MAX mm	CHF		
100	92x46	11	125	330.00	1	015990200
125	108x54	13	150	454.00	1	015990225
150	125x62	13	200	620.00	1	015990250
175	140x70	15	220	827.00	1	015990275

1599GR

Paire de mâchoires et vis de rechange pour étau 1599GI



	A mm	CHF		
1599GR 100	100	31.50	1	015990920
1599GR 125	125	39.50	1	015990925
1599GR 150	150	48.50	1	015990950
1599GR 175	175	56.50	1	015990975

1599P

Étau parallèle d'établi

Mâchoires trempées
Enclume avec ample surface vernie
Base carrée en acier

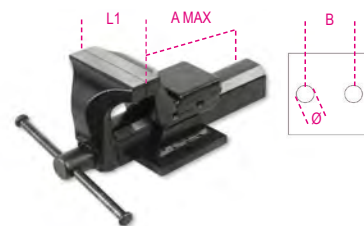

L1 mm	B mm	Ø mm	A MAX mm	CHF		
100	92	11	111	376.00	1	015990000
125	108	13	130	451.00	1	015990025
150	130	15	170	629.00	1	015990050

1599B

Base pivotante pour étau 1599P



	1599P	CHF		
1599B 100	100	157.00	1	015990810
1599B 125	125	178.50	1	015990812
1599B 150	150	220.50	1	015990815

1599T

Étau parallèle de perceuse

Étaux en fonte spéciale, avec mâchoires trempées et rectifiées
Applicable sur les petites et moyennes perceuses à colonne

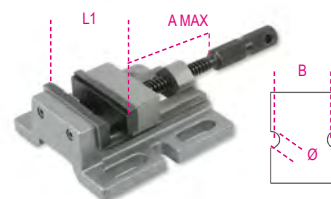

L1 mm	B mm	Ø mm	A MAX mm	CHF		
80	111	11	65	212.00	1	015990480
100	120	13	87	263.00	1	015990500

1599G

Paires de mors en aluminium

- Magnétiques sur la totalité de la longueur
- Fraisé intérieurement pour permettre un serrage aisé des pièces filetés



A mm	CHF	1	015990910
100	69.00	1	015990910
125	71.50	1	015990912
150	78.00	1	015990915
180	87.00	1	015990917

1600Q 8

Clé cruciforme pour tableautiers

Carré de 5 / 6 / 7-8 mm

Triangle de 9 mm

Ailettes de 3-5 mm

Hexagone de 1/4"

Embout double avec fente 1,0x7mm et empreinte cruciforme PH2



L mm	CHF	1	016000008
76	38.50	1	016000008

1600Q 10

Clé articulée cruciforme double pour tableautiers

Carré de 5 / 6-7 / 8-9 mm

Triangle de 5-6-7 / 8-9 / 10 mm

Ailettes 3-5 mm

Hexagone 1/4"

Carré mâle 1/4"



L mm	CHF	1	016000010
125	49.00	1	016000010

SERVICE DE CERTIFICATION DES INSTRUMENTS DE MESURES

La certification des instruments de mesure est essentielle dans les secteurs où les domaines d'application requièrent de mesures précises, et non ambiguës. La certification implique la délivrance d'un certificat Accredia :

Sur demande, Beta Utensili S.p.A. fournit le service de certification pour les niveaux, les pieds à coulisse, les comparateurs, les micromètres et les jauges d'épaisseur. Pour bénéficier de ce service, veuillez contacter votre revendeur BETA.



1650

Pied à coulisse précision au 1/10e

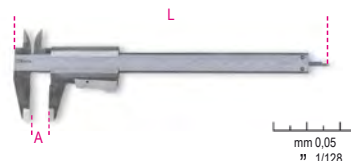

UNI EN ISO 13385-1DIN 862

A max mm	L mm	CHF	1	016500001
150	235	80.00	1	016500001
200	290	105.50	1	016500002

1650FD

Pied à coulisse pour disque de frein, précision au 1/10e

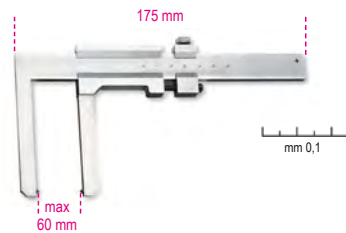

1650FD	CHF	1	016500050
	284.00	1	016500050

1650FT

Pied à coulisse pour tambour de frein, précision au 1/20e

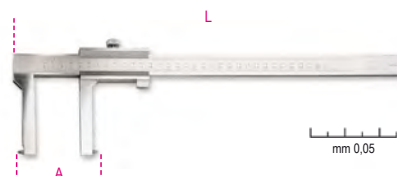

	A max mm	L mm	CHF	1	016500060
1650FT/1	350	438	532.00	1	016500060
1650FT/2	500	550	929.00	1	016500070

1651DGTB

Pied à coulisse numérique précision au 1/100e

Caractéristiques :

- Précision au 1/100e
- Blocage de la coulisse grâce à une vis
- Conversion mm/pouces
- Mise à zéro dans n'importe quelle position
- Tige de profondeur carrée jusqu'à 300 mm
- étui rigide de rangement en matière plastique

CE



UNI EN ISO 13385-1DIN 862CE

A Max mm	L mm	B mm	CHF	1	016510211
150	235	40	135.00	1	016510211
200	285	50	176.00	1	016510212
300	400	60	230.00	1	016510213

1651DGTB/IP

Pied à coulisse numérique
précision au 1/100e
avec protection IP67

- Précision au 1/100e
- Blocage à vis de la coulisse
- Conversion mm/pouces
- Allumage automatique grâce au mouvement de la coulisse
- Mise à zéro dans n'importe quelle position
- Fonction HOLD
- Choix possible entre mesure absolue et mesure incrémentale

Le degré de protection IP67 garantit une protection intégrale contre les poussières et les liquides, ce qui préserve les caractéristiques fonctionnelles même en cas d'immersion complète de l'instrument.

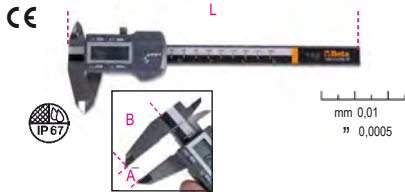

UNI EN ISO 13385-1 DIN 862CE

A Max mm	L mm	B mm	CHF		
150	235	40	220.50	1	016510711

270x115x35 mm - 450 g

1652

Pied à coulisse à cadran analogique,
précision au 1/50e

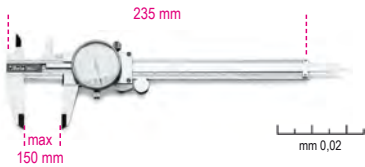

UNI EN ISO 13385-1DIN 862

1652	CHF		
	169.00	1	016520016

1654

Pied à coulisse, précision au 1/50e



UNI EN ISO 13385-1DIN 862

A max mm	L mm	CHF		
200	330	371.00	1	016540020
300	410	503.00	1	016540030

Beta

1654DGT

Pied à coulisse à affichage digital
Précision au 1/100e
Lecture 0,01 mm
Lecture 0,0005"

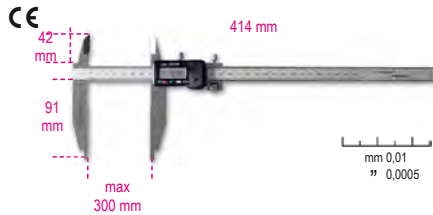

UNI EN ISO 13385-1DIN 862CE

1654DGT	CHF		
	849.00	1	016540111

1656

Jauge de profondeur,
précision au 1/50e

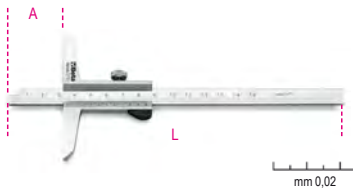

UNI EN ISO 13385-2DIN 862

A max mm	L mm	CHF		
200	260	176.00	1	016560020
300	360	259.00	1	016560030

1657DGT/2

Jauge de profondeur à affichage digital,
précision au 1/100e

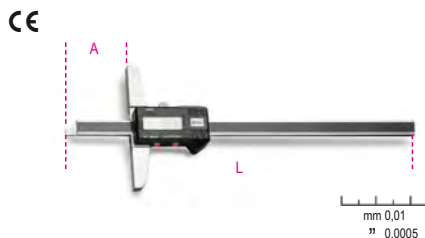

UNI EN ISO 13385-2DIN 862CE

1657DGT/2	A max mm	L mm	CHF		
	200	270	327.00	1	016570002

1658/...

Micromètre d'extérieur,
précision au 1/100e



DIN 863/II

	A mm	CHF		
1658/25	0÷25	101.00	1	016580025
1658/50	25÷50	109.50	1	016580050
1658/75	50÷75	124.00	1	016580075
1658/100	75÷100	135.50	1	016580100

1658/C4

Coffret de 4 micromètres 1658



DIN 863

1658/C4	CHF		
	407.00	1	016580001

1658/25	0÷25 mm
1658/50	25÷50 mm
1658/75	50÷75 mm
1658/100	75÷100 mm

365x245x35 mm - 2,5 kg

1658DGTB

Micromètre d'extérieur numérique IP65
précision au 1/100e

- Précision au 1/1000e
- Contacts en métal dur
- Blocage grâce à un levier de la coulisse
- Conversion mm/pouces
- Mise à zéro dans n'importe quelle position
- Choix possible entre mesure absolue et mesure incrémentale
- Clé de réglage incluse



DIN 863CE

1658DGTB 25	CHF		
	276.00	1	016580525
1658DGTB 50	343.00	1	016580550

Beta

Beta

1658SP/1

Support pour micromètre



1658SP/1 **CHF** 70.00 1 016580910

1659

Jauge d'épaisseur avec comparateur analogique, précision au 1/100e

C=course



1659 **CHF** 260.00 1 016590001

1662/1 - 1662/2

Comparateur à cadran analogique, précision au 1/100e

C=course



DIN 878

C mm	CHF	1	016620001
0÷5	119.00	1	016620001
0÷10	145.00	1	016620010

1662DGT/A

Comparateur à affichage digital précision au 1/100e

C = Course

CE



1662DGT/A **CHF** 361.00 1 016620311

1662AN

Comparateur à cadran analogique à levier précision au 1/100e

C=Course



DIN 2270

C mm	CHF	1	016620200
0÷0,8	281.00	1	016620200

1662SPO

Support de comparateur magnétique



1662SPO **CHF** 100.50 1 016620800

1662SP2

Support de comparateur articulé magnétique



1662SP2 **CHF** 181.50 1 016620910

1666

Equerre simple en acier inoxydable, faces rectifiées et polies



DIN 875/0

L mm	L1 mm	CHF	1	016660210
100	70	82.50	1	016660210
150	100	119.50	1	016660215
200	130	143.00	1	016660220
250	165	185.50	1	016660225
300	200	233.50	1	016660230

1666A

Equerre à chapeau en acier inoxydable, faces rectifiées et polies



DIN 875/0

L mm	L1 mm	CHF	1	016660110
100	70	121.00	1	016660110
150	100	163.50	1	016660115
200	130	230.50	1	016660120
250	170	286.00	1	016660125
300	200	362.00	1	016660130

1668

Equerre simple en acier normalisé faces et arêtes rectifiées



DIN 875/2

L mm	L1 mm	CHF	2	016680210
100	70	36.50	2	016680210
150	100	48.50	2	016680215
200	130	63.00	2	016680220
250	165	91.50	1	016680225
300	174	113.00	1	016680230

Beta

1668A

Équerre à chapeau en acier normalisé, faces et arêtes rectifiées



DIN 875/2

L mm	L1 mm	CHF		
100	70	43.50	2	016680110
150	100	67.00	2	016680115
200	130	85.00	2	016680120
250	165	122.00	1	016680125
300	176	145.50	1	016680130

1670

Équerre simple, en acier, rectifiée



L mm	L1 mm	CHF		
100	70	22.70	3	016700010
150	100	23.70	3	016700015
200	130	26.50	3	016700020
250	160	29.00	3	016700025
300	175	32.00	3	016700030
400	230	47.50	2	016700040
500	280	53.50	2	016700050
600	330	56.50	2	016700060
800	420	77.00	1	016700080
1000	500	91.50	1	016700099

1670A

Équerre à chapeau, en acier, rectifiée



L mm	L1 mm	CHF		
100	70	29.50	3	016700110
150	100	32.00	3	016700115
200	130	34.50	3	016700120
250	165	42.00	3	016700125
300	175	49.50	3	016700130
400	230	65.00	2	016700140
500	280	87.00	2	016700150
600	330	97.50	2	016700160
800	420	115.50	1	016700180
1000	500	143.00	1	016700199

1672

Fausse équerre à coulisse lame et talon en acier

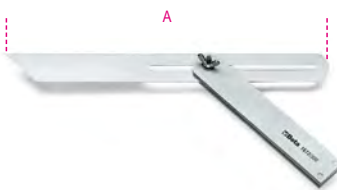

A mm	CHF		
300	69.50	2	016720030

1672A

Fausse équerre à coulisse lame en acier chromée, talon en aluminium

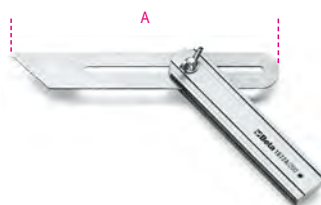

A mm	CHF		
200	36.00	3	016720120
300	39.50	3	016720130

1674A

Équerre de menuisier, lame en acier talon en aluminium, double échelle millimétrique



L mm	L1 mm	CHF		
300	169	34.00	2	016740130
400	214	42.50	2	016740140

1674C

Équerre combinée de menuisier avec support en acier et niveaux de lecture

- Double échelle en mm
- Niveau de Surface

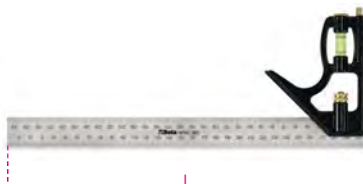

L mm	CHF		
300	24.90	2	016740230

1676

Rapporteur d'angles simple en acier inoxydable

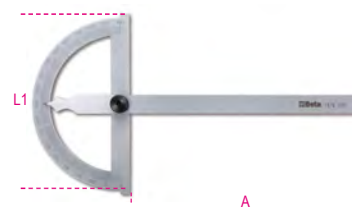

A mm	A mm	L1 mm	G mm	CHF		
120	120	80	1°	54.00	2	016760012
150	165	120	1°	62.00	2	016760015
200	210	150	1°	75.00	2	016760020
300	310	200	1°	101.00	1	016760030

1678/C3

Rapporteur d'angles en acier inoxydable



L Max mm	D mm	CHF		
300	70	384.00	1	016780030

1679

Pied à coulisse à tracer à molette en acier inoxydable, précision au 1/10e

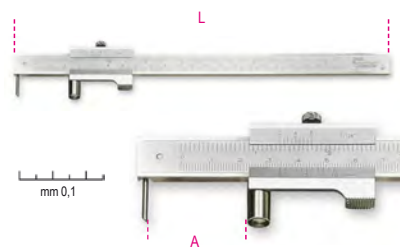

L mm	A Max mm	CHF		
235	200	116.00	1	016790020

1679/PR

Pointe pour pied à coulisse 1679



L mm	CHF		
1679/PR	18.70	1	016790021

1680

Compas à verge corps et pointes de traçage en acier trempé

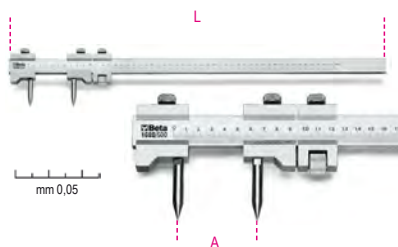

L mm	A Max mm	CHF	1	016800050
660	500	384.00		

1680A

Compas d'intérieur



L mm	A Max mm	CHF	2	016800115
150	144	25.00		
200	200	30.50		
250	245	38.00		
300	300	43.50		

1680B

Compas d'épaisseur



L mm	A Max mm	CHF	2	016800215
150	155	25.00		
200	190	30.50		
250	235	38.00		
300	280	43.50		

1680C

Compas à pointes sèches pointes droites en acier trempé



L mm	A Max mm	CHF	2	016800315
150	138	25.00		
200	190	30.50		
250	235	38.00		
300	280	43.50		

1682

Réglet flexible en acier inoxydable



L mm	H mm	\pm mm	CHF	5	016820015
150	13	0,5	4.10		
200	13	0,5	4.40		
250	13	0,5	5.50		
300	13	0,5	6.80		
500	13	0,5	15.40		
1000	13	0,5	40.50		

1683

Réglet semi-rigide en acier inoxydable

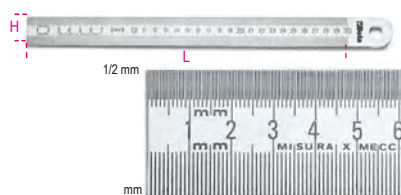

L mm	H mm	\pm mm	CHF	5	016830030
300	30	1	12.10		
500	30	1	20.20		
1000	30	1	51.00		
1500	30	1	113.50		

1685/C7

Coffret de 7 outils de métrologie



1685/C7	CHF	1	016850110
	391.00		

	1650	160 mm
	1658/25	0+25 mm
	1670	100 mm
	1680C	150 mm
	1682	150 mm
	1688BC	165 mm
	1688BC/R	

320x210x37 mm - 1,2 kg

1687A

Pointe de précision coudée 90° avec manche

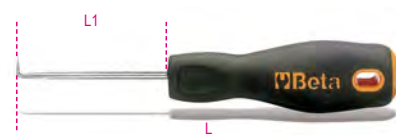

1687A	L mm	L1 mm	CHF	1	016870120
	153	80	8.50		

1687AC

Pointe de précision courte coudée avec manche



1687AC	L mm	L1 mm	CHF	1	016870125
	153	80	8.50		

1687D

Pointe de précision droite avec manche



1687D	L mm	L1 mm	CHF	1	016870110
	153	80	8.50		

1687U

Pointe de précision à crochet avec manche



1687U	L mm	L1 mm	CHF	1	016870115
	153	80	8.50		

1687/S4

Jeu de 4 pointes de précision avec manche



1687/S4	CHF	1	016870150
1687A-1687AC 1687D-1687U	34.00		

1688

Pointe à tracer en acier trempé



	L mm	Ø mm	CHF		
1688	250	2	11.20	5	016880020

1688A

Pointe à tracer en carbure



	L mm	Ø mm	CHF		
1688A	200	4	20.20	5	016880120

1688PC

Pointe à tracer rétractable en carbure en acier trempé chromé



	L mm	Ø mm	CHF		
1688PC	150	1	47.50	1	016880300

1688PC/R

Pointe pour 1688PC



	CHF		
1688PC/R	14.00	1	016880310

1688M

Crayon de menuisier



	L mm	CHF		
1688M	180	1.47	50	016880880

1690F

Mètre pliant en fibre de verre classe de précision III

CE



	L m	S mm	CHF		
1690F/2	2	17	16.10	5	016900220

1690L

Mètre pliant en bois de bouleau classe de précision III

CE



	L m	S mm	CHF		
1690L/2	2	17	17.60	5	016900200

1691BM

Mètre à ruban
boîtier ABS antichoc bi-matières
Ruban en acier
Classe de précision : II

CE



	L m	S mm	CHF		
1691BM/5	5	25	21.10	1	016910205
1691BM/8	8	32	31.50	1	016910208
1691BM/10	10	32	38.50	1	016910210

1691MG

Mètre à ruban avec aimant fixe
boîtier ABS antichoc bi-matières
Ruban en acier
Classe de précision : II

CE



	L m	S mm	CHF		
1691MG/5	5	25	19.00	1	016910405
1691MG/8	8	25	26.50	1	016910408
1691MG/10	10	25	28.00	1	016910410

1692

Mètre à ruban
boîtier ABS antichoc bi-matières
ruban en acier
classe de précision: II

CE



	L m	S mm	CHF		
1692/2	2	16	10.20	5	016920052
1692/3	3	16	12.80	5	016920053
1692/5	5	19	18.20	5	016920055
1692/8	8	25	26.00	5	016920058

1693

Appareil de mesure de distance laser
20 mètres

MESURES :

- mesure de distance simple
- mesure continue ou mesurage minimum

Arrêt automatique



CE
IP54

DONNÉES TECHNIQUES

Champ de mesure : de 0,05 à 20m (de 0.2ft à 66ft)

Sélection échelle : m, in, ft

Précision : ±1,5 mm (± 0.06 in)

Classe Laser : 2

Batteries : AAA 2 x 1.5V

	H mm	L mm	S mm	CHF		
1693 20	100	36	23	162.00	1	016930020

1693L

Télémètre laser multifonction,
40 m
avec niveaux de positionnement

MESURES :

- Mesure de distance
 - Mesure continue ou mesurage minimum
- FONCTIONS :
- Addition/soustraction
 - Mesure de surfaces
 - Mesure du volume
 - Mesure de variable indirecte (mesure de Pythagore)
 - Mesure de l'inclinaison

Arrêt automatique

Durée batterie: jusqu'à 5.000 mesures

Étui souple en toile (inclus)



CE
IP54

Données techniques :

• Champ de mesure : 0,05 + 40 m (0.2in + 131ft)

• Sélection échelle : m, in, ft

• Précision : ±1,5 mm (±0.06 in)

• Classe laser : 2

• Nbre de mesures mémorisables : 99

• Batteries : AAA 2 x 1.5V

	H mm	L mm	S mm	CHF		
1693L 40	115	50	25	196.50	1	016930040

1693M

Appareil de mesure de distance laser multifonction,
80 m

- MESURES :**
- mesure de distance simple
 - mesure continue ou mesurage minimum
- FONCTIONS :**
- addition/soustraction
 - mesure de la zone
 - mesure du volume
 - Mesure indirecte (mesure de Pythagore)
 - Mesure de l'inclinaison

Arrêt automatique
Étui souple en toile (inclus)
Durée batterie : jusqu'à 4.000 mesurages



CE
IP54

DONNÉES TECHNIQUES

Champ de mesure : de 0,05 à 80 m (de 0,2 pieds à 229 pieds)
Sélection échelle : m, pouces, pieds
Précision : $\pm 1,5$ mm ($\pm 0,06$ pouces)
Classe Laser : 2
Mémoire mesures : 99
Batteries : AAA 2 x 1,5 V

	H mm	L mm	S mm	CHF		
1693M 80	115	48	29	275.00	1	016930080

1694/L

Mesure longue à ruban
boîtier en ABS antichoc,
ruban en fibre de verre recouvert de PVC,
classe de précision III



	L m	S mm	CHF		
1694L10	10	13	17.00	1	016940110
1694L20	20	13	21.10	1	016940120

1694A/L

Mesure longue à ruban à poignée
boîtier en ABS antichoc
ruban en fibre de verre recouvert de PVC
classe de précision III



	L m	S mm	CHF		
1694A/L30	30	13	42.00	1	016940230
1694A/L50	50	13	55.00	1	016940250

1694B/L

Mesure longue à ruban
à poignée revolver corps en aluminium,
ruban en acier verni,
classe de précision II



	L m	S mm	CHF		
1694B/L50	50	12,5	84.50	1	016940350

1695XS

Niveau de poche avec base en "V"
magnétique en aluminium profilé
2 foies incassables
précision : 1 mm/m



	L mm	H mm	S mm	CHF		
1695XS	70	48,5	20	17.00	5	016950250

1696

Niveau tubulaire aluminium,
surfaces anodisées, avec foies
incassables, précision : 1 mm/m.



L mm	H mm	S mm	CHF		
200	50	19	28.50	2	016960002
400	50	19	33.00	2	016960004
500	50	19	36.00	2	016960005
600	50	19	38.50	2	016960006
800	50	19	47.50	2	016960008
1000	50	19	53.50	2	016960010

1696A

Niveau trapézoïdal corps en aluminium
moulé sous pression,
avec 1 semelle rectifiée
et 2 foies incassables, précision 1 mm/m



L mm	H mm	S mm	CHF		
300	43	23	41.00	2	016960103
400	43	23	43.50	2	016960104
500	43	23	47.00	2	016960105
600	43	23	51.50	2	016960106
1000	43	23	103.50	1	016960110

1696B

Niveau tubulaire aluminium avec semelle
magnétique
corps en profilé aluminium,
surfaces anodisées 2 foies incassables,
précision : 1 mm/m



L mm	H mm	S mm	CHF		
200	49	22	44.00	2	016960202
300	49	22	46.00	2	016960203
400	49	22	48.50	2	016960204
500	49	22	59.00	2	016960205
600	49	22	62.00	2	016960206

1696D

Niveau corps en aluminium moulé sous pression, avec 4 bases rectifiées et 3 fioles incassables, précision 1 mm/m



L	H	S	CHF		
mm	mm	mm			
300	47	25	38.50	2	016960353
400	47	25	43.50	2	016960354
500	47	25	47.00	2	016960355
600	47	25	53.50	2	016960356

1696S

Niveau de maçon corps en aluminium avec 2 fioles incassables, précision 1 mm/m



L	H	S	CHF		
mm	mm	mm			
1500	90	25	135.50	1	016960415
2000	90	25	162.00	1	016960420
2500	90	25	201.50	1	016960425
3000	90	25	227.50	1	016960430

1697

niveau laser croisé, 30 mètres, faisceau vert, avec base magnétique et support mural, en coffret

SPÉCIFICATIONS TECHNIQUES:

- croix auto-nivelante
- la fonction d'auto-nivellement peut être désactivée pour une utilisation manuelle
- diode laser 515 Nm, classe 2
- plage de travail: 30 m
- précision : ± 1 mm à 5 m
- plage d'auto-nivellement : $3^\circ \pm 0,5^\circ$
- corps en ABS et caoutchouc antidérapant
- Lecteur femelle 1/4 »
- 2 pilesXA
- autonomie de la batterie: 4 heures BASE:
- 1 base magnétique pour usage individuel et combiné, entraînement mâle 1/4 »
- 1 support de serrage réglable pour plusieurs profilés en bois et en métal (à utiliser en combinaison avec une base magnétique)
- alignement horizontal et vertical rapide à un angle de 90°

CE



IP55



H	L	S	CHF		
mm	mm	mm			
82	57	89,5	336.00	1	016970030

320x230x90 mm

1699L

Niveau droit de haute précision corps en fonte avec semelles rainurées en V rectifiées et 2 fioles incassables, précision = 0,05 mm/m



DIN 877

	L	A	CHF		
	mm	mm			
1699L	200	49	407.00	1	016990002

1699L/1

Niveau droit de haute précision corps en fonte avec semelles rainurées en V rectifiées et 2 fioles incassables, précision = 0,02 mm/m



DIN 877

	L	A	CHF		
	mm	mm			
1699L/1	200	49	433.00	1	016990005

1699Q

Niveau à cadre de précision corps en fonte, semelles rectifiées (2 rainurées en V et 2 planes) et 2 fioles incassables, précision = 0,05 mm/m



DIN 877

L	A	CHF		
mm	mm			
150	40	577.00	1	016990015
200	48	720.00	1	016990020

1700N

Broche de maçon



L	S	CHF		
mm	mm			
250	16	21.30	5	017000005
300	16	23.10	5	017000006

1700N/PM

Broche de maçon avec protecteur



L	S	CHF		
mm	mm			
250	16	28.50	2	017000105
300	16	33.50	2	017000106

1701N

Ciseau de maçon



L	A	S	CHF		
mm	mm	mm			
250	23	16	22.90	5	017010001
300	23	16	24.70	5	017010003

1701N/PM

Ciseau de maçon avec protecteur



L	A	S	CHF		
mm	mm	mm			
250	23	16	29.50	2	017010101
300	23	16	33.50	2	017010103

Beta

1701PMR

Protecteur pour 1700N et 1701N



D mm	L mm	CHF	🔧	📦
16	115	13.80	1	017010206

1701NE/...

Ciseau d'électricien



	SxL mm	CHF	🔧	📦
1701NE3	10x200	14.10	5	017010406
1701NE4	10x250	15.00	5	017010409

1702N

Burin large



A mm	SxH mm	CHF	🔧	📦
50	13x23	30.00	2	017020005
70	13x23	30.50	2	017020007

1702N/PM

Burin large avec protecteur



A mm	SxH mm	CHF	🔧	📦
50	13x23	36.50	2	017020105
70	13x23	40.50	2	017020107



Il est recommandé de refroidir fréquemment l'outil pendant le réaffûtage

1702PMR

Protecteur pour 1702N



L mm	CHF	🔧	📦
115	10.70	1	017020200

1704

Pince à décoffrer, à bords relevés

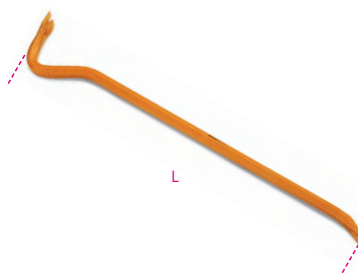

L mm	6 mm	M mm	mm	CHF	🔧	📦
500	16	35	28	38.50	2	017040050
600	16	34	26	43.50	2	017040060
800	18	38	29	60.50	2	017040080

1704A

Barres à mine avec bord plat et pointu trempés

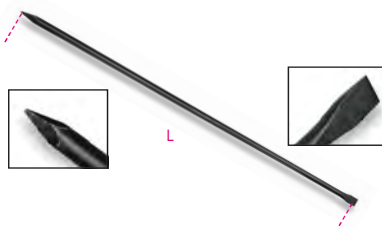

L mm	Ø mm	mm	CHF	🔧	📦
1500	25	45	130.00	1	017040110
2000	25	55	153.00	1	017040120

1704C

Pince à talon



L mm	8 mm	min-MAX mm	mm	CHF	🔧	📦
1200	21-31	39	131.50	1	017040210	
1400	31-37	42	157.50	1	017040212	
1600	25-37	42	195.50	1	017040215	

1705

Cordeau à tracer en aluminium



L m	CHF	🔧	📦
1705	26.00	4	017050001

1705PT

Poudre à tracer

- Récipient avec distributeur
- bleu



g	CHF	🔧	📦
250	16.60	5	017050025

1706DGT

Jauge de profondeur digitale pour le contrôle d'usure des pneus



1706DGT	CHF	🔧	📦
	48.50	1	017060011

1707

Jauges de filetage

Pour filets métriques ISO à 60° et Whitworth à 55°.



P (ISO)	W	CHF	🔧	📦
0,25+6	62÷4x1"	22.80	5	017070001

1707A/1-2-3

Jauges à rayons, lames concaves et convexes en acier

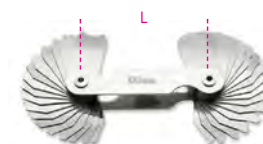

	R mm	L mm	n	CHF	🔧	📦
1707A/1	1,0÷7,0	70	34	34.50	2	017070007
1707A/2	7,5÷15	85	32	38.00	2	017070015
1707A/3	15,5÷25	85	30	38.00	2	017070025

1708/8 - 13 - 20

Jauges d'épaisseur



	CHF		
1708/8	8.70	5	017080008
S = 0,05÷0,50 mm			
1708/13	9.80	5	017080013
S = 0,05÷1,00 mm			
1708/20	15.90	5	017080020
S = 0,05÷1,00 mm			

1709/10 - 1709/18

Casse-écrous



	L mm	A max mm	CHF		
1709/10	82,5	17 (M10)	70.00	1	017090010
1709/18	107,8	24 (M16)	77.50	1	017090018

1710

Casse-écrous hydraulique



	C min mm	C max mm	CHF		
7(M4)	7(M4)	22(M14)	322.00	1	017100001

1712E/1 - 2 - 3

Doigt magnétique flexible

F = force magnétique



	L mm	D mm	F kg	CHF		
1712E/1	420	7,5	0,5	41.50	2	017120011
1712E/2	530	15	1,8	52.50	2	017120012
1712E/3	532	19	3,0	65.00	2	017120013

1712TF

Aimant télescopique avec tête flexible

• Avec nettoyeur pour gicleurs lave-verres
F= force magnétique



	L mm	D mm	F kg	CHF		
150÷590	150÷590	11	1	27.50	1	017120600

1713M

Doigt mécanique flexible à griffes

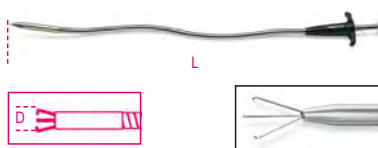

	L mm	D mm	CHF		
500	500	7	57.50	2	017130011
1000	1000	7	101.50	1	017130015

1713M/K7

Coffret avec 7 outils d'inspection

Coffret comprenant :

- 1 manche télescopique d'une longueur de 185 à 660 mm
- 1 miroir d'inspection rectangulaire 65x43 mm
- 1 miroir d'inspection rond de Ø 52 mm
- 1 aimant de Ø 16,3 mm
- 1 lumière LED ultra lumineuse
- 1 doigt mécanique flexible à griffes (réf 1713M)
- 1 bac de rangement magnétique en acier inoxydable
- 3 piles LR44



	CHF		
1713M/K7	204.50	1	017130100

297x165x52 mm - 0,8 kg

1714

Miroir d'inspection en plastique



	L mm	D mm	CHF		
1714	155	25	5.10	5	017140001

1715

Miroir d'inspection télescopique, montage en métal chromé



	L mm	D mm	CHF		
1715	180÷540	30	43.50	1	017150001

1715FL/A

Miroir d'inspection flexible carré



	L mm	A mm	B mm	CHF		
1715FL/A	600	53	90	52.00	1	017150110

1715R/FL

2 miroir d'inspection pour 1715FL/A et 1715FL/B

	CHF		
1715R/FL	11.00	1	017150151

1715FL/B

Miroir d'inspection flexible rectangulaire avec lampe

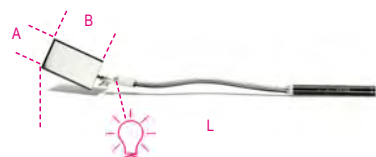

	L mm	A mm	B mm	CHF		
1715FL/B	553	53	90	62.00	1	017150115

1715B/R5L

Kit de 5 ampoule pour 1715FL/B

	CHF		
1715B/R5L	8.95	1	017150152

1715I

Miroir d'inspection télescopique articulé avec fonction grossissement 5x

- Poignée antidérapante en PVC
- Miroir d'inspection et poignée en acier inoxydable



	L mm	D mm	CHF		
1715I	250÷720	55	40.50	1	017150020

1715L

Miroir d'inspection télescopique télescopique avec lumière LED

- Corps en acier inoxydable
- Format de poche avec clip ceinture
- Fourni avec 3 piles de type L736F

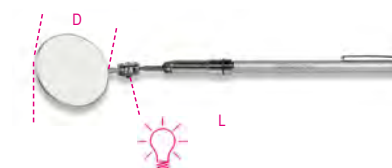

	L mm	D mm	CHF		
1715L	265÷765	50	63.00	1	017150005

1716A

Pointe coudée



	L mm	L1 mm	CHF		
1716A	240	125	14.90	3	017160040

1716P

Grattoir pour joints



L	L1	Ø	CHF	Icon	Icon
mm	mm	mm			
1716P	250	125	6	18.20	3 017160020

1716R

Pointe ronde



L	L1	Ø	CHF	Icon	Icon
mm	mm	mm			
1716R	215	100	6	12.80	5 017160001

1716U

Pointe à crochet

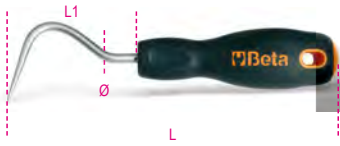

L	L1	Ø	CHF	Icon	Icon
mm	mm	mm			
1716U	195	80	6	14.90	3 017160025

1717A

Grattoir feuille de sauge



L	L1	L2	CHF	Icon	Icon
mm	mm	mm			
1717A	150	70	260	28.00	2 017170015
	200	75	310	30.00	2 017170020
	250	100	360	33.50	2 017170025

1717B

Grattoir triangulaire



L	L1	L2	CHF	Icon	Icon
mm	mm	mm			
1717B	150	75	260	24.30	2 017170115
	200	85	310	28.00	2 017170120
	250	100	360	31.50	2 017170125

1717C

Grattoir droit plat



L	S	L1	CHF	Icon	Icon
mm	mm	mm			
1717C	150	18	270	24.10	2 017170215
	200	20	320	27.00	2 017170220
	250	25	370	30.00	2 017170225

1717D

Grattoir droit plat à coupe frontale



L	S	L1	CHF	Icon	Icon	
mm	mm	mm				
1717D	150	150	23	240	33.00	2 017170320

1717T

Grattoir à lame triangulaire fourni avec 2 lames



L	CHF	Icon	Icon
mm			
1717T	310	15.40	1 017170610

1717T RT

Lame triangulaire de rechange



L	CHF	Icon	Icon
mm			
1717T RT	65	3.20	1 017170660

1717T RS

Lame façonnée de rechange



CHF	Icon	Icon
1717T RS	3.20	1 017170661

1717V

Grattoir pour vernis avec lame utilisable sur plusieurs côtés



L	A	CHF	Icon	Icon
mm	mm			
1717V	38	200	10.30	1 017170703
1717V	65	285	22.10	1 017170706

1717V R

Lame de rechange pour 1717V



L	A	CHF	Icon	Icon
mm	mm			
1717V R	38	3.20	1 017170753	
1717V R	65	4.55	1 017170756	

CUTTERS

RUGEUX

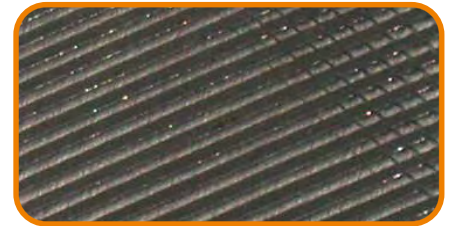

DEUXIEME COUPE



LISSE



1718D...Q

Lime carrée grossière, sans manche

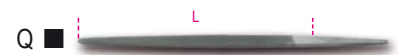

L	L	CHF	Icon	Icon
mm	"			
1718D6/Q	150	6	12.10	5 017180121
1718D8/Q	200	8	14.40	5 017180131
1718D10/Q	250	10	19.60	5 017180141

1718A...Q

Lime carrée demi-douce, sans manche

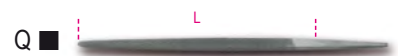

L	L	CHF	Icon	Icon
mm	"			
1718A6/Q	150	6	12.30	5 017180021
1718A8/Q	200	8	14.90	5 017180031
1718A10/Q	250	10	20.50	5 017180041

1718D...T

Lime triangulaire grossière, sans manche



	L mm	L "	CHF		
1718D6/T	150	6	14.50	5	017180123
1718D8/T	200	8	18.50	5	017180133
1718D10/T	250	10	24.40	5	017180143

1718A...T

Lime triangulaire demi-douce, sans manche



	L mm	L "	CHF		
1718A6/T	150	6	14.90	5	017180023
1718A8/T	200	8	19.00	5	017180033
1718A10/T	250	10	25.50	5	017180043

1718D...P

Lime plate grossière, sans manche



	L mm	L "	CHF		
1718D6/P	150	6	11.40	5	017180125
1718D8/P	200	8	13.40	5	017180135
1718D10/P	250	10	18.00	5	017180145

1718A...P

Lime plate demi-douce, sans manche



	L mm	L "	CHF		
1718A6/P	150	6	12.10	5	017180025
1718A8/P	200	8	13.90	5	017180035
1718A10/P	250	10	19.60	5	017180045

1718D...M

Lime demi-ronde grossière, sans manche



	L mm	L "	CHF		
1718D6/M	150	6	16.00	5	017180127
1718D8/M	200	8	19.70	5	017180137
1718D10/M	250	10	25.50	5	017180147

1718A...M

Lime demi-ronde demi-douce, sans manche



	L mm	L "	CHF		
1718A6/M	150	6	16.30	5	017180027
1718A8/M	200	8	20.20	5	017180037
1718A10/M	250	10	27.00	5	017180047

1718D...R

Lime ronde grossière, sans manche



	L mm	L "	CHF		
1718D6/R	150	6	11.40	5	017180129
1718D8/R	200	8	13.40	5	017180139
1718D10/R	250	10	17.60	5	017180149

1718A...R

Lime ronde demi-douce, sans manche



	L mm	L "	CHF		
1718A6/R	150	6	12.10	5	017180029
1718A8/R	200	8	13.90	5	017180039
1718A10/R	250	10	18.60	5	017180049

1718D...S5

Jeu de 5 limes grossières, sans manche



	L mm	L "	CHF		
1718D6/S5	150	6	65.00	1	017180130
1718D8/S5	200	8	79.50	1	017180140
1718D10/S5	250	10	105.50	1	017180150

1718A...S5

Jeu de 5 limes demi-douce, sans manche



	L mm	L "	CHF		
1718A6/S5	150	6	67.50	1	017180030
1718A8/S5	200	8	82.00	1	017180040
1718A10/S5	250	10	111.00	1	017180050

1719BMD...Q

Lime carrée grossière, avec manche



	L mm	L "	CHF		
1719BMD6/Q	150	6	16.50	5	017190191
1719BMD8/Q	200	8	18.20	5	017190221
1719BMD10/Q	250	10	25.00	5	017190241
1719BMD12/Q	300	12	33.00	3	017190325

1719BMA...Q

Lime carrée demi-douce, avec manche



	L mm	L "	CHF		
1719BMA6/Q	150	6	16.60	5	017190021
1719BMA8/Q	200	8	20.00	5	017190052
1719BMA10/Q	250	10	26.00	5	017190071
1719BMA12/Q	300	12	38.50	3	017190311

1719BMX...Q

Lime carrée douce, avec manche



	L mm	L "	CHF		
1719BMX6/Q	150	6	17.70	5	017190022
1719BMX8/Q	200	8	22.90	5	017190053
1719BMX10/Q	250	10	31.00	5	017190072

1719BMD...T

Lime triangulaire grossière, avec manche



	L mm	L "	CHF		
1719BMD6/T	150	6	19.70	5	017190193
1719BMD8/T	200	8	22.60	5	017190223
1719BMD10/T	250	10	30.50	5	017190243
1719BMD12/T	300	12	43.50	3	017190326

1719BMA...T

Lime triangulaire demi-douce, avec manche



	L mm	L "	CHF		
1719BMA6/T	150	6	19.70	5	017190023
1719BMA8/T	200	8	24.40	5	017190054
1719BMA10/T	250	10	31.50	5	017190073
1719BMA12/T	300	12	45.00	3	017190313

1719BMX...T

Lime triangulaire douce, avec manche



	L mm	L "	CHF		
1719BMX6/T	150	6	23.30	5	017190024
1719BMX8/T	200	8	30.50	5	017190055
1719BMX10/T	250	10	39.00	5	017190074

1719BMD...P

Lime plate grossière, avec manche



	L mm	L "	CHF	5	10
1719BMD6/P	150	6	16.50	5	017190195
1719BMD8/P	200	8	17.40	5	017190225
1719BMD10/P	250	10	24.60	5	017190245
1719BMD12/P	300	12	32.00	3	017190327

1719BMA...P

Lime plate demi-douce, avec manche



	L mm	L "	CHF	5	10
1719BMA6/P	150	6	17.40	5	017190025
1719BMA8/P	200	8	19.70	5	017190056
1719BMA10/P	250	10	25.50	5	017190075
1719BMA12/P	300	12	36.50	3	017190315

1719BMX...P

Lime plate douce, avec manche



	L mm	L "	CHF	5	10
1719BMX6/P	150	6	17.70	5	017190026
1719BMX8/P	200	8	23.30	5	017190057
1719BMX10/P	250	10	30.50	5	017190076

1719BMD...M

Lime demi-ronde grossière, avec manche



	L mm	L "	CHF	5	10
1719BMD6/M	150	6	21.70	5	017190197
1719BMD8/M	200	8	23.30	5	017190227
1719BMD10/M	250	10	31.50	5	017190247
1719BMD12/M	300	12	44.00	3	017190328

1719BMA...M

Lime demi-ronde demi-douce, avec manche



	L mm	L "	CHF	5	10
1719BMA6/M	150	6	22.60	5	017190027
1719BMA8/M	200	8	26.50	5	017190058
1719BMA10/M	250	10	34.00	5	017190077
1719BMA12/M	300	12	48.50	3	017190317

1719BMX...M

Lime demi-ronde douce, avec manche



	L mm	L "	CHF	5	10
1719BMX6/M	150	6	24.10	5	017190028
1719BMX8/M	200	8	29.50	5	017190059
1719BMX10/M	250	10	41.50	5	017190078

1719BMD...R

Lime ronde grossière, avec manche



	L mm	L "	CHF	5	10
1719BMD6/R	150	6	16.50	5	017190199
1719BMD8/R	200	8	17.10	5	017190229
1719BMD10/R	250	10	23.90	5	017190249
1719BMD12/R	300	12	31.50	3	017190329

1719BMA...R

Lime ronde demi-douce, avec manche



	L mm	L "	CHF	5	10
1719BMA6/R	150	6	17.50	5	017190029
1719BMA8/R	200	8	19.50	5	017190060
1719BMA10/R	250	10	24.80	5	017190079
1719BMA12/R	300	12	33.50	3	017190319

1719BMX...R

Lime ronde douce, avec manche



	L mm	L "	CHF	5	10
1719BMX6/R	150	6	20.20	5	017190031
1719BMX8/R	200	8	22.60	5	017190061
1719BMX10/R	250	10	30.50	5	017190081

1719BMA...B5

Jeu de 5 limes demi-douces, avec manche, en étui



	L mm	L "	CHF	5	10
1719BMA8/B5	200	8	109.50	1	017190297
1719BMA10/B5	250	10	142.00	1	017190298

1719BMD...B5

jeu de 5 limes grossières, avec manche, en étui



	L mm	L "	CHF	5	10
1719BMD8/B5	200	8	98.50	1	017190303
1719BMD10/B5	250	10	135.50	1	017190305

1719BMD...S5

Jeu de 5 limes grossières, avec manche

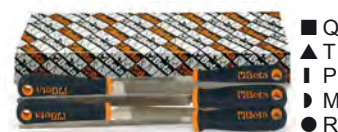

	L mm	L "	CHF	5	10
1719BMD6/S5	150	6	91.00	1	017190200
1719BMD8/S5	200	8	98.50	1	017190230
1719BMD10/S5	250	10	135.50	1	017190250
1719BMD12/S5	300	12	184.00	1	017190363

1719BMA...S5

Jeu de 5 limes demi-douces, avec manche



	L mm	L "	CHF	5	10
1719BMA6/S5	150	6	93.50	1	017190030
1719BMA8/S5	200	8	109.50	1	017190070
1719BMA10/S5	250	10	142.00	1	017190080
1719BMA12/S5	300	12	202.00	1	017190361

1719BMX...S5

Jeu de 5 limes douces, avec manche



	L mm	L "	CHF	5	10
1719BMX6/S5	150	6	103.00	1	017190032
1719BMX8/S5	200	8	129.00	1	017190069
1719BMX10/S5	250	10	172.50	1	017190082

1719BMB/P

Limes plates aluminium
manche en matériau plastique



L mm	L mm	CHF		
250	10	39.00	5	017190152
300	12	46.00	5	017190153

1719BMC

Limes demi-rondes et plates d'entrée
manche en matériau plastique



UNI 5569 - UNI 5568

L mm	L mm	CHF		
1719BMC/M 250	250 10	26.00	6	017190252
1719BMC/M 300	300 12	33.00	4	017190253
1719BMC/P 250	250 10	20.60	6	017190262
1719BMC/P 300	300 12	25.50	4	017190263

1719BM/RL

Râpe plate
1 côté râpe seconde coupe, 1 côté lime rugueuse
avec manche bi-matière antidérapant



L mm	L mm	CHF		
1719BM/RL	200 8	20.60	5	017190360

1719BM/RR

Râpe ronde avec manche bi-matière
antidérapant



L mm	L mm	CHF		
1719BM/RR	200 8	21.60	5	017190351

1719BM/RG

Râpe demi-ronde avec poignée ergonomique
en plastique



L mm	L mm	CHF		
200	8	21.30	5	017190353

1719BM/RP

Râpe plate avec poignée ergonomique en
plastique



L mm	L mm	CHF		
200	8	22.00	5	017190352

1719BMR/B3

Blister de 3 râpes avec poignées
ergonomiques en plastique



L mm	L mm	CHF		
200	8	65.00	1	017190358

1719BMR

Manche de rechange pour limes



	L mm	A mm	CHF		
1719BMR/0	95	25	4.70	10	017190950
1719BMR/0B	110	29	4.70	10	017190955
1719BMR/1	110	29	4.70	10	017190951
1719BMR/1B	110	29	4.70	10	017190953
1719BMR/2	123	31	4.70	10	017190952
1719BMR/2B	123	31	4.70	10	017190954

	mm	"		
1719BMR/0	100/150	4/6	▲▲	▶▶
1719BMR/0B	100/150	6/8	■●	■●
1719BMR/1	150/200	6/8	▲▲	▶▶
1719BMR/1B	150/200	6/8	■●	■●
1719BMR/2	250/300	10/12	▲▲	▶▶
1719BMR/2B	250/300	10/12	■●	■●



1720/...

Lime semi-douce,
tige Ø 3 mm

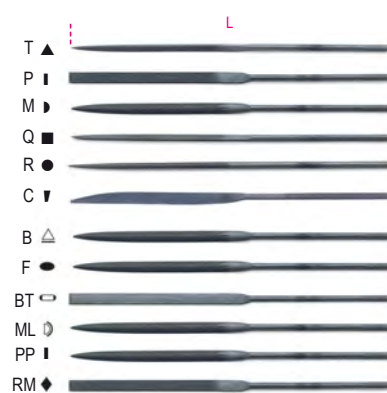

UNI 5569 UNI 5670

	L mm	CHF		
1720T	160	9.50	5	017200004
1720P	160	9.50	5	017200006
1720M	160	9.50	5	017200008
1720Q	160	9.50	5	017200009
1720R	160	9.50	5	017200010
1720C	160	9.50	5	017200012
1720B	160	9.50	5	017200005
1720ML	160	9.50	5	017200007
1720BT	160	9.50	5	017200011
1720F	160	9.50	5	017200013
1720PP	160	9.50	5	017200014
1720RM	160	9.50	5	017200015



	CHF		
1720/S3	28.50	1	017200000

1720/B

trousse de 6 limes semi-douce



	CHF		
1720/B6	59.50	1	017200002
1720/B12	114.00	1	017200003

1720D/...

Lime diamantée,
grain D126



	L mm	CHF		
1720D/T	160	61.50	2	017200104
1720D/P	160	61.50	2	017200106
1720D/M	160	61.50	2	017200108
1720D/Q	160	61.50	2	017200109
1720D/R	160	61.50	2	017200110
1720D/C	160	61.50	2	017200112



1720D/B6 **CHF** 371.00 1 017200120

1721/B6

Jeu de 6 limes pour contacts



1721/B6 **CHF** 31.50 1 017210010

1723

Tire-ressorts



1723 **CHF** 20.60 5 017230001

1725

Monture de scie à métaux avec lame



1725 **CHF** 28.50 4 017250001

1725CR

Monture de scie de précision en aluminium



1725CR **CHF** 15.50 5 017250010

1726

Monture de scie à métaux avec système de tension de lame intégré



1726 **CHF** 38.00 4 017260001

1726BM

Monture de scie à métaux avec système de tension de la lame à déclenchement

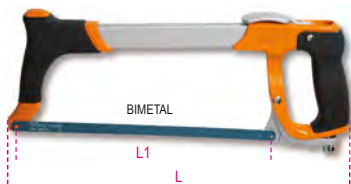

1726BM **CHF** 60.50 1 017260050

1727

Monture de scie à métaux type soudeur avec lame

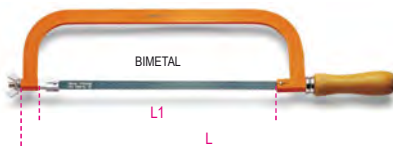

1727 **CHF** 26.00 4 017270001

1727BM

Monture de scie à métaux monobloc



1727BM **CHF** 31.50 5 017270020

1728...

Lame de scie



1728LA **CHF** 1.85 100 017280001

1725CR 1725MQ **CHF** 4.65 100 017280010

1728BM 1725-1726 1727-1727M **CHF** 6.45 50 017280030

1728CO 1725-1726 1727-1727M

1729CG

Monture de scie pour placoplâtre



1729CG **CHF** 31.00 2 017290200

1729DM 450

Scie égoïne à bois

denture moyenne, 12 dents par pouce



1729DM 450 **CHF** 35.50 4 017290450

1730

Spatule universelle avec lame en acier inoxydable et manche



S mm	L mm	L1 mm	CHF		
38	210	85	7.90	2	017300038
63	220	95	9.35	2	017300063
75	220	95	10.20	2	017300075
100	220	95	11.70	2	017300100

1730M

Spatule pour mélangeurs avec lame en acier inoxydable et manche



L1 mm	L mm	S mm	CHF		
150	245	27	11.00	2	017300215
200	330	28	20.50	2	017300220
250	365	36	25.50	2	017300225

1730V 38

Spatule pour vitriers avec lame à couteau en acier inoxydable



1730V 38 **CHF** 7.90 2 017300338

1736A

Carde à lime fils d'acier inoxydable Ø fil 0,5 mm



1736A **CHF** 14.30 10 017360010

1737

Brosse à bougies en fils de cuivre ondulé,
Ø fil 0,2 mm



1737	L mm 145	CHF 6.95	10	017370001
------	----------------	-------------	----	-----------

1737NX

Brosse métallique en fils d'acier cuivré,
Ø fil 0,3 mm



1737NX	L mm 270	CHF 8.30	5	017370010
--------	----------------	-------------	---	-----------

1737AC

Brosse métallique en fils d'acier
à 5 rangées,
Ø fil 0,3 mm



1737AC	L mm 275	CHF 7.95	5	017370020
--------	----------------	-------------	---	-----------

1737B

Paire de nettoyeurs
de cosse et bornes
de batterie
fils en acier
Ø fil 0,3 mm



1737B	CHF 19.50	1	017370050
-------	--------------	---	-----------

1738

Pinceau de nettoyage



1738	L mm 210	H mm 30	CHF 11.40	10	017380001
------	----------------	---------------	--------------	----	-----------

1739C

Pince à riveter à extenseur comprenant 5
embouts interchangeables



Ø mm	3,2	4	4,8	5	6	6,4
Aluminium
Acier Inoxydable

1739C	L max mm 810	CHF 165.50	1	017390152
-------	--------------------	---------------	---	-----------

1740AN

Pincettes à riveter 2 bras comprenant 5 embouts
interchangeables
• livrée avec réservoir de récupération



Ø mm	3,2	4	4,8	5	6	6,4
Aluminium
Acier Inoxydable

1740AN	L mm 530	CHF 150.50	1	017400103
--------	----------------	---------------	---	-----------

1740B

Pince à riveter gros effort compacte



Ø mm	2,4	3	3,2	3,2	4,8
Aluminium
Acier inox
Inox

1740B 280	L mm 280	CHF 97.50	1	017400280
-----------	----------------	--------------	---	-----------

Ø mm	2,4	3,2	4,0	4,8	6,4
Aluminium
Acier inox
Inox

1740B 330	L mm 330	CHF 113.00	1	017400330
-----------	----------------	---------------	---	-----------

1741B

Pince à riveter
avec 4 embouts



Ø mm	2,4	3,2	4	4,8	5
Aluminium
Acier
Inox

1741B	CHF 51.50	1	017410000
-------	--------------	---	-----------

1741B/C5

Pince à riveter 1741B avec assortiment
de 700 rivets en aluminium



1741B/C5	CHF 159.50	1	017410025
----------	---------------	---	-----------

	Ø mm	L mm	n.
1741RV2,9K	3,0	6	200
1741RV3,2K	3,2	8	200
1741RV3,8K	4,0	10	100
1741RV4K	4,0	12	100
1741RV4,8K	4,8	12	100

415x155x60 mm - 3,1 Kg



1741BP

Pince à riveter avec 4 embouts



Ø mm	2,4	3,2	4	4,8	5
Aluminium	•	•	•	•	•
Acier	•	•	•	•	•
Inox	•	•	•	•	•

1741BP CHF 78.50 1 017410350

1741U

Pince à riveter ultra compacte avec réglage de l'effort avec 4 embouts
3 griffes : meilleure prise du rivet



Ø mm	2,4	3	3,2	4	4,8
Aluminium	•	•	•	•	•
Acier	•	•	•	•	•
Acier inoxydable	•	•	•	•	•

1741U CHF 60.50 1 017410450

1741RV...K

Rivets en aluminium



1741RV 2,9K	CHF 26.00	1 017410191
ØxL = 3x6 mm		
1741RV 3,2K	CHF 26.50	1 017410192
ØxL = 3,2x8 mm		
1741RV 3,8K	CHF 33.50	1 017410193
ØxL = 4x10 mm		
1741RV 4K	CHF 36.50	1 017410194
ØxL = 4x12 mm		
1741RV 4,8K	CHF 45.00	1 017410195
ØxL = 4,8x12 mm		

Les prix indiqués sont pour 500 pièces

1742N

Pince à inserts filetés comprenant 4 embouts et mandrins interchangeables (M3;M4;M5;M6)



1742N CHF 170.50 1 017420002

	Ø mm	L mm
3	5	11
4	6	11
5	7	13
6	9	17

1742N/KR

kit de recharge comprenant 4 mandrins filetés pour la pince à insert 1742N



M3	CHF 73.00	1 017420063
M4	CHF 73.00	1 017420064
M5	CHF 73.00	1 017420065
M6	CHF 73.00	1 017420066

1742R-AL/M...

Rivets filetés en aluminium pour 1742-1742A-1946KF



1742R-AL M3	CHF 6.40	1 017420023
ØxL = 5x10 mm		
M = 3		
1742R-AL M4	CHF 6.50	1 017420024
ØxL = 6x12 mm		
M = 4		
1742R-AL M5	CHF 7.00	1 017420025
ØxL = 7x13 mm		
M = 5		
1742R-AL M6	CHF 8.50	1 017420026
ØxL = 9x15 mm		
M = 6		

Les prix indiqués sont pour 20 pièces

1742R-A/M...

Rivets filetés en acier pour 1742-1742A-1946KF



1742R-A M3	CHF 6.75	1 017420013
ØxL = 5x11 mm		
M = 3		
1742R-A M4	CHF 6.90	1 017420014
ØxL = 6x11 mm		
M = 4		
1742R-A M5	CHF 7.25	1 017420015
ØxL = 7x13 mm		
M = 5		
1742R-A M6	CHF 8.70	1 017420016
ØxL = 9x17 mm		
M = 6		
1742R-A M8	CHF 8.25	1 017420018
ØxL = 11x17 mm		
M = 8		
1742R-A M10	CHF 9.85	1 017420020
ØxL = 13x24 mm		
M = 10		
1742R-A M12	CHF 11.10	1 017420022
ØxL = 12x24 mm		
M = 12		

Les prix indiqués sont pour 20 pièces
• Les prix indiqués sont pour 10 pièces

1742N/C4

Pince à inserts filetés 1742N avec assortiment de 400 inserts filetés en acier



1742N/C4 CHF 382.00 1 017420006

	M	Ø mm	n.
1742R-A/M3	3	5	100
1742R-A/M4	4	6	100
1742R-A/M5	5	7	100
1742R-A/M6	6	9	100

415x155x60 mm - 2,9 kg

1742AN

Pince à inserts filetés 2 bras comprenant 7 embouts interchangeables



1742AN CHF 539.00 1 017420101

M	Ø mm	L mm
5	7	13
6	9	17
8	11	17
10	13	24

1742AN/KR

kit de rechange comprenant 4 mandrins filetés pour la pince à insert 1742AN



		CHF		
1742AN/KR M3	M3	49.50	1	017420153
1742AN/KR M4	M4	49.50	1	017420154
1742AN/KR M5	M5	49.50	1	017420155
1742AN/KR M6	M6	49.50	1	017420156
1742AN/KR M8	M8	49.50	1	017420158
1742AN/KR M10	M10	49.50	1	017420160
1742AN/KR M12	M12	49.50	1	017420162

1742AN/C

Pince à insert filetés 2 bras 1742AN avec assortiment de 80 inserts filetés en acier



	CHF		
1742AN/C	627.00	1	017420106

	M	∅ mm	n.
1742R-A/M5	5	7	20
1742R-A/M6	6	9	20
1742R-A/M8	8	11	10
1742R-A/M10	10	13	10

420x240x80 mm - 2,5 kg

1749

Pistolet à silicone modèle standard, tôle laquée



	L min mm	CHF		
1749	340	18.20	2	017490001

1749A

Pistolet à silicone modèle professionnel, tube en aluminium



	L min mm	CHF		
1749A	360	57.00	1	017490010

1749A/RB

Bec verseur pour 1749A

	CHF		
1749A/RB	1.32	1	017490051

1749A/RT

Bouchon frontal vissable pour 1749A

	CHF		
1749A/RT	2.89	1	017490052

1749AC

Pistolet à haute poussée pour scellants chimiques



	L min mm	CHF		
1749AC	360	51.00	1	017490005

1750

Pompe à graisse à levier

Utilisable avec cartouches 1750CG ou graisse en vrac



1 g, 550 bar Max

1750CG cc	L mm	CHF		
400	380	56.50	1	017500500
600	450	66.50	1	017500750

1750R/1 - 1750R/2

Flexible pour 1750



	L mm	CHF		
1750R/1	310	8.95	2	017500030
1750R/2	410	9.90	2	017500040

1750RC

Bec rigide coudé pour 1750



	L mm	M mm	CHF		
1750RC	150	10x1	7.30	2	017500050

1750RT

Raccord à griffes pour 1750



	M mm	CHF		
1750RT	10x1	6.60	5	017500110

1750RP/1 - 1750RP/2

Raccord plat pour 1750



	∅ mm	M mm	CHF		
1750RP/1	16	10x1	16.30	2	017500115
1750RP/2	22	10x1	36.50	2	017500120

1750CG

Cartouche de graisse pour 1750



cc	CHF		
400	19.80	18	017500140
600	24.80	18	017500160

1750KG10

Pompe à graisse à levier de 10 kg, avec tuyau à haute pression de 2 m

Dotée d'un raccord pivotant pour ne pas étrangler le tuyau
Corps de pompage en aluminium moulé sous pression avec soupape de déchargement

3 niveaux différents de pression réglables :
-4 g à 275 bars
-7 g à 206 bars
-9 g à 137 bars



1750KG10 CHF 254.00 1 017500100

1750TA

Tête autobloquante à 6 broches pour graissage à haute pression

Une fois positionnée, elle reste sur le graisseur sans aucune aide.

Déconnexion facile même avec tête sous pression

Filet M10x1 : adapté à tous les types de pompe à graisse :

électrique, pneumatique, manuelle etc.
Aucune déformation jusqu'à 550 bars



1750TA CHF 59.50 1 017500111

1750TLA

Tête autobloquante à 6 broches pour graissage, version longue

• Une fois positionnée, elle reste sur le graisseur sans aucune aide

• Déconnexion facile même avec tête sous pression

• Filet M10x1 : adapté à tous les types de pompe à graisse :

électrique, pneumatique, manuelle etc.

• Aucune déformation jusqu'à 550 bars



1750TLA CHF 80.00 1 017500112

1750M

Mini pompe à graisse

• Avec micro-buse

• Particulièrement indiqué pour les outils pneumatiques



1750M cc D mm L mm CHF 1 017500025

cc	D mm	L mm	CHF	Qty	Part No.
100	43	145	29.50	1	017500025

1750M3

Mini pistolet graisseur avec 3 buses

• Equipé de 3 buses interchangeables : 0,7 - 1,0 - 1,4 mm

• Fortement conseillé pour la lubrification des outils pneumatiques

• Peut être utilisé avec de la graisse en vrac.

• Peut être utilisé avec de la graisse allant jusqu'au grade NLGI 2



1750M3 cc Ø mm L mm CHF 1 017500003

cc	Ø mm	L mm	CHF	Qty	Part No.
85	42	160	39.00	1	017500003

1751CR

Burettes métalliques sous pression avec embouts rigides



1751CR cc D mm L mm CHF 1 017510202

cc	D mm	L mm	CHF	Qty	Part No.
200	62	140	20.10	4	017510202
300	75	140	21.70	4	017510203
500	85	140	23.10	4	017510205
700	100	140	25.00	2	017510207
1000	100	140	27.50	2	017510210

1751N

Burette tôle sous pression à embout flexible



1751N cc D mm L mm CHF 1 017510020

cc	D mm	L mm	CHF	Qty	Part No.
200	62	140	21.20	4	017510020
300	75	140	23.10	4	017510030
500	85	140	24.20	4	017510050
700	100	140	26.00	2	017510075
1000	100	140	28.50	2	017510100

1752

Burette plastique sous pression à embout rigide



1752 cc D mm L mm CHF 1 017520002

cc	D mm	L mm	CHF	Qty	Part No.
200	67	140	13.80	4	017520002
300	77	140	14.90	4	017520003
500	95	140	15.60	4	017520005

1754

Burette plastique à embout flexible



1754 cc D mm L mm CHF 1 017540015

cc	D mm	L mm	CHF	Qty	Part No.
150	60	130	12.50	5	017540015
250	65	130	14.10	5	017540025

1755C

Burettes plastique avec embouts rigides inclinés



cc	L mm	A mm	CHF		
125	110	46	5.70	5	017550112
250	110	60	7.80	5	017550125
500	110	74	8.85	4	017550150

1756

Burette stylo

Convient pour une utilisation avec des huiles minérales



cc	L mm	CHF		
5	140	30.00	2	017560001

1756B

Seringue à huile

- Avec rainurage antidérapant
- Température de fonctionnement : -10 °C ÷ +60 °C
- Densité d'huile minimale SAE 10



cc	L mm	CHF		
500	280	29.00	2	017560220

1756C

Seringue à huile de 200 ml en polypropylène

- Également adaptée au liquide du système de freinage
- Double joint en EPDM
- Température de fonctionnement : +0 °C ÷ +50 °C
- Non adaptée aux carburants et huiles minérales
- La densité d'huile minimale utilisable est ISO 150, SAE 90 (huile pour engrenages), SAE 40 (huile moteur)



1756C	CHF		
	45.00	1	017560502

1756D

Seringue à huile de 1500 ml en polypropylène

- Double joint en NBR
- Température de fonctionnement : +0 - +50 °C
- NON adaptée aux carburants

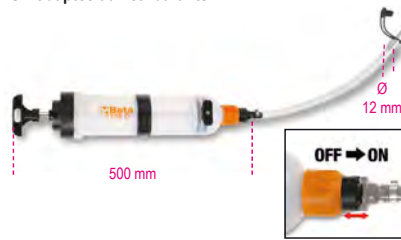

1756D	CHF		
	103.50	1	017560515

1756E

Pompe à siphonner carburants



1756E	CHF		
	53.50	1	017560610

1756G

Seringue pour moteurs diesel capacité 1,5 l pour branchement aux tuyaux diesel

- Utilisable pour :
- remplissage filtres diesel
 - remplissage réservoir cérine



- Le kit comprend :
- 2 tuyaux avec attache rapide femelle pour branchement tuyau diesel
 - 2 attaches rapides mâle en métal
 - 1 adaptateur conique pour tuyaux caoutchouc

1756G	CHF		
	158.50	1	017560615

1756C-20R

Couple de joints toriques pour seringues 1756C

1756C-20R	CHF		
	5.90	1	017560503

1756D-20R

Couple de joints toriques pour seringues 1756D

1756D-20R	CHF		
	9.80	1	017560516

1757

Flacon de remplissage pour batterie



cc	D mm	CHF		
250	60	4.65	4	017570002
500	75	5.65	4	017570004
1000	90	7.75	2	017570006

1757A

Flacon avec bec verseur pour liquide de batterie



cc	CHF		
2000	57.00	1	017570020

1758

Entonnoir auto-ajustable

Particulièrement utile pour les autos sans profondeur au niveau du bouchon de remplissage d'huile moteur



1758	CHF		
	71.50	1	017580020

1758ADB-D

Entonnoir et anti-retour pour AdBlue



1758 ADB-D	CHF		
	46.00	1	017580050

1758ADB-45°

Entonnoir avec accouplement à 45° et anti-retour pour AdBlue®



1758 ADB-45 Max 1 CHF 49.00 1 017580060

1758A

Entonnoir anti-retour avec attache rapide Ø 38 mm
Pour automobiles du groupe Volkswagen



1758A CHF 109.50 1 017580010

1758B

Entonnoir anti-retour avec attache rapide
Particulièrement indiqué pour les automobiles du groupe VAG



1758B CHF 47.50 1 017580030

1758B-1,6

Entonnoir anti-retour de 1600 ml avec attache rapide

Attache rapide pour les automobiles de groupe VAG



	H1	H2	Ø	CHF		
	mm	mm	mm			
1758B-1,6	125	100	155	53.50	1	017580033

1758B-RNT

Coupleur rapide anti-reflux pour entonnoir 1758B - 1758B-1,6

Pour moteur Renault 1,5 dCi



1758B-RNT CHF 34.00 1 017580035

1758B/K5

kit d'adaptateurs d'accouplement rapide sans retour, pour entonnoir 1758B - 1758B-1,6

Contenu du kit :

- 1 adaptateur pour moteurs Renault, Dacia, Nissan 1,5 dCi
- 1 adaptateur pour moteurs Renault, Dacia, Nissan 1.5/1.6 dCi
- 1 adaptateur pour moteurs diesel BMW 3.0
- 1 adaptateur pour moteurs essence 1.5/2.0, groupe VAG
- 1 adaptateur de connexion pour entonnoir, avec robinet



1758B/K5 CHF 135.50 1 017580040

1758RD

Entonnoir avec raccords rapides



H mm 248 Ø mm 172 CHF 147.50 1 017580070

1758S

Support mural pour le rangement des entonneurs 1758 et leurs accessoires



1758S CHF 110.50 1 017580080

1758LG

Plaque modulaire en aluminium revêtue de caoutchouc, pour la canalisation des liquides



L mm 365 H mm 168 CHF 60.50 1 017580006

1758M

Entonnoir



1758M L mm 350 CHF 18.00 1 017580000

1758R

Récipient pour liquides

Bec flexible pratique extractible



	lit	CHF		
1758R 1	1	11.30	1	017580201
1758R 2	2	13.50	1	017580202
1758R 3	3	24.10	1	017580203
1758R 5	5	29.00	1	017580205

1758VT

Kit pour le contrôle des têtes

Signale rapidement l'éventuelle présence d'anhydride de carbone dans la cuve d'expansion



1758VT	CHF			
	231.00	1	017580100	

290x190x50 mm - 1 kg

1758VT/L

Liquide de contraste pour le contrôle des têtes



1758VT/L	CHF			
	66.50	1	017580101	

1759

Analyseur optique pour liquides de refroidissement, batterie, lave-vitres et AdBlue®

En étui rigide

Compensation automatique de la température

Acide batterie : intervalle de mesure

de 1,1 à 1,3 kg/l

Liquide de refroidissement propylène :

de -25 °C à -50 °C

Liquide de refroidissement éthylène : de -25 °C à -50 °C

Liquide lave-vitres : de -25 °C à -40 °C

AdBlue : Mesure d'urée en pourcentage de 30% à 45%



1759	CHF			
	214.00	1	017590251	

1759A

Pèse-antigel



1759A	L mm	CHF		
	340	90.00	1	017590001

1759B

Pèse-acides



1759B	L mm	CHF		
	280	59.00	1	017590005

1759HD/3

Outil pour le contrôle de l'étanchéité de l'installation de refroidissement et remplissage du circuit (outil de contrôle d'étanchéité et de remplissage du circuit de refroidissement)

• Permet de vérifier sous pression les pertes de charge (tuyaux, raccords, pompes, radiateurs) et de remplir rapidement le circuit afin d'éviter la formation de bulles d'air



1759HD/3	CHF			
	754.00	1	017590063	

600x500x140 mm - 6,5 kg

1759HD/RR

Outil pour remplissage du circuit de refroidissement



1759HD/RR	CHF			
	231.00	1	017590064	

450x310x110 mm - 2,2 kg



1759LR

Outil de lavage des systèmes de refroidissement

grâce à l'air comprimé, le système de haute pression de l'eau permet un lavage efficace du système de refroidissement

- 6 adaptateurs pour connexion avec installation
- Levier de commande avec verrouillage de position pour une utilisation continue
- Raccord rapide eau inclus



1759LR L mm CHF 579.00 1 017590070
390X330X100

1759HD/TRUCK

Coffret de testeur de pression de liquide de refroidissement des poids-lourds



1759HD/TRUCK CHF 525.00 1 017590065
440x330x100 mm - 1,3 kg

1759TT

Kit de 4 paires de bouchons pour le contrôle des circuits turbo - utilisable avec pistolet de gonflage de pneus



1759TT CHF 278.00 1 017590300
400x160x100 mm - 1,8 kg

CERTIFICATION D'INSTRUMENTS DE MESURE ÉLECTRONIQUES

La certification d'instruments de mesure électroniques tels que les multimètres, les pinces ampèremétriques, les tachymètres et les thermomètres sont essentiels dans les secteurs où les domaines d'application requièrent des mesures précises et non ambiguës.

Pour les thermomètres infrarouges, un rapport d'étalonnage en 4 points (minimum, maximum et deux points intermédiaires) avec traçabilité ENAC est délivré.

Sur demande, Beta Utensili S.p.A. fournit le service de certification. Pour bénéficier de ce service, veuillez contacter votre revendeur.

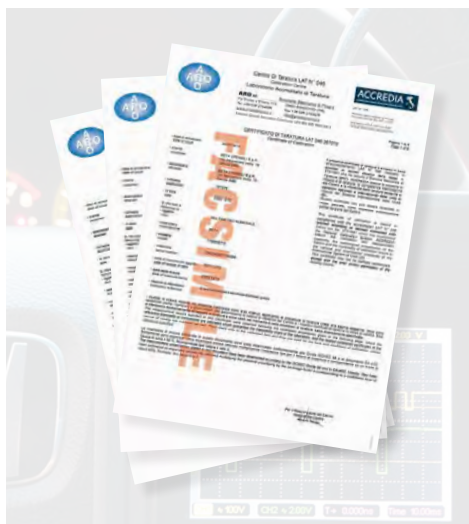

1760DGT

Multimètre numérique automobile

CE



195 mm



92 mm

CARACTÉRISTIQUES TECHNIQUES

RPM (tachymètre):
 Pour moteurs à 2 et 4 cylindres
 RPM4 600 - 4000 RPM
 RPM4 600 - 12000 RPM (x10 RPM)
 RPM2/DIS 300 - 4000 RPM
 RPM2/DIS 300 - 6000 RPM (x10 RPM)
 Angle Dwell: 4-8 CYL
 Tension c.c. : 400mV-4/40/400/1000V
 Tension a.c. : 4/40/400/700V
 Courant c.c. : 40/400mA-4/20A
 Courant a.c. : 40/400mA-4/20A
 Résistance : 400Ω-4/40/400kΩ-4/40MΩ
 Capacité : 40/400nF-4/40/100μF
 Fréquence : 5/50/500Hz-50/500-10MHz
 Duty Cycle : 0.1 - 99.9%
 Amplitude pulsations : 1 - 10ms
 Essai diodes : courant test 0,3mA
 Continuité : <150Ω - courant test <0,3mA
 Display : LCD à contraste élevé 4 digits, rétroéclairé
 Surtension : catégorie II 1000 V
 Auto-extinction : 30 minutes
 Alimentation : 1 pile 9V (fournie)
 Pince inductive (fournie)
 2 embouts (fournis)
 Étui souple en toile (fournie)
 Manuel d'utilisation

1760DGT CHF 353.00 1 017600005



Beta

1760DGT/2

Multimètre numérique automobile portable avec oscilloscope à 2 canaux et générateur d'onde



LE KIT COMPREND :

- embouts multimètre
- 2 connecteurs pince crocodile BNC pour oscilloscope
- sonde à embout pour oscilloscope (1X et 10X)
- chargeur de batterie
- étui en nylon

DONNÉES TECHNIQUES

Écran : TFT en couleurs de 2,8"
Résolution : 320 x 240 pixels
Alimentation : 100V-240V AC, 50Hz-60Hz ; DC INPUT 5V DC-2A
Batterie : 2 x 2600 mAh

SPÉCIFICATIONS MULTIMÈTRE

Test : Tension, Courant, Résistance, Capacité, Diodes et On-Off
Tension max. : 600V AC-DC
Courant max. : 10A AC-DC
Résistance max. : 40MOHM
Capacité max. : 100uF

SPÉCIFICATIONS OSCILLOSCOPE

Horizontal
Largeur bande : 40MHz
Intervalle de fréquence échantillon : 250MSa/s (canal simple)
- 125MSa/s (double canal)
Gamme SEC/DIV : 5ns/div ÷ 500s/div 1,2,5 séquence
Verticale
Gamme VOLTS/DIV : 10mV/div ÷ 10V/div entrée BNC
Analogique sélectionnable limite largeur de bande, typique : 20MHz
Réponse à basse fréquence (-3db) : ≤10Hz à BNC
DC Précision : ± 3% pour la modalité d'acquisition Normale ou Moyenne, de 10V/div à 10 mV/div
Trigger
Type : Edge
Mode : Auto, Normal, Single
Slope : Rising, Falling, Rising, & Falling
Source : CH1, CH2
Entrée
Accouplement : DC, AC ou GND
Facteurs d'alimentation de la sonde supportés : 1X, 10X, 100X, 1000X
Générateur de forme d'onde arbitraire
Fréquence forme d'onde : Sine (1Hz÷25MHz), Square (1Hz÷10MHz), Ramp (1Hz÷1MHz), EXP (1Hz÷5MHz)
Amplitude : 2.5Vpp (50Ω) - 5Vpp (haute impédance)
Impédance de sortie : 50Ω

Dimensions : 199 x 98 x 40 mm
Poids : 624 g

CHF 986.00 1 017600008

1760B

Multimètre digital



SPÉCIFICATIONS

Tension CC : 200 mV-2/20/200/1000V
Tension CA : 2-20/200/700V
Courant CC : 2/20/200 mA-20 A
Courant CA : 2/200 mA- 20 A
Résistance : 200Ω - 2/20/200 kΩ - 2/20 MΩ
Capacité : 2/20/200 nF - 2/200 μF
Température : -20° + 1000°C/ -4 °F ~ +2000°F
Fréquence : 20kHz
Alimentation : 1 pile 9 V (fournie)

1760B **CHF** 228.00 1 017600012

1760/OHM

Multimètre/mégohmmètre pour test isolation à haute tension

Lecture à valeur efficace TRUE RMS



CE
CAT. IV
600V
CAT. III
1000V

Plage de mesure Précision de base
Tension AC/DC : 50mV - 1000V ±0.06% - ±0.1% rdg
Courant AC/DC : 0.01μA - 10A ±0.5% - ±1% rdg
Résistance : 0.01Ω - 50MΩ ±0.2% - ±2% rdg
Meg OHM : 0.01 - 5000MΩ ±4% rdg. max current
1mA
Capacité : 5nF - 10mF ±1.5% - ±3% rdg
Fréquence : 50Hz - 100 MHz ±0.02% - ±0.1% rdg
Température : -50°C - +1350°C ±0.5% rdg
Test diodes : 3V dc
Test continuité : <30 Ω

1760/OHM **CHF** 1,081.00 1 017600025

1760/RMS

Multimètre industriel IP67

avec lecture en valeur efficace RMS

EN61010-1
EN61326-1



Plage de mesure Précision de base
Tension CA/CC 110mV - 600V ±0.8% - ±2% rdg
Courant CA/CC 110μA - 10A ±1.5% - ±2% rdg
Résistance 110Ω - 40MΩ ±1.2% - ±2.5% rdg
Capacité 11nF - 40mF ±5% - ±10% rdg (jusqu'à 11mF)
Fréquence 1100Hz - 110 MHz ±1.2% - ±1.5% rdg
Température -32°C - +1000°C ±3% - ±5% rdg
Test diodes 3 Vcc ±10% rdg
Test continuité <30 Ω -

1760/RMS **CHF** 392.00 1 017600020

1760S

Multimètre digital compact

Lecture à valeur efficace TRUE RMS



Spécifications :
Tension CC : 200 mV-2/20/200/600V
Tension CA : 100/600V
Courant CC : 200 mA-10 A
Courant CA : 0.01-10 A
Résistance : 200Ω - 2/20/200 kΩ - 2 MΩ
Essai diodes : 0.4 ÷ 0.7
Alimentation : 2 piles 1,5V type AAA

1760S **CHF** 113.00 1 017600022

153x75x42 mm

1760PA/80

Pince ampèremétrique AC/DC 80A

Spécifique pour les mesures de valeurs basses de dispersion du courant ou absorptions sur véhicules

CE



- Fourchette : 1mA-80A AC/DC
- Fonction torche avec LED blanc
- Écran d'affichage LCD illuminé sur le fond
- Fonction de mise à zéro
- Fonction Hold
- Extinction automatique
- Alimentation : 2 piles 1,5V type AAA

1760PA/80 **CHF** 294.00 1 017600002

1760PA/AC

Pince ampèremétrique et multimètre digital

A: AC
V: AC/DC

CE



SPÉCIFICATIONS
 Tension CC 400 mV - 4/40/400/600 V
 Tension CA 400 mV - 4/40/400/600 V
 Courant CA 40/400/1000 A
 Résistance 400Ω - 4/40/400 kΩ - 4/40 MΩ
 Fréquence 5/50/500 Hz - 5/50/500 kHz - 5/10 MHz
 Capacité 40/400 nF - 4/40/100 μF
 Température -20 °C ÷ 1000 °C / -4 °F ÷ 1832 °F
 Alimentation : 1 pile 9 V (fournie)

1760PA/AC **CHF** 240.50 1 017600050

1760PA/AC-DC

Pince ampèremétrique et multimètre digital

A: AC/DC
V: AC/DC

CE



A: AC/DC
V: AC/DC

SPÉCIFICATIONS
 Tension CC: 0.1mV ÷ 600V
 Tension CA: 0.1mV ÷ 600V
 Courant AC: 0.01A ÷ 1000A
 Courant CC: 0.01A ÷ 1000A
 Résistance: 0.1Ω ÷ 40MΩ
 Capacité: 0.001nF ÷ 40 μF
 Fréquence: 0.001kHz ÷ 4kHz
 Température: -40°C ÷ 1000 °C
 -40°F ÷ 1832°F

1760PA/AC-DC **CHF** 436.00 1 017600000

1760PA/AC-DC2000

Pince ampèremétrique avec multimètre numérique munie d'une connexion Bluetooth

Fonction TRUE RMS dans les mesures AC

A: AC/DC
V: AC/DC

CE



Spécifications :
 • Tension CC : 0.1mV ÷ 1000V
 • Tension CA : 0.1mV ÷ 1000V
 • Courant CA : 0.01A ÷ 2000A
 • Courant CC : 0.01A ÷ 2000A
 • Résistance : 0.1Ω ÷ 60MΩ
 • Capacité : 1nF ÷ 6000 μF
 • Fréquence : 10kHz ÷ 20kHz
 • Température : -20 °C ÷ 1000 °C -4 °F ÷ 1832 °F
 • Alimentation : 3 piles 1,5V type AA (fournies)
 • Connexion Bluetooth (version 4.0)

H mm 300 L mm 110 P mm 43 **CHF** 861.00 1 017600003

380x280x100 mm - 1,78 kg

1760DGT-R3

Embout pour multimètres numériques et pinces ampérométriques



1760DGT-R3 **CHF** 30.50 1 017600603

1760/RSE

Détecteur de signal

Permet de tester l'alimentation de composants tels que : injecteurs électroniques Common Rail, injecteurs électroniques essence/GPL, injecteurs piézoélectriques, électrovannes débitmètre EGR, bobines et autres

CE



Pour effectuer le diagnostic individuel des composants de l'installation électrique, il suffit d'approcher la sonde du composant en question.

Sur les installations avec composants électromécaniques/électroniques commandés par une centrale, l'instrument permet de vérifier si :

- la centrale de gestion est alimentée et remplit sa fonction de commande
- le câblage de la centrale au composant est efficace
- le composant en question n'est pas interrompu
- le composant n'est pas en court-circuit
- le composant fonctionne d'un point de vue électronique

1760/RSE **CHF** 611.00 1 017600170

Beta

1760/TC2

Tachymètre digital à distance et par contact



CARACTÉRISTIQUES TECHNIQUES

- Pour la mesure de :
 - rotation à distance (tr/mn - rpm)
 - rotation (tr/mn - rpm)
 - et vitesse linéaire (m/mn ou ft/min) par contact.
- Afficheur à cristaux liquides à 5 chiffres.
- Échelle :
 - à distance 2,5÷99.999 tr/mn
 - par contact 0,5÷19.999 tr/mn
 - vitesse linéaire 0,05÷1.999,9 m/mn.
- Fréquence : 0,8 sec.
- Alimentation : 4 piles de 1,5V (type AA) ou alimentateur 6V (pas fourni)
- Fourni avec :
 - adaptateur pour les mesures par contact;
 - 2 embouts mâles en caoutchouc;
 - 1 embout femelle en caoutchouc;
 - 1 molette pour détections linéaires;
 - étiquettes réfléchissantes;
 - manuel d'instructions;
 - boîtier en plastique.

	L	H	CHF		
1760/TC2	230	74	305.00	1	017600161

1760R/TC2

Jeu d'étiquettes réfléchissantes pour 1760/TC2



	CHF		
1760R/TC2	27.00	1	017600561

1760K

Détecteur de tension de poche avec mini-torche à LED

Plage de détection : 200-1000Vac 50/60Hz
CAT III-1000V
Alimentation : 2 piles AAA (comprises)



	CHF		
1760K	49.00	1	017600140

1760PT

Testeur combiné de tension et de continuité 12-690V AC/DC

- Fonctions :
- continuité
 - rotation phases
 - détecteur de tension
 - torche LED

CE



IP64
CATIV
- 600V ;
CATIII
- 1000V

	CHF		
1760PT	196.50	1	017600150

1760/IR500

Thermomètre digital à infrarouge avec système de pointage laser double

ne convient pas pour mesurer la température corporelle



CARACTÉRISTIQUES TECHNIQUES

Gamme de température : -50 ÷ 500 °C (-22 ÷ 932 °F)
Résolution afficheur : 0,1 °C (0,1 °F)
Émissivité : 0,1 ÷ 1 réglable
Précision : -50 ÷ 20 °C (+/- 3 °C); 20 ÷ 500 °C (+/- 2 % ou 2 °C)
Résolution optique (D:S) : 12:1
Auto-extinction : environ 10 secondes
Température d'exercice : 0 ÷ 50 °C
Température de stockage : -20 ÷ 60 °C
Alimentation : 1 pile 9V

	CHF		
1760/IR500	210.00	1	017600350

1760/IR1000

Thermomètre digital à infrarouge avec système de pointage laser double

ne convient pas pour mesurer la température corporelle



CARACTÉRISTIQUES TECHNIQUES

Gamme de température : -50 ÷ 1000 °C (-58 ÷ 1832 °F)
Résolution afficheur : 0,1 °C (0,1 °F)
Émissivité : 0,1 ÷ 1 réglable
Précision : -50 ÷ 20 °C (+/- 3,5 °C); 20 ÷ 300 °C (+/- 1% ou 1 °C); 300 ÷ 1000 °C (+/- 1,5 %)
Résolution optique (D:S) : 20:1
Température d'exercice : 0 ÷ 50 °C
Température de stockage : -10 ÷ 60 °C
Alimentation : 2 piles 1,5 V (type AAA)

	CHF		
1760/IR1000	347.00	1	017600400

1760/IR1600

Thermomètre digital à infrarouge avec système de pointage laser

ne convient pas pour mesurer la température corporelle



CARACTÉRISTIQUES TECHNIQUES

Gamme: -50 °C ÷ 1600 °C / -58 °F ÷ 2912 °F
Sélection échelle: °C/°F
Précision: ±1,5% ou ±2 °C ÷ 20 °C
Puissance Laser: <1mW
Réponse: 1 sec
Émissivité: 0,10÷1,0 réglable
Rapport distance: (D:S) 50:1
Température d'exercice: 0 °C ÷ 50 °C / 32 °F ÷ 122 °F
Taux d'humidité : de 10% à 90% RH
Afficheur LCD rétroéclairé
Fonction de maintien des données
Auto-extinction
Alimentation: 1 pile 9V (fournie)
Boîtier rigide trépieds en aluminium
Manuel d'utilisation

	mm	mm	CHF		
1760/IR1600	200	115	971.00	1	017600461



1760LX

Luxmètre numérique portable

EN61010-1
EN61326-1



CE

Détails techniques :
Plage de mesure Précision de base
Luminosité Lux 0-200000 ±3%
Luminosité FC 0-20000 ±3%
Alimentation : 1 x 9V

1760LX	L mm	165	CHF	132.50	1	017600820
--------	---------	-----	-----	--------	---	-----------

1760TMC

Caméra thermique à infrarouges

Caméra thermique compacte pour le mesure de la température sans contact, préconisée pour applications dans les secteurs du bâtiment, de la mécanique, les installations électriques et de chauffage.

Écran d'affichage LCD TFT de 2 pouces 240x320

Capteur de 32x32 pixels

Fréquence d'acquisition 7Hz

Thermosensibilité <347mK

Acquisition automatique des points chauds et froids

Appareil photo d'acquisition d'images en format BMP (maximum 100 images)

Émissivité réglable

Alimentation 3 batteries alcaline AAA

Interface USB

IP54

Température -20°C/+600 °C

Bande infrarouges 6,5-14µm

Distance de fusion visible/infrarouge : 0,5 ; 1 ; 2 m

Fonction alarme, en sélectionnant la température maximale et minimale acceptables



CE

1760TMC 600	CHF	1,111.00	1	017600710
-------------	-----	----------	---	-----------

1760WM

Anémomètre numérique avec capteur à pales de ventilateur

EN61010-1
EN61326-1



CE

Détails techniques :
Plage de mesure Précision de base
Vitesse m/s 0,4-30 ±2%
Vitesse k/n 1,4-108 ±2%
Vitesse ft/m 80-5900 ±2%
Vitesse mil/h 0,8-58 ±2%
Flux CFM 0-99990 ±0-9,999 ft2
Flux CMM 0-99990 ±0-9,999 m2
Flux CMS 0-99990 ±0-9,999 m2

1760WM	L mm	170	CHF	107.00	1	017600800
--------	---------	-----	-----	--------	---	-----------

1761

Pince tordeuse de fil à retour automatique



L mm	255	CHF	86.00	1	017610101
---------	-----	-----	-------	---	-----------

1761RS/1

Pince tordeuse de fil réversible à retour automatique



L mm	220	CHF	153.50	1	017620130
---------	-----	-----	--------	---	-----------

1762

Pince emporte-pièces 6 diamètres



Ø mm	L mm	CHF	40.50	2	017620001
2-2,5-3	210				
3,5-4-4,5					

1763

Pince pour selliers automobiles



1763	CHF	47.00	1	017630001
------	-----	-------	---	-----------

1763G/S500

500 agrafes pour revêtements textiles auto



1763G/S500	CHF	88.50	1	017630105
------------	-----	-------	---	-----------

1764/K5

Pince à riveter manuelle pour rivets en plastique

Fournie avec 4 tailles de rivets

Le kit comprend :

- 10 rivets Ø 5x17,2 mm
- 10 rivets Ø 5x15,8 mm
- 10 rivets Ø 6,3x25,2 mm
- 10 rivets Ø 6,6x17,2 mm



1764/K5	CHF	69.00	1	017640001
---------	-----	-------	---	-----------

1764/K5-R

Lot de 20 rivets en plastique pour la pince à riveter 1764/K5



1764/K5-R1	5X17,2	CHF	18.90	1	017640003
1764/K5-R2	5X15,8	CHF	18.90	1	017640004
1764/K5-R3	6,3X25,2	CHF	18.90	1	017640005
1764/K5-R4	6,6X17,2	CHF	18.90	1	017640006

1765/C24

Coffret avec 24 outils
dépose-autoradios



1765/C24 CHF 257.00 1 017650001

1766

Ventouse double pour pare-brise



max kg 50 CHF 160.00 2 017660001

1766A

Ventouse simple



max kg 30 CHF 41.00 2 017660005

1766/8

Composition de 8 outils
pour vitres automobile



1766/8 CHF 595.00 1 017660100

1766ER

Extracteur pour lèche-vitres
avec manche

Permet d'extraire aisément
les lèche-vitres sans risquer de les abîmer



1766ER CHF 29.00 1 017660501

1766ER/VW

Outil de retrait de garniture de fenêtre

Particulièrement adapté aux moulures de fenêtres du groupe
VAG
avec un espace de préhension réduit

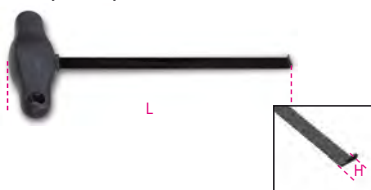

L mm 215 H mm 4 CHF 20.60 1 017660510

1766L

Lève pare-brise



1766L CHF 67.00 1 017660015

1766LI

Levier pour insertion câble coupe vitres

bords aiguisés pour coupe scellant



1766LI CHF 23.80 1 017660016

1766I

Poignée pour câble 1766G



1766I CHF 65.00 2 017660020

1766G

Câble d'acier pour vitres

Section carrée



50 m CHF 57.50 1 017660025

1766T

Câble carré en acier pour pare-brise

section triangulaire



50 m CHF 67.00 1 017660026



1767A

Barre télescopique

- Conçue pour soutenir les capots et les coffres dont les verrins ne fonctionnent plus
- Également utilisable pour maintenir les pédales bloquées



L mm
640 ÷ 1090

CHF 90.50

1 017670000

1767B

Kit pour le verrouillage de la pédale de frein et du volant

Le mécanisme de réglage par gâchette garantit des réglages précis tout en gardant le véhicule accéléré



1767B

CHF 194.00

1 017670100

490x285x95 mm • 2,4 kg

1767PMC

Bac de rangement magnétique rond



1767PMC

CHF 28.50

1 017670020

1767PMR

Bac de rangement magnétique rectangulaire

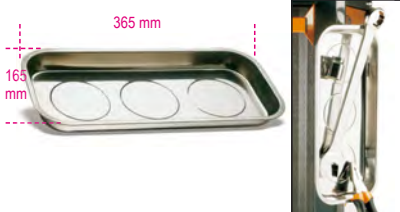

1767PMR

CHF 57.50

1 017670010

1768

Marche pied en aluminium

Surface revêtue d'un matériau antidérapant
capacité de charge maximale: 200 kg



L mm 960

L1 mm 300

H mm 475

CHF 250.00

1 017680010

1770

Cutter extra-plat à lame sécable 9 mm avec 2 lames de recharge



1770

L mm 140

A mm 9

CHF 21.70

10 017700001

1770A

Cutter de 9 mm avec blocage automatique de la lame, avec 3 lames de recharge



1770A

L mm 135

A mm 9

CHF 8.15

10 017700025

1770RL

Etui de 10 lames sécables 9 mm, pour 1770, 1770BM et 1770A



1770RL

CHF 7.20

5 017700010

1770BM

Cutter de 9 mm, avec 6 lames de recharge



1770BM

L mm 140

A mm 9

CHF 16.60

10 017700050

1771

Cutter à lame sécable 18 mm avec 3 lames



1771

CHF 12.30

10 017710000

1771BM

Cutter à lame sécable 18 mm, avec 6 lames à rechargement automatique



1771BM

L mm 170

A mm 18

CHF 27.00

10 017710050

1771HD

Cutter 18 mm fourni avec 6 lames

- Chargement automatique de la lame
- Système bloque-lame à vis



1771HD

L mm 190

A mm 18

CHF 30.00

5 017710100

1771RL

Etui de 10 lames sécables 18 mm, pour 1771 et 1771BM, 1771HD



1771RL

CHF 10.40

5 017710010

1772M

Cutter de sécurité à lame rétractable, avec 4 lames

Lame avec retour automatique à ressort

- Corps en alliage moulé sous pression
- Retire-agrafes intégré dans le manche



1772M

L mm 170

A mm 18

CHF 24.60

5 017720040

1772R

Cutter à lame trapézoïdale rétractable
fourni avec 5 lames



	L mm	A mm	CHF		
1772R	125	18	22.70	5	017720006

1772H

Cutter de sécurité à lame rétractable,
avec 2 lames



	L mm	A mm	CHF		
1772H	170	18	23.90	5	017720029

1772RL/2

Étui de sécurité de 10 lames trapézoïdales
longues pour 1772H, 1772M, 1772R,
1774, 1777BMT, 1777T

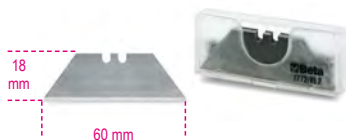

	CHF		
1772RL/2	5.75	5	017720017

1773A

Cutter de 25 mm



	L mm	A mm	CHF		
1773A	180	25	23.90	10	017730000

1773RL

Étui de 10 lames pour 1773A



	CHF		
1773RL	23.40	5	017730015

1773S

Cutter de sécurité à lame ronde

- Lame principale Ø 28 mm coupe sangle
- Lame secondaire pour de couper les films et les bandes adhésives
- Trou de suspension



	L mm	A mm	CHF		
1773S	190	28	11.20	1	017730100

1773S/RL

3 lames rondes Ø 28 mm
pour cutter de sécurité 1773S



	CHF		
1773S/RL	4.95	5	017730110

1774

Grattoir plastique
avec protection de la lame



	L mm	L1 mm	CHF		
1774	155	60	5.60	5	017740001

1774A

Grattoir plastique
poignée bi-matériaux



	L mm	A mm	CHF		
1774A	300	40	17.40	1	017740011

1774A/RL

Étui de 10 lames pour grattoirs 1774A et
1774S

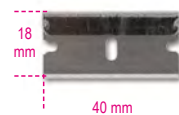

	CHF		
1774A/RL	8.25	1	017740511

1774S

Grattoir pour enlever les adhésifs



	A mm	L mm	CHF		
1774S	40	100	9.35	2	017740021

1777BM

Couteau d'électricien avec dénudeur,
lame en acier inoxydable



	L mm	L1 mm	A mm	CHF		
1777BM	190	80	16	15.60	5	017770100

1777T

Couteau à cran d'arrêt avec lame
trapézoïdale,
poignée en aluminium fournie avec 5 lames de
rechange



	L mm	A mm	L1 mm	CHF		
1777T	160	19	65	34.00	5	017770030

1777BMT

Cutter à lame trapézoïdale à cran d'arrêt avec
3 lames

4 profondeurs réglables de la lame
4; 9.5; 15.5; 21.5 mm
fourni avec 3 lames



	L mm	L1 mm	A mm	CHF		
1777BMT	170	80	19	36.50	5	017770050

1778AN

couteau pliant, lame en acier inoxydable,
poignée légère en aluminium anodisé
• avec étui



	L mm	A mm	L1 mm	CHF		
1778AN	204	26	84	42.00	5	017780065

1778AX

Couteau à cran d'arrêt,
lame en acier inoxydable à dents,
manche en aluminium,
avec cran pour ouverture aisée,
• avec étui



	L	A	L1	CHF		
1778AX	mm 189	mm 26	mm 80	46.00	5	017780026

1778BS

Couteau pliable finition "carbon" avec double
verrouillage de sécurité et lame dentelée en
acier inoxydable

• Avec étui



	L	A	L1	CHF		
1778BS	mm 200	mm 29	mm 85	46.00	10	017780035

1778CM

Couteau à cran d'arrêt mimétique
lame en acier trempé
en étui



	L	A	L1	CHF		
1778CM	mm 195	mm 24	mm 80	43.50	5	017780099

1778M7

couteau pliant, mini lame en acier inoxydable,
poignée avec inserts en fibre de verre
• avec étui



	L	A	L1	CHF		
1778M7	mm 163	mm 24	mm 68	37.00	5	017780015

1778P

couteau à cran d'arrêt,
lame et manche en acier inoxydable et
aluminium,
bouton d'ouverture
• avec étui



	L	A	L1	CHF		
1778P	mm 193	mm 29	mm 72	49.50	5	017780088

1778SCL

Couteau à cran d'arrêt avec finition soft carbon
look
lame en acier trempé
avec étui



	L	A	L1	CHF		
1778SCL	mm 180	mm 22	mm 78	41.00	5	017780089

1778SOS

Couteau de survie auto
avec fonction marteau brise-vitre
et coupe-ceinture de sécurité
avec étui



	L	A	L1	CHF		
1778SOS	mm 205	mm 25	mm 85	43.50	5	017780080

1778V18

Couteau à cran d'arrêt en aluminium
• avec étui



	L	A	L1	CHF		
1778V18	mm 195	mm 25	mm 85	41.00	5	017780018

1778X

Couteau pour maintenance nautique en acier
inoxydable avec manche aluminium



	L	L1	A	CHF		
1778X	mm 185	mm 85	mm 25	39.50	2	017780050



1778MT - MULTITOOL

L'outil multifonctions BETA se distingue des articles similaires sur le marché par des caractéristiques qui dénotent son origine BETA : des pinces d'une qualité incomparable, l'utilisation de matériaux prisés et un haut contenu technologique. La présence de **11 embouts** aux géométries les plus présentes sur le marché, rend cet article idéal pour tout milieu et toute condition de travail, du camping au nautisme, de la chasse au bricolage.



22 FONCTIONS

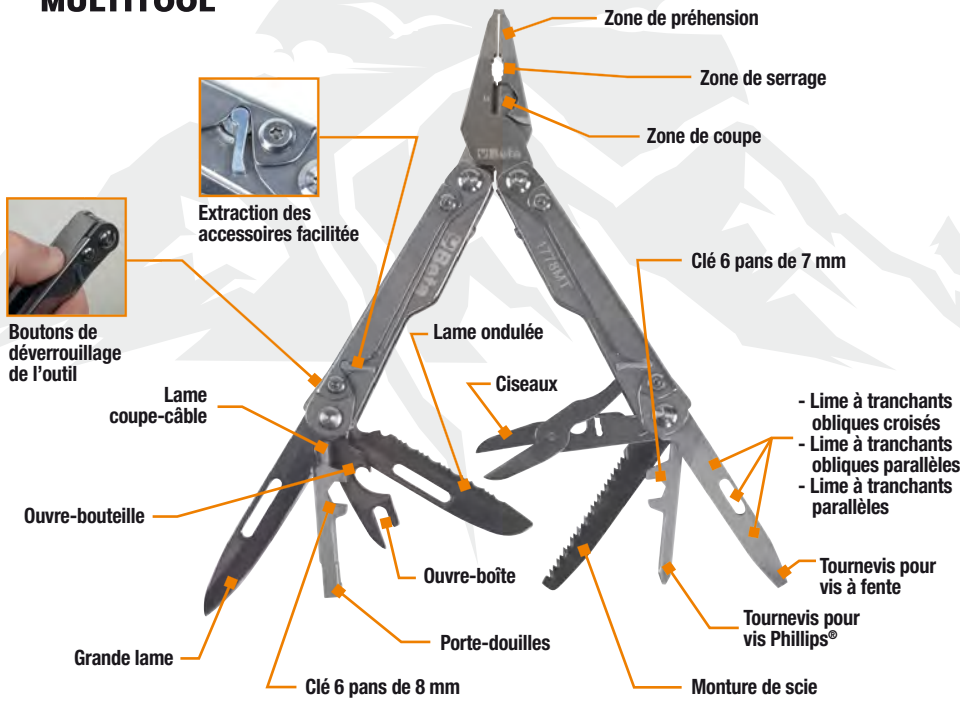

11 embouts + Porte-douilles



Règle de 100 mm / 4"

1778MT

Outil multifonctions complet avec embouts et étui
9 outils
22 fonctions



L mm	L1 mm	CHF	🔧	📦	Code
180	115	130.00	1	1	017780055

1781

Ciseaux à lames longues pointues



L mm	CHF	🔧	📦	Code
1781 132	24.10	2	1	017810001

1783

Ciseaux faible effort



L mm	CHF	🔧	📦	Code
215	20.00	5	1	017830021
240	22.30	5	1	017830024

1784

Ciseaux gros effort



L mm	CHF	🔧	📦	Code
175	28.50	2	1	017840017
200	38.50	2	1	017840020
250	51.00	2	1	017840025
300	69.00	2	1	017840030

1800/100

Coussin élévateur (max. 100 kg)

- Soulever-mettre à niveau
- Bloquer portes et volets



A mm	B mm	S mm	CHF	🔧	📦	Code
160	150	2÷55	77.50	3	1	018000000



Beta

ÉCLAIRAGE

La famille d'éclairage comprend une large gamme de produits conçus pour satisfaire toutes les exigences des utilisateurs, allant de l'inspection de petits tuyaux à l'éclairage de grandes zones de travail.

Lampes de poche

Le nouveau design, les améliorations techniques et le large choix de tailles permettent de sélectionner la lampe de poche la plus appropriée en fonction des critères de : luminosité, durée de vie de la batterie et des performances.

Lampes et spots

Basées sur une technologie LED améliorée, une durée de vie allongée de la batterie, un temps de charge réduit, une attention particulière aux matériaux et une recherche continue de solutions innovantes, les lampes de travail de Beta allient une combinaison exceptionnelle de design, fonctionnalité et performance. Une gamme complète conçue pour permettre aux professionnels de travailler dans tous les secteurs d'activité et dans les meilleures conditions possibles.



WIRELESS

La nouvelle technologie sans fil permet de charger les derniers spots et lampes via une seule base de charge 1839BRW. Grâce à la nouvelle base 1839BRW, il est possible de

charger simultanément les spots et les lampes les plus récents sans nécessairement avoir recours à des câbles. De plus, le support amovible permet également de recharger les téléphones portables.



CRI - Color Rendering Index

CCT - Correlated Color Temperature

PROJECTEURS

ARTICLE	LUMEN	BATTERIE	TEMPS DE RECHARGE	AUTONOMIE	IP/IK	CCT	CRI
1837C/2100	500 - 1000 - 2100	Li-Ion 11.1V; 4400 mAh	4.0h	9 - 2.5h	IP65 - IK07	6500K	80+
1837C/4300	1100 - 2100 - 4300	Li-Ion 11.1V; 5200 mAh	4.0h	6 - 1.5h	IP65 - IK07	6500K	80+
1837M	500 - 1000 - 2000	Li-Ion 11.1 V, 5200 mAh	3.5h	2 - 8h	IP65 - IK07	2700-3500-4500-5500-6500K	96+
1838FLASH	360 - 720	Li-Ion 7.4 V; 4000 mAh	4.0h	4 - 8h	IP65	6300K	-
1838POCKET	160 - 400 - 800	Li-Ion 3.7 V; 2600 mAh	4.0h	3 - 9h	IP65	6500K	80+

LES LAMPES

ARTICLE	LUMEN	BATTERIE	TEMPS DE RECHARGE	AUTONOMIE	IP/IK	CCT	CRI
1838/11LED	320	Li-Ion 3.7V; 4200 mAh	4.0h	4h	IP65	6500K	
1838AM	60 - 700 120 (spot)	Li-Ion 3.7V; 2600 mAh	4.0h - USB-C	2.5 - 16h 10h (spot)	IP54 - IK07	6500K	80+ 70+
1838COB	100 - 200 75 (spot)	Li-Ion 3.7V; 1600 mAh	3.0h	3-6h 4h (spot)	IP65	6000K	80+
1838P	80 - 50	Li-Ion 3.7V; 700 mAh	2.5h	4h	IP20	6000K	80+
1838SLIM	100 - 200 180 (back) 80 (spot)	Li-Ion 3.7 V, 700 mAh	2.5h - USB-C	2 - 4h 2h (back) 3h (spot)	IP54 - IK07	6500K	80
1838UV	75 - 150	Li-Ion 3.7V; 1600 mAh	3.0h	3h	IP20	6000K	80
1838SW	250 - 500 - 1000	Li-Ion 3.6V; 3350 mAh	4.5 - 6.5h	3 - 7h	IP65 - IK07	6500K	80+
1838E	500 - 1000 - 2000	Li-Ion 3.6V; 3350 mAh	4.5 - 6.5h	3 - 9h	IP20 - IK07	5500K	80+

LAMPES FRONTALES

ARTICLE	LUMEN	BATTERIE	TEMPS DE RECHARGE	AUTONOMIE	IP/IK	CCT	CRI
1836B	125 - 250	Li-Ion 3.8V; 1600 mAh	3.0h	5h	IP65 - IK07	6000K	80+
1836AW	30 - 200 - 400	Li-Ion 3.7V; 1500 mAh	2.5h	4-18h	IP65 - IK07	6500K	80+

LUMIÈRES

ARTICLE	LUMEN	BATTERIE	TEMPS DE RECHARGE	AUTONOMIE	IP/IK	PORTÉE D'ÉCLAIRAGE
1833XS/1	100	1 x AAA	-	5h	IP66	85m
1833XS/2	200	2 x AAA	-	10h	IP66	112m
1833S	500	2 x AA	-	10h	IP66	140m
1833M	700	3 x AAA	-	7.5h	IP66	170m
1833L	1100	3 x AA	-	8.5h	IP66	330m
1833L/USB	1200	Li-Ion 3.7 V, 2600 mAh	3.0h - USB-C	3.0h	IP66	230m
1833XSW	80 - 250	Li-Ion 3.7V 2600 mAh	2.0 h	2.0-8.0h	IP54 - IK07	
1833MW	5 - 30 - 400 - 1000	Li-Ion 3.7V; 2600 mAh	4.0 - 6.0 h	2.0-200.0h	IP68 - IK07	
1833XL	1500	3xD	-	22h	IP66	290m
1837F	500	3 x AA	-	14.5h	IP66	125m
1837F/USB	600	Li-Ion 3.7 V, 2900 mAh	4.0h - USB-C	10h	IP66	280m

1833L/USB

Torche LED rechargeable à haute luminosité en aluminium anodisé renforcé jusqu'à 1200 Lumens

- Cône lumineux réglable
- 3 réglage possible de luminosité
- batterie : 3H
- IP66
- Portée d'éclairage : 230 m
- témoin indicateur de charge de la batterie (<15%)
- chargement par port USB-C
- chargeur non inclus



L mm 240
CHF 150.50
1 018330054

1833RB-L/USB

Batterie de rechange pour 1833L/USB

1833RB-L/USB
CHF 69.50
1 018330975

1833XS/1

Torche d'inspection LED en aluminium anodisé renforcé

- 100 lumens
- Cône lumineux réglable
- piles : 1xAAA (non inclus)
- IP66
- autonomie : 5H
- Portée d'éclairage : 85 m



L mm 92
CHF 26.00
3 018330000

1833XS/2

Torche d'inspection LED en aluminium anodisé renforcé

- 200 lumens
- Cône lumineux réglable
- piles : 2xAAA (non inclus)
- IP66
- autonomie : 10H
- Portée d'éclairage : 112 m



L mm 133
CHF 28.50
3 018330001

1833XSW

Torche d'inspection LED sans fil rechargeable

- 2 intensités lumineuses : LED SMD, 250 ou 80 lumens
- Batterie rechargeable : 3,7 V, 700 mAh, 2,59 Wh Li-ion
- 2 modes de chargement :
- base de recharge sans fil 1839BRW
- câble d'alimentation avec port USB-C
- Temps de charge:
- 2h avec base de recharge sans fil
- 2h avec le câble d'alimentation
- Autonomie de la batterie : 2 à 8 h
- Indicateur de niveau de batterie LED
- Supports magnétique sur la base et sur l'arrière
- Boucle de ceinture
- IP54
- IK07
- Câble d'alimentation USB-C inclus



L mm 145
 CHF 61.50 1 018330011

1833S

Torche LED à haute luminosité en aluminium anodisé renforcé jusqu'à 500 Lumens

- Cône lumineux réglable
- 2 réglages possibles de luminosité
- piles: 2xAA (non inclus)
- Autonomie : 10H
- IP66
- Portée d'éclairage : 140 m



L mm 150
 CHF 49.00 1 018330002

1833M

Torche LED à haute luminosité en aluminium anodisé renforcé jusqu'à 700 Lumens

- Cône lumineux réglable
- 2 réglages possibles de luminosité
- piles: 3xAAA (non inclus)
- témoin indicateur de charge des piles (<15%)
- Autonomie : 7.5h
- IP66
- Portée d'éclairage : 170 m



L mm 162
 CHF 61.50 1 018330003

1833MW

Torche LED haute luminosité sans fil rechargeable

- 4 intensités lumineuses : LED SMD de 1000 - 400 - 30 ou 5 lumens
- Batterie rechargeable : 3,7 V 2600 mAh, 9,62 Wh Li-ion
- 2 modes de chargement :
- base de recharge sans fil 1839BRW
- câble d'alimentation avec port USB-C
- Temps de charge:
- 6h avec base de recharge sans fil
- 4h avec le câble d'alimentation
- Autonomie de la batterie : 2 à 200 h
- Indicateur de niveau de batterie à 3 LED
- Support Magnétique au dos
- IP68
- IK07
- Câble d'alimentation USB-C inclus



L mm 160
 CHF 112.00 1 018330013

1833L

Torche LED à haute luminosité en aluminium anodisé renforcé jusqu'à 1100 Lumens

- Cône lumineux réglable
- 2 réglages possibles de luminosité
- piles: 3xAA (non inclus)
- témoin indicateur de charge des piles (<15%)
- Autonomie : 8.5h
- IP66
- Portée d'éclairage : 330 m



L mm 196
 CHF 102.50 1 018330004

1833XL

Torche LED à haute luminosité en aluminium anodisé renforcé jusqu'à 1500 Lumens

- Cône lumineux réglable
- 2 réglages possibles de luminosité
- piles: 3xD (non inclus)
- témoin indicateur de charge des piles (<15%)
- Autonomie : 22h
- IP66
- Portée d'éclairage : 290 m



L mm 300
 CHF 128.50 1 018330005

1836AW

Lampe frontale à LED rechargeable sans fil, avec double émission de lumière

- Double émission de lumière :
- front : 3 intensités de lumière LED COB 30 - 200 - 400 lumens
- spot (tête): LED COB, 400 lumens
- Batterie rechargeable : Li-Ion 3.7 V, 1500 mAh, 5.55 Wh
- Avec port USB-C
- Câble USB-C inclus
- Temps de charge : 2,5 h
- Autonomie de la batterie :
- front : 4-18 h
- spot (tête): 4 h
- IP 65
- IK 07



1836AW
 CHF 92.50 1 018360051

1836B

Lampe frontale LED rechargeable à double intensités lumineuses et détecteur de mouvement ON/OFF

- Détecteur de mouvement marche/arrêt sans contact
- Livrée avec câble de chargement USB / mini-jack et chargeur
- 250 lumens
- Autonomie de la batterie : 3 à 6 h
- IP65



1836B
 CHF 167.50 1 018360200

1837F

Lampe magnétique articulée à LEDs haute luminosité, en aluminium anodisé renforcé, jusqu'à 500 Lumens

- Cône lumineux réglable
- 2 intensités lumineuses
- Piles 3xAA (non fournies)
- Durée 14.5 h
- Indicateur de charge
- IP66



L mm 460
 CHF 111.00 1 018370050

1837F/USB

Lampe magnétique articulée rechargeable en aluminium anodisé renforcé et LED haute luminosité jusqu'à 600 lumens.

- Cône lumineux réglable
- 2 intensités lumineuses
- Autonomie de la batterie : 10H
- Indicateur de batterie déchargée <15%
- Recharge grâce à un port USB-C
- Livrée avec câble de recharge USB-C
- IP66



L mm 460 CHF 164.50 1 018370060

1837RB-F/USB

Batterie de recharge pour 1837F/USB

1837RB-F/USB CHF 48.50 1 018370960

1838POCKET

Spot de poche rechargeable, articulé, orientable et à double faisceau lumineux LED.

- Double émission lumineuse :
Lumière principale : LED COB avec 3 intensités lumineuses : 160 - 400 - 800 lumens
Spot : LED SMD, 250 lumens
- Angle d'éclairage :
Lumière principale : 160°
Spot : 18°
- Lampe rechargeable 3,7 V 2 600 mAh Li-ion
- 2 modes de recharge grâce à :
Base à induction 1839BRW
Port USB-C
- Temps de recharge :
4,5H avec base de recharge par induction
4 H avec alimentation
- Autonomie :
Lumière principale : 3H à 9H
Spot : 4,5H
- Indicateur de charge de la batterie à 3 LED
- Orientable à 210°
- Corps en caoutchouc antidérapant
- Base magnétique
- Magnétique sur la base
- IP65
- IK07
- Livré avec câble USB-C



L mm 98 I mm 82 S mm 39 CHF 87.50 1 018380080

1837C

Spot rechargeable à LED de chantier

- 3 intensités lumineuses
- charge batterie : input : 100-240 V AC - 50/60Hz ; output: 15V 1,5A
- temps de recharge : 4 heures
- indicateur de charge à 3 LED
- orientable à 180°
- IP65
- IK07



LxHxl mm	Lm	h	CHF	1	018370210
220x225x70	2100	2.5	244.00		
	1000	5.0			
	500	9.0			
266x236.6x59	4300	1.5	358.00		1 018370430
	2100	3.0			
	1100	6.0			

1837C/RA2100-4300

Alimentateur pour spot à LED 1837C/2100-4300

1837C/RA2100-4300 CHF 34.50 1 018370970

1837M

Spot rechargeable à LED COLOUR MATCH, pour contrôle couleur, haut indice de rendu de couleur (IRC 96+), jusqu'à 2.000 lumens

- 3 intensités lumineuses : 500/1.000/2.000Lumen
- CRI (indice de rendu de couleur) : 96+
- CCT (température couleur) : 2700K/ 3500K/ 4500K/ 5500K/ 6500K
- charge batterie : input : 100-240V AC - 50/60Hz ; output : 15V 1.5A
- connecteur de recharge à décrochage rapide
- temps de recharge : 3.5 heures
- durée : 8/4/2 h
- indicateur de charge
- touche à LED indicateur de température couleur
- touche à led indicateur d'intensité lumineuse
- orientable à 180°
- IP65
- IK07



LxHxl mm	Lm	h	CHF	1	018370450
220x225x70	500	8.0	382.00		
	1000	4.0			
	2000	2.0			

1837M/RA

Alimentateur pour spot COLOUR MATCH 1837M



1837M/RA CHF 65.50 1 018370975

1837S

Trépied télescopique pour support spot de chantier

- En métal
- Hauteur variable 70+155 cm
- Compatible avec 1837C et 1838FLASH



h cm 70÷170 CHF 79.50 1 018370500

1838FLASH

Spot rechargeable compact, étudié pour offrir la meilleure solution possible en toute occasion.

ÉCLAIRAGE GÉNÉREUX ET TOUJOURS PRÊT : avec une capacité d'éclairage maximum de 720 lumens et la possibilité de travailler avec batterie ou câble, il est toujours prêt à l'emploi.

INSTALLABLE PARTOUT :

- sur plans : avec pieds en caoutchouc sur trois côtés ou avec entraînement de 1/4" pour chevalet (standard type appareil photo)

- sur structures métalliques : avec aimant dévissable ou crochet orientable à 360°

COMPACT : avec seulement 85x100x155 mm d'encombrement, il peut être logé de manière pratique dans la sacoche des outils et utilisé dans des lieux exigus.

ROBUSTE : étudié pour résister aux sollicitations mécaniques les plus sévères. Garantie de durée dans le temps.



1838FLASH CHF 433.00 1 018380300

1838RB/FLASH

Batterie de recharge pour 1838/FLASH

1838RB/FLASH CHF 94.00 1 018380930

1838/11LED

Lampe rechargeable à LEDs très haute luminosité

Batterie au lithium polymère

- Corps compact en caoutchouc antiglisse
- Verre frontal facile à remplacer
- Crochet orientable
- Avec station de recharge 110-230Vac
- 340 Lumen
- Avec led en tête pour éclairage multidirectionnel



1838/11LED CHF 212.00 1 018380111

1838RA/10-11LED

Alimentateur pour 1838/10LED et 1838/11LED

CE

1838RA/10-11LED CHF 44.50 1 018380903

1838RB/10LED

Batterie pour 1838/10LED et 1838/11LED

1838RB/10LED CHF 71.50 1 018380902

1838RR/11LED

Base de recharge pour 1838/11LED

1838RR/11LED CHF 47.00 1 018380914

1838RV/11LED

Verre frontal anti-écaillage pour lampe 1838/11LED



1838RV/11LED CHF 6.50 2 018380905

Beta

1838AM

lampe d'inspection LED rechargeable, avec double émission de lumière, articulée, peut être tournée à 180°, avec base magnétique pivotante et crochet

- double émission lumineuse : avant: LED COB, 60-700 lumens, peut être ajusté avec potentiomètre spot (tête): LED SMD, 120 lumens, interrupteur ON-OFF
- batterie Li-ion rechargeable 3.6V 2600mAh
- avec port USB-C
- fourni avec chargeur 100-240V / 50-60Hz
- temps de charge: 4h
- autonomie de la batterie: front: 2.5-16h spot (tête): 10h
- Indicateur de niveau de batterie à 3 LED
- articulé, peut être tourné de 180° (± 90° par rapport à l'axe)
- base magnétique (avec aimant en néodyme), peut être tournée de 90°
- crochet de base pivotant
- IP54
- IK07



L I S L1
mm mm mm mm
1838AM 405 40 45 175 CHF 139.00 1 018380400

1838COB

Lampe à LED portable rechargeable

- Fixation murale, avec corps en caoutchouc antiglisse et antichoc
- Batterie au lithium polymère
- Base magnétique orientable à 180 degrés
- Avec chargeur 100-240Vac / 50-60Hz
- 100/200 lumens ; SPOT 75 lumens
- Autonomie : 6h / 3h ; SPOT 4h
- temps de recharge : 3 heures
- IP65

CE
IP65



1838COB CHF 120.00 1 018380010

1838P

Lampe stylo rechargeable, avec double émission lumineuse : lampe ou torche

- Corps compact en caoutchouc antiglisse
- 75/150 lumens
- Crochet de poche
- Base magnétique orientable à 180 degrés
- Fournie avec câble de charge USB/jack 3,5mm
- Autonomie : 2,5 heures
- IP65



1838P CHF 103.00 1 018380005

1838SLIM

Lampe slim articulée rechargeable à 3 LED

- 3 Intensités lumineuses
- Avant : 100/200 lumens - Arrière : 180 lumens - Spot (tête) : 80 lumens
- Base magnétique
- Temps de recharge : 2,5H
- Autonomie : 2 à 4H / Spot 3H
- Livrée avec câble de recharge USB-C

CE
IP54



L I S
mm mm mm
1838SLIM 307 17 29 CHF 93.50 1 018380221

Beta

1838SW

Lampe articulée à LED, rechargeable avec chargeur sans fil

- Double émission lumineuse : avant : LED COB, 3 intensités lumineuses : 250 - 500 - 1000 lumens
- en tête (spot) : LED SMD, 200 lumens
- Batterie rechargeable Li-ion 3.6V 3.350mAh
- 2 modes de charge : base sans fil 1839BRW alimentateur avec connexion USB-C
- Temps de charge : 6.5h avec base de recharge sans fil 4.5h avec alimentateur
- Autonomie : avant : 3-5h en tête (spot) : 7h
- Indicateur de charge de la batterie à 3 LEDs
- Base orientable à 180°
- Corps en caoutchouc antiglisse
- Double crochet orientable
- 3 aimants sur derrière
- 1 aimant sur base
- IP65
- IK07
- Câble USB-C inclus



	L mm	I mm	S mm	CHF		
1838SW	260	53	40	124.50	1	018380142

1838UV

Lampe rechargeable UV + lumière blanche idéale pour la détection des fuites

- Corps compact en caoutchouc antiglisse
- Avec chargeur 100-240Vac / 50-60Hz
- 150 lumens / UV



	CHF		
1838UV	202.50	1	018380150

1838E

Lampe LED rechargeable sous capot

- Triple émission de lumière: 500/1000/2000 lumens
- Orientable à 360°
- réglable en longueur: 116 ÷ 188 cm
- corps en aluminium
- crochets en caoutchouc antidérapants
- port de charge en USB-C
- 2 modes de charge: charge via le port USB de la lampe charge via le port USB de la batterie interne
- fourni avec chargeur de batterie entrée: 100-240V ~ 50 / 60Hz sortie: DC 5V - 2000 mA
- Autonomie: 3-9 h
- IP20
- IK07



IP20
IK07

L min mm	L max mm	I mm	CHF		
1170	1880	150	237.50	1	018380270

1838E-BT

Batterie rechargeable avec port USB-C pour lampe sous capot article 1838E

- Li-Ion 3,6V
- DC 5V - 2000 mA

CE

	CHF		
1838E-BT	67.00	1	018380271

1839BRW

Base de recharge sans fil, compatible avec les lampes 1838POCKET, 1838SW

- Deux positions de charge avec fixation magnétique pouvant être utilisées simultanément
- Avec support amovible pour recharge sans fil du téléphone portable
- LED indicateur d'état de charge
- Puissance d'entrée max. : 10W x2
- Entrée : AC 100-240V 50/60Hz
- Sortie : DC 12V 1.5A
DC 9V 2A
DC 5V 3A
- Port USB-C
- Peut être accroché au mur au moyen de : 3 aimants puissants à l'arrière
2 trous pour les vis
- IP20
- IK07



L mm	I mm	S mm	CHF			
1839BRW	101	190	28	118.00	1	018390002

1839/R5

Câble USB-C QC 3.0, pièce de rechange pour 1838POCKET, 1839BRW

	CHF		
1839/R5	10.70	1	018390505

1839/R6

Transformateur de charge rapide USB Q C3.0, pièce de rechange pour 1838POCKET, 1839BRW

	CHF		
1839/R6	31.50	1	018390506

1839/R1

Transformateur avec sortie USB, recharge pour 11833L/USB, 1836B, 1837F/USB, 1838COB, 1838P, 1838S, 1838SLIM, 1838UV, 1838AM, 1838E

CE

	CHF		
1839/R1	31.00	1	018390501

1839/R2

Câble USB/jack 3,5 mm, recharge pour 1836B ; 1838P ; 1838COB; 1838UV

	CHF		
1839/R2	11.90	1	018390502

1839/R4

Câble USB/USB-C, recharge pour 1833L/USB, 1833F/USB, 1838SLIM, 1838S, 1838AM, 1838E

	CHF		
1839/R4	10.50	1	018390504

Beta

Beta

1842LED/BM

Baladeuse à LEDs très haute luminosité,
100- 240 Vac

- Câble de 10 m
- Corps compact en caoutchouc antiglisse
- Verre frontal facile à remplacer
- Crochet orientable
- 340 lumens
- Avec LED en tête pour éclairage multidirectionnel

CE



1842LED/BM	L mm 230	CHF 175.50	1	018420301
------------	----------------	---------------	---	-----------

1842LED/ABM

Baladeuse à LEDs très haute luminosité,
12-24V AC/DC

- Câble de 10 m
- Corps compact en caoutchouc antiglisse
- Verre frontal facile à remplacer
- Crochet orientable
- 320 lumens
- Avec LED en tête pour éclairage multidirectionnel

CE



1842LED/ABM	L mm 230	CHF 166.00	1	018420311
-------------	-------------	---------------	---	-----------

ENROULEURS



La nouvelle gamme complète d'enrouleurs Beta a été conçue et développée dans le but de satisfaire toutes les exigences des professionnels.

- La gamme d'enrouleurs de câble comprend de nombreuses longueurs et types de câbles. Les enrouleurs disposent d'une gamme avec des lampes LED ou avec des prises électriques standard ou SCHUKO.
- La gamme d'enrouleurs de tuyaux comprend des tuyaux de 8 mm et 10 mm de diamètre.

Le ressort haute résistance assure une remarquable longévité et une utilisation tout en douceur. Le caisson en polypropylène épais, permet une résistance unique aux chocs.

Le dispositif Rack permet l'arrêt automatique du rembobinage du câble, il peut être désactivé facilement pour permettre une traction continue

Chaque enrouleur est équipé d'un support mural pivotant à 180 ° et d'un support supplémentaire permettant une connexion ou une déconnexion rapide d'avec celui-ci.

ENROULEURS DE CÂBLES

Une large gamme comprenant pas moins de 18 versions, conçue pour satisfaire toutes les exigences de travail, y compris les utilisateurs les plus exigeants. Leurs longueurs allant de 10 m à 30 m, et leurs sections allant de 2x1. 0 mm² à 5Gx1. 5mm², avec les types de câbles H05VV-F et H07RN-F. Tous les enrouleurs de câble, jusqu'à une section de câble de 3Gx2. 5mm², sont fournis avec des commutateurs de protection thermique, qui sont déclenchés en cas de surcharge du circuit électrique.



ENROULEURS DE TUYAUX



La gamme sélectionnée, avec des longueurs allant de 10 m à 15 m et de 8 mm et 10 mm de diamètre, est préconisée pour une utilisation avec des outils pneumatiques.

Les enrouleurs étant étanches, ils peuvent également être utilisés avec projection d'eau.

Article	Image	Conducteurs	Section	Type de câble	Longueur	Boîtier	Thermal protection	Accessoire
1842 15-H05/LED		2x	1,0 mm ²	H05VV-F	15+1 m	Petit	OUI	Lampe LED
1843 15-H05		2x	1,5 mm ²	H05VV-F	15+1 m	Petit	OUI	
1844 10-H05		3G	1,5 mm ²	H05VV-F	10+1 m	Petit	OUI	-
1844 15-H05	H05VV-F			15+1 m	Petit	OUI	-	
1844 15-H07	H07RN-F			14+1 m	Petit	OUI	-	
1844 30-H05	H05VV-F			30+2 m	Moyen	OUI	-	
1844 15-H05/SCK		3G	1,5 mm ²	H05VV-F	15+1 m	Petit	OUI	SCHUKO
1844 15-H07/SCK	H07RN-F			14+1 m	Petit	OUI	SCHUKO	
1845 12-H05		3G	2,5 mm ²	H05VV-F	12+1 m	Petit	OUI	
1845 15-H07	H07RN-F			15+1 m	Moyen	OUI		
1845 25-H07	H07RN-F			25+1,5 m	Moyen	OUI		
1846 10-H05		4G	1,5 mm ²	H05VV-F	10+1 m	Petit	NON	
1846 10-H07	H07RN-F			10+1 m	Petit	NON		
1846 15-H05	H05VV-F			15+1 m	Petit	NON		
1847 10-H05		4G	2,5 mm ²	H05VV-F	10+1 m	Moyen	NON	
1847 15-H07	H07RN-F			15+1 m	Moyen	NON		
1848 10-H05		5G	1,5 mm ²	H05VV-F	10+1 m	Moyen	NON	
1848 15-H07	H07RN-F			15+1 m	Moyen	NON		

Beta

1842

enrouleur de câble automatique avec lampe d'inspection LED, 100-240Vac

- avec transformateur de sécurité 230/12V
- Câble H05VV-F 2x1,0 mm²
- longueur du câble enroulé: 15 m
- Câble entrant de 1,5 m avec prise de type SCHUKO
- longueur du câble hors du tambour: 1 m
- le mécanisme de rack peut être désactivé pour garder le câble tiré
- fourni avec un support pivotant à 180 ° et un support de connexion rapide supplémentaire

CE



IP42
IP65

1842 15-H05/LED	H05VV-F	L m	CHF	1	018420821
		15+1	438.00		

1846R-LED/BM

Lampe à LED de recharge

12-24V - AC-DC



1846LED/BM R	CHF	1	018460331
	120.00		

1843

enrouleur de câble automatique, avec câble 2x1,5 mm²

- Câble H05VV-F 2x1,5 mm²
- avec interrupteur de protection thermique
- longueur du câble enroulé: 15 m
- longueur du câble hors du tambour: 1 m
- fourni sans câble entrant
- le mécanisme de rack peut être désactivé pour garder le câble tiré
- puissance max. (enroulée): 1300W (230V-20 °C)
- puissance max. (déroulé): 2300W (230V-20 °C)
- fourni avec un support pivotant à 180 ° et un support de connexion rapide supplémentaire

CE



IP42

1843 15-H05	H05VV-F	L m	CHF	1	018430215
		15+1	292.00		

1844

enrouleur de câble automatique, avec câble 3Gx1,5 mm²

- Câble 3Gx1,5 mm²
- avec interrupteur de protection thermique
- longueur du câble hors tambour: 1 m (sauf pour 1844 30-H05, 2 m)
- fourni sans câble entrant
- le mécanisme de rack peut être désactivé pour garder le câble tiré
- puissance max. (enroulée): 1500W (230V-20 °C)
- puissance max. (déroulé): 2500W (230V-20 °C)
- fourni avec un support pivotant à 180 ° et un support de connexion rapide supplémentaire

CE



IP42

1844 10-H05	H05VV-F	L m	CHF	1	018440310
		10+1	260.00		
1844 15-H05	H05VV-F	15+1	285.00		018440315
1844 15-H07	H07RN-F	14+1	310.00		018440317
1844 30-H05	H05VV-F	30+2	548.00		018440330

1844SCK

enrouleur de câble automatique, avec câble 3Gx1,5 mm² et prise de type SCHUKO

- Câble 3Gx1,5 mm²
- avec interrupteur de protection thermique
 - longueur du câble hors du tambour: 1 m
 - fourni avec câble entrant de 1,5 m et prise de type SCHUKO
 - le mécanisme de rack peut être désactivé pour garder le câble tiré
 - puissance max. (enroulée): 1500W (230V-20 °C)
 - puissance max. (déroulé): 2500W (230V-20 °C)
 - fourni avec un support pivotant à 180 ° et un support de connexion rapide supplémentaire

CE



IP42

1844 15-H05/SCK	H05VV-F	L m	CHF	1	018440316
		15+1	298.00		
1844 15-H07/SCK	H07RN-F	14+1	322.00		018440318

1845

enrouleur de câble automatique, avec câble 3Gx2,5 mm²

- Câble 3Gx2,5 mm²
- avec interrupteur de protection thermique
- longueur du câble hors tambour: 1 m (sauf pour 1845 25-H07RN-F, 1,5 m)
- fourni sans câble entrant
- le mécanisme de rack peut être désactivé pour garder le câble tiré
- puissance max. (enroulée): 2000W (230V-20 °C)
- puissance max. (déroulé): 3000W (230V-20 °C)
- fourni avec un support pivotant à 180 ° et un support de connexion rapide supplémentaire

CE



IP42

1845 12-H05	H05VV-F	L m	CHF	1	018450365
		12+1	588.00		
1845 15-H07	H07RN-F	15+1	588.00		018450367
1845 25-H07	H07RN-F	25+1,5	742.00		018450377

1846

enrouleur de câble automatique, avec câble 4Gx1,5 mm²

- Câble 4Gx1,5 mm²
- sans interrupteur de protection thermique
- longueur du câble hors du tambour: 1 m
- fourni sans câble entrant
- le mécanisme de rack peut être désactivé pour garder le câble tiré
- puissance max. (enroulée): 1400W (230V-20 °C)
- puissance max. (déroulé): 1900W (230V-20 °C)
- fourni avec un support pivotant à 180 ° et un support de connexion rapide supplémentaire

CE



IP42

1846 10-H05	H05VV-F	L m	CHF	1	018460405
		10+1	316.00		
1846 10-H07	H07RN-F	10+1	327.00		018460407
1846 15-H05	H05VV-F	15+1	327.00		018460415



1847

enrouleur de câble automatique, avec câble 4Gx2,5 mm²

- Câble 4Gx2,5 mm²
- sans interrupteur de protection thermique
- longueur du câble hors du tambour: 1 m
- fourni sans câble entrant
- le mécanisme de rack peut être désactivé pour garder le câble tiré
- puissance max. (enroulée): 2000W (230V-20 °C)
- puissance max. (déroulé): 2700W (230V-20 °C)
- fourni avec un support pivotant à 180 ° et un support de connexion rapide supplémentaire

CE



IP42

	L m	CHF		
1847 10-H05	H05VV-F 10+1	340.00	1	018470420
1847 15-H07	H07RN-F 15+1	632.00	1	018470427

1848

enrouleur de câble automatique, avec câble 5Gx1,5 mm²

- Câble 5Gx1,5 mm²
- sans interrupteur de protection thermique
- longueur du câble hors du tambour: 1 m
- fourni sans câble entrant
- le mécanisme de rack peut être désactivé pour garder le câble tiré
- puissance max. (enroulée): 1400W (230V-20 °C)
- puissance max. (déroulé): 1900W (230V-20 °C)
- fourni avec un support pivotant à 180 ° et un support de connexion rapide supplémentaire

CE



IP42

	L m	CHF		
1848 10-H05	H05VV-F 10+1	353.00	1	018480510
1848 15-H07	H07RN-F 15+1	675.00	1	018480517

1852R1750

Pistolet à induction portable



CE

- Réchauffe et débloque les boulons, les écrous, les moyeux et les roulements particulièrement bloqués sans utiliser de flammes
 - Permet de réchauffer tout type de métal ferromagnétique
- Pièces fournies :
- Deux serpentins avant avec diamètre 19 et 26 mm pour déblocage écrous
 - Un serpent plat pour réchauffer les surfaces
 - Un serpentin fil exible de 800 mm de longueur
 - Présenté dans un coffret en plastique

Données techniques :

- tension d'entrée : 230V AC, 50/60 Hz
- courant d'entrée : max. 7,5A
- puissance : max. 1.75 kW

EN OPTION

D'autres mesures de serpentins sont disponibles

AVANTAGES

Économie de temps : réchauffement rapide et grande précision
Sécurité anti-incendie : ne génère pas de flammes, sécurité maximum pour l'opérateur
Pratique : utilisable avec une seule main et serpentins facilement interchangeables

DOMAINES D'APPLICATION

Automotive
Maintenance industrielle
Industrie aéronautique
Industrie navale
Industrie pétrochimique

1852R1750	CHF 1,960.00	1	018520175
-----------	--------------	---	-----------

480x370x130 mm - 4,5 kg

1852S-CNT

bobine de contact



1852S-CNT	CHF 147.00	1	018520520
-----------	------------	---	-----------

1852S-CC

bobine de cuillère



1852S-CC	CHF 118.00	1	018520521
----------	------------	---	-----------

1852S-KR/CNT

kit de pièces de rechange pour bobine de contact



1852S-KR/CNT	CHF 64.00	1	018520522
--------------	-----------	---	-----------

1852S-L

Serpentins avec branchement sur le côté



	Ø mm	M	L mm	CHF		
1852S-L 19	19	M6	220	59.50	1	018520501
1852S-L 20	20	M8	220	59.50	1	018520502
1852S-L 23	23	M10	220	59.50	1	018520503
1852S-L 26	26	M12	220	59.50	1	018520504
1852S-L 32	32	M16	220	59.50	1	018520505
1852S-L 38	38	M20	220	68.00	1	018520506
1852S-L 45	45	M22	220	75.00	1	018520507

1852S-F

Serpentin avec branchement sur le devant



	Ø mm	M	L mm	CHF		
1852S-F 19	19	M6	220	59.50	1	018520508
1852S-F 20	20	M8	220	59.50	1	018520509
1852S-F 23	23	M10	220	59.50	1	018520510
1852S-F 26	26	M12	220	59.50	1	018520511
1852S-F 32	32	M16	220	59.50	1	018520512
1852S-F 38	38	M20	220	68.00	1	018520513
1852S-F 45	45	M22	220	72.50	1	018520514

1852S-FLESS

Serpentin flexible



	L mm	CHF		
1852S-FL750	750	44.00	1	018520519
1852S-FLESS	800	111.50	1	018520515
1852S-FL1000	1000	143.00	1	018520517
1852S-FL1500	1500	169.00	1	018520518

1852 S-PIATTE

Serpentin plat



1852S-PIATTE	CHF 68.00	1	018520516
--------------	-----------	---	-----------

Beta



SOUDAGE

POSTES À SOUDER À ONDULEUR

Postes à souder à onduleur faciles à utiliser, excellentes caractéristiques de soudage avec tous les types d'électrodes. Équipés d'un contrôle de surtension, de surchauffe et d'anti-collage de l'électrode. Compacts et légères, idéales pour les travaux d'entretien ménager, la menuiserie légère et les travaux d'entretien.

MASQUES POUR SOUDAGE

Beta propose différents masques LCD à obscurcissement automatique adaptés aux différents types de soudage : électrode, MIG/MAG, TIG et plasma. La protection et le confort sont garantis par le respect total de toutes les réglementations de sécurité en vigueur.

ACCESSOIRES DE SOUDAGE

Large gamme d'accessoires pour soutenir les opérations liées aux travaux de soudage.

POSTES À SOUDER POUR ÉTAIN ET AU GAZ

Postes à souder et accessoires conçus pour les petites opérations de maintenance et l'usinage dans le domaine de la microélectronique. En plus des soudeuses à câble, Beta propose diverses solutions au gaz butane qui permettent également de travailler en extérieur et en l'absence d'électricité.

1808

Fer à souder bi-watts
avec panne droite pointue en acier 1824R8



W	V	CHF		
20/130	230	108.00	1	018080001

1812 150

Fer à souder instantané



W	V	CHF		
150	230	154.50	1	018120015

1814M

Fer à souder pour l'électronique
avec panne droite en acier



W	V	CHF		
25	230	87.00	1	018140225
30	230	91.00	1	018140230
40	230	99.00	1	018140240

1820

Fer à souder



	CHF		
1820 30 30W L = 210mm	64.00	1	018200003
1820 60 60W L = 220mm	73.00	1	018200006
1820 80 80W L = 260mm	103.50	1	018200008

1822

Fer à souder marteau



	CHF		
1822 120 120W LxA = 250x125mm	158.00	1	018220012
1822 180 180W LxA = 250x125mm	167.50	1	018220018
1822 320 320W LxA = 250x140mm	208.50	1	018220032

1823 60

Poste de soudage
thermorégulé
à contrôle numérique

- Réglage continu de la température de 160 °C à 480 °C (précision ±1%).
- Fonction mémoire pour sauvegarde de la température sélectionnée au moment de l'arrêt.
- 3 touches de sélection rapide (200-300-400 °C).



W	CHF		
60	613.00	1	018230060

1823R/60

Fer à souder pour 1823 60



	CHF		
1823R 60	121.00	1	018230066



1824R

Panne pour fer à souder

	CHF		
1824R 08 1808	46.00	1	018240100
1824R 12 1812/150	6.20	1	018240301
1824R 14-M25 1814M/25	6.20	1	018240152
1824R 14-M30 1814M/30	6.20	1	018240153
1824R 14-M40 1814M/40	6.20	1	018240154
1824R 20 1820/30	8.20	1	018240302
1824R 60 1820/60	8.20	1	018240303
1824R 80 1820/80	11.90	1	018240304
1824R 120-180 1822/120 -/180	96.00	1	018240305
1824R 320 1822/320	122.00	1	018240307
1824R ST-60 1823-60	16.90	1	018240308

1825B

Fil à souder en étain avec antioxydant

- fil de 1 mm² ; 250 g
- Sn 99.3% ; Cu 0.7%



	CHF		
1825B	90.00	1	018250251

1827

Fer à souder au gaz réglable



	CHF		
1827	193.50	1	018270001

1827PC

Pannes coniques pour 1827



	CHF		
1827PC 1,6	40.50	1	018270501
1827PC 3,2	40.50	1	018270502

1827PCL

Pannes à lame pour 1827



	CHF		
1827PCL 2,4	40.50	1	018270503

1827PFL

Pannes à flamme nue pour 1827



CHF
40.50

1 018270504

1827/K

Fer à souder au gaz avec 7 accessoires en coffret avec plateau en mousse compacte



- Puissance : de 30 Watts jusqu'à 125 Watts
- Température de la panne réglable de 250 °C jusqu'à 500 °C
- Régulateur du flux de gaz
- Temps de réchauffement : 15 secondes après l'allumage
- Réservoir contenant assez de gaz pour 120 minutes d'utilisation en continu
- Réservoir transparent permettant de surveiller le niveau du gaz
- Rechargeable avec du gaz butane

CHF
299.00

1 018270100

1827F

Mini lampe à souder à gaz butane rechargeable
Réservoir de 35 g

- Trois buses interchangeables de 550 °C ; 1000 °C et 1300 °C
- Fournie avec trépied dans coffret rigide



CHF
212.50

1 018270200

1830T

Pompe à dessouder avec embout antistatique en matière plastique



L
mm
190

CHF
22.80

5 018300021

1860BH/120A

Poste à souder à onduleur en courant continu (DC) pour le soudage MMA avec électrodes rutiles, basiques et en acier inoxydable.
Compact et facile à transporter

Fonctions arc réglable (arc force), démarrage à chaud (hotstart), anti-collage (anti-sticking), protection thermostatique

Courant de réglage : 10÷120A
Alimentation : 1x230V

Facteur d'utilisation (40 °C) :

25% - 120 A

50% - 80 A

100% - 60 A

Protection : IP22S

Électrodes utilisables: Ø 1.6 - 3.2mm rutiles, basiques, inox, fonte etc.

Fourni avec câbles de 16 mm²

CE



CHF
472.00

1 018600121

1860BH/120A

1860BH/160A

Poste à souder à onduleur en courant continu (DC) pour le soudage MMA avec électrodes rutiles, basiques et en acier inoxydable.
Compact et facile à transporter

Fonctions arc réglable (arc force), démarrage à chaud (hotstart), anti-collage (anti-sticking), protection thermostatique

Courant de réglage : 10÷160A
Alimentation : 1x230V

Facteur d'utilisation (40 °C) :

25% - 160 A

60% - 100 A

100% - 80 A

Protection : IP22S

Électrodes utilisables: Ø 1.6 - 4mm rutiles, basiques, inox, fonte etc.

Fourni avec câbles de 16 mm²

CE



CHF
609.00

1 018600161

1860BH/160A

1860BH/200A

Poste à souder à onduleur en courant continu (DC) pour le soudage MMA avec électrodes rutiles, basiques et en acier inoxydable.
Compact et facile à transporter

Fonctions arc réglable (arc force), démarrage à chaud (hotstart), anti-collage (anti-sticking), protection thermostatique

Courant de réglage : 10÷160A
Alimentation : 1x230V

Facteur d'utilisation (40 °C) :

25% - 200 A

60% - 130 A

100% - 100 A

Protection : IP22S

Électrodes utilisables: Ø 1.6 - 4mm rutiles, basiques, inox, fonte etc.

Fourni avec câbles de 16 mm²

CE



CHF
677.00

1 018600201

1860BH/200A

1860BH R/CM

Câbles de masse pour poste à souder à onduleur 1860BH-120/160/200A



CHF
65.00

1 018600612

1860BH R/CM

1860BH R/CS

Câbles de pince porte-électrode pour poste à souder à onduleur 1860BH-120/160/200A



CHF
79.50

1 018600613

1860BH R/CS

1860BHT/160A

Poste à souder à onduleur en courant continu (DC) pour soudage à l'électrode MMA et TIG sur acier.

Compact et facile à transporter

Fonctions arc réglable (arcforce), STICK/TIG (lift arc), démarrage à chaud (hotstart), anti-collage (anti-sticking), protection thermostatique

Courant de réglage : 10÷160A
Alimentation : 1x230V

Facteur d'utilisation (40 °C) :

60 % - 160 A

100 % - 130 A

Protection : IP23S

Électrodes utilisables : Ø 1,6 - 4 mm rutiles, basiques, en acier inoxydable.

Fourni avec câbles de 25 mm²

CE



1860BHT/160A	CHF 1,185.00	1	018600179
--------------	-----------------	---	-----------

1860BHT R/CM

Câbles de masse pour poste à souder TIG 1860BHT



1860BHT R/CM	CHF 101.00	1	018600616
--------------	---------------	---	-----------

1860BHT R/CS

Câbles de pince de soudage pour poste à souder TIG 1860BHT



1860BHT R/CS	CHF 130.00	1	018600617
--------------	---------------	---	-----------

1860BHT/T

Torches TIG pour postes à souder TIG 1860BHT

Longueur du câble : 4m
Section du câble : 50mm²



1860BHT/T	CHF 321.00	1	018600615
-----------	---------------	---	-----------

1860M

Étau d'angle magnétique avec réglage rapide pour le soudage

Avec mors oscillants

idéal pour bloquer les pièces de différentes tailles

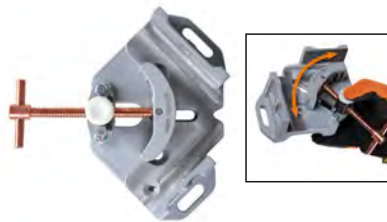

1860M	L max mm 30	CHF 121.50	1	018600301
-------	-------------------	---------------	---	-----------

1860DM

Disque magnétique pour levage de tôles

Idéal pour la manipulation et la fixation de tôles

Force magnétique constante sur toute la surface du disque
Poignées à trous pour faciliter l'usinage vertical



1860DM 16	kg max 16	CHF 69.50	1	018600310
1860DM 40	40	98.00	1	018600311

1860PMIG

Pince multi-usages pour le soudage MIG



1860PMIG	L mm 215	L1 mm 44	CHF 50.00	2	018600350
----------	----------------	----------------	--------------	---	-----------

1860EI

Équerre magnétique 90°, pour angles internes et externes

Idéal pour positionner vos pièces avant de souder
18 kg de force magnétique
avec ébavurage pour angles de 30 et 60°
et orifice hexagonal pour faciliter le détachement de l'aimant du métal



1860EI	L mm 165	L1 mm 110	S mm 35	CHF 49.00	1	018600290
--------	----------------	-----------------	---------------	--------------	---	-----------

1860RG

Équerre magnétique réglable 30°÷270°

Idéal pour positionner vos pièces avant de souder

15 kg de force magnétique

Clé 6 pans fournie pour blocage réglage angle
embout fourni pour blocage réglage à 30°-45°-90°/270°-180°
Avec orifice hexagonal pour faciliter le détachement de l'aimant du métal



1860RG	L mm 155	S mm 35	CHF 78.50	1	018600255
--------	----------------	---------------	--------------	---	-----------

1860SQ

Équerre magnétique 45°/90°

Idéal pour positionner vos pièces avant de souder

25 kg de force magnétique

sans pile, effet marche/arrêt obtenu avec l'inclinaison des aimants internes

L'interrupteur sur arrêt permet de démagnétiser l'aimant et de se débarrasser de limailles de fer



1860SQ	CHF 119.50	1	018600210
--------	---------------	---	-----------





7041LCD/4S

Masque LCD à obscurcissement automatique pour soudure à électrode ; MIG/MAG ; TIG et plasma.

4 capteurs

avec filtre TRUE COLOR

alimentation à cellules solaires et batteries au lithium pour une durée exceptionnelle du filtre LCD

- aire visuelle 98x80 mm
- tonalité d'obscurcissement variable 5+8,5/9-13 avec réglage interne
- protection UV/IR : DIN16
- temps d'obscurcissement 1/25000 s
- temps d'éclaircissement 0,1-2,0 s
- sensibilité et retard de l'obscurcissement réglables
- mise en marche et arrêt automatiques
- fonction de meulage
- indicateur bas niveau de la batterie
- design ergonomique, léger et bien équilibré
- avec douille réglable



7041LCD/4S CHF 389.00 1 070410001

7041LCD/4S-VE

Verre frontal anti-écaflure externe pour 7041LCD/4S

7041LCD/4S-VE CHF 9.50 2 070410101

7041LCD/4S-VI

Verre interne pour 7041LCD/4S

7041LCD/4S-VI CHF 4.80 2 070410102

7042LCD

Masque LCD à obscurcissement automatique pour soudage à l'électrode; MIG/MAG; TIG et plasma.

Alimentation par cellules solaires et batteries au lithium pour une durée exceptionnelle du filtre LCD

- Champ de vision 98x43 mm
- Tonalité d'obscurcissement DIN 9-13 avec réglage externe
- Protection UV/IR
- Temps d'obscurcissement 1/25000 s
- Temps d'éclaircissement 0.25-1s
- Sensibilité et retard de l'obscurcissement réglables
- Mise en marche et arrêt automatiques
- Fonction de meulage
- Forme optimisée pour faciliter la respiration lorsque la visière est abaissée



7042LCD CHF 273.00 1 070420001

7042LCD/RV

Verre anti-écaflures pour 7042LCD, 7043

7042LCD/RV CHF 4.30 2 070420101

7042LCD/RV-INT

Écran intérieur pour 7042LCD, 7043

7042LCD/RV-INT CHF 3.80 2 070420102

7043

Masque LCD à obscurcissement automatique, pour soudage à l'électrode, MIG/MAG, TIG et plasma.

Alimentation par cellules solaires.

- Champ de vision 92x43 mm
- Tonalité d'obscurcissement DIN 9-13 avec réglage externe
- Protection UV/IR
- Temps d'obscurcissement 1/1000 s
- Temps d'éclaircissement 0.1-1.0 s
- Retard de l'obscurcissement réglable
- Mise en marche et arrêt automatiques
- Fonction de meulage
- Forme optimisée pour faciliter la respiration lorsque la visière est abaissée



7043 CHF 158.00 1 070430001

REPARATION DE VEHICULES

Nos outils de réparation de véhicules qui sont utilisés par les professionnels les plus exigeants, sont développés et fabriqués pour répondre aux normes les plus élevées du monde, et régulièrement testés dans les conditions de fonctionnement les plus difficiles.

Depuis plus de 50 ans, nous travaillons fièrement et en collaboration les plus grands champions des sport mécaniques, nous aidant à améliorer continuellement nos produits et témoignant du niveau de qualité PREMIUM.

Les outils de réparations de véhicules se trouvent dans les sections:

Diagnostics	articles 1438 to 1499 articles 1758VT to 1760TMC
Moteur	articles 955 to 989A articles 1438 to 1499
Vidange	articles 1438 to 1499 articles 1877 to 1885
Système électrique	articles 1438 to 1499
Boosters de démarrage	articles 1498BC/12 to 1498/40A
Transmission	articles 1438 to 1499
Suspension	articles 1549 to 1569CP
Freins	articles 1438 to 1499
Roues	articles 955 to 989A
Carrosserie	articles 1302 to 1369 articles 1763 to 1767A
Autres équipements	articles 1875LT to 3067
Levage	articles 3029/2T to 3067/70-13T



1875LT

Nettoyeur pour moquettes et tissus d'ameublement à injection et extraction

Parfait pour laver en profondeur les surfaces textiles. Emploie un détergent pulvérisé sous pression et l'aspire avec la saleté, laissant les surfaces pratiquement sèches.

Accessoires fournis :

- 1 tuyau flexible avec branche ergonomique
- 1 groupe de distribution
- 2 rallonges rigides
- 1 petit embout de pulvérisation
- 1 grand embout de pulvérisation
- 6 douilles de blocage du câble d'alimentation électrique

CE



1875LT CHF 746.00 1 018750000

1875SP/K3

Kit de brosses pour le nettoyage des tissus

- 1 brosse plate Ø 48 mm
- 1 brosse plate Ø 100 mm
- 1 brosse hémisphérique Ø 90 mm
- coupleur pour clé à chocs 1/4"

1/4



ISO 1173 E 6,3

1875SP/K3 CHF 24.10 1 018750010

1877

Récupérateur para gravité de 90 litres avec bac et grille Récupérateur d'huile par gravité de 90 litres avec bac et grille

- indicateur de niveau
- entonnoir de grand diamètre avec égouttoir à filtre de 12 litres
- vidage pneumatique du réservoir avec tuyau de 1,8 m
- bac porte-outils

CE



1877 CHF 929.00 1 018770008

1877A

Récupérateur à double fonction par aspiration et par gravité de 90 litres avec préchambre

- indicateur de niveau
- entonnoir de grand diamètre avec égouttoir à filtre de 12 litres
- préchambre transparente de 9,5 litres
- tuyau d'aspiration de 1,8 m
- vidage pneumatique du réservoir avec tuyau de 1,8 m
- bac porte-outils

Pièces fournies :

- 1 sonde rigide Ø 5x700 mm
- 1 sonde flexible Ø 5x700 mm
- 1 sonde rigide Ø 6x600 mm
- 1 sonde flexible Ø 6x700 mm
- 1 sonde flexible Ø 7x700 mm
- 1 sonde flexible Ø 8x700 mm
- adaptateurs pour VW, BMW, CITROËN

CE



1877A CHF 1,645.00 1 018770080

1877F

Récupérateur d'huile usée pour flacons de 1 litre

- Peut contenir jusqu'à à 4 flacons simultanément
- 2 bidons de 2 l inclus



H mm 405 L mm 270 P mm 240 CHF 126.50 1 018770100

1877P

Récupérateur à roues d'huile usée avec réservoir en polyéthylène

- Capacité réservoir : 40 l
- Grand bac en PPL pour récupérer l'huile
- Indicateur de niveau
- Vidage pneumatique du réservoir



H min-max mm 1030-1630 H1 mm 900 I mm 40 CHF 565.00 1 018770180

1878 2

Cuve pour récupération des liquides

- Capacité maximale 2 l
- Particulièrement indiquée pour le remplacement huile sur les scooter



I mm 2 H mm 85 CHF 19.00 1 018780002

1878 3

Cuve pour récupération de l'huile moyeux camions

Écoulement de l'huile avec anti-gouttes



I mm 3 CHF 28.50 1 018780003

1878 4

Cuve transportable pour récupération des liquides

- Indiquée pour moto
- Capacité maximale 4 l
- Limite les éclaboussures



I mm 4 H mm 100 CHF 40.50 1 018780004

1878 8

Cuve pour récupération des liquides

- Hauteur adaptée pour moto
- Capacité maximale 8 l



1878 8	l	H mm	CHF		
8		110	21.50	1	018780008

1878 11

Cuve pour récupération des liquides

- Capacité maximum : 11 l
- Bouchon d'écoulement liquides
- Cloison intérieure pour éviter le débordement des liquides pendant le transport



1878 11	l	CHF		
11		47.50	1	018780011

1878 30

Cuve de récupération des liquides

- Capacité maximum : 30 l
- Grille anti-éclaboussures
- Munie de 4 roues pivotantes

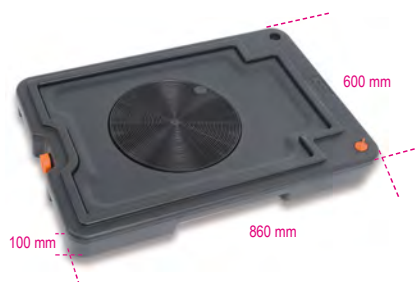

1878 30	l	CHF		
30		185.50	1	018780030

1879

Aspirateur pour liquides manuel et pneumatique (9,5 l)



1879 9,5	CHF			
	401.00	1	018790001	

1879 6

Aspirateur manuel pour liquides (6 l)



1879 6	CHF			
	293.00	1	018790000	

1879R/K4

Kit de 4 tubes pour aspirateur pour liquides 1879



1879R/K4	CHF			
	77.50	1	018790504	

1879/FUEL

Aspirateur manuel des liquides de 6 litres

Utilisable pour hydrocarbures



1879/FUEL	l	CHF		
6		173.50	1	018790010

1880

Pompe à levier pour fûts d'huile

- Pour huile et liquides non agressifs
- Ne pas utiliser avec liquides à base aqueuse, solvants acides, le gasoil, l'essence et autres produits semblables
- Fournie avec fixation fût, tube télescopique et bec verseur
- Utilisable avec fûts de 60, 100 et 200 litres



1880	gr	CHF		
240		75.50	1	018800001

1880ADB

Pompe rotative pour AdBlue®

- 5 litres toutes les vingt rotations
- rallonges pour fûts jusqu'à 1,20 m
- 1 attache pour fûts pas fin
- 1 attache pour fûts pas gros



1880ADB	CHF			
	175.50	1	018800101	

1881

Pompe pneumatique pour fûts rapport 3:1

CE



1881	l/min	CHF		
18		644.00	1	018810001

1882N

Pistolet à huile avec tête flexible et récupérateur de gouttes automatique



1882N	CHF			
	193.50	1	018820110	

1883N

Compteur de litres d'huile numérique



1883N	CHF			
	273.00	1	018830036	

1883NC

Nipler mâle-mâle 1/2 pour unir art. 1882N et 1883N



1883NC CHF 17.00 1 018830135

1884

Outil pour l'introduction d'huile dans les boîtes de vitesses manuelles, automatiques et les différentiels
Comprend 12 adaptateurs pour la connexion directe



1884 CHF 636.00 1 018840010

AT-101	FORD
AT-102	UNIVERSAL (Bmw, Honda, Nissan...)
AT-103	VW-AUDI
AT-104	VW-AUDI-PORSCHE
AT-105	VW-AUDI-MINI COOPER
AT-106	MERCEDES
AT-107	DSG
AT-108	VW-AUDI CVT
AT-109	VOLVO
AT-110	TOYOTA-LEXUS
AT-111	SKODA
AT-112	VW Passat/Tiguan <2007

1884/C12

Coffret d'adaptateurs pour 1884



1884/C12 CHF 235.50 1 018840100

1884N/C8

Jeu de 8 adaptateurs pour 1884

contenu du jeu :

- 1 adaptateur pour Infiniti, 7 vitesses, M8x1.0
- 1 adaptateur pour Honda, Hyundai, Kia 5x8x200 mm
- 1 adaptateur pour Skoda M18x1.5
- 1 adaptateur pour Mini M14x1.5
- 1 adaptateur pour Nissan M10x1.5
- 1 adaptateur pour Nissan Juke M12x1.25
- 1 adaptateur pour GM M12x1.75
- 1 adaptateur pour véhicules du groupe VAG, 7 vitesses



1884N/C8 CHF 154.50 1 018840200

200x145x40 mm - 400 g

1889N

Bac de rétention en acier pour la manutention et le stockage pour 2 fûts de 200 l

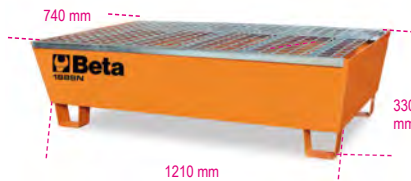

1889N CHF 1,058.00 1 018890220

1889CF

Clé universelle pour l'ouverture des fûts

- 1 hexagone femelle Ø 38 mm
- 1 profil à 4 secteurs Ø 42 mm
- 1 lame 17x7 mm



1889CF CHF 44.50 1 018890010

1885

Poste pour la maintenance de la boîte de vitesses automatiques

Permet d'effectuer en toute sécurité, avec une procédure simple et guidée, le cycle complet de lavage et de remplacement de l'huile dans toutes les transmissions automatiques.

Prévient l'endommagement dérivant de l'usure de l'huile présente dans la boîte de vitesses automatiques, en prévenant de manière pratique et rapide les dysfonctionnements caractéristiques tels que : le bruit excessif de la boîte de vitesses, les vitesses bloquées, les enclenchements brusques des vitesses, l'allongement du temps de changement de vitesse.



CARACTÉRISTIQUES FONCTIONNELLES

Fonctionnement automatique
Procédure guidée avec base de données intégrée
Compensation de la quantité de l'huile introduite avec la même quantité d'huile usée, garantissant ainsi la présence constante de la juste quantité d'huile dans le système
Débitmètre pour contrôle visuel de la qualité de l'huile
Impression de chaque opération effectuée

CARACTÉRISTIQUES AUTOMATIQUES

Introduction de solvant (facultative)
Lavage boîte de vitesses
Vidange d'huile de la coupe
Vidange d'huile du convertisseur
Introduction d'huile dans le convertisseur

CARACTÉRISTIQUES TECHNIQUES

Alimentation : 220 V 50 Hz
Viseurs huile rétroéclairés avec 2 LED lumière blanche
2 balances électroniques
Balances électroniques résolution +/- 10 g
Carte électronique avec écran d'affichage graphique rétroéclairé

1885 CHF 11,250.00 1 018850010



1885/C1

Kit raccords boîte de vitesses automatiques pour 1885

Le kit comprend :

- 1885/C1-R1 raccord boîte de vitesses Land Rover Freelander
- 1885/C1-R2 raccord boîte de vitesses DP0
- 1885/C1-R3 raccord boîte de vitesses ZF 9HP
- 1885/C1-R4 tige de niveau boîte de vitesses ZF 9HP
- 1885/C1-R5 tige de niveau boîte de vitesses Mercedes
- 1885/C1-R6 raccord boîte de vitesses AISIN TG82
- 1885/C1-R7 raccord boîte de vitesses AISIN TG81
- 1885/C1-R8 raccord boîte de vitesses Renault-Nissan



1885/C1 CHF 970.00 1 018850110

1885/C1-R1

Raccord boîte de vitesses Land Rover Freelander pour 1885

Ic01430



1885/C1-R1 CHF 83.50 1 018850111

1885/C1-R2

Raccord boîte de vitesses DP0 pour 1885

Ic0990



1885/C1-R2 CHF 145.50 1 018850112

1885/C1-R3

Raccord boîte de vitesses ZF 9HP pour 1885

Ic0992



1885/C1-R3 CHF 163.00 1 018850113

1885/C1-R4

Tige de niveau boîte de vitesses ZF 9HP pour 1885

Ic0192



1885/C1-R4 CHF 90.50 1 018850114

1885/C1-R5

Tige de niveau boîte de vitesses Mercedes pour 1885

K-A-M



1885/C1-R5 CHF 150.50 1 018850115

1885/C1-R6

Raccord boîte de vitesses AISIN TG82 pour 1885

Ic01820



1885/C1-R6 CHF 161.00 1 018850116

1885/C1-R7

Raccord boîte de vitesses AISIN TG81 pour 1885

Ic0150



1885/C1-R7 CHF 161.00 1 018850117

1885/C1-R8

Raccord boîte de vitesses Renault-Nissan pour 1885

Ic02150



1885/C1-R8 CHF 161.00 1 018850118

1885/C2

Kit raccords boîte de vitesses automatiques pour 1885

Le kit comprend :

- 1885/C2-R1 raccord boîte de vitesses Audi 8HP
- 1885/C2-R2 raccord boîte de vitesses ZF 9HP sans échangeur
- 1885/C2-R3 raccord boîte de vitesses Audi 0KC
- 1885/C2-R4 raccord boîte de vitesses AG4-ZF 4HP
- 1885/C2-R5 raccord boîte de vitesses FIAT
- 1885/C2-R6 raccord boîte de vitesses Audi Q5-Q7
- 1885/C2-R7 raccord boîte de vitesses Audi 0B5



1885/C2 CHF 787.00 1 018850120

1885/C2-R1

Raccord boîte de vitesses Audi 8HP pour 1885

Ic0993



1885/C2-R1 CHF 158.00 1 018850121

1885/C2-R2

Raccord boîte de vitesses ZF 9HP sans échangeur pour 1885

Ic0860



1885/C2-R2 CHF 103.00 1 018850122

1885/C2-R3

Raccord boîte de vitesses Audi 0KC pour 1885

Ic02020



1885/C2-R3 CHF 161.00 1 018850123

1885/C2-R4

Raccord boîte de vitesses AG4-ZF 4HP pour 1885

Ic0750



1885/C2-R4 CHF 139.00 1 018850124

1885/C2-R5

Raccord boîte de vitesses FIAT pour 1885

Ic0061



1885/C2-R5 CHF 60.50 1 018850125

1885/C2-R6

Raccord boîte de vitesses Audi Q5-Q7 pour 1885

Ic0680



1885/C2-R6 CHF 150.50 1 018850126

1885/C2-R7

Raccord boîte de vitesses Audi 0B5 pour 1885

Ic01720



1885/C2-R7 CHF 90.50 1 018850127

1885/C3

Kit raccords boîte de vitesses automatiques pour 1885

Le kit comprend :

- 1885/C3-R1 raccord boîte de vitesses DSG Mercedes
- 1885/C3-R2 raccord boîte de vitesses POWERSHIFT
- 1885/C3-R3 raccord boîte de vitesses Toyota IQ
- 1885/C3-R4 raccord boîte de vitesses Mazda
- 1885/C3-R5 raccord boîte de vitesses Renault Laguna-Esp
- 1885/C3-R6 raccord boîte de vitesses Nissan Juke
- 1885/C3-R7 raccord boîte de vitesses AISIN TF71 FV
- 1885/C3-R8 raccord boîte de vitesses AISIN TF71 FP
- 1885/C3-R9 raccord boîte de vitesses AISIN TF71 FO
- 1885/C3-R10 raccord boîte de vitesses AISIN TF71 FS



1885/C3 CHF 1,390.00 1 018850130

1885/C3-R1

Raccord boîte de vitesses DSG Mercedes pour 1885

Ic0191



1885/C3-R1 CHF 161.00 1 018850131

1885/C3-R2

Raccord boîte de vitesses POWERSHIFT pour 1885

Ic0190



1885/C3-R2 CHF 161.00 1 018850132

1885/C3-R3

Raccord boîte de vitesses Toyota IQ pour 1885

Ic0991



1885/C3-R3 CHF 161.00 1 018850133

1885/C3-R4

Raccord boîte de vitesses Mazda pour 1885

Ic02130



1885/C3-R4 CHF 161.00 1 018850134

1885/C3-R5

Raccord boîte de vitesses Renault Laguna-Esp pour 1885

Ic02150



1885/C3-R5 CHF 161.00 1 018850135

1885/C3-R6

Raccord boîte de vitesses Nissan Juke pour 1885

Ic02140



1885/C3-R6 CHF 161.00 1 018850136

1885/C3-R7

Raccord boîte de vitesses AISIN TF71 FV pour 1885

Ic01420



1885/C3-R7 CHF 161.00 1 018850137

1885/C3-R8

Raccord boîte de vitesses AISIN TF71 FP pour 1885

Ic001420/1



1885/C3-R8 CHF 161.00 1 018850138

1885/C3-R9

Raccord boîte de vitesses AISIN TF71 FO pour 1885

Ic001420/2



1885/C3-R9 CHF 161.00 1 018850139

1885/C3-R10

Raccord boîte de vitesses AISIN TF71 FS pour 1885

Ic001420/3



1885/C3-R10 CHF 161.00 1 018850140

1885/XC60

Raccord boîte de vitesses Volvo XC60 pour 1885



1885/XC60 CHF 173.00 1 018850151

1893/134A

Poste automatique de recharge des climatiseurs à gaz R134a

Modèle complètement automatique avec base de données auto/camions, avec quantité de gaz, quantité et type d'huile compresseur, logiciel d'auto-diagnostic pour opérations d'entretien ordinaire.

La base de données peut être mise à jour avec un logiciel. La machine peut travailler en modalité manuelle (avec supervision humaine phase par phase) ou en modalité complètement automatique (sans supervision).



R134A (250 ml)

CARACTÉRISTIQUES FONCTIONNELLES

Fonctionnement automatique
Base de données auto/camions avec quantités de gaz, quantités et type d'huile compresseur
Récupération automatique du gaz s'échappant du tuyau
Compensation de la recharge de la quantité de gaz contenu dans les tuyaux
Échappement automatique des gaz non condensables
Indication automatique d'anomalies et maintenance
Manomètres ø 80 mm
Vacuomètre digital

CARACTÉRISTIQUES TECHNIQUES

Réservoir gaz : 15 kg
Pompe à vide : 75 l/mn
Balance électronique : 50 kg
Carte électronique avec écran d'affichage rétroéclairé
Vitesse de reprise : 500 t/mn
Alimentation : 220 V

1893/134A CHF 8,180.00 1 018930001

1893/1234YF

Poste automatique de recharge des climatiseurs à gaz R1234yf

Modèle complètement automatique avec base de données auto/camions, avec quantité de gaz, quantité et type d'huile compresseur, logiciel d'auto-diagnostic pour opérations d'entretien ordinaire.

La base de données peut être mise à jour avec un logiciel. La machine peut travailler en mode manuel avec supervision humaine phase par phase ou en mode totalement automatique sans aucune supervision.



CE



1234YF (250 ml)

CARACTÉRISTIQUES FONCTIONNELLES

Fonctionnement automatique
Base de données auto/camions avec quantités de gaz, quantités et type d'huile compresseur
Récupération automatique du gaz s'échappant du tuyau
Compensation de la recharge de la quantité de gaz contenu dans les tuyaux
Échappement automatique des gaz non condensables
Indication automatique d'anomalies et maintenance
Manomètres ø 80 mm
Vacuomètre digital

CARACTÉRISTIQUES TECHNIQUES

Réservoir gaz : 15 kg
Pompe à vide : 75 l/mn
Balance électronique : 50 kg
Carte électronique avec écran d'affichage rétroéclairé
Vitesse de reprise : 500 t/mn
Alimentation : 220 V

1893/1234YF CHF 8,440.00 1 018930012

1893TR/134A

Traceur pour gaz R134a



1893TR/134A ml 250 CHF 57.00 1 018930901

1893TR/1234YF

Traceur pour gaz R1234yf



1893TR/1234YF ml 250 CHF 65.50 1 018930902

1893TR/CI

Traceur pour compresseurs hybrides



1893TR/CI ml 250 CHF 68.00 1 018930903

1895G

Générateur de commande pour injecteurs électroniques (essence et GPL) et électrovannes

Permet de tester en pleine autonomie l'efficacité de composants tels que :

- électrovannes EGR
- injecteurs électroniques de moteurs essence et GPL
- Électrovannes pour le réglage des turbines à géométrie variable
- compresseurs pour climatiseurs de nouvelle génération



CE

AVANTAGES

- Permet de comprendre si le composant est mécaniquement fonctionnant
 - Avec les cuves à ultrasons, le nettoyage des composants commandé électroniquement est plus efficace pendant la phase de lavage
 - Lors du contrôle des climatiseurs, il est indispensable pour établir l'efficacité du compresseur et de sa vanne de réglage
- ### CARACTÉRISTIQUES TECHNIQUES
- Commande injecteurs essence et GPL :
- nombre de sorties : 4
 - durée du test : 1-60 s
 - Temps d'ouverture : 5-10 ms
 - Réglage fréquence percussion : 1-10 Hz
- Commande dispositifs PWM :
- nombre de sorties : 1
 - durée du test : 1-60 mn
 - Automatique ou manuel
 - Réglage duty cycle : 10%-85%
 - Réglage fréquence signal : 120-250 Hz
- Comprend 4 connecteurs avec terminaux faston femelle
Alimentation : 110-220 V
Dimensions : 334x240x74 mm
Poids : 4 kg

1895G CHF 2,440.00 1 018950800

1895/S

Support réglable pour cuves à ultrasons 1895

Permet le positionnement correct des injecteurs pendant la phase de lavage dans la cuve à ultrasons

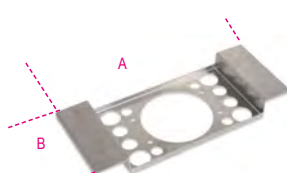

1895S A mm 340 B mm 140 CHF 144.50 1 018950501

1895 6

Cuve de lavage à ultrasons de 6 litres

Avec fonction spéciale de dégazage



CE

- À travers le réchauffement du liquide et avec l'action des ultrasons, permet de nettoyer efficacement les pièces de rechange et les pièces métalliques en général (injecteurs, carburateurs, vannes etc.)
- Écran numérique avec réglage de la température et du temps de lavage
- Double fonction lavage: "soft" et "normal"
- Pour un nettoyage général, il suffit d'utiliser de l'eau à une température de 50/60 °C
- Pour un nettoyage plus méticuleux, ajouter des solutions détergentes non moussantes indiquées pour les cuves à ultrasons
- La fonction de dégazage accélère l'évacuation de l'air dans tout le volume de la cuve en augmentant l'efficacité des ultrasons

DONNÉES TECHNIQUES
Capacité cuve : 6 litres
Robinet de déchargement
Puissance : 150 Watt
Puissance de réchauffement : 300 Watt
Réglage température : 0+80 °C
Réglage temps de lavage : 0-99 minutes
Fréquence : 40 kHz
Alimentation : 220/230V
Dimensions : 330x180x310 mm
Dimensions réservoir : 300x155x150 mm
Dimensions panier : 250x105x100 mm
Poids : 6,7 kg

1895 6 Max 5,5 CHF 942.00 1 018950060

1895 13

Cuve de lavage à ultrasons de 13 litres

Avec fonction spéciale de dégazage



CE

- À travers le réchauffement du liquide et avec l'action des ultrasons, permet de nettoyer efficacement les pièces de rechange et les pièces métalliques en général (injecteurs, carburateurs, vannes etc.G9)
- Écran numérique avec réglage de la température et du temps de lavage
- Double fonction lavage : "soft" et "normal"
- Pour un nettoyage général, il suffit d'utiliser de l'eau à une température de 50/60 °C
- Pour un nettoyage plus méticuleux, ajouter des solutions détergentes non moussantes indiquées pour les cuves à ultrasons
- La fonction de dégazage accélère l'évacuation de l'air dans tout le volume de la cuve en augmentant l'efficacité des ultrasons

DONNÉES TECHNIQUES
Capacité cuve : 13 litres
Robinet de déchargement
Puissance : 300 Watt
Puissance de réchauffement : 400 Watt
Réglage température : 0+80 °C
Réglage temps de lavage : 0-99 minutes
Fréquence : 40 kHz
Alimentation : 220/230V
Dimensions : 350x325x320 mm
Dimensions réservoir : 325x235x145 mm
Dimensions panier : 257x185x100 mm
Poids : 10,5 kg

1895 13 Max 12 CHF 1,460.00 1 018950130

1895 27

Cuve de lavage à ultrasons de 27 litres

Avec fonction spéciale de dégazage



- À travers le réchauffement du liquide et avec l'action des ultrasons, permet de nettoyer efficacement les pièces de rechange et les pièces métalliques en général (injecteurs, carburateurs, vannes etc.)
- Écran numérique avec réglage de la température et du temps de lavage
- Double fonction lavage: "soft" et "normal"
- Pour un nettoyage général, il suffit d'utiliser de l'eau à une température de 50/60 °C
- Pour un nettoyage plus profond, ajouter des solutions détergentes non moussantes spéciales pur cuves à ultrasons
- La fonction de dégazage accélère l'évacuation de l'air dans tout le volume de la cuve en augmentant l'efficacité des ultrasons

DONNÉES TECHNIQUES

Capacité cuve : 27 litres
 Robinet de déchargement
 Puissance : 500 Watt
 Puissance de réchauffement : 500 Watt
 Réglage température : 0+80 °C
 Réglage temps de lavage : 0-99 minutes
 Fréquence : 40 kHz
 Alimentation : 220/230V
 Dimensions : 530x330x380 mm

1895 27	Max 25	CHF 2,035.00	1	018950270
---------	--------	--------------	---	-----------

1895/RC

Panier pour cuves à ultrasons 1895



	L mm	L1 mm	A mm	CHF		
1895/RC6	250	105	100	59.50	1	018950506
1895/RC13	257	185	100	94.00	1	018950513
1895/RC27	450	250	150	158.50	1	018950527

9881U



9881U 1 (1-2)	567
9881U 1 (3)	567

9882R



9882R 1 (1-2)	567
9882R 1 (3)	567

1897

Sableuse d'établi professionnelle

- Particulièrement indiquée pour les opérations de finition superficielle de différents matériaux (métal, plastique, verre, céramique, bois etc.). La cabine est réalisée en tôle d'acier avec des renforcements pour garantir une grande robustesse et une bonne stabilité. La cabine est dotée de :
- porte de chargement avec fermeture à aimants
 - plan en tôle perforée
 - Coupleur standard pour aspirateurs Ø 36mm
 - fenêtre de visualisation en polycarbonate de protection de 6 mm
 - éclairage avec ampoule au LED
 - circuit pneumatique (arrivée d'air comprimé)
 - pistolet de sablage avec fonctionnement à gâchette



DONNÉES TECHNIQUES

Dimensions utiles de la cabine : 600x520x320 mm
 Dimensions d'encombrement : 660x530x500 mm
 Poids : 38 kg
 Plan de travail : tôle perforée
 Éclairage : LED
 Consommation d'air : 340 l/mn à 7 atm
 Alimentation : 220 V - 50 Hz

1897	CHF 4,530.00	1	018970066
------	--------------	---	-----------

1897/CRB

Coridon pour sableuse 1897 en sac de 25 kg



1897CRB	CHF 227.00	1	018970101
---------	------------	---	-----------

1897/G

Garnet pour sableuse 1897 en sac de 25 kg



1897G	CHF 182.00	1	018970104
-------	------------	---	-----------

1897/MV

Microsphères en verre pour sableuse 1897 en sac de 25 kg



1897MV	CHF 300.00	1	018970103
--------	------------	---	-----------

1898/K40

Bac manuel pour le nettoyage de pièces mécaniques à recirculation avec liquide chauffé et bactéries

- Permet l'élimination des coûts d'écoulement pour solvants ou hydrocarbures ;
- en utilisant le détergent écologique Beta à base d'enzymes et bactéries, il permet l'élimination et l'écoulement des différents résidus de graisse présents sur les pièces mécaniques ;
- la fonction enzymatique aide à séparer la partie huileuse de la partie solide de saleté tandis que les bactéries transforment cette dernière en dioxyde de carbone et en eau, régénérant ainsi constamment le détergent.



DOTÉ DE :

- brosse à soies longues et conduit de connexion ;
- prédisposition pour utilisation de la part des droitiers et des gauchers ;
- grille forée en acier inox ;
- roues avec frein ;
- carte avec écran pour affichage de la température de fonctionnement et avertissement de niveau trop bas.

COMPREND :

- 2 bidons de liquide détergent respectueux de l'environnement de 20 litres et 2 paquets de bactéries.

DONNÉES TECHNIQUES

- Débit maximal de la pompe : 10 litres/minute
- Capacité réservoir : 40 litres
- Température de fonctionnement : +5 °C + +40 °C
- Dimensions : 900 x 1000 x 750 mm
- Poids : 50 kg à vide

1898/K40	CHF 6,030.00	1	018980004
----------	--------------	---	-----------

ATTENTION

Pays où il est possible de distribuer le produit 1898/K40 : Autriche, Belgique, Espagne, France (à partir de 2021), Hongrie, Italie, Pays Bas, Pologne, Portugal, Royaume-Uni.

1898/B

Flacon de bactéries de 300 ml pour cuve de lavage des pièces 1898/K40



1898/B	CHF 124.00	1	018980904
--------	------------	---	-----------

ATTENTION :

Pays où le produit 1898/B peut être distribué : Autriche, Belgique, France, Italie, Pays-Bas, Pologne, Portugal, Royaume-Uni, Espagne, Hongrie

1898/D

Jerricane de liquide détergent éco-compatible de 20 litres pour cuve de lavage des pièces 1898/K40



1898/D CHF 246.50 1 018980920

ATTENTION :

Pays où le produit 1898/B peut être distribué : Autriche, Belgique, France, Italie, Pays-Bas, Pologne, Portugal, Royaume-Uni, Espagne, Hongrie

1898/M

Nébuliseur à pression avec réservoir de 1,5 litres

- Buse réglable pour jet linéaire ou nébulisé
- Échelle graduée de 0,5 l - 1 l - 1,5 l
- Levier avec blocage pour jet continu
- Non utilisable avec des hydrocarbures



H mm 340 l 1,5 CHF 20.00 1 018980930

1898/S

Pompe manuelle à pression avec réservoir de 5 litres

- Lance en acier inoxydable
- Levier avec blocage pour jet continu
- Buse réglable pour jet linéaire ou nébulisé
- Sangle de transport confortable
- Poignée avec crochet pour la lance
- Tuyau flexible de 1,2 m
- Non utilisable avec des hydrocarbures



H mm 415 l 5 CHF 34.50 1 018980932

Beta

Quality Tools

1899A

Machine de nettoyage du système DPF/FAP®

Des détergents spéciaux peuvent être utilisés périodiquement nettoyer et restaurer les systèmes DPF et FAP® endommagé par des dépôts de suie et de cendres.



Fourni avec:

- 1 tuyau d'alimentation de 2 m de long
- 1 raccord rapide + buse de tuyau pour tuyaux de capteur différentiel
- 1 niplax M18x1.5 avec buse de tuyau pour une connexion directe à la sonde lambda
- 1 tuyau d'extension
- 1 buse de pulvérisation DPF/FAP®
- 1 support de tuyau magnétique
- 1 tuyau DPF/FAP® avec presse-étoupe de réglage plus niplax M14/16/18 mm pour connecter des sondes lambda

Caractéristiques techniques :

- tension de fonctionnement: 12 V
- longueur du cordon d'alimentation: 3,9 m
- capacité du réservoir: 1 l

1899A CHF 1,645.00 1 018990010

1899SI

Machine 2en1 pour le nettoyage des injecteurs et du collecteur d'aspiration

Grâce à l'utilisation de détergents prévus à cet effet, il est possible de nettoyer périodiquement les injecteurs et le collecteur d'aspiration des moteurs Diesel et essence, éliminant les dépôts de carbone et les résidus de combustion.



Caractéristiques techniques

- Tension de fonctionnement 12 V
- 2 tuyaux de service avec raccords rapides
- 2 réservoirs (capacité 1 l/chacun)

1899SI CHF 6,150.00 1 018990030

2080/VG

Étui à outils organisateur ABS avec plateaux pivotants

Avec organisateur supérieur de petites pièces (145 mm de diamètre) et 4 plateaux pivotants: - 1 plateau de 305 mm de diamètre - 3 plateaux de 445 mm de diamètre • Livré complet avec 12 cloisons pour une utilisation dans 3 plateaux pivotants plus grands, pour obtenir jusqu'à 8 compartiments par niveau



2080/VG CHF 222.00 1 020800100
445x445x550 mm - 3,4 kg

2250-O

Tabouret à roulettes réglable en hauteur



2250-O CHF 142.50 1 022500011

2252

Siège mobile d'atelier



2252-G CHF 240.00 1 022520002

2252KR4

Roues de rechange siège mobile d'atelier 2252



2252KR4 CHF 80.50 1 022520900

2258N-0

Mini-servante tabouret à 3 tiroirs



2258N-0	CHF 246.50	1	022580021
---------	---------------	---	-----------

2258RR

Roue de rechange pour mini-servante tabouret 2258N



2258RR	CHF 13.60	1	022580111
--------	--------------	---	-----------

2254A

housses de voiture, pour une utilisation en extérieur, hydrofuge et résistant aux UV Ces housses sont idéales pour protéger les véhicules endommagés en attendant d'être réparés

Caractéristiques techniques

- finition extérieure avec traitement de protection UV
- finition intérieure douce et sans écâtillage
- 6 cordes de réglage pour faire tenir le couvercle près de la voiture
- 2 fermetures éclair de porte avant pour permettre l'accès au véhicule sans avoir à retirer le couvercle
- sièges rétroviseurs
- réflecteur



- 3 versions :
- taille M recommandée pour les voitures compactes
 - taille L recommandée pour les berlines et les breaks
 - taille XL recommandée pour les VUS

	LxPxH mm	CHF		
/M	4400x1450x1300	201.00	1	022540002
/L	5300x1450x1150	224.50	1	022540000
/X	4700x1450x1580	206.00	1	022540001

2254C

Protection à ventouses pour carrosseries

En tissu plastifié avec 4 ventouses sur le côté supérieur



2254C	L1 mm 1150	L2 mm 650	CHF 65.50	1	022540200
-------	------------------	-----------------	--------------	---	-----------

2254F

Housse de protection avant

Permet de protéger la partie frontale du véhicule prévoyant les ouvertures pour les phares et le radiateur



- Imperméable
- Résistant aux huiles et aux graisses
- Fixation à l'aide de lacets
- Matériau : 98 % polyamide/nylon, 2 % polyuréthane

2254F	CHF 112.00	1	022540150
-------	---------------	---	-----------

2254K

Housse de protection réutilisable pour sièges, volant et pommeau du levier de vitesse

Apte à la plupart des sièges, volants et pommeaux des leviers de vitesse des véhicules



2254K	CHF 38.50	1	022540101
-------	--------------	---	-----------

2254SM

Tapis sous voiture en EVA

Double finition :

- 1 côté en souple EVA
- 1 côté en carbon look rigide pour favoriser le glissement



2254SM	CHF 88.50	1	022540033
--------	--------------	---	-----------

2254T

Tapis pour protection des genoux

Réalisé en EVA antidérapant



2254T	CHF 39.00	1	022540047
-------	--------------	---	-----------

3000L

Couchette d'atelier

• Coussin PVC épais garni de mousse caoutchouc pour un confort optimal.



3000L	CHF 227.00	1	030000210
-------	---------------	---	-----------

3000L/RLS

Roues de rechange couchette d'atelier



3000L/RLS	CHF 16.50	6	030000212
-----------	--------------	---	-----------

3002

Couchette d'atelier et siège mobile

- Structure en acier
- Revêtement en PVC rembourré
- Possibilité de réglage rapide de la position : couchette d'atelier ou siège mobile



3002 CHF 150.50 1 030020001

3002/RLS

6 roues pour couchette d'atelier 3002



3002/RLS CHF 39.00 1 030020501

3003

Couchette d'atelier en plastique antichoc

- Ø roues : 76 mm



3003 CHF 117.00 1 030030001

3003/RLS

6 roues pour couchette d'atelier 3003



3003/RLS CHF 60.50 1 030030501

Beta

3003C

Couchette d'atelier en plastique antichoc

- Dotée de :
- coussin pour la tête et la zone lombaire avec finition en carbon look
 - plaques supérieures en métal pour la fixation d'accessoires magnétiques
 - 6 roues en caoutchouc avec diamètre 79 mm
 - portée max. 120 kg
 - poids 5,5 kg



3003C CHF 317.00 1 030030100

3003C/RLS

6 roues de rechange pour couchette d'atelier 3003C



3003C/RLS CHF 127.00 1 030030600

3003PRO

Couchette d'atelier en plastique antichoc

- Dotée de :
- coussin appui-tête ergonomique
 - protection souple pour le dos
 - 2 roues de 178 mm avec double coussin qui permettent l'utilisation même sur surfaces irrégulières et en présence de tubes/câbles
 - 1 roue pivotante
 - double réglage de la hauteur du sol : 38 ou 76 mm
 - 2 lampes à Led portables de 250 Lumens avec aimants pour fixation
 - capacité de charge : 200 kg
 - poids : 7,7 kg



C max	H min	H Max	H1	CHF		
kg	mm	mm	mm			
200	170	230	230	445.00	1	030030150

3003PRO/SP

Support mural en plastique pour couchette d'atelier 3003PRO

Peut être appliqué sur un mur, un pont, une servante ou autre, permettant ainsi la fixation de la couchette d'atelier par le biais d'un système rapide et sûr avec fermeture de sécurité.



3003PRO/SP CHF 119.00 1 030030151

3003PRO/PM

Bac de rangement magnétique rond pour couchette d'atelier 3003PRO

En l'appliquant à la jante des roues de la couchette d'atelier, il permet de ne pas éparpiller la visserie pendant les interventions.



3003PRO/PM CHF 12.80 1 030030152

3003PRO/RCR

Paire de roues de rechange arrière pour couchette d'atelier 3003PRO



3003PRO/RCR CHF 94.00 1 030030650

Beta

3003PRO/RRG

Roue de rechange pivotante avant pour couchette d'atelier 3003PRO



3003PRO/RRG

CHF
29.50



1 030030651

3003PRO/RT

lampe a LED avec aimants de rechange pour couchette d'atelier 3003PRO

- 250 lumens
- Piles : 4xAAA (non fournies)



3003PRO/RT

CHF
21.50



1 030030652

3004

Cale de roue



3004
H mm 225
L mm 475
L1 mm 200

CHF
48.50



1 030040000

REPARATION DE VEHICULES

Nos outils de réparation de véhicules qui sont utilisés par les professionnels les plus exigeants, sont développés et fabriqués pour répondre aux normes les plus élevées du monde, et régulièrement testés dans les conditions de fonctionnement les plus difficiles.

Depuis plus de 50 ans, nous travaillons fièrement et en collaboration les plus grands champions des sport mécaniques, nous aidant à améliorer continuellement nos produits et témoignant du niveau de qualité PREMIUM.

Les outils de réparations de véhicules se trouvent dans les sections:

Diagnostics	articles 1438 to 1499 articles 1758VT to 1760TMC
Moteur	articles 955 to 989A articles 1438 to 1499
Vidange	articles 1438 to 1499 articles 1877 to 1885
Système électrique	articles 1438 to 1499
Boosters de démarrage	articles 1498BC/12 to 1498/40A
Transmission	articles 1438 to 1499
Suspension	articles 1549 to 1569CP
Freins	articles 1438 to 1499
Roues	articles 955 to 989A
Carrosserie	articles 1302 to 1369 articles 1763 to 1767A
Autres équipements	articles 1875LT to 3067
Levage	articles 3029/2T to 3067/70-13T



3006

Élévateur hydraulique pour le montage/démontage des roues de tracteurs et engins de chantier

- capacité maximum 1200 kg
- diamètre minimum roue 1000 mm
- diamètre maximum roue 2200 mm
- épaisseur maximum roue 800 mm

CE



3006

CHF
2,380.00



1 030060000

3006 R/RGF

Roue pivotante avec frein de rechange pour élévateur hydraulique pour le montage/démontage des roues 3006



3006 R/RGF

CHF
91.00



1 030060501

3006 R/RG

Roue pivotante de rechange pour élévateur hydraulique pour le montage/démontage des roues 3006



3006 R/RG

CHF
79.50



1 030060502

3007

Chariot de déplacement de véhicules sans roues

Permet de déplacer facilement les véhicules accidentés ou en cours de réparation

- 4 roues pivotantes, dont 2 avec frein, adaptées à l'utilisation en cabines de peinture
- 2 supports coulissants pour s'adapter à tous les châssis
- capacité maximum 800 kg

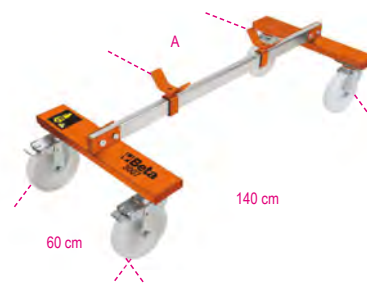

3007
A Max mm 110

CHF
856.00



1 030070001

Beta

3007 R/RGF

Roue pivotante avec frein de recharge pour chariot de déplacement des véhicules 3007



3007 R/RGF CHF 141.50 1 030070501

3007 R/RG

Roue pivotante de recharge pour chariot de déplacement des véhicules 3007



3007 R/RG CHF 123.50 1 030070502

3008N

Élévateur hydraulique pour le montage/démontage des roues simples ou jumelées des poids-lourds

- Capacité maximum : 500 kg
- Hauteur minimum : 120 mm
- Hauteur maximum : 650 mm
- Entraxe rouleaux : 429÷670 mm
- Sécurité hydraulique en cas de surcharge
- Roues avant pivotantes

CE



3008N CHF 4,040.00 1 030080110

3009

Chariot de déplacement véhicules

- Capacité maximum : 550 kg
- 4 rouleaux basculants
- Largeur rouleaux 200 mm
- Pour roues jusqu'à 240 mm de large



A 400÷850 mm B 600 mm CHF 560.00 1 030090001

3009R/GR4

Groupe 4 roues chariots 3009 R/GR4



3009R/GR4 CHF 228.50 1 030090501

3010/T..

Paire de chandelles



C max kg	H min mm	H max mm	H1 mm	L mm	L1 mm
2000	280	425	245	185	165

3010T 2 CHF 132.00 1 030100002

C max kg	H min mm	H max mm	H1 mm	L mm	L1 mm
3000	285	430	250	180	195

3010T 3 CHF 157.00 1 030100003

C max kg	H min mm	H max mm	H1 mm	L mm	L1 mm
6000	400	580	340	245	280

3010T 6 CHF 227.50 1 030100006

C max kg	H min mm	H max mm	H1 mm	L mm	L1 mm
10000	471	735	420	330	290

3010T 10 CHF 392.00 1 030100010

3011/T

Crics bouteilles hydrauliques

CE



C max kg	H min mm	H Max mm	L mm
2000	174	369	90

3011T 2 CHF 118.00 1 030110020

C max kg	H min mm	H Max mm	L mm
3500	170	366	86

3011T 3,5 CHF 132.00 1 030110035

C max kg	H min mm	H Max mm	L mm
5000	203	467	118

3011T 5 CHF 148.00 1 030110050

C max kg	H min mm	H Max mm	L mm
10000	220	484	114

3011T 10 CHF 222.00 1 030110100

C max kg	H min mm	H Max mm	L mm
15000	230	497	113

3011T 15 CHF 272.00 1 030110150

C max kg	H min mm	H Max mm	L mm
20.000	245	521	115

3011T 20 CHF 389.00 1 030110200

3010H

Chandelles série lourde



C Max kg	H min mm	H Max mm	L mm	L1 mm
15,000	445	631	300	300

3010H631-T15 CHF 424.00 1 030100150

C Max kg	H min mm	H Max mm	L mm	L1 mm
15,000	645	1077	300	300

3010H1077-T15 CHF 532.00 1 030100165

3010V

Chandelles série lourde avec réglage à vis



C Max kg	H min mm	H Max mm	L mm	L1 mm
20,000	410	600	330	330

3010V600-T20 CHF 618.00 1 030100200

C Max kg	H min mm	H max mm	L mm	L1 mm
20,000	665	1090	460	460

3010V1090-T20 CHF 785.00 1 030100220

3012

Barre support moteur



L mm	C max kg	CHF		
1500	500	403.00	1	030120010
1800	400	547.00	1	030120018

3012C

Barre support moteur inférieure - grande amplitude

Ideale pour automobiles et vehicules utilitaires



	CHF		
3012C	1,066.00	1	030120255

3012I

Barre support moteur inférieure

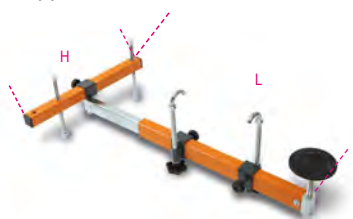

	L mm	H mm	CHF		
3012I	630+960	190	946.00	1	030120250

3014

Chevalet de support moteur



	CHF		
3014	508.00	1	030140010

3014R/GR5

5 roues pour chevalet de support moteur 3014



	CHF		
3014R/GR5	127.00	1	030140501

3014 SAR

Chevalet pliable support moteur

- Facilement pliable pour un encombrement minimum
 - Permet une rotation de 360° du moteur ou de la transmission
 - Assure une sécurité et stabilité maximales lors des interventions
- Capacité maximum : 450 kg



	CHF		
3014SAR	1,860.00	1	030140360

3014SAR/RR

4 roues pour chevalet de support moteur 3014SAR



	CHF		
3014SAR/RR	202.00	1	030140370

3014SAR/1

Réservoir de collecte liquides pour 3014 SAR

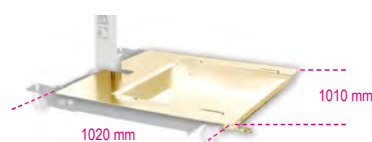

	CHF		
3014SAR/1	546.00	1	030140361
			1020x1010x11 mm

3014SAR/2

Étrier pour fixation de la transmission sur chevalet 3014 SAR

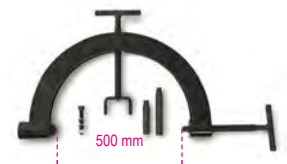

	CHF		
3014SAR/2	526.00	1	030140362

3023

étau télescopique avec réglage par vis

Capacité de charge maximale: 400 kg



	H min-Max mm	Ø mm	CHF		
3023	1350+2030	300	280.00	1	030230050

3025N

Grue hydraulique pliable avec pompe à double effet

Caractéristiques :

- Capacité maximum : 1 t
- 4 positions de charge : 300-600-800-1000 kg
- Avec limiteur de charge et tige chromé
- Vitesse de descente contrôlée
- Roues en nylon
- Hauteur maximum : 2420 mm



A mm	B mm	C mm	D mm	CHF		
1560	1600	1000	880	2,870.00	1	030250110

3025N/PF

Pince de levage de fûts

Capacité maximum : 300 kg

CE



	A	B	CHF		
	mm	mm			
3025N/PF	550+640	70	627.00	1	030250111

3026 0,3

Vérin hydraulique de fosse et sous-pont 300kg

CE



H min	H Max	L	L1	Ø	CHF		
mm	mm	mm	mm	mm			
1120	1970	450	450	25	915.00	1	030260003

3026/R0,3

4 roues pivotantes pour vérin hydraulique 3026 0,3



3026/R 0,3	CHF		
	230.50	1	030260903

3026 0,5

Verrins de fausse hydrolique de 500kg

Capacité maximum : 500 kg

CE



H min	H Max	L	L1	Ø	CHF		
mm	mm	mm	mm	mm			
1140	1990	600	550	30	1,089.00	1	030260005

3026/R0,5

4 roues pivotantes pour vérin hydraulique 3026 0,5



3026/R 0,5	CHF		
	321.00	1	030260905

3026 1,0

Vérin hydraulique de fosse et sous-pont 1 t

Capacité maximum : 1 t

CE



H min	H Max	L	L1	Ø	CHF		
mm	mm	mm	mm	mm			
1140	1990	650	550	35	1,315.00	1	030260010

3026/R 1,0

4 Roue pivotantes pour vérin hydraulique 3026 1,0



3026/R 1,0	CHF		
	414.00	1	030260910

3026/S

Support orientable pour transmissions avec boîtes chaudes de réduction pour vérins 3026

Capacité maximum : 500 kg

CE



3026/S	CHF		
	774.00	1	030260501

3026/SP

Support universel orientable pour boîtes de vitesses

Permet à un seul opérateur de démonter et remonter les transmissions des voitures, des véhicules utilitaires et tout-terrain avec rapidité et sécurité.

CE



3026/SP	CHF		
	900.00	1	030260505

3026/SA

Support moyeu roue pour vérins de fosse

- Utilisable pour les interventions de maintenance concernant les moyeux, et pendant les opérations de remplacement des amortisseurs
- Adaptable aux vérins hydrauliques de fosse 3026 0,3 et 3026 0,5



3026/SA	CHF		
	188.00	1	030260510

3026/SAM

Support amortisseurs pour vérins de fosse

- Utilisable pour soutenir l'amortisseur au démontage du bras de la suspension
- Étrier pour amortisseurs avec diamètre max. 80 mm, plus réduction pour diamètres max. 60 mm
- Adaptable aux vérins hydrauliques de fosse 3026 0,3 et 3026 0,5



3026/SAM	CHF		
	243.00	1	030260515

3027N 10

Presse hydraulique de table avec piston mobile

- Capacité maximum : 10 t
- Pompe manuelle à 2 vitesses
- Piston mobile
- Retour automatique du piston
- Série de prismes en V inclus
- Tige chromée

CE



3027N 10	CHF 2,540.00	1	030270101
----------	-----------------	---	-----------

3027N 20

Presse hydraulique avec piston mobile

- Capacité maximum : 20 t
- Pompe manuelle à 2 vitesses
- Piston mobile
- Tige chromée
- Retour automatique du piston
- Sécurité hydraulique en cas de surcharge
- Manomètre
- Série de prismes en V inclus

CE



3027N 20	CHF 3,510.00	1	030270102
----------	-----------------	---	-----------

3027N 30

Presse hydraulique avec piston mobile et treuil

- Capacité maximale : 30 t
- Pompe manuelle à 2 vitesses
- Piston mobile
- Tige chromée
- Retour automatique du piston
- Sécurité hydraulique en cas de surcharge
- Manomètre
- Treuil à câbles d'acier pour le levage du plan de travail

CE



3027N 30	CHF 6,140.00	1	030270103
----------	-----------------	---	-----------

3027N 50

Presse hydraulique avec piston mobile et treuil

- Capacité maximum : 50 t
- Pompe manuelle à 2 vitesses
- Piston mobile
- Tige chromée
- Retour automatique du piston
- Sécurité hydraulique en cas de surcharge
- Manomètre
- Série de prismes en V
- Treuil à câbles d'acier pour le levage du plan de travail

CE



3027N 50	CHF 8,560.00	1	030270105
----------	-----------------	---	-----------

3027N 100

Presse électrohydraulique motorisée avec piston mobile et treuil

- Capacité maximum : 100 t
- Moteur triphasé : 230-400 V
- Fréquence : 50 Hz
- Puissance du moteur électrique : 3 kW
- Pompe électrohydraulique à 2 vitesses
- Commande avec distributeur à levier en 3 positions : avant-neutre-retour
- Piston mobile
- Ø piston : 100 mm
- Levage du plan de travail au moyen d'un treuil à câble en acier
- Cordon d'alimentation avec fiche industrielle 380 V à 4 pôles
- Huile moteur déjà incluse

CE

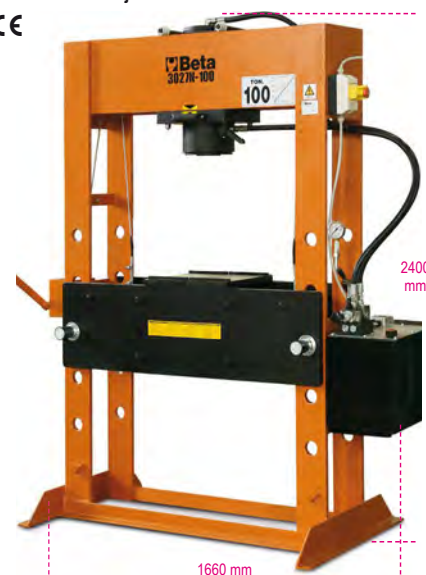

3027N 100	CHF 26,390.00	1	030270110
-----------	------------------	---	-----------

3027N/KP

Jeu de chasse-goupilles et plaque pour presse 3027N

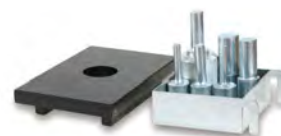

	CHF		
3027NKP10-20	470.00	1	030270511
3027NKP30	657.00	1	030270531
3027NKP50	804.00	1	030270541
3027NKP100	1,475.00	1	030270552

3027N/KPP

Commande à pédale pour presses hydrauliques 3027N



	CHF		
3027N/KPP10	502.00	1	030270560
3027N/KPP50	570.00	1	030270565



3027/PR

Support universel de presse pour l'extraction ou l'introduction des moyeux, roulements et silent block

Système universel qui travaille sous presse à travers une base d'appui et accessoires annexes, permet le démontage/montage de moyeux, roulements et silent block de leur siège.

L'outil s'adapte aux formes géométriques irrégulières des moyeux/embouts fusionnés sur lesquels l'opérateur doit intervenir.



DONNÉES TECHNIQUES

Intervalle de travail : min. 130 mm - max. 186 mm

Dimensions : 300 x 300 mm

Poids : 13 kg

Capacité maximum : 20 t

3027/PR CHF 828.00 1 030270400

3028 15

Presse hydraulique de table avec piston mobile

Capacité maximum : 15 t

Plateau réglable en hauteur

Piston coulissant



A mm 1010 B mm 565 C mm 480 D mm 80+370 CHF 1,375.00 1 030280015

3028SP/15

Écran de protection pour presses 3028 15



3028SP/15 CHF 200.00 1 030280016

3028 20

Presse hydraulique avec piston mobile

Capacité maximum : 20 t

Plateau réglable en hauteur

Piston coulissant

CE

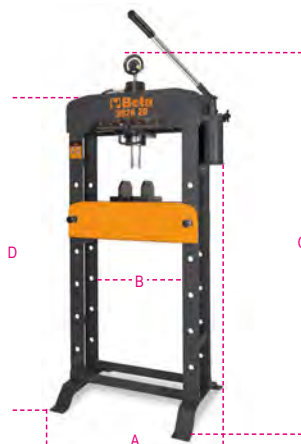

A mm 850 B mm 540 C mm 1830 D mm 1602 CHF 2,000.00 1 030280020

3028SP/20

Écran de protection pour presses 3028 20



3028SP/20 CHF 224.00 1 030280021

3028 30

Presse hydraulique avec piston mobile

Capacité maximum : 30 t

Plateau réglable en hauteur

Piston coulissant

CE

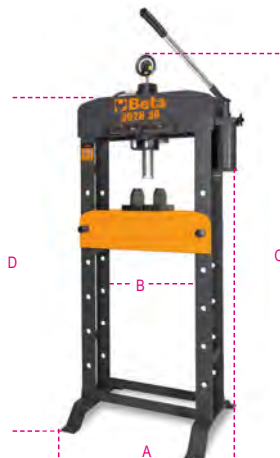

A mm 850 B mm 540 C mm 1850 D mm 1650 CHF 2,790.00 1 030280030

3028SP/30

Écran de protection pour presses 3028 30



3028SP/30 CHF 224.00 1 030280031

3028 50

Presse hydraulique avec piston mobile et treuil

Capacité maximum : 50 t

Plateau réglable en hauteur au moyen d'un treuil

Piston coulissant

CE

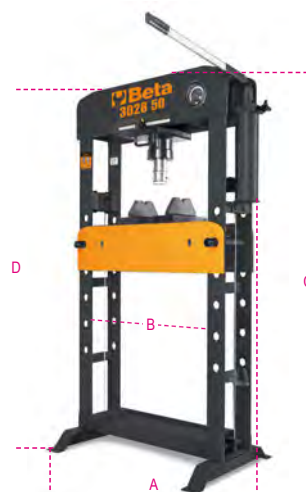

A mm 1100 B mm 750 C mm 1850 E mm 820 CHF 4,890.00 1 030280050

3028SP/50

Écran de protection pour presses 3028 50



3028SP/50 CHF 237.50 1 030280051

3028/KP

Jeu de chasse-goupilles et plaque pour presses 3028



3028/KP CHF 173.50 1 030280055



Beta

3029/2T

Cric rouleur hydraulique 2 t

- Pédale d'approche rapide
- Structure en acier et roues en nylon
- Hauteur minimum 75 mm

CE



H Max
500 mm

290 mm 720 mm

3029/2T CHF 557.00 1 030290020

3029L/2T

Cric rouleur hydraulique long 2 t

Permet d'intervenir sur les véhicules avec faible hauteur du sol et point de soulèvement interne

- Vitesse de descente contrôlée
- Pédale d'approche rapide
- Roues en nylon

CE



H min
75 mm
H Max
520 mm

320 mm 295 mm 930 mm

3029L/2T CHF 645.00 1 030290120

3029/2T-L/RP

Plateau de recharge en caoutchouc 85 mm pour 3029/2T, 3029L/2T



3029/2T-L/RP CHF 21.80 1 030290502

3029/2T-L/R6

Roue arrière pour 3029/2T, 3029L/2T, 3030H/2T, 3033E/3T



3029/2T-L/R6 CHF 70.50 1 030290506

3029/2T-L/R5

Roue avant pour cric 3029/2T, 3029L/2T



3029/2T-L/R5 CHF 65.50 1 030290505

3030/2T

Cric rouleur hydraulique à 6 roues

- Doubles roues avant basculantes en matière plastique (PTFE)
- Excellent manœuvrabilité du cric sur sols accidentés et irréguliers
- Charge utile maximum : 2 tonnes

CE



H Max
520 mm

400 mm 860 mm H min
85 mm

3030/2T CHF 1,059.00 1 030300020

43 kg

3030/2T-R5

Roue avant avec pivot pour cric rouleur 3030/2T



3030 2T/R5 CHF 37.00 1 030300505

3030/2T-R6

Roue arrière pour 3030/2T



3030 2T/R6 CHF 57.50 1 030300506

3030/2TRP

Plateau de recharge en caoutchouc 85 mm pour 3030/2T



3030/2TRP CHF 7.50 5 030300501

3030H/2T

Cric hydraulique à haute levée 6 roues, 2 Tonnes

Permet de travailler sur des véhicules en hauteur par rapport au sol et ayant une longue course d'amortisseur • vitesse de descente contrôlée

- pédale d'approche rapide
- roues en nylon

CE



H Max

H Min

L1

H min-Max mm 85+780 L mm 1010 L1 mm 300 CHF 887.00 1 030300220

3033/3T

Vérin hydraulique 3 t version longue

- Pour utilisation sur véhicules commerciaux
- Capacité maximum : 3 t
- Roues en polyamide

CE



h Max 520 mm

h Min 140 mm

1180 mm

3033/3T CHF 1,400.00 1 030330030



3033E/3T

Cric hydraulique 4 roues, 3 Tonnes

- vitesse de descente contrôlée
- roues en nylon

CE



	H min-Max mm	L mm	L1 mm	CHF		
3033E/3T	95-515	700	370	520.00	1	030330130

3033S 3T/R2

Roue avant de secours pour cric 3033E/3T



3033S 3T/R2	CHF 59.50	1	030330532
-------------	-----------	---	-----------

Beta

3035

chariot de transport pour pneumatique

- 2 roues Ø 260 mm
- 2 roues Ø 125 mm
- Hauteur maximum transportable 1,60 m
- Charge utile maxi 200 kg
- Fourches réglables en 2 positions :
première position ouverture maximum 880 mm
deuxième position ouverture maximum 980 mm



3035	CHF 1,275.00	1	030350100
------	--------------	---	-----------

3036

Base pour manipulation des roues

Socle porte-pneus
Roues en caoutchouc non marquantes



3036	CHF 150.50	1	030360063
------	------------	---	-----------

3061/2T

Cric pneumatique 2 boudins - 2 tonnes

CE



B	415 mm
C	250 mm
D	132-326 mm
E	2 t

Doté de:

- membrane triple épaisseur de grande résistance et guide télescopique interne
- dispositif d'arrêt en fin de course et soupape de sécurité pour charges excessives
- possibilité d'utilisation même sur leviers de soulèvement

DONNÉES TECHNIQUES

capacité : 2 t
poids : 14 kg
pression d'alimentation : 8-10 bars
hauteur : min.132 - max. 326 mm

3061/2T	CHF 1,187.00	1	030610020
---------	--------------	---	-----------

3061/2T-P50

Rallonge de 50 mm pour 3061/2T



3061/2T P50	CHF 101.00	1	030610021
-------------	------------	---	-----------

3061/2T-P100

Rallonge de 100 mm pour 3061/2T



3061/2T P100	CHF 135.00	1	030610022
--------------	------------	---	-----------

Beta

Beta

3065/20-10T

Cric hydro-pneumatique 20-10 t avec coffret de transport

Portable et léger, idéal pour les interventions d'assistance

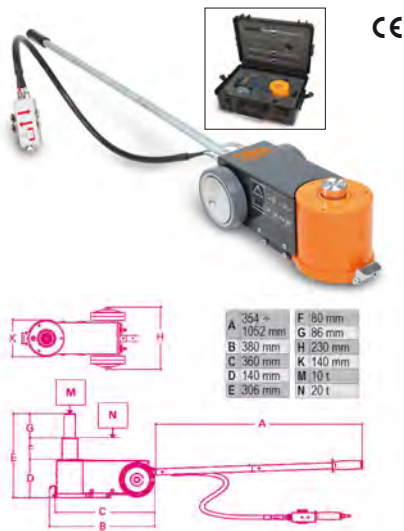

- Doté de 2 rallonges de 60 et 75 mm

DONNÉES TECHNIQUES

Capacité : 20-10 tonnes
Poids : 23 kg
Pression d'alimentation : 8-10 bar
Consommation d'air : 400 l/min

3065/20-10T CHF 3,510.00 1 030650100

3065/40-20T

Cric hydro-pneumatique 40/20 tonnes

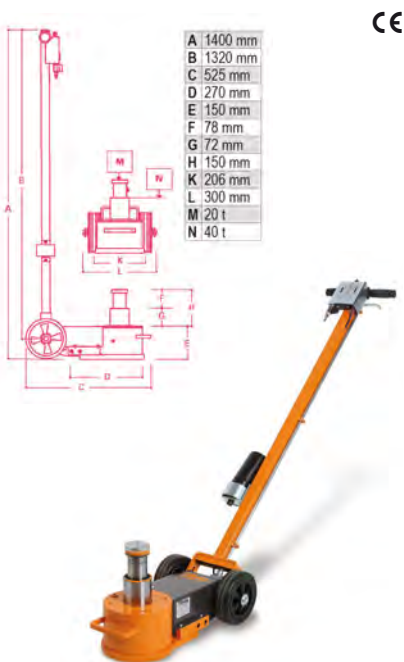

- indiqué pour utilisation sur poids-lourds
- pratique et maniable pour le transport, même dans des véhicules d'intervention
- retour automatique des pistons
- deux vannes de descente avec contrôle de la vitesse sous charge

DONNÉES TECHNIQUES

capacité : 40/20 tonnes
poids : 39 kg
pression d'alimentation : 8-10 bars
consommation d'air : 400 l/min

3065/40-20T CHF 3,940.00 1 030650200

3067/60-15T

Cric hydro-pneumatique 60-30-15 t

Avec une hauteur minimum de 120 mm seulement, il est particulièrement indiqué pour les interventions sur les autobus, les cars et tous les moyens de transport de ce type.

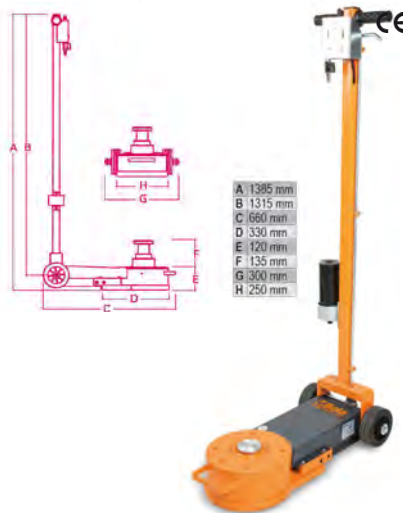

- Retour automatique des pistons
- Deux vannes de descente avec contrôle de vitesse sous charge
- Doté de deux rallonges de 70 et 120 mm

DONNÉES TECHNIQUES

Capacité : 60-30-15 tonnes
Poids : 56 kg
Pression d'alimentation : 8-10 bar
Consommation d'air : 600 l/min

3067/60-15T CHF 5,820.00 1 030670120

3067/70-13T

Cric hydro-pneumatique 70-43-23-13 tonnes

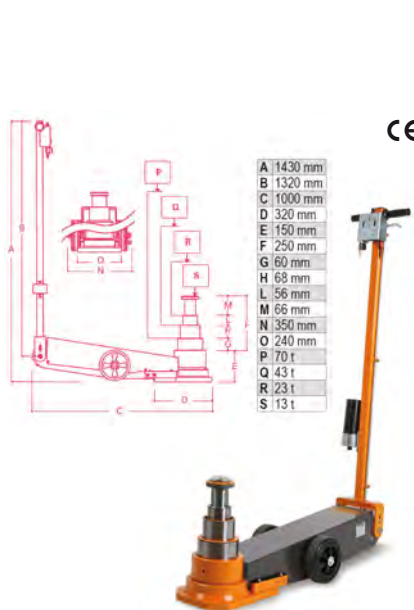

- Version longue, adaptée à l'utilisation sur camions, semi-remorques, autobus et machines agricoles
- retour automatique des pistons
- deux vannes de descente avec contrôle de vitesse sous charge

DONNÉES TECHNIQUES

capacité : 70-43-23-13 tonnes
poids : 74 kg
pression d'alimentation : 8-10 bars
consommation d'air : 600 l/min

3067/70-13T CHF 7,330.00 1 030670130

3068

Transpalette manuel avec fourches courtes



Données techniques:

- Capacité maximale : 2500 kg
- Longueur totale : 1200 mm
- Longueur de fourche : 800 mm
- Largeur de fourche : 540 mm
- Largeur de fourche individuelle : 160 mm
- Hauteur du levier : 1230 mm
- Hauteur de levage maximale : 115 mm

3068 CHF 1,042.00 1 030680000

3069

Transpalette manuel



Données techniques:

- Capacité maximale : 2500 kg
- Longueur totale : 1550 mm
- Longueur de fourche : 1150 mm
- Largeur de fourche : 540 mm
- Largeur de fourche individuelle : 160 mm
- Hauteur du levier : 1230 mm
- Hauteur de levage maximale : 115 mm
- Espace de stockage de palettes : 800x1200 en longueur : 1805 mm
- Rayon de braquage : 1347 mm

3069 CHF 980.00 1 030690000

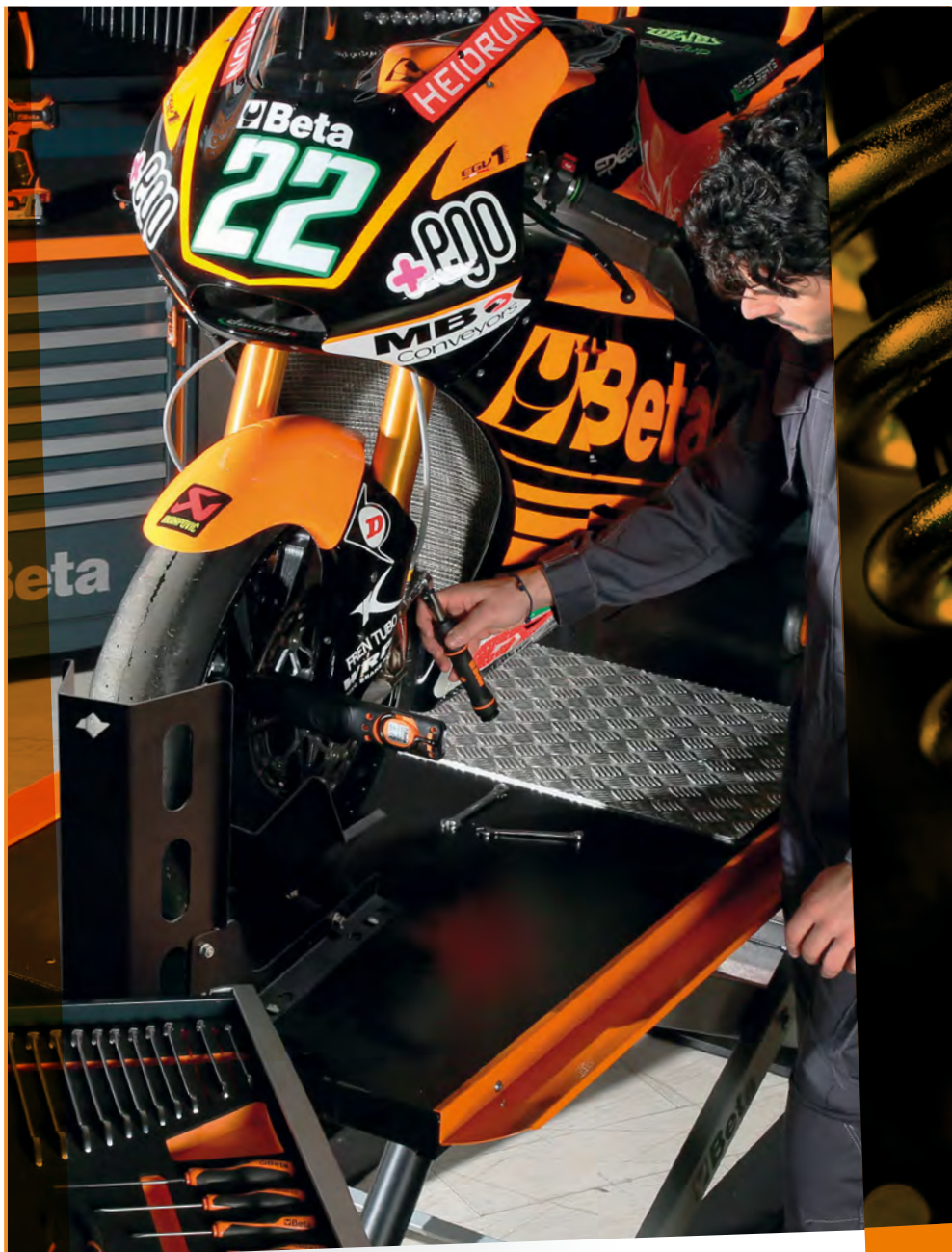

OUTILS POUR MOTORCYCLES

La qualité et la fiabilité des produits Beta sont garanties par plus de huit décennies d'expérience et de tradition. La famille d'outils Beta pour la réparation de motos comprend des produits spécialement conçus pour l'industrie de la moto. Nos produits sont réglés quotidiennement, dont la qualité est hautement appréciée par les techniciens des meilleures équipes de Moto GP, Mondial Superbike, Mondial Motocross et Enduro.



3040C

Chevalet arrière réglable pour motos



- Peinture noire mate
- 4 roues en caoutchouc thermoplastique
- Comprend paire de curseurs en V
- Comprend paire de curseurs en L



3040C **CHF** 104.50 1 030400002

3040C/S1

Paire de curseurs en V pour 3040C



3040C/S1 **CHF** 16.60 1 030400503

3040C/S2

Paire de curseurs en L en caoutchouc pour 3040C



3040C/S2 **CHF** 24.10 1 030400504

3041C

Chevalet avant réglable pour motos



- Peinture noire mate
- 4 roues en caoutchouc thermoplastique
- Comprend paire de curseurs à rouleaux
- Comprend paire de curseurs à cône



3041C **CHF** 98.00 1 030410002

3041C/12

Paire de curseurs à rouleaux pour 3041C



3041C/12 **CHF** 23.20 1 030410512

3041C/16

Paire de curseurs à cône pour 3041C



3041C/16	CHF 15.90	1	030410516
----------	-----------	---	-----------

3042C

Chevalet avant pour fourreau de direction moto

- Peinture noir mate
- 4 roues en caoutchouc thermoplastique
- Comprend kit de 8 pivots Ø 13 - 15 - 15,5 - 17 - 19 - 20 - 21 - 27



3042C	CHF 176.50	1	030420002
-------	------------	---	-----------

3043C

Chevalet pour moto avec monobras gauche

- Peinture noire mate
- 4 roues en caoutchouc thermoplastique
- Pivot en option



3043C	CHF 129.00	1	030430002
-------	------------	---	-----------

3043C/ 41÷47

Pivot pour 3043C



	Ø mm	CHF		
3043C/41	21,5 ÷ 25,5	29.50	1	030430551
Ducati				
3043C/42	27,5	29.50	1	030430552
KTM - Triumph				
3043C/43	42,5	32.00	1	030430553
MV				
3043C/44	40,5	32.00	1	030430554
Ducati				
3043C/45	28,5	29.50	1	030430555
Honda				
3043C/47	53,5	38.00	1	030430557
BMW				

3047C

Béquille cross/enduro à pédale



3047C	CHF 82.00	1	030470002
-------	-----------	---	-----------

3048C

Béquille cross racing en acier

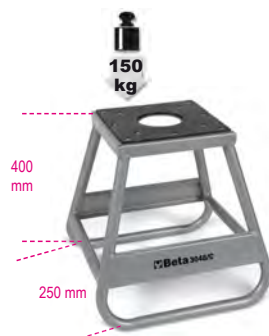

3048C	CHF 82.00	1	030480002
-------	-----------	---	-----------

3050/CC

Béquille centrale à vis sous berceau pour Custom, Enduro, Cross, Scooter

Comprend kit de supports réglables



3050/CC	CHF 210.00	1	030500012
---------	------------	---	-----------

3050/600

Élévateur moto électrohydraulique, 600 kg



3050/O
3050/G
3050/R

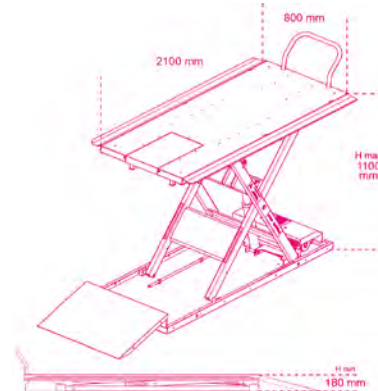

Caractéristiques techniques

- sécurités électriques, mécaniques et hydrauliques
- portée : 600 kg
- centrale électrohydraulique intégrée : 230V - 50 Hz
- pompe hydraulique
- vitesse de descente contrôlée
- fusibles de sécurité en cas de coupure du câble
- clavier de commande
- certifié cc homologué TÜV

	L mm	L mm	H min mm	H Max mm	CHF		
3050/O	975	2100	185	1110	7,090.00	1	030500201
3050/G	975	2100	185	1110	7,090.00	1	030500202
3050/R	975	2100	185	1110	7,090.00	1	030500203

3050/KA

Kit d'élargissement pour élévateur 3050/600



3052/KA-O
3052/KA-G
3052/KA-R

	A mm	B mm	CHF		
3050/KA-O	107,5	2100	1,420.00	1	030500221
3050/KA-G	107,5	2100	1,420.00	1	030500222
3050/KA-R	107,5	2100	1,420.00	1	030500223

3050/MS

Étau de roue autobloquant pour élévateur 3050/600

Permet le blocage de la roue avant de la moto sur le pont



3050/MS	CHF 806.00	1	030500032
---------	------------	---	-----------



3050/MV

Étau de roue autobloquant mécanique à vis pour élévateur 3050/600



3050/MV CHF 1,400.00 1 030500034

3050/LA

Plan en tôle antidérapante pour élévateur 3050/600

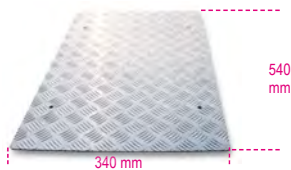

3050/LA CHF 161.00 1 030500062

9562T1

garage mat, 100X80 cm

adapté à une utilisation sous les leviers de pneus moto BETA 3071 et 3071B
• fond recouvert de caoutchouc antidérapant facile à nettoyer



9562T1 L cm 100 H cm 80 CHF 113.00 1 095620150

9562T3

Tapis d'atelier
Dimensions : 300x160 cm

- Particulièrement indiqué pour l'utilisation sous les ponts élévateurs moto

- Protège le sol contre les fuites d'huile et d'essence et respecte l'environnement
- Facile à nettoyer, en caoutchouc et antidérapant



9562T3 L cm 300 H cm 160 CHF 446.00 1 095620300

3054

Base mobile pour chevalet central ou pour roue arrière moto avec extension pour chevalet latéral



3054 max kg 500 CHF 355.00 1 030540000

3055M

Étau automatique pour fourgons

Permet de fixer la roue avant de la moto



3055M CHF 135.00 1 030550002

3057

Rampe en aluminium pour chargement/déchargement moto

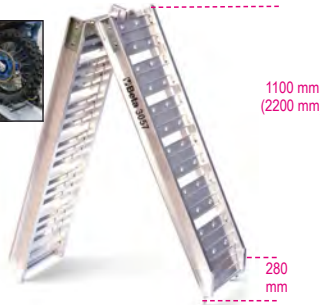

3057 CHF 288.00 1 030570001

3070B

Équilibreuse statique manuelle



- permet l'équilibrage des roues dans l'atelier et les écuries
- dotée de paliers à roulement, niveau de positionnement et pieds réglables pour une précision optimale
- comprend un couple de cônes pour moyeux

3070B CHF 168.50 1 030700100

3070B/...

tige d'équilibrage pour équilibreur 3070B



	Ø1	Ø2	L	CHF		
3070B/10	30	10	410	30.00	1	030700101
3070B/12	30	12	415	35.50	1	030700102
3070B/14	40	14	415	43.50	1	030700103

3070BE/K

Équilibreuse électronique portable à lancement manuel

Système d'équilibrage avec microprocesseur à lancement manuel (sans moteur) qui permet l'équilibrage de roues en fer ou en alliage d'autos et de motos.

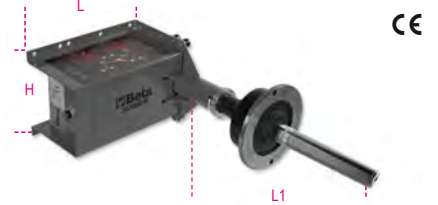

- Compacte et facile à transporter, elle peut être utilisée en atelier, dans les fourgons ou dans les box des circuit ;
- peut être fixée sur un établi ou sur un mur ;
- le logiciel prévoit tous les programmes d'ajustement du déséquilibre avec indication des positions avec poids adhésifs (ALUS), poids dissimulés derrière les rayons (SPLIT) et optimisation du déséquilibre ;
- peut être utilisée avec support orientable BETA 3070BE/S (en option).

ACCESSOIRES INCLUS

- règle flexible graduée ;
- douille de serrage avec volant et 3 cônes de Ø 45 + 110 mm

DONNÉES TECHNIQUES

Alimentation : 115-230V AC ou 12-24V DC
Puissance maximale absorbée : 0,15 kW
Vitesse d'équilibrage : 100 rpm
Incertitude des mesures : 1 g
Largeur jante réglable : 1,5" + 20" (40 + 510 mm)
Poids maximal de la roue : max. 75 kg

3070BE/K CHF 4,240.00 1 030700250

3070BE/S

Support orientable pour équilibreuse portable électronique 3070BE

Permet la fixation murale ou à l'établi de l'équilibreuse en réduisant l'encombrement et les espaces d'installation.



3070BE/S L mm 514 L1 mm 280 CHF 1,550.00 1 030700201

3070BE/F

Bride universelle motocycles Ø 40 mm pour 3070BE

Utilisable sur les roues avec trou central passant avec Ø de 15 à 35 mm et sur les roues bridées avec centrage jusqu'à Ø 68 mm.



3070BE/F CHF 2,115.00 1 030700202

3070BE/B

Kit de 8 douilles pour le centrage des roues des motocycles pour 3070BE

Permet d'intervenir sur les Ø suivants : 28 - 25 - 22 - 20 - 19,05 - 17 - 16 - 15



3070BE/B CHF 2,355.00 1 030700203

3071A

levier de pneu manuel pour motos cross et enduro

Permet un retrait facile et rapide des pneus dans les champs de course; basé sur un cadre robuste et large en acier galvanisé, il offre une fermeté lors du retrait des pneus. Peut être installé sur le support BETA 3071RS, pour plus de commodité Fonctionnalités:

- Poignée ergonomique en caoutchouc, pour un maintien facile et sûr du levier
- Avec dispositif de retenue en caoutchouc pour verrouiller la tige pendant le transport
- Peut être utilisé pour installer des pneus cross et enduro, 17 » ÷ 21 ».

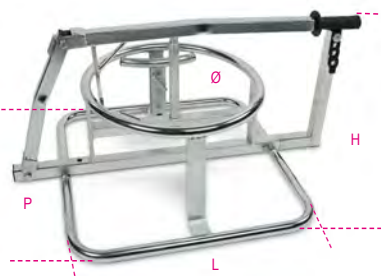

3071A L H P Ø CHF 570 400 850 440 652.00 1 030710000

3071B

levier de pneu manuel pour mini vélos et mini motos tout-terrain

Permet un retrait facile et rapide des pneus dans les champs de course; basé sur un cadre robuste et large en acier galvanisé, il offre une fermeté lors du retrait des pneus. Peut être installé sur le support BETA 3071RS, pour plus de commodité Fonctionnalités:

- Poignée ergonomique en caoutchouc, pour un maintien facile et sûr du levier
- Peut être utilisé pour installer la plupart des mini-vélos et mini pneus de vélo sales.

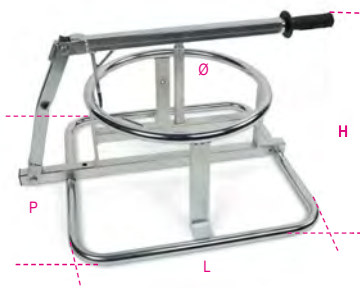

3071B L H P Ø CHF 570 330 650 340 610.00 1 030710010

3071RS

Support pour leviers de pneus BETA 3071A et 3071B

pour élever les leviers de pneus BETA 3071A et 3071B, ce qui facilite le retrait des pneus; cadre en acier galvanisé, avec base carrée pour une fermeté accrue.

- Avec 4 crochets de fixation

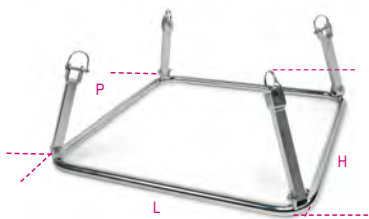

3071RS L H P CHF 670 275 670 284.00 1 030710020

962C

leviers de pneus, paire, pour les motos cross et enduro, les mini-motos et les mini motos sales

pour une utilisation en combinaison avec BETA 3071A et 3071B



962C L A CHF 420 30 150.00 1 009620020

3072N

établi arrière moto amortisseur démonter, manuel

Permet le démontage totalement sûr de l'amortisseur arrière de la moto; basé sur ses bras réglables, il convient à la plupart des amortisseurs arrière; alternativement, il peut être utilisé avec la plaque fournie. - anneaux de verrouillage en option Fonctionnalités:

- Convient pour une utilisation sur la plupart des amortisseurs arrière de moto
- Réglable verticalement en 8 positions
- 3 bras réglables avec dispositifs de retenue réglables verticalement
- plaque de verrouillage de l'amortisseur
- avec prise pantographe
- avec pieds en caoutchouc
- avec goupille de verrouillage de l'amortisseur Données techniques Extension jack: max. 130 mm Extension de bras: max. 55 mm Extension de retenue: max. 18 mm Poussée: max. 1 t

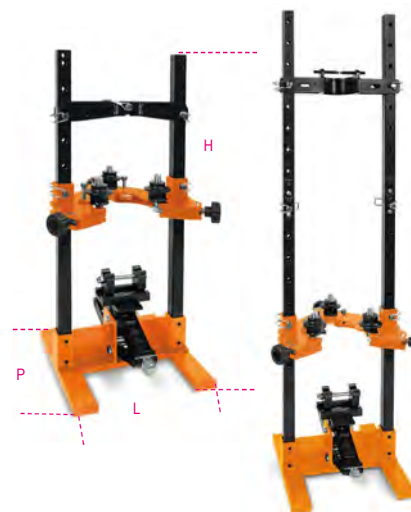

3072N L H P CHF 390 785 390 1,475.00 1 030720010

3073

outil universel d'insertion de joints d'huile de fourche (joint spi)

Pour diamètres tige de 35 à 48 mm



3073 CHF 112.00 1 030730001

30740

Clé pour bouchons de fourche Ohlins Electroniques

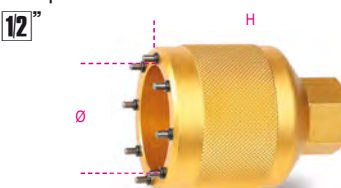

30740 H Ø CHF 70,5 50,5 131.50 1 030740001

30740/S

Clé à fourche Sachs pour DUCATI Multistrada

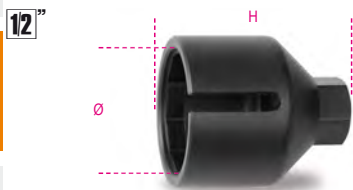

30740/S	H mm	Ø mm	CHF	1	030740002
	75	65	149.00		

30740/M

Clé cloche pour fourche Marzocchi pour DUCATI 1199 et Hypermotard

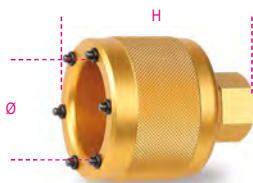

30740/M	H mm	Ø mm	CHF	1	030740003
	69	55	129.00		

30740/2

Clé à capot de fourche octogonale Ohlins pour motos DUCATI

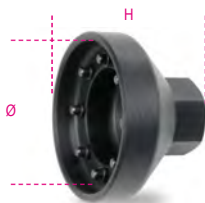

30740/2	H mm	Ø mm	CHF	1	030740004
	45	65	136.50		

3075A

Douille six pans pour écrous moyeu roue

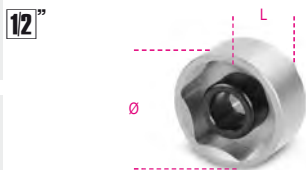

	Ø mm	Ø mm	L mm	CHF	1	
3075A 28	28	38	30	36.50		030750028
3075A 30	30	40	30	39.00		030750030

3075B

Douille 12 pans pour écrous moyeu roue

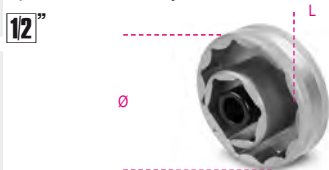

3075B 55	Ø mm	Ø mm	L mm	CHF	1	030750155
	55	70,7	25	93.50		

3075MV

Douille 12 pans pour écrous moyeu roue MV AGUSTA

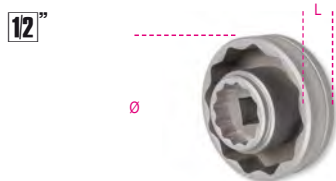

3075MV 56	Ø mm	Ø mm	L mm	CHF	1	030750156
	56	70,7	30	104.50		

3075/CM

Clé mâle six pans multiple pour pivots roues



3075/CM	CHF	1	030750212
12-14-17-19-22-24 mm	52.50		

3075/K10

Set clé universelle à embout interchangeable avec 10 embouts, pour serrage des rayons de roues



Mesures : 5.2 - 5.4 - 5.6 - 5.8 - 6.0 - 6.2 - 6.4 - 6.6 - 6.8 - 7.0



3075/K10	CHF	1	030750410
	70.00		

3079/21

Huileur de câbles



Permet une lubrification correcte des câbles embrayage et commande gaz en augmentant le glissement des gaines et la durée des câbles.



3079/21	CHF	1	030790021
	10.70		

3080/C15

Kit rive/dérive chaînes



Ø 3-4-5 mm et kit Regina



3080/C15	CHF	1	030800015
	467.00		

420x185x60 mm

3080R/CS3

Kit de 3 chasse-goupilles pour dérive-chaîne 3080/C15



Ø 3-4-5 mm



3080R/CS3	CHF	1	030800503
	72.00		

3081

Dérive-chaîne portable



Robuste et pliable pour en faciliter le transport dans le sac d'enduro. Adapté pour les chaînes 415, 420, 428, 520, 525, 530, 532



3081	CHF	1	030810010
	58.00		

3085

Outil pour séparation des pistons de frein



Indiqué pour les pinces de frein de moto et scooter



3085	CHF	1	030850010
	129.00		

3091

Extracteur avec filet interne pour volant-moteur



	M	CHF		
3091/10	24x1,5	27.00	1	030910010
3091/20	26x1,0	28.50	1	030910020
3091/25	27x1,0	28.50	1	030910025
3091/30	28x1,0	29.00	1	030910030
3091/40	30x1,0	38.50	1	030910040
3091/45	30x1,5	38.50	1	030910045
3091/50	32x1,5	42.00	1	030910050
3091/60	33x1,5	44.00	1	030910060
3091/70	35x1,0	62.00	1	030910070
3091/75	35x1,5	62.00	1	030910075
3091/80	38x1,5	67.50	1	030910080

3092

Extracteur avec filet externe pour volant-moteur



	M	CHF		
3092/10	18x1,5	14.40	1	030920010
3092/20	19x1,0	16.70	1	030920020
3092/25	27x1,0	17.50	1	030920025
3092/30	27x1,25/20x1	17.60	1	030920030
3092/35	22-26x1,5	17.60	1	030920035
3092/40	25x1,5/22x1	17.60	1	030920040
3092/50	26-28x1,0	17.60	1	030920050
3092/60	28x1,5	17.40	1	030920060

3093/E

Équipement pour le blocage du volant-moteur, la cloche d'embrayage et les poulies



	CHF		
3093/E	47.50	1	030930100

3093/U

Extracteur multiple pour volant-moteur



	CHF		
3093/U	46.00	1	030930050
M10x1.25R			
M14x1.5R			
M16x1.5R			
M18x1.5R			
M24x1.0R			
M27x1.0L			

3094PA

Panneau de service de dépannage de moto OFFROAD



Cadre métallique; les jambes peuvent être pliées en cadre; recommandé pour la disposition des outils dans les champs de course disponible en 3 couleurs :

- 3094PA-O Orange
- 3094PA-G Gris
- 3094PA-R Rouge Accessoires en option :
- porte-rouleau de papier 3200 PR
- porte-bouteille universel magnétique 2499PF/M

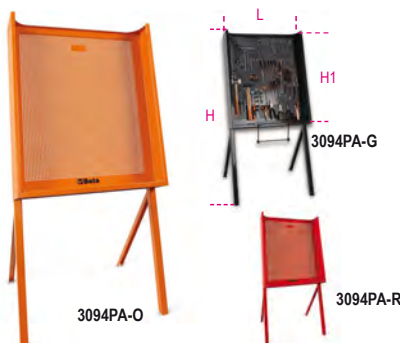

	L	H	H1	CHF		
	mm	mm	mm			
3094PA-O	750	1555	900	680.00	1	030940101
3094PA-G	750	1555	900	680.00	1	030940102
3094PA-R	750	1555	900	680.00	1	030940103

3095

Support de banc pour moteurs de moto



Grâce aux étriers réglables, les usinages sur les moteurs sont pratiques et aisés



	H	P	L	L1	CHF		
	mm	mm	mm	mm			
3095	360	460	640	460	766.00	1	030950001

3099E

Housse de moto d'extérieur, résistante à l'eau et à la poussière



protège la peinture des rayures, de la poussière et du soleil



Taille "M" recommandée pour les motos sportives et nues et les scooters de taille moyenne
Taille "L" recommandée pour les motos maxi, enduro et crossover

		CHF		
3099E/M	M	108.50	1	030990102
3099E/L	L	133.50	1	030990103

3099T

Housse de moto d'intérieur, en tissu extensible



protège la peinture des rayures, de la poussière et du soleil



Taille "M" recommandée pour les motos sportives et nues et les scooters de taille moyenne
Taille "L" recommandée pour les motos maxi, enduro et crossover
Taille "XL" recommandée pour les motos de super tourisme

		CHF		
3099T/M	M	94.00	1	030990202
3099T/L	L	115.50	1	030990203
3099T/XL	XL	139.50	1	030990204



Beta



OUTILS POUR VÉLOS

Beta a toujours été impliqué dans le cyclisme. Cette famille, centrée sur les outils vélo et développée pour les professionnels du cyclisme, présente une sélection précise de produits destinés à l'entretien des vélos et des vélos électriques.



Tour de France 2020 e 2021



Partnership 2023

Official contributor
of Eolo KOMETA cycling



Partnership 2023



3910

Élévateur pour E-Bike



- Charge maximale : 40 kg
- Hauteur maximale du support de pédalier : 135 cm
- Centre de roue intégré
- Système de verrouillage innovant utilisant l'axe traversant
- Bagues d'adaptation fournies pour les principales fourches existantes
- Adaptateur pour fixation de fourche sans axe traversant inclus
- Entièrement pliable et transportable
- Poids de l'élevateur : 48 kg

CE

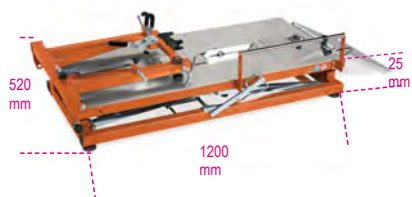

3910 CHF 4,670.00 1 039100010

3912TP

Etabli d'atelier TOP pour l'entretien des vélos



- Avec support pour le mouvement central, avec goupille de sécurité
- Tiroir à outils avec glissières à roulement à billes (490x365x90 mm)
- Support de treillis de roue intégré
- Système innovant de verrouillage de l'essieu traversant



3912TP CHF 1,935.00 1 039120050

3912PP

Etabli d'atelier PRO pour l'entretien des vélos



- Avec support pour le mouvement central, avec goupille de sécurité
- Support de treillis de roue intégré
- Système innovant de verrouillage de l'essieu traversant



3912PP CHF 1,054.00 1 039120150

3912TP/A

prise d'adaptateur pour fourches à essieu traversant



Pour les établis 3912TP, 3912PP et 3910



L mm 39 Ø mm 30 Ø1 mm 5 CHF 26.00 1 039120052

3912TP/C

douille d'adaptateur universelle pour fourches à essieu traversant, serrage de douille hexagonale



Pour les établis 3912TP, 3912PP et 3910



L mm 29 Ø mm 30 CHF 26.00 1 039120054

3912TP/FOX

douille pour fourches FOX®



Pour les établis 3912TP, 3912PP et 3910



L mm 38 CHF 26.00 1 039120058

3912TP/QRE

douille pour fourches sans essieux traversants



Pour les établis 3912TP, 3912PP et 3910



L mm 108 CHF 42.50 1 039120064

3912TP/ROAD

douille pour fourches routières



Pour les établis 3912TP, 3912PP et 3910



L mm 33 Ø mm 35 CHF 28.50 1 039120060

3912TP/RS

douille pour fourches ROCKSHOX® à essieu traversant



Pour les établis 3912TP, 3912PP et 3910



L mm 35 Ø mm 30 CHF 26.00 1 039120056

3912TP/ST

douille pour fourches SUNTOUR



Pour les établis 3912TP, 3912PP et 3910



L mm 31 Ø mm 30 Ø1 mm 18 CHF 28.50 1 039120062



Beta

3916MMP

pince monoface d'atelier pour l'entretien du vélo

- La pince peut être tournée à 360°, avec des mâchoires flottantes et un réglage micrométrique
- Capacité de charge: 25 kg
- Plateau à outils en plastique



3916MMP CHF 955.00 1 039160150

3918MML

Étau léger à un bras, pliable

- Étau rotatif à 360°
- Capacité : 15 kg
- Hauteur maximale de l'étau : 150 cm



3918MML CHF 388.00 1 039180010

3921

Outil pour l'alignement du dérailleur

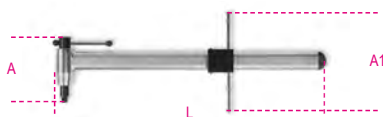

L mm 440 A mm 115 A1 mm 165 CHF 135.00 1 039210010

3923

Outil guide-lame pour découpe tige de selle de type aérodynamique jusqu'à 80 mm et découpe fourreaux de 1" à 1,1/2"

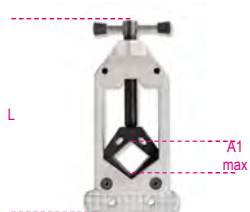

L mm 160 A1 max mm 80 Ø max mm 45 CHF 64.00 1 039230010

3927

Bloque-guidon



3927 L mm 365 CHF 38.50 1 039270010

3932U

Dérive-chaîne professionnel compatible avec chaînes de 5 à 11 vitesses



L mm 164 L1 mm 115 CHF 70.50 1 039320011

3935

Indicateur d'usure de la chaîne



L mm 120 CHF 12.10 1 039350010

3937

Pince pour fausse maille



L mm 170 CHF 31.00 1 039370010

3948

Extracteur pour manivelle

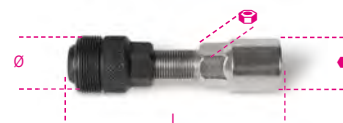

mm 14 L mm 79 Ø mm 20 mm 15 CHF 24.20 1 039480015

3952

Clé conique simple



mm	L mm	CHF		
13	205	31.00	2	039520013
14	205	31.00	2	039520014
15	205	31.00	2	039520015
16	205	31.00	2	039520016
17	205	31.00	2	039520017
18	205	31.00	2	039520018
19	205	31.00	2	039520019
20	205	31.50	1	039520020
21	205	31.50	1	039520021
22	205	31.50	1	039520022
24	205	33.00	1	039520024



	CHF		
3952/S7 13-14-15-16 17-18-19 mm	217.00	1	039520207
3952/S11 13-14-15-16 17-18-19-20-21-22-24 mm	345.00	1	039520211

3953

Clé pour pédales



mm 15 L mm 401 CHF 48.50 1 039530015

3955

Clé à fourche pour jeux guidon universels



mm	L mm	CHF		
30x32	292	44.50	1	039550108
32x36	319	49.50	1	039550114

39613,2

Clé à rayon noire 3,2 mm



mm 3,2 CHF 17.60 1 039610032

39613,3

Clé à rayon verte 3,3 mm



mm
3,3

CHF
17.60



1 039610033

39613,5

Clé à rayon rouge 3,5 mm



mm
3,5

CHF
17.60



1 039610035

3961U

Clé à rayon professionnelle 3,2 - 4,0 mm



mm
3,2 - 4,0

CHF
29.00



1 039610100

3962SH

Clé à rayon double pour Shimano



L mm
132

A1 mm
4,3

A2 mm
4,4

CHF
22.30



1 039620010

3962MV

Clé à rayon double pour Mavic



L mm
135

A1 mm
4,3

A2 mm
8,4

CHF
23.20



1 039620020

3963P

Clé spéciale pour rayons plats



L mm
129

CHF
10.50



1 039630010

3964

Clé spéciale de vissage des barrettes



L mm
170

L1 mm
89

CHF
26.00



1 039640010

3965

Gabarit pour carrossage roues de 20" à 29"



L mm
680

CHF
127.50



1 039650010

3965C

Centreur de roues professionnel



- Pour diamètres de 20" à 29"
- Adaptateur pour axes passants de 10 à 20 mm



L mm
500

L1 mm
380

A mm
285

CHF
516.00



1 039650110

3967

Clé fouet démonte-cassette



- Compatible jusqu'à boîtes à 11 vitesses
- Manche en 2PVC
- Adapté même aux roues à déclenchement fixe



L mm
289

CHF
70.00



1 039670010

3969

Levier démonte-pneus



L mm
200

A mm
15,6

CHF
12.80



1 039690010

3969K3

Jeu de 3 leviers démonte-pneus en plastique



L mm
113

CHF
7.05



1 039690130

3971

Clé pour vis en plastique Shimano



- Adapté aux garnitures Shimano Hollowtech II



N°
8

mm
8

CHF
15.60



1 039710010

3972

Clé extracteur pour mouvement central



- Apte pour Shimano® Hollowtech II, Campagnolo® Ultra-torque, FSA®, SRAM®



L mm
252

CHF
30.00



1 039720010

3973PF

Extracteur pour roulements Press-Fit



- Adapté aux Ø internes de 24 mm et 30 mm



L mm
240

CHF
40.50



1 039730001

3973/1

Douille extracteur pour mouvement central à 16 encoches



- Apte pour Shimano® XTR BB93, Dura-Ace® BB9000

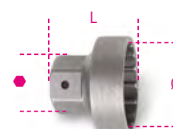

Ø mm
39

mm
24

L mm
34

CHF
26.00



1 039730010

3973/2

Douille extracteur pour mouvement central à 16 encoches

• Apte pour Shimano® BBR60 (Ultegra® 11 vitesses)



12"



Ø mm 41 ● mm 24 L mm 35 CHF 26.00 1 039730020

3973/3

Douille extracteur pour mouvement central à 16 encoches

• Apte pour Shimano® Hollowtech II, Campagnolo® Ultra-torque, FSA®, SRAM®



12"



Ø int. mm 46 ● mm 24 L mm 53,5 CHF 26.00 1 039730030

3973/4

Douille extracteur pour mouvement central à 20 encoches avec pivot central, nickelée

• Apte pour Shimano et ISIS



12"



Ø mm 31,5 L mm 55 ● mm 24 CHF 16.40 1 039730040

3975

Presse permettant le montage série du guidon et du pédalier central

• Permet le montage des jeux de direction

1", 1,1/8", 1,1/4", 1,1/2" et 2"

NB : Ne pas utiliser avec des bouchons "zero stack"



L mm 360 Ø mm 16x1 CHF 342.00 1 039750010

3984/1

Clé extracteur pour roues libres BMX à 4 embouts

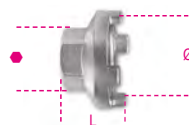

Ø mm 35 L mm 25,5 ● mm 24 CHF 19.10 1 039840010

3984/2

Clé extracteur pour roues libres Shimano



Ø mm 22,8 L mm 26 ● mm 24 CHF 12.10 1 039840020

3984/3

Clé extracteur pour roues libres Shimano à cassette avec embout de guide



12"



Ø mm 23,5 L mm 65 L1 mm 25 CHF 20.70 1 039840030

3984/4

Clé extracteur pour roues libres Campagnolo avec embout de guide



Ø mm 23 L mm 51 L1 mm 13 ● mm 24 CHF 27.00 1 039840040

3984/5

Clé extracteur pour roues libres à 2 embouts



12"



Ø mm 18,5 L mm 38 ● mm 21 CHF 19.10 1 039840050

3984/6

Clé extracteur pour roues libres à 4 embouts



12"



Ø mm 19,5 L mm 36 ● mm 21 CHF 19.10 1 039840060

3991

Levier pour écarter les pastilles des freins à disque



L mm 222 A mm 36 α 7° CHF 45.00 1 039910010

3992

Clé pour redresser les disques des freins



L mm 234 A1 mm 55 CHF 34.00 1 039920010

2115PI/BIKE-HOME



2115PI/BIKE-HOME 361

M400



M400 543
MV400 543

M401



M401 543
MV401 543

MM400



MM400 548
MMV400 548

MM401



MM401 548
MMV401 548

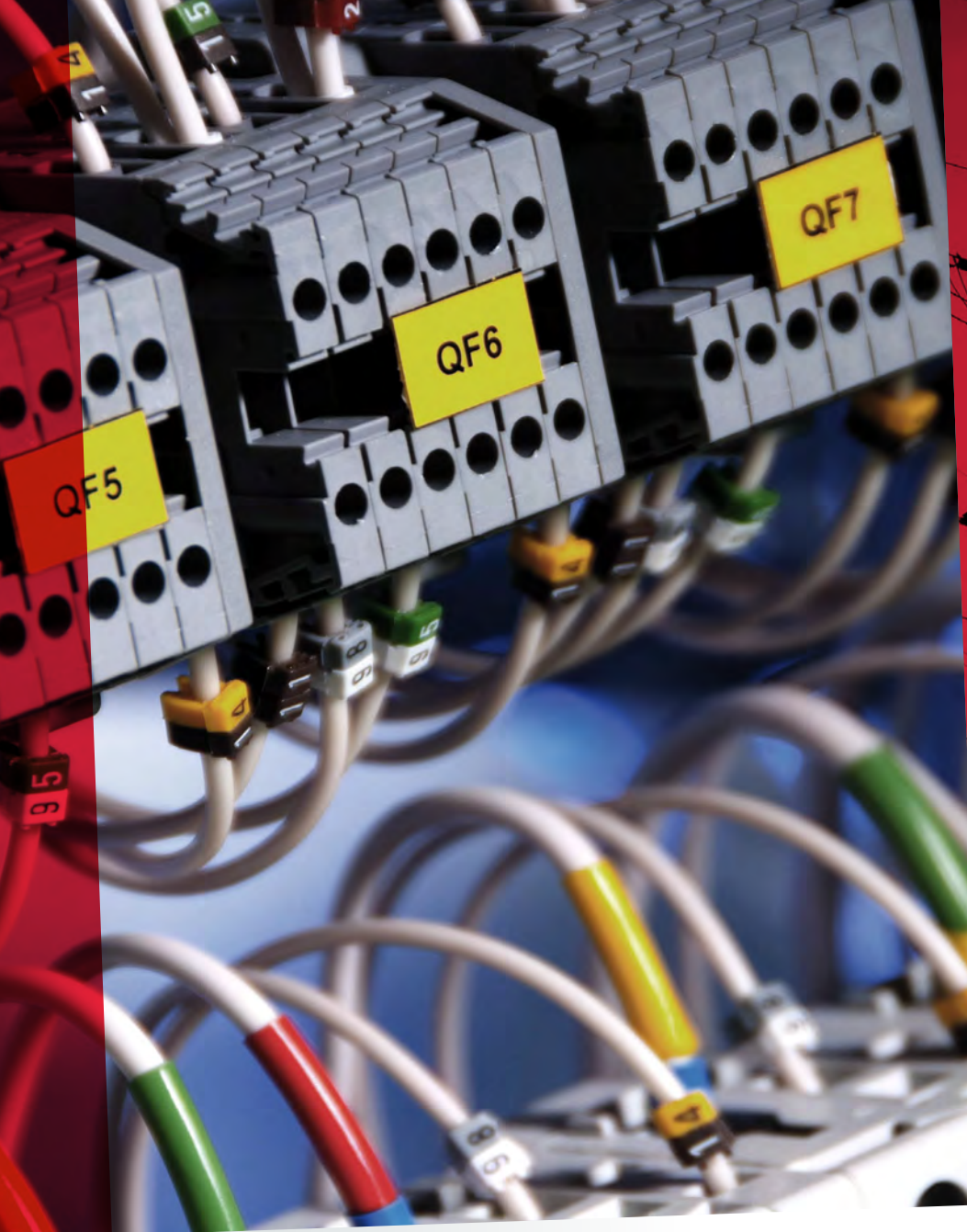

OUTILS ISOLÉS

Les outils isolés Beta sont des produits conçus pour garantir la sécurité des installateurs et des manutentionnaires électriques. Tous les outils isolés permettent d'intervenir sur les installations sous tension jusqu'à 1 000 V en courant alternatif et 1 500 V en courant continu.

Pour offrir ce qu'il y a de mieux en terme de qualité, de performance et pour vérifier et garantir la conformité aux normes EN 60900, chaque outil est soumis à un procédé de vérification poussé qui prévoit des essais de résistance de la poignée contre le défilage et la propagation de la flamme, et un essai de tension appliquée à 10 000 V.

Pour les compositions et les plateaux thermoformés, voir les sections correspondantes. Tous les outils isolés Beta sont construits conformément aux spécifications de la norme EN60900 et sont homologués par les meilleurs instituts européens de certification.



Istituto Italiano del Marchio di Qualità - I



Verband der Elektrotechnik
Elektronik Informationstechnik - D

1000 V

ESSAI DE SÉCURITÉ : testés à 10.000 volts pour travailler sur des installations à 1.000 volts.

Les outils à haut isolement Beta sont testés pièce par pièce à 10 kV dans le but d'offrir une qualité absolue pour des instruments de travail qui doivent garantir de très hauts standards de sécurité. Ils permettent en effet de travailler sur des installations sous tension jusqu'à 1000 V en courant alternatif (1500 V en courant continu).

NORMES DE SÉCURITÉ :

malgré les contrôles très poussés en phase de production, l'opérateur doit toujours vérifier, avant usage, l'absence de lacérations, de modifications ou de détériorations en tout genre de la branche isolante. La durée dans le temps des caractéristiques diélectriques est strictement liée aux stress mécaniques, chimiques ou thermiques qui peuvent être imposés à l'outil. En cas de détérioration de l'isolant, l'utilisation de cet outil pour les installations sous tension ne doit pas être considérée comme sûre. Utiliser systématiquement des lunettes et des gants isolés.

CONTRÔLES EFFECTUÉS EN PHASE DE PRODUCTION



Contrôle visuelle à 100 % :

tous les outils doivent présenter des finitions superficielles sans défauts visibles de l'extérieur.



Essai de choc :

après avoir laissé l'outil pendant 2 heures à une température de -25 °C, il est frappé trois fois (par un poids spécifique déterminé par la norme) et la branche isolante ne doit présenter aucun endommagement.



Essai de pénétration :

un poids de 2 kg est appliqué pendant deux heures sur la branche de l'outil à +70 °C, puis dans la zone soumise à pression mécanique est appliquée une tension de 5 kV pendant trois minutes. Aucun passage de courant ne doit être relevé.



Essai mécanique :

les outils doivent satisfaire tous les critères des prestations mécaniques définis par les normes ISO respectives pour chaque produit



Essai de non-propagation de la flamme :

une flamme est orientée vers l'outil pendant 10 secondes. Lors des 20 secondes suivantes, la flamme ne doit pas dépasser 120 mm de hauteur.



Contrôle dimensionnel :

toutes les paramètres des outils doivent être conformes aux spécifications techniques du projet.



Essai d'isolation électrique :

après avoir immergé l'outil dans l'eau pendant 24 heures, une tension de 10 kV est appliquée pendant 3 minutes. Aucune dispersion de courant supérieure à celles prévues par la norme ne doit se produire.



Essai d'adhérence :

après avoir laissé l'outil pendant 168 heures à +70 °C, une charge de 500 N lui est appliquée pour vérifier que la branche ne se défile pas.



Essai d'indélébilité des marquages :

après l'essai de frottement avec de l'alcool isopropylique, les marquages doivent rester lisibles.



52MQ

Clé à fourche



EN 60900

Ø mm	L mm	CHF	U	IP
6	90	42.00	1	000520106
7	96	42.00	1	000520107
8	100	42.00	1	000520108
9	108	42.00	1	000520109
10	110	42.00	1	000520110
11	120	42.00	1	000520111
12	132	44.50	1	000520112
13	140	47.00	1	000520113
14	146	48.50	1	000520114
15	166	50.00	1	000520115
16	156	54.50	1	000520116
17	168	54.50	1	000520117
18	170	56.50	1	000520118
19	176	56.50	1	000520119
21	190	61.50	1	000520121
22	200	61.50	1	000520122
24	225	66.50	1	000520124
27	210	87.00	1	000520127
30	240	90.50	1	000520130
32	240	92.50	1	000520132

89MQ

Clé polygonale contre-coudée



EN 60900

Ø mm	L mm	CHF	U	IP
6	150	54.00	1	000890106
7	155	54.00	1	000890107
8	155	54.00	1	000890108
9	160	54.00	1	000890109
10	170	54.00	1	000890110
11	180	54.00	1	000890111
12	190	59.00	1	000890112
13	195	62.50	1	000890113
14	200	66.50	1	000890114
15	210	67.50	1	000890115
16	216	72.00	1	000890116
17	218	72.00	1	000890117
18	236	77.00	1	000890118
19	240	77.00	1	000890119
21	250	88.00	1	000890121
22	255	88.00	1	000890122
24	280	100.00	1	000890124
27	300	106.00	1	000890127
30	320	124.50	1	000890130
32	340	126.50	1	000890132

110MQ

Clé à molette à ouverture graduée



EN 60900

L mm	A max	CHF	U	IP
200	28	108.00	1	001100520
250	30	124.50	1	001100525
300	30	181.50	1	001100530

606MQ/50

Clé dynamométrique à déclenchement avec cliquet réversible



EN 60900
UNI EN 26789
ISO 6789

Nm	Kgfm	lbf.ft	A mm	L mm	i g
5÷50	0,5÷5	4÷40	90	375	1130

606MQ/50	CHF	1	006060705
	1,042.00		

850MQ

Poignée porte-embouts magnétique isolée bimatières



IMQ CSV
EN 60900

L mm	L1 mm	D mm	CHF	1	008500910
233	125	12.5	31.50		

910MQ/B

Douille 12 pans



EN 60900

Ø mm	L mm	Ø1 mm	Ø mm	CHF	1	009100616
6	45	14	24	38.50		
7	45	15	24	38.50		
8	45	16	24	38.50		
9	45	17	24	38.50		
10	45	19	24	38.50		
11	45	20	24	38.50		
12	45	24	24	38.50		
13	45	24	24	38.50		
14	45	25	24	38.50		
15	45	27	24	40.50		
16	45	27,5	24	40.50		
17	45	30	24	41.50		
18	45	31	24	41.50		
19	45	32	24	41.50		

910MQ/PE

Douille tournevis pour vis 6 pans creux



EN 60900

mm	Ø mm	L mm	CHF	1	009100604
4	24	100	43.50		
5	24,5	100	43.50		
6	25,0	100	43.50		
8	25,0	100	43.50		
10	25,5	100	44.50		

910MQ/TX

Douille tournevis pour vis Torx®



EN 60900

T	Ø mm	L mm	L1 mm	CHF	1	009100641
T15	23	116	61	54.50		
T20	24,5	116	65	54.50		
T25	24,5	116	65	54.50		
T27	24,5	116	65	54.50		
T30	24,5	116	65	56.00		
T40	24,5	116	65	56.50		

910MQ/XZN

Douille tournevis pour vis XZN®



EN 60900

M	Ø mm	L mm	L1 mm	CHF	1	009100658
M8	24	106	57	51.00		
M10	24	106	57	52.50		

910MQ/PT

Rallonge pré-étalonnée carré femelle 3/8"



EN 60900

Nm	L mm	L1 mm	CHF	1	009100801
12	80	35,5	288.00		

910MQ/21

Rallonge carrés mâle et femelle 3/8"



EN 60900

L mm	Ø mm	CHF	1	009100804
140	13,4	69.50		

910MQ/22

Rallonge carrés mâle et femelle 3/8"



EN 60900

L mm	Ø mm	CHF	1	009100805
265	13,4	75.50		

910MQ/T

Poignée à béquille à cardan carré mâle 3/8"



EN 60900

L mm	L1 mm	CHF	1	009100807
200	165	82.50		

910MQ/55

Cliquet réversible carré mâle 3/8"



EN 60900

L mm	D mm	A mm	CHF	1	009100808
203	41	67	235.50		

910MQ/C16

Jeu 8 douilles 12 pans
Jeu 4 douilles tournevis pour vis 6 pans et 4 accessoires



EN 60900

910MQ/C16	CHF	1	009100917
	1,029.00		

○ 910MQ/B	8 - 10 - 11 - 12 - 13 - 14 - 17 - 19 mm
○ 910MQ/PE	4 - 5 - 6 - 8 mm
910MQ/21	125 mm
910MQ/22	250 mm
910MQ/T	
910MQ/55	

914MQ/A

Douille 6 pans, carré femelle 3/8", en technopolymères spéciaux sur base polyamide
Spécifique pour intervenir sur les batteries de voitures hybrides et électriques

Utiliser avec des clés dynamométriques



EN 60900

Ø mm	Ø mm	L mm	Ø1 mm	CHF	1	009140008
8	17,5	45	20	20.00	2	009140010
10	20,5	45	20	20.00	2	009140013
13	24	45	20	20.00	2	009140017
17	30	45	22	20.00	2	009140017



EN 60900

914MQ-A/S4	CHF	1	009140054
8-10-13-17 mm	80.00	1	009140054

920MQ/A

Douille 6 pans



EN 60900

Ø mm	Ø mm	L mm	Ø1 mm	CHF	1	009200238
8	21,5	57	27,5	38.50	1	009200239
9	21,5	57	27,5	38.50	1	009200240
10	21,5	57	27,5	38.50	1	009200241
11	21,5	57	27,5	38.50	1	009200242
12	23,0	57	27,5	38.50	1	009200243
13	23,0	57	27,5	38.50	1	009200244
14	23,0	57	27,5	39.50	1	009200246
16	23,0	57	27,5	40.50	1	009200247
17	30,0	57	27,5	40.50	1	009200248
18	32,0	57	27,5	41.50	1	009200249
19	32,2	57	27,5	41.50	1	009200250
20	32,0	57	27,5	46.50	1	009200251
21	34,0	57	27,5	46.50	1	009200252
22	36,0	57	27,5	46.50	1	009200254
24	39,0	57	27,5	47.50	1	009200257
27	42,0	57	27,5	48.50	1	009200260
30	44,0	57	27,5	50.00	1	009200262
32	48,0	57	27,5	51.50	1	009200262

920MQ/PE

Douille tournevis pour vis 6 pans creux



EN 60900

	Ø mm	L mm	L1 mm	CHF	1	009200264
*4	28,5	94,50	10,5	64.50	1	009200265
*5	28,5	94,5	10,5	64.50	1	009200266
*6	28,5	94,5	10,5	64.50	1	009200268
*8	28,5	94,5	10,5	67.00	1	009200267
10	28,5	94,5	10,5	67.00	1	009200269
12	28,5	94,5	10,5	67.00	1	009200269

920MQ/21

Rallonge carrés mâle et femelle 1/2"



EN 60900

L mm	Ø mm	CHF	1	009200804
135	28	73.50	1	009200804

920MQ/22

Rallonge carrés mâle et femelle 1/2"



EN 60900

L mm	Ø mm	CHF	1	009200805
264	30	83.50	1	009200805

920MQ/T

Poignée en T carré mâle 1/2"



EN 60900

L mm	L1 mm	CHF	1	009200807
200	163	88.00	1	009200807

920MQ/55A

Cliquet réversible carré mâle 1/2"



EN 60900

L mm	D mm	A mm	CHF	1	009200809
240	50	89	315.00	1	009200809

920MQ/C16

Jeu de 9 douilles 6 pans, 3 douilles tournevis pour vis 6 pans creux et 4 accessoires



EN 60900

920MQ/C16	CHF	1	009200917
	1,200.00	1	009200917

920MQ/A	8 - 10 - 12 - 13 - 14 - 17 - 19 - 22 - 24 mm
920MQ/PE	5 - 6 - 8 mm
920MQ/21	135 mm
920MQ/22	264 mm
920MQ/55A	
920MQ/T	
420x280x60 mm - 5,2 kg	

943MQ

Clé à douille emmanchée



EN 60900

Ø mm	L mm	L1 mm	D mm	CHF	1	009430235
5,5	233	125	12,2	25.00	1	009430236
6	233	125	12,5	25.00	1	009430237
7	240	125	14,3	26.50	1	009430238
8	240	125	15,3	27.00	1	009430240
10	252	125	17,3	28.00	1	009430243
13	252	125	21,3	31.00	1	009430243

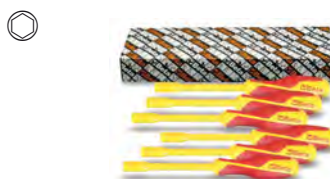

943MQ/S6	CHF	1	009430250
5,5-6-7-8-10-13 mm	163.00	1	009430250

951MQ

Clé mâle 6 pans en T



EN 60900

mm	L mm	L1 mm	CHF	1	009510703
3	120	105	62.50	1	009510704
*4	165	105	64.50	1	009510705
*5	170	105	64.50	1	009510706
*6	168	105	64.50	1	009510708
*8	165	105	65.50	1	009510710
10	200	105	68.00	1	009510710

993MQ

Brucelles à becs coudés



EN 60900

L mm	CHF	1	009930040
147	52.50		

994MQ

Brucelles à becs droits arrondis



EN 60900

L mm	CHF	1	009940040
145	51.50		

1010MQ

Pince à becs ronds long



EN 60900

L mm	L1 mm	CHF	1	010100096
160	51,5	63.00		

1048MQ

Pince multiprise entrepassée

• Finition chrome



EN60900

L mm	A max mm	L1 mm	CHF	1	010480315
250	48	39	93.00		

1082MQ

Pince coupante diagonale



EN 60900

L mm	L1 mm	mm	CHF	1	010820094
140	20	1,6	62.50		
160	22	1,6	65.50		

1084MQ

Pince coupante diagonale à faible effort de coupe



EN 60900

L mm	L1 mm	mm	CHF	1	010840100
200	26	2,0	82.50		

1088MQ

Pince coupante frontale



EN 60900

L mm	L1 mm	mm	CHF	1	010880096
160	7	1,6	78.00		

1128MQ

Ciseaux d'électriciens lames en acier inoxydable avec micro-denture



IEC60900

L mm	L1 mm	CHF	1	011280101
145	45	65.00		

1132MQ

Coupe-câbles avec branches isolées pour couper les câbles en cuivre et aluminium



EN 60900

L mm	mm	CHF	1	011320193
230	18	120.00		

1142MQ

Pince à dénuder



EN 60900

L mm	mm²	CHF	1	011420096
160	0,5-6	69.50		

1150MQ

Pince universelle chromée polie



EN 60900

L mm	L1 mm	mm	CHF	1	011500496
160	37	1,6	59.50		
180	39	1,8	65.00		
200	43	2,0	68.00		
220	46	2,0	74.50		

1162MQ

Pince à becs plats longs striés



EN 60900

L mm	L1 mm	mm	CHF	1	011620096
160	56	1,6	64.50		
200	76	1,6	68.00		

1164MQ

Pince à becs coudés plats longs



L mm	L1 mm	mm	CHF	1	011640096
160	54	1,6	67.00		
200	76	1,6	70.50		

1166MQ

Pince à becs demi-ronds longs striés



EN 60900

L mm	L1 mm	mm	CHF	1	011660096
160	56	1,6	64.50		
200	76	1,6	68.00		

1168MQ

Pince à becs coulés demi-ronds longs striés



EN 60900

L mm	L1 mm	mm	CHF	Icon	Icon
160	50	1,6	67.00	1	011680096
200	70	1,6	70.50	1	011680100

1169MQ/D2



1000 V

1169MQ/D2	CHF	Icon	Icon
1150MQ 180 mm	131.00	1	011690152
1082MQ 160 mm			

1272MQF

pour vis cruciformes à tête Phillips®

Slim

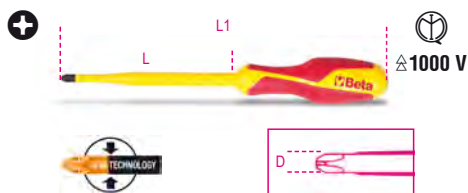

EN60900

PHxDxL mm	L1 mm	CHF	Icon	Icon
1x4,5x80	187	18.90	3	012720609
2x6x100	218	21.30	3	012720618

1272MQ

Tournevis pour vis Phillips®

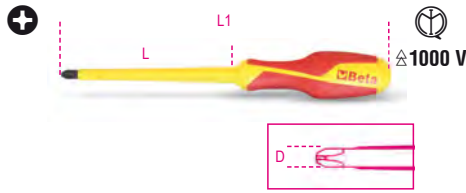

EN 60900

PHxDxL mm	L1 mm	CHF	Icon	Icon
0x3x60	160	12.70	3	012720703
1x4,5x80	187	15.50	3	012720709
2x6x100	218	17.70	3	012720718
3x8x150	276	22.90	2	012720724
4x10x200	326	27.00	2	012720727



1272MQ/S5	CHF	Icon	Icon
PH0x3x60-PH1x4,5x80 PH2x6x100-PH3x8x150 PH4x10x200 mm	96.00	1	012720751

1273MQF/D...

Jeu de 6 tournevis isolé 1000V "slim"



1273MQF/D4	CHF	Icon	Icon
1272MQF 1x4,5x80-2x6x100 mm 1274MQF 0,6x3,5x100-1x5,5x125 mm	75.00	1	012730604

1273MQF/D6	CHF	Icon	Icon
1272MQF 1x4,5x80-2x6x100 mm 1274MQF 0,6x3,5x100-1x4,5x100 1x5,5x125-1,2x6,5x150 mm	116.00	1	012730606

1273MQ/D6

Jeu de 6 tournevis



1273MQ/D6	CHF	Icon	Icon
1274MQ 0,5x3x100-0,8x4x100 1,0x5,5x125 mm 1272MQ PH0x3x60 -PH1x4,5x80 PH2x6x100 mm	90.50	1	012730851

1274MQF

Tournevis pour vis à fentes sans tête

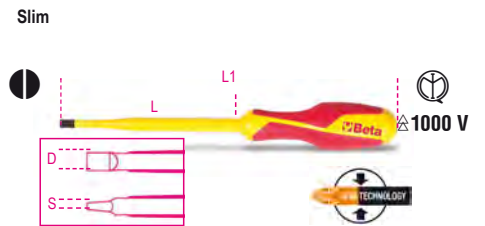

EN60900

SxDxL mm	L1 mm	CHF	Icon	Icon
0,6x3,5x100	200	16.10	3	012740603
1x4,5x100	205	18.00	3	012740606
1x5,5x125	232	19.00	3	012740609
1,2x6,5x150	268	22.70	3	012740612

1274MQ

Tournevis à lame fraisée pour vis à fente

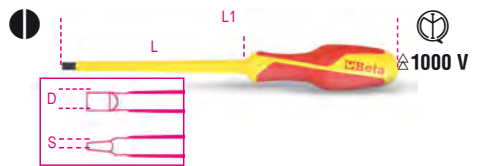

EN 60900

SxDxL mm	L1 mm	CHF	Icon	Icon
0,4x2,5x75	175	12.30	3	012740700
0,5x3x100	200	12.90	3	012740703
0,8x4x100	207	15.30	3	012740706
1x5,5x125	232	16.30	3	012740709
1,2x6,5x150	268	19.70	3	012740712
1,2x8x175	301	22.90	2	012740715
1,6x10x200	326	27.00	2	012740718



1274MQ/S6	CHF	Icon	Icon
0,5x3x100-0,8x4x100 1x5,5x125-1,2x6,5x150 1,2x8x175-1,6x10x200 mm	114.00	1	012740751

1275MQ/C

Tournevis pour vis cruciformes combinées PH + à fente

Slim

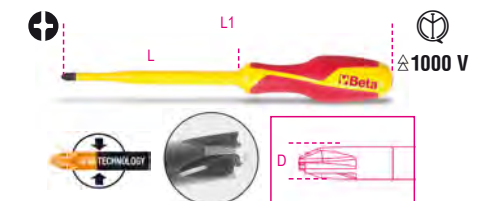

EN60900

Icon	Icon	CHF	Icon	Icon
PH1+LPP		17.40	2	012750409
PH2+LPP		19.70	2	012750418

1276MQ/C

Tournevis pour vis cruciformes combinées PZ + à fente

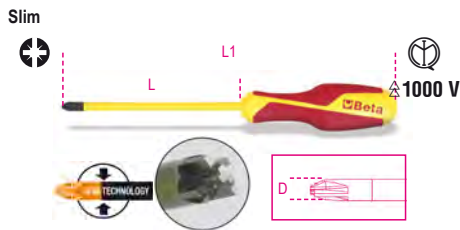

EN 60900

	CHF		
☉ PZ1+LPP	16.40	2	012760409
☉ PZ2+LPP	18.50	2	012760418

1279MQ/F

Tournevis pour vis Pozidriv®-Supadriv®

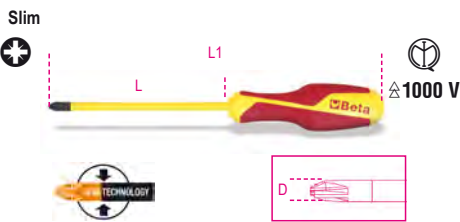

EN60900

pz	L mm	L1 mm	CHF		
1	80	187	17.40	3	012790409
2	100	218	19.70	3	012790418

1279MQ

Tournevis pour vis Pozidriv®-Supadriv®



EN 60900

PZ	L mm	L1 mm	CHF		
0	60	160	13.00	3	012790703
1	80	187	15.80	3	012790709
2	100	218	18.10	3	012790718
3	150	276	23.90	2	012790724



	CHF		
1279MQ/S4 PZ 0-1-2-3	70.50	1	012790751

1725MQ

Mini-scie



EN 60900

	L mm	H mm	CHF		
1725MQ	260	85	120.00	1	017250030

1777MQ/C

Couteau d'électricien avec dénudeur isolé

• pour câbles multipolaires



EN 60900

	L mm	CHF		
1777MQ/C	190	48.50	1	017770026

1777MQ/U

Couteau d'électricien avec dénudeur isolé



EN 60900

	L mm	CHF		
1777MQ/U	190	44.00	1	017770011

1777RL/U

4 lame de rechange pour 1777MQ/U



	CHF		
1777RL/U	34.50	1	017770021

1995MQ/T

Tapis isolant

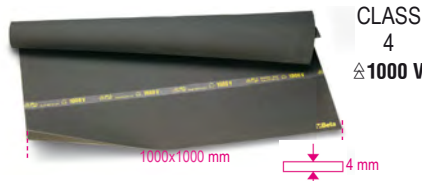

VDE 0303
EN 60243

	LxSxH mm	CHF		
1995MQ/T	1000x1000	402.00	1	019950030

1995MQ/G1 - G2

Gants isolants en latex



EN 60903

	Gr.	L mm	CHF		
1995MQ/G1	9	410	160.50	1	019950010
1995MQ/G2	10	410	160.50	1	019950013

1996MQ/T

Bâche isolante

500x500mm

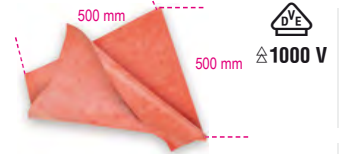

DIN EN 61112

	S mm	CHF		
1996MQ/T0,5	1.0	122.00	1	019960005

1996MQ/GM

Gants isolants composites

EN60903
EN388



EN 60903
EN 61482

	Gr.	L mm	CHF		
1996MQ/GM 9	9	410	206.00	1	019960109
1996MQ/GM 10	10	410	206.00	1	019960110

1996SVG

Instrument pour la vérification pneumatique des gants isolés

Obligatoire pour la EN90603



	CHF		
1996SVG	471.00	1	019960133

2115P L-MQ32



2115PL-MQ32	362
-------------	-----

2029EM



2029EM	355
--------	-----

5989 VEM



5989 VEM	517
----------	-----



OUTILS ANTI-CHUTE

Beta H-SAFE

La gamme des outils H-SAFE de Beta comprend plus de 200 références. Un système de retenue différent a donc été conçu selon les outils afin de résister aux sollicitations mécaniques les plus sévères et pour assurer une garantie de sécurité maximum.

De même, le confort d'utilisation ne doit pas être négligé. En effet, les outils présentant deux parties actives, comme les clés de serrage réf. 42, sont attachés par un câble en acier qui coulisse le long du corps de l'outil tandis que les outils utilisés en torsion, par exemple les tournevis sont attachés par des anneaux à rotation libre pour ne pas torsader le cordon de retenue.





Le système de retenue H-SAFE a été conçu, testé et produit dans les établissements Beta. Grâce au système de sécurité H-SAFE de Beta, les outils sont toujours à portée de main, de manière confortable et sûre

35HS

Burin nervuré H-SAFE





L mm	A mm	CHF		
200	23,0	52.00	1	000354004
250	28,5	65.50	1	000354005

42HS

Clé mixte H-SAFE





DIN 3113 UNI-HSO 7738

 mm	L mm	CHF		
6x6	95	26.50	1	000424506
7x7	105	27.00	1	000424507
8x8	116	27.50	1	000424508
9x9	127	28.00	1	000424509
10x10	137	28.50	1	000424510
11x11	148	29.00	1	000424511
12x12	158	29.50	1	000424512
13x13	169	30.00	1	000424513
14x14	180	31.50	1	000424514
15x15	190	31.50	1	000424515
16x16	201	32.00	1	000424516
17x17	212	34.00	1	000424517
18x18	222	34.50	1	000424518
19x19	233	35.50	1	000424519
20x20	243	36.50	1	000424520
21x21	254	39.00	1	000424521
22x22	264	40.50	1	000424522
23x23	275	42.00	1	000424523
24x24	285	44.00	1	000424524
25x25	296	44.00	1	000424525
26x26	307	45.00	1	000424526
27x27	317	48.50	1	000424527
28x28	328	49.00	1	000424528
29x29	338	54.00	1	000424529
30x30	349	56.00	1	000424530
32x32	370	61.50	1	000424532
34x34	391	101.00	1	000424534
36x36	412	111.00	1	000424536

42HS/AS

Clé mixte H-SAFE



 mm	L mm	CHF		
1/4x1/4	95	29.00	1	000424106
5/16x5/16	116	29.00	1	000424108
3/8x3/8	137	31.00	1	000424110
7/16x7/16	148	31.50	1	000424111
1/2x1/2	169	31.50	1	000424113
9/16x9/16	180	32.00	1	000424114
5/8x5/8	201	34.50	1	000424116
11/16x11/16	212	36.50	1	000424117

Ø"	L mm	CHF	🔧	📄
3/4x3/4	233	39.00	1	000424119
13/16x13/16	254	43.50	1	000424121
7/8x7/8	264	44.00	1	000424122
15/16x15/16	285	48.50	1	000424124
1x1	296	49.50	1	000424125
1.1/16x1.1/16	317	54.50	1	000424127
1.1/8x1.1/8	338	57.50	1	000424129
1.1/4x1.1/4	370	69.00	1	000424132
1.5/16x1.5/16	391	104.00	1	000424133

55HS

Clé à fourches H-SAFE



UNI-ISO 10102 DIN 3110

Ø mm	L mm	CHF	🔧	📄
• 6x7	120	21.50	1	000554012
• 8x9	140	22.00	1	000554021
• 10x11	155	22.30	1	000554030
• 12x13	170	24.30	1	000554042
• 14x15	185	24.90	1	000554054
• 16x17	202	26.50	1	000554060
• 18x19	220	28.00	1	000554066
• 20x22	236	29.50	1	000554075
• 21x23	245	31.50	1	000554078
• 22x24	245	33.50	1	000554081
• 24x27	262	36.50	1	000554090
• 30x32	297	46.00	1	000554108
• 34x36	325	103.00	1	000554117

91HS-C

Clé polygonale contre-coudée gros effort H-SAFE



Ø mm	Ø mm	CHF	🔧	📄
36	54	126.00	1	000914036
41	62	147.00	1	000914041
46	69	170.50	1	000914046

91HS

Clé polygonale contre-coudée gros effort H-SAFE



Ø mm	Ø mm	CHF	🔧	📄
36	54	251.00	1	000914236
41	62	272.00	1	000914241
46	69	321.00	1	000914246

92HS

Manche tubulaire pour 91 H-SAFE



L mm	91 mm	Ø mm	CHF	🔧	📄
610	32±41	22	125.00	1	000924020
760	46±55	25	150.50	1	000924030

93HS

Clé polygonale pour échafaudage H-SAFE



Ø mm	L mm	CHF	🔧	📄
21x22	310	72.50	1	000934021

96TBP-HS

Clé mâle 6 pans coudée à tête sphérique et à poignée en T, équipée du système de retenue antichute H-SAFE



Ø mm	L mm	L1 mm	Ø mm	CHF	🔧	📄
2,5	153	55	4	34.00	1	000964685
3	153	55	4	35.50	1	000964686
4	179	70	5	36.00	1	000964687
5	200	84	6	36.50	1	000964688
6	221	103	7	39.50	1	000964689
8	255	117	10	46.00	1	000964690
10	285	132	12	50.00	1	000964692

96THS

Clé mâle 6 pans à poignée en T haute performance H-SAFE

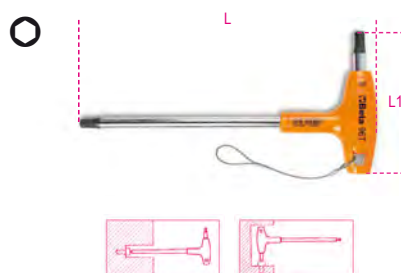

mm	L mm	L1 mm	CHF	🔧	📄
2,5	153	55	33.00	1	000964935
3	153	55	33.50	1	000964936
4	179	70	34.00	1	000964938
5	200	84	34.50	1	000964940
6	221	103	37.00	1	000964941
8	255	117	44.00	1	000964943
10	285	132	47.50	1	000964945

96THS-AS

Clé mâle 6 pans à poignée en T haute performance H-SAFE



Ø"	L mm	L1 mm	Ø mm	CHF	🔧	📄
5/32	200	84	6	37.00	1	000964673
3/16	200	84	6	37.00	1	000964674
7/32	221	103	7	41.50	1	000964675
1/4	236	106	8	42.50	1	000964676
5/16	255	117	10	46.00	1	000964678
3/8	285	132	12	51.00	1	000964680

97TTXHS

Clé mâle pour vis TORX® à poignée en T haute performance H-SAFE

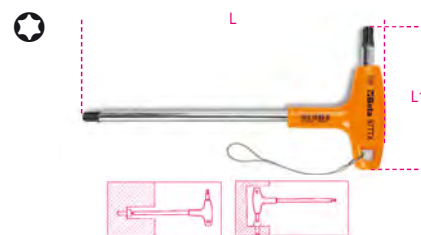

Ø	L mm	L1 mm	CHF	🔧	📄
T10	179	70	33.50	1	000974710
T15	179	70	34.00	1	000974715
T20	179	70	34.50	1	000974720
T25	179	70	35.50	1	000974725
T30	200	84	41.00	1	000974730
T40	221	103	43.50	1	000974740
T45	236	106	46.50	1	000974745
T50	255	117	57.00	1	000974750

111E-HS

Clé à molette à ouverture graduée, chromée

équipée du système de retenue antichute H-SAFE

- Rotation de la molette vers la droite
- Échelle millimétrique et en pouces



DIN 3117 ISO 6787

L mm	L"	A max mm	CHF	🔧	📄
200	8	29	67.00	1	001114120
250	10	34	75.50	1	001114125
300	12	40	93.50	1	001114130
380	15	45	159.50	1	001114138
450	18	54	252.00	1	001114145

142HS

Clé mixte à cliquet réversible H-SAFE



mm	L mm	CHF		
8x8	136	42.00	1	001424008
9x9	143	43.50	1	001424009
10x10	159	44.00	1	001424010
11x11	168	44.50	1	001424011
12x12	174	45.00	1	001424012
13x13	180	46.50	1	001424013
14x14	190	47.50	1	001424014
15x15	200	49.50	1	001424015
16x16	216	53.50	1	001424016
17x17	233	54.50	1	001424017
18x18	239	57.50	1	001424018
19x19	248	58.00	1	001424019
21x21	285	70.00	1	001424021
22x22	285	71.50	1	001424022
24x24	325	82.50	1	001424024
27x27	355	109.50	1	001424027
30x30	420	126.50	1	001424030
*32x32	420	131.50	1	001424032

360HS

Clé serre-tubes modèle Stillson H-SAFE



L mm	Ø max * mm	CHF		
250	1" gas	68.00	1	003604025
350	1 1/2" gas	84.50	1	003604035
450	2" gas	109.00	1	003604045
600	2 1/2" gas	155.50	1	003604060



LC system, système de retenue à double sphère. Le relâchement de la douille advient uniquement par le biais de la touche

666HS

Clé dynamométrique à déclenchement ZERO-RESET avec cliquet réversible pour serrage à droite
Précision de serrage : ± 3%
avec système de retenue antichute H-SAFE

• Sans besoin d'être déchargée



ISO 6789

Nm	■	D mm	A mm	L mm	LC system	g	■
10÷50	3/8	30	33	342	-	680	0,25

CHF		
666HS/5	348.00	1 006664705

Nm	■	D mm	A mm	L mm	LC system	g	■
20÷100	3/8	30	33	385	-	760	0,25

CHF		
666HS/10	353.00	1 006664710

Nm	■	D mm	A mm	L mm	LC system	g	■
40÷200	1/2	42	43	471	*	1020	0,5

CHF		
666HS/20LC	398.00	1 006664721

Nm	■	D mm	A mm	L mm	LC system	g	■
60÷300	1/2	42	43	600	*	1270	1,0

CHF		
666HS/30LC	446.00	1 006664731

900E-HS/55

Cliquet réversible H-SAFE



DIN 3122 - UNI-ISO 3315

L mm	Ø mm	A mm	■	CHF		
125	25	18	1/4	65.50	1	009004880

910E-HS/55

Cliquet réversible H-SAFE

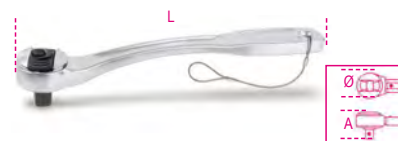

DIN 3122 - UNI-ISO 3315

L mm	Ø mm	A mm	■	CHF		
200	30	33	3/8	72.50	1	009104880

920E-HS/55LC

Cliquet réversible avec "Locking system" H-SAFE

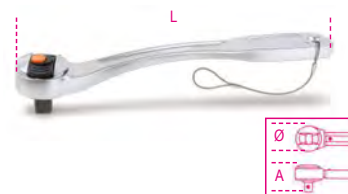

DIN 3122 - UNI-ISO 3315

L mm	Ø mm	A mm	■	CHF		
275	40	43	1/2	107.00	1	009204860

932HS

Clé à pipe débouchée chromée polie H-SAFE

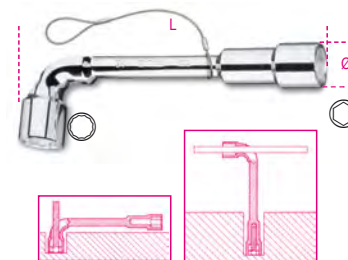

NF E 74.303

mm	Ø mm	L mm	CHF		
6x6	11,5	110	35.50	1	009324006
7x7	12,5	116	36.50	1	009324007
8x8	13,0	120	39.00	1	009324008
9x9	14,0	125	39.50	1	009324009
10x10	16,5	133	41.00	1	009324010
11x11	17,5	143	42.50	1	009324011
12x12	19,0	148	44.00	1	009324012
13x13	19,5	154	44.50	1	009324013
14x14	21,5	167	47.50	1	009324014
15x15	22,5	182	48.50	1	009324015
16x16	24,5	193	49.50	1	009324016
17x17	26,0	198	51.00	1	009324017
18x18	26,5	215	54.50	1	009324018
19x19	29,0	220	57.50	1	009324019

1032HS

Pince pour circlips intérieurs à becs droits H-SAFE



UNI 7914 DIN 5256

L mm	Ø mm	Ø1 mm	A mm	CHF		
140x1,3	12÷25	1,3	20	49.00	1	010324014
180	19÷60	1,9	21	52.00	1	010324017

Beta

1034HS

Pince pour circlips intérieurs à becs coudés à 90° H-SAFE



UNI 7914 DIN 5256

L	Ø	Ø1	A	CHF		
mm	mm	mm	mm			
170	19÷60	1,9	21	55.00	1	010344017

1036HS

Pince pour circlips extérieurs à becs droits H-SAFE



UNI 7915 DIN 5254

L	Ø	Ø1	A	CHF		
mm	mm	mm	mm			
140x1,3	10÷25	1,3	20	52.00	1	010364014
175	19÷60	1,9	21	53.50	1	010364017

1038HS

Pince pour circlips extérieurs à becs coudés à 90° H-SAFE



UNI 7915 DIN 5254

L	Ø	Ø1	A	CHF		
mm	mm	mm	mm			
175	19÷60	-	21	57.00	1	010384017

1048BM-HS

Pince multiprise entrepassée branches bimatières H-SAFE

· nouveau modèle neuf positions

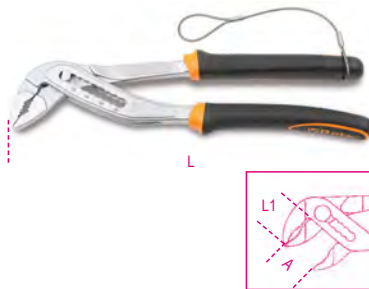

ISO 8976

L	A max	L1	g	CHF		
mm	mm	mm	g			
250	48	39	460	82.00	1	010484215

1052HS

Pince-étau universelle à mâchoires concaves H-SAFE



L	A	A1 max	S	CHF		
mm	mm	mm	mm			
240	72	42	10,0	67.50	1	010524024

1082BM-HS

Pince coupante diagonale branches gainées confort bi-matières H-SAFE



UNI/ISO 5749

L	L1	mm	A	CHF		
mm	mm	mm	mm			
160	22	1,6	28,0	66.50	1	010824036

1088BM-HS

Pince coupante frontale à faible effort de coupe branches gainées confort bi-matières H-SAFE

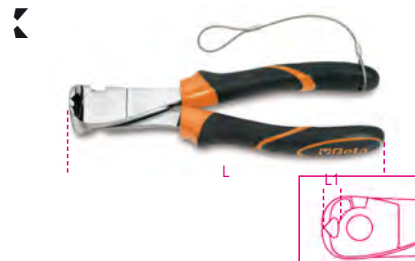

UNI/ISO 5748

L	L1	mm	A	CHF		
mm	mm	mm	mm			
160	9	1,6	28,0	76.00	1	010884036
200	11	2,0	36,0	95.50	1	010884040

1128BAX-HS

Ciseaux d'électriciens à double effet, avec profils à foret en acier inoxydable revêtu en DLC H-SAFE

Coupe à double effet : à travers une came spéciale sur le point d'appui, l'on obtient un déplacement longitudinal des lames qui, lors de la phase de fermeture, en augmente la puissance de coupe.

Profil et foret : étudiés pour élargir les orifices sur plastique de 13 à 25 mm.

Revêtement DLC : le carbone de type diamant (DLC - diamond-like carbon) est un revêtement innovant à base de carbone : la grande dureté et le faible coefficient de frottement sont dus à la présence simultanée de carbone déposé sur la surface en forme de graphite et diamant.

- Grande dureté superficielle des lames (résistance à l'abrasion et maintien de l'affûtage dans le temps)
- Faible coefficient de frottement (glissement et puissance de coupe)
- Embout excentrique anti-ralentissement
- Branches amples avec gorges auto-serrantes
- Fournis avec étui en plastique articulé



L	L1	mm ²	CHF		
mm	mm	mm ²			
150	50	50	63.00	1	011284088



1132BM-HS

Coupe-câbles branches gainées confort bi-matières H-SAFE



UNI 8791

L	mm	A	B	CHF		
230	18	37	12,5	116.00	1	011324143

1150BM-HS

Pince universelle chromée polie branches gainées confort bi-matières H-SAFE



ISO 5746

L	L1	mm	A	CHF		
160	42	1,6	22,0	57.50	1	011504146
180	46	1,8	25,0	60.00	1	011504148
200	50	2,0	27,0	66.50	1	011504150

1166BM-HS

Pince à becs demi-ronds longs striés branches gainées confort bi-matières H-SAFE



ISO 5745

L	L1	mm	A	CHF		
200	76	1,6	22,0	68.00	1	011664040

1168BM-HS

Pince à becs coulés demi-ronds longs striés branches gainées confort bi-matières H-SAFE



ISO 5745

L	L1	mm	A	CHF		
200	70	1,6	22,0	72.00	1	011684040

1290HS

Tournevis pour vis à fente H-SAFE



ISO 2380

SxAxL	L1	Ø	CHF		
0,4x2,5x75	171	2,5	23.70	1	012904006
0,5x3x100	196	3,0	24.60	1	012904012
0,6x3,5x100	196	3,5	26.00	1	012904021
0,8x4x100	196	4,0	25.50	1	012904030
0,8x4x150	246	4,0	27.00	1	012904036
1x5,5x150	259	5,0	30.50	1	012904042
1,2x6,5x150	270	6,0	32.00	1	012904051
1,2x8x150	282	7,0	35.50	1	012904057
1,6x10x200	332	8,0	42.00	1	012904066

1292HS

Tournevis pour vis Phillips® H-SAFE



UNI/ISO 8764

PHxDxL	L1	CHF		
0x3x100	196	24.80	1	012924006
1x4,5x120	229	27.50	1	012924012
2x6x150	270	33.00	1	012924021
3x8x150	282	38.00	1	012924024

1294HS

Tournevis à lame fraisée pour vis à fente H-SAFE



SxDxL	L1	CHF		
0,5x2,5x60	156	23.10	1	012944003
0,6x3x75	171	23.30	1	012944006
0,8x4x100	196	25.50	1	012944012
1x5x125	234	30.00	1	012944018

1299HS

Tournevis pour vis Pozidriv®-Supadriv® H-SAFE



UNI/ISO 8764

PZ	L	L1	CHF		
0	60	156	26.00	1	012994000
1	80	189	29.00	1	012994003
2	100	220	35.50	1	012994006
3	150	282	44.50	1	012994009

1370T-HS

Marteau de mécanicien, manche en fibre H-SAFE



g	A	L	L1	CHF		
300	23	300	105	49.00	1	013704630
500	27	320	118	52.50	1	013704650
1000	36	360	135	66.50	1	013704700

1370FT-HS

Marteau de mécanicien tête rivoir, manche en fibre



A	L	L1	B	CHF		
mm	mm	mm	mm			
28	280	86	22	67.50	1	013704528
30	280	92	24	68.00	1	013704530
36	300	104	29	80.50	1	013704536

1390HS

Maillet à embouts nylon, manche en bois H-SAFE



UNI 7784

D	L	L1	CHF		
mm	mm	mm			
35	310	95	62.00	1	013904035
45	320	107	88.00	1	013904045

1392HS

Maillet sans rebond à poignées surmoulées grand confort, manche en acier H-SAFE



D	L	L1	CHF		
mm	mm	mm			
35	305	115	90.00	1	013924035
40	310	125	100.50	1	013924040
50	325	135	117.00	1	013924050
60	385	155	170.50	1	013924060

1602A-HS

Pince à cosse préisolées, modèle standard H-SAFE



mm ²	L	A	B	CHF		
	mm	mm	mm			
0+6	220	42	4	95.50	1	016024005

1682HS

Réglet flexible en acier inoxydable H-SAFE

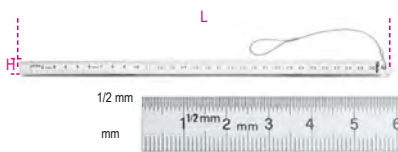

L	H	±	CHF		
mm	mm	mm			
200	13	0,5	21.50	1	016824020
300	13	0,5	24.30	1	016824030

1692HS

Mètre à ruban boîtier ABS antichoc bi-matériaux ruban en acier classe de précision: II H-SAFE



L	S	CHF		
m	mm			
3	16	29.00	1	016924053
5	19	34.00	1	016924055

1708HS/20

Jauges d'épaisseur H-SAFE

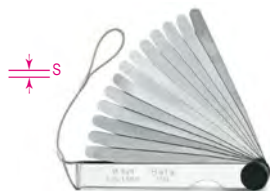

S	S	L	CHF		
mm	mm	mm			
0,05=1,0	0,002=0,040	105	31.50	1	017084020

1727HS

Monture de scie à métaux type soudeur avec lame H-SAFE

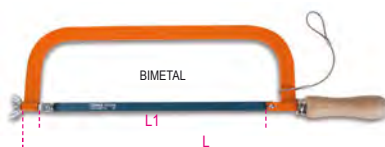

L	L1	CHF		
mm	mm			
515	300	44.00	1	017274001

1743HS

Pince pour colliers en Nylon H-SAFE



L	A	B	CHF		
mm	mm	mm			
195	85	17	91.00	1	017434001

1750HS

Pompe à graisse à levier H-SAFE



1 g, 550 bar Max

cc	L	CHF		
mm	mm			
500	380	77.00	1	017504500

1760BHS

Multimètre digital H-SAFE



SPÉCIFICATIONS

Tension CC : 200 mV-2/20/200/1000V
 Tension CA : 2-20/200/700V
 Courant CC : 2/20/200 mA-20 A
 Courant CA : 2/200 mA- 20 A
 Résistance : 200Ω - 2/20/200 kΩ - 2/20 MΩ
 Capacité : 2/20/200 nF - 2/200 μF
 Température : -20° + 1000°C/ -4 °F ~ +2000°F
 Fréquence : 20kHz
 Alimentation: 1 pile 9 V (fournie)

1760BHS	CHF		
	303.00	1	017604012

1772H-HS

Cutter de sécurité à lame rétractable, avec 2 lames H-SAFE



L mm	A mm	CHF		
170	18	39.50	1	017724029

1778SOS-HS

Couteau de survie auto avec fonction marteau brise-vitre et coupe-ceinture de sécurité avec étui H-SAFE



L mm	A mm	L1 mm	CHF		
205	25	85	63.00	1	017784080

8871

Ceinture de sécurité avec boucle métallique à double verrouillage, pour connecter les outils H-SAFE



	L cm min-max	CHF		
8871 70	70-100	179.00	1	088710070
8871 100	100-135	194.00	1	088710100

8872A

Passant fixe

• Pour ceinture 8871



	CHF		
8872A 50	31.50	1	088720050

8872AS

Passant ouvrable type "scratch"

• Pour ceinture 8871



	D mm	CHF		
8872AS 25	25	29.00	1	088720525

8873

Sacoche porte-outils, avec fermeture autoserrante et fermeture éclair

• Pour ceinture 8871



	CHF		
8873 230	152.00	1	088730230

8877

Sangle de connexion élastique

• MAX 2.7 kg



	L cm min-max	DxL mm	CHF		
8877 80	70-110	40x80	39.00	1	088770080

8877M

Sangle de connexion élastique

• Avec raccord anti-vrillage • MAX 2.7 kg



	L cm min-max	DxL mm	CHF		
8877M 20-140	20-140	30x60	69.50	1	088770510

8879

Bracelet type "scratch"

• MAX 2.7 kg



	D mm	CHF		
8879	30	44.50	1	088790025

8880

Sangle de connexion rigide

• Avec raccord anti-vrillage



	L Cm	D mm	CHF		
8880 30	30	10	34.50	1	088800030

8883

Sac porte-outils

- En nylon 840 anti-abrasion
- MAX 20 kg
- Mousqueton pour bloquer la fermeture éclair en fin de course
- 6 courroies antichute pour outils
- Poche interne



	DxH cm	CHF		
8883	30x40	367.00	1	088830030





OUTILS EN ACIER INOXYDABLE



Les outils BETA INOX peuvent être utilisés dans des environnements critiques, à savoir des zones où aucun niveau de contamination n'est admis.

Quelques exemples :

- Applications nucléaires
- Production pharmaceutique – classe C
- Applications en haute mer
- Laboratoires biotechnologiques et biomédicaux
- Industrie alimentaire.

Les outils Beta Inox évitent le phénomène de la rouille impropre.

En utilisant des outils qui ne sont pas en acier inoxydable sur des vis, écrous ou surfaces en acier inoxydable, des particules peuvent se détacher de ces outils et déclencher des processus de corrosion, en créant souvent des problèmes esthétiques et parfois même des problèmes structurels.

Quelques exemples d'applications :

- Chantiers navals
- Bâtiment
- Installations solaires
- Construction automobile.



INOX + SANS INOX
= ROUILLE



INOX + INOX
= ABSENCE DE ROUILLE

CARACTÉRISTIQUES

Le choix sélectif des matériaux et la recherche approfondie des meilleurs traitements thermiques confèrent aux outils Beta Inox des caractéristiques mécaniques bien au-dessus des valeurs des normes et comparables à celles des outils Beta standard.

L'ergonomie et le design des produits sont les mêmes que ceux des outils Beta connus et appréciés par les utilisateurs professionnels depuis plus de 75 ans.

L'acier inoxydable est 100% recyclable.

Une caractéristique qui a également toute son importance.



Marque pour les produits en acier inoxydable
Marque délivrée par Centro Inox – l'Association italienne pour l'Étude et le Développement des Aciers Inoxydables, caractérisant les produits réalisés en acier inoxydable.

34INOX

Burin plat,
en acier inoxydable



L mm	A mm	Ø mm	CHF		
160	18	18	54.50	1	000340318
200	20	20	80.50	1	000340320

39INOX

Coin plat,
en acier inoxydable



L mm	A mm	S mm	CHF		
100	50	10	38.00	1	000390310
150	50	13	68.00	1	000390315
200	40	40	199.50	1	000390320

42INOX

Clé mixte
en acier inoxydable



DIN 3113 - UNI ISO 7738

mm	L mm	CHF		
6x6	95	19.00	2	000420306
7x7	105	19.70	2	000420307
8x8	116	19.80	2	000420308
9x9	127	21.30	2	000420309
10x10	137	22.60	2	000420310
11x11	148	24.40	2	000420311
12x12	158	25.50	2	000420312
13x13	169	25.50	2	000420313
14x14	180	26.50	2	000420314
15x15	190	27.50	2	000420315
16x16	201	28.00	2	000420316
17x17	212	31.50	2	000420317
18x18	222	34.00	2	000420318
19x19	233	36.50	2	000420319
21x21	254	44.50	1	000420321
22x22	264	46.00	1	000420322
24x24	285	51.00	1	000420324
27x27	290	147.50	1	000420327
30x30	320	180.50	1	000420330
32x32	340	196.00	1	000420332
36x36	360	275.00	1	000420336
38x38	430	294.00	1	000420338
41x41	430	345.00	1	000420341
46x46	480	396.00	1	000420343
50x50	520	427.00	1	000420345
55x55	560	461.00	1	000420347
60x60	595	513.00	1	000420350



CHF		
287.00	1	000420391

42INOX/S11
6-8-10-11-12-13-
14-15-16-17-19 mm



CHF		
251.00	1	000420387

42INOX/SC9
8-10-11-12-13-14-15-17-19 mm

42INOX-AS

Clé mixte,
en acier inoxydable



"	L mm	CHF		
1/4x1/4	95	22.80	1	000420356
5/16x5/16	116	23.10	1	000420358
3/8x3/8	137	27.50	1	000420360
7/16x7/16	148	30.00	1	000420361
1/2x1/2	169	30.50	1	000420363
9/16x9/16	180	33.00	1	000420364
5/8x5/8	201	34.50	1	000420366
11/16x11/16	212	40.50	1	000420367
3/4x3/4	233	44.00	1	000420369
13/16x13/16	254	51.00	1	000420371
7/8x7/8	264	53.50	1	000420372
15/16x15/16	285	60.00	1	000420373



CHF		
286.00	1	000420396

42INOX-AS/S9
1/4-5/16-3/8-7/16-1/2
9/16-5/8-11/16-3/4



96BPINOX

Clé mâle 6 pans coudée à tête sphérique,
en acier inoxydable



mm	L mm	L1 mm	Ø g	CHF		
2	91	22	4	6.70	4	000961441
2,5	91	22	6	6.70	4	000961442
3	101	24	11	7.05	4	000961443
4	112	29	19	7.95	4	000961444
5	131	33	32	9.45	4	000961445
6	154	36	51	10.40	4	000961446
7	164	40	65	13.50	2	000961447
8	175	44	116	16.50	2	000961448
10	197	51	189	20.50	2	000961450



CHF		
65.50	1	000961455

96BPINOX/B6
2,5-3-4-5-6-8 mm

96BPINOX-AS

Clé mâle 6 pans coudée,
à tête sphérique,
en acier inoxydable

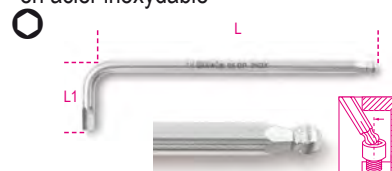

"	L mm	L1 mm	Ø g	CHF		
5/64	91	22	5,5	8.60	4	000961989
3/32	91	22	5,3	8.60	4	000961990
7/64	101	24	10,5	9.25	4	000961991
1/8	101	24	10,7	9.25	4	000961992
9/64	112	29	18,7	10.10	4	000961993
5/32	112	29	18,7	10.10	4	000961994
3/16	131	33	31,5	13.50	2	000961995
7/32	154	36	50,0	14.00	2	000961996
1/4	164	40	70,0	14.90	2	000961997
5/16	175	44	115,0	17.60	2	000961998
3/8	197	51	186,5	21.80	2	000961999



CHF		
104.50	1	000962000

96BPINOX-AS/B8
5/64-3/32-1/8-5/32-
3/16-7/32-1/4-5/16

CHF		
8.05	1	000961459

96BPINOX/BV

96TINOX

Clé mâle 6 pans coudée à poignée en T haute performance, en acier inoxydable

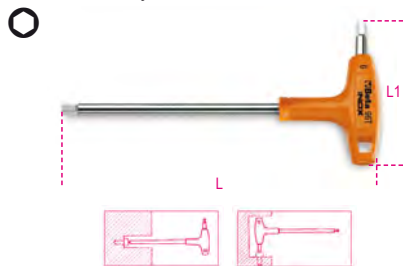

mm	L mm	L1 mm	CHF		
2,5	153	55	16.10	2	000961935
3	153	55	16.70	2	000961936
4	179	70	18.40	2	000961938
5	200	84	20.30	2	000961940
6	221	95	22.20	2	000961941
7	236	106	25.50	2	000961942
8	255	117	30.00	2	000961943
10	285	132	39.00	2	000961944



	CHF		
96TINOX/S5 2,5-3-4-5-6 mm	93.50	1	000961952
96TINOX/S8 2,5-3-4-5-6-7-8-10 mm	188.50	1	000961954

96TINOX-AS

Clé mâle 6 pans à poignée en T haute performance, en acier inoxydable

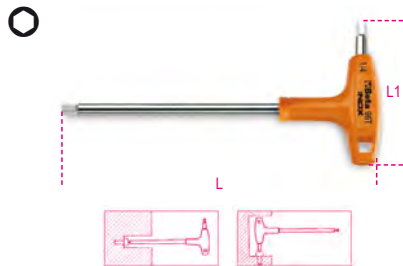

"	L mm	L1 mm	Ø mm	CHF		
3/32	153	55	3	17.60	2	000961861
7/64	153	55	4	18.00	2	000961862
1/8	179	70	4	20.20	2	000961863
9/64	179	70	5	20.60	2	000961864
5/32	200	84	6	21.70	2	000961865
3/16	200	84	6	23.30	2	000961866
7/32	221	103	7	27.00	2	000961867
1/4	236	106	8	28.50	2	000961868
5/16	255	117	10	34.50	2	000961869
3/8	285	132	12	38.00	2	000961870



	CHF		
96TINOX-AS/S7 3/32-1/8-5/32-3/16-7/32-1/4-5/16	173.00	1	000961877

111INOX

Clé à molette, en acier inoxydable



DIN 3117 - ISO 6787

L mm	L"	A max mm	A1 mm	CHF		
150	6	18	45	116.50	1	001110315
200	8	24	58	151.00	1	001110320
250	10	30	70	188.50	1	001110325

362INOX

Clé serre-tubes modèle américain, en acier inoxydable



L mm	Ø max mm	CHF		
300	58	255.00	1	003620430

920INOX-A

Douille 6 pans, en acier inoxydable



DIN 3124 - UNI ISO 2725

Ø mm	Ø	A mm	L mm	CHF		
8	15	10	40	40.50	2	009203008
9	16	10	40	42.50	2	009203009
10	17	10	40	44.50	2	009203010
11	18	11	40	47.50	2	009203011
12	19	11	40	51.00	2	009203012
13	20	11	40	54.00	2	009203013
14	21	11	40	56.50	2	009203014
15	23	11	40	59.50	2	009203015
16	24	11	40	62.00	2	009203016
17	25	11	40	64.00	2	009203017
18	26	13	42	66.50	2	009203018
19	28	13	42	69.00	2	009203019
20	29	13	42	73.00	1	009203020
21	30	13	43	74.50	1	009203021
22	31	15	43	75.00	1	009203022
24	34	15	43	87.50	1	009203024
27	38	18	46	107.00	1	009203027
30	42	20	46	127.00	1	009203030
32	44	20	46	144.00	1	009203032

920/55INOX

Cliquet réversible carré mâle 1/2" à 72 dents, en acier inoxydable



L mm	Ø mm	A mm	CHF		
264	40	43	309.00	1	009203882

920/R55INOX



	CHF		
920/R55 INOX	109.50	1	009203879

1048INOX

Pince multiprise entrecassée, en acier inoxydable
• Modèle 7 positions

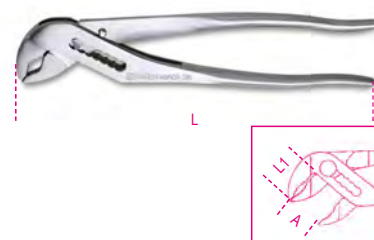

L mm	A max mm	L1 mm	CHF		
250	33	33	197.00	1	010480325

1082INOX

Pince coupante diagonale en acier inoxydable



L mm	L1 mm	mm	CHF		
150	20,0	1,6	143.00	1	010820350

1150INOX

Pince universelle à grande force de coupe en acier inoxydable

Embout décentré joint ouvert



L mm	L1 mm	CHF		
180	39	139.50	1	011500518



1153INOX

Pince universelle réglable "mécanicien", en acier inoxydable



L mm	L1 mm	CHF		
150	26	136.50	1	011530315

1290INOX

Tournevis pour vis à fente en acier inoxydable

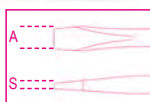

ISO 2380

SxAL mm	L1 mm	Ø mm	CHF		
0,4x2,5x50	146	2.5	11.80	4	012900403
0,5x3x75	171	3.0	12.10	4	012900409
0,8x4x100	196	4.0	12.50	4	012900430
1,0x5,5x150	259	5.0	16.00	4	012900442
1,2x6,5x150	270	6.0	18.40	4	012900451

1292INOX

Tournevis à lame courte pour vis Phillips®, en acier inoxydable



ISO 8764

PHxDxL mm	L1 mm	CHF		
0x3x60	156	11.00	4	012920403
1x4,5x80	189	13.00	4	012920409
2x6x100	220	16.00	4	012920418

1293INOX/D8

Jeu de tournevis en acier inoxydable



		CHF		
1293INOX/D8		111.00	1	012930408
1290INOX	0,4x2,5x50-0,5x3x75			
	0,8x4x100-1,0x5,5x150			
	1,2x6,5x150 mm			
1292INOX	PH0x60-PH1x80			
	PH2x100 mm			

1370INOX

Marteau de mécanicien en acier inoxydable



	A	L	L1	CHF		
g	mm	mm	mm	123.50	1	013700375
500	25	240	101			

1377INOX

Marteau américain en acier inoxydable



	L	L1	CHF		
g	mm	mm	72.00	1	013770623
230	220	82			
340	220	90	103.50	1	013770634

1730INOX

Grattoir universel, en acier inoxydable



	A	L	CHF		
mm	mm	mm	63.00	1	017300450
50		200			

C20TSS

Boîte à outils 5 cases en acier inoxydable AISI 304



	CHF		
C20TSS	384.00	1	021203001

450x200x210 mm - 4kg

T23



T23	549
TV23	549

T99



T99	552
TV99	552

T228



T228	556
TV180	555-556

Beta

Beta

C04TSS-7

Servante mobile d'atelier à 7 tiroirs complètement en acier inoxydable

Caractéristiques principales :

- 7 tiroirs de 570 x 410 mm montés sur glissières à billes de précision ;
- 6 tiroirs - hauteur 83 mm ;
- 1 tiroir - hauteur 170 mm ;
- 4 roues de Ø 125 mm: 2 fixes et 2 pivotantes avec freins ;
- Serrure centralisée centrale ;
- Structure complètement en acier inoxydable ;
- Roues, supports, sphères, intérieur des tiroirs et glissières en acier inoxydable;
- Poignée tiroirs en aluminium.

63 kg

Beta
INOX
STAINLESS STEEL

700
kg

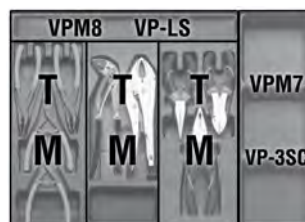

h	max
83 mm	25 kg
170 mm	30 kg

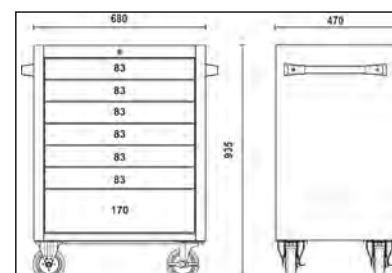
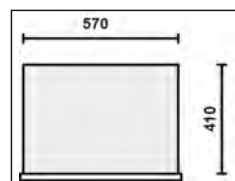

C04TSS/7

CHF 3,430.00 1 024003077



CUIVRE-BÉRYLLIUM Cu-Be

Les outils antidéflagrants **Beta** sont prévus pour opérer en toute sécurité dans les environnements à risque d'explosion potentiel, en présence de liquides ou de gaz inflammables, ou pour les applications qui nécessitent l'utilisation d'outils amagnétiques et résistants à la corrosion.



Les outils antidéflagrants sont certifiés par l'institut de recherche et d'essai BAM, conformément à la Directive européenne 99/92/EC



ATTENTION :
Risque d'explosion en présence d'**ACÉTYLÈNE**.

Les outils antidéflagrants ont des caractéristiques mécaniques différentes de celles des outils courants en acier. Nous recommandons de les utiliser avec une attention particulière, en évitant les surcharges.

CLASSIFICATION DES ZONES À RISQUE D'EXPLOSION

ATEX		MOYENNE BASSE	TRÈS BASSE
GAZ		<p>ZONE 1 Zone où pendant les activités normales il peut se former une atmosphère explosive consistant en un mélange d'air et de substances inflammables sous forme de gaz, vapeur ou brouillard.</p>	<p>ZONE 2 Zone où, pendant les activités normales, il est peu probable qu'il se forme une atmosphère explosive consistant en un mélange d'air et de substances inflammables sous forme de gaz, vapeur ou brouillard et, si cela se produit, le phénomène sera uniquement de courte durée.</p>
	POUSSIÈRE	<p>ZONE 21 Zone où pendant les activités normales il peut se former occasionnellement une atmosphère explosive sous forme de nuage de poussières combustibles dans l'air.</p>	<p>ZONE 22 Zone où, pendant les activités normales, il est peu probable qu'il se forme une atmosphère explosive sous forme de nuage de poussières combustibles dans l'air et, si cela se produit, le phénomène sera uniquement de courte durée.</p>

30BA

Chasse-clous antidéflagrant



∅ mm	L mm	S mm	CHF	🔧	📦
5	150	15	82.00	1	000300806
8	150	17	101.00	1	000300808
10	150	19	125.00	1	000300810

31BA

Chasse-goupilles antidéflagrant



∅ mm	L mm	CHF	🔧	📦
3	110	35.50	1	000310853
4	110	77.00	1	000310854
6	115	117.00	1	000310856
8	120	132.50	1	000310858

31BA/C

Chasse-clous antidéflagrant conique



∅ mm	∅1 mm	L mm	CHF	🔧	📦
★6	12	150	47.50	1	000310876
★7	13	150	56.50	1	000310877
★12	18	175	120.00	1	000310882
★13	29	255	377.00	1	000310883

32BA

Pointeau antidéflagrant



∅ mm	L mm	CHF	🔧	📦
14	150	113.00	1	000320811

34BA

Burin plat antidéflagrant



L mm	A mm	CHF	🔧	📦
200	22	153.00	1	000340801
250	24	256.00	1	000340803
300	25	345.00	1	000340802

39BA

Coin plat antidéflagrant



L mm	A mm	CHF		
150	40	67.00	1	000390801
230	40	225.00	1	000390802
250	40	352.00	1	000390803

42BA

Clé mixte antidéflagrante



mm	L mm	CHF		
6x6	105	71.50	1	000420806
7x7	105	80.50	1	000420807
8x8	120	90.00	1	000420808
9x9	120	103.00	1	000420809
10x10	135	111.00	1	000420810
11x11	135	117.00	1	000420811
12x12	150	128.50	1	000420812
13x13	150	132.50	1	000420813
14x14	175	139.00	1	000420814
15x15	175	146.50	1	000420815
16x16	195	152.00	1	000420816
17x17	200	159.50	1	000420817
18x18	215	178.50	1	000420818
19x19	220	182.00	1	000420819
20x20	230	189.50	1	000420820
21x21	240	201.50	1	000420821
22x22	250	214.50	1	000420822
24x24	268	249.00	1	000420824
26x26	290	301.00	1	000420826
27x27	290	335.00	1	000420827
28x28	290	393.00	1	000420828
30x30	313	402.00	1	000420830
32x32	333	441.00	1	000420832
34x34	360	481.00	1	000420834
35x35	360	546.00	1	000420835
36x36	355	569.00	1	000420836
38x38	430	600.00	1	000420838
41x41	430	706.00	1	000420841
46x46	480	826.00	1	000420846
50x50	520	874.00	1	000420850
55x55	560	962.00	1	000420855
60x60	580	1,027.00	1	000420860
*65x65	595	1,171.00	1	000420865
*70x70	630	1,315.00	1	000420870

42BA-AS

Clé mixte antidéflagrante



mm	L mm	CHF		
9/32x9/32	120	77.00	1	000420946
5/16x5/16	120	77.00	1	000420947
11/32x11/32	135	98.00	1	000420948
3/8x3/8	128	103.00	1	000420950
7/16x7/16	135	117.00	1	000420951

mm	L mm	CHF		
15/32x15/32	140	129.00	1	000420949
1/2x1/2	140	134.00	1	000420953
9/16x9/16	163	145.00	1	000420954
*19/32x19/32	195	174.00	1	000420955
5/8x5/8	177	175.50	1	000420956
11/16x11/16	195	187.00	1	000420957
3/4x3/4	215	193.00	1	000420959
13/16x13/16	230	225.00	1	000420961
7/8x7/8	235	233.00	1	000420962
15/16x15/16	256	259.00	1	000420964
*31/32x31/32	265	285.00	1	000420963
1x1	266	281.00	1	000420965
1.1/16x1.1/16	283	316.00	1	000420967
1.1/8x1.1/8	297	417.00	1	000420969
1.3/16x1.3/16	308	450.00	1	000420970
1.1/4x1.1/4	324	529.00	1	000420973
*1.7/16x1.7/16	360	642.00	1	000420976

55BA

Clé à fourches antidéflagrante



mm	L mm	CHF		
6x7	90	49.00	1	000550801
8x9	100	52.50	1	000550802
8x10	100	54.50	1	000550795
9x11	110	58.00	1	000550797
10x11	120	62.00	1	000550803
12x13	130	78.00	1	000550804
*12x14	130	95.00	1	000550846
13x14	133	94.00	1	000550799
14x15	145	95.00	1	000550805
14x17	150	101.00	1	000550806
16x17	165	102.50	1	000550807
17x19	170	134.00	1	000550847
18x19	170	137.00	1	000550809
*19x22	185	156.00	1	000550810
20x22	185	157.50	1	000550811
21x23	210	171.50	1	000550813
22x24	210	204.50	1	000550815
24x26	230	240.00	1	000550817
24x27	230	256.00	1	000550818
25x28	230	278.00	1	000550819
27x29	246	325.00	1	000550820
30x32	265	379.00	1	000550822
36x38	320	481.00	1	000550826
36x41	335	529.00	1	000550828
41x46	355	658.00	1	000550829
*46x50	370	754.00	1	000550830
*50x55	385	802.00	1	000550831
*55x60	415	996.00	1	000550832

55BA-AS

Clé à fourches antidéflagrante



mm	L mm	CHF		
3/8x7/16	110	64.50	1	000550853
1/2x9/16	130	77.00	1	000550854
5/8x11/16	160	113.00	1	000550857
3/4x13/16	180	139.00	1	000550859
7/8x15/16	210	196.00	1	000550865
1x1.1/16	230	265.00	1	000550868
1.1/8x1.3/16	245	345.00	1	000550870
1.1/4x1.5/16	255	408.00	1	000550872

58BA

Clé à fourches à frapper antidéflagrante



mm	L mm	CHF		
17	125	131.50	1	000580817
19	125	136.50	1	000580819
22	135	137.00	1	000580822
24	150	154.50	1	000580824
27	165	189.00	1	000580827
30	180	237.50	1	000580830
32	190	278.00	1	000580832
*34	200	317.00	1	000580834
36	210	329.00	1	000580836
38	220	362.00	1	000580838
41	230	408.00	1	000580841
46	240	489.00	1	000580846
50	255	554.00	1	000580850
*55	305	691.00	1	000580855
*60	315	802.00	1	000580860
*65	335	931.00	1	000580865
*70	370	1,123.00	1	000580870
*75	375	1,300.00	1	000580875
*80	400	1,555.00	1	000580880
*85	400	1,830.00	1	000580885
*90	445	2,175.00	1	000580890
*95	445	2,520.00	1	000580895
*100	485	2,910.00	1	000580900
*110	513	3,610.00	1	000580901

58BA-AS

Clé à fourches à frapper antidéflagrante



mm	L mm	A mm	S mm	CHF		
*11/16	125	40,5	11,0	145.00	1	000580904
*3/4	125	40,5	11,0	147.50	1	000580905
*7/8	135	46,2	12,0	151.00	1	000580906
*15/16	150	50,3	12,0	173.00	1	000580907
*31/32	150	50,3	12,0	194.00	1	000580954
*1	175	56,9	15,0	201.00	1	000580908
*1.1/8	190	64,0	15,5	258.00	1	000580909
*1.1/4	190	64,0	15,5	303.00	1	000580910
*1.7/16	210	75,0	18,5	352.00	1	000580912
*1.1/2	220	82,0	18,5	418.00	1	000580913
*1.5/8	230	86,8	18,5	450.00	1	000580914
*1.3/4	250	98,0	20,	569.00	1	000580970

78BA

Clé polygonale contre-coudée antidéflagrante



mm	L mm	CHF		
17	145	137.00	1	000780817
19	145	150.50	1	000780819
22	165	153.00	1	000780822
24	140	187.00	1	000780824
27	155	214.50	1	000780827
30	165	249.00	1	000780830
32	180	270.00	1	000780832
34	192	297.00	1	000780834
36	208	329.00	1	000780836
38	215	386.00	1	000780838
41	225	458.00	1	000780841
46	245	512.00	1	000780846
50	250	594.00	1	000780850

mm	L mm	CHF		
55	265	691.00	1	000780855
60	275	746.00	1	000780860
65	295	802.00	1	000780865
70	310	908.00	1	000780870
75	325	1,019.00	1	000780875
80	340	1,091.00	1	000780880
*85	355	1,385.00	1	000780885
*90	380	1,630.00	1	000780890
*95	390	1,890.00	1	000780895
*100	410	2,155.00	1	000780900
*105	420	2,385.00	1	000780903
*110	445	2,730.00	1	000780901
*120	480	3,220.00	1	000780902

78BA-AS

Clé polygonale à frapper antidéflagrante



"	L mm	CHF		
11/16	145	135.50	1	000780908
3/4	145	140.50	1	000780909
7/8	155	157.50	1	000780935
15/16	165	174.00	1	000780936
*31/32	165	203.50	1	000780937
1	175	203.50	1	000780938
*1.1/16	175	241.00	1	000780939
1.1/8	180	243.50	1	000780940
1.3/16	185	254.00	1	000780941
1.1/4	177	276.00	1	000780910
*1.5/16	200	281.00	1	000780954
*1.3/8	205	294.00	1	000780911
1.7/16	208	366.00	1	000780912
*1.1/2	215	382.00	1	000780913
*1.9/16	225	474.00	1	000780947
*1.11/16	225	500.00	1	000780962
1.5/8	225	464.00	1	000780914
*1.3/4	235	512.00	1	000780963
1.13/16	243	529.00	1	000780916
1.7/8	235	600.00	1	000780915
2	254	624.00	1	000780918
2.3/16	264	729.00	1	000780920
2.3/8	275	795.00	1	000780922
*2.9/16	286	826.00	1	000780924
*2.15/16	311	1,002.00	1	000780926
*3.1/8	325	1,163.00	1	000780928
*3.1/2	355	1,470.00	1	000780930

89BA

Clé polygonale contre-coudée antidéflagrante



mm	L mm	CHF		
10	200	155.50	1	000890810
11	210	161.00	1	000890811
12	220	167.50	1	000890812
13	230	171.50	1	000890813
14	240	174.00	1	000890814
16	260	187.00	1	000890816
17	270	194.00	1	000890817
18	280	209.00	1	000890818
19	300	215.50	1	000890819
20	310	270.00	1	000890820
22	330	270.00	1	000890822
24	350	296.00	1	000890824
27	370	365.00	1	000890827
30	400	408.00	1	000890830
32	420	429.00	1	000890832

90BA

Clé polygonale contre-coudée antidéflagrante



mm	L mm	CHF		
6x7	122	49.50	1	000900801
8x9	128	64.50	1	000900802
10x11	155	72.50	1	000900803
12x13	175	85.00	1	000900806
12X14	180	91.00	1	000900807
14x15	200	102.50	1	000900808
14x17	220	104.00	1	000900809
16x17	230	122.50	1	000900811
16x18	235	122.50	1	000900812
17X19	250	126.50	1	000900814
18x19	265	139.00	1	000900815
19x22	280	146.50	1	000900817
20x22	295	166.00	1	000900818
21x23	298	175.50	1	000900820
22x24	315	212.00	1	000900821
24x26	333	273.00	1	000900822
24x27	340	273.00	1	000900823
30x32	395	402.00	1	000900824
34x36	410	569.00	1	000900826
*36x41	450	770.00	1	000900828
*41x46	470	946.00	1	000900829
*46x50	490	1,050.00	1	000900830

91BA

Clé polygonale contre-coudée antidéflagrante



mm	Ø mm	CHF		
24	38	329.00	1	000910824
27	42	393.00	1	000910827
30	48	450.00	1	000910830
32	49	502.00	1	000910832
36	54	546.00	1	000910836
41	62	611.00	1	000910841
*46	69	811.00	1	000910846
*50	75	867.00	1	000910850
*55	82	1,002.00	1	000910855

92BA

Manche tubulaire pour 91BA, antidéflagrante



	L mm	91BA mm	Ø mm	CHF		
92BA/1	460	24÷30	25	389.00	1	000920810
92BA/2	610	32÷41	28	502.00	1	000920820
*92BA/3	760	46÷55	32	675.00	1	000920830

93BA

Clé à cliquet polygonale pour échafaudages antidéflagrante



mm	L mm	CHF		
21x22	345	811.00	1	000930821

95BA

Clé polygonale double droite, antidéflagrante



mm	L mm	CHF		
7x9	115	49.00	1	000950801
8x10	115	54.50	1	000950802
10x11	140	60.00	1	000950804
10x12	140	71.50	1	000950805
12x14	145	82.00	1	000950806
14x17	165	98.00	1	000950807
*16x18	170	127.00	1	000950809
*17x19	185	111.00	1	000950808
*18x19	185	139.00	1	000950810
*19x22	200	173.00	1	000950812
*21x23	230	191.00	1	000950815
*24x27	255	243.50	1	000950817
*30x32	295	366.00	1	000950820

96BA

Clé mâle 6 pans coudée antidéflagrante



mm	L mm	L1 mm	CHF		
1,5	50	17	101.00	1	000960760
2	50	16	103.00	1	000960762
2,5	56	20	110.50	1	000960761
3	63	21	112.00	1	000960763
4	69	25	118.50	1	000960764
5	78	29	122.50	1	000960765
6	88	33	125.00	1	000960766
7	93	34	131.50	1	000960767
8	97	36	139.00	1	000960768
9	104	37	145.50	1	000960769
10	110	39	150.50	1	000960770
11	118	42	160.00	1	000960771
12	122	44	183.00	1	000960772
14	150	58	204.50	1	000960774
15	156	60	215.50	1	000960775
16	162	63	237.50	1	000960776
17	168	65	249.00	1	000960777
19	177	72	279.00	1	000960779
22	186	77	326.00	1	000960802
24	192	82	377.00	1	000960804

96BA/BP

Clé mâle 6 pans coudée à tête sphérique, antidéflagrante



mm	L mm	L1 mm	CHF		
1,5	50	16	103.50	1	000961800
2	50	16	104.00	1	000961801
2,5	63	20	118.00	1	000961802
3	60	20	118.50	1	000961803
3,5	70	25	123.50	1	000961799
4	66	25	124.00	1	000961804
5	75	28	126.50	1	000961805
6	84	32	130.00	1	000961806
8	92	36	142.00	1	000961808
10	102	40	153.00	1	000961810
12	113	45	189.00	1	000961812

96BAF-AS

Clé mâle 6 pans coudée, antidéflagrante



mm	L mm	L1 mm	CHF		
*1/16	59	25	82.00	1	000962831
*5/64	59	25	84.50	1	000962832
*3/32	59	25	88.00	1	000962833
*7/64	59	25	91.50	1	000962834
*1/8	59	25	95.50	1	000962835
*9/64	64	29	103.00	1	000962836
*5/32	65	30	106.00	1	000962837
*3/16	79	31	112.00	1	000962838
*7/32	85	37	117.00	1	000962839
*1/4	85	37	122.50	1	000962840
9/32	88	38	126.50	1	000962841
*5/16	92	44	132.00	1	000962842
11/32	100	44	135.50	1	000962843
*3/8	110	45	144.00	1	000962844
*7/16	119	48	153.00	1	000962845
*1/2	140	55	187.00	1	000962846
*9/16	150	58	214.50	1	000962847

99BA

Clé à ergot pour écrous à encoches latérales antidéflagrante



mm	A mm	CHF		
32-75	4,0	266.00	1	000990803
50-120	4,5	418.00	1	000990805
115-170	4,5	675.00	1	000990811

110BA

Clé à molette à ouverture graduée antidéflagrante



L mm	A max	CHF		
100	13	197.00	1	001100810
150	18	226.50	1	001100815
200	24	266.00	1	001100820
250	30	321.00	1	001100825
300	36	451.00	1	001100830
375	46	608.00	1	001100837
*450	55	851.00	1	001100845
*600	65	1,420.00	1	001100860

330BA

Coupe-tubes antidéflagrant



mm	Ø max	L mm	CHF		
330BA/2	50 mm	375	1,035.00	1	003300802

330BA/2R

Couteau et goupille de rechange pour 330BA pour tuyaux de gaz, antidéflagrant



CHF		
330BA /2-R	104.00	1 003300822

363BA

Clé serre-tubes modèle américain antidéflagrante



L mm	Ø max	Ø max mm	CHF		
150	1/2" gas	20	336.00	1	003630815
200	1" gas	30	337.00	1	003630820
250	1 1/2" gas	49	393.00	1	003630825
300	2" gas	60	500.00	1	003630830
350	2" gas	60	618.00	1	003630835
450	2 1/2" gas	76	937.00	1	003630845
600	3" gas	90	1,305.00	1	003630860

378BA

Clé serre-tubes modèle suédois antidéflagrante, Cuivre/Béryllium



L mm	Ø max "	CHF		
430	1" 1/2 gas	1,022.00	1	003780800
530	2" gas	1,260.00	1	003780801

386BA

Clé serre-tubes réversible à chaîne, gros effort, antidéflagrante

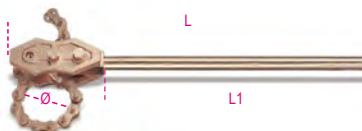

L mm	Ø max mm	L1 mm	CHF		
600	100	470	1,545.00	1	003860806
900	200	750	2,560.00	1	003860809

911BA

douille 12 pans antidéflagrante

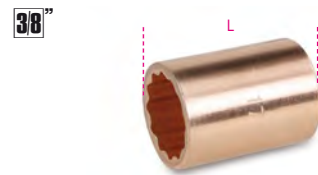

mm	L mm	CHF		
6	28	68.00	1	009110806
7	28	72.50	1	009110807
8	28	78.00	1	009110808
9	28	83.00	1	009110809
10	32	113.00	1	009110810
11	32	119.00	1	009110811
12	32	126.00	1	009110812
13	32	131.50	1	009110813
14	32	139.50	1	009110814
15	32	140.50	1	009110815
16	32	147.50	1	009110816
17	32	153.00	1	009110817
18	32	155.50	1	009110818
19	32 32	161.00	1	009110819

911BA/16

Augmentateur carré femelle 3/8" et mâle 1/2", antidéflagrant

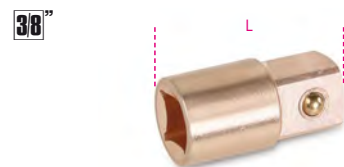

L mm	CHF		
34	144.00	1	009110836

911BA/20

Rallonge carrés mâle et femelle 3/8", antidéflagrant



L mm	CHF		
75	116.00	1	009110840

911BA/55

Cliquet à glissière, carré mâle 3/8", antidéflagrant

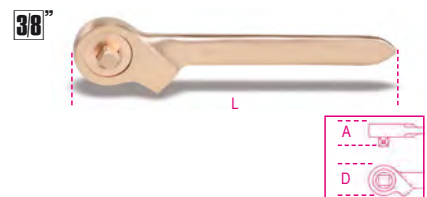

L mm	D mm	A mm	CHF		
200	45	16.5	246.50	1	009110882



921BA

Douille 12 pans antidéflagrante

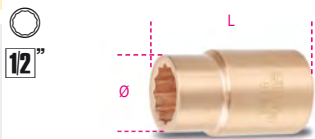

mm	Ø mm	L mm	CHF	1	2
8	15,0	40	102.50	1	009210808
9	16,0	40	108.00	1	009210809
10	17,5	40	123.50	1	009210810
11	18,0	40	127.00	1	009210811
12	18,5	40	135.50	1	009210812
13	20,0	40	144.00	1	009210813
14	21,0	40	146.50	1	009210814
15	21,5	40	152.00	1	009210815
16	24,0	40	157.00	1	009210816
17	25,0	40	162.50	1	009210817
18	25,0	40	169.00	1	009210818
19	28,0	42	174.00	1	009210819
20	29,0	42	183.00	1	009210820
21	30,0	43	186.00	1	009210821
22	30,5	43	194.00	1	009210822
24	34,0	43	227.50	1	009210824
25	36,0	43	246.50	1	009210825
26	37,5	43	263.00	1	009210826
27	37,5	45	276.00	1	009210827
28	38,9	46	288.00	1	009210828
30	41,5	46	325.00	1	009210830
32	43,5	46	358.00	1	009210832

921BA-AS

Douille 12 pans antidéflagrante

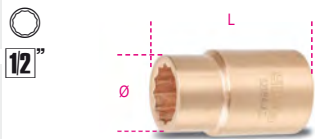

mm	Ø mm	L mm	CHF	1	2
5/16	24,0	40	109.00	1	009210958
3/8	24,0	40	118.00	1	009210960
7/16	24,0	40	128.50	1	009210961
1/2	24,0	40	137.00	1	009210963
9/16	24,0	40	144.00	1	009210964
5/8	25,0	40	162.50	1	009210966
11/16	25,5	40	175.50	1	009210967
3/4	28,0	42	194.00	1	009210969
13/16	30,0	43	204.50	1	009210971
7/8	31,5	43	224.00	1	009210972
15/16	34,0	43	236.00	1	009210974
1	36,0	43	263.00	1	009210975
1.1/16	38,0	46	283.00	1	009210977
1.1/4	42,0	46	377.00	1	009210982
1.7/16	50,5	50	464.00	1	009210986

921BA/15

Augmentateur carré femelle 1/2" et mâle 3/8", antidéflagrant



L mm	□	■	CHF	1	2
34	1/2	3/8	129.50	1	009210839

921BA/16

adaptateur antidéflagrant, 1/2 » femelle et 3/4 » mâle

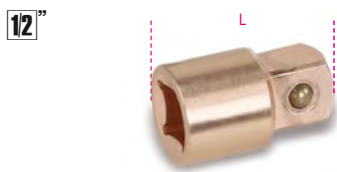

L mm	□	■	CHF	1	2
34	1/2	3/4	170.50	1	009210840

921BA/21 - 921BA/22

Rallonge carrés mâle et femelle 1/2", antidéflagrante



	L mm	Ø mm	CHF	1	2
921BA/21	125	30	173.00	1	009210842
921BA/22	250	31	241.00	1	009210844

921BA/25

Cardan carrés mâle et femelle 1/2", antidéflagrant



L mm	Ø mm	□	■	CHF	1	2
80	25	1/2	1/2	175.50	1	009210845

921BA/42

Poignée coulissante carré mâle 1/2", antidéflagrante



L mm	CHF	1	2
250	285.00	1	009210846

921BA/50

Cliquet antidéflagrant



L mm	D mm	A mm	CHF	1	2
250	45	16,5	329.00	1	009210850

921BA/R50

Set de rechange antidéflagrant



1/2"	CHF	1	2
	98.00	1	009210851

926BA

Douille 12 pans antidéflagrante

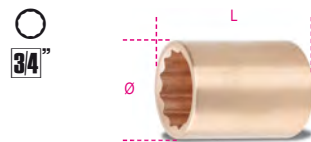

mm	Ø mm	L mm	CHF	1	2
22	40	55	214.50	1	009260822
24	40	55	240.00	1	009260824
26	40	55	273.00	1	009260826
27	40	55	288.00	1	009260827
28	41	55	337.00	1	009260828
30	43	60	345.00	1	009260830
32	45	60	386.00	1	009260832
34	48	60	409.00	1	009260834
36	50	60	444.00	1	009260836
38	53	60	474.00	1	009260838
41	57	65	520.00	1	009260841
46	63	65	618.00	1	009260846
50	68	70	677.00	1	009260850

926BA/15

adaptateur antidéflagrant, 3/4 » femelle et 1/2 » mâle



L mm	□	■	CHF	1	2
55	3/4	1/2	170.50	1	009260861

926BA/22

Rallonge carrés mâle et femelle 3/4", antidéflagrante



	L mm	Ø mm	CHF	1	2
926BA/22	200	38	345.00	1	009260872

926BA/42

Poignée coulissante carré mâle 3/4", antidéflagrante



L mm	CHF	1	2
400	500.00	1	009260876

926BA/50

Cliquet réversible à glissière carré mâle 3/4", antidéflagrant



L mm	D mm	A mm	CHF	1	009260880
300	61	22	512.00	1	009260880

926BA/R50

Set de rechange antidéflagrant



3/4"	CHF	1	009260881
3/4"	162.50	1	009260881

937BA

Clé à pipe débouchée 6 pans antidéflagrante



mm	L mm	A mm	CHF	1	009370813
13	240	45	127.00	1	009370813
17	260	51	184.00	1	009370817
19	270	55	193.00	1	009370819
22	278	59	252.00	1	009370822
24	286	63	270.00	1	009370824
27	294	69	286.00	1	009370827
30	302	75	316.00	1	009370830
32	310	81	345.00	1	009370832
*36	330	85	405.00	1	009370836
*41	350	90	490.00	1	009370841

951BA

Clé mâle 6 pans en T, antidéflagrante



mm	L mm	L1 mm	CHF	1	009510904
4	100	90	214.50	1	009510904
5	100	90	225.00	1	009510905
6	100	90	237.50	1	009510906

961BA

Dérouiller à levier antidéflagrant



L mm	A mm	CHF	1	009610802
250	39	189.00	1	009610802
350	55	285.00	1	009610806

963BA

Pince levier à broche et palette, antidéflagrante



L mm	A mm	CHF	1	009630801
500	24	528.00	1	009630801
*800	24	828.00	1	009630803
*1000	30	1,755.00	1	009630805

964BA

Clé à bonde antidéflagrante



L mm	CHF	1	009640801
385	500.00	1	009640801

964BA/L

Cisaille universelle pour fûts, antidéflagrante
Pour l'ouverture des fûts en métal avec bord



*964BA/L	L mm	CHF	1	009640821
*964BA/L	510	2,520.00	1	009640821

965BA

Clé de serrage simple antidéflagrante pour soupapes de sûreté



A mm	A1 mm	L mm	CHF	1	009650830
30	44	200	219.00	1	009650830
32	50	300	306.00	1	009650832
35	47	250	249.00	1	009650835
40	50	300	286.00	1	009650840
45	58	350	370.00	1	009650845
48	62	375	386.00	1	009650848
50	67	400	423.00	1	009650850

A mm	A1 mm	L mm	CHF	1	009650855
55	73	450	506.00	1	009650855
60	79	500	546.00	1	009650860
*65	82	550	611.00	1	009650865
*70	85	600	675.00	1	009650870

966BA

Clé de serrage antidéflagrante pour soupapes de sûreté

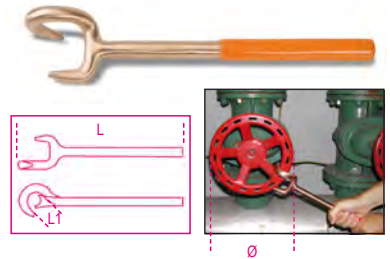

L mm	L1 mm	Ø min+max mm	CHF	1	009660801
350	40	50÷150	479.00	1	009660801

966BA/V

Clé de serrage antidéflagrante pour soupapes de sûreté

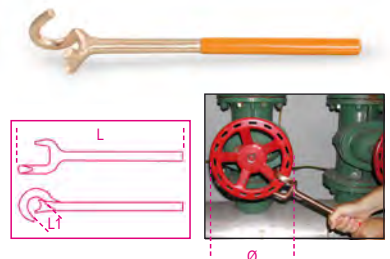

L mm	L1 mm	Ø min+max mm	CHF	1	009660812
370	36	125÷250	479.00	1	009660812
430	48	250÷400	691.00	1	009660814

1032BA

Pince pour circlips intérieurs à becs droits antidéflagrante, branches recouvertes en PVC



L mm	Ø mm	CHF	1	010320820
200	40÷100	312.00	1	010320820

1036BA

Pince pour circlips extérieurs à becs droits antidéflagrante, branches recouvertes en PVC

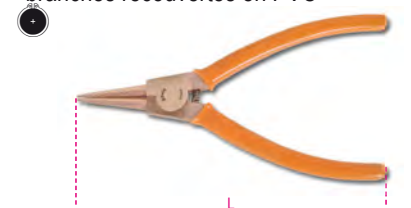

L mm	Ø mm	CHF	1	010360820
200	40÷100	312.00	1	010360820

1046BA

Pince multiprise à crémaillère, antidéflagrante



L mm	A max mm	CHF	Icon	Icon
250	32	408.00	1	010460801
★300	52	538.00	1	010460803

1052BA

Pince-étau universelle à mâchoires concaves, antidéflagrante

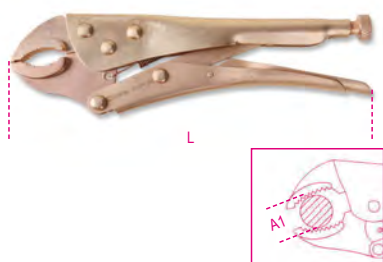

L mm	A1 max mm	CHF	Icon	Icon
225	40,0	402.00	1	010520824

1082BA

Pince coupante diagonale antidéflagrante

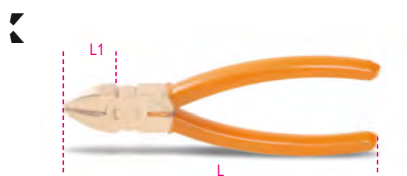

L mm	L1 mm	CHF	Icon	Icon
160	22	292.00	1	010820801

1100BA

Coupe-boulons, antidéflagrant



L mm	CHF	Icon	Icon
600	2,090.00	1	011000860

1137BA

Pince d'artificier



L mm	L1 mm	CHF	Icon	Icon
185	30	543.00	1	011370801

1137BA/RC

Lame pour 1137BA



1137BA/RC	CHF	Icon	Icon
	104.00	1	011370851

1150BA

Pince universelle chromée satinée antidéflagrante



L mm	L1 mm	CHF	Icon	Icon
200	40	343.00	1	011500820

1162BA

Pince à becs plats longs striés antidéflagrante



L mm	L1 mm	CHF	Icon	Icon
150	54	270.00	1	011620815

1166BA

Pince à becs demi-ronds longs striés branches antidéflagrante



L mm	L1 mm	CHF	Icon	Icon
150	54	270.00	1	011660815

1270BA

Tournevis pour vis à fente à lame antidéflagrante



AxL mm	L1 mm	CHF	Icon	Icon
3x75	178	49.00	1	012700803
4x100	209	60.00	1	012700804
5x150	250	80.50	1	012700805
6x150	270	85.00	1	012700806
10x250	382	129.50	1	012700810
8x200	312	96.50	1	012700808

1272BA

Tournevis pour vis Phillips® à lame antidéflagrante



PHxDxL mm	L1 mm	CHF	Icon	Icon
1x5x100	209	67.50	1	012720801
2x6x150	270	86.00	1	012720802
3x8x200	332	103.50	1	012720803

1277BA

Tournevis pour vis Torx(R), antidéflagrant



Ø	L mm	L1 mm	Ø mm	CHF	Icon	Icon
T10	75	184	5	64.50	1	012770810
T15	75	184	5	69.50	1	012770815
T20	100	209	6	94.00	1	012770820
T25	125	209	6	99.00	1	012770825
T30	150	270	6	109.00	1	012770830
T40	200	332	8	145.00	1	012770840

1370BA

Marteau de mécanicien antidéflagrant, manche en bois



g	A mm	L mm	L1 mm	CHF	Icon	Icon
500	30	310	108	180.50	1	013700805
1000	35	340	137	317.00	1	013700810

1370BA/MR

Manche pour 1370BA

	CHF		
1370BA/MR 500	30.50	1	013700865
1370BA/500			
1370BA/MR 1000	37.00	1	013700870
1370BA/1000			

1370BA/PL

Marteau de mécanicien antidéflagrant, manche en fibre



g	A mm	L mm	L1 mm	CHF		
500	30	310	108	180.50	1	013700815
1000	35	340	137	317.00	1	013700820

1375BA/PL

Marteau de charpentier antidéflagrant, manche en fibre



g	L mm	L1 mm	Ø mm	CHF		
680	321	125	30	232.00	1	013750800

1377BA

Marteau américain antidéflagrant



g	L1 mm	L mm	CHF		
340	90	280	116.00	1	013770834

1377BA/PL

Marteau américain, manche en fibre, antidéflagrant



g	L1 mm	L mm	CHF		
340	90	280	116.00	1	013770884

1379BA

Marteau à piquer antidéflagrant, manche en bois



g	L1 mm	L mm	CHF		
500	142	315	225.00	1	013790850

1380BA

Massette antidéflagrante, manche en bois



g	L1 mm	L mm	CHF		
1000	100	400	389.00	1	013800810
1500	118	400	474.00	1	013800815
2000	126	400	624.00	1	013800820

1380BA/MR

Manche pour 1380BA

	CHF		
1380BA/MR 1000	39.50	1	013800860
1380BA/1000			
1380BA/MR 1500	39.50	1	013800865
1380BA/1500			
1380BA/MR 2000	39.50	1	013800870
1380BA/2000			

1380BA/PL

Massette antidéflagrante, manche en fibre



g	L1 mm	L mm	CHF		
500	80	310	194.00	1	013800955
1000	94	350	362.00	1	013800960
1500	115	400	520.00	1	013800965
2000	125,5	400	681.00	1	013800970

1381BA

Masse antidéflagrante, manche en bois



g	L1 mm	L mm	CHF		
5000	179	900	1,455.00	1	013810850
*8000	190	900	2,325.00	1	013810858

1381BA/MR

Manche pour 1381BA

	CHF		
1381BA/MR 5000	60.00	1	013810870
1381BA/5000			
*1381BA/MR 8000	70.00	1	013810878
1381BA/8000			

1381BA/PL

Masse antidéflagrante, manche en fibre



g	L1 mm	L mm	CHF		
5000	172	900	1,330.00	1	013810885
8000	204	900	2,385.00	1	013810888

1390BA

Maillet à embouts nylon antidéflagrant



Ø mm	L mm	L1 mm	CHF		
*52	370	130	312.00	1	013900805

1390BA/R

Embout en nylon pour 1390BA



D mm	CHF		
52	63.00	4	013900885



1602BA

Pince à cosses préisolées, série légère, antidéflagrante



mm ²	L mm	CHF		
0.75+6	200	384.00	1	016020801

1701BA

Ciseau hexagonal antidéflagrante



L mm	A mm	S mm	CHF		
150	12	10	70.50	1	017010810
200	16	14	113.00	1	017010814
250	18	14	139.00	1	017010815
350	19	17	366.00	1	017010817

1703BA/A

Hache antidéflagrante



L mm	L1 mm	A mm	CHF		
340	145	82	317.00	1	017030082

1703BA/P

Pic antidéflagrante



A mm	L mm	L1 mm	CHF		
56	1050	410	830.00	1	017030150

1703BA/PL

Pelle antidéflagrante



A mm	L1 mm	L mm	CHF		
240	420	990	699.00	1	017030200

1717BA

Grattoir rigide antidéflagrante



A mm	CHF		
60	170.50	1	017170801
80	189.00	1	017170803

1717BA/1

Grattoir tranchant antidéflagrante



A mm	L mm	CHF		
100	220	341.00	1	017170805

1719BA8

Lime de 8" antidéflagrante



	L mm	CHF		
1719BA8/P	200	209.00	1	017190801
1719BA8/M	200	215.50	1	017190805
1719BA8/R	200	220.50	1	017190810
1719BA8/T	200	203.50	1	017190815
1719BA8/Q	200	203.50	1	017190820

1719BA12

Lime de 12" antidéflagrante



1719BA12/P	L mm	CHF		
	300	377.00	1	017190831

1727BA

Monture de scie à métaux avec lame antidéflagrante



L mm	L1 mm	CHF		
500	300	666.00	1	017270801

1728BA

Lame de scie antidéflagrante
Cuivre/Béryllium



L mm	CHF		
300	129.00	1	017280801

1737BA

Brosse antidéflagrante



L mm	A mm	CHF		
294	29	86.00	1	017370801

1758BA

Entonnoir antidéflagrante



Ø mm	H mm	CHF		
160	150	120.00	1	017580815

1776BA

Couteau antidéflagrante



L1 mm	L mm	CHF		
145	250	187.00	1	017760801

1784BA

Ciseaux antidéflagrants



L mm	CHF		
225	325.00	1	017840822





OUTILLAGE ELECTROPORTATIF

Des outils de travail fiables et durables sont capables de satisfaire les exigences de tous les professionnels.

La famille d'outils électroportatifs Beta comprend

OUTILS SUR BATTERIE

OUTILS FILAIRES

Beta
POWERTOOLS

OUTILLAGE SUR BATTERIE

Beta
3-YEAR
WARRANTY



La nouvelle gamme d'outils sur batterie comprend des machines hautes performances en 12V et en 20V.

La gamme 12V comprend la perceuse à percussion et la visseuse à chocs avec mandrin, des outils indispensables conçus pour faciliter le travail quotidien et basés sur la performance, la légèreté et la compacité.

Tandis que la gamme **20 V** comprend des outils sur batterie proposant de **hautes performances, et alliant qualité et durabilité.**

Chez Beta, nous nous sommes appuyés sur ces caractéristiques pour développer une gamme complète d'outils sur batterie, allant de la perceuse à percussion à la clé à chocs avec entraînement carré de 1/2" avec un couple élevé.

Tous les nouveaux outils électriques de Beta sont équipés de moteurs sans charbon de mécanismes intérieurs de première qualité, permettant des performances et une longévité considérablement améliorées de l'outil.

La clé à chocs avec un couple de dévissage maximum de 1200 Nm est l'un des outils électroportatif phare de cette nouvelle gamme, et en fait le partenaire de travail idéal pour tous ceux qui ont besoin d'une puissance et de performances optimales.

Nos batteries lithium-ion 20V sont disponibles avec des capacités allant jusqu'à 6Ah et peuvent être utilisées sur tous les outils sans fils de la gamme.



Scanner le code QR pour plus d'informations sur l'extension de garantie gratuite de 3 ans.

1972/K12V-10

Perceuse visseuse ultra compacte 12V

- Ultra compacte : seulement 170 mm de longueur ; ultra légère : seulement 1,1 kg avec batterie et parfaitement équilibrée
- Double vitesse mécanique avec engrenages en acier et embrayage à 20 positions
- Couple jusqu'à 30 Nm et 1300 tours/min (400 tours/min en 1ère vitesse) ; perce des diamètres jusqu'à 10 mm dans l'acier et 20 mm dans le bois
- Batteries de 2Ah et indicateur de charge sur le corps de la machine
- Poignée ergonomique antidérapante
- LED frontale
- Mandrin autoserrant de 10 mm
- Clip pour ceinture droite/gauche
- Sélecteur vissage-dévisage-blocage (pour le transport)
- Fournie dans un coffret rigide avec 2 batteries au lithium-ion de 2 Ah et chargeur rapide (50 min)



CE

1972/K12V-10 CHF 326.00 1 019720112

316x254x96 mm - 1,1 kg

1982/K12V

Visseuse à chocs réversible à percussion 12V idéale pour les espaces restreints, exerce un couple élevé de 80 Nm et peut être utilisée d'une seule main

- Ultra compacte : seulement 160 mm de longueur ; ultra légère : seulement 1 kg avec batterie et parfaitement équilibrée
- Entraînement hexagonal de 1/4" avec douille de blocage
- Clip pour ceinture droite/gauche
- LED frontale
- Sélecteur vissage-dévisage-blocage (pour le transport)
- Poignée ergonomique antidérapante
- Boîte d'engrenages entièrement métallique
- Batteries de 2Ah et indicateur de charge sur le corps de la machine
- Fournie dans un coffret rigide avec 2 batteries au lithium-ion de 2 Ah et chargeur rapide (50 min)



CE

1982/K12V CHF 326.00 1 019820112

316x254x96 mm - 1,1 kg

1972/K12V-COMBO

Kit 12V perceuse visseuse ultra compacte + clé à chocs à percussion 1/4" HEX (12V)

Contenu du coffret :

- 1 perceuse visseuse ultra compacte 12V, avec mandrin autoserrant de 10 mm
- 1 clé à chocs réversible à percussion 12V, avec entraînement hexagonal de 1/4"
- 2 batteries au lithium-ion de 2 Ah
- 1 chargeur rapide



CE

1972/K12V-COMBO CHF 554.00 1 019720010

310x295x100 mm - 3 kg

1972/12V-10

Perceuse ultracompacte, 12V (corps de la machine, fourni sans batterie)

CE

- Ultracompacte : seulement 170 mm de longueur. Ultralégère et parfaitement équilibrée : seulement 1,1 kg avec batterie
- Mandrin métallique automatique de 10 mm
- Couple jusqu'à 30 Nm et 1300 tr/min (400 tr/min en 1ère vitesse) ; perce des diamètres jusqu'à 10 mm dans l'acier et 20 mm dans le bois
- Sélecteur double vitesse mécanique avec engrenages en acier (0-400/1300 tr/min)
- Réglage du couple possible sur 20 positions
- Sélecteur vissage-dévisage-verrouillage (pour le transport)
- LED frontale
- Poignée ergonomique antidérapante
- Clip ceinture (positionnable côté droit ou gauche)

📏 790 g

1972/12V-10

CHF 135.00 1 019720113

Beta
3-YEAR
WARRANTY



1982/12V

Visseuse à chocs réversible, 12V (corps de la machine fourni sans batterie)

CE

Idéal pour travailler dans les espaces exigus, elle développe un couple élevé de 80 Nm et est conçue pour une utilisation d'une seule main

- Ultracompacte : seulement 160 mm de longueur. Ultralégère et parfaitement équilibrée / seulement 1 kg avec batterie
- Entraînement hexagonal de 1/4" avec douille de blocage
- Clip ceinture (positionnable côté droit ou gauche)
- LED frontale
- Sélecteur vissage-dévisage-verrouillage (pour le transport)
- Poignée ergonomique antidérapante
- Carter d'engrenage entièrement métallique

📏 800 g

1982/12V

CHF 144.00 1 019820113

Beta
3-YEAR
WARRANTY



1994BL 12V-2AH

Batterie lithium-ion 2 Ah pour outils BETA 12 V

CE

Caractéristiques principales

- Tension de la batterie : 12 V
- Capacité de la batterie : 2 Ah
- Capacité énergétique : 24Wh
- Type de batterie : Li-ion

📏 170 g

1994BL 12V-2AH

CHF 60.50 1 019940015



1994CB 12V

Chargeur de batterie rapide, 12V, 110V-240V

CE

Caractéristiques principales:

- Indicateur de niveau de charge LED
- Tension d'entrée nominale : 110 V-240 V ~ 50/60 Hz
- Tension de sortie : 12,6 V
- Courant de charge : 2 A
- Puissance d'entrée nominale : 35 W
- Temps de charge de la batterie 2 Ah : 50 min

📏 260 g

1994CB 12V

CHF 60.50 1 019940123



1972/K20V-13BMC

Coffret perceuse à percussion Brushless 20V

• Moteur brushless aux performances considérablement améliorées : puissance accrue, consommation d'énergie réduite, durée de vie du moteur prolongée, commande électrique améliorée grâce à son bouton.

- 3 modes de fonctionnement : perçage, vissage et perçage à percussion
- Compact : seulement 210 mm de longueur
- Poignée ergonomique antidérapante
- Sélecteur vissage-dévisage-verrouillage (pour le transport)
- Carter d'engrenage entièrement métallique
- Éclairage LED intégré afin de travailler dans des conditions optimales
- Clip de ceinture (positionnable côté droit ou gauche)
- Poignée latérale supplémentaire lors d'une utilisation à couple élevé
- Livrée dans un coffret rigide avec 2 batteries lithium-ion (4 Ah) et 1 chargeur rapide

Caractéristiques principales:

- Couple Maximal : 80 Nm
- Réglage du couple sur 20 positions
- Mandrin automatique métallique de 13 mm
- Double vitesse mécanique avec engrenages en acier (0-450/1650 tr/min)
- Diamètre maximal de perçage dans le bois : 55 mm
- Diamètre maximal de perçage dans le métal : 13 mm
- Diamètre maximal de perçage dans le béton : 13 mm

Beta
**3-YEAR
WARRANTY**

DISPONIBLE
À PARTIR DE MAI



CHF 708.00 1 019720020

1972/K20V-13BMC

490x370x125 mm - 5,5 kg

1972/20V-13BMC

Perceuse à percussion, Brushless 20V (corps de la machine fourni sans batterie)

• Moteur brushless aux performances considérablement améliorées : puissance accrue, consommation d'énergie réduite, durée de vie du moteur prolongée, commande électrique améliorée grâce à son bouton.

- 3 modes de fonctionnement : perçage, vissage et perçage à percussion
- Compact : seulement 210 mm de longueur
- Poignée ergonomique antidérapante
- Sélecteur vissage-dévisage-verrouillage (pour le transport)
- Carter d'engrenage entièrement métallique
- Éclairage LED intégré afin de travailler dans des conditions optimales
- Clip de ceinture (positionnable côté droit ou gauche)
- Poignée latérale supplémentaire lors d'une utilisation à couple élevé
- Livrée dans un coffret rigide, sans batterie ni chargeur

Caractéristiques principales:

- Couple Maximal : 80 Nm
- Réglage du couple sur 20 positions
- Mandrin automatique métallique de 13 mm
- Double vitesse mécanique avec engrenages en acier (0-450/1650 tr/min)
- Diamètre maximal de perçage dans le bois : 55 mm
- Diamètre maximal de perçage dans le métal : 13 mm
- Diamètre maximal de perçage dans le béton : 13 mm

Beta
**3-YEAR
WARRANTY**

DISPONIBLE
À PARTIR DE MAI



CHF 291.00 1 019720019

1972/20V-13BMC

490x370x125 mm - 3,6 kg

1984/K600

Clé à chocs réversible à percussion 20V brushless avec coupler 1/2" - 600 Nm

- Moteur digital sans broches (brushless)
Considérable augmentation des prestations dont : puissance supérieure, consommations d'énergie réduite, vie utile du moteur supérieure, meilleur dosage de la puissance par le biais de la touche
- Boîte d'engrenages entièrement métallique
- Poignée ergonomique antidérapante
- Carré mâle de 1/2" avec anneau de retenue de la douille
- Réversible
- Rotation droite/gauche avec bouton de sécurité (pour le transport)
- Lumière LED intégrée pour fonctionner même dans des conditions de mauvaise visibilité
- Indicateur LED du niveau de charge de la batterie
- Clip de ceinture droite/gauche

Serrage

Choix entre 3 réglages différents de couple et de nombre de tours (faible - moyen - élevé) :

- 1 : 200 Nm ; 1000 RPM
- 2 : 350 Nm ; 1500 RPM
- 3 : 550 Nm ; 1800 RPM

Desserrage

- 1 : 600 Nm : la clé à chocs applique le couple maximal en continu (dévisage libre)
- 2 : 600 Nm - Arrêt automatique : la clé à chocs applique le couple maximal jusqu'au dévisage complet de l'écrou puis s'arrête automatiquement (dévisage mono-impulsion)

Livrée dans un étui rigide pratique avec 2 batteries lithium-ion (4 Ah) et un chargeur rapide.

DISPONIBLE
À PARTIR DE MAI

Beta
**3-YEAR
WARRANTY**



1984/K600

CHF

816.00



1



019840060

490x370x125 mm - 6,3 kg

1984 20V/600BMC

Clé à chocs réversible Brushless 20V, avec entraînement 1/2" - 600 Nm (corps de la machine fourni sans batterie)

- 3 réglages de couple différents en mode vissage
- Jusqu'à 600 Nm de couple en mode dévissage
- Moteur Brushless aux performances considérablement améliorées : puissance accrue, consommation d'énergie réduite, durée de vie du moteur prolongée, commande électrique améliorée à partir du bouton
- Carré mâle 1/2" avec bague de retenue de douille
- Carter d'engrenage entièrement en métal
- Poignée ergonomique antidérapante
- Sélecteur modes vissage-dévisage-verrouillage (pour le transport)
- Éclairage LED intégré pour travailler dans des conditions de mauvaise visibilité
- Clip de ceinture (positionnable côté droit ou gauche)
- Livrée dans un coffret rigide, sans piles ni chargeur

Couples

3 réglages de couple (faible - moyen - fort) disponibles :

- 1 : 200 Nm ; 1000 tr/min
- 2 : 350 Nm ; 1500 tr/min
- 3 : 550 Nm ; 1800 tr/min

Desserrage

- 1 : 600 Nm : la clé à chocs applique le couple maximum sans arrêt (dévisage libre)
- 2 : 600 Nm - Autostop : la clé à chocs applique le couple maximum jusqu'au dévissage complet de l'écrou, puis s'arrête automatiquement (dévisage en un seul coup)

DISPONIBLE
À PARTIR DE MAI

Beta
**3-YEAR
WARRANTY**

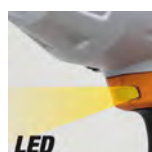
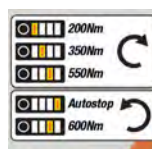

1984 20V/600BMC

CHF

399.00



1



019840907

490x370x125 mm - 4,4 kg

1984/K1200

Clé à chocs réversible à percussion 20V brushless avec coupler 1/2" - 1000 Nm

CE

- Moteur digital sans broches (brushless)
Considérable augmentation des prestations dont : puissance supérieure, consommations d'énergie réduite, vie utile du moteur supérieure, meilleur dosage de la puissance par le biais de la touche
- Boîte d'engrenages entièrement métallique
- Poignée ergonomique antidérapante
- Carré mâle de 1/2" avec anneau de retenue de la douille
- Réversible
- Rotation droite/gauche avec bouton de sécurité (pour le transport)
- Lumière LED intégrée pour fonctionner même dans des conditions de mauvaise visibilité
- Indicateur LED du niveau de charge de la batterie
- Clip de ceinture droite/gauche

Serrage

Choix entre 3 réglages différents de couple et de nombre de tours (faible - moyen - élevé) :

- 1 : 300 Nm ; 900 RPM
- 2 : 500 Nm ; 1600 RPM
- 3 : 680 Nm ; 1900 RPM

Desserrage

- 1 : 1000 Nm : la clé à chocs applique le couple maximal en continu (dévissage libre)
- 2 : 1000 Nm - Arrêt automatique : la clé à chocs applique le couple maximal jusqu'au dévissage complet de l'écrou puis s'arrête automatiquement (dévissage mono-impulsion)

Livrée dans un étui rigide pratique avec 2 batteries lithium-ion (6 Ah) et un chargeur rapide.

DISPONIBLE
À PARTIR DE MAI

Beta
**3-YEAR
WARRANTY**



CHF 986.00 1 019840120

490x370x125 mm - 7 kg

1984 20V/1200BMC

Clé à chocs Brushless réversible, 20V avec entraînement 1/2" - 1200 Nm (corps de la machine fourni sans batterie)

CE

Idéale pour les applications nécessitant un couple élevé.

- 3 réglages de couple différents en mode vissage
- Jusqu'à 1 200 Nm de couple en position dévissage
- Jusqu'à 1 700 Nm de couple maximal en position vissage
- Moteur Brushless aux performances considérablement améliorées : puissance accrue, consommation d'énergie réduite, durée de vie du moteur prolongée, commande électrique améliorée grâce à son bouton
- Carré mâle 1/2" avec bague de retenue de douille
- Carter d'engrenage entièrement métallique
- Poignée ergonomique antidérapante
- Sélecteur vissage-dévissage-verrouillage (pour le transport)
- Éclairage LED intégré pour de travailler dans des conditions optimales
- Clip de ceinture (positionnable côté droit ou gauche)
- Livrée dans un coffret rigide, sans batterie ni chargeur

Couples

3 réglages de couple (faible - moyen - fort) disponibles :

- 1 : 350 Nm ; 800 tr/min
- 2 : 600 Nm ; 1400 tr/min
- 3 : 900 Nm ; 1600 tr/min

Desserrage

- 1 : 1200 Nm : la clé à chocs applique le couple maximum sans arrêt (dévissage libre)
- 2 : 1200 Nm - Autostop : la clé à chocs applique le couple maximum jusqu'au dévissage complet de l'écrou, puis s'arrête automatiquement (dévissage en un seul coup)

DISPONIBLE
À PARTIR DE MAI

Beta
**3-YEAR
WARRANTY**

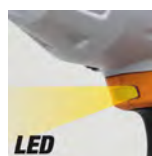
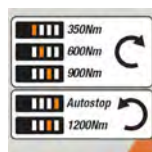

CHF 465.00 1 019840911

490x370x125 mm - 4,7 kg

1986/K20V-125

Coffret meuleuse d'angle, Brushless 20V

Moteur Brushless aux performances considérablement améliorées : puissance accrue, consommation d'énergie réduite, durée de vie du moteur prolongée, commande électrique améliorée à partir du bouton

Caractéristiques principales

- Protection contre le redémarrage accidentel
- Poignée supplémentaire qui peut être positionnée des deux côtés
- Carter de protection manipulable sans outils (libération rapide)
- Dispositif de verrouillage de broche pour des changements de disque rapides
- Interrupteur coulissant marche/arrêt de verrouillage
- Ailettes d'aération protégées contre les infiltrations de poussières tout en assurant un refroidissement optimal
- Livrée dans un coffret rigide, avec 2 batteries lithium-ion (4 Ah) et 1 chargeur rapide

Données techniques

- Diamètre du disque (non inclus) : 125/115 mm
- Vitesse à vide : 8 000 tr/min
- Filetage de l'axe de la meuleuse : M14
- Longueur du câble anti-enchevêtrement : 4 m

Beta
**3-YEAR
WARRANTY**

DISPONIBLE
À PARTIR DE MAI



CE

1986/K20V-125

CHF 708.00 1 019860015

490x370x125 mm - 5,6 kg

1986/20V-125BMC

Meuleuse d'angle, Brushless 20V (corps de la machine fourni sans batterie)

Moteur Brushless aux performances considérablement améliorées : puissance accrue, consommation d'énergie réduite, durée de vie du moteur prolongée, commande électrique améliorée à partir du bouton

Caractéristiques principales

- Protection contre le redémarrage accidentel
- Poignée supplémentaire qui peut être positionnée des deux côtés
- Carter de protection manipulable sans outils (libération rapide)
- Dispositif de verrouillage de broche pour des changements de disque rapides
- Interrupteur coulissant marche/arrêt de verrouillage
- Ailettes d'aération protégées contre les infiltrations de poussières tout en assurant un refroidissement optimal
- Livrée dans un coffret rigide, sans batterie ni chargeur

Données techniques

- Diamètre du disque (non inclus) : 125/115 mm
- Vitesse à vide : 8 000 tr/min
- Filetage de l'axe de la meuleuse : M14
- Longueur du câble anti-enchevêtrement : 4 m

Beta
**3-YEAR
WARRANTY**

DISPONIBLE
À PARTIR DE MAI



CE

1986/20V-125BMC

CHF 291.00 1 019860025

490x370x125 mm - 3,8 kg



1994B 20V-2AH

Batterie lithium-ion 2 Ah pour outils BETA 20 V

Technologie lithium-ion premium
3 indicateurs de niveau de charge LED

Caractéristiques principales

- Tension de la batterie : 20 V
- Capacité de la batterie : 2 Ah
- Capacité énergétique : 40Wh
- Type de batterie : Li-ion

📦 410 g



DISPONIBLE
À PARTIR DE MAI

CE

CHF 82.00 1 019940022

1994B 20V-2AH

1994B 20V-4AH

Batterie lithium-ion 4 Ah pour outils BETA 20 V

Technologie lithium-ion haut de gamme
3 indicateurs de niveau de charge LED

Caractéristiques principales

- Tension de la batterie : 20 V
- Capacité de la batterie : 4 Ah
- Capacité énergétique : 80Wh
- Type de batterie : Li-ion

📦 660 g



DISPONIBLE
À PARTIR DE MAI

CE

CHF 136.50 1 019940044

1994B 20V-4AH

1994B 20V-6AH

Batterie lithium-ion 6 Ah pour outils BETA 20 V

Technologie lithium-ion haut de gamme
3 indicateurs de niveau de charge LED

Caractéristiques principales

- Tension de la batterie : 20 V
- Capacité de la batterie : 6 Ah
- Capacité énergétique : 120Wh
- Type de batterie : Li-ion

📦 900 g



DISPONIBLE
À PARTIR DE MAI

CE

CHF 188.50 1 019940066

1994B 20V-6AH

1994C 20V

Chargeur de batterie rapide 20V, 110V-240V

Caractéristiques principales:

- Indicateur de niveau de charge LED
- Tension d'entrée nominale : 110 V-240 V ~ 50/60 Hz
- Tension de sortie : 20 V
- Courant de charge : 6 A
- Puissance d'entrée nominale : 145 W

Temps de charge de la batterie 20V 2Ah : 45 min

Temps de charge de la batterie 20V 4Ah : 90 min

Temps de charge de la batterie 20V 6Ah : 120 min

📦 570 g



DISPONIBLE
À PARTIR DE MAI

CE

CHF 144.00 1 019940140

1994C 20V

1989RCB

Radio de chantier 20V

CE

Radio numérique de chantier multifonctions : radio numérique (DAB ; Bluetooth) et radio FM conventionnelle
Convient pour une utilisation sur les chantiers de construction ou pour les loisirs

Radio robuste au design compact et moderne, indice de protection IP54
Son stéréo puissant fourni par deux puissants haut-parleurs latéraux de 16 W
Fonction d'alarme intégrée
Livré Complet avec poignée de transport et protection d'angle antichoc
Avec connexion AUX et connecteur USB protégé pour la connexion et la charge du téléphone
Peut être utilisée avec les batteries 20 V Beta (en option) ou le cordon d'alimentation (inclus).

Caractéristiques principales:

- Gamme de fréquences radio FM : 87,5 à 108 MHz
- Gamme de fréquences radio DAB : 174 à 240 MHz
- Nombre de stations FM et DAB mémorisées : 20
- Puissance du haut-parleur : 16 W
- Tension nominale de la batterie (en option) : 20 V
- Dimensions radio : 180 x 205 x 305 mm
- Poids radio (sans batterie) : 3,2 kg

DISPONIBLE
À PARTIR DE MAI



1989RCB

CHF 422.00 1 019890020

C9PT

Sac en tissu technique pour l'outillage électroportatif

Parfait pour transporter facilement l'outillage électroportatif Beta

Fabriqué à partir de tissu technique ultra résistant
Double poignée supérieure pour une prise en main sûre et équilibrée

DISPONIBLE
À PARTIR DE MAI



C9PT

CHF 52.00 1 021090001

400x210x290 mm - 2,4 kg

Beta



La gamme d'outils filaires comprend des meuleuses d'angle, **des perceuses (à percussion et à perforation)**, **des aspirateurs pour solides et pour fluides**, **des pistolets thermiques et à pistolets à colle**.

En particulier, les meuleuses d'angle Beta (avec des puissances de 750W à 2400W) connaissent un succès croissant grâce aux caractéristiques de construction suivantes :

• **Performance exceptionnelle:**

- Moteur puissant, imprégné à la résine et permettant de résister à l'usure.
- Ailettes d'aération assurant un refroidissement optimal, et protégeant contre les infiltrations de poussières

• **Sécurité inégalée des opérateurs:**

- Dispositif de verrouillage de broche pour un changement rapide des disques
- Protection contre une activation accidentelle
- Démarrage progressif, pour limiter l'appel initial important de courant au démarrage

• **Confort et facilité de manipulation uniques:**

- Poignée ergonomique antidérapante pour une meilleure prise en main
- Tête abaissée permettant le travail dans des espaces confinés

Câble anti enchevêtrement d'une longueur de 4 mètres permettant une facilité de mouvement Poignée supplémentaire pouvant être montée des deux côtés.

1956 115-750W

meuleuse d'angle pour disques Ø 115 mm

Idéal pour les travaux de coupe, de meulage et d'ébauche Moteur puissant (750 W) Poignée ergonomique antidérapante pour un confort et une sécurité accrue Tête abaissée qui permet de travailler dans des espaces confinés Extrêmement léger (ne pèse pas plus de 1,8 kg)

Caractéristiques principales

- Protection contre l'activation accidentelle
- Poignée supplémentaire pouvant être montée des deux côtés
- Couvercle de disque sans outil (dégagement rapide)
- Dispositif de verrouillage de broche pour des changements de disque rapides
- Interrupteur à glissière verrouillez / éteignez
- Bouches d'aération protégées contre les infiltrations de poussière et offrant des performances de refroidissement optimales
- Clé de service incluse

1,8 kg



1956 115-750W

CHF 101.00 1 019560011

1956 125-1400W

meuleuse d'angle pour disques Ø 125 mm

Idéal pour les travaux de coupe, de meulage et d'ébauche Moteur puissant (1400 W) - Vitesse variable Poignée ergonomique antidérapante pour un confort et une sécurité accrue Tête abaissée qui permet de travailler dans des espaces confinés

Caractéristiques principales

- Protection contre l'activation accidentelle
- Poignée anti-vibration supplémentaire qui peut être montée des deux côtés
- Couvercle de disque sans outil (dégagement rapide)
- Dispositif de verrouillage de broche pour des changements de disque rapides
- Interrupteur à glissière verrouillez / éteignez
- Bouches d'aération protégées contre les infiltrations de poussière et offrant des performances de refroidissement optimales
- Clé de service incluse

📦 2,5 kg

1956 125-1400W

CHF 196.00 1 019560125

CE

L = 4 m



1956 230-2400W

meuleuse d'angle pour disques Ø 230 mm

Moteur puissant (2400 W) Poignée ergonomique antidérapante pour un confort et une sécurité accrue

Caractéristiques principales

- Protection contre l'activation accidentelle
- Fonction de démarrage progressif pour un démarrage en douceur et limiter les grandes poussées initiales de courant au démarrage
- Poignée anti-vibration supplémentaire qui peut être montée des deux côtés
- Couvercle de disque à vis
- Dispositif de verrouillage de broche pour des changements de disque rapides
- Interrupteur à glissière verrouillez / éteignez
- Bouches d'aération protégées contre les infiltrations de poussière et offrant des performances de refroidissement optimales
- Clé de service incluse

📦 5,8 kg

1956 230-2400W

CHF 264.00 1 019560230

CE

L = 4 m



1966/910W

Perceuse à percussion, 910W

Idéal pour percer différents matériaux, le bois, le métal, le plastique, les murs en agglos et le béton

Moteur puissant de 910 W

Conception compacte avec poignée ergonomique et antidérapante

Mandrin automatique en métal de 13 mm

Vitesse variable réversible

Carter d'engrenage entièrement métallique

Verrouillage de l'interrupteur pour un confort d'utilisation amélioré

Caractéristiques principales:

- Diamètre maximal de perçage dans le bois : 32 mm
- Diamètre Maximal de perçage dans le métal : 13 mm
- Diamètre Maximal de perçage dans les murs en agglos : 13 mm
- Vitesse à vide : 0-2 800 tr/min
- Câble d'alimentation anti-enchevêtrement d'une longueur de 4 m

Accessoires fournis:

- Mandrin automatique en métal, 13 mm
- Poignée latérale supplémentaire pouvant s'orienter à 360°
- Tige repère pour le perçage précis en profondeur

DISPONIBLE
À PARTIR DE MAI



CHF

161.00



1



019660091

420x320x120 mm - 4,3 kg

1967/800W

Marteau perforateur SDS-PLUS, 800W

Idéal pour percer, marteler ou ciseler les murs d'agglos, le béton, le carrelage, le bois et le métal.

Moteur puissant de 800 W pour les applications intensives

Professionnel, léger et puissant

De conception ergonomique et compacte, il permet de travailler dans des espaces exigus

Caractéristiques principales

3 modes de fonctionnement et 1 fonction Vario-Lock :

- Fonction perçage
- Fonction marteau
- Fonction burin
- Fonction vario-lock : peut être verrouillée dans 36 positions de burinage, pour obtenir un angle de travail optimal

• Diamètre maximal de perçage dans le bois : 30 mm

• Diamètre maximal de perçage dans le métal : 13 mm

• Diamètre maximal de perçage dans le béton : 26 mm

Réversible

Embrayage de sécurité

Puissance de course : 3,2 Joules

Vitesse à vide : 0-1350 tr/min

Nombre de coups : 0-5700 coups/min

Câble d'alimentation sans enchevêtrement d'une longueur de 4 m

Accessoires fournis:

- Mandrin de 13 mm avec adaptateur SDS-PLUS
- Poignée latérale supplémentaire orientable à 360°
- Tige de repère pour un perçage précis en profondeur
- 3 forets à Béton, Ø 8-10-12 mm, longueur 150 mm
- 1 burin plat 14x250 mm
- Burin 1 pointe, 14x250 mm

DISPONIBLE
À PARTIR DE MAI



CHF

232.00



1



019670080

420x300x115 mm - 5,2 kg



1850D

Pistolet thermique à 3 vitesses

- Pos. I 250 l/min 50 °C
- Pos. II 250 l/min 400 °C
- Pos. III 500 l/min 550 °C



1850D	L mm 255	H mm 210	CHF 171.00	1	018500018
-------	----------------	----------------	---------------	---	-----------

1850E

pistolet thermique électronique réglable

- Pos. Je 250-500 l / min 50 °C
- Pos. II 250 à 500 l / min 50 à 650 °C

- affichage numérique
- boutons de réglage de la température et du débit
- 4 programmes prédéfinis et autres programmes personnalisables

- Prog 1 150 °C env. 400 l / min
- Prog 2 200 °C env. 400 l / min
- Prog 3 300 °C env. 450 l / min
- Prog 4 400 °C env. 500 l / min



1850E	L mm 255	H mm 210	CHF 358.00	1	018500020
-------	----------------	----------------	---------------	---	-----------

1851VK

Pistolet pour colle à chaud fourni avec 12 bâtonnets de colle thermofusible en coffret

- Puissance : 80 watts
- Pour colle en bâtonnet Ø 11 et 12 mm

CE



1851VK	CHF 70.50	1	018510058
≡ 320x250x50 mm			

1851VK-12C

12 bâtonnets de colle thermofusible Ø 11 mm



1851VK-12C	CHF 18.10	1	018510062
------------	--------------	---	-----------

1851VK-12V

12 bâtonnets de colle thermofusible

Ø 11 mm



1851VK-12V	CHF 18.10	1	018510072
------------	--------------	---	-----------



1870

Aspirateur 20 litres eau et poussières pour usage professionnel

- moteur by-pass mono-étagé
- tension 230/240 V
- fréquence 50/60 Hz
- puissance maxi 1200 W
- débit d'air l/sec. 58
- dépression maxi 190 mbars
- volume de la cuve : 20 l en plastique antistatique
- niveau sonore <70 dB(A)
- longueur câble 5 m
- chariot porte-accessoires
- ACCESSOIRES FOURNIS Ø 36 mm
- 1 flexible aspiration 1,5 m
- 2 tubes aspiration rigides en plastique
- 1 suceur brosse multifonctions eau et poussières
- 1 suceur fente long
- SYSTÈMES FILTRANTS
- 1 filtre cartouche surface 1900 cm² - 12 microns nom.
- 1 filtre mousse PPI 45/PPI 30

CE



IPX4

1870	CHF 305.00	1	018700020
------	---------------	---	-----------

1870I

aspirateur solide et fluide, 20 l, tambour en acier inoxydable

- moteur de by-pass à un étage
- tension : 230/240 V
- fréquence : 50/60 Hz
- puissance max. : 1200 W
- débit d'air : 58 l/sec.
- pression d'aspiration max. : 190 mbar
- capacité maximale du tambour: 20 l, en acier inoxydable
- émissions acoustiques : <70 dB(A)
- longueur du câble: 5 m ACCESSOIRES STANDARD Ø 36 mm
- 1 tuyau ondulé avec poignée ergonomique et évent
- 2 tubes d'extension durs
- 1 brosse multi-utilisation pour sols et fluides
- 1 buse plate
- 1 sac en papier SYSTÈMES DE FILTRAGE
- 1 cartouche de filtre à air de surface 1900 cm² - 12 µm nom.
- 1 filtre anti-mousse PPI 45/PPI 30

CE



IPX4

1870I	CHF 340.00	1	018700220
-------	---------------	---	-----------

1872L

Aspirateur 35 litres pour solides et liquides classe certifiée "L"

- Moteur by-pass bi-étagé
- Tension 230/240 V
- Fréquence 50/60 Hz
- Puissance max. 1100 W
- Débit d'air 55 l/sec.
- Dépression max. 220 mbar
- Capacité max. bidon 35 l en PE-HD antistatique
- Émissions acoustiques <68 dB(A)
- Longueur câble 6 m
- ACCESSOIRES FOURNIS Ø 36 mm
- 1 tuyau cannelé avec branche ergonomique
- 2 tuyaux de rallonge en plastique
- 1 suceur combiné 2 positions
- 1 suceur avec raclette en caoutchouc pour l'aspiration de liquides
- 1 embout à lance
- SYSTÈMES FILTRANTS
- 1 sac en tissu non tissé classe de filtrage "L"
- 1 cartouche filtre classé IFA classe "L"
- 1 filtre anti-mousse PPI 45/PPI 30
- 2 post-filtres en PET associé à PP

CE



IPX4

1872L 35 CHF 666.00 1 018720135

1873

Aspirateur 30 litres eau et poussières pour usage professionnel en acier INOX

- moteur by-pass bi-étagé
- tension 230/240 V • fréquence 50/60 Hz
- puissance maxi 1100 W • débit d'air l/sec. 55
- dépression maxi 220 mbars
- volume de la cuve: 30 l en acier inox
- niveau sonore <61 dB(A) • longueur câble 6 m
- chariot porte-accessoires
- ACCESSOIRES FOURNIS Ø 45 mm
- 1 flexible d'aspiration 2 m avec poignée ergonomique - grande amplitude de travail
- 2 tubes rallonges d'aspiration rigides en acier inox
- 1 porte-suceur brosse pour sols
- 1 suceur brosse articulée pour sols et moquettes
- 1 suceur avec raclette en caoutchouc
- 1 suceur fente long
- 1 buse d'aspiration triangulaire
- SYSTÈMES FILTRANTS
- 1 sac en papier filtre
- 1 filtre cartouche surface 1900 cm² 12 microns nom.
- 1 filtre mousse PPI 45/PPI 30

CE



1873 30 CHF 888.00 1 018730030

1874

Aspirateur 50 litres eau et poussières pour usage professionnel en acier inox

- moteur by-pass bi-étagé
- tension 230/240 V • fréquence 50/60 Hz
- puissance maxi 1350 W • débit d'air l/sec. 55
- dépression maxi 240 mbars
- volume de la cuve: 50 l en acier inox
- niveau sonore <63 dB(A) • longueur câble 6 m
- chariot porte-accessoires
- ACCESSOIRES FOURNIS Ø 45 mm
- 1 flexible d'aspiration 2 m avec poignée ergonomique - grande amplitude de travail
- 2 tubes rallonges d'aspiration rigides en acier inox
- 1 porte-suceur brosse pour sols
- 1 suceur brosse articulée pour sols et moquettes
- 1 suceur avec raclette en caoutchouc pour aspiration de liquides
- 1 suceur fente long
- 1 buse d'aspiration triangulaire
- SYSTÈMES FILTRANTS
- 1 sac en papier filtre
- 1 filtre cartouche surface 5200 cm² 12 microns nom.
- 1 filtre mousse PPI 45/PPI 30

CE



1874 50 CHF 1,121.00 1 018740050

1870-20/5S

5 sacs en papier horizontaux pour 1870-1875LT



1870 20/5S CHF 69.50 1 018700021

1870-72 /FC

Filtre cartouche surface 1900 cm² 12 microns nom. pour 1870 - 1870I - 1873 - 1875LT



1870/FC CHF 59.50 1 018700026

1870-72/FL

Filtre pour aspiration liquides pour 1870 - 1870I - 1872L - 1873 - 1874 - 1875LT



1870 72/FL CHF 22.00 1 018700027

1872L 35/FC

Filtre à cartouche classe "L" pour 1872L 35



1872L 35/FC CHF 72.00 1 018720144

1872L 35/5S

5 sacs en tissu non-tissé classe "L"



1872L 35/5S CHF 109.50 1 018720136

1873-30/5S

5 sacs en papier verticaux pour 1873



1873 30/5S CHF 69.50 1 018730031

1874-50/5S

5 sacs verticaux pour 1874



1874 50/5S CHF 88.00 1 018740051

1874-50/FC

Filtre cartouche surface 5200 cm² 12 microns nom. pour 1874



1874 50/FC CHF 71.50 1 018740056



OUTILLAGE PNEUMATIQUE ET ACCESSOIRES

Depuis plus de 20 ans, Beta Utensili a élargi son offre avec une gamme complète d'outillage pneumatique et d'accessoires destinés au marché automobile et à la maintenance industrielle : clés à chocs, cliquets, perceuses, meuleuses, ponceuses et bien d'autres articles.

Lors de cette période, l'étroite collaboration avec les utilisateurs professionnels a été fondamentale pour une croissance constante. C'est précisément grâce à cette croissance qu'aujourd'hui le marché reconnaît que l'outillage pneumatique Beta présente un excellent rapport fiabilité/prestations.

Afin de satisfaire au mieux les demandes du marché, Beta Utensili effectue les réparations des articles pneumatiques au sein de son Service Qualité. Ce processus a permis à l'entreprise de développer considérablement son propre savoir-faire et de réagir en temps réel aux demandes de la clientèle.

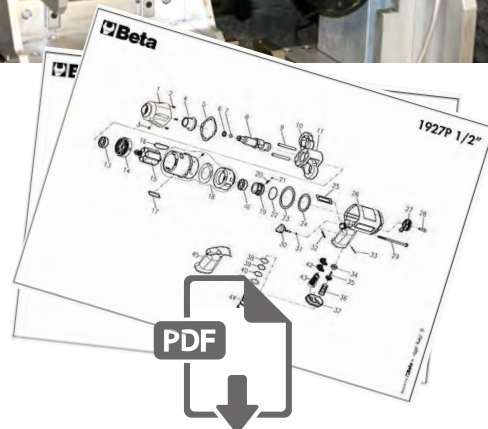
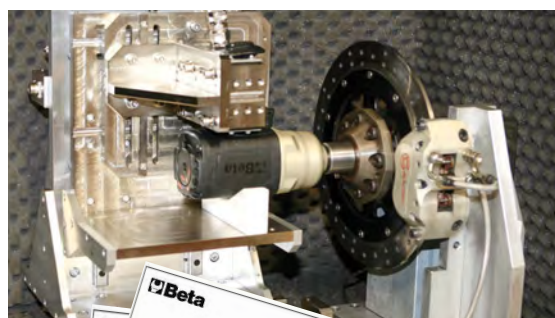







PDF



www.beta-tools.com

GUIDE AU CHOIX D'OUTILS PNEUMATIQUES













CLÉS À CHOCS

■	CODE BETA	N °	MATÉRIAU	 max. Nm	 db (A) LpA	 db (A) LpW	 l/min.	 kg	MÉCANISME	 m/s ²
3/8"		1924F	Aluminium	108	93,6	104,6	59	0,5	Double frappe	6,85
3/8"		1924B	Aluminium	353	91	95	80	1,5	Pin clutch	7,9
3/8"		1924CD	Composite	410	91,7	102,7	79	1,3	Double frappe	6,2
3/8"		1924XM	Composite	515	91,7	102,7	122	1,3	Simple frappe	6,2
1/2"		1927AN	Aluminium	244	89,4	100,4	190	2,1	Simple frappe	8,63
1/2"		1927G	Aluminium	325	92,2	103,2	113	1,2	Simple frappe	9,96
1/2"		1927B	Aluminium	705	98,0	109,0	133	2,1	Pin clutch	14,08
1/2"		1927XM	Aluminium	770	102	113	122	1,3	Simple frappe	7,5
1/2"		1927CD	Composite	1.020	95,5	106,5	130	2,3	Double frappe	7,2
1/2"		1927P	Composite	1.750	95,1	106,1	290	2,0	Double frappe	6,7
3/4"		1928XM	Aluminium	1.600	91,8	102,8	175	2,9	Double frappe	12,96
3/4"		1928DA	Aluminium	1.695	96	99,5	300	4,3	Double frappe	3,6
3/4"		1928DAL	Aluminium	1.695	96	99,5	300	4,8	Double frappe	3,6
3/4"		1928CD	Composite	1.800	97,5	108,5	215	3,5	Double frappe	11,4
3/4"		1928P	Composite	2.100	96,2	107,2	221	3,7	Double frappe	7,6
1"		1930CD	Composite	2.445	95,6	97,1	410	7,1	Double frappe	3,6
1"		1930PA	Aluminium	2.445	96,0	97,1	410	9,6	Double frappe	7,2
1"		1930A	Aluminium	2.445	103,3	114,3	460	9,5	Double frappe	67
1"		1930LH	Aluminium	2.441	97,1	108,1	282	7,1	Double frappe	17,4
1"		1930LA	Aluminium	2.445	95,6	97,1	460	10,6	Double frappe	3,6

GUIDE AU CHOIX D'OUTILS PNEUMATIQUES

■	CODE BETA	N°	MATÉRIAU	max. Nm	db (A) LpA	db (A) LpW	l/min.	kg	MECHANISM	m/s ²
				1"		1930HLA	Aluminium	3.661	99	101
1 1/2"		1930ZL	Aluminium	4.068	102,4	113,4	480	15	Double frappe	69.6

CLIQUETS

■	CODE BETA	N°	 max. Nm	 db (A) LpA	 db (A) LpW	 l/min.	 kg	 m/s ²
1/4"		1921B1	24	96	85	90	0,4	2.6
1/4"		1921M1	27	84	88	96	0,6	1.8
1/4"		1922P1	68	90,6	101,6	88	0,6	8.61
3/8"		1921M2	27	84	88	96	0,6	1.8
3/8"		1922P2	68	90,6	101,6	88	0,6	8.61
1/2"		1921N3	68	80	87	140	1,2	2.6
1/2"		1922P3	136	94,9	105,9	113	1,5	18.28

MEULEUSE

	CODE BETA	N°	PUISSANCE	 db (A) LpA	 db (A) LpW	 l/min.	 kg	 m/s ²
		1933	0,20 kW	80,0	87,0	230	0,38	4,53
		1933L	0,20 kW	80,0	87,0	270	0,67	1,15
		1933AN90	0,20 kW	80,0	87,0	230	0,51	1,24
		1933I	0,38 kW	80,0	87,0	260	0,67	4,53
		1933IL	0,38 kW	79,0	97,0	113	1,4	1,6
		1933IH	0,75 kW	88,1	99,1	370	0,8	2,6
		1933ILH	0,75 kW	85,7	96,7	370	1,2	1,4
		1933AN90-H	0,75 kW	85,6	96,6	370	1,1	6,7
		1934MAV	0,04 kW	71	76	115	0,2	2,5
		1934MAV70	0,08 kW	80	87	115	0,2	4

1921B1

Mini-cliquet réversible

1/4"

CE



Vitesse à vide	350 tours/min
Couple de serrage maximum	24 Nm
Capacité vis/écrou	Cl 8.8 M7●11 mm
Capacité vis/écrou	Cl 12.9 M6●10 mm
Filetage d'arrivée d'air	1/4" GAS
Pression d'utilisation	6,2 bar
Ø intérieur du tuyau d'air	8 mm
Consommation d'air moyenne	68 l/min
Poids	0,4 kg

■	kg	CHF	1	019210001
1/4	0,6	321.00		

1921M1

Mini-cliquet réversible compact

• Régulateur de vitesse à bouton

1/4"

CE



Vitesse à vide	200 tours/min
Couple de serrage maximum	27 Nm
Capacité vis/écrou	Cl 8.8 M7●11 mm
Capacité vis/écrou	Cl 12.9 M6●10 mm
Filetage d'arrivée d'air	1/4" GAS
Pression d'utilisation	6,2 bars
Ø intérieur du tuyau d'air	8 mm
Consommation d'air moyenne	96 l/min
Poids	0,6 kg

■	kg	CHF	1	019210005
1/4	0,6	283.00		

1921M2

Mini-cliquet réversible compact

• Régulateur de vitesse à bouton

3/8"

CE



Vitesse à vide	200 tours/min
Couple de serrage maximum	27 Nm
Capacité vis/écrou	Cl 8.8 M7●11 mm
Capacité vis/écrou	Cl 12.9 M6●10 mm
Filetage d'arrivée d'air	1/4" GAS
Pression d'utilisation	6,2 bars
Ø intérieur du tuyau d'air	8 mm
Consommation d'air moyenne	96 l/min
Poids	0,6 kg

■	kg	CHF	1	019210015
3/8	0,6	283.00		

1921N3

Mini-cliquet réversible

1/2"

CE



Vitesse à vide	150 tours/min
Couple de serrage maximum	68 Nm
Capacité vis/écrou	Cl 8.8 M10●16 mm
Capacité vis/écrou	Cl 12.9 M8●13 mm
Filetage d'arrivée d'air	1/4" GAS
Pression d'utilisation	6,2 bars
Ø intérieur du tuyau d'air	10 mm
Consommation d'air moyenne	140 l/min
Poids	1,2 kg

■	kg	CHF	1	019210025
1/2	1,2	283.00		

1922P1

Mini-cliquet à impulsion réversible

• Mécanisme impulsif type "rocking dog" à double frappe

1/4"

CE



Vitesse à vide	700 tours/min
Couple de serrage maximum	68 Nm
Capacité vis/écrou	Cl 8.8 M10●16 mm
Capacité vis/écrou	Cl 12.9 M8●13 mm
Filetage d'arrivée d'air	1/4" GAS
Pression d'utilisation	6,2 bar
Ø intérieur du tuyau d'air	10 mm
Consommation d'air moyenne	88 l/min
Poids	0,6 kg

■	kg	CHF	1	019220006
1/4	0,6	343.00		

1922P2

Mini-cliquet à impulsion réversible

• Mécanisme impulsif type "rocking dog" à double frappe

3/8"

CE



Vitesse à vide	700 tours/min
Couple de serrage maximum	68 Nm
Capacité vis/écrou	Cl 8.8 M10●16 mm
Capacité vis/écrou	Cl 12.9 M8●13 mm
Filetage d'arrivée d'air	1/4" GAS
Pression d'utilisation	6,2 bar
Ø intérieur du tuyau d'air	10 mm
Consommation d'air moyenne	88 l/min
Poids	0,6 kg

■	kg	CHF	1	019220010
3/8	0,6	343.00		

1922P3

Mini-cliquet à impulsion réversible

• Mécanisme impulsif type "rocking dog" à double frappe

1/2"

CE



Vitesse à vide	600 tours/min
Couple de serrage maximum	136 Nm
Capacité vis/écrou	Cl 8.8 M12●18 mm
Capacité vis/écrou	Cl 12.9 M10●16 mm
Filetage d'arrivée d'air	1/4" GAS
Pression d'utilisation	6,2 bar
Ø intérieur du tuyau d'air	10 mm
Consommation d'air moyenne	113 l/min
Poids	1,5 kg

■	kg	CHF	1	019220013
1/2	1,5	542.00		

1924F

Clé à chocs réversible compacte "papillon"

• Mécanisme impulsif type "rocking dog" à double frappe

3/8"

CE



Vitesse à vide	12.000 tours/min
Couple de serrage maximum	108 Nm
Capacité vis/écrou	Cl 8.8 M12●18 mm
Capacité vis/écrou	Cl 12.9 M10●16 mm
Filetage d'arrivée d'air	1/4" GAS
Pression d'utilisation	6,2 bar
Ø intérieur du tuyau d'air	10 mm
Consommation d'air moyenne	59 l/min
Poids	0,5 kg

■	kg	CHF	1	019240025
3/8	0,5	317.00		



1924B

Clé à chocs réversible compacte

• Mécanisme à percussion "Pin Clutch"



Vitesse à vide	10.000 tours/min
Couple de serrage maximum	353 Nm
Capacité vis/écrou	Cl 8.8 M16●24 mm
Capacité vis/écrou	Cl 12.9 M14●21 mm
Filetage d'arrivée d'air	1/4" GAS
Pression d'utilisation	6,2 bar
Ø intérieur du tuyau d'air	8 mm
Consommation d'air moyenne	80 l/min
Poids	1,5 kg

3/8"	kg	CHF	1	019240021
3/8"	1,5	365.00		

1924XM

Clé à chocs réversible compacte

• Mécanisme à simple frappe



Vitesse à vide	9.000 tour/min
Couple de serrage maximum	515 Nm
Capacité vis/écrou	Cl 8.8 M16●24 mm
Capacité vis/écrou	Cl 12.9 M14●21 mm
Filetage d'arrivée d'air	1/4" GAS
Pression d'utilisation	6,2 bar
Ø intérieur du tuyau d'air	10 mm
Consommation d'air moyenne	122 l/min
Poids	1,3 kg

3/8"	kg	CHF	1	019240030
3/8"	1,3	352.00		

1927B

Clé à chocs réversible

• Mécanisme à "Pin Clutch"



Vitesse à vide	7.000 tours/min
Torque max.	705 Nm
Capacité vis/écrou	Cl 8.8 M22●34 mm
Capacité vis/écrou	Cl 12.9 M18●27 mm
Filetage d'arrivée d'air	1/4" GAS
Pression d'utilisation	6,2 bar
Ø intérieur du tuyau d'air	10 mm
Consommation d'air moyenne	133 l/min
Poids	2,1 kg

1/2"	kg	CHF	1	019270022
1/2"	2,1	245.50		

1924CD

Clé à chocs réversible en matériau composite

• Mécanisme à double frappe



Vitesse à vide	10.000 tours/min
Couple de serrage maximum	410 Nm
Capacité vis/écrou	Cl 8.8 M16●24 mm
Capacité vis/écrou	Cl 12.9 M14●21 mm
Filetage d'arrivée d'air	1/4" GAS
Pression d'utilisation	6,2 bar
Ø intérieur du tuyau d'air	8 mm
Consommation d'air moyenne	79 l/min
Poids	1,3 kg

3/8"	kg	CHF	1	019240007
3/8"	1,3	441.00		



1927B/K5

clé à chocs réversible, en aluminium, fournie avec 5 douilles d'impact, en coffret



Vitesse à vide	7.000 rpm
Couple Max	705 Nm
Capacité vis/écrou	Cl 8.8 M22●34 mm
Capacité vis/écrou	Cl 12.9 M18●27 mm
Entrée d'air	1/4" GAS
Pression de service	6,2 bar
Taille du tuyau interne (Ø)	10 mm
Consommation moyenne d'air	133 l/min
Poids	2.1 kg

1/2"	kg	CHF	1	019270122
1/2"	3,5	324.00		
350x305x86 mm				

1927CD

Clé à chocs réversible en matériau composite

- Mécanisme à double frappe



Vitesse à vide	7.000 tours/min
Couple de serrage maximum	1.020 Nm
Capacité vis/écrou	Cl 8.8 M22●34 mm
Capacité vis/écrou	Cl 12.9 M18●27 mm
Filetage d'arrivée d'air	1/4" GAS
Pression d'utilisation	6,2 bar
Ø intérieur du tuyau d'air	10 mm
Consommation d'air moyenne	130 l/min
Poids	2,3 kg

1/2 2,3 CHF 508.00 1 019270007

1927P

Clé à chocs réversible en matériau composite

- Mécanisme à double frappe



Vitesse à vide	7.500 tours/min
Couple de serrage maximum	1.750 Nm
Capacité vis/écrou	Cl 8.8 M24●36 mm
Capacité vis/écrou	Cl 12.9 M20●30 mm
Filetage d'arrivée d'air	1/4" GAS
Pression d'utilisation	6,2 bar
Ø intérieur du tuyau d'air	10 mm
Consommation d'air moyenne	290 l/min
Poids	2 kg

1/2 kg 2,0 CHF 554.00 1 019270008

1927XM

Clé à chocs réversible compacte

- Mécanisme à simple frappe



Vitesse à vide	10.000 tours/min
Couple de serrage maximum	770 Nm
Capacité vis/écrou	Cl 8.8 M22●34 mm
Capacité vis/écrou	Cl 12.9 M18●27 mm
Filetage d'arrivée d'air	1/4" GAS
Pression d'utilisation	6,2 bar
Ø intérieur du tuyau d'air	10 mm
Consommation d'air moyenne	122 l/min
Poids	1,3 kg

1/2 kg 1,3 CHF 374.00 1 019270030

1927CD/K3

Composition d'une clé à chocs réversible et de 3 douilles à chocs

- Mécanisme à double frappe



Vitesse à vide	7.000 tours/min
Couple de serrage maximum	1.020 Nm
Capacité vis/écrou	Cl 8.8 M22●34 mm
Capacité vis/écrou	Cl 12.9 M18●27 mm
Filetage d'arrivée d'air	1/4" GAS
Pression d'utilisation	6,2 bars
Ø intérieur du tuyau d'air	10 mm
Consommation d'air moyenne	130 l/min
Poids	1,9 kg

1/2 kg 4 CHF 572.00 1 019270107

350x305x86 mm

1927P/K3

Clé à chocs réversible en matériau composite fournie avec 3 douilles à chocs



Vitesse à vide	7.500 tours/min
Couple de serrage maximum	1.750 Nm
Capacité vis/écrou	Cl 8.8 M24●36 mm
Capacité vis/écrou	Cl 12.9 M20●30 mm
Filetage d'arrivée d'air	1/4" GAS
Pression d'utilisation	6,2 bars
Ø intérieur du tuyau d'air	10 mm
Consommation d'air moyenne	290 l/min
Poids	2,9 kg

1/2 kg 4 CHF 646.00 1 019270118

350x305x86 mm

1927XM/K5

Composition d'une clé à chocs réversible compacte 1927XM et de 5 douilles à chocs

- Mécanisme de simple frappe



Vitesse à vide	10.000 tours/min
Couple de serrage maximum	770 Nm
Capacité vis/écrou	Cl 8.8 M22●34 mm
Capacité vis/écrou	Cl 12.9 M18●27 mm
Filetage d'arrivée d'air	1/4" GAS
Pression d'utilisation	6,2 bars
Ø intérieur du tuyau d'air	10 mm
Consommation d'air moyenne	122 l/min
Poids	1,3 kg

1/2 kg 2,8 CHF 455.00 1 019270129

307x206x86 mm

1927AN

Clé à chocs réversible à renvoi d'angle

- Mécanisme de simple frappe

12"

CE



Vitesse à vide	4.700 tours/min
Couple de serrage maximum	244 Nm
Capacité vis/écrou	CI 8.8 M14●21 mm
Capacité vis/écrou	CI 12.9 M12●19 mm
Filetage d'arrivée d'air	1/4" GAS
Pression d'utilisation	6,2 bar
Ø intérieur du tuyau d'air	10 mm
Consommation d'air moyenne	190 l/min
Poids	2,1 kg

1/2	kg	CHF	1	019270012
2,1		661.00		

1927G

Clé à chocs réversible compacte

- Mécanisme à simple frappe

12"

CE



Vitesse à vide	8500 tours/min
Torque max.	325 Nm
Capacité vit/écrou	CI 8.8 M16●24 mm
Capacité vis/écrou	CI 12.9 M14●21 mm
Filetage d'arrivée d'air	1/4" GAS
Pression d'utilisation	6,2 bar
Ø intérieur du tuyau d'air	10 mm
Consommation d'air moyenne	113 l/min
Poids	1,2 kg

1/2	kg	CHF	1	019270050
1,2		543.00		

1927SP-AM

Support magnétique pour clé à chocs pneumatique

- Équipé de deux aimants à haute tenue avec caoutchouc de protection
- Permet de loger 1 clé à chocs 1/2", 4 douilles et 1 clé dynamométrique
- Capacité : 10 kg



g	CHF	1	019270000
400	80.50		

1928DA

Clé à chocs réversible

- Mécanisme à double frappe

3/4"

CE



Vitesse à vide	5.000 tours/min
Couple de serrage maximum	1.695 Nm
Capacité vis/écrou	CI 8.8 M30●46 mm
Capacité vis/écrou	CI 12.9 M27●41 mm
Filetage d'arrivée d'air	3/8" GAS
Pression d'utilisation	6,2 bar
Ø intérieur du tuyau d'air	10 mm
Consommation d'air moyenne	240 l/min
Poids	4,3 kg

3/4	kg	CHF	1	019280022
4,3		1.073.00		

1928DAL

Clé à chocs réversible

- Mécanisme à double frappe

3/4"

CE



Vitesse à vide	5.000 tours/min
Couple de serrage maximum	1.695 Nm
Capacité vis/écrou	CI 8.8 M27●41 mm
Capacité vis/écrou	CI 12.9 M24●36 mm
Filetage d'arrivée d'air	3/8" GAS
Pression d'utilisation	6,2 bar
Ø intérieur du tuyau d'air	10 mm
Consommation d'air moyenne	240 l/min
Poids	4,8 kg

3/4	kg	CHF	1	019280023
4,8		1.151.00		

1928KA

Coffret clé à chocs réversible et quatre douilles à chocs longues

- Mécanisme à percussion "Pin Clutch"

3/4"

CE



728L 27-30-32-36 mm

Vitesse à vide	4.000 tours/min
Couple de serrage maximum	1.493 Nm
Capacité vis/écrou	CI 8.8 M27●41 mm
Capacité vis/écrou	CI 12.9 M24●36 mm
Filetage d'arrivée d'air	3/8" GAS BSP
Pression d'utilisation	6,2 bar
Ø intérieur du tuyau d'air	10 mm
Consommation d'air moyenne	260 l/min
Poids clé à chocs	5,2 kg

3/4	kg	CHF	1	019280104
9,3		1.095.00		
410x330x106 mm				

1928XM

Clé à chocs réversible compacte

- Mécanisme double frappe
- Extrêmement compacte et puissante
- Commande d'inversion à touche actionnable d'une seule main
- Trois niveaux de réglage de la puissance de vissage
- Échappement de l'air par la poignée

3/4"

CE



Vitesse à vide	4.800 tours/min
Couple de serrage maximum	1.600 Nm
Capacité vis/écrou	CI 8.8 M27●41 mm
Capacité vis/écrou	CI 12.9 M24●36 mm
Filetage d'arrivée d'air	3/8" GAS
Pression d'utilisation	6,2 bars
Ø intérieur du tuyau d'air	10 mm
Consommation d'air moyenne	175 l/min
Poids	2,9 kg

3/4	kg	CHF	1	019280030
2,9		742.00		

1928CD

Clé à chocs réversible en matériau composite

• Mécanisme à double frappe



Vitesse à vide	4.500 tours/min
Couple de serrage maximum	1.800 Nm
Capacité vis/écrou	Cl 8.8 M27 ● 41 mm
Capacité vis/écrou	Cl 12.9 M24 ● 36 mm
Filetage d'arrivée d'air	3/8" GAS
Pression d'utilisation	6,2 bar
Ø intérieur du tuyau d'air	10 mm
Consommation d'air moyenne	215 l/min
Poids	3,5 kg

3/4 kg 3,5 CHF 1,220.00 1 019280007

1928P

Clé à chocs réversible en matériau composite

• Mécanisme à double frappe



Vitesse à vide	5.000 tours/min
Couple Maximal	2,100 Nm
Capacité vis/écrou/boulon	Cl 8.8 M30 ● 46 mm
Capacité vis/écrou/boulon	Cl 12.9 M27 ● 41 mm
Filetage de l'arrivée d'air	3/8" GAS
Pression d'utilisation	6,2 bar
Ø intérieur du tuyau d'air	10 mm
Consommation moyenne d'air	221 l/min
Poids	3,7 kg

3/4 kg 3,7 CHF 1,475.00 1 019280006

1930LH

Clé à chocs réversible

• Mécanisme à double frappe



Vitesse à vide	6.000 tours/min
Torque max.	2.441 Nm
Capacité vis/écrou	Cl 8.8 M36 ● 55 mm
Capacité vis/écrou	Cl 12.9 M30 ● 46 mm
Filetage d'arrivée d'air	1/2" GAS
Pression d'utilisation	6,2 bar
Ø intérieur du tuyau d'air	13 mm
Consommation d'air moyenne	280 l/min
Poids	7,1 kg

1 kg 7,1 CHF 1,655.00 1 019300030

1930CD

Clé à chocs réversible en matériau composite

• Mécanisme à double frappe



Vitesse à vide	4.000 tours/min
Couple de serrage maximum	2.445 Nm
Capacité vis/écrou	Cl 8.8 M36 ● 55 mm
Capacité vis/écrou	Cl 12.9 M30 ● 46 mm
Filetage d'arrivée d'air	1/2" GAS
Pression d'utilisation	6,2 bar
Ø intérieur du tuyau d'air	13 mm
Consommation d'air moyenne	320 l/min
Poids	7,1 kg

1 kg 7,1 CHF 1,780.00 1 019300022

1930PA

Clé à chocs réversible

• Mécanisme à double frappe



Vitesse à vide	3.500 tours/min
Couple de serrage maximum	2.445 Nm
Capacité vis/écrou	Cl 8.8 M36 ● 55 mm
Capacité vis/écrou	Cl 12.9 M30 ● 46 mm
Filetage d'arrivée d'air	1/2" GAS
Pression d'utilisation	6,2 bar
Ø intérieur du tuyau d'air	13 mm
Consommation d'air moyenne	350 l/min
Poids	9,6 kg

1 kg 9,6 CHF 1,600.00 1 019300032

Beta

1930LA

clé à chocs réversible

• Système de frappe double marteaux

1"
CE



Vitesse à vide	4.000 rpm
Couple de serrage maximum	2.445 Nm
Capacité vis/écrou	CI 8.8 M36●55 mm
Capacité vis/écrou	CI 12.9 M30●46 mm
Filetage d'arrivée d'air	1/2" GAS
Pression d'utilisation	6,2 bar
Ø intérieur du tuyau d'air	13 mm
Consommation d'air moyenne	460 l/min
Poids	10,6 kg

■	kg	CHF	1	019300037
1	10,6	1,685.00		

1930HLA

Clé à chocs réversible 1"

• Mécanisme à double frappe

1"
CE



Vitesse à vide	3.000 tours/min
Couple de serrage maximum	3.661 Nm
Capacité vis/écrou	CI 8.8 M42●65 mm
Capacité vis/écrou	CI 12.9 M33●50 mm
Filetage d'arrivée d'air	1/2" GAS
Pression d'utilisation	6,2 bar
Ø intérieur du tuyau d'air	13 mm
Consommation d'air moyenne	460 l/min
Poids	16,4 kg

■	kg	CHF	1	019300040
1	16,4	2,330.00		

1931CD6

Perceuse réversible en matériau composite

CE



Vitesse à vide	2.600 tours/min
Capacité mandrin	1÷6 mm
Puissance	0,23 kW
Filetage de la broche	3/8" - 24UNF
Filetage d'arrivée d'air	1/4" GAS
Pression d'utilisation	6,2 bar
Ø intérieur du tuyau d'air	8 mm
Consommation d'air moyenne	130 l/min
Poids	0,6 kg

■	kg	CHF	1	019310006
0,6		342.00		

1930A

Clé à chocs réversible

• Mécanisme à double frappe

1"
CE



Vitesse à vide	4.000 tours/min
Couple de serrage maximum	2.445 Nm
Capacité vis/écrou	CI 8.8 M36●55 mm
Capacité vis/écrou	CI 12.9 M30●46 mm
Filetage d'arrivée d'air	1/2" GAS
Pression d'utilisation	6,2 bar
Ø intérieur du tuyau d'air	13 mm
Consommation d'air moyenne	460 l/min
Poids	9,5 kg

■	kg	CHF	1	019300036
1	9,5	1,625.00		

1930ZL

Clé à chocs réversible

• Mécanisme à double frappe

1 1/2"
CE



Vitesse à vide	3.000 tours/min
Couple de serrage maximum	4.068 Nm
Capacité vis/écrou	CI 8.8 M42●65 mm
Capacité vis/écrou	CI 12.9 M36●55 mm
Filetage d'arrivée d'air	1/2" GAS
Pression d'utilisation	6,2 bar
Ø intérieur du tuyau d'air	13 mm
Consommation d'air moyenne	480 l/min
Poids	15 kg

■	kg	CHF	1	019300070
1 1/2	15	2,930.00		

1931CD10

Perceuse réversible en matériau composite

CE



Vitesse à vide	1.800 tours/min
Capacité mandrin	1÷10 mm
Puissance	0,38 kW
Filetage de la broche	3/8" - 24UNF
Filetage d'arrivée d'air	1/4" GAS
Pression d'utilisation	6,2 bar
Ø intérieur du tuyau d'air	10 mm
Consommation d'air moyenne	170 l/min
Poids	1 kg

■	kg	CHF	1	019310010
1,0		308.00		

1931CD13

Perceuse réversible en matériau composite



Vitesse à vide	800 tours/min
Capacité mandrin	1,0÷13 mm
Puissance	0,38 kW
Filetage de la broche	1/2" - 20UNC
Filetage d'arrivée d'air	1/4" GAS
Pression d'utilisation	6,2 bar
Ø intérieur du tuyau d'air	10 mm
Consommation d'air moyenne	170 l/min
Poids	1,3 kg

kg 1,3
CHF 458.00
1 019310013

1931AN10

Perceuse à renvoi d'angle réversible



Vitesse à vide	1.400 tours/min
Capacité mandrin	1÷10 mm
Puissance	0,38 kW
Filetage de la broche	3/8" - 24UNF
Filetage d'arrivée d'air	1/4" GAS
Pression d'utilisation	6,2 bar
Ø intérieur du tuyau d'air	10 mm
Consommation d'air moyenne	150 l/min
Poids	1,1 kg

kg 1,1
CHF 342.00
1 019310030

1932B10

Perceuse réversible



Vitesse à vide	1.800 tours/min
Capacité mandrin	1÷10 mm
Puissance	0,44 kW
Filetage de la broche	3/8" - 24UNF
Filetage d'arrivée d'air	1/4" GAS
Pression d'utilisation	6,2 bar
Ø intérieur du tuyau d'air	10 mm
Consommation d'air moyenne	160 l/min
Poids	1,2 kg

kg 1,2
CHF 245.00
1 019320040

1932RS13

Perceuse réversible



Vitesse à vide	750 tours/min
Capacité mandrin	1,5÷13 mm
Puissance	0,55 kW
Filetage de la broche	3/8" - 24UNF
Filetage d'arrivée d'air	1/4" GAS
Pression d'utilisation	6,2 bar
Ø intérieur du tuyau d'air	10 mm
Consommation d'air moyenne	160 l/min
Poids	1,4 kg

kg 1,4
CHF 311.00
1 019320043

1932B13

Perceuse réversible



Vitesse à vide	400 tours/min
Capacité mandrin	1,5÷13 mm
Puissance	0,34 kW
Filetage de la broche	1/2" - 20UNC
Pression d'utilisation	1/4" GAS
Ø intérieur du tuyau d'air	6,2 bar
Consommation d'air moyenne	10 mm
Poids	1,6 kg

kg 1,6
CHF 366.00
1 019320004

1933IH

Meuleuse droite haute puissance

• Fournie avec pinces de Ø 3 et 6 mm



Vitesse à vide	20.000 tours/min
Capacité pince	3 - 6 mm
Puissance	0,75 kW
Filetage d'arrivée d'air	1/4" GAS
Pression d'utilisation	6,2 bar
Ø intérieur du tuyau d'air	10 mm
Consommation d'air moyenne	370 l/min
Poids	800 g

g 800
CHF 278.00
1 019330006

Beta
Quality Tools

1933ILH

Meuleuse droite longue haute puissance

• Fournie avec pinces de Ø 3 et 6 mm

CE



Vitesse à vide	20.000 tours/min
Capacité pince	3 - 6 mm
Puissance	0,75 kW
Filetage d'arrivée d'air	1/4" GAS
Pression d'utilisation	6,2 bar
Ø intérieur du tuyau d'air	10 mm
Consommation d'air moyenne	370 l/min
Poids	1,2 kg

kg 1,2 CHF 522.00 1 019330011

1933AN90-H

Meuleuse à renvoi d'angle haute puissance

• Fournie avec pinces de Ø 3 et 6 mm

CE



Vitesse à vide	15.000 tours/min
Capacité pince	3 - 6 mm
Puissance	0,75 kW
Filetage d'arrivée d'air	1/4" GAS
Pression d'utilisation	6,2 bar
Ø intérieur du tuyau d'air	10 mm
Consommation d'air moyenne	370 l/min
Poids	1,1 kg

kg 1,1 CHF 522.00 1 019330021

1933

Meuleuse droite

• Fournie avec pince de Ø 3 et 6 mm

CE



Vitesse à vide	25.000 tours/min
Capacité pince	3 - 6 mm
Puissance	0,20 kW
Filetage d'arrivée d'air	1/4" GAS
Pression d'utilisation	6,2 bar
Ø intérieur du tuyau d'air	10 mm
Consommation d'air moyenne	230 l/min
Poids	380 g

kg 380 CHF 182.00 1 019330001

1933I

Meuleuse droite

• Fournie avec pinces de Ø 3 et 6 mm

CE



Vitesse à vide	20.000 tours/min
Capacité pince	3 - 6 mm
Puissance	0,38 kW
Filetage d'arrivée d'air	1/4" GAS
Pression d'utilisation	6,2 bar
Ø intérieur du tuyau d'air	10 mm
Consommation d'air moyenne	260 l/min
Poids	670 g

g 670 CHF 207.00 1 019330005

1933L

Meuleuse droite longue

• Fournie avec pinces de Ø 3 et 6 mm

CE



Vitesse à vide	25.000 tours/min
Capacité pince	3 - 6 mm
Puissance	0,20 kW
Filetage d'arrivée d'air	1/4" GAS
Pression d'utilisation	6,2 bar
Ø intérieur du tuyau d'air	10 mm
Consommation d'air moyenne	270 l/min
Poids	670 g

g 670 CHF 233.00 1 019330015

1933IL

Meuleuse droite longue

• Fournie avec pinces de Ø 3 et 6 mm

CE



Vitesse à vide	20.000 tours/min
Capacité pince	3 - 6 mm
Puissance	0,38 kW
Filetage d'arrivée d'air	1/4" GAS
Pression d'utilisation	6,2 bar
Ø intérieur du tuyau d'air	10 mm
Consommation d'air moyenne	113 l/min
Poids	1,4 kg

kg 1,4 CHF 283.00 1 019330010

1933AN90

Meuleuse à renvoi d'angle

• Fournie avec pinces de Ø 3 et 6 mm

CE



Vitesse à vide	20.000 tours/min
Capacité pince	3 - 6 mm
Puissance	0,20 kW
Filetage d'arrivée d'air	1/4" GAS
Pression d'utilisation	6,2 bar
Ø intérieur du tuyau d'air	10 mm
Consommation d'air moyenne	230 l/min
Poids	510 g

g 510 CHF 233.00 1 019330020

1934BV

Nettoyeur à basse vitesse

• Fournie avec pinces de Ø 3 et 6 mm

CE



Vitesse à vide	3.700 tours/min
Capacité pince	3 - 6 mm
Puissance	0,37 kW
Filetage d'arrivée d'air	1/4" GAS
Pression d'utilisation	6,2 bar
Ø intérieur du tuyau d'air	10 mm
Consommation d'air moyenne	113 l/min
Poids	0,84 kg

g 840 CHF 252.00 1 019340000



1934MAV

Micro-meuleuse droite

CE



Vitesse à vide	56.000 tours/min
Capacité pince	3 mm
Puissance	0,04 kW
Filetage d'arrivée d'air	1/4" GAS BSPT
Pression d'utilisation	6,2 bar
Ø intérieur du tuyau d'air	4,5 mm
Consommation d'air moyenne	115 l/min
Poids	0,2 kg

kg 205
CHF 215.50
1 019340010

1934MAV70

Micro-meuleuse droite à grande vitesse

CE



Vitesse à vide	70.000 tours/min
Capacité pince	3 mm
Puissance	0,08 kW
Filetage d'arrivée d'air	1/4" GAS BSPT
Pression d'utilisation	6,2 bar
Ø intérieur du tuyau d'air	4,5 mm
Consommation d'air moyenne	115 l/min
Poids	0,21 kg

kg 210
CHF 358.00
1 019340030

1935F

Visseuse pneumatique réversible

1/4

CE



Vitesse à vide	800 tours/min
Champ couple de serrage	4-16 Nm
Capacité vis	6-9 M
Porte-embouts	● 1/4"
Filetage d'arrivée d'air	1/4" GAS
Pression d'utilisation	6,2 bar
Ø intérieur du tuyau d'air	10 mm
Consommation d'air moyenne	150 l/min
Poids	1,3 kg

kg 1,3
CHF 342.00
1 019350045

1936/4A

Meuleuse à renvoi d'angle

CE



Vitesse à vide	11.000 tours/min
Dimension de la meule	115 mm
Puissance	0,66 kW
Filetage de la broche	M14
Filetage d'arrivée d'air	1/4" GAS
Pression d'utilisation	6,2 bar
Ø intérieur du tuyau d'air	10 mm
Consommation d'air moyenne	390 l/min
Poids	1,77 kg

kg 1,8
CHF 564.00
1 019360024

1936/5A

Meuleuse à renvoi d'angle

CE



Vitesse à vide	10.000 tours/min
Dimension de la meule	125 mm
Puissance	0,66 kW
Filetage de la broche	M14
Filetage d'arrivée d'air	1/4" GAS
Pression d'utilisation	6,2 bar
Ø intérieur du tuyau d'air	10 mm
Consommation d'air moyenne	390 l/min
Poids	1,9 kg

kg 1,9
CHF 564.00
1 019360025

1936/7A

Meuleuse à renvoi d'angle

CE



Vitesse à vide	7600 giri/min
Dimension de la meule	180 mm
Puissance	1,3 kW
Filetage de la broche	M14
Filetage d'arrivée d'air	3/8" GAS
Pression d'utilisation	6,2 bar
Ø intérieur du tuyau d'air	13 mm
Consommation d'air moyenne	906 l/min
Poids	2,7 kg

kg 2,7
CHF 826.00
1 019360027



1937

Ponceuse orbitale rotative sans lubrification, en matériau composite

• Diamètre orbite 5 mm



Vitesse à vide	12.000 tours/min
Puissance	0,18 kW
Dimensions du plateau	150 mm
Diamètre orbite	5 mm
Filetage de la broche	5/16"-24
Filetage d'arrivée d'air	1/4" GAS
Pression d'utilisation	6,2 bar
Ø intérieur du tuyau d'air	10 mm
Consommation d'air moyenne	170 l/min
Poids	0,86 kg

kg	CHF		
0,86	595.00	1	019370001

1937R/P

Plateau Ø 150 mm 6 trous pour 1937



1937R/P	CHF		
	62.00	1	019370002

1937KC

Coffret mini ponceuse roto-orbitale

- Diamètre orbite 4 mm
- 2 plateaux de ponçage Ø 50 mm et Ø 75 mm
- 10 disques de papier de verre abrasif Ø 50 mm avec grain 400, 600, 800
- 10 disques de papier de verre abrasif Ø 75 mm avec grain 400, 600, 800



Vitesse à vide	15000 tours/min
Puissance	0,25 kW
Dimensions du plateau	50 - 75 mm
Filetage de la broche	M6 x 1,0
Filetage d'arrivée d'air	1/4" GAZ
Pression d'utilisation	6,2 bars
Ø intérieur du tuyau d'air	10 mm
Consommation d'air moyenne	79 l/min
Poids ponceuse	0,64 kg
Poids kit	1,4 kg

kg	CHF		
1,4	341.00	1	019370171

1937C...

Disques de papier de verre pour 1937KC



Ø mm	P	CHF		
50	400	20.30	1	019370175
50	600	20.30	1	019370176
50	800	20.30	1	019370177
75	400	26.00	1	019370178
75	600	26.00	1	019370179
75	800	26.00	1	019370180

* Les prix indiqués sont pour 10 pièces

1937KL

Mini polisseuse revolver orbitale

- Plateau de polissage Ø 75 mm
- 2 éponges pour lustrer Ø 90mm - 1937/KL-DSB, 1937/KL-DSG
- Laine d'agneau Ø 90 mm - 1937/KL-DLA



Vitesse à vide	3.200 tours/min
Puissance	0,25 kW
Dimensions du plateau	75 mm
Filetage de la broche	M6
Filetage d'arrivée d'air	1/4" GAS BSPT
Pression d'utilisation	6,2 bars
Ø intérieur du tuyau d'air	10 mm
Consommation d'air moyenne	91 l/min
Poids polisseuse	0,75 kg
Poids kit	1,8 kg

kg	CHF		
1,8	371.00	1	019370161

1937KL-D

Accessoires pour 1937KL



	Ø mm	CHF		
1937KL-DLA	90	33.50	1	019370164
1937KL-DSB	90	33.50	1	019370165
1937KL-DSG	90	33.50	1	019370166

1937K...

Plateau pour 1937KC et 1937KL



	Ø mm	1937KC	1937KL	CHF		
1937KC-RP	50	•		36.50	1	019370173
1937KL-RP	75	•	•	44.00	1	019370163

1937M

Ponceuse multifonction avec 16 accessoires



Vitesse à vide	3.500 tours/min
Puissance	0,34 kW
Filetage d'arrivée d'air	1/4" GAS
Pression d'utilisation	6,2 bar
Ø intérieur du tuyau d'air	10 mm
Consommation d'air moyenne	113 l/min
Poids ponceuse	1,5 kg
Poids kit	4,5 kg

kg	CHF		
4,5	1,028.00	1	019370011

458x495x116 mm

1937M-01÷11

Accessoires pour 1937M



	L mm	1937M-	CHF		
1937M-01	30		38.50	1	019370101
1937M-02	30		38.50	1	019370102
1937M-03	11		33.50	1	019370103
1937M-04	23		33.50	1	019370104
1937M-05	11		33.50	1	019370105
1937M-06	23		33.50	1	019370106
1937M-07	16		91.50	1	019370107
1937M-08	13	07	33.50	1	019370108
1937M-09	26	07	33.50	1	019370109
1937M-10	11	03, 05	33.50	1	019370110
1937M-11	23	01, 02, 04, 06	33.50	1	019370111

* Les prix indiqués sont pour 6 pièces

1937N10

Ponceuse à bande



Vitesse à vide	20.000 tours/min
Puissance	0,37 kW
Dimensions de la bande	10x330 mm
Filetage d'arrivée d'air	1/4" GAS
Pression d'utilisation	6,2 bar
Ø intérieur du tuyau d'air	10 mm
Consommation d'air moyenne	374 l/min
Poids	0,9 kg

kg	CHF	
0,9	401.00	1 019370041

1937N10-GR

Bandes abrasives pour 1937N10



	P	CHF	
1937N10-GR60	60	42.00	1 019370146
1937N10-GR80	80	42.00	1 019370148
1937N10-GR100	100	42.00	1 019370150
1937N10-GR120	120	42.00	1 019370152

Les prix indiqués sont pour 10 pièces

1937N20

Ponceuse à bande



Vitesse à vide	16.000 tours/min
Puissance	0,45 kW
Dimensions de la bande	20x520 mm
Filetage d'arrivée d'air	1/4" GAS
Pression d'utilisation	6,2 bar
Ø intérieur du tuyau d'air	10 mm
Consommation d'air moyenne	400 l/min
Poids	1,6 kg

kg	CHF	
1,6	466.00	1 019370051

1937N20-GR

Bandes abrasives pour 1937N20



	P	CHF	
1937N20-GR60	60	55.00	1 019370156
1937N20-GR80	80	55.00	1 019370158
1937N20-GR100	100	55.00	1 019370160
1937N20-GR120	120	55.00	1 019370162

Les prix indiqués sont pour 10 pièces

1938

Couteau vibrant dépose-vitres

• Fourni avec 1 lame droite de 57 mm



Nombre d'oscillations à la minute	20.000
Filetage d'arrivée d'air	1/4" GAS
Pression d'utilisation	6,2 bar
Ø intérieur du tuyau d'air	6,5 mm
Consommation d'air moyenne	200 l/min
Poids	1,0 kg

kg	CHF	
1,0	314.00	1 019380021

1938R/L

Lames pour couteau vibrant dépose-vitres

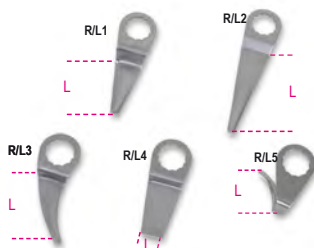

	L mm	CHF	
1938R/L1	57	26.50	1 019380041
1938R/L2	90	49.00	1 019380042
1938R/L3	30	29.50	1 019380043
1938R/L4	8	42.00	1 019380044
1938R/L5	36	48.50	1 019380045

1938R/S5

Jeu de 5 lames pour 1938

kg	CHF	
3,3	196.00	1 019380055

1940

Marteau burineur

• Fourni avec un ressort de retenue et un coupleur rapide à baïonnette pour forets 6 pans



Nombre de coups à la minute	3.500
Dimension de l'emmanchement	Ø 11 mm
Dimension du piston	19 mm
Longueur de la course	67 mm
Filetage d'arrivée d'air	1/4" GAS
Pression d'utilisation	6,2 bar
Ø intérieur du tuyau moyenne	8 mm
Consommation d'air moyenne	240 l/min
Poids	1,9 kg

kg	CHF	
1,9	252.00	1 019400001

1940/C6

Coffret marteau pneumatique avec 5 burins et accessoires

• Pour couper la tôle, les boulons et les corps, enlever les scories de soudage, les rivets, le plâtre et les carreaux
• Assortiment dans une mallette à outils ABS pratique, comprenant:

- 1 marteau à air article 1940
- 1 burin plat article 1940SN
- 1 burin de démolition article 1940ST
- 1 burin à pointe ronde 1940SD
- 1 burin biseauté article 1940SPS
- 1 ciseau à tôle 1940SDT
- 1 élément de ressort anti-retour 1940MT
- 1 support à baïonnette pour burins hexagonaux



Coups par minute	3.500
Emmanchement	Ø 11 mm
dimension du piston	19 mm
longueur de course du piston	67 mm
Entrée d'air	1/4" GAS
Pression de travail	6,2 bar
Taille du tuyau interne (Ø)	8 mm
Consommation moyenne d'air	240 l/min
Weight	3.3 kg

kg	CHF	
3,3	357.00	1 019400000

320x240x90 mm

1940MT

Ressort de retenue pour 1940



1940MT	CHF	16.50	5	019400110
--------	-----	-------	---	-----------

1940S...

Burins pour marteau burineur 1940



1940SN	CHF	20.20	5	019400020
1940ST	CHF	20.20	5	019400021
1940SD	CHF	20.20	5	019400022
1940SPS	CHF	20.20	5	019400023
1940SDT	CHF	20.20	5	019400024

1940/S5

Jeu de 5 burins pour 1940



1940/S5	CHF	91.50	1	019400030
---------	-----	-------	---	-----------

1940E10

Marteau burineur

- Compatible avec burins à entraînement hexagonal de 10 mm
- Fourni avec un ressort de retenue et un coupleur rapide à baïonnette



Nombre de coups à la minute	2.900
Dimension de l'emmanchement	10 mm
Dimension du piston	19 mm
Longueur de la course	67 mm
Filetage d'arrivée d'air	1/4" GAS
Pression d'utilisation	6,2 bars
Ø intérieur du tuyau d'air	10 mm
Consommation d'air moyenne	76 l/min
Poids	1,7 kg

kg	1,7	CHF	278.00	1	019400010
----	-----	-----	--------	---	-----------

1940E10/MT

Ressort de tenue pour 1940E10



1940E10/MT	CHF	2.19	5	019400112
------------	-----	------	---	-----------

1940E10/S...

Burins pour marteau burineur 1940E10



1940E10/SN	CHF	14.00	5	019400040
1940E10/ST	CHF	14.00	5	019400041
1940E10/SD	CHF	14.00	5	019400042
1940E10/SPS	CHF	14.00	5	019400043
1940E10/SDT	CHF	14.00	5	019400044

1940E10/S5

Jeu de 5 burins pour marteau burineur 1940E10



1940E10/S5	CHF	70.00	1	019400050
------------	-----	-------	---	-----------

1942A

Scie alternative



Nombre de cycles par minute	10.000
Longueur de la course	10 mm
Filetage d'arrivée d'air	1/4" GAS BSP
Pression d'utilisation	6,2 bar
Ø intérieur du tuyau d'air	8 mm
Consommation d'air moyenne	75 l/min
Poids	550 g

g	550	CHF	419.00	1	019420000
---	-----	-----	--------	---	-----------

1942LR

Lames Bimétal pour scie alternative 1942A



1942LR	CHF	9.75	5	019420032
--------	-----	------	---	-----------

1944A

Dérouilleur à aiguilles axial

CE



Nombre de coups à la minute	3.800
Course du piston	33 mm
N°. aiguilles	19
Ø aiguille	3 mm
Filetage d'arrivée d'air	1/4" GAS
Pression d'utilisation	6,2 bar
Ø intérieur du tuyau d'air	10 mm
Consommation d'air moyenne	85 l/min
Poids	2,8 kg

kg	2,8	CHF	472.00	1	019440011
----	-----	-----	--------	---	-----------

1944N

Dérouilleur à aiguilles

CE



Nombre de coups à la minute	3800
Corse du piston	33 mm
N°. aiguilles	19
Ø aiguille	3 mm
Filetage d'arrivée d'air	1/4" GAS
Pression d'utilisation	6,2 bar
Ø intérieur du tuyau d'air	8 mm
Consommation d'air moyenne	85 l/min
Poids	2,7 kg

kg	2,7	CHF	604.00	1	019440002
----	-----	-----	--------	---	-----------

1944AR

Jeu de aiguilles pour 1944N et 1944A



1944AR 2	CHF	62.00	1	019440015
1944AR 3	CHF	48.50	1	019440005

1944PA

Plaques porte-aiguilles pour 1944N et 1944A



	Ø mm	N.	CHF		
1944PA 2	2	29	68.00	1	019440016
1944PA 3	3	19	52.00	1	019440006

1945S

Agrafeuse

• Utilise des agrafes type 80, section 0,95 x 0,65 mm (21 Gauge), longueur 4 - 16 mm, largeur 12,8 mm



Capacité du chargeur 157 pces
 Filetage d'arrivée d'air 1/4" GAS
 Pression d'utilisation 4,2 - 7 bar
 Ø intérieur du tuyau d'air 8 mm
 Consommation d'air (7 bar) 0,34 l/cycle
 Poids 0,87 kg

kg	CHF		
0,9	257.00	1	019450000

1945S/G...

Agrafes type 80, section 0,95x0,65 mm (21 Gauge), largeur 12,8 mm, pour 1945S

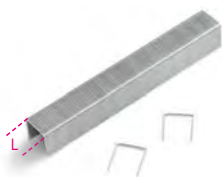

	L mm	CHF		
• 1945S/G 4	4	23.90	1	019450004
1945S/G 6	6	9.45	1	019450006
1945S/G 8	8	10.20	1	019450008
1945S/G 10	10	11.40	1	019450010
1945S/G 12	12	12.80	1	019450012
1945S/G 14	14	13.80	1	019450014
1945S/G 16	16	15.10	1	019450016

Les prix indiqués sont pour 5.000 pièces
 • Les prix indiqués sont pour 10.000 pièces

1945C

Agrafeuse-cloueuse

• Utilise des agrafes type 90 section 1,25 x 1,0 mm (18 Gauge), longueur 16-40 mm, largeur 5,8 mm
 • Utilise des clous type B12 section 1,25 x 1,0 mm (18 Gauge), tête de 1,9 mm



Capacité du chargeur 100 pces
 Filetage d'arrivée d'air 1/4" GAS
 Pression d'utilisation 5 - 8 bar
 Ø intérieur du tuyau d'air 8 mm
 Consommation d'air (7 bar) 1,12 l/cycle
 Peso 1,16 kg

kg	CHF		
1,16	339.00	1	019450200

1945C/G...

Agrafes type 90, section 1,25x1,0 mm (18 Gauge), longueur 5,8 mm, pour 1945C

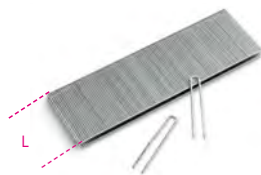

	L mm	CHF		
1945C/G 16	16	18.20	1	019450216
1945C/G 19	19	21.50	1	019450219
1945C/G 22	22	23.60	1	019450222
1945C/G 25	25	27.50	1	019450225
1945C/G 28	28	29.00	1	019450228
1945C/G 32	32	34.00	1	019450232
1945C/G 35	35	36.50	1	019450235
1945C/G 38	38	41.00	1	019450238
1945C/G 40	40	43.50	1	019450240

Les prix indiqués sont pour 10.000 pièces

1945C/GP...

Clous type B12, section 1,25x1,0 mm (18 Gauge), tête de 1,9 mm, pour 1945C

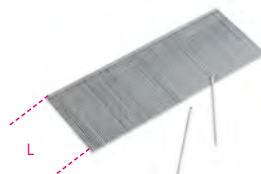

	L mm	CHF		
1945C/GP 15	15	9.55	1	019450255
1945C/GP 16	16	9.90	1	019450256
1945C/GP 20	20	11.40	1	019450260
1945C/GP 25	25	13.40	1	019450265
1945C/GP 30	30	15.60	1	019450270
1945C/GP 32	32	17.20	1	019450272
1945C/GP 35	35	18.50	1	019450275
1945C/GP 38	38	20.00	1	019450278
1945C/GP 40	40	20.60	1	019450280
1945C/GP 45	45	22.80	1	019450285
1945C/GP 50	50	25.00	1	019450290

Les prix indiqués sont pour 10.000 pièces



1945P

Aiguilleur micropin/minibrad sans tête

• Utilise des pointeaux type B6, Ø 0,64 mm (23 Gauge), longueur 12 - 35 mm



Capacité du chargeur 145 pces
 Filetage d'arrivée d'air 1/4" GAS
 Pression d'utilisation 4 - 7 bar
 Ø intérieur du tuyau d'air 8 mm
 Consommation d'air (7 bar) 0,27 l/cycle
 Poids 0,87 kg

kg	CHF		
0,87	410.00	1	019450100

1945P/S...

Pointeaux type B6, Ø 0,64 mm (23 Gauge), pour 1945P



	L mm	CHF		
1945P/S 12	12	11.20	1	019450112
1945P/S 15	15	12.20	1	019450115
1945P/S 18	18	13.30	1	019450118
1945P/S 20	20	15.40	1	019450120
1945P/S 21	21	15.60	1	019450121
1945P/S 22	22	16.10	1	019450122
1945P/S 25	25	17.20	1	019450125
1945P/S 30	30	19.70	1	019450130
1945P/S 35	35	22.50	1	019450135

Les prix indiqués sont pour 10.000 pièces



1946

Riveteuse

- Livrée avec des buses interchangeables de 2,4-3,2-4,0-4,8 mm

CE



Puissance de traction	8000 N
Longueur de la course	14 mm
Capacité maximum	Ø rivets aluminium 4,8 mm
Filetage d'arrivée d'air	1/4" GAS
Pression d'utilisation	6,2 bar
Ø intérieur du tuyau d'air	6 mm
Consommation d'air moyenne	1,2 l/ciclo
Poids	1,5 kg

kg	CHF	1	019460001
1,5	255.00		

1946C4,8

Riveteuse

- Aspiration automatique
- Fournie assemblée pour rivets en acier, acier inoxydable, aluminium et cuivre, de 2,4 - 3,2 - 4,0 - 4,8 mm

CE



Puissance de traction	8.900 N
Longueur de la course	15 mm
Capacité maximum rivets	Ø acier inoxydable 4,8 mm
Filetage d'arrivée d'air	1/4" GAS
Pression d'utilisation	6,2 bar
Ø intérieur du tuyau d'air	10 mm
Consommation d'air	2,6 l/cycle
Poids	1,5 kg

kg	CHF	1	019460006
1,5	796.00		

1946C7,8

Riveteuse

- Aspiration automatique
- Fournie assemblée pour rivets en acier, acier inoxydable, aluminium et cuivre, de 4,8 - 5,6 - 6,4 - 7,8 mm

CE



Puissance de traction	16.900 N
Longueur de la course	22,5 mm
Capacité maximum rivets	Ø acier inoxydable 7,8 mm
Filetage d'arrivée d'air	1/4" GAS
Pression d'utilisation	6,2 bar
Ø intérieur du tuyau d'air	10 mm
Consommation d'air	4,9 l/cycle
Poids	1,8 kg

kg	CHF	1	019460008
1,8	1.255.00		

1946C/T...

Têtes pour rivets structurels



	Ø mm	CHF	1	019460016
1946C/T4,8	4,8	48.50		
1946C/T6,4	6,4	48.50		

1946KF

Riveteuse pour embouts filetés

- Fournie assemblée pour rivets filetés en acier, acier inox, aluminium et cuivre, M4, M5, M6, M8

CE



Puissance de traction	14.235 N
Longueur de la course	7 mm
Capacité maximum rivets	Ø acier inoxydable M8
Filetage d'arrivée d'air	1/4" GAS
Pression d'utilisation	6,2 bar
Ø intérieur du tuyau d'air	10 mm
Consommation d'air	2,1 l/cycle
Poids riveteuse	2,1 kg
Poids kit	3,4 kg

kg	CHF	1	019460012
3,4	2.640.00		

1946KF/M...

Embouts de rechange pour 1946KF



	CHF	1	019460124
1946KF/M4	88.50		
1946KF/M5	88.50		
1946KF/M6	88.50		
1946KF/M8	85.00		

1947

Pistolet à silicone

- Pistolet pneumatique pour silicones, colles et scellants moyenne densité
- Prise en charge cartouches standard (210 x 50 mm) dures et souples

CE



Dimension du tuyau	210x50 mm
Capacité de la cartouche	350 ml
Filetage d'arrivée d'air	1/4" GAS
Pression d'utilisation	4,8 bars
Ø intérieur du tuyau d'air	10 mm
Consommation d'air moyenne	120 l/min
Poids	1,1 kg

kg	CHF	1	019470001
1,1	89.00		

1947H

Pistolet à silicone

- Pistolet pneumatique pour l'extrusion de silicones et mastics en cartouches standard plastique ou métal
- Prise en charge cartouches standard (215/218 x 50/51 mm) dures et souples
- Flux du matériel contrôlé par la gâchette
- Réducteur de pression intégré

CE



Dimension du tuyau	210x50 mm
Capacité de la cartouche	300/310 ml
Filetage d'arrivée d'air	1/4" GAS
Pression d'utilisation	4 ÷ 8 bars
Ø intérieur du tuyau d'air	2,5 mm
Consommation d'air moyenne	120 l/min
Poids	750 g

g	CHF	1	019470011
750	311.00		

Beta

1947G

Pistolet de graissage pneumatique

Tête moulée sous pression en aluminium
 Manche ergonomique avec partie saillante pour atteindre les espaces restreints
 Vanne en cuivre pour une longue durée
 Fonctionne avec cartouches de 400 g ou graisse en vrac jusqu'à 500 cc
 Dimensions du tuyau : 54 (interne) x 260 mm
 Filetage d'arrivée d'air: 1/4" GAZ
 Pression d'utilisation: 4+10 bars
 Poids: 1,9 kg



1947G **CHF** 219.50 1 019470051

1947G2

Pistolet de graissage 2 en 1

Pour distribution progressive ou continue de la graisse
 Tête moulée sous pression en aluminium
 Manche ergonomique
 Fonctionne avec cartouches de 400 cc ou graisse en vrac jusqu'à 500 cc
 Dimensions du tuyau : 54 (interne) x 260 mm
 Filetage d'arrivée d'air : 1/4" GAZ
 Pression d'utilisation : 3+10 bars Poids : 1,9 kg



Dimensions du tuyau 54 (interne) x 276 mm
 Filetage d'arrivée d'air 1/4" GAS BSP
 Pression d'utilisation 3+10 bar
 poids 2,2 kg

1947G2 **CHF** 225.50 1 019470060

1948

Crayon à graver

• Il peut graver les matériaux comme l'acier, l'acier inoxydable, l'aluminium, le verre, la pierre et la céramique



Nombre de coups à la minute 3.500 ÷ 3.800
 Dureté maximum 60 HRC
 Filetage d'arrivée d'air 1/4" GAS
 Pression d'utilisation 6,2 bars
 Consommation d'air moyenne 50 l/min
 Poids 150 g

150 **CHF** 412.00 1 019480001

1948PR

Pointe de rechange au carbure de tungstène pour 1948

• Dureté maximum : 60 HRC



1948PR **CHF** 155.50 1 019480005

1949XS

Soufflette stylo progressive

• Fabriquée en alliage léger
 • Débit d'air réglable en tournant la tête du stylo



Filetage 1/4" GAS
 Pression d'utilisation 3-8 bar
 Pression maximale d'utilisation 10 bar
 Température d'utilisation de -20 °C à 70 °C
 Poids 20 g

20 **CHF** 8.85 25 019490025

1949U5

Soufflette progressive avec 5 buses

• Corps en matériau composite à haute résistance, antichoc
 • 3 buses en acier 100/160/320 mm avec embout de protection en caoutchouc anti-rayures
 • 1 buse "Turbo" en nylon renforcé avec fibres de verre et embout de sécurité
 • 1 buse orientable 100 mm nylon renforcé avec fibres de verre
 • Doté de système de fixation rapide



Embout cuivre fileté 1/4" GAS
 Pression d'utilisation 10 bar
 Pression d'utilisation maximum 15 bar
 Consommation d'air moyenne 280 l/min
 Température d'utilisation -10°C ÷ 85°C
 Poids 93 g

93 **CHF** 49.00 1 019490030

1949U5/A

Buse en acier 100 mm avec embout de protection en caoutchouc anti-rayures pour 1949U5 - 1949P



1949U5/A **CHF** 9.90 1 019490131

1949U5/B

Buse en acier 160 mm avec embout de protection en caoutchouc anti-rayures pour 1949U5 - 1949P



1949U5/B **CHF** 10.10 1 019490132

1949U5/C

Buse en acier 320 mm avec embout de protection en caoutchouc anti-rayures pour 1949U5 - 1949P



1949U5/C **CHF** 12.90 1 019490133

1949U5/D

Buse pivotante 100 mm en nylon renforcé de fibres de verre pour 1949U5 - 1949P



1949U5/D **CHF** 9.45 1 019490134

1949U5/E

Buse "Turbo" en nylon renforcé avec fibres de verre avec embout de sécurité



CHF 4.65 1 019490135

1949U5/F

Buse à éventail plate, en nylon renforcé avec fibres de verre, pour 1949U5 et 1949P



CHF 5.95 1 019490136

1949U5/G

Buse OSHA, en nylon renforcé avec fibres de verre, pour 1949U5 et 1949P



CHF 4.45 1 019490137

1949BC

Soufflette progressive avec buse en caoutchouc

- Corps en matériau composite haute résistance, antichoc
- Buse en caoutchouc anti-éraflure, remplaçable

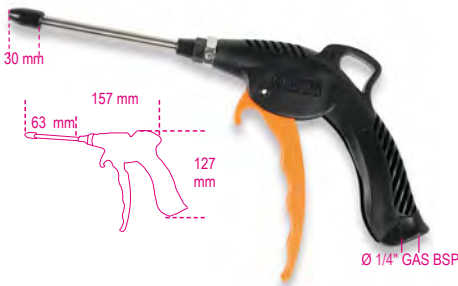

Embout aluminium fileté 1/4" GAS
 Pression d'utilisation 6-8 bar
 Pression d'utilisation maximum 15 bar
 Consommation d'air moyenne 87 l/min
 Température d'utilisation -20°C ÷ 70°C
 Poids 120 g

CHF 24.10 1 019490022

1949BC/RUL

5 buses longues en caoutchouc, pour la soufflette 1949BC



CHF 29.50 1 019490123

1949P

Mini soufflette progressive

- Corps en matériau composite à haute résistance, antichoc
- Système de fixation rapide des buses
- Flux d'air réglable par rotation de l'écrou



Embout cuivre fileté 1/4" GAS
 Pression d'utilisation 6-8 bar
 Pression d'utilisation maximum 15 bar
 Consommation d'air moyenne 280 l/min
 Température d'utilisation -10°C ÷ 85°C
 Poids 70 g

CHF 31.50 1 019490031

1949T

Soufflette progressive télescopique

- Corps en matériau composite haute résistance, antichoc
- Tube télescopique en acier orientable : 165 mm ÷ 300 mm

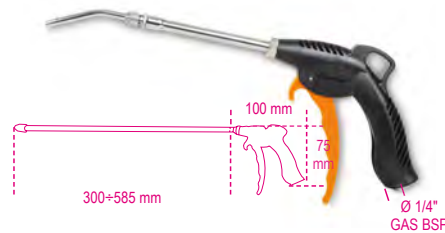

Embout aluminium fileté 1/4" GAS
 Pression d'utilisation 6-8 bar
 Pression d'utilisation maximum 15 bar
 Consommation d'air moyenne 144 l/min
 Température d'utilisation -20°C ÷ 70°C
 Poids 190 g

CHF 38.50 1 019490040



1949F2

Soufflette progressive

- En matière plastique composite haute résistance, antichoc, antiéraflure et isolé thermiquement
- La soupape spéciale et la sensibilité du levier assurent une ouverture progressive du circuit et une optimisation du flux de l'air
- Embout équipé d'un cône de sécurité en plastique pour une manipulation en toute sécurité lorsqu'il n'est pas utilisé



Embout cuivre fileté 1/4" GAS
 Pression d'utilisation 4-8 bar
 Pression d'utilisation maximum 12 bar
 Température d'utilisation -20°C ÷ 70°C
 Poids 125 g

CHF 22.30 1 019490028

1949GPA

gonfleur de pneus

- Corps enduit de caoutchouc antichoc
- levier de commande métallique
- pression de service: 0,5÷12 bar, 7÷174 psi
- fonction de relâchement de pression
- fonction de mesure de pression
- longueur du tuyau: 58 cm
- Rotation du tuyau à 360°
- Entrée d'air 1/4 »



CHF 142.50 1 019490018



1949DGT/2

gonfleur de pneu numérique

- corps enduit de caoutchouc antichoc
- levier de commande métallique
- pression de service: 0,5÷12 bar, 7÷174 psi
- 4 unités de mesure, bar/psi/kpa/kgf
- écran LCD rétroéclairé
- résolution: 0.05 bar
- auto-mise hors tension après 1,5 minute
- longueur du tuyau: 58 cm
- Rotation du tuyau à 360°
- alimentation: 2 piles AAA
- Entrée d'air 1/4 »



CE

L=560 mm
 Ø 1/4" GAS BSP
 bar psi
 1949DGT/2 0,5÷12 7÷174
 CHF 170.50 1 019490021

1949GPN

Pistolet pour gonflage de pneus corps en ABS

- Manomètre certifié CE avec échelle 0,7÷12 bar (gradins par 1/10e bar)
- Les deux boutons servo-assistés permettent de gonfler (+) et dégonfler (-) le pneu avec précision et rapidité
- Fourni avec certificat d'étalonnage
- Livré avec coquille de protection antichoc et embout d'attelage
- Fourni avec raccord fileté 1/4" GAZ
- Prise d'air pivotante pour tuyau en caoutchouc Ø 7 mm

CE



245 mm
 Ø 4 mm
 L=1500 mm
 bar g
 1949GPN 0,7÷12 810
 CHF 283.00 1 019490011

1949M

Pistolet de gonflage pneumatique



L=350mm
 60 mm
 bar psi g
 1949M 0÷4 5÷60 280
 CHF 100.00 1 019490400

1949R

Soufflette pour nettoyer les radiateurs

Equipée de 5 trous perpendiculaires à la poignée permettant d'éliminer la saleté des radiateurs



L mm
 600
 mm
 6
 CHF 90.00 1 019490050

1950BZK

Talonneur à pneus

- La poignée secondaire activée par un bouton permet de ne jamais lâcher l'outil pendant l'utilisation
- Capacité du réservoir : 18 litres
- Pression de fonctionnement : 3-8 bars
- Pression maximale du réservoir : 16 bars
- Soupape de sécurité pour surpression
- Manomètre avec échelle graduée
- Embout en plastique pour éviter d'abîmer la jante

CE



CHF 413.00 1 019500078



1951

Pistolet de lavage

- Indiqué pour le nettoyage de tapisserie d'auto, moquette, sièges et coffres



Vitesse à vide
 Capacité réservoir 1 L
 Filetage d'arrivée d'air 1/4" GAS
 Pression d'utilisation 6,2 bar
 Ø intérieur du tuyau d'air 8 mm
 Consommation d'air moyenne 110 l/min
 Poids 650 g

g
 650
 CHF 193.50 1 019510051

1951A

Pistolet de lavage avec aspiration

- Indiqué pour le nettoyage de tapisserie d'auto, moquette, sièges et coffres
- À utiliser avec les détergents prévus à cet effet
- Réservoir de 1 l
- Équipé de robinet pour le réglage de la sortie du liquide contenu dans le réservoir
- Fourni avec tuyau ondulé de 1,8 m



Capacité réservoir 1 l
 Filetage d'arrivée d'air 1/4" GAS
 Pression d'utilisation 6,2 bars
 Ø intérieur du tuyau d'air 8 mm
 Consommation d'air moyenne 120 l/min
 Poids 800 g

g
 800
 CHF 314.00 1 019510101

1952

Pistolet de vernissage professionnel

- Corps en aluminium moulé sous pression avec traitement de protection en nickel chimique noir.
- Godet en nylon avec dispositif ramasse-goutte, filet 3/8M BSP.
- Filetage sur le corps 1/4" BSP Gaz cylindrique.
- Régulateur de pression et de débit d'air.
- Régulateur du jet, de rond à éventail.
- Régulateur de la quantité de vernis.
- Fourni avec clé de service pour la maintenance.

CE



Ø mm	CHF	1	019520012
1952 1,2	1,2	207.00	1 019520012
1952 1,5	1,5	207.00	1 019520015
1952 1,8	1,8	207.00	1 019520018
1952 2,0	2,0	207.00	1 019520020

1900S

enrouleur automatique de tuyau à ressort, corps en plastique antichoc, pour une utilisation avec de l'air ou de l'eau

- pression de service max. : 15 bar
- tuyau en polyuréthane tressé
- cadre en polypropylène
- dispositif de fixation automatique du tuyau à la longueur requise
- le mécanisme de rack peut être désactivé pour garder le tuyau tiré
- plage de température de fonctionnement: -5 °C / +50 °C
- fourni avec un support pivotant à 180° et un support de connexion rapide supplémentaire

CE



D1xD mm	L m	Ø GAS BSP	CHF	1	019000080
1900S 8X10	8x12	1/4"	220.00	1	019000080

1900M

enrouleur de tuyau à ressort automatique, corps en plastique antichoc, à utiliser avec de l'air ou de l'eau

- pression de service max. : 15 bar
- tuyau en polyuréthane tressé
- cadre en polypropylène
- dispositif de fixation automatique du tuyau à la longueur requise
- le mécanisme de rack peut être désactivé pour garder le tuyau tiré
- plage de température de fonctionnement: -5 °C / +50 °C
- fourni avec un support pivotant à 180° et un support de connexion rapide supplémentaire

CE



D1xD mm	L m	Ø GAS BSP	CHF	1	019000085
1900M 8X15	8x12	15 1/4"	301.00	1	019000085
1900M 10X15	10x14	15 3/8"	314.00	1	019000115

1914

Tuyau spiralé en polyuréthane 98 Shore, extensible

- Pression d'utilisation maximum 12 bars



L m	D1xD mm	Ø GAS BSP	CHF	1	019140054
4	5x8	1/4"	33.00	1	019140054
6	5x8	1/4"	38.50	1	019140056
10	5x8	1/4"	49.00	1	019140060

1915B

Tuyau spiralé en polyuréthane 95 Shore, extensible sur 9 m

- Pression d'utilisation maximum 10 bars

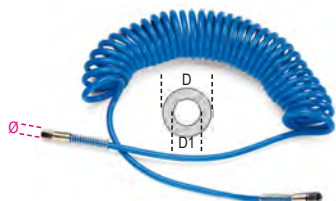

D1xD mm	Ø GAS BSP	CHF	1	019150011
6,5x10	1/4"	56.50	1	019150011
8x12	1/4"	67.50	1	019150012

1915C

Tuyau spiralé en polyuréthane 95 Shore, extensible sur 12 m

- Pression d'utilisation maximum 10 bars

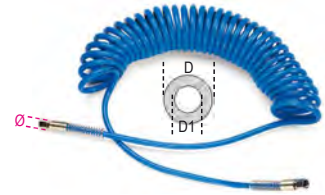

D1xD mm	Ø GAS BSP	CHF	1	019150014
6,5x10	1/4"	67.50	1	019150014
8x12	1/4"	83.00	1	019150015

1915C/L

Tuyau spiralé en polyuréthane 95 Shore, extensible sur 15 m

- Pression d'utilisation maximum 10 bars



D1xD mm	Ø GAS BSP	CHF	1	019150115
8x12	1/4"	106.50	1	019150115
11x16	3/8"	180.50	1	019150116

1915D

Tuyau en polyuréthane armé 95 Shore, longueur 9 m

- Pression d'utilisation maximum 15 bars



D1xD mm	Ø GAS BSP	CHF	1	019150017
8x12	1/4"	67.50	1	019150017

1915E

Tuyau en polyuréthane armé 95 Shore, longueur 12 m

- Pression d'utilisation maximum 15 bars



D1xD mm	Ø GAS BSP	CHF	1	019150019
8x12	1/4"	89.00	1	019150019
11x16	3/8"	133.50	1	019150020

1915E/XL

Bobine en polyuréthane armé 95 Shore, longueur 50 m

• Pression d'utilisation maximum 15 bars



D1xD mm	Ø GAS BSP	CHF		
8x12	1/4"	307.00	1	019150519
11x16	3/8"	513.00	1	019150520

1916I

Embout rapide profil Italien, filetage mâle, embout cylindrique BSP



Ø GAS BSP	CHF		
1/4"	3.90	5	019160001
3/8"	4.40	5	019160002

1916G

Embout rapide profil Européen, filetage mâle, embout conique BSPT



Ø GAS BSPT	CHF		
1/4"	3.90	5	019160005
3/8"	5.15	5	019160010
1/2"	5.70	5	019160012

1916GF

Embout rapide profil Italien, filetage femelle, embout cylindrique BSP



Ø GAS BSP	CHF		
1/4"	3.90	5	019160055
3/8"	4.40	5	019160060

1916GFE

Embout rapide profil Européen, filetage femelle, embout conique BSPT



Ø GAS BSPT	CHF		
1/4"	3.90	5	019160075
3/8"	5.15	5	019160082
1/2"	5.70	5	019160084

1916JM

Embout rapide profil Asiatique, filetage mâle, embout conique BSPT



Ø GAS BSPT	CHF		
1/4"	5.45	1	019160406
3/8"	5.70	1	019160410

1916JF

Embout rapide profil Asiatique, filetage femelle, embout cylindrique BSP



Ø GAS BSPT	CHF		
1/4"	5.45	1	019160456
3/8"	5.70	1	019160460

1916P

Embout rapide profile Italien avec masque tuyau



D1xD mm	CHF		
6x14	5.15	5	019160256
8x17	5.50	5	019160258
10x19	7.45	5	019160260

1916S

embout rapide profile Italien avec ressort spirale

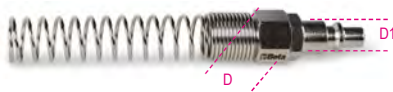

D1xD mm	CHF		
6x8	5.15	5	019160306
8x10	5.45	5	019160308
10x12	6.95	5	019160310

1917M

Raccord universel à billes avec manchon antichoc, filetage mâle, embout cylindrique BSP

• Accouplable à les embouts 1916I et 1916G



Ø GAS BSP	CHF		
1/4"	14.00	5	019170001
3/8"	14.00	5	019170003
1/2"	15.00	5	019170004

1917F

Raccord universel à billes avec manchon antichoc, filetage femelle, embout cylindrique BSP

• Couplage à les embouts 1916I et 1916G



Ø GAS BSP	CHF		
1/4"	14.50	5	019170005
3/8"	14.00	5	019170010
1/2"	15.50	5	019170014

1917JM

Raccord universel à billes pour profil Asiatique, filetage mâle, embout cylindrique BSP



Ø GAS BSP	CHF		
1/4"	23.30	1	019170406
3/8"	23.30	1	019170410
1/2"	25.00	1	019170412

1917JF

Raccord à billes pour profil Asiatique, filetage femelle, embout cylindrique BSP



Ø GAS BSP	CHF		
1/4"	23.30	1	019170456
3/8"	23.30	1	019170460

1917RG

Raccord tournant universel

- En aluminium, filetage femelle, embout cylindrique BSP, filetage mâle, embout cylindrique BSP
- Couplage à tous les embouts avec profil Italien et Européen
- Rotation libre même en absence d'air connecté



Ø GAS BSP	CHF		
1/4"	30.50	1	019170252

1917SP

Raccord universel à billes avec masque tuyau



D1xD mm	CHF	5	019170206
6x14	15.00	5	019170206
8x17	15.60	5	019170208
10x19	17.90	5	019170210

1917ST

Raccord universel à billes avec ressort spirale



D1xD mm	CHF	5	019170306
6x8	14.00	5	019170306
8x10	14.10	5	019170308
10x12	16.00	5	019170310

1918

Raccord cannelé, filetage mâle



D1 mm	Ø GAS BSP	CHF	3	019180106
6	1/8"	3.15	3	019180106
8	1/8"	3.15	3	019180108
6	1/4"	3.40	3	019180116
8	1/4"	3.60	3	019180118
10	1/4"	3.60	3	019180120
10	3/8"	4.10	3	019180130
12	3/8"	4.20	3	019180132
10	1/2"	5.60	3	019180140
12	1/2"	5.70	3	019180142

1918N

Barrette de connexion avec filetage conique BSPT



Ø GAS	Ø1 GAS	CHF	5	019180300
1/4"	1/4"	3.60	5	019180300
3/8"	3/8"	4.20	5	019180310
1/2"	1/2"	5.70	5	019180320



1918R

Barrette de réduction avec filetage conique BSPT



Ø GAS	Ø1 GAS	CHF	5	019180200
1/4"	3/8"	4.10	5	019180200
3/8"	1/2"	5.60	5	019180210

1919FE1/4

Filtre régulateur lubrificateur



Filetages d'arrivée d'air	1/4" GAS BSPT
Filetage du manomètre	1/8" GAS BSPT
Débit maximum	750 l/min
Pression d'entrée maximum	9,5 bar
Pression d'utilisation	0,5 - 8,5 bar
Température d'utilisation	5 - 60 °C
Capacité de filtrage	5 micron
Capacité cuves	15 cl air / 25 cl huile
Poids	700 g

g	CHF	1	019190200
700	140.50	1	019190200

1919RB-FE1/4

Paire de cuves de recharge pour 1919FE1/4



CHF	1	019190210
30.50	1	019190210

1919RF-FE1/4

Élément filtrant de rechange pour 1919FE1/4



CHF	1	019190230
8.30	1	019190230

1919RM-FE1/4

Manomètre de rechange pour 1919FE1/4



CHF	1	019190220
18.00	1	019190220

1919F1/4

Filtre régulateur lubrificateur



Filetages d'arrivée d'air	1/4" GAS BSPT
Débit maximum	1000 l/min
Pression d'entrée maximum	9,5 bar
Pression d'utilisation	0,5 - 8,5 bar
Température d'utilisation	5 - 60 °C
Capacité de filtrage	5 µm
Capacité cuves	60 cl air / 90 c huile
Poids	1,3 kg

kg	CHF	1	019190250
1,3	221.50	1	019190250



1919F3/8

Filtre régulateur lubrificateur



Filetages d'arrivée d'air 3/8" GAS BSPT
 Débit maximum 1350 l/min
 Pression d'entrée maximum 9,5 bar
 Pression d'utilisation 0,5 - 8,5 bar
 Température d'utilisation 5 - 60 °C
 Capacité de filtrage 5 µm
 Capacité cuves 60 cl air / 90 cl huile
 Poids 1,3 kg

kg 1,3 CHF 221.50 1 019190350

1919F1/2

Filtre régulateur lubrificateur



Filetages d'arrivée d'air 1/2" GAS BSPT
 Débit maximum 2500 l/min
 Pression d'entrée maximum 9,5 bar
 Pression d'utilisation 0,5 - 8,5 bar
 Température d'utilisation 5 - 60 °C
 Capacité de filtrage 5 µm
 Capacité cuves 60 cl air / 90 cl huile
 Poids 1,3 kg

kg 1,3 CHF 221.50 1 019190450

1919RB-F

Paire de cuves pour filtres 1919F - 1/4", 3/8" et 1/2"



CHF 39.00 1 019190510

1919RF-F

Élément filtrant de rechange pour 1919F - 1/4", 3/8" et 1/2"



CHF 15.50 1 019190530

1919RM-F

Manomètre de rechange pour filtres 1919F - 1/4", 3/8" and 1/2"



CHF 23.20 1 019190520

1919ML

Mini-lubrificateur



Ø	L	Ø	CHF		
1/4"	63	36	28.50	1	019190030
3/8"	63	36	31.00	1	019190032

1919SC

Mini-séparateur de condensation



Ø	L	Ø	CHF		
1/4"	80	40	36.50	1	019190035

1919L

Huile lubrifiante ISO 32

Densité à 20°C
 Viscosité à 40°C
 Inflammabilité COC

875 Kg/m³
 32 cSt
 210°C



cc 500 CHF 25.00 5 019190050

SACOCHE ET SACS À DOS EN TISSU TECHNIQUE

- **FONCTIONNEL**
- **ROBUSTE**
- **LONGÉVITÉ**

Ce sont les trois caractéristiques de la gamme de sacs en tissu technique de Beta. Les sacoches et les sacs à dos de Beta sont fabriqués dans un tissu technique robuste, résistant à l'abrasion et à l'usure, avec des fonds et des coutures renforcés, se traduisant par une fiabilité et une longévité. Chaque sacoches présente des caractéristiques particulières, conçues pour différentes applications en optimisant l'espace (poches zippées, poignées télescopiques, protège-roues, bretelles renforcées, et pochettes transparentes pour documents ne sont que quelques-unes des particularités de chaque sac et sac à dos.) Un soin minutieux des détails, la variété et une attention particulière au transport des outils en toute sécurité rendent ces produits adéquats pour chaque métier.



VALISES À OUTILS EN POLYPROPYLÈNE

Beta propose une large gamme de valises techniques répondant à tous les besoins ! Les valises à outils et les trolleys de Beta sont fabriqués à partir de polypropylène robuste, épais, antichoc et résistant à la corrosion, conçu pour résister à une utilisation intensive (par exemple à basse température). Choisissez le produit qui correspond le mieux à vos exigences de travail parmi



le chariot classique, à roulettes, équipé de serrures TSA pour un déplacement en toute sécurité, la version aluminium ou étanche. La plupart des valises et trolleys Beta sont également disponibles avec des assortiments d'outils répondant à différents domaines d'applications : électronique, hydraulique, nautisme et maintenance.

2001/B26

Trousse en tissu avec 26 outils



2001/B26 **CHF 301.00** 1 020010215

55 6x7 - 8x9 - 10x11 - 12x13 - 14x15 - 16x17 mm
 96N/SC9 1,5 - 2 - 2,5 - 3 - 4 - 5 - 6 - 8 - 10 mm
 1128BMX 145 mm
 1150 180 mm
 1201E 3x75 - 4x100 - 5,5x150 mm
 1202E PH1x80 - PH2x100 mm
 1370 300 g
 1692 2 m
 1770A 9 mm

2001/BV **CHF 70.00** 1 020010051

2001/BZV

trousse en tissu technique vide

- Double poignée supérieure pour une confort optimal
- Grande poche avant pour documents avec fermeture éclair
- Bande velcro à l'arrière, pour fixer la valise à outils à la poignée du chariot
- 20 compartiments à outils pratiques (6 poches et 14 bandes élastiques)
- Boucles pour marteau
- La bandoulière C9 / RT peut également être incluse (vendue séparément)



2001/BZV **CHF 64.00** 1 020010151

380x290x60 mm - 675 g



2001/BZ24 MQ

trousse en tissu technique avec assortiment de 24 outils pour électriciens



2001/BZ24 MQ CHF 439.00 1 020010154

	n.
1128BMX	1
1150MQ	180 mm
42	8-10-13-17-19 mm
1274MQ	3x100 - 4x100 - 5,5x125 mm
1272MQ	PH0x60 - PH1x80 - PH2x100 mm
96BP/SC9	1,5-2-2,5-3-4-5-6-8-10 mm
1253	
1082MQ	160 mm

2001/BZ27 VU

trousse en tissu technique avec assortiment de 27 outils pour la maintenance générale



2001/BZ27 VU CHF 355.00 1 020010157

	n.
1128BMX	1
1150	180 mm
42	7-8-10-13-17-19 mm
1201E	3x75 - 4x100 - 5,5x150 mm
1202E	PH0x60 - PH1x80 - PH2x100 mm
96/SC9	1,5-2-2,5-3-4-5-6-8-10 mm
1370	300 g
1048N	250 mm
1692/5	5 m
1771	18 mm

2002/BV6

Portefeuille d'outils enroulable en polyester durable, vide

- Avec 6 compartiments à outils pratiques et de tailles différentes
- La poignée centrale en tissu renforcé facilite le transport
- Avec rabat intérieur empêchant les outils de sortir
- Coutures de renforcement dans tout le périmètre du portefeuille
- Double fermeture velcro
- Dimensions à l'ouverture : 175 x 240 mm



2002/BV6 CHF 11.30 1 020020000

2002/BVL6

Portefeuille d'outils enroulable en polyester durable, vide

- Avec 6 compartiments à outils pratiques et de tailles différentes
- La poignée centrale en tissu renforcé facilite le transport
- Avec rabat intérieur empêchant les outils de sortir
- Coutures de renforcement dans tout le périmètre du portefeuille
- Double fermeture velcro
- Dimensions à l'ouverture : 220 x 290 mm



2002/BVL6 CHF 14.40 1 020020010

2002/BV7-ZIP

Portefeuille d'outils enroulable en polyester durable, vide

- Avec 7 compartiments pratiques de tailles différentes et une petite poche à outils avec fermeture à glissière
- La poignée centrale en tissu renforcé facilite le transport
- Avec rabat intérieur empêchant les outils de sortir
- Coutures de renforcement dans tout le périmètre du portefeuille
- Double fermeture velcro
- Dimensions à l'ouverture : 355 x 220 mm



2002/BV7-ZIP CHF 26.00 1 020020060

2002/BV8

Portefeuille d'outils enroulable en polyester durable, vide

- Avec 8 compartiments à outils pratiques et de tailles différentes
- La poignée centrale en tissu renforcé facilite le transport
- Avec rabat intérieur empêchant les outils de sortir
- Coutures de renforcement dans tout le périmètre du portefeuille
- Double fermeture velcro
- Dimensions à l'ouverture : 395 x 360 mm



2002/BV8 CHF 14.40 1 020020020

2002/BV9

Portefeuille d'outils enroulable en polyester durable, vide

- Avec 9 compartiments à outils pratiques et de tailles différentes
- La poignée centrale en tissu renforcé facilite le transport
- Avec rabat intérieur empêchant les outils de sortir
- Coutures de renforcement dans tout le périmètre du portefeuille
- Double fermeture velcro
- Dimensions à l'ouverture : 325 x 290 mm



2002/BV9 CHF 14.40 1 020020030

2002/BV12

Portefeuille d'outils enroulable en polyester durable, vide

- Avec 12 compartiments à outils pratiques et de tailles différentes
- La poignée centrale en tissu renforcé facilite le transport
- Avec rabat intérieur empêchant les outils de sortir
- Coutures de renforcement dans tout le périmètre du portefeuille
- Double fermeture velcro
- Dimensions à l'ouverture : 650 x 355 mm



2002/BV12 CHF 23.90 1 020020040

2002/BV13

Portefeuille d'outils enroulable en polyester durable, vide

- Avec 13 compartiments à outils pratiques et de tailles différentes
- La poignée centrale en tissu renforcé facilite le transport
- Avec rabat intérieur empêchant les outils de sortir
- Coutures de renforcement dans tout le périmètre du portefeuille
- Double fermeture velcro
- Dimensions à l'ouverture : 330 x 190 mm



2002/BV13 CHF 14.40 1 020020050

2002/BV42

Portefeuille d'outils enroulable en polyester durable, vide

- Avec 42 compartiments à outils pratiques et de tailles différentes :
 - 18 élastiques et 24 poches dont une à rabat avec fermeture à scratch
- La poignée centrale en tissu renforcé facilite le transport
- Accrochage mural au moyen d'anneaux métalliques
- Coutures de renforcement dans tout le périmètre du portefeuille
- Fermeture robuste avec boucle à double clip
- Dimensions à l'ouverture : 595 x 535 mm



2002/BV42 CHF 35.50 1 020020070

2005MPU

pochette à outils, vide, en nylon, avec ceinture

- Cinq grandes poches à outils • Une poche à ciseaux avant • Boucle avec crochet pour ruban adhésif • Ceinture réglable (70 ÷ 120 cm) Dimensions: 155x285x80 mm



2005MPU CHF 37.00 1 020050060

2005MPU/E

pochette à outils avec assortiment de 5 outils



2005MPU/E CHF 119.50 1 020050065

- 1128BMX
- 1150BM 180 mm
- 1201E 3,5x100 - 4x100 mm
- 1202E PH1x80 mm

155x285x80 mm

2005PA/D

Porte-outils poche double vide en nylon, avec ceinture



2005PA/D CHF 87.50 1 020050000

2005PA/E

pochette à outils, vide, en nylon, avec ceinture

- Deux grandes poches avec bandes d'outils élastiques • Deux poches avant en ciseaux • Deux compartiments latéraux pratiques avec: - poche gauche avec crochet métallique robuste pour rubans à mesurer - double poche droite avec sac avec cordon de serrage et fermeture à glissière • Boucle avec crochet pour ruban adhésif • Ceinture réglable (70 ÷ 120 cm) Dimensions: 260x250x190 mm



2005PA/E CHF 58.00 1 020050030

2005PA/ET

pochette à outils avec assortiment de 8 outils pour la maintenance électrotechnique



2005PA/ET CHF 237.50 1 020050035

- 1082MQ 160 160 mm
- 1128BMX
- 1253
- 1272MQF PH1x80 - PH2x100
- 1274MQF 3,5x100 - 4,5x100
- 1639ESB BMESB1925NE

260x250x190 mm

2005PA/S

Porte-outils en nylon, avec ceinture



2005PA/S CHF 44.00 1 020050020

2009N/BV

Sacoche de maintenance industrielle en cuir



2009N/BV CHF 370.00 1 020090200

530x220x190 mm

2005PA/U

pochette à outils avec assortiment de 17 outils pour la maintenance générale



2005PA/U CHF 228.50 1 020050040

96/SC9

111E 200 mm

1048N 250 mm

1128BMX

1201E 4x100 - 5,5x125 mm

1202E PH1x80 - PH2x100 mm

1692/3 3 m

260x250x190 mm

2028/VV

Valise porte-outils en polypropylène

2 panneaux porte-outils
Fond intérieur avec séparateurs amovibles
Double fermeture avec combinaison



2028/VV CHF 306.00 1 020280010

480x190x400 mm

2028E

Composition avec valise porte-outils pour l'électronique et la microtechnique



2028EL/A CHF 1,505.00 1 020281014

2028ET/A 1,520.00 1 020281018
(2028/VV+5980ET/A)

2029/VV

Valise porte-outils en polypropylène à grande épaisseur, profilée en aluminium

2 panneaux porte-outils
Fond avec séparateurs amovibles et réglables
Fournie avec bandoulière
2 serrures avec clé



2029/VV CHF 438.00 1 020290000

480x227x408 mm

2029E

Composition avec valise porte-outils pour l'électronique et la microtechnique



2029 BG MQ CHF 2,690.00 1 020291257
(2029/VV+5980MQ)

2029ET/B 2,110.00 1 020291021
(2029/VV+5980ET/B)

2029EL/B 2,125.00 1 020291017
(2029/VV+5980EL/B)

2029EM

Valise d'outils pour l'entretien et la réparation de véhicules hybrides et électriques



2029EM CHF 2,720.00 1 020290300

52MQ 7-8-9-10-11-12-13-14-15-16-17-19-22 mm

910MQ/B 6-7-10-12-13-17-19 mm

910MQ/TX TX25 - TX30 - TX40

910MQ/55

1048MQ 250 mm

1082MQ 160 mm

1128MQ 145 mm

1150MQ 180 mm

1162MQ 160 mm

1272MQ PH1 - PH2

1274MQ 2,5x75 - 3x100 - 4x100 - 5,5x125 - 6,5x150 mm

1760PT

1777MQ/U 190 mm

1996MQ/GM GM 10

7109A A1 - A2

7109D D2 - D3

2032/TV

Valise porte-outils en matière plastique

2 panneaux porte-outils
Poche porte-outils
Fond intérieur avec séparateurs amovibles



2032/TV CHF 591.00 1 020320110

450x200x400 mm



2032/TE

Composition avec valise porte-outils pour l'électronique et la microtechnique



2032TET/A
(2032/TV+5980ET/A)

CHF 1,805.00

1 020321328

2033L/VV

Boîte à outils murale, en aluminium, vide

- Très résistant aux chocs
- Finition sans écaillage
- Poignée ergonomique avec poignée en caoutchouc
- Double fermeture avec combinaison
- 2 panneaux d'outils avec bandes élastiques
- Fond intérieur avec cloisons amovibles



2033L/VV

CHF 479.00

1 020330250

470x203x373 mm

2033L

boîte outils en aluminium avec assortiments d'outils pour la maintenance électronique et électrotechnique



2033LEL/A
(2033L/VV+5980EL/A)

CHF 1,680.00

1 020331224

2033LEL/B
(2033L/VV+5980EL/B)

2,170.00

1 020331225

2033LET/B
(2033L/VV+5980ET/B)

2,145.00

1 020331237

2036/TV

Valise porte-outils en polypropylène grande épaisseur, en aluminium profilé

2 panneaux porte-outils
Poignée télescopique
Roues avec roulements à billes



2036/TV

CHF 693.00

1 020360000

480x267x408 mm

2036E

Composition avec chariot porte-outils pour l'électronique et la microtechnique



2036TET/B
(2036/TV+5980ET/B)

CHF 2,360.00

1 020361223

2036EL/B
(2036/TV+5980EL/B)

2,380.00

1 020361218

2037/TV

Valise porte-outils en polypropylène, avec 4 roues pivotantes

Extrêmement résistante aux chocs. Indiquée pour le transport d'outils en avion.
2 panneaux porte-outils amovibles.
Poche porte-documents intégrée.
4 roues pivotantes amovibles qui permettent la manutention horizontale de la valise.
2 bacs de rangement inc



2037/TV

CHF 854.00

1 020370000

482x295x478 mm

2038/TV

Valise porte-outils en polypropylène grande épaisseur

- Extrêmement résistante aux chocs.
- En aluminium profilé
- 2 serrures homologuées TSA avec clé
- 2 panneaux porte-outils amovibles.
- Grande poignée télescopique et grandes roues avec roulements à billes
- 2 poignées (1 latérale) ergonomiques revêtues de caoutchouc
- Fond grande capacité
- Poche porte-documents
- 3 petits tiroirs de rangement



2038/TV

CHF 1,131.00

1 020380000

430x375x525 mm



2041UC

Valise Utility Case avec 33 outils



2041UC CHF 450.00 1 020410215

- 55 6x7 - 8x9 - 10x11 - 12x13 - 14x15 - 16x17 mm
- 96/SC9 1,5 - 2 - 2,5 - 3 - 4 - 5 - 6 - 8 - 10 mm
- 111E 200 mm
- 1048VN 250 mm
- 1128BMX 145 mm
- 1150 180 mm
- 1201E 2,5x50 - 3x75 - 4x100 - 5,5x100 - 6,5x150 mm
- 1202E PH0x60 - PH1x80 - PH2x100 mm
- 1370 300 g
- 1692 3m
- 1771 170 mm
- 1833S 70 Lumen / 140 mm
- 1639NS-N 25m
- 1696 200 mm

535x282x87 mm - 4,5 Kg

2051N

Valise en polypropylène antichoc avec composition de 55 outils pour maintenance nautique



2051N CHF 1,066.00 1 020510225

- 42 7 - 8 - 10 - 12 - 13 - 14 - 17 - 19 mm
- 55AS 3/8x7/16 - 1/2x9/16 - 5/8x11/16"
- 96/SC9 O1,5+10 mm
- 111E 200 mm
- 920A O 10 - 12 - 13 - 14 - 17 - 19 mm
- 920AS O 7/16 - 1/2 - 9/16 - 11/16 - 7/8"
- 920/22 255 mm - □1/2 - ■1/2
- 920/25 □1/2 - ■1/2
- 920/42 ■1/2
- 920/55 ■1/2
- 956C □1/2 - 16 - 20,8 mm
- 1048BM 250 mm
- 1084BM 160 mm
- 1128BMX 145 mm
- 1150BM 180 mm
- 1166BM 160 mm
- 1201E O3x75 - 4x100 - 5,5x150 - 6,5x150 mm
- 1202E PH1x80 - PH2x100 mm
- 1390 O 35 mm
- 1490/2 ø max 240 mm
- 1737 145 mm
- 1778X
- BMN1436 3,6 x 140 mm
- BMESB1925NE 25 m

585x393x92 mm - 9 kg

2055HB

Valise avec 24 outils



2055HB CHF 272.00 1 020550215

- 55 6x7 - 8x9 - 10x11 - 12x13 mm
- 96N/SC9 1,5 - 2 - 2,5 - 3 - 4 - 5 - 6 - 8 - 10 mm
- 1128BMX 145 mm
- 1150 180 mm
- 1048VN 250 mm
- 1201E 3x75 - 4x100 - 5,5x100 mm
- 1202E PH0x60 - PH1x80 - PH2x100 mm
- 1370 300 g
- 1692 3m

373x275x70 mm - 3 Kg

2080/V6

Valise type organizer avec 6 bacs de rangement amovibles et séparateurs réglables



2080/V6 mm CHF 50.00 1 020800060

2080/V6-U

Bac de rangement amovible pour valise type organizer 2080/V6



2080/V6-U CHF 3.85 1 020800066

90x60x50 mm

2080/D10

Jeu de 10 séparateurs réglables pour valise type organizer 2080/V6



2080/D10 CHF 10.20 1 020800070

2080/V12

Valise type organizer avec 12 bacs de rangement amovibles



2080/V12 mm CHF 78.50 1 020800000

2080/V12-...

Bac de rangement amovible pour valise type organizer 2080/V12



2080/V12-S CHF 4.85 3 020800013

2080/V12-M CHF 7.25 2 020800015

2080/V12-L CHF 12.50 1 020800020

95x75x65 mm

145x75x65 mm

295x75x65 mm

C3

Mini sac à outils en tissu technique

Caractéristiques principales:

- 1 poche extérieure avant avec fermeture éclair
- 2 poches latérales avec module de rangement
- 1 poche arrière pratique avec fermeture Velcro
- 1 panneau porte-outils intérieur amovible, avec des bandes élastiques des deux côtés
- Interface USB pour charger les appareils mobiles
- Complet avec bandoulière

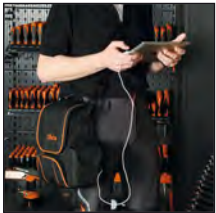

C3 CHF 84.50 1 021030000
 230x110x320 mm - 890 g

C4 - 2104

Sac seau porte-outils en tissu technique

Panneau intérieur porte-outils amovible
 Poches et élastiques porte-outils intérieurs et extérieurs
 Base rigide imperméable avec pieds en caoutchouc
 Bandoulière fournie



C4 CHF 142.50 1 021040000
2104VU/0 CHF 661.00 1 021041122
 (C4+5915VU/0)
 330x260x360 mm - 2,5 kg

C5S

Sac à dos porte-outils en polyester résistant

- Double poignée sur la partie supérieure centrale du sac à dos pour une prise sûre et équilibrée
- Deux grandes poches frontales
- Deux grandes poches intérieures et deux bandes velcro supplémentaires
- Trousse pratique enroulable composée de 4 panneaux porte-outils
- Bretelles renforcées réglables
- Charge maximale : 15 kg



C5S CHF 72.50 1 021050100
 310x120x390 mm - 0,9 Kg

C5 - 2105

Sac à dos porte-outils en tissu technique



C5 CHF 203.50 1 021050000
2105VU/0 CHF 722.00 1 021051122
 (C5+5915VU/0)
 400x200x500 mm - 2,5 Kg

C6T - 2106

Sac à dos porte-outils en tissu technique, avec roues



C6T CHF 289.00 1 021060010
2106T/VU0 CHF 807.00 1 021061123
 (C6T+5915VU/0)
 360x200x480 mm - 4,5 kg

C7 - 2107

Sacoche porte-outils en tissu technique

2 panneaux porte-outils intérieurs amovibles
 Poche intérieure porte-PC
 2 poches extérieures avant
 Fond intérieur en matière plastique avec séparateurs amovibles



C7 CHF 301.00 1 021070000
2107VU/2 CHF 848.00 1 021071112
 (C7+5915VU/2)
2107VU/3 CHF 1,465.00 1 021071114
 (C7+5915VU/3)
 480x165x380 mm - 3,5 kg

C7AT

Sacoche d'assistance en tissu technique

Caractéristiques principales:

- Fabriqué à partir de tissu technique ultra résistant
- Base renforcée avec pieds en caoutchouc
- Double poignée supérieure pour une prise en main sûre et équilibrée
- Grande poche avant avec fermeture zippée pour le rangement de documents et compartiment supplémentaire avec double sangle avec fermeture à clip
- Double poche latérale avec fermeture à scratch
- Compartiment intérieur spacieux avec poche supplémentaire pour documents
- Compartiment PC et tablette avec rembourrage de protection intérieur (taille PC jusqu'à L=370 mm, H=250 mm)
- Ouverture zippée sur le devant et des deux côtés pour un accès rapide aux outils :
- 29 compartiments et 13 emplacements élastiques à outils sur la face avant ;
- 33 compartiments à outils sur la face arrière.
- Bandoulière rembourrée réglable



C7AT

CHF
161.00

1 021070010

470x200x340 mm

C8 - 2108

Chariot porte-outils en tissu technique



C8
2108VU/1
(C8+5915VU/1)

CHF
340.00

1 021080000

CHF
968.00

1 021081022

470x280x380 mm - 4 kg

C8B

Chariot porte-outils en tissu technique pour électriciens

Structure rigide

Poignée télescopique de transport

4 roues pivotantes

1 panneau porte-outils intérieur amovible

Poche frontale avec porte-badge

Double fond avec bac de rangement compris

2 poches extérieures latérales

2 crochets porte-sonde tire-fils

Manche inclinable pour faciliter l'accès aux outils

Possibilité de fermeture avec cadenas (non compris)



C8B

CHF
274.00

1 021080300

380x250x430 mm - 4,7 kg

C9 - 2109

Sacoche porte-outils en tissu technique

• Base rigide

• Poches intérieures et extérieures pour le rangement des outils

• Poche extérieure avec fermeture éclair pour plus de sécurité

• Poche refermable à fermeture facile pour objets personnels

• Double fond

• Double-sangles porte-niveaux

• Bandoulière de transport



C9

CHF
164.50

1 021090000

2109VU/1
(C9+5915VU/1)

CHF
792.00

1 021091022

2109VU/3
(C9+5915VU/3)

CHF
1,330.00

1 021091024

550x280x320 mm - 2,6 kg

C9/RT

bandoulière pour C4,C7,C9,C10,C10S,C11 e C12



C9/RT

CHF
21.30

1 021090900

C9DA

Sac à outils avec grande ouverture

Caractéristiques principales:

- Fabriqué à partir de tissu technique ultra résistant
- Base en rigide en plastique et résistante à l'eau
- Poignée supérieure renforcée pour une prise en main sûre
- Double poche latérale avec fermeture à scratch
- 2 compartiments à outils latéraux avec de grandes ouvertures pour un accès rapide et une aperçu rapide du contenu.
- 22 compartiments supplémentaires avec fermeture zippée frontale.
- 14 compartiments à outils supplémentaire zippé à l'arrière
- Livré vide avec bandoulière rembourrée réglable



C9DA

CHF
130.00

1 021090005

420x220x310 mm

Beta

C9MT

Sacoche porte-outils pour les agents d'entretien

- Revêtement externe en PVC robuste et imperméable
- Coutures de renfort sur tout le périmètre
- Fermeture avec double boucle à clip
- Double poignée interne pour une prise équilibrée et sûre
- Poche porte-documents avec fermeture éclair



C9MT CHF 115.50 1 021090200

450x180x200 mm

2109MT ID/1

Sacoche pour les agents d'entretien avec un assortiment de 24 outils pour la plomberie



2109MT ID/1 CHF 816.00 1 021091026
(C9MT+5980ID/1)

- 111E 250 mm
- 332 Ø 3+28 mm
- 334 Ø 3+30 mm
- 342 Ø 0+42 mm
- 345SB2 140 mm
- 376 320-410 mm
- 1048N 175-250 mm
- 1128BMX
- 1150GBM 180 mm
- 1201E 3x75-4x100-5,5x150-8x150 mm
- 1202E PH1x80-PH2x100
- 1370 500 g
- 1690F 2 m
- 1692/5 5 m
- 1696 200 mm
- 1719BMA...M 200 mm
- 1719BM/RL 200 mm
- 1725

Beta

C9PT



C9PT 321

C10 - 2110

Boîte à outils en tissu technique

- Structure rigide
- Double fond. Le fond peut être enlevé pour augmenter la capacité du sac
- Manche inclinable pour faciliter l'accès aux outils
- Élastiques porte-outils, poches intérieures et extérieures
- Doublure de couverture
- Bac de rangement compris dans le double fond



C10 CHF 206.50 1 021100000
2110VU/1 CHF 835.00 1 021101031
 (C10+5915VU/1)
2110VU/3 CHF 1,370.00 1 021101034
 (C10+5915VU/3)
2110VU/AS CHF 1,485.00 1 021101036
 (C10+5915VU/AS)

520x220x250 mm - 3,3 kg

C10S - 2110S

Boîte à outils en tissu technique

- Structure rigide
- Double fond. Le fond peut être enlevé pour augmenter la capacité du sac
- Manche inclinable pour faciliter l'accès aux outils
- Élastiques porte-outils, poches intérieures et extérieures
- Doublure de couverture
- Bac de rangement compris dans le double fond



C10S CHF 162.50 1 021100001
2110SVU/1 CHF 791.00 1 021101041
 (C10S+5915VU/1)
2110SVU/3 CHF 1,325.00 1 021101044
 (C10S+5915VU/3)

420x220x250 mm - 2,3 kg

C11 - 2111

Boîte à outils en tissu



C11 CHF 120.00 1 021110000
2111VU/1 CHF 749.00 1 021111031
 (C11+5915VU/1)
2111VU/3 CHF 1,285.00 1 021111034
 (C11+5915VU/3)

410x230x250 mm - 2 kg





C12 - 2112

Sacoche porte-outils en tissu technique

Panneau intérieur porte-outils amovible

Élastiques porte-outils et grandes poches intérieures et extérieures

La sacoche s'ouvre à l'avant pour faciliter l'accès aux outils sur le lieu de travail

Base rigide imperméable avec pieds en caoutchouc

Prévue pour être utilisée avec chariot porte-outils C8



	CHF		
C12	261.00	1	021120000
2112ET/A (C12+5980ET/A)	1,475.00	1	021121028
2112ET/B (C12+5980ET/B)	1,930.00	1	021121029
2112VU/5 (C12+5915VU/5)	1,735.00	1	021121056

500x270x350 mm - 5 kg

C13

Coffre porte-outils avec roues, en polypropylène haute résistance

• Adapté pour l'utilisation en plein air

• Résistant aux chocs et aux agents chimiques

• Prédiposition pour fermeture avec cadenas (non inclus)

• Équipé de deux serrures

• Deux roues pour un déplacement horizontal du coffre

• Fourni avec un bac de rangement amovible à verrouiller à l'intérieur dans deux positions

• Plaque d'identification porte-nom



	CHF		
C13	432.00	1	021130000

806x350x467 mm - 7,2 kg

C14

Chariot porte-outils en polypropylène avec 4 tiroirs

• Structure en polypropylène à injection qui garantit une grande résistance aux chocs.

• La partie avant, protégée par le couvercle, accueille 4 tiroirs 470x255 mm extractibles :

1 tiroir hauteur 30 mm

2 tiroirs hauteur 60 mm

1 tiroir hauteur 90 mm

• Serrure centralisée avant permettant de fermer simultanément les deux couvercles, supérieur et avant.

• Deux poignées latérales

• 4 roues résistantes arrière

• Plateau supérieur amovible

• Panneau porte-outils intégré dans le couvercle

• 3 bacs de rangement inclus

• Plaque d'identification porte-nom

• Prédiposition pour la fermeture avec cadenas TSA



	CHF		
C14	1,101.00	1	021140000
2114VU/M (C14+5914VU/M)	2,500.00	1	021141011

585x390x457 mm - 10 kg

CP15 - 2115

Boîte à outils en matière plastique avec plateau et bacs de rangement amovibles

• 1 couvercle de rangement intégré dans le couvercle

• 2 bacs de rangement amovibles avec séparateurs réglables

• 1 récipient interne avec séparateurs réglables



	CHF		
CP15	64.00	1	021150201
2115PVU/1 (CP15+5915VU/1)	692.00	1	021151232
2115PVU/2 (CP15+5915VU/2)	611.00	1	021151234

445x240x250 mm - 2 kg

CP15L - 2115

Boîte à outils longue en matière plastique avec plateau et bacs de rangement

• 3 bacs de rangement intégrés dans le couvercle avec séparateurs réglables

• 1 récipient interne avec séparateurs réglables



	CHF		
CP15L	87.00	1	021150202
2115PL-VU/1 (CP15L+5915VU/1)	715.00	1	021151242
2115PL-VU/3 (CP15L+5915VU/3)	1,250.00	1	021151245

558x277x270 mm - 2,5 kg

2115PI/BIKE-HOME

Composition de 28 outils

Réparation vélos



	CHF		
2115PI/BIKE-HOME	348.00	1	021150098

96BP/SC9

3935

3969K3

42 8-9-10-13-14 mm

42SLIM 15 mm

1082G 160 mm

1150G 180 mm

1201E 3x75 - 5,5x150 mm

1202E PH0x60 - PH2x100 mm

3991

BMESB1925NE 25 m

BMN1436 3,6 x 140 mm

558x277x270 mm - 4,3 kg





2115P L-MQ32

Composition de 32 outils isolés pour autos hybrides, coffret en matière plastique, avec plateau en mousse compacte



2115PL-MQ32 CHF 1,555.00 1 021150332

- 920MQ/55A
- 89MQ 10-12 mm
- 850MQ 1/4"
- 860TX/A10 T7-T8-T9-T10-T15-T20-T25-T27-T30-T40
- 920MQ/A 8-10-12-13-14-17-19 mm
- 920MQ/21 125mm
- 920MQ/22 250mm
- 1048MQ250 250mm
- 1150MQ 180mm
- 1164MQ160 160mm
- 1272MQ 4.5X80-6X100mm
- 1274MQ 3X100-4X100-5.5X125
- 1995MQ/G2 G2
- CP15L

C16 - 2116

Boîte à outils en matière plastique avec bac plastique interne, vide



C16 CHF 142.00 1 021160000
2116VU/1 CHF 770.00 1 021161102
 (C16+5915VU/1)
2116VU/3 CHF 1,305.00 1 021161105
 (C16+5915VU/3)

500x260x260 mm - 2,5 kg

CP17 - CP17L - 2117

Boîte à outils en acier inoxydable et en matière plastique avec plateau amovible



CP17
500x200x220 mm



CP17L
575x245x265 mm

	CHF		
CP17	119.00	1	021170500
2117P-VU/1 (CP17+5915VU/1)	748.00	1	021171042
2117P-VU/3 (CP17+5915VU/3)	1,280.00	1	021171045
CP17L	171.00	1	021170502
2117L-VU/1 (CP17L+5915VU/1)	800.00	1	021171142
2117PL-VU/3 (CP17L+5915VU/3)	1,335.00	1	021171145

C18 - 2118

Boîte à outils simple, métallique



	CHF		
C18	56.50	1	021180001
2118VU/1 (C18+5915VU/1)	684.00	1	021181032

450x200x100 mm - 3 kg

C19 - 2119 - C19L - 2119L

Boîte à outils 3 cases, métallique



C19
450x200x160 mm



C19L
550x200x160 mm

	CHF		
C19	74.50	1	021190001
2119VU/3 (C19+5915VU/3)	1,235.00	1	021191025
C19L	95.50	1	021190002
2119L-VU/3 (C19L+5915VU/3)	1,260.00	1	021191125

G20 - G20L - 2120

Boîte à outils 5 cases, métallique



G20
450x200x210 mm



G20L
550x200x210 mm

	CHF		
G20	104.50	1	021200001
2120VU/2 (G20+5915VU/2)	652.00	1	021201061
2120VU/3 (G20+5915VU/3)	1,270.00	1	021201063
2120VU/4 (G20+5915VU/4)	1,610.00	1	021201064
2120VU/AS (G20+5915VU/AS)	1,380.00	1	021201068
G20L	114.50	1	021200002
2120L-VU/2 (G20L+5915VU/2)	662.00	1	021201161
2120L-VU/3 (G20L+5915VU/3)	1,280.00	1	021201163
2120L-VU/4 (G20L+5915VU/4)	1,620.00	1	021201164
2120L-VU/AS (G20L+5915VU/AS)	1,390.00	1	021201168



C20TSS

Boîte à outils 5 cases en acier inoxydable AISI 304



C20TSS	CHF		
	384.00	1	021203001

≡: 450x200x210 mm - 📦 4kg

C22B

Coffre porte-outils, en tôle



C22B O
≡ 720x320x310 mm



C22BM O
≡ 850x360x350 mm



C22BL O
≡ 1010x410x400 mm

C22B-O	CHF		
	298.00	1	022000150
C22BM-O	342.00	1	022000160
C22BL-O	456.00	1	022000170

C22B O: 📦 13 kg
C22BM O: 📦 20 kg
C22BL O: 📦 26 kg

C22W

Coffre porte-outils en tôle d'acier, avec doublage intérieur en mélaminé pour une meilleure protection du coffre et des outils



C22W-O
≡ 690x300x360 mm



C22WL-O
≡ 990x300x360 mm

C22W-O	CHF		
	331.00	1	022000269
C22WL-O	430.00	1	022000299

C22W O: 📦 15 kg
C22WL O: 📦 28 kg

C22P

Coffre porte-outils de chantier, en tôle

poignées encastrables invisibles
patins surélevés pour déplacement avec chariot élévateur
double fermeture anti-effraction pour cadenas (non inclus)



C22PM O
≡ 915x540x430 mm



C22PL O
≡ 1220x720x615 mm

C22PM-O	CHF		
	887.00	1	022000240
C22PL-O	1,370.00	1	022000245

C22PM O: 📦 39 kg
C22PL O: 📦 67 kg





C99

Combo est le système modulaire de Beta, composé de **3 différents types de coffrets robustes porte-outils**, conçus pour ranger parfaitement et en toute sécurité vos outils de travail. Les coffret peuvent être aisément unis entre eux **par un simple clic**, au moyen d'un système de fermeture latérale à enclenchement.

Le système Beta Combo C99 est compatible avec le standard L-BOXX de Sortimo®.

C99

Système modulaire complet BETA COMBO

Les coffrets porte-outils peuvent être aisément unis entre eux par un simple clic, au moyen d'un système de fermeture latérale à enclenchement.

Composé de :

- Chariot ultracompact pliable avec poignée télescopique C99P (485x520x1095 mm)
- Coffret porte-outils en ABS C99V1 (445x358x152 mm)
- Coffret porte-outils en ABS C99V2 (445x358x254 mm)
- Coffret porte-outils en ABS avec 2 bacs de rangement portables C99V3/2C (445x358x322 mm)



C99

CHF 870.00 1 099000010

C99V0

Coffret porte outils en ABS, avec couvercle transparent - Vide

Les coffrets porte outils en ABS peuvent être facilement assemblés les uns aux autres par un simple clic, grâce au mécanisme d'encliquetage latéral fonctionnel.

Caractéristiques principales:

- Couvercle transparent en polycarbonate robuste pour une identification rapide du contenu
- Dimensions extérieures: 445x358x118 mm
- Max. capacité de charge intérieure: 25 kg
- Peut être cadencassé
- Poids: 2,5 kg

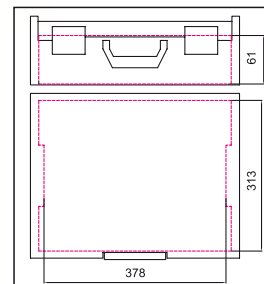

C99V0

CHF 139.00 1 099000020

C99V0-P12

Coffret porte outils en ABS, avec couvercle transparent - + kit 18 bacs
- Vide

Les coffrets porte outils peuvent être facilement assemblés les unes aux autres par un simple clic, grâce au mécanisme d'encliquetage latéral fonctionnel.

Caractéristiques principales:

- Couvercle transparent en polycarbonate robuste pour une identification rapide du contenu
- Particulièrement adapté pour transporter des petits objets, y compris des vis, des écrous, des rondelles, des rivets et des chevilles
- Livré complet avec kit de 18 bacs fourre-tout:
 - 2 plateaux rouges, 52x52 mm
 - 3 plateaux jaunes, 104x52 mm
 - 2 plateaux bleus, 104x104 mm
 - 1 plateau vert, 104x156 mm
 - 2 plateaux orange, 208x52 mm
 - 2 plateaux gris, 312x71 mm et 6 cloisons réglables
- Dimensions extérieures: 445x358x118 mm
- Max. capacité de charge intérieure: 25 kg
- Peut être cadenassé
- Poids: 3,2 kg

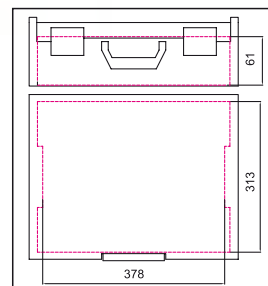

C99V0-P12

CHF 197.50 1 099000200

C99P12-V0

Kit de 18 bacs pour boîtes à outils C99V0

Contenu du kit :

- 2 plateaux rouges, 52x52 mm
- 3 plateaux jaunes, 104x52 mm
- 2 plateaux bleus, 104x104 mm
- 1 plateau vert, 104x156 mm
- 2 plateaux orange, 208x52 mm
- 2 plateaux gris, 312x71 mm, et 6 cloisons réglables



C99P12-V0

CHF 61.50 1 099000499

C99V1

Coffret porte-outils COMBO en ABS

Les coffrets porte-outils peuvent être aisément unis entre eux par un simple clic, au moyen d'un système de fermeture latérale à enclenchement.

Caractéristiques principales :

- Dimensions extérieures : 445x358x152 mm
- Capacité de charge max. interne : 25 kg
- Prédiposition pour fermeture avec cadenas
- Poids : 2,2 kg

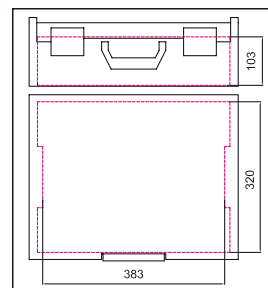

C99V1

CHF 141.50 1 099000250

C99V2

Coffret porte-outils COMBO en ABS

Les coffrets porte-outils peuvent être aisément unis entre eux par un simple clic, au moyen d'un système de fermeture latérale à enclenchement.

Caractéristiques principales :

- Dimensions extérieures : 445x358x254 mm
- Capacité de charge max. interne : 25 kg
- Poids : 2,8 kg

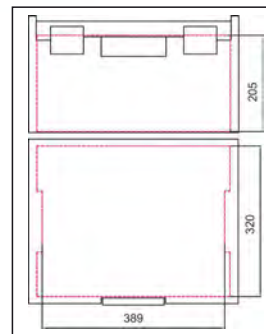

C99V2

CHF 157.00 1 099000350

C99V3/2C

Coffret porte-outils COMBO en ABS avec 2 bacs de rangement portables

Les coffrets porte-outils peuvent être aisément unis entre eux par un simple clic, au moyen d'un système de fermeture latérale à enclenchement.

Caractéristiques principales :

- Dimensions extérieures : 445x358x322 mm
- Capacité de charge max. interne : 25 kg
- Équipé de 2 bacs de rangement C99C-V3 vides
- Poids : 5,6 kg

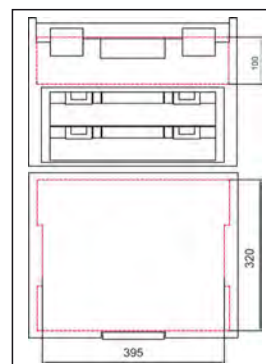

C99V3/2C

CHF 301.00 1 099000450

C99C-V3

Coffret porte-outils COMBO portable

Couvercle transparent pour identifier rapidement le contenu

Poignée intégrée

Dimensions extérieures : 367x316x72 mm

Poids : 0,9 kg

Accessoires :

- bac de rangement à 7 compartiments C99T-V3
- Jeu de 17 bacs de rangement C99P-V3

C99C-V3

CHF 51.00 1 099000496

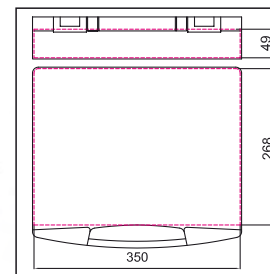

C99P

Chariot pliable COMBO en aluminium

Caractéristiques principales :

- Chariot ultracompact pliable en aluminium anodisé
- Branche avec poignée télescopique
- Dimensions ouvert : 485x520x1195 mm
- Dimensions fermé : 485x60x905 mm
- Dimensions base inclinable 485x350 mm
- Deux roues anti-crevaisson

C99P

CHF 272.00 1 099000101



C99PC

Revêtement interne pour couvercle coffrets C99V1 et C99V3/2C

Indispensable en association avec les plateaux thermoformés pour éviter que le contenu ne sorte des compartiments ou se mélange pendant le transport.

C99PC 400x320x20 mm

CHF 23.90 1 099000491



C99PP

panneau d'outils pour les boîtiers COMBO

- avec 6 poches et 11 bandes d'outils élastiques
- fourni complet avec des crochets pour fixer le panneau dans le couvercle du boîtier

C99PP

CHF 64.50 1 099000489





RSC22

coffre à outils portable avec 3 tiroirs

Caractéristiques principales:

- 3 tiroirs (588x277 mm) avec glissières à roulement à billes: 1 tiroir, 50 mm de haut 2 tiroirs, 70 mm de haut.
- Serrure centralisée avant.
- Poignées latérales rétractables pour faciliter la manipulation.

19 kg



RSC22-O



RSC22-A



RSC22-R



h	max
50 mm	25 kg
70 mm	25 kg

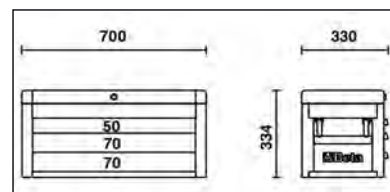
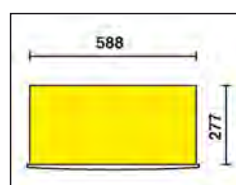

		CHF		
RSC22-O	RAL 2011	613.00	1	022003001
RSC22-R	RAL 3000	613.00	1	022003003
RSC22-A	RAL 7016	613.00	1	022003007

RSC23

coffre à outils portable avec 5 tiroirs

Caractéristiques principales:

- 5 tiroirs (588x277 mm) avec glissières à roulement à billes: 2 tiroirs, 50 mm de haut 3 tiroirs, 70 mm de haut.
- Serrure centralisée avant.
- Poignées latérales rétractables pour faciliter la manipulation.



RSC23-A



RSC23-R



RSC23-O

26 kg



h	max
50 mm	25 kg
70 mm	25 kg

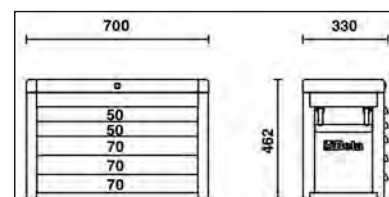
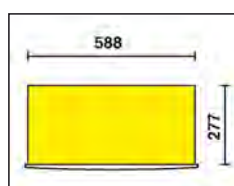

		CHF		
RSC23-O	RAL 2011	776.00	1	023003001
RSC23-R	RAL 3000	776.00	1	023003003
RSC23-A	RAL 7016	776.00	1	023003007

CD23S

Chariot Caddy

Caractéristiques principales :

- Socle en ABS permettant de poser les coffres C22S, C23S, C23SC, C23ST
- Poignée démontable pouvant être rangée sous le châssis.
- 4 roues, Ø 100 mm: 2 fixes et 2 mobiles (dont une équipée d'un frein).
- Capacité de charge maximale : 250 kg.

14 kg



		CHF		
CD23S		357.00	1	023000610

RSC23C

coffre à outils portable avec 8 tiroirs

Caractéristiques principales:

- 8 tiroirs (588x277 mm) avec glissières à roulement à billes : 4 tiroirs, 50 mm de haut 3 tiroirs, 70 mm de haut 1 tiroir, 100 mm de haut.
- Serrure centralisée avant.
- Poignées latérales rétractables pour faciliter la manipulation.



RSC23C-A



RSC23C-R



RSC23C-O



h	max
50 mm	25 kg
70 mm	25 kg

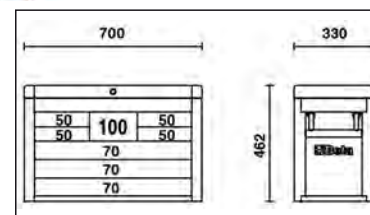
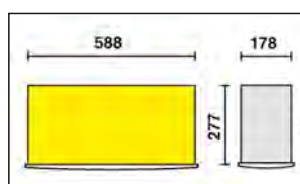

		CHF		
RSC23C-O	RAL 2011	877.00	1	023003011
RSC23C-R	RAL 3000	877.00	1	023003013
RSC23C-A	RAL 7016	877.00	1	023003017

RSC23T

coffre à outils portable avec 5 tiroirs

Caractéristiques principales:

- 5 tiroirs (588x367 mm) avec glissières à roulement à billes : 5 tiroirs, 70 mm de haut.
- Serrure centralisée avant.
- Peut être équipé d'un kit de 4 roulettes et 1 poignée (2300ST/KIT)

📦 36 kg



RSC23T-A



RSC23T-B



RSC23T-G



RSC23T-N



RSC23T-R



RSC23T-O



RSC23T-FO

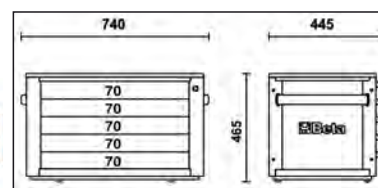
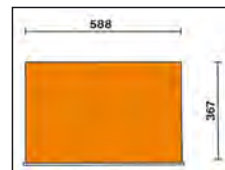
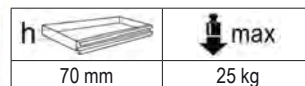

		CHF	📦	🖨️
RSC23T-FO	RAL 2011	978.00	1	023003020
RSC23T-O	RAL 2011	978.00	1	023003021
RSC23T-G	RAL 9006	978.00	1	023003022
RSC23T-R	RAL 3000	978.00	1	023003023
RSC23T-B	RAL 5015	978.00	1	023003026
RSC23T-A	RAL 7016	978.00	1	023003027
RSC23T-N	RAL 9005	978.00	1	023003029

2300ST/KIT

Kit de 4 roues et poignée pour coffre C23ST

- 4 roues, Ø 125 mm:
- 2 fixes et 2 mobiles (dont une équipée d'un frein).
- Manche télescopique

📦 6,5 kg

	CHF	📦	🖨️
2300ST/KIT	263.00	1	023000950

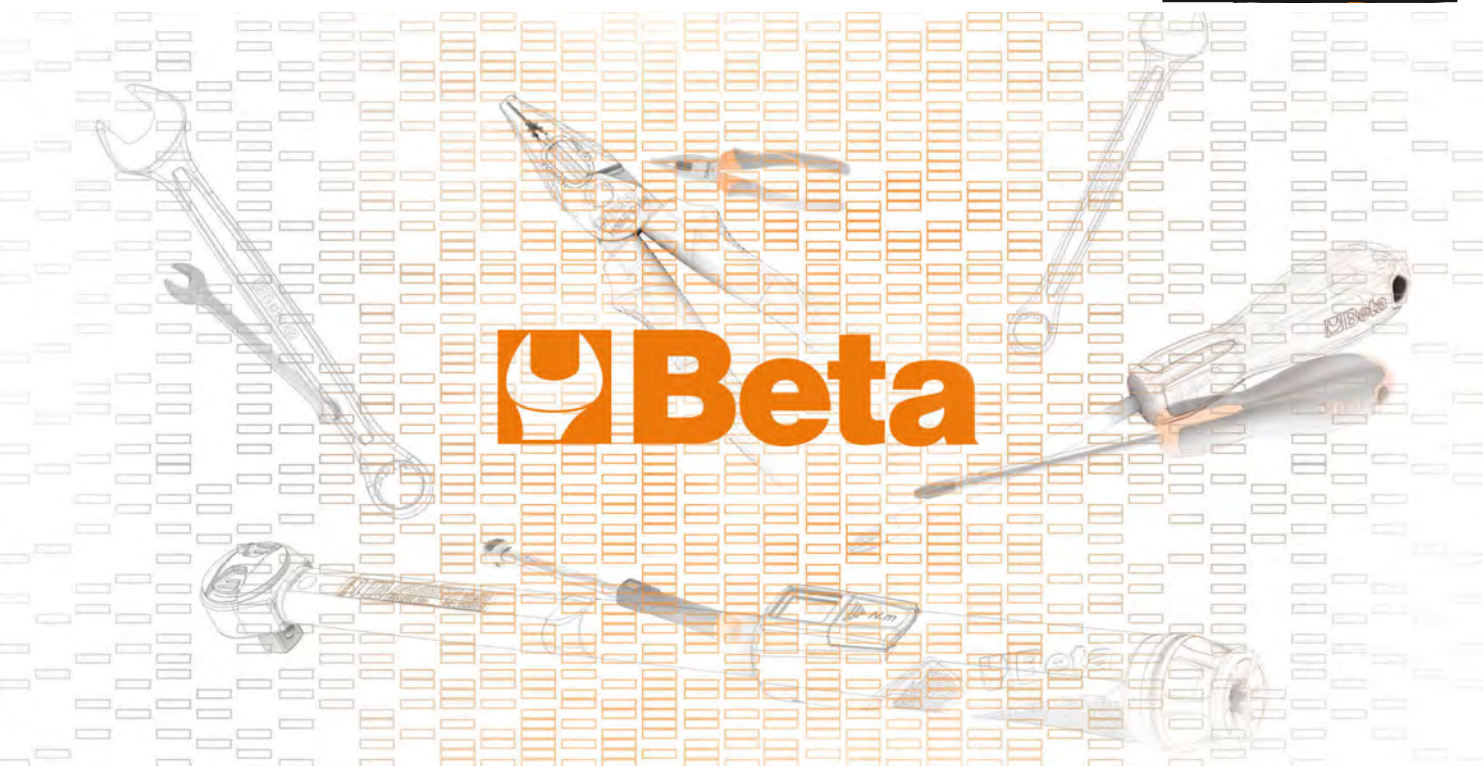



SERVANTE MOBILE RSC24

Beta
RSC24

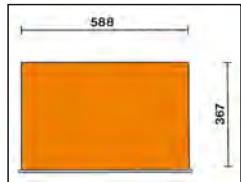
800 kg



Couleurs disponibles :

RSC24-		
FO	RAL 2011	RAL 2011
O	RAL 7016	RAL 2011
G	RAL 7016	RAL 9006
R	RAL 7016	RAL 3000
B	RAL 7016	RAL 5015
A	RAL 7016	RAL 7016
N	RAL 9005	RAL 9005

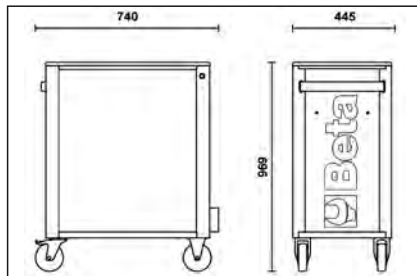

NOUVEAU PLAN DE TRAVAIL

PLUS ROBUSTE
PLUS PRATIQUE
PLUS FONCTIONNEL
PLUS MODERNE



- Tiroirs montés sur glissières à roulement à billes de précision
- Intérieur des tiroirs protégés par un tapis en caoutchouc mousse
- Possibilité d'insérer jusqu'à 4 plateaux en mousse EVA ou Thermoformés
- Nouveau plan de travail en thermoplastique renforcé, conçu pour supporter les coffres à outils RSC22, RSC23, RSC23C et RSC23T
- Plan de travail multifonction avec bords anti-chute équipé de huit emplacements pour le rangement vertical des tournevis
- Serrure de sécurité centralisé frontale
- Equipée de quatre roulettes Ø 125 mm : 2 fixes et 2 mobiles
- Capacité de charge statique : 800 kg

Modèles disponibles :

- RSC24/5 (5 tiroirs)
- RSC24/6 (6 tiroirs)
- RSC24/7 (7 tiroirs)
- RSC24/8 (8 tiroirs)

Accessoires disponibles :



RSC24/7

servante mobile à 7 tiroirs RSC24/7

Caractéristiques principales:

- 7 tiroirs entièrement amovibles (588x367 mm), avec glissières à roulement à billes:
- 5 tiroirs, hauteur 70 mm
- 1 tiroir hauteur 140 mm
- 1 tiroir hauteur 210 mm

800 kg



RSC24/7-O

Beta
RSC24



RSC24/7-FO

RSC24/7-A



RSC24/7-B

RSC24/7-G



RSC24/7-N

RSC24/7-R



h		 max
70 mm		25 kg
140 mm		30 kg
210 mm		30 kg

63 kg

	CHF		
RSC24/7-FO	1,360.00	1	024004070
RSC24/7-O	1,360.00	1	024004071
RSC24/7-G	1,360.00	1	024004072
RSC24/7-R	1,360.00	1	024004073
RSC24/7-B	1,360.00	1	024004076
RSC24/7-A	1,360.00	1	024004077
RSC24/7-N	1,360.00	1	024004079

RSC24/5

servante mobile avec 5 tiroirs RSC24/5

Caractéristiques principales:

- 5 tiroirs entièrement amovibles (588x367 mm), avec glissières à roulement à billes:
- 2 tiroirs, hauteur 70 mm
- 2 tiroirs hauteur 140 mm
- 1 tiroir, hauteur 280 mm

60 kg

	CHF		
RSC24/5-FO	1,177.00	1	024004050
RSC24/5-O	1,177.00	1	024004051
RSC24/5-G	1,177.00	1	024004052
RSC24/5-R	1,177.00	1	024004053
RSC24/5-B	1,177.00	1	024004056
RSC24/5-A	1,177.00	1	024004057
RSC24/5-N	1,177.00	1	024004059



RSC24/5-O

Beta RSC24



RSC24/5-FO



RSC24/5-A



RSC24/5-B



RSC24/5-G



RSC24/5-N



RSC24/5-R



h	max
70 mm	25 kg
140 mm	30 kg
280 mm	35 kg

RSC24/6

servante mobile à 6 tiroirs RSC24/6

Caractéristiques principales:

- 6 tiroirs entièrement amovibles (588x367 mm), avec glissières à roulement à billes:
- 4 tiroirs, hauteur 70 mm
- 1 tiroir hauteur 140 mm
- 1 tiroir, hauteur 280 mm

62 kg

	CHF		
RSC24/6-FO	1,265.00	1	024004060
RSC24/6-O	1,265.00	1	024004061
RSC24/6-G	1,265.00	1	024004062
RSC24/6-R	1,265.00	1	024004063
RSC24/6-B	1,265.00	1	024004066
RSC24/6-A	1,265.00	1	024004067
RSC24/6-N	1,265.00	1	024004069



RSC24/6-O

Beta RSC24



RSC24/6-FO



RSC24/6-A



RSC24/6-B



RSC24/6-G



RSC24/6-N



RSC24/6-R



h	max
70 mm	25 kg
140 mm	30 kg
280 mm	35 kg

RSC24/8

servante mobile avec 8 tiroirs RSC24/8

Caractéristiques principales:

- 8 tiroirs entièrement amovibles (588x367 mm), avec glissières à roulement à billes:
- 6 tiroirs, hauteur 70 mm
- 2 tiroirs hauteur 140 mm

66 kg

	CHF		
RSC24/8-FO	1,470.00	1	024004080
RSC24/8-O	1,470.00	1	024004081
RSC24/8-G	1,470.00	1	024004082
RSC24/8-R	1,470.00	1	024004083
RSC24/8-B	1,470.00	1	024004086
RSC24/8-A	1,470.00	1	024004087
RSC24/8-N	1,470.00	1	024004089



RSC24/8-O

Beta RSC24



RSC24/8-FO



RSC24/8-A



RSC24/8-B



RSC24/8-G



RSC24/8-N



RSC24/8-R



h	max
70 mm	25 kg
140 mm	30 kg

RSC24A/6

servante mobile avec 6 tiroirs, avec système anti-basculement

Caractéristiques principales:

- 6 tiroirs entièrement amovibles (588x367 mm), avec glissières à roulement à billes : 4 tiroirs, 70 mm de haut 1 tiroir, 140 mm de haut 1 tiroir, 280 mm de haut

62 kg

	CHF		
RSC24A/6-O	1,410.00	1	024004161
RSC24A/6-R	1,410.00	1	024004163
RSC24A/6-A	1,410.00	1	024004167



RSC24A/6-O

Beta RSC24



RSC24A/6-A



RSC24A/6-R



h	max
70 mm	25 kg
140 mm	30 kg
280 mm	35 kg



RSC24A/7

servante mobile avec 7 tiroirs, avec système anti-basculement

Caractéristiques principales:

- 7 tiroirs entièrement amovibles (588x367 mm), avec glissières à roulement à billes : 5 tiroirs, 70 mm de haut 1 tiroir, 140 mm de haut 1 tiroir, 210 mm de haut.

63 kg

	CHF		
RSC24A/7-O	1,505.00	1	024004171
RSC24A/7-R	1,505.00	1	024004173
RSC24A/7-A	1,505.00	1	024004177



RSC24A/7-O

Beta RSC24



RSC24A/7-A



RSC24A/7-R



h	max
70 mm	25 kg
140 mm	30 kg
210 mm	30 kg



RSC24A/8

servante mobile avec 8 tiroirs, avec système anti-basculement

Caractéristiques principales:

- 8 tiroirs entièrement amovibles (588x367 mm), avec glissières à roulement à billes : 6 tiroirs, 70 mm de haut 2 tiroirs, 140 mm de haut

66 kg

	CHF		
RSC24A/8-O	1,630.00	1	024004181
RSC24A/8-R	1,630.00	1	024004183
RSC24A/8-A	1,630.00	1	024004187



RSC24A/8-O

Beta RSC24



RSC24A/8-A



RSC24A/8-R



h	max
70 mm	25 kg
140 mm	30 kg





VERSION LONGUE :
Possibilité d'insérer jusqu'à 6 plateaux en mousse EVA ou Thermoformés

SYSTÈME ANTI-BASCULEMENT : EMPÊCHE L'OUVERTURE DE PLUSIEURS TIROIRS SIMULTANÉMENT



- Tiroirs montés sur glissières à roulement à billes de précision
- Plan de travail renforcé en ABS avec bords anti-chute, huit trous pour accueillir des tournevis et 6 plateaux de bac.
- Tiroir à ouverture complète équipée de palette en nylon robuste, avec porte-étiquette intégré
- Quatre roulettes Ø 125 mm : 2 fixes et 2 mobiles (dont une équipée d'un frein)
- Capacité de charge statique : 1000 kg
- Intérieur des tiroirs protégées par des tapis en caoutchouc mousse
- Porte-flacon latéral intégré
- Serrure de sécurité centralisée frontale

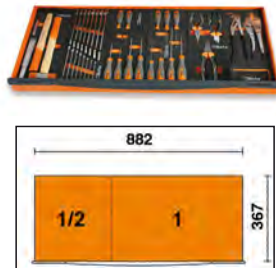
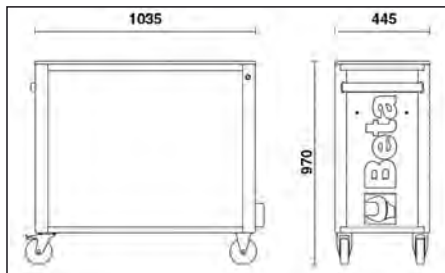

Couleurs disponibles :

	h	
O	RAL 7016	RAL 2011
R	RAL 7016	RAL 3000
A	RAL 7016	RAL 7016

Accessoires disponibles :



RSC24AXL/7

servante mobile extra large avec 7 tiroirs, avec système anti-basculement

caractéristiques principales:

- 7 tiroirs entièrement amovibles (882x367 mm), avec glissières à roulement à billes : 5 tiroirs, 70 mm de haut 1 tiroir, 140 mm de haut 1 tiroir, 210 mm de haut



Beta RSC24



h		max	
70 mm		30 kg	
140 mm		35 kg	
210 mm		35 kg	



84 kg

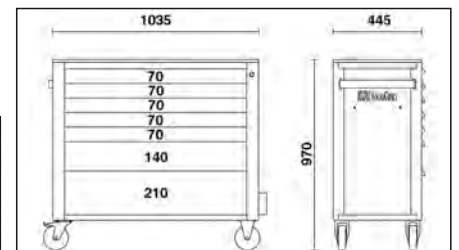
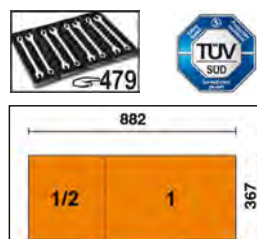

	CHF		
RSC24AXL/7-O	1,915.00	1	024004271
RSC24AXL/7-R	1,915.00	1	024004273
RSC24AXL/7-A	1,915.00	1	024004277

RSC24AXL/8

servante mobile extra large avec 8 tiroirs, avec système anti-basculement

Caractéristiques principales:

- 8 tiroirs entièrement amovibles (882x367 mm), avec glissières à roulement à billes : 6 tiroirs, 70 mm de haut. 2 tiroirs, 140 mm de haut.

88 kg

	CHF	↓	↑
RSC24AXL/8-O	2,050.00	1	024004281
RSC24AXL/8-R	2,050.00	1	024004283
RSC24AXL/8-A	2,050.00	1	024004287



h	max
70 mm	30 kg
140 mm	35 kg

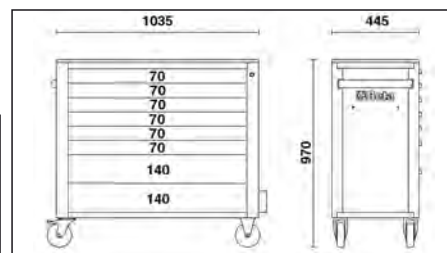
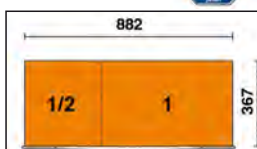

RSC24AXL/9

servante mobile extra large avec 9 tiroirs, avec système anti-basculement

Caractéristiques principales:

- 9 tiroirs entièrement amovibles (882x367 mm), avec glissières à roulement à billes : 8 tiroirs, 70 mm de haut 1 tiroir, 140 mm de haut.

90 kg

	CHF	↓	↑
RSC24AXL/9-O	2,180.00	1	024004291
RSC24AXL/9-R	2,180.00	1	024004293
RSC24AXL/9-A	2,180.00	1	024004297



h	max
70 mm	30 kg
140 mm	35 kg

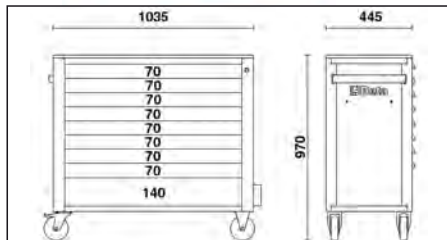

RSC24AXLP/7

Servante mobile extra large avec 7 tiroirs, plan de travail en bois et système anti-basculement

Caractéristiques principales :

- 7 tiroirs entièrement amovibles (882x367 mm), avec glissières à roulement à billes :
- 5 tiroirs, 70 mm de haut
- 1 tiroir, 140 mm de haut
- 1 tiroir, 210 mm de haut.
- Plan de travail en bois contre-plaqué stratifié avec trous pour placer un étau 1599F/100 o 1599GI/100 (à commander séparément)
- Façade en nylon robuste, avec porte-étiquette intégré
- Bases de tiroirs protégées par des tapis en caoutchouc moussé
- 4 roulettes, Ø 125 mm : 2 fixes et 2 pivotantes (une avec frein)
- Serrure de sécurité centralisée à l'avant
- Capacité de charge statique : 1.000 kg
- Porte-bouteille latéral intégré (peut être appliqué des deux côtés)
- Porte-rouleau de papier intégré
- Chaque tiroir peut accueillir jusqu'à 6 plateaux thermoformés en mousse EVA ou ABS

1100 kg

1100 kg

Beta RSC24



RSC24AXLP/7-O



RSC24AXLP/7-A



RSC24AXLP/7-R

h	max
70 mm	30 kg
140 mm	35 kg
210 mm	35 kg

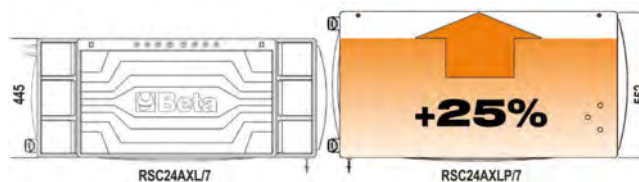

RSC24AXL7

RSC24AXLP7

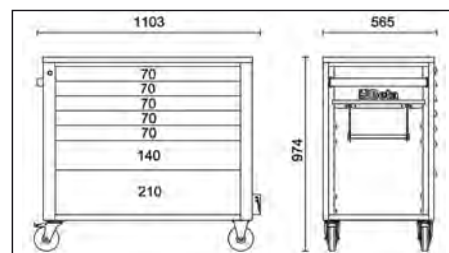
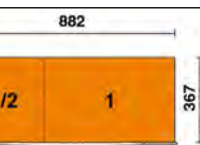

	CHF		
RSC24AXLP/7-O	2,200.00	1	024004571
RSC24AXLP/7-R	2,200.00	1	024004573
RSC24AXLP/7-A	2,200.00	1	024004577

2400 RSC24AXLP/CPR

Bac à déchets pour servante mobile RSC24AXLP/7

5 kg



	CHF		
2400 RSC24AXLP/CPR	85.00	1	024004993

2400 RSC24AXLP/PF

Panneau porte-outils perforé avec supports pour servante mobile RSC24AXLP/7

4,5 kg



	CHF		
2400 RSC24AXLP/PF	155.00	1	024004992



2400 RSC24AXLP/VL

Bac latéral porte-outils pour servante mobile RSC24AXLP/7

4 kg

2400 RSC24AXLP/VL

CHF 65.00 1 024004995



2400 RSC24/PC

support de rouleau de papier pour servante RSC24, RSC24A, RSC24AXL, RSC51

0,3 kg

2400 RSC24/PC-A
2400 RSC24/PC-N

CHF 32.00 1 024004903
32.00 1 024004904



RAL7016 2400 RSC24/PC-A
RAL9005 2400 RSC24/PC-N



2400 RSC24/PD

porte document pour servante RSC24, RSC24A, RSC24AXL

1,2 kg

2400 RSC24/PD-A
2400 RSC24/PD-N

CHF 56.50 1 024004907
56.50 1 024004908

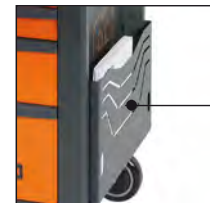

RAL7016 2400 RSC24/PD-A
RAL9005 2400 RSC24/PD-N



2400 RSC24/PF

panneau porte-outils perforé avec supports, pour servantes RSC24, RSC24A, RSC51

2,3 kg

2400 RSC24/PF

CHF 101.50 1 024004902

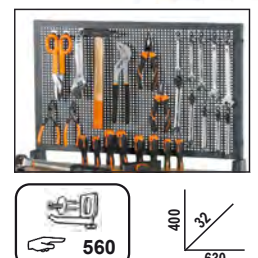

2400 RSC24/PF-

porte flacon pour servante RSC24, RSC24A

0,5 kg

2400 RSC24/PF-A
2400 RSC24/PF-N

CHF 34.00 1 024004905
34.00 1 024004906



RAL7016 2400S RSC24/PF-A
RAL9005 2400S RSC24/PF-N



2400 RSC24/PL

plan de travail en bois pour servantes RSC24, RSC24A, RSC24AXL, RSC51

4,3 kg

2400 RSC24/PL

CHF 126.50 1 024004901



2400 RSC24/SPC

support d'ordinateur pour servante mobile RSC24, RSC24A, RSC24AXLP/7, RSC51

- Avec tiroir amovible
- Ne peut pas être utilisé avec le modèle RSC24AXL

📦 3,1 kg

2400 RSC24/SPC CHF 184.00 1 024004909



2400 RSC24/MP

Étagère pliable pour RSC24, RSC24A, RSC24AXLP/7, RSC51

- Utilisable comme plan de travail supplémentaire
- Plan de travail de 390x440 mm, protégé par un tapis en caoutchouc imperméable à l'huile et à l'essence
- Capacité de charge : 20 kg

📦 3,4 kg

2400 RSC24/MP CHF 96.50 1 024004900



2499PF

Porte-flacons

- Adaptable sur la C38, C38A

📦 2,5 kg

2499PF-O CHF 94.00 1 024990210
2499PF-G CHF 94.00 1 024990219
2499PF-R CHF 94.00 1 024990230

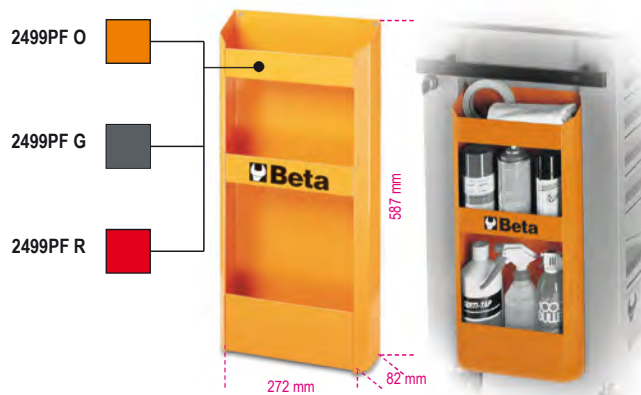

2499PF/M

Porte-flacons universel magnétique

📦 2,2 kg

2499PF/M CHF 85.50 1 024990050



2499PC

support de rouleau de papier

- Possibilité d'être monté sur les servantes C25 et les servantes C38

📦 2,2 kg

2499PC CHF 100.50 1 024990090



RSC24L/7

servante mobile avec 7 tiroirs et étagères latérales

Caractéristiques principales:

- 7 tiroirs (588x367 mm) avec glissières à roulement à billes: 5 tiroirs, 70 mm de haut 1 tiroir, 140 mm de haut 1 tiroir, 210 mm de haut.
- Bases de tiroirs protégées par des tapis en caoutchouc moussé.
- 4 roulettes, E 125 mm : 2 fixes et 2 directions avec freins.
- Serrure centralisée avant.
- Capacité de charge statique : 1 100 kg.
- Plan de travail en bois multicouche avec trous pour un vice (1599F/100, à commander séparément).
- Compartiment latéral avec étagère réglable verticalement.
- Support de rouleau de papier intégré.
- Double porte-bouteille arrière.

80 kg

		CHF	↓	📄
RSC24L/7-O	RAL 2011	2,070.00	1	024004371
RSC24L/7-R	RAL 3000	2,070.00	1	024004373
RSC24L/7-A	RAL 7016	2,070.00	1	024004377

Beta R5 C24

1100 kg



h	↓ max
70 mm	25 kg
140 mm	30 kg
210 mm	30 kg

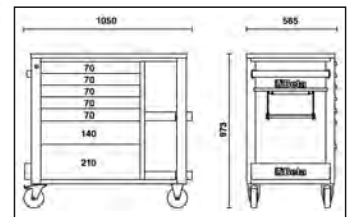
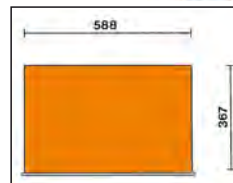

RSC24L-CAB

servante mobile avec 7 tiroirs coffre et étagères latérales

Caractéristiques principales:

- 7 tiroirs (588x367 mm) avec glissières à roulement à billes: 5 tiroirs, 70 mm de haut 1 tiroir, 140 mm de haut 1 tiroir, 210 mm de haut.
- Bases de tiroirs protégées par des tapis en caoutchouc moussé.
- 4 roulettes, E 125 mm : 2 fixes et 2 directions avec freins.
- Serrure centralisée avant.
- Armoire à outils latérale avec porte verrouillable et étagère intérieure réglable verticalement.
- Capacité de charge statique : 1 100 kg.
- Plan de travail en bois multicouche avec trous pour un vice (1599F/100, à commander séparément).
- Support de rouleau de papier intégré.
- Double porte-bouteille arrière.

82 kg

		CHF	↓	📄
RSC24L-CAB/O	RAL 2011	2,140.00	1	024004471
RSC24L-CAB/R	RAL 3000	2,140.00	1	024004473
RSC24L-CAB/A	RAL 7016	2,140.00	1	024004477

Beta R5 C24

1100 kg



h	↓ max
70 mm	25 kg
140 mm	30 kg
210 mm	30 kg

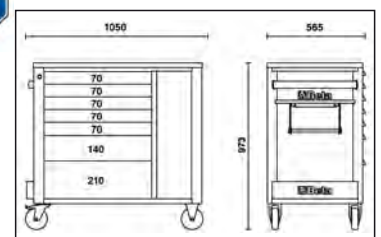
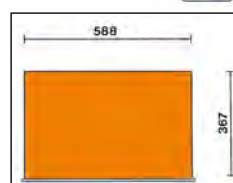

C04TSS-7

Servante mobile d'atelier à 7 tiroirs complètement en acier inoxydable

Caractéristiques principales :

- 7 tiroirs de 570 x 410 mm montés sur glissières à billes de précision ;
- 6 tiroirs - hauteur 83 mm ;
- 1 tiroir - hauteur 170 mm ;
- 4 roues de Ø 125 mm: 2 fixes et 2 pivotantes avec freins ;
- Serrure centralisée centrale ;
- Structure complètement en acier inoxydable ;
- Roues, supports, sphères, intérieur des tiroirs et glissières en acier inoxydable;
- Poignée tiroirs en aluminium.



700 kg

Beta
INOX
STAINLESS STEEL



63 kg

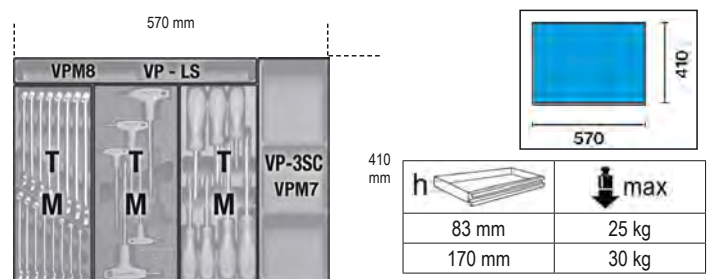

CHF

C04TSS/7 3,430.00 1 024003077 303

C25

Chariot Tank avec étagère

Caractéristiques principales:

- Couvercle de fermeture rabattable.
- 1 tiroir coulissant.
- Plateau de rangement des outils protégé par un tapis en caoutchouc souple.
- Plateaux de service protégés par des tapis en caoutchouc anti-huile et anti-essence.
- Quatre roues ø 100 mm: 2 fixes et 2 pivotantes (une avec frein).
- Serrure de sécurité.
- Plateau thermoformé vide pour douilles et accessoires 1/2" (024990104).
- Possibilité d'application du porte-papier 2499PC.

31,5 kg

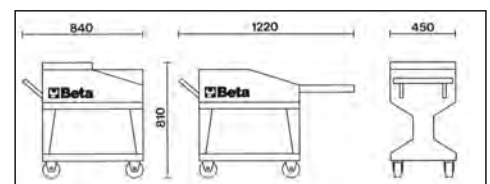

CHF

C25 888.00 1 025000001

RSC28

Etabli mobile SuperTank avec plan de travail en bois et 10 tiroirs

Caractéristiques principales:

- 10 tiroirs (588x367 mm) avec glissières à roulement à billes.
- Système rapide et sûr pour l'ouverture et la fermeture des tiroirs, avec façade en nylon et fibre de verre.
- 5 tiroirs latéraux : 4 tiroirs, 70 mm de haut 1 tiroir, 210 mm de haut.
- 5 tiroirs avant : 4 tiroirs, 70 mm de haut 1 tiroir, 210 mm de haut.
- Bases de tiroirs protégées par des tapis en caoutchouc moussé.
- 4 roulettes haute capacité, Ø 150 mm : 2 fixes et 2 directions avec freins.
- 2 serrures de sécurité centralisées.
- 3 tiroirs à outils avant.
- Plan de travail en bois multicouche avec trous pour un vice (1599F/150, à commander séparément).
- Compartiment à outils intégré.
- Compartiment latéral avec porte rabattable avec serrure.
- Porte-bouteilles intégrés.
- Compartiment de rangement de 135 mm de haut avec base recouverte de plastique.
- Capacité de charge statique : 1 200 kg.

**1200
kg**



RSC28-O

 130 kg



RSC28-A



RSC28-R



h	max
70 mm	25 kg
210 mm	30 kg

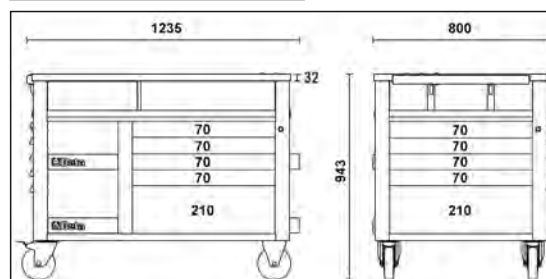
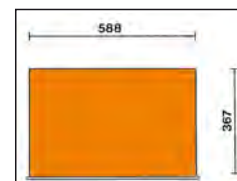

	CHF		
RSC28-O	3,760.00	1	028003001
RSC28-R	3,760.00	1	028003003
RSC28-A	3,760.00	1	028003007

C30M

Établi mobile MaxiTank

Caractéristiques principales:

- 5 tiroirs avant avec glissières à roulement à billes : 3 tiroirs (367x610 mm), 90 mm de haut 1 tiroir (588x610 mm), 90 mm de haut 1 tiroir (588x610 mm), 180 mm de haut.
- Système d'ouverture rapide avec façade en aluminium.
- Bases de tiroirs protégées par des tapis en caoutchouc moussé.
- Peut être équipé de plateaux thermoformés.
- Un vérin hydraulique, conçu pour soulever la partie avant sans effort, permettant ainsi un transport facile.
- 4 roulettes haute capacité : 2 directions, avant, Ø 150 mm 2 fixes, arrière, Ø 170 mm.
- Plan de travail résistant à l'huile et recouvert de caoutchouc, 1300x800 mm, avec trou de vidange pour la collecte des fluides dans un petit réservoir.
- Compartiment de rangement, 720x250x1300 mm, avec plan de travail revêtu de PVC et les panneaux coulissants avant.
- Serrure centralisée pour tiroirs et panneaux.
- 3 porte-bouteilles latéraux intégrés.
- Support de rouleau de papier intégré
- Capacité de charge statique : 1 800 kg.
- Peut accueillir un plan de travail en bois multicouche (3000M/PLM), à commander séparément
- Peut accueillir vice 1599F/150 (à commander séparément).

1800
kg



200
kg

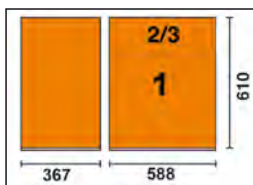

h	max
90 mm	30 kg
180 mm	35 kg

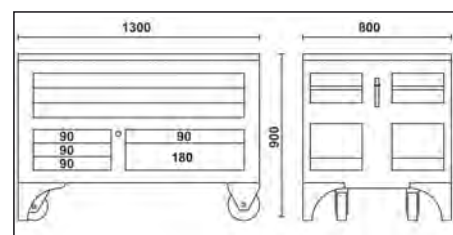

C30M

CHF 6,000.00 1 030000300

3000M/PLM

plan de travail en bois pour C30M, avec trous pour un étau (1599F/150)

10
kg



1240x740x26 mm

3000M/PLM

CHF 583.00 1 030000350



FONCTIONNEL ET ROBUSTE



- Tiroirs coulissants
- Serrure de sécurité centralisé frontale
- Possibilité d'incorporer un plan de travail et des séparateurs de tiroirs (non inclus)
- Capacité de charge statique : 1200 kg

Modèles disponibles:

- C35/6GM (6 tiroirs)
- C35/7GM (7 tiroirs)
- C35/8GM (8 tiroirs)
- C35/9GM (9 tiroirs)

Accessoires disponibles :



C35/6GM

Coffre fixe industriel avec 6 tiroirs

Caractéristiques principales :

- 6 tiroirs entièrement amovibles (600x447 mm) :

2 tiroirs, 75 mm de haut

1 tiroir, 100 mm de haut

1 tiroir, 150 mm de haut

1 tiroir, 200 mm de haut

1 tiroir, 300 mm de haut

- Serrure de sécurité centralisée à l'avant.

- Prédiposition pour plan de travail et séparateurs pour tiroirs (à commander séparément)

75 kg



h	↓ max
75 mm	70 kg
100 mm	70 kg
150 mm	70 kg
200 mm	70 kg
300 mm	70 kg

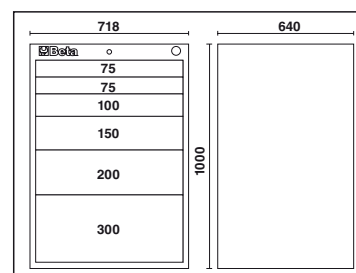
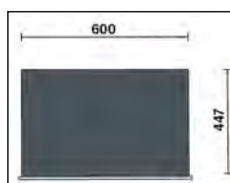

C35/6GM

CHF 2,420.00 1 035000162

C35/7GM

Coffre fixe industriel avec 7 tiroirs

Caractéristiques principales :

- 7 tiroirs entièrement amovibles (600x447 mm) :
- 2 tiroirs, 75 mm de haut
- 1 tiroir, 100 mm de haut
- 3 tiroirs, 150 mm de haut
- 1 tiroir, 200 mm de haut
- Serrure de sécurité centralisée à l'avant.
- Prédiposition pour plan de travail et séparateurs pour tiroirs (à commander séparément)

82 kg

C35/7GM CHF 2,520.00 1 035000172



h	max
75 mm	70 kg
100 mm	70 kg
150 mm	70 kg
200 mm	70 kg

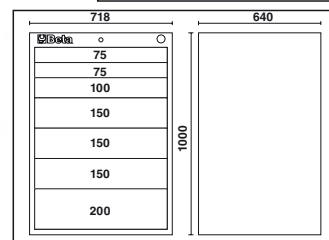

C35/8GM

Coffre fixe industriel avec 8 tiroirs

Caractéristiques principales :

- 8 tiroirs entièrement amovibles (600x447 mm) :
- 4 tiroirs, 75 mm de haut
- 1 tiroir, 100 mm de haut
- 2 tiroirs, 150 mm de haut
- 1 tiroir, 200 mm de haut
- Serrure de sécurité centralisée à l'avant.
- Prédiposition pour plan de travail et séparateurs pour tiroirs (à commander séparément)

86 kg

C35/8GM CHF 2,690.00 1 035000182



h	max
75 mm	70 kg
100 mm	70 kg
150 mm	70 kg
200 mm	70 kg

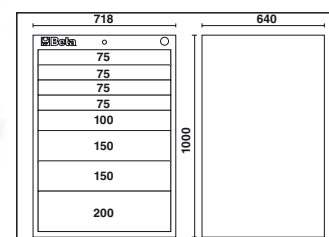

C35/9GM

Coffre fixe industriel avec 9 tiroirs

Caractéristiques principales :

- 9 tiroirs entièrement amovibles (600x447 mm) :
- 6 tiroirs, 75 mm de haut
- 3 tiroirs, 150 mm de haut
- Serrure de sécurité centralisée à l'avant.
- Prédiposition pour plan de travail et séparateurs pour tiroirs (à commander séparément)

91 kg

C35/9GM CHF 2,820.00 1 035000192



h	max
75 mm	70 kg
150 mm	70 kg

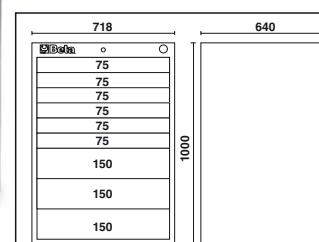

3500/P-M

Plan de travail avec rebord périmétral pour coffre C35

3500/P-M 700x600 mm CHF 470.00 1 035000505



PARE-CHOCS SOUPLE

- Tiroirs montés sur glissières à roulement à billes de précision
- Plan de travail polyvalent robuste
- Tiroir à ouverture complète équipée de palette en aluminium pour une ouverture rapide
- Plan de travail multifonction avec bords anti-chute équipé de d'emplacements pour le rangement des tournevis
- Quatre roulettes Ø 125 mm : 2 fixes et 2 mobiles (dont une équipée d'un frein)
- Capacité de charge statique : 1000 kg
- Pare-chocs angulaires sur toute la hauteur de la servante afin d'éviter d'endommager les véhicules ou la servante à l'intérieur de l'atelier
- Intérieur des tiroirs protégés par un tapis en caoutchouc mousse
- Serrure de sécurité centralisée frontale
- Porte-flacons et support de rouleau papiers intégrés et réglables dans plusieurs positions

Modèles disponibles :

- C37/6 (6 tiroirs)
- C37/7 (7 tiroirs)
- C37/8 (8 tiroirs)
- C37A/7 (7 tiroirs avec système anti-basculement)

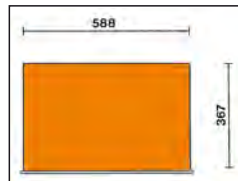

Couleurs disponibles :

O	RAL 2011
G	RAL 7016
R	RAL 3000

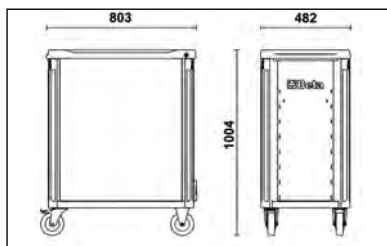

Accessoires disponibles :



3700/PLA



3700/PLL



3700/PF



3700/PFL

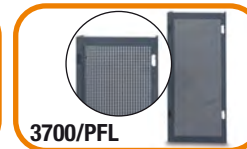

3700/PC



C37/7

Servante mobile d'atelier à 7 tiroirs

Caractéristiques principales :

- 7 tiroirs de 588x367 mm, montés sur glissières à billes de précision :
- 5 tiroirs hauteur 75 mm
- 1 tiroir hauteur 150 mm
- 1 tiroir hauteur 225 mm

71 kg

1000 kg



C37/7-O



C37/7-G



C37/7-R



	CHF		
C37/7-O	1,645.00	1	037000071
C37/7-G	1,645.00	1	037000072
C37/7-R	1,645.00	1	037000073

h	max
75 mm	30 kg
150 mm	35 kg
225 mm	35 kg

C37/6

Servante mobile d'atelier
à 6 tiroirs

Caractéristiques principales :
• 6 tiroirs de 588x367 mm, montés
sur glissières à billes de précision :
4 tiroirs hauteur 75 mm
1 tiroir hauteur 150 mm
1 tiroir hauteur 305 mm

1000
kg



C37/6-O

69 kg

	CHF		
C37/6-O	1,585.00	1	037000061
C37/6-G	1,585.00	1	037000062
C37/6-R	1,585.00	1	037000063



C37/6-G



C37/6-R



h	max
75 mm	30 kg
150 mm	35 kg
305 mm	40 kg



C37/8

Servante mobile d'atelier
à 8 tiroirs

Caractéristiques principales :
• 8 tiroirs de 588x367 mm, montés
sur glissières à billes de précision :
6 tiroirs hauteur 75 mm
2 tiroirs hauteur 150 mm

1000
kg



C37/8-O

73 kg

	CHF		
C37/8-O	1,705.00	1	037000081
C37/8-G	1,705.00	1	037000082
C37/8-R	1,705.00	1	037000083



C37/8-G



C37/8-R



h	max
75 mm	30 kg
150 mm	35 kg



C37A/7

Servante mobile d'atelier
à 7 tiroirs avec système anti-basculement

Caractéristiques principales :
• 7 tiroirs de 588x367 mm, montés sur glissières à
billes de précision :
5 tiroirs hauteur 75 mm
1 tiroir hauteur 150 mm
1 tiroir hauteur 225 mm

1000
kg



C37A/7-O

71 kg

	CHF		
C37A/7-O	1,685.00	1	037000271
C37A/7-G	1,685.00	1	037000272
C37A/7-R	1,685.00	1	037000273



C37A/7-G



C37A/7-R



h	max
75 mm	30 kg
150 mm	35 kg
225 mm	35 kg



3700/PLA

Établi en acier inoxydable pour servante C37

📦 2,8 kg

3700/PLA **CHF** 95.50 1 037000100



3700/PLL

Plan de travail en bois pour chariot C27

Avec possibilité de placer un étau 1599P/100 (à commander séparément)

📦 3,9 kg

3700/PLL **CHF** 119.50 1 037000101



672x396x28 mm

3700/PF

Panneau perforé avec supports pour servante C37

📦 3,2 kg

3700/PF **CHF** 95.00 1 037000102



3700/PFL

Panneau perforé latéral pour servante C37

📦 1,9 kg

3700/PFL **CHF** 51.00 1 037000104



3700/PC

Support porte-ordinateur pour servante C37

📦 3,1 kg

3700/PC **CHF** 129.50 1 037000103



C38

Servante mobile d'atelier
à onze tiroirs

Caractéristiques principales:

- 11 tiroirs montés sur glissières à billes de précision :
- 1 tiroir 937x410x122 mm
- 3 tiroirs 570x410x74 mm
- 2 tiroirs 570x410x153 mm
- 3 tiroirs 313x410x74 mm
- 2 tiroirs 313x410x153 mm
- Fond des tiroirs protégé par un tapis en néoprène.
- Capacité de charge statique : 1200 kg.
- 4 roues haute capacité : Ø 125 mm, 2 fixes et 2 pivotantes (toutes les deux avec frein à levier).
- Verrouillage de sécurité centralisé frontal.
- Plan de travail en tôle revêtue d'un tapis en caoutchouc.
- Possibilité d'application du porte-papier 2499PC et du porte-flacons 2499PF.

114 kg



C38-G

C38-R

C38-O



h	max
74 mm	25 kg
153 mm	30 kg

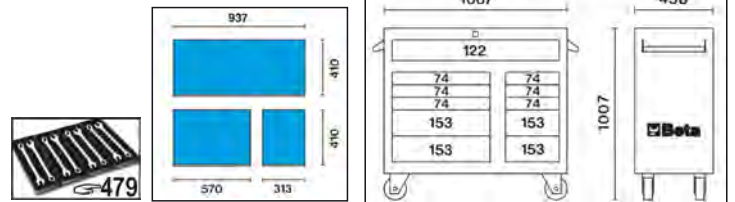

	CHF		
C38-O	2,600.00	1	038000001
C38-G	2,600.00	1	038000003
C38-R	2,600.00	1	038000002

C38L

coffre latéral à 7 tiroirs

Caractéristiques principales :

- 7 tiroirs (410x313 mm), montés sur glissières à billes de précisions :
- 5 tiroirs d'une hauteur de 74 mm 2 tiroirs d'une hauteur de 153 mm
- Fond des tiroirs protégé par un tapis en Néoprène
- Verrouillage de sécurité centralisé frontale
- Plan de travail en Aluminium antidérapant
- Possibilité d'être fixé de chaque côté de la servante C38

45 kg

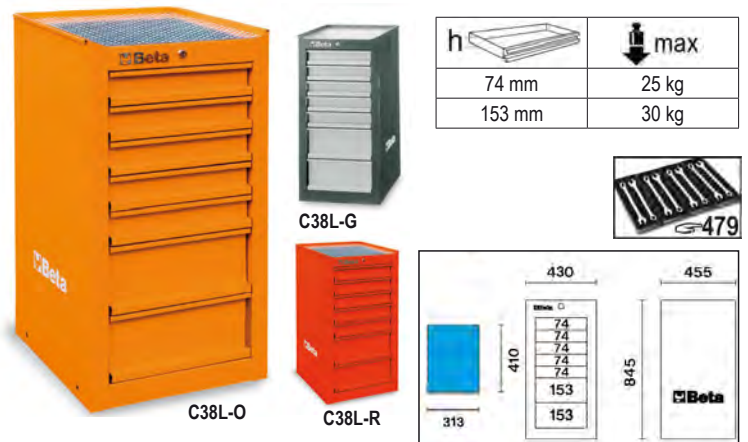

C38L-G

C38L-R

h	max
74 mm	25 kg
153 mm	30 kg

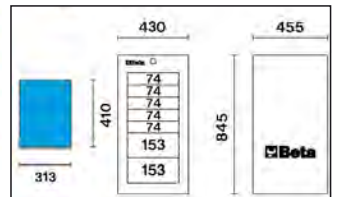

	CHF		
C38L-O	1,255.00	1	038000081
C38L-G	1,255.00	1	038000083
C38L-R	1,255.00	1	038000082

C38LA

Coffre latéral avec porte et étagère interne

Caractéristiques principales:

- Serrure centralisée frontale
- Étagère interne réglable en hauteur
- Porte documents située à l'intérieur du panneau
- Plan de travail en aluminium antidérapant
- Possibilité d'être fixé de chaque côté de la servante C38

18 kg



C38LA-G

C38LA-R

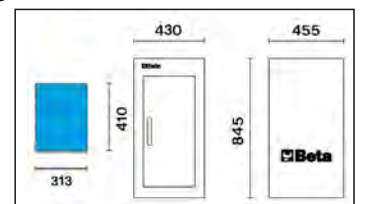

	CHF		
C38LA O	480.00	1	038000071
C38LA G	480.00	1	038000073
C38LA R	480.00	1	038000072

C38C

Servante mobile d'atelier à 25 tiroirs, avec :

- 1 servante mobile C38
- 2 coffres latéraux C38L
- 1 coffre C38T

268 kg



C38C-O



C38C-G



C38C-R



h	max
74 mm	25 kg
153 mm	30 kg

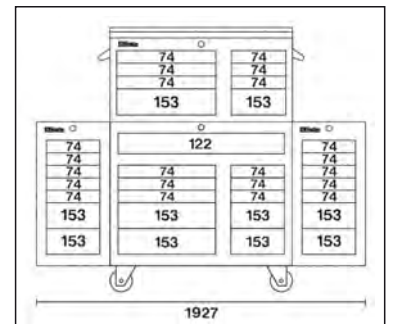
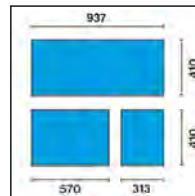

	CHF		
C38C-O	6,750.00	1	038000201
C38C-G	6,750.00	1	038000203
C38C-R	6,750.00	1	038000202

C38T

coffre à 8 tiroirs et compartiment porte outils

Caractéristiques principales :

- 8 tiroirs montés sur glissières à billes de précisions :
- 3 tiroirs 570X410X74mm
- 1 tiroir 570X410X153mm
- 3 tiroirs 313x410x74mm
- 1 tiroir 313x410x153mm

Compartiment porte-outils assisté de 2 verins • Fond des tiroirs protégé par un tapis en Néoprène

- Verrouillage de sécurité centralisé frontale
- Plan de travail en Aluminium antidérapant
- Possibilité d'être posé sur la servante C38

64 kg



C38T-O



C38T-G



C38T-R

h	max
74 mm	25 kg
153 mm	30 kg

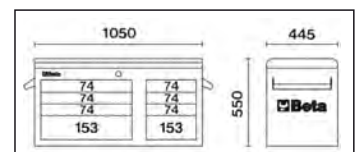
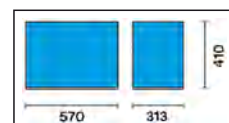

	CHF		
C38T-O	1,635.00	1	038000091
C38T-G	1,635.00	1	038000093
C38T-R	1,635.00	1	038000092

SERVANTE C39

MONTANTS ET PALETTES DES TIROIRS EN ALLIAGE D'ALUMINIUM + ROBUSTE ET + LÉGÈRE

- Tiroirs montés sur glissières à roulement à billes de précision
- Plan de travail multifonction thermoplastique, conçu pour supporter le coffre à outils portable C39T
- Système de palette en aluminium, pour une ouverture rapide du tiroir et s'ouvrant sur toute la longueur.
- Quatre roulettes Ø 125 mm : 2 fixes et 2 mobiles (dont une d'un frein)
- Capacité de charge statique : 1200 kg
- Intérieur des tiroirs protégés par un tapis en caoutchouc mousse
- Serrure de sécurité centralisé frontale
- Compartiments de rangement et emplacement pour tournevis
- Porte-flacon latéraux et arrière intégrés
- Support de rouleau de papier intégré

Modèles disponibles :

- C39/6 (6 tiroirs)
- C39/7 (7 tiroirs)
- C39/8 (8 tiroirs)

Couleurs disponibles :

	
O	RAL 2011
G	RAL 7016
R	RAL 3000

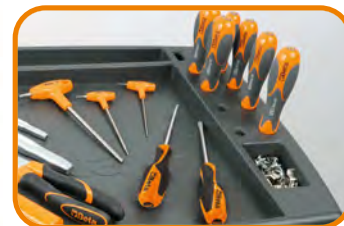
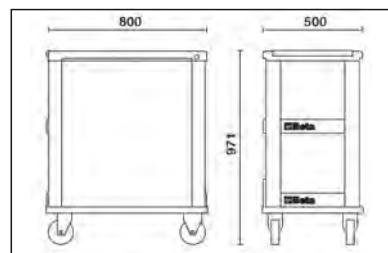
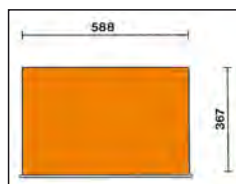

C39/7

Servante mobile à sept tiroirs

Caractéristiques principales:

- Sept tiroirs de 588x367 mm, montés sur glissières à billes de précision:
- 5 tiroirs hauteur 70 mm
- 1 tiroir hauteur 140 mm
- 1 tiroir hauteur 210 mm.

61 kg

1200 kg



C39-7/G



C39-7/R

C39-7/O

	CHF		
C39-7/O	2,475.00	1	039000001
C39-7/G	2,475.00	1	039000002
C39-7/R	2,475.00	1	039000003

h	max
70 mm	30 kg
140 mm	35 kg
210 mm	35 kg



C39/6

Servante mobile d'atelier

Caractéristiques principales :

- 6 tiroirs de 588x367 mm, montés sur glissières à billes de précision :
- 4 tiroirs hauteur 70 mm
- 1 tiroir hauteur 140 mm
- 1 tiroir hauteur 280 mm

📦 59 kg

	CHF	📦	💻
C39-6/O	2,345.00	1	039000031
C39-6/G	2,345.00	1	039000032
C39-6/R	2,345.00	1	039000033



1200 kg

C39-6/O



C39-6/G



C39-6/R



h	max
70 mm	30 kg
140 mm	35 kg
280 mm	40 kg



C39/8

Servante mobile d'atelier à huit tiroirs

Caractéristiques principales :

- 8 tiroirs de 588x367 mm, montés sur glissières à billes de précision :
- 6 tiroirs hauteur 70 mm
- 2 tiroirs hauteur 140 mm

📦 64 kg

	CHF	📦	💻
C39-8/O	2,640.00	1	039000041
C39-8/G	2,640.00	1	039000042
C39-8/R	2,640.00	1	039000043



1200 kg

C39-8/O



C39-8/G



C39-8/R



h	max
70 mm	30 kg
140 mm	35 kg



C39T

Coffre à quatre tiroirs

Caractéristiques principales :

- 4 tiroirs (588x367 mm), montés sur glissières à billes de précision :
- 4 tiroirs hauteur 70 mm
- Serrure centralisée frontale.
- Montants et façade du tiroir en aluminium.

📦 29 kg

	CHF	📦	💻
C39T-O	1,585.00	1	039000101
C39T-G	1,585.00	1	039000102
C39T-R	1,585.00	1	039000103



C39T-O



C39T-R

C39T-G



📦 29 kg

h	max
70 mm	30 kg

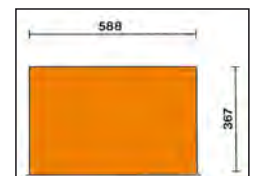
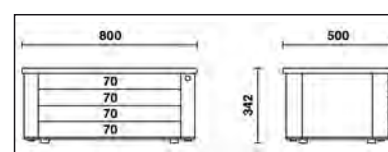

2400-COVER RSC24

housse en nylon pour servante RSC24, RSC24A, C39

2400-COVER RSC24 CHF 32.00 1 024000910



2400-COVER RSC24AXL

housse en nylon pour servante RSC24A-XL, RSC24L, RSC24L-CAB

2400-COVER RSC24AXL CHF 44.00 1 024000930



3700-COVER C37

Housse de protection en nylon pour servante C37

3700-COVER C37 CHF 42.00 1 037000930



Beta

C39SM

Servante spéciale mobile type Racing SM

Caractéristiques techniques

- Plan de travail en bois contre-plaqué stratifié
- 4 roues Ø 125 mm
- 2 fixes et 2 pivotantes (une avec frein) avec plinthes rabattables cache-roues
- Capacité de charge statique : 1200 kg

Module avec 7 tiroirs

de 588x367 mm, montés sur glissières à billes de précision :

- 6 tiroirs hauteur 70 mm
- 1 tiroir hauteur 240 mm
- Fonds des tiroirs protégés par un tapis en Néoprene.
- Serrure de sécurité centralisée frontale.
- Système d'ouverture positionné sur toute la longueur du tiroir.
- Façade des tiroirs en aluminium.

Module de service

- Poubelle incorporée
- Compartiment pour rouleau de papier
- 1 soute porte-objets 420x305x270 mm

125 kg

		CHF		
C39SM-O	RAL 2011	4,020.00	1	039390001
C39SM-G	RAL 7016	4,020.00	1	039390002
C39SM-R	RAL 3000	4,020.00	1	039390003

1200 kg



C39SM-G



C39SM-R



C39SM-O



h	max
70 mm	30 kg
240 mm	40 kg

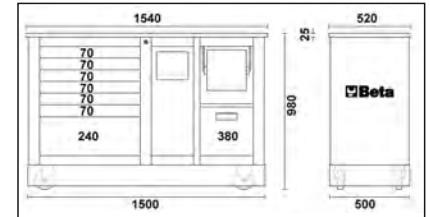
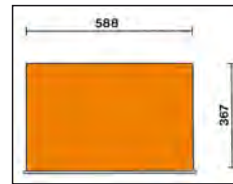

C39MD

Servante spéciale mobile type Racing MD

Caractéristiques techniques

- Plan de travail en bois contre-plaqué stratifié
- 4 roues Ø 125 mm
- 2 fixes et 2 pivotantes (une avec frein) avec plinthes rabattables cache-roues
- Capacité de charge statique : 1200 kg

Module avec 7 tiroirs

de 588x367 mm, montés sur glissières à billes de précision :

- 6 tiroirs hauteur 70 mm
- 1 tiroir hauteur 240 mm
- Fonds des tiroirs protégés par un tapis en Néoprene.
- Serrure de sécurité centralisée frontale.
- Système d'ouverture positionné sur toute la longueur des tiroirs.
- Façade des tiroirs en aluminium.

Module avec 2 tiroirs

de 588x367x270 mm et 588x367x380 mm, montés sur glissières à billes de précision

- Fonds des tiroirs protégés par un tapis en Néoprene
- Serrure de sécurité centralisée frontale
- Système d'ouverture positionné sur toute la longueur des tiroirs
- Façade des tiroirs en aluminium.

123 kg

		CHF		
C39MD-O	RAL 2011	4,140.00	1	039390101
C39MD-G	RAL 7016	4,140.00	1	039390102
C39MD-R	RAL 3000	4,140.00	1	039390103

1200 kg



C39MD-G



C39MD-R



C39MD-O



h	max
70 mm	30 kg
240 mm	40 kg

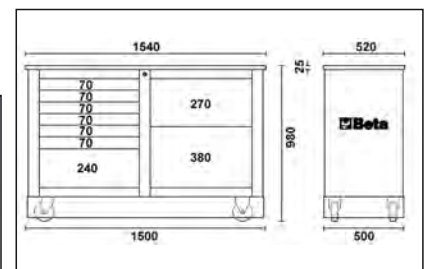
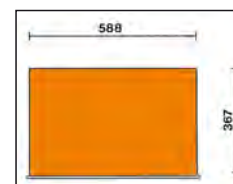

C41S

Chariot porte-outils
à deux modules superposables

Caractéristiques principales:

- Structure en tôle d'acier et volet de fermeture en matière plastique: très robuste et léger.
- 2 modules séparables:
 - 1 coffre supérieur,
 - 1 module avec 1 tiroir de 95 mm de haut et 1 tiroir de 295 mm de haut.
- Roues de grand diamètre (160 mm), incorporées dans la structure pour faciliter le déplacement également dans les escaliers.
- Serrure centralisée latérale pour la fermeture des 2 tiroirs du module inférieur.
- Tiroirs montés sur glissières télescopiques avec roulement à billes et double crochet de fermeture.
- Poignée télescopique en aluminium.
- Plateau de rangement incorporé dans le coffre supérieur.
- Tiroir du bas avec double glissière de précision

Assortiments préconisés: 5940/SBK et 5915VU/5

16 kg

C41S	CHF	682.00	1	041000001
------	-----	--------	---	-----------

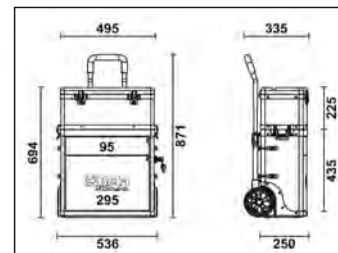
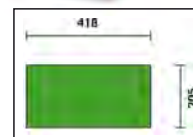

C41H

Chariot porte-outils à deux modules superposables

Caractéristiques principales:

- Structure en tôle d'acier et volet de fermeture en matière plastique: très robuste et léger.
- 2 modules séparables:
 - 1 coffre supérieur,
 - 1 module avec 2 tiroirs de 95 mm de haut, 1 tiroir amovible en matière plastique de 66 mm de haut et 1 tiroir de 295 mm de haut.
- Roues de grand diamètre (160 mm), incorporées dans la structure pour faciliter le déplacement également dans les escaliers.
- Serrure centralisée latérale pour la fermeture des tiroirs du module inférieur.
- Tiroirs montés sur glissières télescopiques avec roulement à billes et double crochet de fermeture.
- Poignée télescopique en aluminium.
- Plateau de rangement incorporé dans le coffre supérieur.
- Tiroir du bas avec double glissière de précision

Assortiments préconisés: 5941VU/M, 5940/SBK et 5915VU/5

* Couleurs disponibles sur demande

21 kg

		CHF		
C41H-O	RAL 2011	771.00	1	041000002
C41H-N	RAL 9005	771.00	1	041000005
C41H-B	RAL 5002	771.00	1	041000006
C41H-R	RAL 3000	771.00	1	041000008
C41H-G	RAL 7016	771.00	1	041000010
C41H-Y	RAL 1023	771.00	1	041000012
C41H-W	RAL 9016	771.00	1	041000021
C41H-V	RAL 6016	771.00	1	041000024



C41H-O



C41H-W

C41H-Y

C41H-R

C41H-V

C41H-B

C41H-G

C41H-N

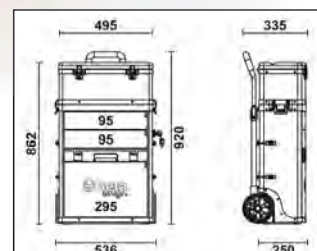
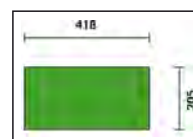

C41H/CE

Coffret porte-outils avec séparateurs amovibles pour accessoires,
en matière plastique

1,3 kg

C41H/CE	CHF	48.50	1	041000916
---------	-----	-------	---	-----------



C42H

Chariot porte-outils à 3 modules superposables

Caractéristiques principales :

- Structure en tôle d'acier et volet de fermeture en matière plastique : très robuste et léger.
- 3 modules séparables :
 - 1 coffre supérieur, hauteur 220 mm
 - 1 module porte-outils central, hauteur 180 mm
 - 1 module porte-outils inférieur avec roues, hauteur 330 mm.
- Roues de gros diamètre (ø 160 mm).
- Poignée télescopique réglable en 3 positions
- Système de décrochage rapide des modules : accès rapide et facile aux différents compartiments porte-outils.
- Panier supérieur avec compartiment porte-objets interne et 3 porte-outils incorporés dans le couvercle.
- Prévu pour être utilisé seulement avec 2 modules.

Assortiments préconisés: 5940/SBK et 5915VU/5

14 kg

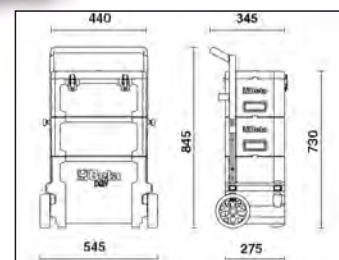

C42H

CHF 548.00 1 042000002

Beta

CX49-G

Chariot multifonction

Utilisable comme poste de travail mobile pour instruments de diagnostic, ordinateurs portables, testeurs et chargeurs de batterie.

CARACTÉRISTIQUES

- Structure en tôle vernie : stabilité et solidité maximum
- Poignée ergonomique
- Plan d'appui supérieur sur 2 niveaux
- Tiroir extractible pour mini clavier
- 2 rayons centraux avec position réglable et 1 rayon bas fixe
- 4 enrouleurs pratiques latéraux en plastique
- 2 pratiques bacs de rangement latéraux
- 2 roues arrière fixes Ø 160 mm
- 2 roues avant pivotantes Ø 100 mm (dont une avec frein)
- Poids : 36 kg

CX49-G

CHF 1,017.00 1 049000102

1099 mm
460 mm
435 mm



CA49-G

Chariot multifonction avec porte

Utilisable comme poste de travail mobile pour instruments de diagnostic, ordinateurs portables, testeurs et chargeurs de batterie.

CARACTÉRISTIQUES

- Structure en tôle vernie : stabilité et solidité maximum
- Manche ergonomique
- Plan d'appui supérieur sur 2 niveaux
- Tiroir extractible pour mini clavier
- 1 rayon avec position réglable, 1 rayon fixe et porte de fermeture
- 4 pratiques enrouleurs de câbles latéraux en plastique
- 2 pratiques conteneurs latéraux
- 2 roues arrière fixes Ø 160 mm
- 2 roues avant pivotantes Ø 100 mm (une avec frein)
- Poids : 36,5 kg

CA49-G

CHF 1,142.00 1 049000112



1099 mm
460 mm
435 mm

4900-COVER C49

Housse de protection en nylon pour chariot multifonction C49

4900-COVER C49

CHF 48.50 1 049000930



C48M

Chariot à plate-forme électrique, avec barrières sur les 4 cotés.

Les dimensions compactes et une utilisation polyvalente font du chariot plateforme C48M la solution idéale pour la manutention de charges lourdes (caisses, conteneurs, objets encombrants, pièces d'équipement) en mode assisté en toute sécurité, y compris dans des zones difficilement accessibles et dans des environnements de travail qui ne sont pas accessibles par des chariots élévateurs.

Cela se traduit par une réduction significative des risques pour les opérateurs - par ex. troubles musculo-squelettiques causés par la manipulation manuelle de charges.

Plateforme motorisée, avec moteur 24V - 400W et alimentation 2x12V - 33Ah et carte de contrôle Curtis.

Plateforme de chargement en acier robuste, recouvert de caoutchouc antidérapant, avec panneaux tubulaires ronds empêchant les objets de tomber pendant le transport. Les panneaux peuvent être retirés pour répondre aux besoins de transport individuels.

La console de commande est équipée des éléments suivants:

- la clé de contact
- bouton de réglage de la vitesse
- poignées papillon latérales pour le contrôle de la traction
- bip intermittent, qui est activé lors du déplacement en marche arrière
- indicateur de charge de la batterie
- bouton de coupure du frein électrique
- bouton d'arrêt d'urgence.

Equipé de 2 roues de traction pneumatiques (Ø 260 mm) et de 2 roues pivotantes en caoutchouc (Ø 150 mm), frein électromagnétique et différentiel.

Livré avec un chargeur de batterie externe, 220V / 50Hz - V / A 24/12

SPÉCIFICATIONS FONCTIONNELLES

Capacité de charge: 400 kg

Vitesse de conduite: 4-6 km / h (réglable)

Autonomie de la batterie: 4 heures

Pente maximale autorisée à pleine charge: 6%

Pente maximale autorisée avec une charge de 100 kg: 18%

Dispositifs de sécurité:

Frein électronique

Avertisseur sonore

Protection anti-écrasement

Indicateur de charge de la batterie

Chariot de contrôle Curtis

SPÉCIFICATIONS TECHNIQUES

Dimensions hors tout: 1280x630x1100h mm

Dimensions utiles de la plate-forme de chargement avec panneaux: 1180x580 mm

Dimensions utiles de la plate-forme de chargement sans panneaux: 1260x620 mm

Hauteur de la plate-forme de chargement à partir du sol: 320 mm

Hauteur du compartiment à piles par rapport au sol: 65 mm

Poids avec batteries: 140 kg

140 kg

Beta
BRUTUS

400
kg

CE



C48M

CHF 3,710.00 1 048000230

C48P

Chariot pliable

Caractéristiques principales :

- Plateforme de chargement en polypropylène (PP) renforcé, revêtement antiglisse et inserts en TPV pour couvrir les saillies
- Poignée pliable pour un stockage rapide et peu encombrant
- 4 roues anti-traces Ø 125 mm : 2 fixes et 2 pivotantes avec freins
- Capacité maximum : 300 kg.
- Largeur utile de la plateforme de chargement : 705 mm
- Profondeur de la plateforme de chargement : 480 mm
- Hauteur de la plateforme de chargement : 200 mm



300
kg



11 kg

C48P CHF 348.00 1 048000030

C51

Chariot d'atelier métallique

- 3 plateaux revêtus de caoutchouc antidérapant
- Poignée ergonomique
- Double possibilité de fixation du plateau central
- 4 roues Ø 100 mm: 2 fixes et 2 pivotantes (dont une avec frein)
- Capacité de charge statique : 200 kg. (réparties sur les 3 étagères)

📦 21 kg

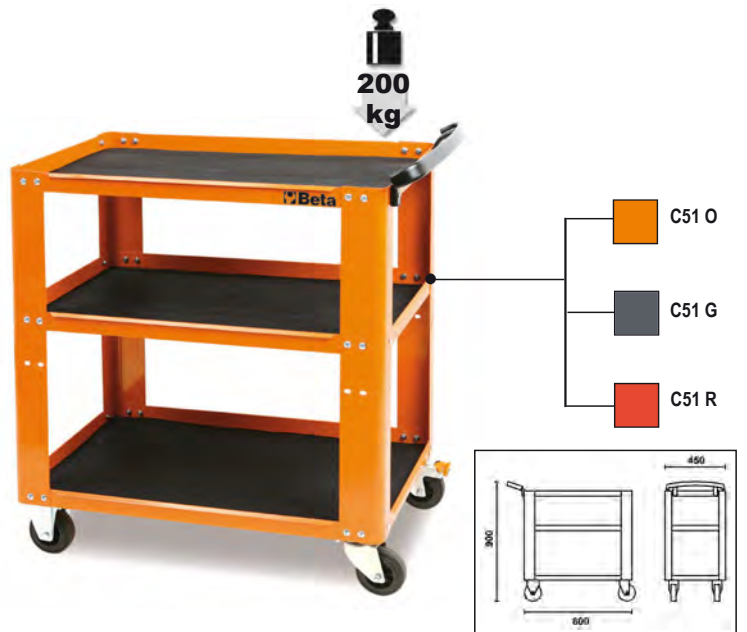

		CHF	📦	🏠
C51 O	RAL 2011	388.00	1	051000001
C51 G	RAL 7016	388.00	1	051000002
C51 R	RAL 3000	388.00	1	051000003

RSC51

Chariot de service d'atelier à 3 tiroirs

Caractéristiques principales :

- Plan de travail renforcé en ABS, solide et robuste
 - Plateau polyvalent avec bords antichute et 8 trous pour accueillir les tournevis
 - 3 tiroirs (588x367 mm) avec glissières à roulement à billes, 70 mm de haut
 - Bases de tiroirs protégées par des tapis en caoutchouc moussé
 - Chaque tiroir peut accueillir jusqu'à 4 plateaux thermoformés en mousse EVA ou ABS
 - Serrure de sécurité centralisée à l'avant
 - Pratique porte-tournevis latéral inclus
 - Deux porte-spray aérosol latéraux intégrés dans la structure
 - Grande étagère inférieure protégée par un tapis en caoutchouc imperméable à l'huile et à l'essence
 - Quatre roulettes, Ø 125 mm: 2 fixes et 2 directions (une avec frein)
- Capacité de charge statique : 400 kg
• Portée de chaque tiroir : 15 kg distribués de manière uniforme



📦 38 kg

		CHF	📦	🏠
RSC51-FO	RAL 2011	775.00	1	051000300
RSC51-R	RAL 3000	775.00	1	051000303
RSC51-A	RAL 7016	775.00	1	051000307

2400 RSC24/MP

Étagère pliable pour RSC24, RSC24A, RSC24AXLP/7, RSC51

- Utilisable comme plan de travail supplémentaire
- Plan de travail de 390x440 mm, protégé par un tapis en caoutchouc imperméable à l'huile et à l'essence
- Capacité de charge : 20 kg

📦 3,4 kg

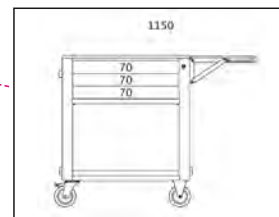

CHF 96.50 1 024004900

2400 RSC24/MP

CP51

Chariot charges lourdes

- 2 étagères recouvertes de tapis en caoutchouc
- Poignée ergonomique
- Quatre roues Ø 125 mm à haute résistance : 2 fixes et 2 pivotantes avec frein
- Capacité de charge statique : 750 kg (distribuée sur 2 étagères)

📦 37 kg

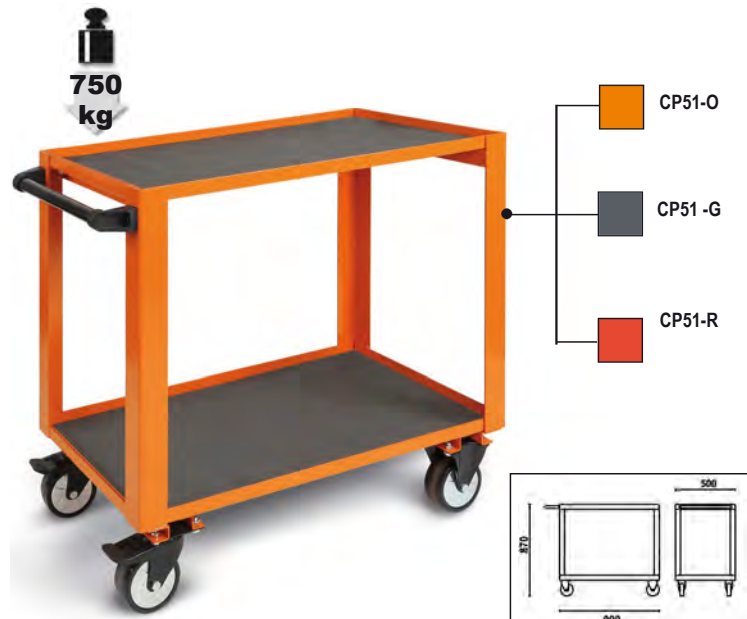

CHF 513.00 1 051000501
513.00 1 051000502
513.00 1 051000503

CP51 O RAL 2011
CP51 G RAL 7016
CP51 R RAL 3000

CB52

Chariot pour la maintenance des boîtes de vitesses et transmissions avec récupérateur d'huile

Le plan incliné et les trous d'écoulement permettent la récupération des liquides directement dans la cuve de collecte

Doté de :

- 4 roues pivotantes dont 2 avec frein
- grand tiroir de rangement avec séparateur
- cuve de collecte liquides extractible avec capacité 7 litres

Dimensions : 1200x640x870 mm

Poids : 60 kg

📦 60 kg



CHF 981.00 1 052000201

CB52-O

C56P O

Établi pliable

Compact et facile à transporter.

Plan de travail de 800x500mm (épaisseur 30 mm) en MDF et tôle galvanisée, utilisable des deux côtés.

Poignée avec protection en caoutchouc pour un transport aisé.

Pieds avec couverture antidérapante.

Capacité de charge statique : 250 kg

📦 25 kg

250 kg

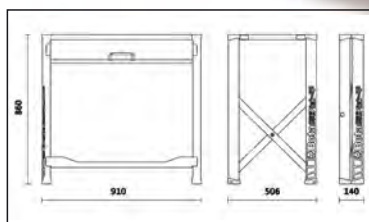

C56P O

CHF 541.00 1 056000011

C56PL O

Établi pliable, version légère

Léger, compact et facile à transporter.

Plan de travail de 800x500 mm en tôle galvanisée utilisable d'un seul côté, protégé par un revêtement en caoutchouc de protection contre l'huile et l'essence.

Poignée avec protection en caoutchouc pour un transport aisé.

Pieds avec revêtement antiglisse.

Capacité de charge statique : 200 kg

📦 18,5 kg

200 kg

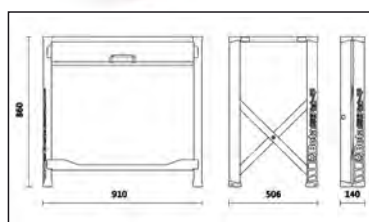

C56PL O

CHF 467.00 1 056000021

C54S

Armoires Cargo

Ce modèle a été conçu après de longues recherches auprès des utilisateurs professionnels. Il offre la solution idéale pour un travail rationnel. Deux panneaux perforés fixés sur les portes peuvent s'ouvrir et augmenter la capacité de rangement.

Caractéristiques principales:

- 1 tiroir grande capacité monté sur glissières télescopiques.
- Possibilité de modifier la disposition intérieure des outils à fin de répondre aux exigences les plus spécifiques.
- Fixation murale simplifiée en utilisant les 2 emplacements situés derrière l'armoire.
- Verrouillage de sécurité centralisé pour les portes et le tiroir.
- Plateau thermoformé vide pour douilles et accessoires 1/2".



C54S-O

37 kg

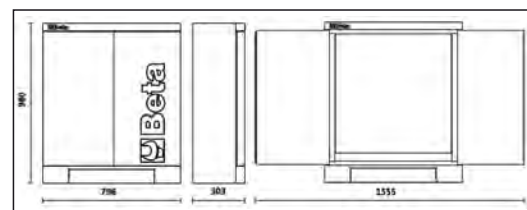

C54S-O

RAL 2011

CHF 980.00 1 054000301

 **Beta**

C57SA

Établi MasterCargo

- Modèle avec paroi porte-outils (C57P) et un bloc à tiroirs.

Bloc à tiroirs composé de 5 tiroirs de 588x367 mm dont 3 de 90 mm de haut, 1 de 180 mm de haut et 1 de 280 mm, montés sur glissières à billes de précision. Prévu pour l'insertion de plateaux thermoformés. Serrure centralisée.

Paroi porte-outils avec 2 trous à l'arrière pour la fixation au mur. Volet roulant en aluminium à mouvement vertical avec serrure de sécurité. Trois panneaux perforés amovibles pour le support des outils.

Plan de travail en bois contre-plaqué stratifié, avec revêtement en laminé plastique, avec 3 trous pour l'installation d'un étau 1599F/150 (en option).



C57SA-O

205 kg



C57SA-G



C57SA-R



h	max
90 mm	30 kg
180 mm	40 kg
280 mm	40 kg

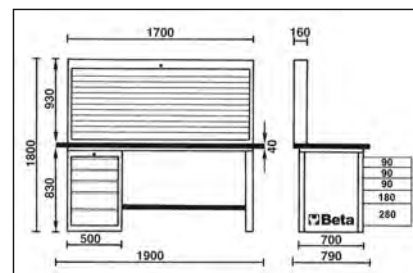

		CHF		
C57SA-O	RAL 2011	6,160.00	1	057001005
C57SA-G	RAL 7016	6,160.00	1	057001205
C57SA-R	RAL 3000	6,160.00	1	057001405

C57SD

Établi MasterCargo

- Modèle avec un bloc à tiroirs

Bloc à tiroirs composé de 5 tiroirs de 588x367 mm dont 3 de 90 mm de haut, 1 de 180 mm de haut et 1 de 280 mm, montés sur glissières à billes de précision. Prévu pour l'insertion de plateaux thermoformés. Serrure centralisée.

Plan de travail en bois contre-plaqué stratifié, avec revêtement en laminé plastique, avec 3 trous pour l'installation d'un étau 1599F/150 (en option).



C57SD-O



h	max
90 mm	30 kg
180 mm	40 kg
280 mm	40 kg



C57SD-G



C57SD-R

158 kg

		CHF		
C57SD-O	RAL 2011	4,350.00	1	057001004
C57SD-G	RAL 7016	4,350.00	1	057001204
C57SD-R	RAL 3000	4,350.00	1	057001404

C57SB

Établi MasterCargo

- Modèle avec paroi porte-outils (C57P) et deux blocs à tiroirs.

Bloc à tiroirs composé de 5 tiroirs de 588x367 mm dont 3 de 90 mm de haut, 1 de 180 mm de haut et 1 de 280 mm, montés sur glissières à billes de précision. Prévus pour l'insertion de plateaux thermoformés. Serrure centralisée.

Paroi porte-outils avec 2 trous à l'arrière pour la fixation au mur. Volet roulant en aluminium à mouvement vertical, avec serrure de sécurité. Trois panneaux perforés amovibles pour le support des outils.

Plan de travail en bois contre-plaqué stratifié, avec revêtement en laminé plastique, avec 3 trous pour l'installation d'un étau 1599F/150 (en option).



1800 kg

C57S/B-O

243 kg



C57S/B-G

C57S/B-R



h	max
90 mm	30 kg
180 mm	40 kg
280 mm	40 kg

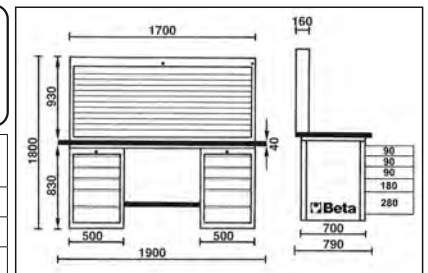

		CHF		
C57S/B-O	RAL 2011	7,680.00	1	057001006
C57S/B-G	RAL 7016	7,680.00	1	057001206
C57S/B-R	RAL 3000	7,680.00	1	057001406

C57SC

Établi MasterCargo

- Modèle avec deux blocs à tiroirs.

Bloc à tiroirs composé de 5 tiroirs de 588x367 mm dont 3 de 90 mm de haut, 1 de 180 mm de haut et 1 de 280 mm, montés sur glissières à billes de précision. Prévus pour l'insertion de plateaux thermoformés. Serrure centralisée.

Plan de travail en bois contre-plaqué stratifié, avec revêtement en laminé plastique, avec 3 trous pour l'installation d'un étau 1599F/150 (en option).



1800 kg

C57S/C-O



h	max
90 mm	30 kg
180 mm	40 kg
280 mm	40 kg



C57S/C-G

C57S/C-R

196 kg

		CHF		
C57S/C-O	RAL 2011	5,870.00	1	057001003
C57S/C-G	RAL 7016	5,870.00	1	057001203
C57S/C-R	RAL 3000	5,870.00	1	057001403

C57SP

Paroi porte-outils

Paroi porte-outils avec 3 trous à l'arrière pour la fixation au mur.
Volet roulant en aluminium, à mouvement vertical, avec serrure de sécurité.
Trois panneaux perforés amovibles pour le support des outils.

46 kg

		CHF		
C57SP-O	RAL 2011	1,810.00	1	057001020
C57SP-G	RAL 7016	1,810.00	1	057001220
C57SP-R	RAL 3000	1,810.00	1	057001420



C57SP G

C57SP R

5700LAMP

Lampe d'éclairage
pour établi MasterCargo

- Structure en tôle d'acier robuste formée de quatre éléments; munie de vis d'assemblage.
- Bande LED de 1120 lumens, 4000K, 14W
- Alimentation 230V.
- Fournie sans câble.

9 kg

	CHF		
5700LAMP	446.00	1	057000005

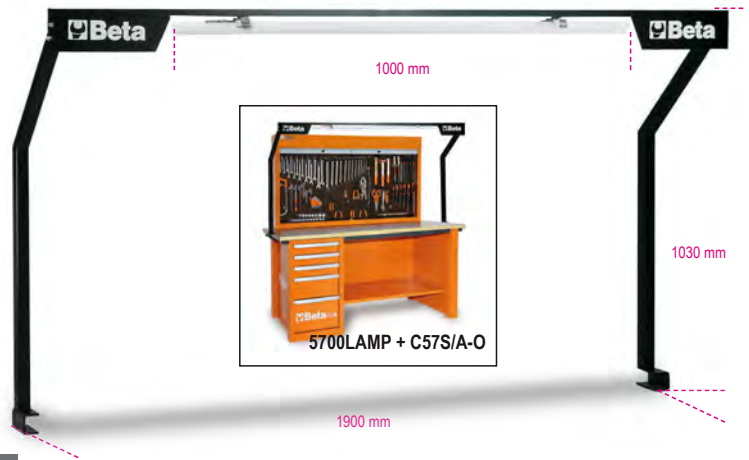

C58P

Paroi porte-outils

- Rideau déroulant verticalement en aluminium peint avec serrure de sécurité
- Deux panneaux perforés amovibles pour le support des outils

46,8 kg

		CHF		
C58P-O	RAL 2011	1,370.00	1	058000221
C58P-G	RAL 7016	1,370.00	1	058000222
C58P-R	RAL 3000	1,370.00	1	058000223



C58P-G



C58P-R



C58P-O

PV

Panneau mural porte-outils

	LxA mm		CHF		
PV1	1000x920	10,2	257.00	1	088880010
PV1,5	1500x920	14,2	340.00	1	088880015



C56W

Établi de travail avec plan en bois

- Plan de travail en bois contre-plaqué stratifié avec trous pour l'installation d'un étau (1599F/125 en option).
- Structure en acier avec 6 pieds de support
- Capacité de chargement : 1.200 kg
- Ajout possible de la paroi porte-outils C57P, non fixable au plan de travail
- Deux tiroirs dotés de serrure.
- Prévu pour la fixation au sol

📦 86 kg



		CHF	📦	🖨️
C56W-O	RAL 2011	1,510.00	1	056000251
C56W-G	RAL 7016	1,510.00	1	056000252
C56W-R	RAL 3000	1,510.00	1	056000253

C56B

Établi avec plan de travail en bois

Caractéristiques principales :

- Plan de travail en bois contre-plaqué stratifié avec trous pour l'installation d'un étau (1599F/125 en option).
- Structure en acier avec 4 pieds de support.
- Capacité de charge statique : 800 kg.
- Compartiment inférieur

📦 54,5 kg



		CHF	📦	🖨️
C56B-O	RAL 2011	899.00	1	056000401
C56B-G	RAL 7016	899.00	1	056000402
C56B-R	RAL 3000	899.00	1	056000403

C56

Établi de travail

- Plan de travail en tôle vernie avec bord périmétral
- Structure en acier avec 6 pieds de support
- Capacité de charge statique : 1.200 Kg
- Ajout possible de la paroi porte-outils C57P, non fixable au plan de travail.
- Deux tiroirs avec serrure.
- Prévu pour la fixation au sol.

📦 82 kg



		CHF	📦	🖨️
C56-O	RAL 2011	1,275.00	1	056000201
C56-G	RAL 7016	1,275.00	1	056000202
C56-R	RAL 3000	1,275.00	1	056000203

C56M

Établi

- Plan de travail bi-matières en aluminium anti-dérapant et en caoutchouc mat
- Capacité de chargement: kg.800
- Ajout possible de la paroi porte-outils C57P, non fixable au plan de travail.
- 3 tiroirs avec serrure.

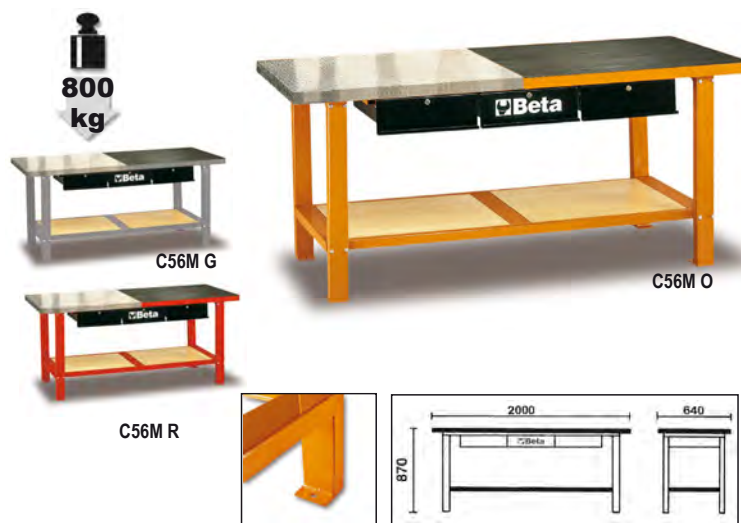

80 kg

		CHF		
C56M O	RAL 2011	1,840.00	1	056000050
C56M G	RAL 7016	1,840.00	1	056000053
C56M R	RAL 3000	1,840.00	1	056000054

C58B

Établi de travail avec plan en bois

Caractéristiques principales :

- Plan de travail en bois contre-plaqué stratifié avec trous pour l'installation d'un étau (1599F/125 en option).
- Structure en acier avec 4 pieds de support.
- Capacité de charge statique : 800 kg.
- Compartiment inférieur

44 kg



		CHF		
C58B-O	RAL 2011	806.00	1	058000401
C58B-G	RAL 7016	806.00	1	058000402
C58B-R	RAL 3000	806.00	1	058000403

C58M

Etabli

Caractéristiques principales • Plan de travail entièrement en métal et revêtu d'un tapis caoutchouc antidérapant amovible

- Etagère inférieure en bois massif
- Capacité de charge statique 800 kg.
- Combinable à la paroi porte-outils C58P (ne peut pas être fixé au plan de travail)
- 2 tiroirs avec serrures
- Prééquipé pour la fixation au sol.
- Plan de travail en Aluminium C58M/PA disponible sur demande

65 kg



		CHF		
C58M-O	RAL 2011	1,183.00	1	058000300
C58M-G	RAL 7016	1,183.00	1	058000302
C58M-R	RAL 3000	1,183.00	1	058000303

C59A

Établi "Endurance" avec 1 servante à six tiroirs

Caractéristiques principales :

- Tablette en bois contre-plaqué stratifié avec trous pour l'installation d'un étau 1599F/125 (en option).
- 6 tiroirs de 588x367 mm, montés sur glissières à billes de précision :
- 4 tiroirs hauteur 70 mm
- 1 tiroir hauteur 140 mm
- 1 tiroir hauteur 280 mm.
- Fonds des tiroirs protégés par un tapis en Néoprène.
- Façade des tiroirs en nylon haute résistance.
- Servantes prévues pour l'insertion de plateaux thermoformés.
- Serrure de sécurité centralisée frontale.
- Compartiment inférieur porte-objets.
- Prévu pour porte-papier (2400 RSC24/PC) et porte-flacons (2400 RSC24/PF-) (en option).

115 kg



C59A O



C59A A



C59A R

1500 kg



h	max
70 mm	25 kg
140 mm	30 kg
280 mm	35 kg

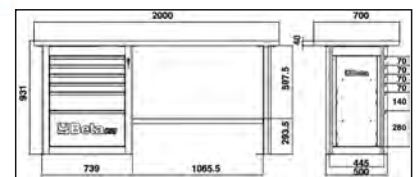

		CHF		
C59A-O	RAL 2011	2,430.00	1	059000011
C59A-A	RAL 7016	2,430.00	1	059000031
C59A-R	RAL 3000	2,430.00	1	059000051

C59B

Établi "Endurance" avec 2 servantes à six tiroirs

Caractéristiques principales :

- Tablette en bois contre-plaqué stratifié avec trous pour l'installation d'un étau 1599F/125 (en option).
- 12 tiroirs de 588x367 mm, montés sur glissières à billes de précision :
- 8 tiroirs hauteur 70 mm
- 2 tiroirs hauteur 140 mm
- 2 tiroirs hauteur 280 mm.
- Fonds des tiroirs protégés par un tapis en Néoprène.
- Prévu pour l'insertion de plateaux thermoformés.
- Serrure de sécurité centralisée frontale.
- Compartiment inférieur porte-objets.
- Prévu pour porte-papier (2400 RSC24/PC) et porte-flacons (2400 RSC24/PF-) (en option).

155 kg

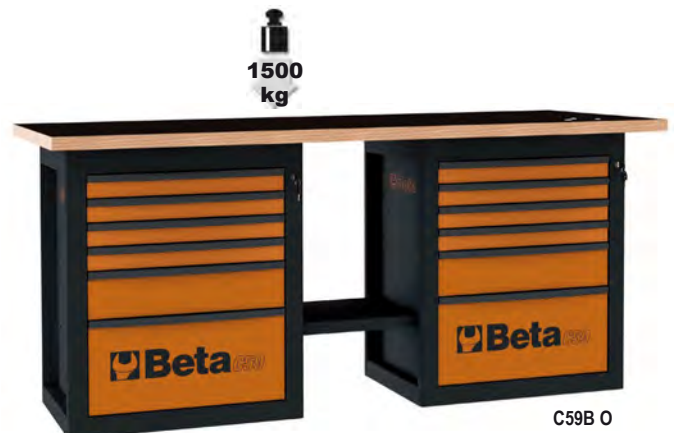

C59B O



C59B A



C59B R

1500 kg

h	max
70 mm	25 kg
140 mm	30 kg
280 mm	35 kg

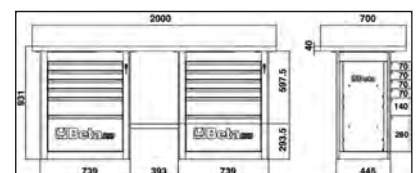

		CHF		
C59B-O	RAL 2011	3,220.00	1	059000012
C59B-R	RAL 3000	3,220.00	1	059000052
C59B-A	RAL 7016	3,220.00	1	059000032

C59C

Établi "Endurance" avec 1 servante à six tiroirs, modèle court

Caractéristiques principales :

- Tablette en bois contre-plaqué stratifié avec trous pour l'installation d'un étau 1599F/125 (en option).
- 6 tiroirs de 588x367 mm, montés sur glissières à billes de précision :
4 tiroirs hauteur 70 mm
1 tiroir hauteur 140 mm
1 tiroir hauteur 280 mm.
- Fonds des tiroirs protégés par un tapis en Néoprène.
- Prévus pour l'insertion de plateaux thermoformés.
- Serrure de sécurité centralisée frontale.
- Compartiment inférieur porte-objets.
- Prévus pour porte-papier (2400 RSC24/PC) et porte-flacons (2400 RSC24/PF-) (en option).

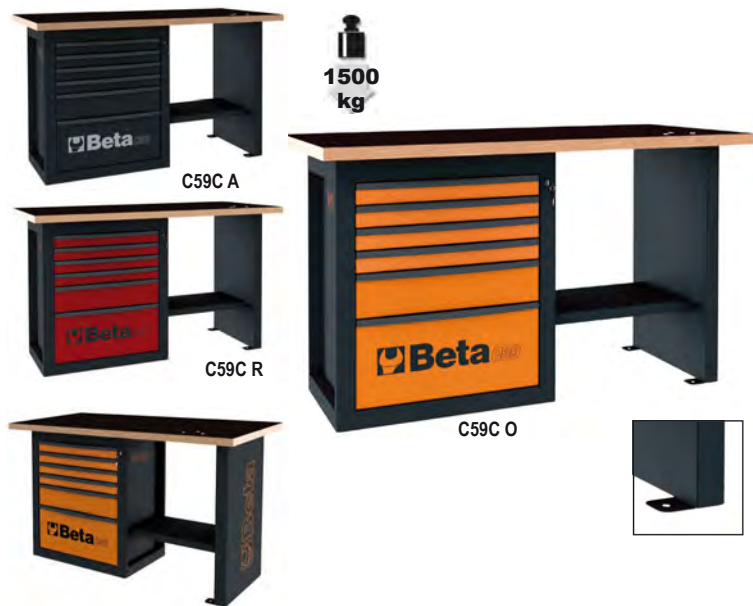

105 kg

		CHF		
C59C-O	RAL 2011	2,195.00	1	059000013
C59C-R	RAL 3000	2,195.00	1	059000053
C59C-A	RAL 7016	2,195.00	1	059000033

h	max
70 mm	25 kg
140 mm	30 kg
280 mm	35 kg

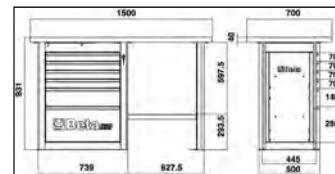

9562T2

Tapis pour établi de travail 200x160 cm

- Protège le sol contre les fuites d'huile et d'essence et respecte l'environnement
- Facile à nettoyer, en caoutchouc et antidérapant



	L cm	CHF		
9562T2	200	307.00	1	095620200

Beta



AMEUBLEMENT DE L'ATELIER



Beta Utensili, pour répondre aux exigences d'un marché de plus en plus tourné vers la qualité, le design et la personnalisation, a créé "Racing System C55" : un mobilier modulaire pour atelier qui offre la possibilité de créer un environnement de travail moderne, modelé sur vos nécessités.

Qualité

La meilleure qualité Beta "Made in Italy" pour agencer votre atelier



Design

Finitions recherchées et captivantes pour faire en sorte que l'atelier soit agréable et en ordre

Organisation

Un atelier organisé de manière rationnelle permet d'optimiser le travail

Modularité

Atelier composable en fonction de vos espaces et de vos exigences





MADE IN ITALY

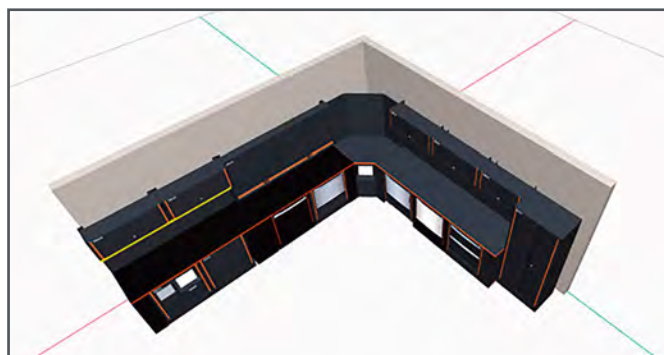

Configurez en ligne votre atelier
Visitez **www.rsc55.com**



L'atelier à vos couleurs!

RSC55 vous offre la possibilité de commander les établis et la paroi avec volet en version neutre (grise), et de compléter votre personnalisation avec les empiècements verticaux colorés à commander parmi les 7 différents rubans adhésifs.

- 1. Commandez vos modules avec couleur neutre**
- 2. Commandez l'empiècement vertical**

Choisissez la couleur en fonction de vos goûts ou des couleurs de votre entreprise.

C55

Combinaison complète d'ameublement de l'atelier RSC55



Combinaison complète composée de :

- Armoire à 1 porte (C55A1)
- Armoire à 2 portes (C55A2)
- Établi (C55BO/2)
- Établi avec prises (C55PRO BO/2)
- Servante mobile à 7 tiroirs (C55C7)
- Module fixe à 2 grands tiroirs (C55M2)
- Module fixe à 7 tiroirs (C55M7)
- Module fixe de service (C55MS)
- Paroi avec meubles hauts (C55/2PM)
- Parois porte-outils avec volet roulant (C55PS-O)

C55AB

Combinaison d'ameublement de l'atelier RSC55

Combinaison composée de :

- Armoire à 2 portes (C55A2)
- Établi (C55BO/2)
- Module fixe à 7 tiroirs (C55M7)
- Module fixe de service (C55MS)
- Paroi avec meubles hauts (C55/2PM)

407 kg



C55AB

CHF 11,990.00 1 055000020



C55PB/3

Combinaison d'ameublement de l'atelier RSC55

Combinaison composée de :

- Établi (C55BO/2)
- Module servante mobile d'atelier à 8 tiroirs (C55C8)
- Module fixe à 2 grands tiroirs (C55M2)
- Paroi porte-outils avec volet roulant (C55PS-O)

334 kg



C55PB/3

CHF 10,110.00 1 055000035



C55PB-PRO/7

Combinaison d'ameublement d'atelier RSC55

Composé de : C55B Établi avec plan de travail (2050x700 mm) recouvert d'une couche ABS antichoc et anti-rayures résistante aux huiles et aux hydrocarbures.

Équipé de:

- Trous pour un étau (1599F/150, à commander séparément)
- Pieds réglables verticalement C55M7 Module fixe avec sept tiroirs (588x367 mm) avec glissières à roulement à billes
- Système d'ouverture en aluminium sur toute la longueur du tiroir
- Bases de tiroirs protégées par des tapis en caoutchouc moussé
- Serrure centralisée avant
- Peut être équipé de plateaux thermoformés C55MS Module fixe de propreté
- Bac à déchets intégré
- Compartiment rouleau de papier
- Tiroir de rangement, 305x270 mm C55/14h + C55/PF Système de mur d'outils avec 2 armoires suspendues
- 2 armoires suspendues, 1024x400x300 mm, avec ressorts à gaz
- 2 panneaux sous armoire, 1024x620x25 mm
- 2 panneaux d'outils perforés sous l'armoire, 1024x620x25 mm



350 kg

C55PB-PRO/7 CHF 11,330.00 1 055000065



C55PB-PRO/8

Combinaison d'ameublement d'atelier RSC55

Composé de : C55B Établi avec plan de travail (2050x700 mm) recouvert d'une couche ABS antichoc et anti-rayures résistante aux huiles et aux hydrocarbures.

Équipé de:

- Trous pour un étau (1599F/150, à commander séparément)
- Pieds réglables verticalement C55C7 servante mobile avec sept tiroirs (588x367 mm) avec glissières à roulement à billes
- 4 roulettes Ø 100 mm, 2 fixes et 2 directions (dont une équipée d'un frein)
- Système d'ouverture en aluminium sur toute la longueur du tiroir
- Bases de tiroirs protégées par des tapis en caoutchouc moussé
- Serrure centralisée avant
- Peut être équipé de plateaux thermoformés C55MA Module fixe à deux portes
- Système d'ouverture push-pull
- Avec serrure
- Étagère intérieure, réglable verticalement C55PS Système de mur d'outils avec volet et cadre
- Volet en aluminium, réglable verticalement, avec serrure
- Panneau d'outils perforé amovible



347 kg

C55PB-PRO/8 CHF 9,760.00 1 055000066



C55B/2

Établi de 2 mètres pour ameublement atelier RSC55

Avec plan de travail 2050x700 mm revêtu d'une couche en PVC antichoc et anti-écaillage résistante aux huiles et hydrocarbures

- Trous pour l'installation d'un étau (1599F/150 - 1599GI/150 en option)
- Pieds réglables en hauteur

105 kg

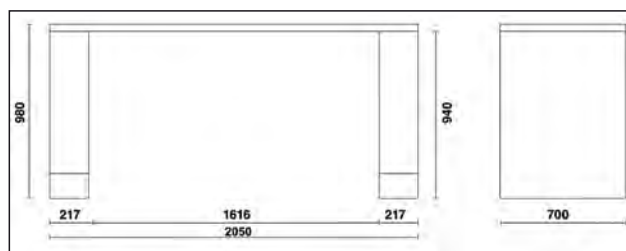
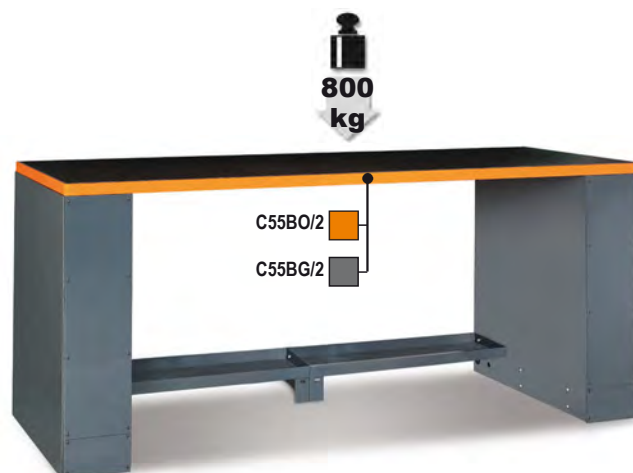

	CHF		
C55BO/2	2,780.00	1	055000101
C55BG/2	2,780.00	1	055000111

C55PRO B/2

Etabli en tôle de 2 mètres pour ameublement atelier RSC55

Avec plan de travail (2050x700 mm) revêtu d'une couche de PVC antichoc et anti rayures et résistante aux huiles et aux hydrocarbures

Prises électriques et enrouleur intégré

- Prise Schuko +16+10A
- Prise EU Plug 10A
- Prise pour air comprimé avec enrouleur intégré I, Ø 8 mm, Longueur: 10 m.
- Trous pour l'installation d'un étau 1599P/150 - 1599GI/150 (non inclus)
- Pieds réglables en hauteur

110 kg

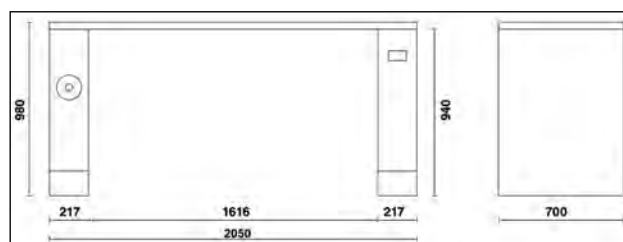
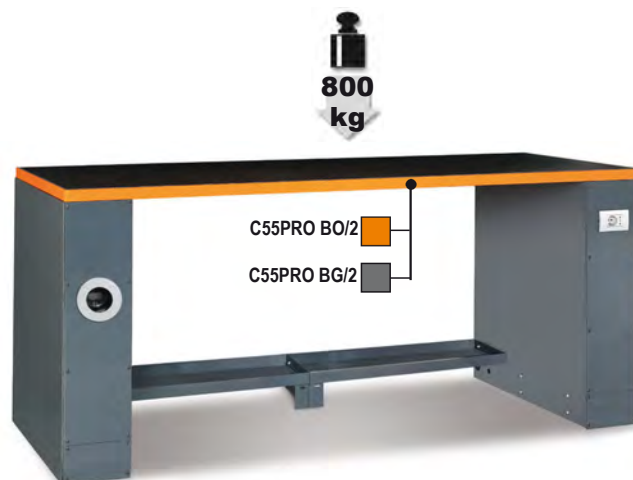

	CHF		
C55PRO BO/2	3,420.00	1	055000151
C55PRO BG/2	3,420.00	1	055000171

C55B/2,8

Établi de 2,8 mètres pour ameublement atelier RSC55

Avec plan de travail 2850x700 mm revêtu d'une couche en PVC antichoc et anti-écaillage résistante aux huiles et hydrocarbures

- Trous pour l'installation d'un étau 1599F/150 - 1599GI/150 (en option)
- Pieds réglables en hauteur

129 kg

600 kg

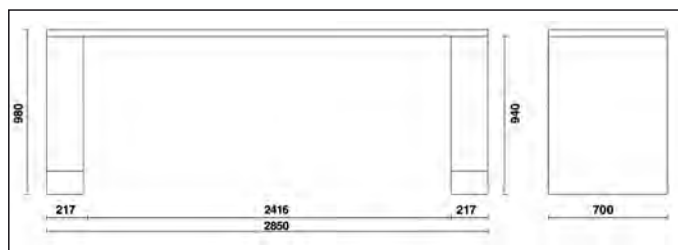
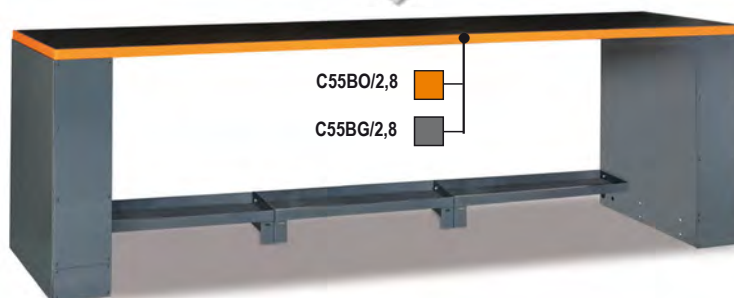

	CHF		
C55BO/2,8	3,500.00	1	055000261
C55BG/2,8	3,500.00	1	055000281

C55PRO B/2,8

Établi de 2,8 mètres pour ameublement atelier RSC55

Plan de travail en tôle vernie (2850x700 mm) revêtu d'une couche en PVC antichoc et anti rayure résistante aux huiles et aux hydrocarbures

Prises et enrouleur intégrés :

- Prise Schuko +16+10A
- Prise EU Plug 10A
- Prise pour air comprimé avec enrouleur intégré Ø 8 mm, Longueur : 10 m.
- Trous prévus pour l'installation d'un étau 1599F/150 - 1599GI/150 (non inclus)
- Pieds réglables en hauteur

134 kg

600 kg

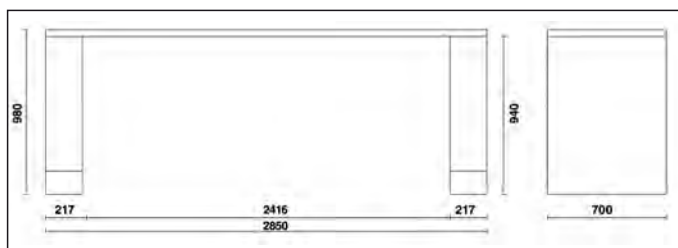
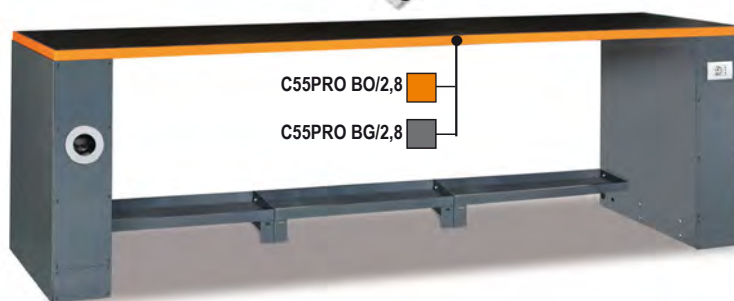

	CHF		
C55PRO BO/2,8	4,130.00	1	055000271
C55PRO BG/2,8	4,130.00	1	055000283

C55B-D4

Établi de travail double de 4 mètres avec pied central

Avec plan de travail 4100x700 mm revêtu d'une couche en PVC antichoc et anti-éraflure résistante aux hydrocarbures

- Trous pour l'installation d'un étau (1599F/150 - 1599GI/150 en option)
- Pieds réglables en hauteur
- Pied central double avec compartiment porte-objets et porte de fermeture escamotable

185 kg

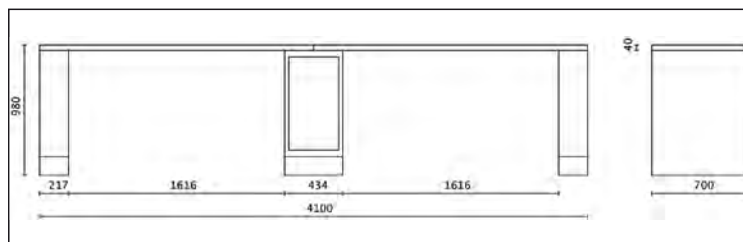

	CHF		
C55BO/D4	5,670.00	1	055000109
C55BG/D4	5,670.00	1	055000119

C55PRO B-D4

Etabli double de 4 mètres avec pied central et équipé d'une prise électrique et d'un enrouleur d'air pour ameublement atelier RSC55

Plan de travail en tôle vernie (4100x700 mm) revêtu d'une couche en PVC antichoc et anti rayure résistante aux huiles et aux hydrocarbures

Prises et enrouleur intégrés :

- Prise Schuko +16+10A
- Prise EU Plug 10A
- Prise pour air comprimé avec enrouleur intégré Ø 8 mm, Longueur : 10 m.
- Trous prévus pour l'installation d'un étau 1599F/150 - 1599GI/150 (non inclus)
- Pieds réglables en hauteur Double pied central avec compartiment et porte escamotable 365x750mm

190 kg

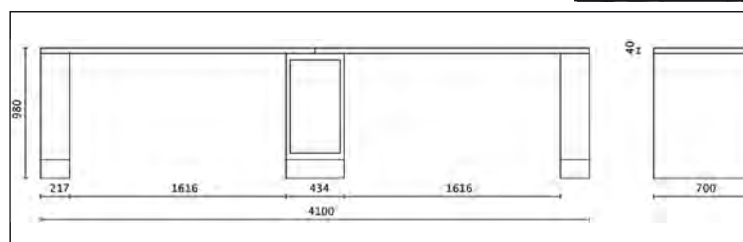
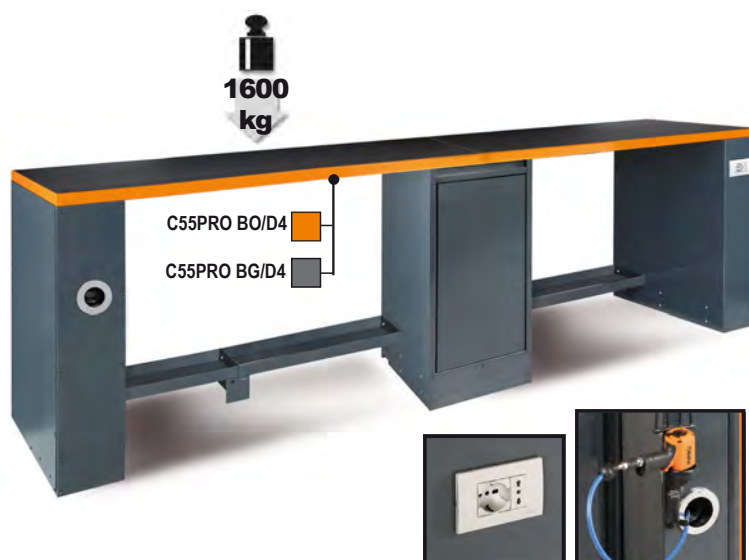

	CHF		
C55PRO-BO/D4	6,300.00	1	055000159
C55PRO-BG/D4	6,300.00	1	055000179

 **Beta**

C55B/G

Pied universel pour établi ameublement atelier

- Doté de pieds réglables en hauteur
- Utilisable sur les deux côtés de l'établi
- Accès avant et latéral

📦 30 kg

C55B/G **CHF** 749.00 1 055000096

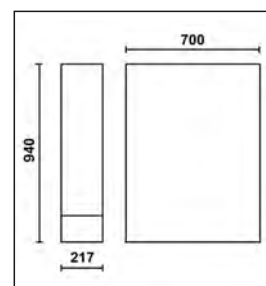

C55B/GAA

Pied universel pour ameublement atelier RSC55 avec enrouleur de tuyau intégré

- Enrouleur automatique de tuyau intégré pour air comprimé ou eau froide Ø 8 mm
- Longueur du tuyau : 10 m
- Pied réglable en hauteur
- Possibilité d'accès frontal ou latéral

📦 35 kg

C55B/GAA **CHF** 1,210.00 1 055000099

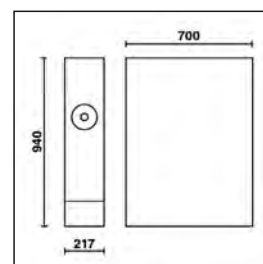

C55B/GDP

Double pied pour établis adjacents ameublement atelier

- Compartiment pour support rouleaux de papier
- Compartiment porte-objets avec porte
- Doté de pieds réglables en hauteur

📦 45 kg

C55B/GDP **CHF** 1,780.00 1 055000292

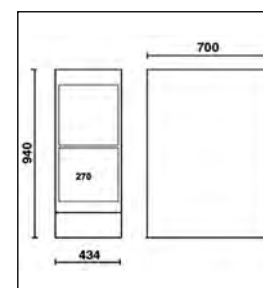

C55B/GDS

Pied double pour établis adjacents pour mobilier d'atelier RSC55

- Compartiment porte-objets avec porte de fermeture escamotable 365x750 mm
- Doté de pieds réglables en hauteur

📦 45 kg

C55B/GDS **CHF** 1,595.00 1 055000291

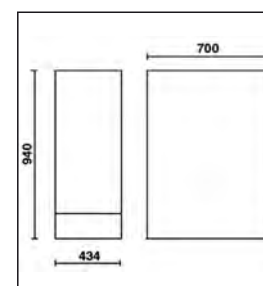

C55B/GE

Pied universel avec prises électriques pour établi ameublement atelier

- Prise Schuko+16+10A
- Prise EU Plug +10A
- Doté de pieds réglables en hauteur
- Accès avant et latéral

📦 30 kg

C55B/GE CHF 920.00 1 055000097

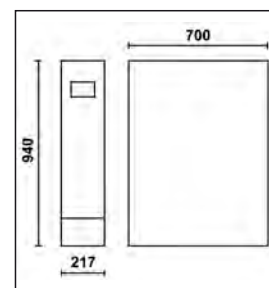

C55B/GAE

Pied universel pour ameublement atelier RSC55 avec enrouleur électrique intégré

- Enrouleur automatique de câble électrique avec prise Schuko.
- Longueur de câble 15 m
- Avec protection thermique
- Pied réglable en hauteur
- Possibilité d'accès frontal ou latéral

📦 35 kg

C55B/GAE CHF 1,290.00 1 055000094

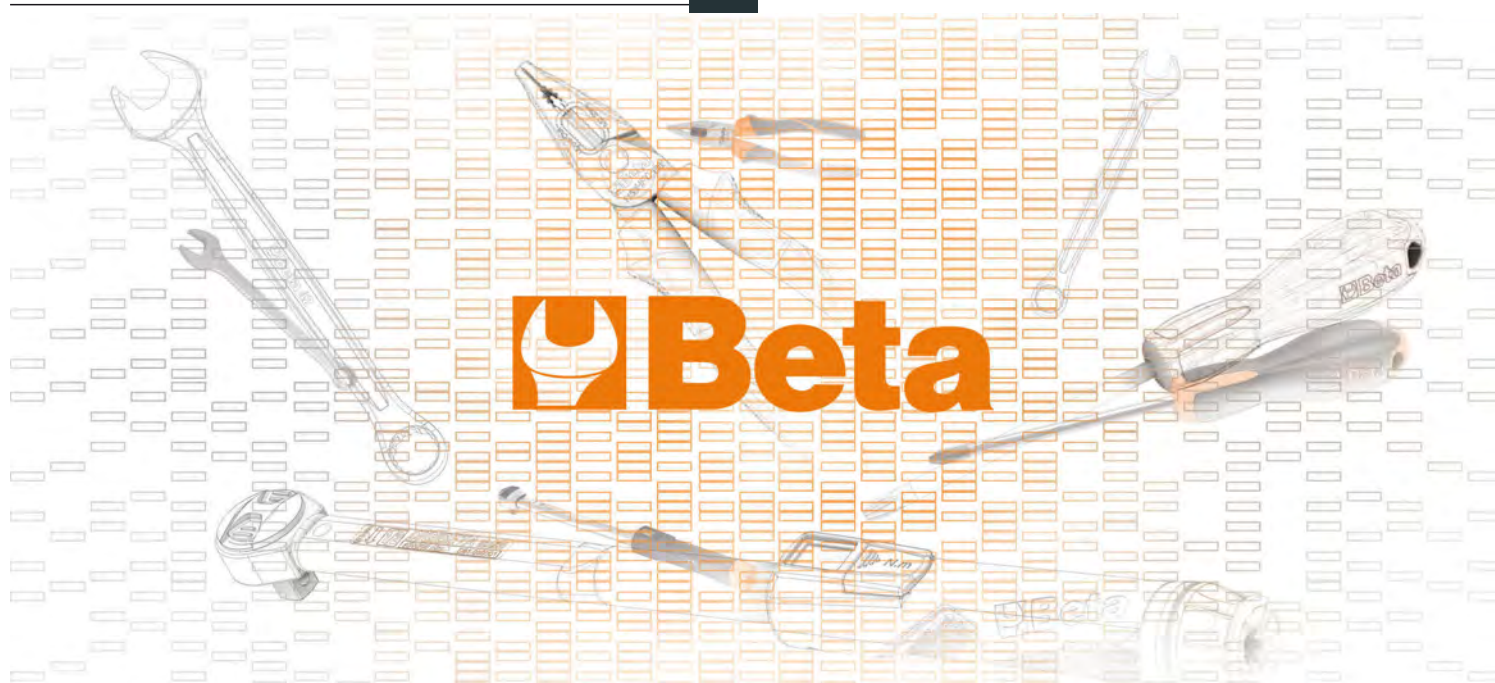
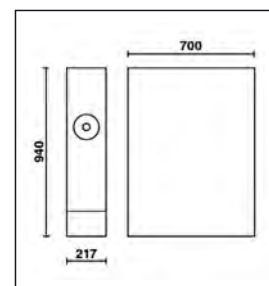
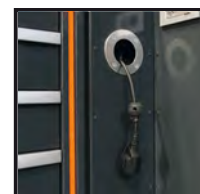

C55/PL-1,024

Plan de travail d'1 mètre pour extension sur ameublement atelier RSC55

Plan de travail en tôle vernie (1024x700 mm) revêtu d'une couche en PVC antichoc et anti rayure et résistante aux huiles et aux hydrocarbures

📦 21 kg

	CHF		
C55/PLO-1,024	619.00	1	055000130
C55/PLG-1,024	619.00	1	055000131



C55B PT/2

Plan de travail de 2 mètres pour établi ameublement atelier RSC55

Plan de travail en tôle vernie (2050x700 mm) revêtu d'une couche en PVC antichoc et anti rayure et résistante aux huiles et aux hydrocarbures
Trous prévus pour l'installation d'un étau 1599P/150 - 1599GI/150 (non inclus)

📦 43 kg

	CHF		
C55BO PT/2	1,285.00	1	055000106
C55BG PT/2	1,285.00	1	055000116

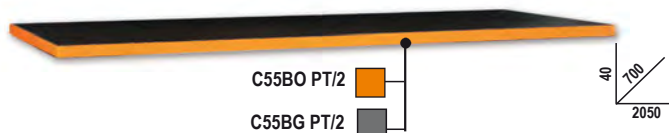

C55B PT/2,8

Plan de travail de 2,80 mètres pour établi ameublement atelier RSC55

Plan de travail en tôle vernie (2850x700 mm) revêtu d'une couche en PVC antichoc et anti rayure et résistante aux huiles et aux hydrocarbures
Trous prévus pour l'installation d'un étau 1599P/150 - 1599GI/150 (non inclus)

📦 61 kg

	CHF		
C55BO PT/2,8	1,995.00	1	055000266
C55BG PT/2,8	1,995.00	1	055000286



C55RB

Revêtement en PVC antichoc, anti-rayure, résistant aux hydrocarbures

Pour protéger le plan de travail.

C55RB/2: pour établi de 2 mètres

C55RB/2,8: pour établi de 2,8 mètres

C55RB/0,7: pour établi de 700x700mm

C55RB/1: pour établi de 1 mètre

	CHF		
C55RB/2	217.50	1	055000195
C55RB/2,8	295.00	1	055000196
C55RB/0,7	121.00	1	055000199
C55RB/1	165.00	1	055000198



C55B/VS

Étrier inférieur de soutien d'établis

Dimensions 800x230x60 mm

📦 4 kg

	CHF		
C55B/VS	165.00	1	055000095

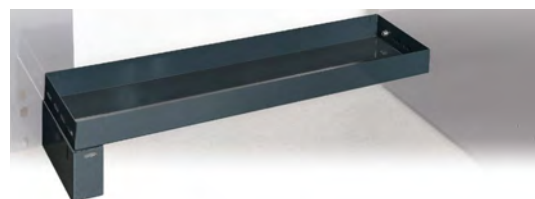

C55C7

Servante mobile d'atelier à 7 tiroirs pour ameublement atelier

7 tiroirs de 588x367 mm, montés sur glissières à billes de précision

- 4 roues de Ø 100 mm, 2 fixes (dont une avec frein) et 2 pivotantes
- Système d'ouverture en aluminium sur toute la longueur du tiroir
- Fond des tiroirs protégé par un tapis en Néoprène
- Serrure centralisée frontale
- Tiroirs conçus pour l'emplacement des thermoformés

79 kg

1000 kg

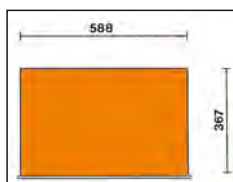

h	max
70 mm	30 kg
245 mm	40 kg

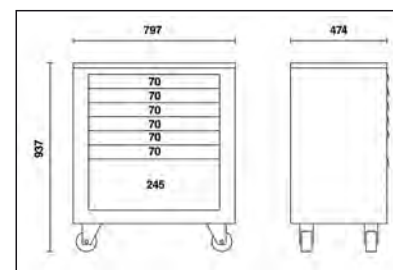

C55C7

CHF 2,580.00 1 055000201

 **Beta**

C55C8

Module servante mobile d'atelier à 8 tiroirs pour ameublement atelier

- 8 tiroirs de 588x367 mm, montés sur glissières à billes de précision
- 4 roues de Ø 100 mm, 2 fixes (dont une avec frein) et 2 pivotantes
- Système d'ouverture en aluminium sur toute la longueur du tiroir
- Fond des tiroirs protégé par un tapis en Néoprène
- Serrure centralisée frontale
- Tiroirs conçus pour l'emplacement des thermoformés

81 kg



h	max
70 mm	30 kg
175 mm	40 kg

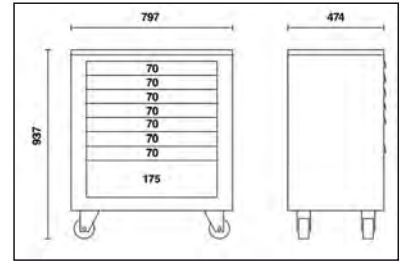
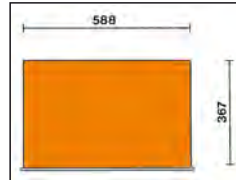

C55C8 CHF 2,620.00 1 055000206

C55M2

Module fixe à 2 tiroirs pour ameublement atelier

- 2 tiroirs de 588x367mm, montés sur glissières à billes de précision
- Système d'ouverture en aluminium sur toute la longueur du tiroir
- Fond des tiroirs protégé par un tapis en Néoprène
- Serrure centralisée frontale

66 kg



h	max
280 mm	40 kg
385 mm	40 kg

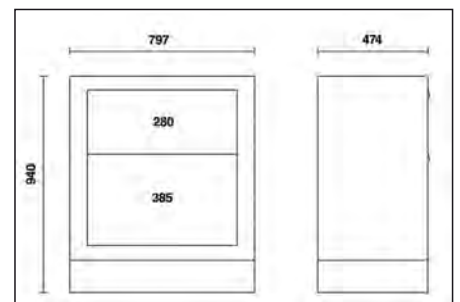
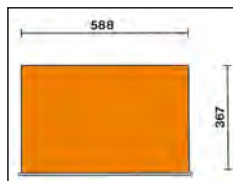

C55M2 CHF 2,190.00 1 055000202

C55M4

Module fixe à 4 tiroirs pour ameublement atelier

4 tiroirs de 588x367 mm, montés sur glissières à billes de précision

- Système d'ouverture en aluminium sur toute la longueur du tiroir
- Fond des tiroirs protégé par un tapis en Néoprene
- Serrure centralisée frontale

75 kg

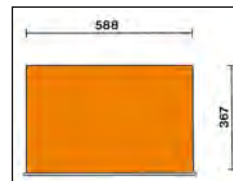

h	max
140 mm	30 kg
245 mm	40 kg

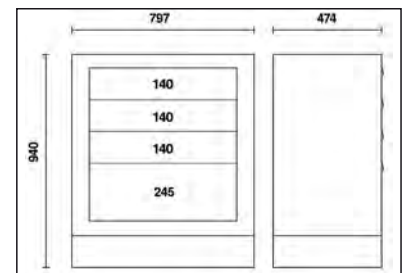

C55M4

CHF 2,300.00 1 055000212

C55M7

Module fixe à 7 tiroirs pour ameublement atelier

7 tiroirs de 588x367 mm, montés sur glissières à billes de précision

- Système d'ouverture en aluminium sur toute la longueur du tiroir
- Fond des tiroirs protégé par un tapis en Néoprene
- Serrure centralisée frontale
- Tiroirs conçus pour l'emplacement des thermoformés

78 kg

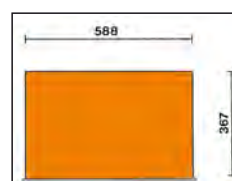

h	max
70 mm	30 kg
245 mm	40 kg

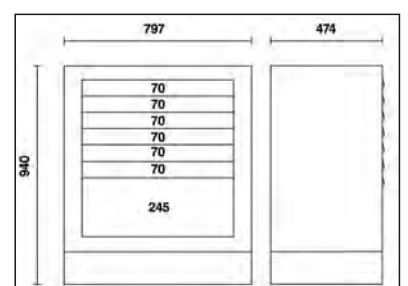

C55M7

CHF 2,435.00 1 055000203

C55M8

Module fixe à 8 tiroirs pour ameublement atelier

8 tiroirs de 588x367 mm, montés sur glissières à billes de précision

- Système d'ouverture en aluminium sur toute la longueur du tiroir
- Fond des tiroirs protégé par un tapis en Néoprène
- Serrure centralisée frontale
- Tiroirs conçus pour l'emplacement des thermoformés

📦 78,9 kg



h	max
70 mm	30 kg
175 mm	40 kg

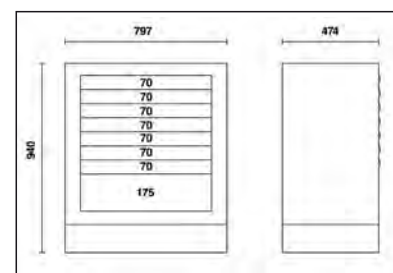
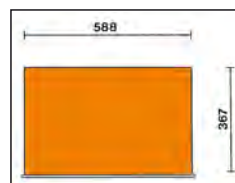

C55M8

CHF 2,485.00 1 055000207

C55CS

Module fixe pour tri des déchets pour ameublement atelier

- Compartiment déchets extractible 588x465 mm monté sur glissières à billes de précision
- 2 grands conteneurs internes extractibles pour le tri des déchets

📦 62 kg

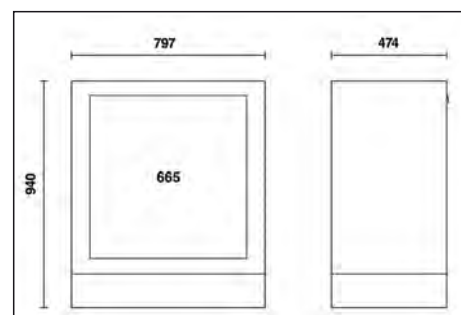

C55 CS

CHF 2,220.00 1 055000208

C55MA

Module fixe à 2 portes pour ameublement atelier

- Système d'ouverture push-pull à pression
- Avec serrure
- Rayon interne réglable en hauteur

📦 75 kg

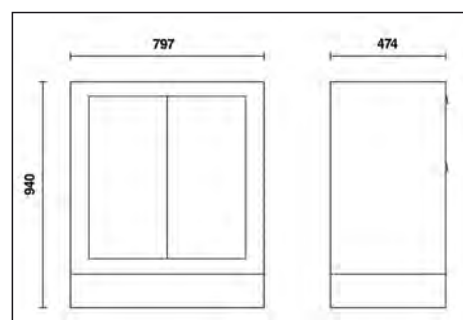

C55MA

CHF 1,890.00 1 055000205

C55MDO

Module fixe de distribution d'huile pour ameublement atelier

- 2 enrouleurs avec tuyau flexible de 7 m - 1/2" compris
- Fourni avec 2 pistolets équipés de compte-litres numérique et équipés de ramasse-gouttes automatique
- débit max. : 30 l/mn
- viscosité : 8÷2000 mPas

📦 94 kg

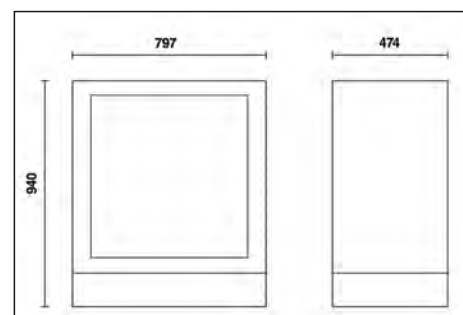

C55MDO

CHF 3,970.00 1 055000210

C55MS

Module fixe de service pour ameublement atelier

- Poubelle incorporée
- Compartiment pour rouleaux de papier préforés
- Soute porte-objets 305x270 mm

📦 75 kg

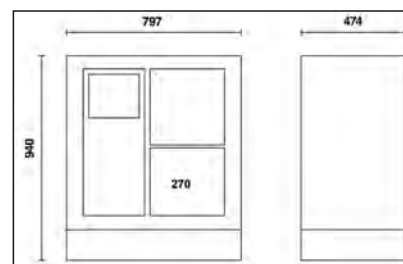

C55MS

CHF 1,995.00 1 055000204

C55T3

Chariot d'atelier

- 3 plateaux revêtus de caoutchouc antidérapant
- Poignée ergonomique
- Double possibilité de fixation du plateau central
- 4 roues Ø 100 mm pivotantes (dont deux avec frein)
- Capacité de charge statique : 200 kg (répartie sur les 3 étagères)

📦 21 kg

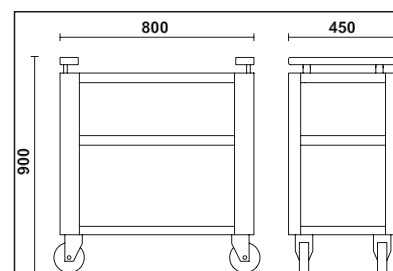

C55T3

CHF 453.00 1 055000219

C55P/MCD

Montants centraux intermédiaires doubles

10 kg

C55P/MCD

CHF 190.50 1 055000257



C55P/2MDX-SX

Couple de montants droite-gauche parois

10 kg

C55P/2MDX-SX

CHF 347.00 1 055000253



C55PM

Meuble haut de 1 mètre pour établi ameublement atelier

• Dimensions 1024x400x300 mm, avec ressorts à gaz pour faciliter l'ouverture/fermeture de la porte

24 kg

C55PM

CHF 1,270.00 1 055000302

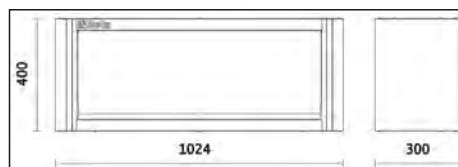

C55PFA-1,0

Panneau foré autoportant de 1 mètre pour ameublement atelier

Panneau foré en acier 1024x1020x25 mm pour le support des outils

11 kg

C55PFA-1,0

CHF 427.00 1 055000316

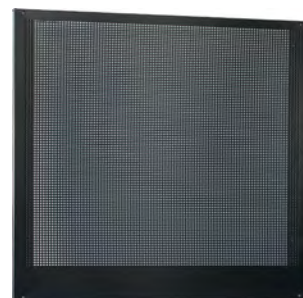

C55/PF

Panneau foré sous meuble haut de 1 mètre pour ameublement atelier

• Panneau foré 1024x600 mm pour accrocher les outils, à superposer à C55PT1,0x0,6

6 kg

C55/PF

CHF 293.00 1 055000307



C55PT1,0X0,6

Panneau sous meuble haut de 1 mètre

Dimensions 1024x620x25 mm

8 kg

C55PT1,0X0,6 CHF 233.50 1 055000314



C55PTE-1,0

Panneau sous meuble haut de 1 mètre

Dimensions 1024x620x25 mm

Avec prédétermination pour 2 prises électriques (non comprises)

8 kg

C55PTE-1,0 CHF 278.00 1 055000319



C55/2PM

Paroi avec meubles hauts pour ameublement atelier

- 2 meubles hauts, 1024x400x300 mm, avec ressorts à gaz pour faciliter l'ouverture/fermeture de la porte.
- Panneau mural 2050x620 mm prévu pour le logement des panneaux porte-outils perforés C55/PF (en option)
- Fournie avec structure portante
- Possibilité d'assortiment à l'établi de 2 mètres.

80 kg

C55/2PM CHF 3,550.00 1 055000301

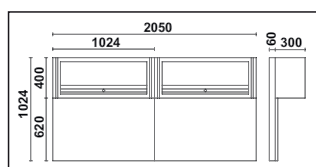
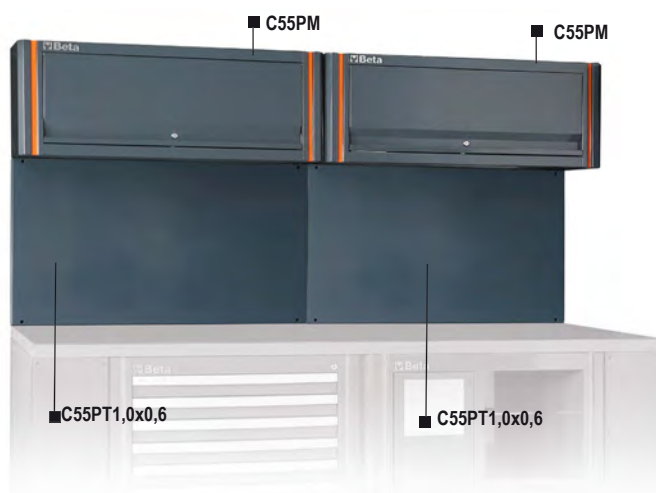

 **Beta**

C55PFA-0,8

Panneau foré autoportant de 0,8 mètres pour ameublement atelier

Panneau foré en acier 800x1020x25 mm pour le support des outils

10 kg

C55PFA-0,8 CHF 392.00 1 055000315



C55PM/M0,8

Meuble haut de 0,8 mètres pour ameublement atelier

Dimensions 800x400x300 mm, avec ressorts à gaz pour faciliter l'ouverture/fermeture de la porte

19 kg

C55PM/M0,8 CHF 1,215.00 1 055000312

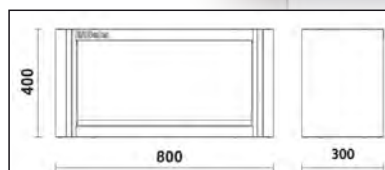

C55PTE-0,8

Panneau sous meuble haut de 0,8 mètres

Dimensions 800x620x25 mm
Avec prédisposition pour 1 prise électrique (non comprise)

6 kg

C55PTE-0,8 CHF 251.00 1 055000318



C55PT0,8X0,6

Panneau sous meuble haut de 0,8 mètres

Dimensions 800x620x25 mm

7,8 kg

C55PT0,8X0,6 CHF 217.50 1 055000313



C55/1PF

Panneau perforé porte-outils pour ameublement atelier

• Panneau perforé 800x600 mm pour le support des outils

5 kg

C55/1PF CHF 195.50 1 055000309

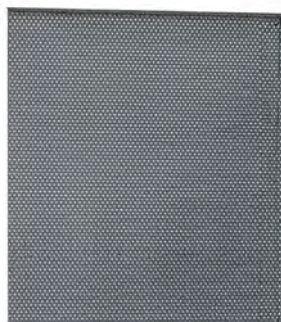

C55PS

Paroi porte-outils avec volet roulant pour ameublement atelier

- Volet roulant en aluminium à mouvement vertical avec serrure
- Panneau perforé amovible pour le support des outils
- Fournie avec structure portante
- Possibilité d'assortiment à l'établi de 2 mètres

📦 88 kg

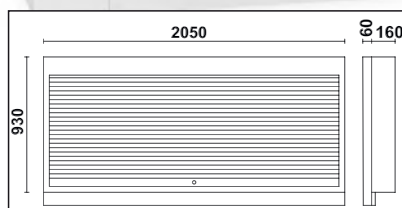

C55PS-O	CHF	2,510.00	1	055000250
C55PS-G	CHF	2,510.00	1	055000255

C55PSE

Paroi porte-outils avec volet roulant et prédisposition pour 2 prises électriques

- Volet roulant en aluminium à mouvement vertical avec serrure
- Panneau perforé amovible pour le support des outils
- Fournie avec structure portante
- Avec prédisposition pour prises électriques (non comprises)
- Possibilité d'assortiment à l'établi de 2 mètres

📦 88 kg

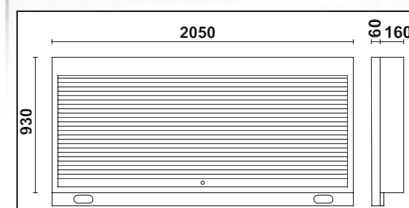

C55PSE-O	CHF	2,540.00	1	055000258
C55PSE-G	CHF	2,540.00	1	055000260

C55AE

Profil 2 mètres avec prédisposition électrique

Dimensions 2050x25x90mm
Avec prédisposition pour 2 prises électriques

📦 1,5 kg

C55AE	CHF	233.50	1	055000325
-------	-----	--------	---	-----------

C55AC

Angle complet autoportant

Plan de travail de 700x700 mm avec pieds

2 parois supérieures porte-outils équipées de 2 rayons pour fixation 670x160 mm

66 kg

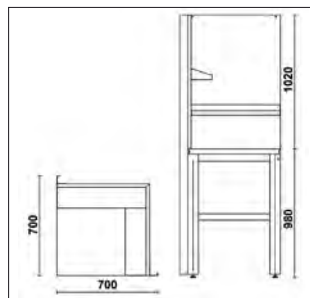

	CHF		
C55AC-O	2,900.00	1	055000360
C55AC-G	2,900.00	1	055000380

C55KAI

Élément angulaire 700x700 mm avec pieds

• Plan de travail en tôle vernie 700x700 mm revêtu d'une couche en PVC antichoc, anti-rayure, résistante aux hydrocarbures

32 kg

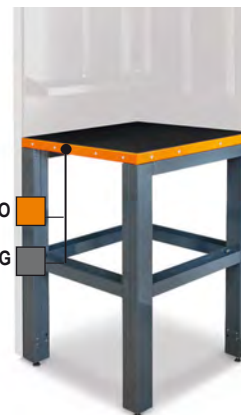

	CHF		
C55KAI-O	1,665.00	1	055000365
C55KAI-G	1,665.00	1	055000385

C55KAS

Angle supérieur avec parois porte-outils

• 2 parois forées 700x1020x25 mm
• 2 rayons pour fixation 670x160 mm

24 kg



	CHF		
C55KAS	1,230.00	1	055000370

C55MP

Etagère métallique pour angle haut

Dimensions 670x160x80 mm



	CHF		
C55MP	173.50	1	055000374



C55B/1

Rallonge d'1 mètre

Plan de travail en tôle vernie 1024x700 mm revêtu d'une couche en PVC antichoc, anti-rayure, résistante aux hydrocarbures

• Pied universel doté de pieds réglables en hauteur
1 module fixe:

7 tiroirs de 588x367 mm, montés sur glissières à billes de précision

• Système d'ouverture en aluminium sur toute la longueur du tiroir

• Fond des tiroirs protégé par un tapis en Néoprene

• Serrure centralisée frontale

127 kg



h	max
70 mm	30 kg
245 mm	40 kg

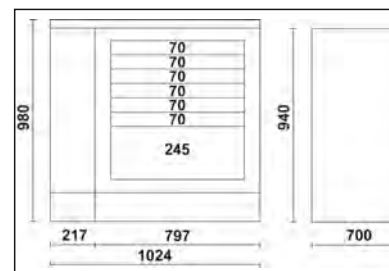
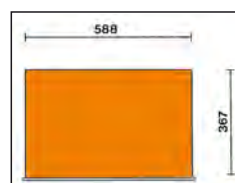

	CHF		
C55BO/1	3,810.00	1	055000090
C55BG/1	3,810.00	1	055000091

Beta

C55A1

Armoire métallique une porte, pour combinaison d'ameublement d'atelier RSC55

- 3 étagères amovibles et réglables en hauteur
- Tringle à vêtements intégrée sous la première étagère
- Avec serrure de sécurité
- Dimensions intérieures utiles : 1770x420x420 mm

📦 50 kg

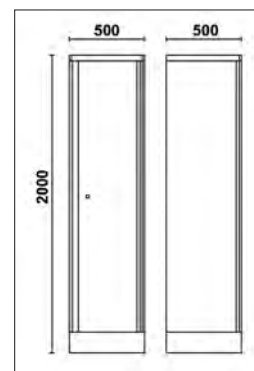

C55A1

CHF 920.00 1 055000411

C55A1/R42

étagère intérieure pour armoire C55A1 et C55AT1

📦 2,4 kg



C55A1/R42

497x403 mm

CHF 40.50 1 055000461

C55 A1/RB42

Etagère intérieure munie d'une tringle à vêtements pour armoire à outils C55A1/C55AT1

📦 2,5 kg



C55 A1/RB42

497x403 mm

CHF 53.50 1 055000463

 **Beta**

C55A2

Armoire en tôle à 2 portes pour ameublement atelier RSC55

- 3 tablettes amovibles réglables en hauteur
- Avec serrure
- Dimensions intérieures utiles : 1798x797x403 mm

📦 72 kg

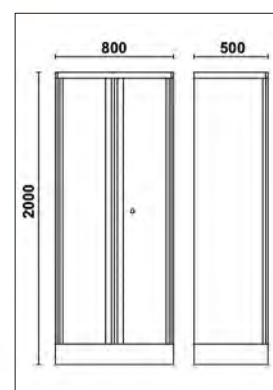

C55A2

CHF 1,235.00 1 055000412

C55A2/R70

étagère intérieure pour armoire C55A2 et C55A2T

📦 3,5 kg



C55A2/R70

700x420 mm

CHF 64.50 1 055000462



C55AT1

Armoire en tôle à 1 porte transparente en polycarbonate pour ameublement atelier RSC55

- 3 tablettes amovibles réglables en hauteur
- Avec serrure
- Dimensions intérieures utiles : 1798x497x403 mm

41 kg

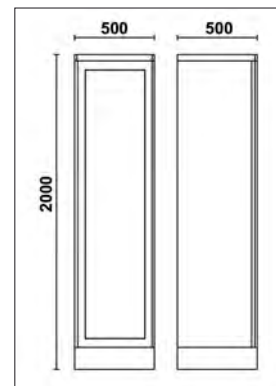

C55AT1 CHF 1,099.00 1 055000421

C55AT2

Armoire en tôle à 2 portes transparentes en polycarbonate pour ameublement atelier RSC55

- 3 tablettes amovibles réglables en hauteur
- Avec serrure
- Dimensions intérieurs utiles : 1798x797x403 mm

56 kg

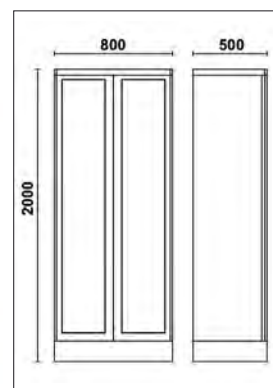

C55AT2 CHF 1,490.00 1 055000422

C55STR

Ruban adhésif coloré 25 m

Permet de personnaliser la couleur des embouts verticaux de l'ameublement d'atelier C55



RAL2011
RAL3000
RAL6029
RAL9016
RAL1023
RAL5015
RAL1035
RAL9006

		CHF		
C55STR-O/2011	Orange	93.50	1	055000901
C55STR-R/3000	Red	93.50	1	055000903
C55STR-V/6029	Green	93.50	1	055000906
C55STR-W/9016	White	93.50	1	055000907
C55STR-Y/1023	Yellow	93.50	1	055000905
C55STR-B/5015	Blue	93.50	1	055000904
C55STR-GO/1035	Grey	93.50	1	055000909
C55STR-S/9006	Black	93.50	1	055000902





AMEUBLEMENT DE L'ATELIER



Beta poursuit ses investissements dans sa production "Made in Italy" et nous sommes ravis de vous présenter

LA NOUVELLE LIGNE D'AMEUBLEMENT

Au fil des années, l'expérience acquise grâce à nos deux gammes actuelles d'ameublement RSC55 et C45PRO nous a permis d'être attentif aux exigences des utilisateurs professionnels. Sa conception s'inspire des notions fondamentales suivantes:

Qualité

Le choix minutieux des matériaux, le souci du détail ainsi que son design moderne font de la gamme RSC50 un produit incomparable dans l'ameublement d'atelier.



Facilité d'assemblage

Montage simple et rapide grâce à l'optimisation de la fabrication des différents composants de la gamme.

Modularité

Chaque combinaison d'ameublement peut être modifiée ou complétée suivant l'évolution des besoins et les exigences de l'utilisateur.

Compatibilité

Les tiroirs, aux dimensions standards Beta (588x367 mm), permettent d'intégrer parfaitement les modules mousses ou thermoformés d'outillage Beta.



Fonctionnalité et Robustesse

Son plan de travail, d'une profondeur de 63 cm, permet de travailler sur une grande surface, confortable et fonctionnelle.

Prédisposé pour le montage d'un étau, celui-ci permet un travail des plus exigeant.



MADE IN ITALY

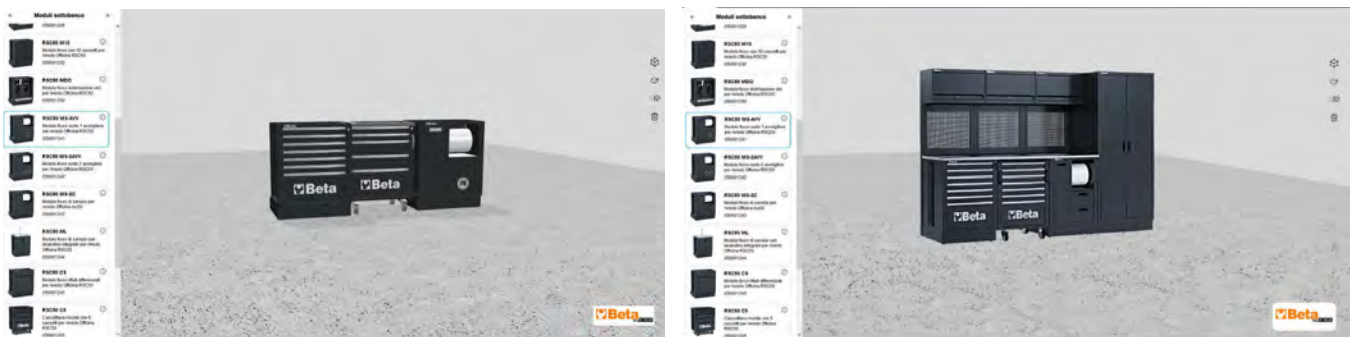

Configurez votre atelier en 3D en ligne
sur **www.beta-tools.com**

Le nouvel ameublement RSC50 propose des combinaisons prédéterminées et spécialement conçues par Beta pour l'utilisateur professionnel, mais permet également de concevoir le poste de travail idéal en choisissant parmi les nombreux modules, éléments et accessoires disponibles.

La personnalisation dans les couleurs des poignées des tiroirs et l'éclairage sous les établis et les meubles hauts, font du nouvel ameublement d'atelier RSC50 le choix parfait pour travailler efficacement en toute sécurité.



RSC50 I

Combinaison d'ameublement d'atelier RSC50

Combinaison comprenant :

- 1 plan de travail de 2240 mm (RSC50 PG/3-2,2MT)
- 1 plan de travail de 1495 mm (RSC50 PG/2-1,5MT)
- 1 module fixe à 7 tiroirs (RSC50 M7)
- 1 servante mobile à 7 tiroirs (RSC50 C7)
- 1 module fixe de propreté avec 2 tiroirs (RSC50 MS-2C)
- 1 angle complet autoportant (RSC50 AC-G)
- 1 module fixe à 5 tiroirs (RSC50 M5)
- 1 module fixe à 2 portes (RSC50 MA)
- 5 meubles hauts muraux (RSC50 PM)
- 5 panneaux porte-outils perforés supérieurs (RSC50 PFS)
- 5 panneaux porte-outils perforés inférieurs (RSC50 PFI)
- 5 paires d'étriers (RSC50 P/2MDX-SX)
- 2 armoires à 1 porte (RSC50 A1)

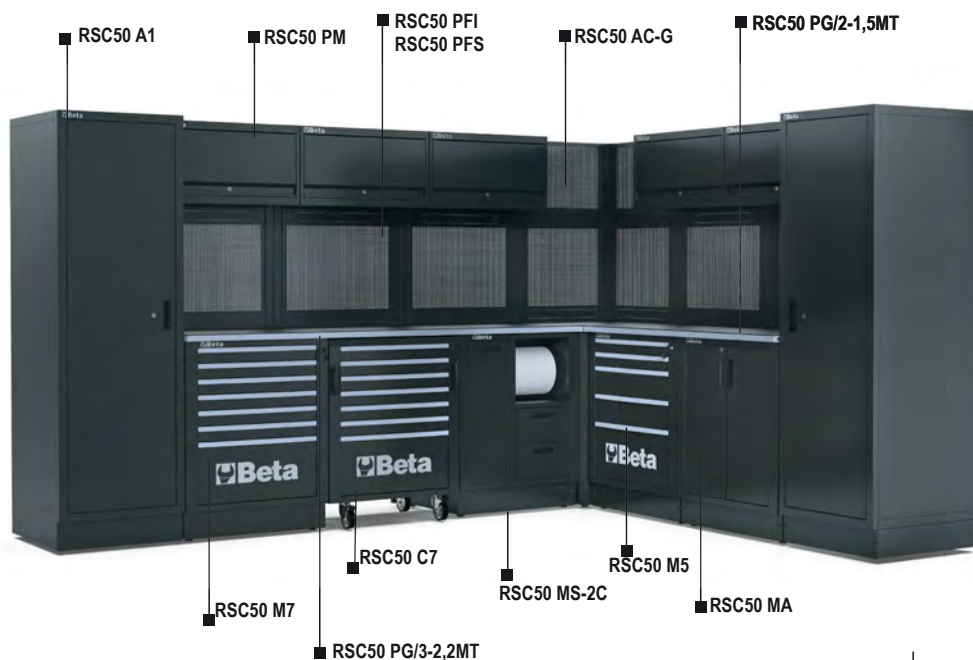

2000
690
3530 / 2785

625 kg

RSC50 I CHF 23,320.00 1 050001045

RSC50 L

Combinaison d'ameublement d'atelier RSC50

Combinaison comprenant :

- 1 plan de travail de 2240 mm (RSC50 PG/3-2,2MT)
- 1 plan de travail de 750 mm (RSC50 PG/1-0,7MT)
- 1 module fixe de propreté (RSC50 MS-2AVV) avec 2 enrouleurs intégrés (1 enrouleur de tuyaux d'air comprimé art. 1900S 8x10mm et 1 enrouleur de câbles électriques art. 1844 15-H05/SCK)
- 1 servante mobile à 7 tiroirs (RSC50 C7)
- 1 module fixe à 7 tiroirs (RSC50 M7)
- 1 angle complet autoportant (RSC50 AC-G)
- 1 module fixe à 2 portes (RSC50 MA)
- 1 Paroi porte-outils avec volet roulant et structure en aluminium (RSC50 PS)
- 2 meubles hauts muraux (RSC50 PM)
- 2 panneaux porte-outils perforés supérieurs (RSC50 PFS)
- 2 panneaux porte-outils perforés inférieurs (RSC50 PFI)
- 2 paires d'étriers (RSC50 P/2MDX-SX)
- 2 armoires à 1 porte (RSC50 A1)



2000
690
3530 / 2040

541 kg

RSC50 L CHF 20,390.00 1 050001050

RSC50

Combinaison complète d'ameublement d'atelier RSC50

Combinaison complète comprenant :

- 1 armoire à 1 porte (RSC50 A1)
- 1 plan de travail de 750 mm (RSC50 PG/1-0,7MT)
- 1 plan de travail de 2240 mm (RSC50 PG/3-2,2MT)
- 1 servante mobile à 7 tiroirs (RSC50 C7)
- 1 module fixe à 4 tiroirs (RSC50 M4)
- 1 module fixe à 7 tiroirs (RSC50 M7)
- 1 module fixe de propreté (RSC50 MS-AVV) avec enrouleur de tuyaux d'air comprimé art. 1900S 8x10mm
- 1 Paroi porte-outils avec volet roulant et structure en aluminium (RSC50 PS)
- 2 meubles hauts muraux (RSC50 PM)
- 2 panneaux porte-outils perforés supérieurs (RSC50 PFS)
- 2 panneaux porte-outils perforés inférieurs (RSC50 PFI)
- 2 paires d'étriers (RSC50 P/2MDX-SX)
- 1 armoire à 2 portes (RSC50 A2)

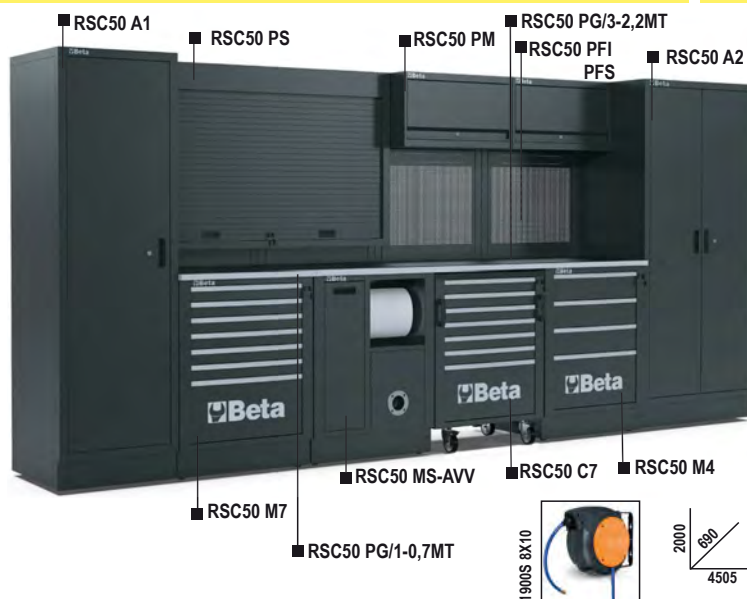

534 kg

RSC50 CHF 18,510.00 1 050001000

RSC50 H

Combinaison d'ameublement d'atelier RSC50

Combinaison comprenant :

- 1 plan de travail de 2240 mm (RSC50 PG/3-2,2MT)
- 1 module fixe de propreté avec 2 tiroirs (RSC50 MS-2C)
- 1 servante mobile à 7 tiroirs (RSC50 C7)
- 1 module fixe à 7 tiroirs (RSC50 M7)
- 1 module fixe avec évier intégré (RSC50 ML)
- 4 meubles hauts muraux (RSC50 PM)
- 4 panneaux porte-outils perforés supérieurs (RSC50 PFS)
- 4 panneaux porte-outils perforés inférieurs (RSC50 PFI)
- 4 paires d'étriers (RSC50 P/2MDX-SX)
- 1 armoire à 1 porte (RSC50 A1)

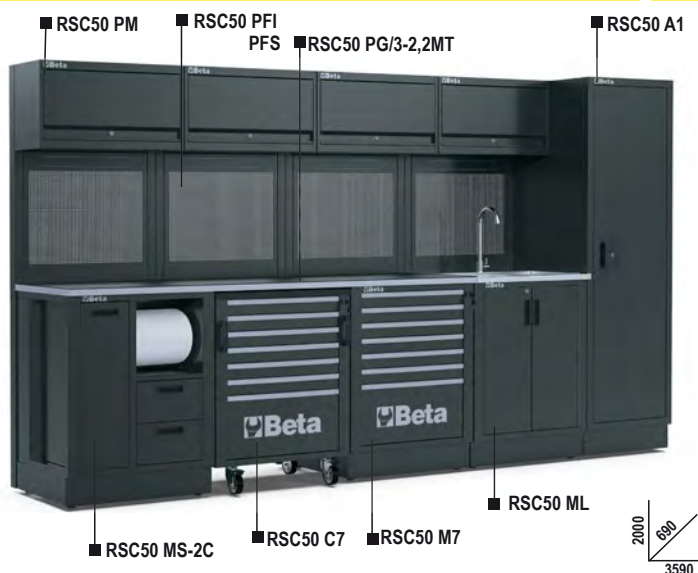

417 kg

RSC50 H CHF 16,160.00 1 050001040

RSC50 G

Combinaison d'ameublement d'atelier RSC50

Combinaison comprenant :

- 1 plan de travail de 2240 mm (RSC50 PG/3-2,2MT)
- 1 module fixe de propreté (RSC50 MS-2AVV) avec 2 enrouleurs intégrés (1 enrouleur de tuyaux d'air comprimé art. 1900S 8x10mm et 1 enrouleur de câbles électriques art. 1844 15-H05/SCK)
- 1 servante mobile à 7 tiroirs (RSC50 C7)
- 1 module fixe à 4 tiroirs (RSC50 M4)
- 3 meubles haut muraux (RSC50 PM)
- 3 panneaux porte-outils perforés supérieurs (RSC50 PFS)
- 3 panneaux porte-outils perforés inférieurs (RSC50 PFI)
- 3 paires d'étriers (RSC50 P/2MDX-SX)
- 1 armoire à 2 portes (RSC50 A2)



356 kg

RSC50 G CHF 13,620.00 1 050001035

RSC50 F

Combinaison d'ameublement d'atelier RSC50

Combinaison comprenant :

- 1 plan de travail de 2240 mm (RSC50 PG/3-2,2MT)
- 1 module fixe à 7 tiroirs (RSC50 M7)
- 1 servante mobile à 7 tiroirs (RSC50 C7)
- 1 module fixe de propreté avec 2 tiroirs (RSC50 MS-2C)
- 3 panneaux porte-outils perforés supérieurs (RSC50 PFS)
- 3 panneaux porte-outils perforés inférieurs (RSC50 PFI)
- 3 paires d'étriers (RSC50 P/2MDX-SX)
- 1 armoire à 2 portes (RSC50 A2)

361 kg

RSC50 F **CHF** 13,340.00 1 050001030

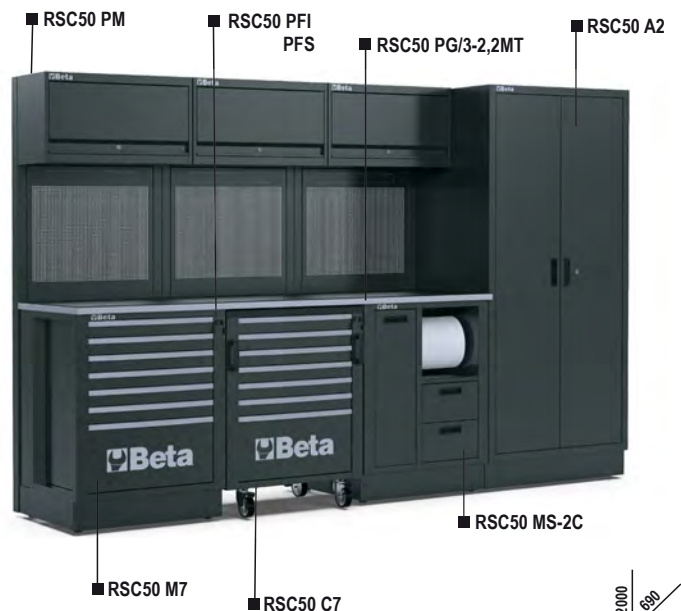

RSC50 E

Combinaison d'ameublement d'atelier RSC50

Combinaison comprenant :

- 1 plan de travail de 2240 mm (RSC50 PG/3-2,2MT)
- 1 module fixe de propreté avec 2 tiroirs (RSC50 MS-2C)
- 1 module fixe à 7 tiroirs (RSC50 M7)
- 1 module fixe à 2 portes (RSC50 MA)
- 3 meubles hauts muraux (RSC50 PM)
- 3 panneaux porte-outils perforés supérieurs (RSC50 PFS)
- 3 panneaux porte-outils perforés inférieurs (RSC50 PFI)
- 3 paires d'étriers (RSC50 P/2MDX-SX)

266 kg

RSC50 E **CHF** 10,910.00 1 050001025



RSC50 D

Combinaison d'ameublement d'atelier RSC50

Combinaison comprenant :

- 1 plan de travail de 1495 mm (RSC50 PG/2-1,5MT)
- 1 module fixe à 5 tiroirs (RSC50 M5)
- 1 module fixe à 2 portes (RSC50 MA)
- 2 meubles hauts muraux (RSC50 PM)
- 2 panneaux porte-outils perforés supérieurs (RSC50 PFS)
- 2 panneaux porte-outils perforés inférieurs (RSC50 PFI)
- 2 paires d'étriers (RSC50 P/2MDX-SX)
- 1 armoire à 1 porte (RSC50 A1)

230 kg

RSC50 D **CHF** 8,360.00 1 050001020

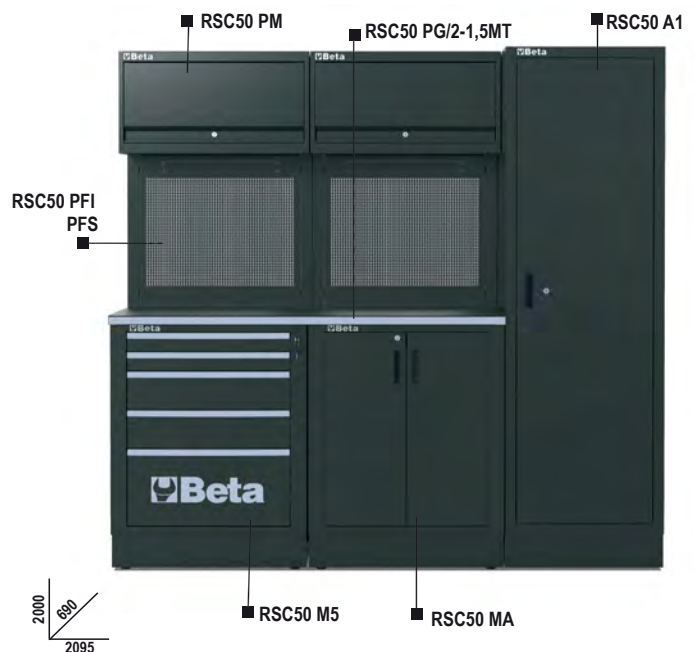

RSC50 C

Combinaison d'ameublement d'atelier RSC50

Combinaison comprenant :

- 1 plan de travail de 1495 mm (RSC50 PG/2-1,5MT)
- 1 module fixe de propreté avec 2 tiroirs (RSC50 MS-2C)
- 1 module fixe à 7 tiroirs (RSC50 M7)
- 2 meubles hauts muraux (RSC50 PM)
- 2 panneaux porte-outils perforés supérieurs (RSC50 PFS)
- 2 panneaux porte-outils perforés inférieurs (RSC50 PFI)
- 2 paires d'étriers (RSC50 P/2MDX-SX)
- 1 armoire à 1 porte (RSC50 A1)

258 kg

RSC50 C

CHF

8,800.00



1



050001015

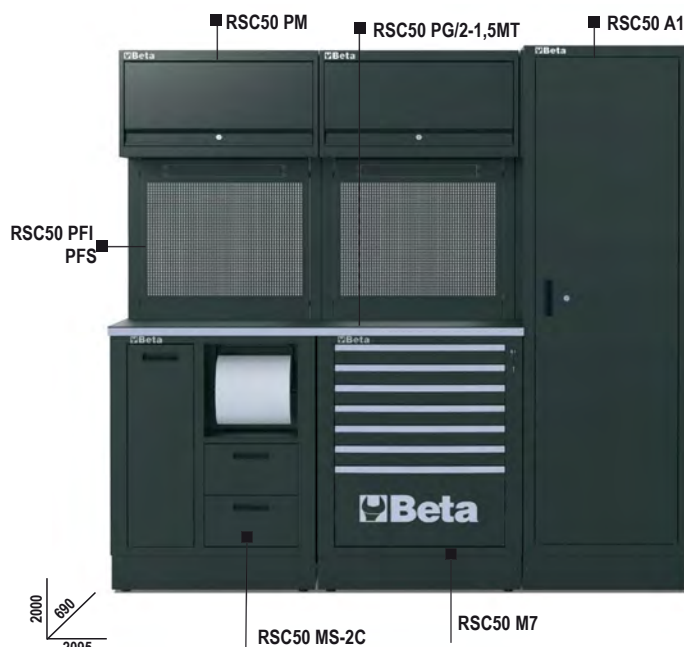

RSC50 B

Combinaison d'ameublement d'atelier RSC50

Combinaison comprenant :

- 1 plan de travail de 1495 mm (RSC50 PG/2-1,5MT)
- 1 module fixe à 2 portes (RSC50 MA)
- 1 module fixe à 7 tiroirs (RSC50 M7)
- 1 Paroi porte-outils avec volet roulant et structure en aluminium (RSC50 PS)

188 kg

RSC50 B

CHF

7,610.00



1



050001010



RSC50 A

Combinaison d'ameublement d'atelier RSC50

Combinaison comprenant :

- 1 plan de travail de 1495 mm (RSC50 PG/2-1,5MT)
- 1 module fixe à 7 tiroirs (RSC50 M7)
- 1 module fixe de propreté à 2 tiroirs (RSC50 MS-2C)
- 2 meubles hauts muraux (RSC50 PM)
- 2 panneaux porte-outils perforés supérieurs (RSC50 PFS)
- 2 panneaux porte-outils perforés inférieurs (RSC50 PFI)
- 2 paires d'étriers (RSC50 P/2MDX-SX)

192 kg

RSC50 A

CHF

7,710.00



1



050001005

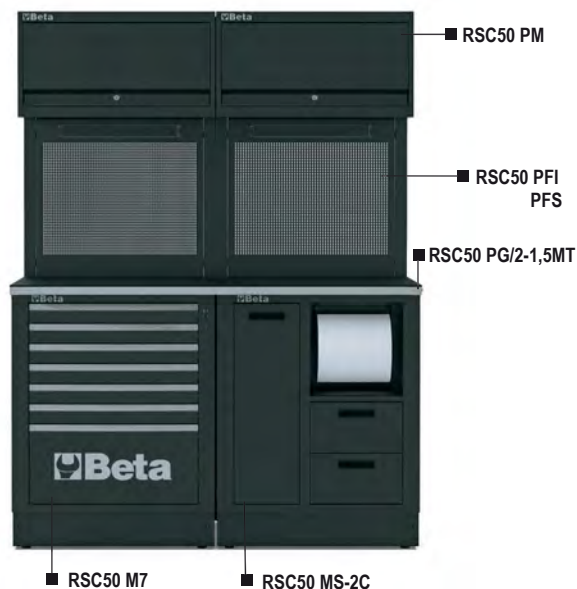

RSC50 P/1-0,7MT

Plan de travail de 0,75 m pour la combinaison d'ameublement d'atelier RSC50

Plan de travail en tôle vernie (750x630 mm) revêtu d'une couche en PVC antichoc, anti-rayures et résistante aux hydrocarbures.

Livré avec deux habillages extérieurs et deux fixations emboîtables.

Trous prévus pour l'installation d'un étau 1599P/125 (non inclus).

12,4 kg



RSC50 PG/1-0,7MT	CHF	630.00	1	050001107
RSC50 PA/1-0,7MT	CHF	630.00	1	050001108

RSC50 P/2-1,5MT

Plan de travail de 1,5 m pour la combinaison d'ameublement d'atelier RSC50

Plan de travail en tôle vernie (1495x630 mm) revêtu d'une couche en PVC antichoc, anti-rayures et résistante aux hydrocarbures.

Livré avec deux habillages extérieurs et deux fixations emboîtables.

Trous prévus pour l'installation d'un étau 1599P/125 (non inclus).

24,5 kg

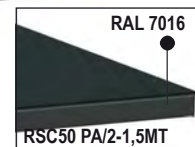

RSC50 PG/2-1,4MT	CHF	883.00	1	050001114
RSC50 PA/2-1,4MT	CHF	883.00	1	050001115

RSC50 P/3-2,2MT

Plan de travail de 2,2 m pour la combinaison d'ameublement d'atelier RSC50

• Plan de travail en tôle vernie (2240x630 mm) revêtu d'une couche en PVC antichoc, anti-rayures et résistante aux hydrocarbures.

• Livré avec deux habillages extérieurs et deux fixations emboîtables.

• Trous prévus pour l'installation d'un étau 1599P/125 (non inclus).

36,5 kg

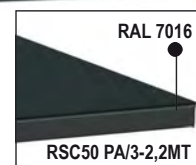

RSC50 PG/3-2,2MT	CHF	1,074.00	1	050001122
RSC50 PA/3-2,2MT	CHF	1,074.00	1	050001123



RSC50 RB

Revêtement PVC antichoc, anti-rayures et résistant aux hydrocarbures

Indispensable pour protéger les plans de travail de l'aménagement d'atelier RSC50:

RSC50 RB/0,63 : conçu pour le plan de travail d'angle, 630x630 mm

RSC50 RB/0,75 : conçu pour le plan de travail d'une longueur de 750 mm

RSC50 RB/1,5 : conçu pour le plan de travail d'une longueur de 1495 mm

RSC50 RB/2,2 : conçu pour le plan de travail d'une longueur de 2240 mm



	CHF		
RSC50 RB/0,63	68.00	1	050001140
RSC50 RB/0,75	82.00	1	050001141
RSC50 RB/1,5	163.50	1	050001142
RSC50 RB/2,2	245.50	1	050001143

RSC50 C5

Servante mobile à 5 tiroirs pour la combinaison d'ameublement d'atelier RSC50

- 5 tiroirs (588x367 mm) montés sur glissières à billes de précision.
- 4 roues directionnelles, Ø 100 mm (dont deux équipées d'un frein)
- Fonds des tiroirs protégés par un tapis en néoprène.
- Serrure de sécurité centralisée frontale
- Tiroirs conçus pour l'emplacement de 4 modules d'outillage BETA
- Poignées intégrées dans la structure afin de faciliter la manipulation

51,4 kg

h	max
70 mm	25 kg
140 mm	30 kg
280 mm	35 kg

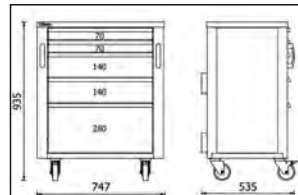
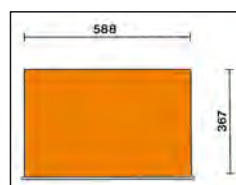

800 kg



	CHF		
RSC50 C5	2,245.00	1	050001205

RSC50 C7

Servante mobile à 7 tiroirs pour la combinaison d'ameublement d'atelier RSC50

- 7 tiroirs (588x367 mm) montés sur glissières à billes de précision.
- 4 roues directionnelles, Ø 100 mm (dont deux équipées d'un frein)
- Fonds des tiroirs protégés par un tapis en néoprène
- Serrure de sécurité centralisée frontale
- Tiroirs conçus pour l'emplacement de 4 modules d'outillage BETA
- Poignées intégrées dans la structure afin de faciliter la manipulation

56,3 kg

h	max
70 mm	25 kg
280 mm	35 kg

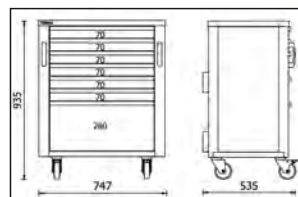
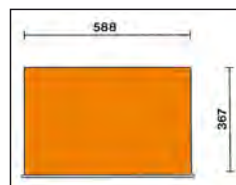

800 kg



	CHF		
RSC50 C7	2,345.00	1	050001207

RSC50 C8

Servante mobile à 8 tiroirs pour la combinaison d'ameublement d'atelier RSC50

- 8 tiroirs (588x367 mm) montés sur glissières à billes de précision.
- 4 roues directionnelles, Ø 100 mm (dont deux équipées d'un frein)
- Fonds des tiroirs protégés par un tapis en néoprène
- Serrure de sécurité centralisée frontale
- Tiroirs conçus pour l'emplacement de 4 modules d'outillage BETA
- Poignées intégrées dans la structure afin de faciliter la manipulation

📦 59 kg

RSC50 C8 **CHF** 2,395.00 1 050001208

h	max
70 mm	25 kg
140 mm	30 kg

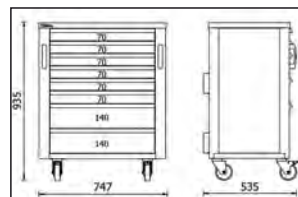
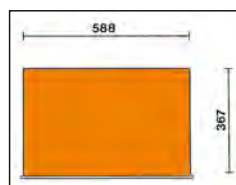

RSC50 M4

Module fixe à 4 tiroirs pour la combinaison d'ameublement d'atelier RSC50

- 4 tiroirs (588x367mm) montés sur glissières à billes de précision
- Fonds des tiroirs protégés par un tapis en néoprène
- Serrure de sécurité centralisée frontale
- Avec pieds réglables en hauteur
- Tiroirs conçus pour l'emplacement de 4 modules d'outillage BETA

📦 44,5 kg

RSC50 M4 **CHF** 1,905.00 1 050001224

h	max
140 mm	30 kg
280 mm	35 kg

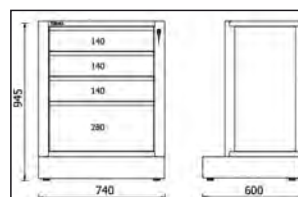
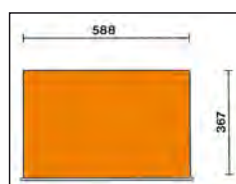

RSC50 M5

Module fixe à 5 tiroirs pour la combinaison d'ameublement d'atelier RSC50

- 5 tiroirs (588x367mm) montés sur glissières à billes de précision
- Fonds des tiroirs protégés par un tapis en néoprène
- Serrure de sécurité centralisée frontale
- Avec pieds réglables en hauteur
- Tiroirs conçus pour l'emplacement de 4 modules d'outillage BETA

📦 47 kg

RSC50 M5 **CHF** 1,955.00 1 050001225

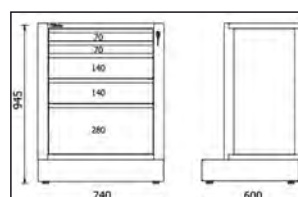
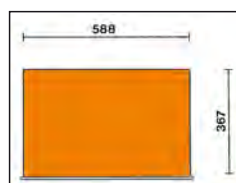

h	max
70 mm	25 kg
140 mm	30 kg
280 mm	35 kg



RSC50 M7

Module fixe à 7 tiroirs pour la combinaison d'ameublement d'atelier RSC50

- 7 tiroirs (588x367mm) montés sur glissières à billes de précision
- Fonds des tiroirs protégés par un tapis en néoprène
- Serrure de sécurité centralisée frontale
- Avec pieds réglables en hauteur
- Tiroirs conçus pour l'emplacement de 4 modules d'outillage BETA

h		 max
	70 mm	25 kg
	280 mm	35 kg

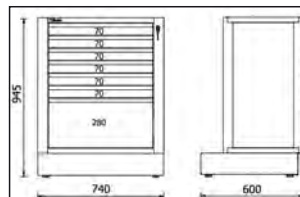
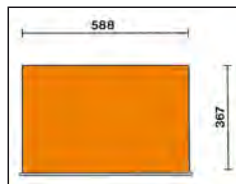

52 kg



RSC50 M7

CHF 2,050.00 1 050001227

RSC50 M8

Module fixe à 8 tiroirs pour la combinaison d'ameublement d'atelier RSC50

- 8 tiroirs (588x367mm) montés sur glissières à billes de précision
- Fonds des tiroirs protégés par un tapis en néoprène
- Serrure de sécurité centralisée frontale
- Avec pieds réglables en hauteur
- Tiroirs conçus pour l'emplacement de 4 modules d'outillage BETA

h		 max
	70 mm	25 kg
	140 mm	30 kg

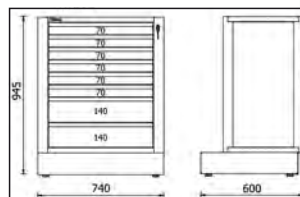
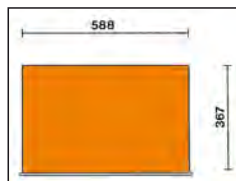

53,2 kg



RSC50 M8

CHF 2,110.00 1 050001228

RSC50 M10

Module fixe à 10 tiroirs pour la combinaison d'ameublement d'atelier RSC50

- 10 tiroirs (588x367mm) montés sur glissières à billes de précision.
- Fonds des tiroirs protégés par un tapis en néoprène
- Serrure de sécurité centralisée frontale
- Avec pieds réglables en hauteur
- Tiroirs conçus pour l'emplacement de 4 modules d'outillage BETA

h		 max
	70 mm	25 kg

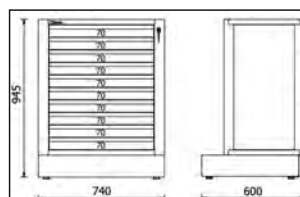
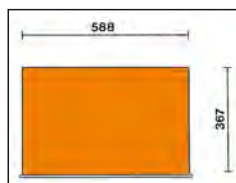

58,2 kg

RSC50 M10

CHF 2,205.00 1 050001230

RSC50 MS-2C

Module fixe de propreté pour la combinaison d'ameublement d'atelier RSC50 (VIDE)

- Poubelle intégrée
- Compartiment pour rouleaux de papier
- 2 tiroirs de dimensions 310x370 mm et d'une hauteur de 180mm
- Avec pieds réglables en hauteur

📦 57 kg

RSC50 MS-2C **CHF** 1,930.00 1 050001243

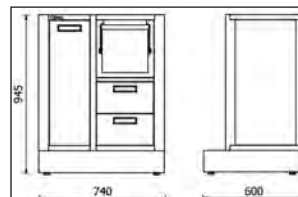

RSC50 MS-AVV

Module fixe de propreté pour la combinaison d'ameublement d'atelier RSC50, (VIDE)

Prédisposition pour l'intégration de 1 enrouleurs à choisir parmi les modèles suivants :

- Enrouleurs de tuyaux d'air comprimé art. 1900S 8x10mm
- Enrouleurs de câbles électriques art. 1843 15-H05, 1844 10-H05, 1844 15-H05, 1844 15-H07, 1844 15-H05/SCK, 1844 15-H07/SCK, 1845 12-H05, 1846 10-H05, 1846 10-H07 et 1846 15-H05

- Poubelle intégrée
- Compartiment permettant le rangement de rouleaux de papier
- Avec pieds réglables en hauteur

📦 41,5 kg

RSC50 MS-AVV **CHF** 1,775.00 1 050001241

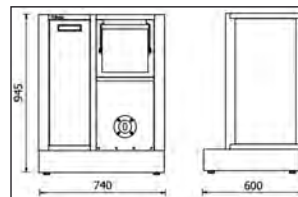

RSC50 MS-2AVV

Module fixe de propreté pour la combinaison d'ameublement d'atelier RSC50, (VIDE)

Permet l'intégration de 2 enrouleurs à choisir parmi les modèles suivants :

- Enrouleurs de tuyaux d'air comprimé art. 1900S 8x10mm
- Enrouleurs de câbles électriques art. 1843 15-H05, 1844 10-H05, 1844 15-H05, 1844 15-H07, 1844 15-H05/SCK, 1844 15-H07/SCK, 1845 12-H05, 1846 10-H05, 1846 10-H07 et 1846 15-H05

- Poubelle incorporée
- Compartiment permettant le rangement de rouleaux de papier
- Avec pieds réglables en hauteur

📦 41,7 kg

RSC50 MS-2AVV **CHF** 1,840.00 1 050001242

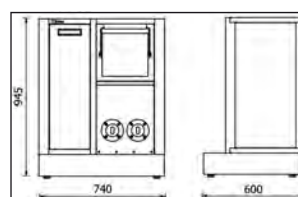

RSC50 MA

Module fixe à 2 portes pour la combinaison d'ameublement d'atelier RSC50

- Avec serrure de sécurité frontale
- Étagère intérieure réglable en hauteur
- Dimensions intérieures : 615x435x740mm
- Avec pieds réglables en hauteur

📦 34 kg

RSC50 MA

CHF 1,585.00 1 050001222

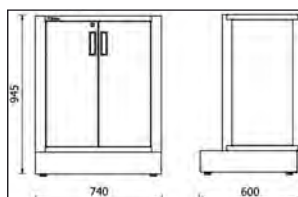

RSC50 CS

Module fixe pour le tri des déchets pour la combinaison d'ameublement d'atelier RSC50

- Compartiment des déchets extractibles (588 x 355 x 580 mm) montés sur glissières à billes de précision.
- 2 grands conteneurs internes pour le tri des déchets
- Avec pieds réglables en hauteur

📦 36 kg

RSC50 CS

CHF 1,840.00 1 050001245

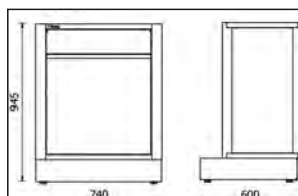

RSC50 ML

Module fixe avec évier intégré pour la combinaison d'ameublement d'atelier RSC50

Caractéristiques techniques :

- Bac en acier inoxydable
- Livré complet avec :
 - 1 mitigeur
 - 1 système de vidange
 - 1 bouchon d'évier
 - 1 bouchon filtrant
 - 1 distributeur de savon

Module fixe à 2 portes avec serrure de sécurité frontale :

- Dimensions intérieures utiles 615x435x 575 mm
- Avec pieds réglables en hauteur

📦 33,5 kg

RSC50 ML

CHF 1,975.00 1 050001244

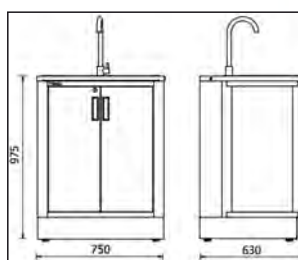

RSC50 MDO

Module fixe de distribution d'huile pour la combinaison d'ameublement d'atelier RSC50

- 2 enrouleurs intégrés avec tuyau flexible de 7 m - 1/2"
- Fourni avec 2 pistolets équipés d'un compte-litres numérique et d'un ramasse-gouttes automatique.
 - débit max. : 30 l/min
 - viscosité: 8 à 2000 mPas

📦 74 kg

RSC50 MDO **CHF** 3,700.00 1 050001250

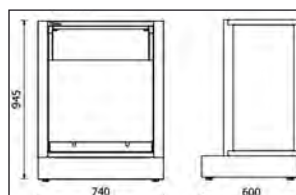

RSC50 T3

Chariot équipé de 3 étagères pour la combinaison d'ameublement d'atelier RSC50

- 4 roues directionnelles, Ø 100 mm (deux 2 équipées de freins)
- Capacité de charge statique : 200 kg (repartie sur les 3 étagères)

📦 22,3 kg

RSC50 T3 **CHF** 434.00 1 050001253

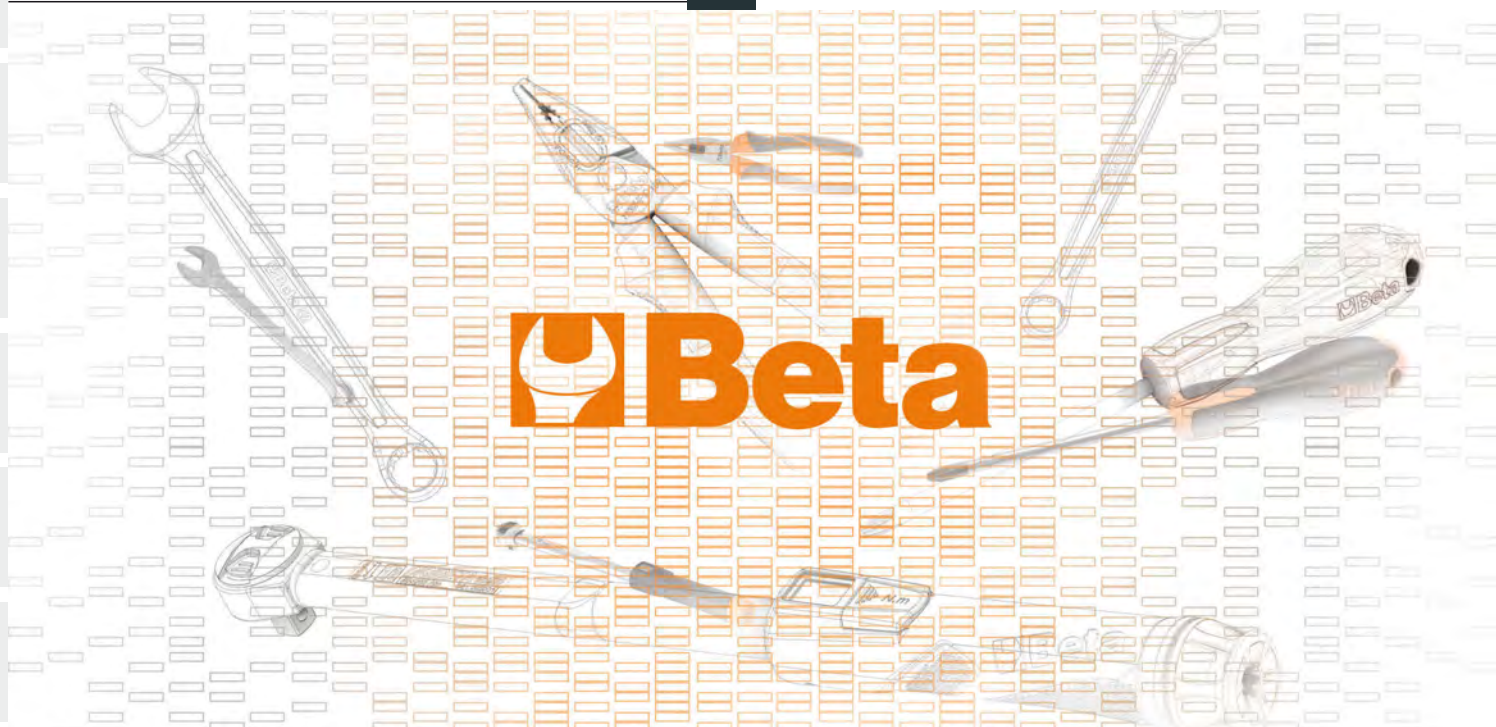
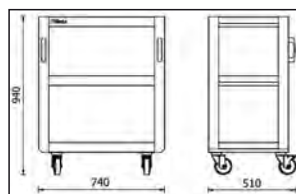

RSC50 KPF

Kit de panneaux d'outils perforés pour la combinaison d'ameublement d'atelier RSC50

- 1 panneau porte-outils perforé inférieur de 650 x 625 x 25 mm, avec possibilité d'insérer un block prise (non inclus)
- 1 panneau porte-outils perforé supérieur de 650 x 400 x 25mm
- 1 paire d'étrier

14,8 kg

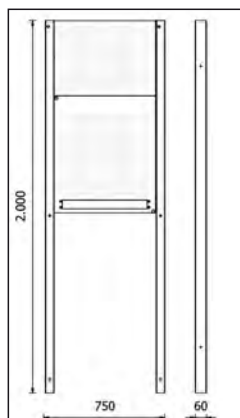

RSC50 KPF

CHF 738.00 1 050001310

RSC50 PFS

Panneau d'outils perforé supérieur pour la combinaison d'ameublement d'atelier RSC50

- Panneau perforé (650x400x25 mm) permettant le support des outils

2,5 kg

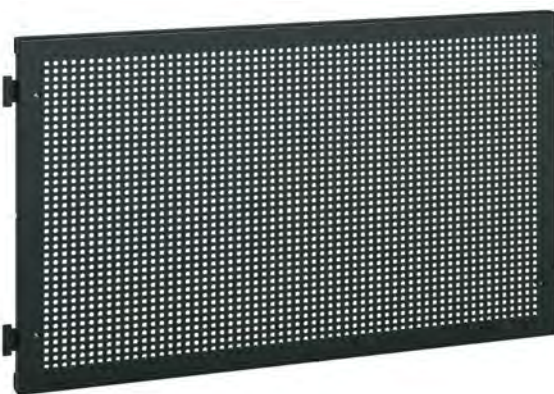

RSC50 PFS

CHF 210.00 1 050001312

RSC50 PFI

Panneau porte-outils perforé inférieur pour la combinaison d'ameublement d'atelier RSC50

- Panneau perforé inférieur (650x625x25 mm) pour le support des outils
- Possibilité d'y insérer un bloc multiprises 19" (non inclus)

3,8 kg



RSC50 PFI

CHF 240.00 1 050001313

RSC50 P/2MDX-SX

Paire d'étriers pour combinaison d'équipement d'atelier RSC50

📦 8,5 kg

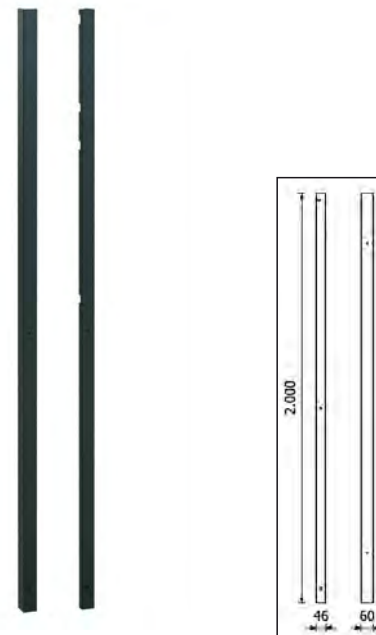

RSC50 P/2MDX-SX

CHF 288.00 1 050001352

RSC50 PM

Meuble haut mural pour la combinaison d'ameublement d'atelier RSC50

- Dimensions: 740x300x400 mm
- Équipé de ressorts à gaz, facilitant l'ouverture et la fermeture de la porte
- Conçu pour l'application d'un profilé thermoplastique avec ruban LED art. 5000 RSC50/PLED ou 5000 RSC50/PLED-ST (non inclus), pour éclairer la zone de travail

📦 14 kg



📦 30 kg

RSC50 PM

CHF 684.00 1 050001302

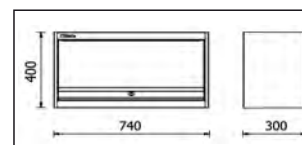

RSC50 MTP

Étagère triangulaire pour la combinaison d'ameublement d'atelier RSC50

- Dimensions : 740 x 300 x 400 mm
- Conçu pour l'application de profilés aluminium avec ruban LED art. 5000 RSC50/PLED ou 5000 RSC50/PLED-ST (non inclus), pour éclairer la zone de travail

📦 6,5 kg



📦 10 kg

RSC50 MTP

CHF 350.00 1 050001305



RSC50 PS

Paroi porte-outils avec volet roulant et structure en aluminium pour la combinaison d'ameublement d'atelier RSC50

- 1 Paroi porte-outils avec volet roulant et structure en aluminium (RSC50 PS)
- Panneaux perforés amovibles facilitant le rangement des outils
- Fournie avec sa structure autoportante
- Possibilité de le combiner avec l'établi d'une longueur de 1495 mm

77 kg



RSC50 PS	CHF	3,090.00	1	050001360
----------	-----	----------	---	-----------

RSC50 AC

Angle complet autoportant pour la combinaison d'ameublement d'atelier RSC50

Caractéristiques :

- Plan de travail de 630x630x30mm avec pieds
- 2 panneaux d'outils perforés inférieurs de 650x625x25 mm, avec possibilité d'insérer un bloc électrique (non inclus)
- 2 panneaux porte-outils perforés supérieurs de 650x400x25 mm
- Livré avec support de structure

41 kg



RSC50 AC-A



RAL 7046



RSC50 AC-G

RSC50 AC-G	CHF	2,400.00	1	050001330
RSC50 AC-A	CHF	2,400.00	1	050001329

RSC50 KAI

Module angulaire bas 630x630 mm avec pieds réglables en hauteur

- Plan de travail en tôle vernie (630x630 mm) revêtu d'une couche en PVC antichoc, anti-rayures et résistante aux hydrocarbures

16 kg



RSC50 KAI-A

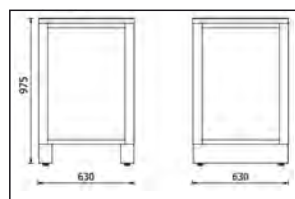

RAL 7046

RAL 7016



RSC50 KAI-G

RSC50 KAI-G	CHF	1,380.00	1	050001335
RSC50 KAI-A	CHF	1,380.00	1	050001336

RSC50 A1

Armoire métallique à une porte pour la combinaison d'ameublement d'atelier RSC50

- 4 étagères amovibles et réglables en hauteur
- Tringle à vêtements intégrée sous la première étagère
- Avec serrure de sécurité • Dimensions intérieures utiles : 590x615 mm
- Pieds réglables en hauteur

📦 66 kg

RSC50 A1 CHF 1,091.00 1 050001411

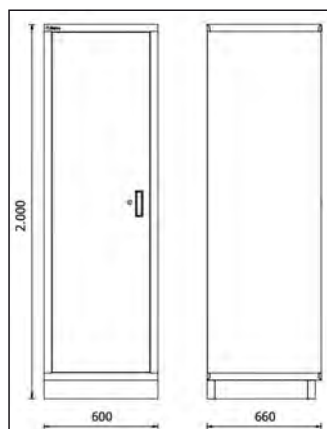

RSC50 A1/R59

Etagère intérieure pour armoire RSC50 A1

RSC50 A1/R59 605x596 mm CHF 68.00 1 050001913



RSC50 A1/RB59

Etagère intérieure avec tringle à vêtements pour armoire RSC50 A1

RSC50 A1/RB59 605x596 mm CHF 80.50 1 050001914



RSC50 A2

Armoire à 2 portes en tôle pour l'ameublement d'atelier RSC50

- 4 étagères amovibles réglables en hauteur
- Avec serrure de sécurité
- Dimensions intérieures : 910x615 mm
- Avec pieds réglables en hauteur

📦 90 kg

RSC50 A2 CHF 1,675.00 1 050001412

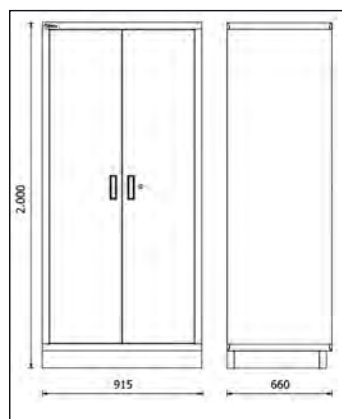

RSC50 A2/R91

Etagère intérieure pour armoire RSC50 A2

RSC50 A2/R91 911x596 mm CHF 98.00 1 050001915

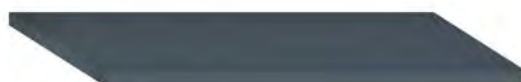

5000 RSC50/MP

Étagère pour la combinaison d'ameublement d'atelier RSC50

- Dimensions 740x140x80mm
- Conçu pour la pose de bande LED article 5000 RSC50/PLED ou 5000 RSC50/PLED-ST (à commander séparément), permettant d'éclairer la zone de travail

2,3 kg



5000 RSC50/MP

CHF 158.00 1 050001705

5000 RSC50/MPA140

Étagère d'angle, profondeur 140 mm, pour combinaison d'ameublement d'atelier RSC50

- Dimensions : 630x630x35 mm, profondeur 140 mm
- A fixer sur les panneaux perforés du module d'angle RSC50 AC
- Conçu pour l'application de profilés en aluminium avec bandes LED article 5000 RSC50/PLED ou 5000 RSC50/PLED-ST (à commander séparément), pour éclairer la zone de travail

3 kg



5000 RSC50/MPA140

CHF 209.50 1 050001706

5000 RSC50/CLL

Meuble haut mural prévu pour la combinaison d'ameublement d'atelier RSC50

- Dimensions 740x125x30mm
- A fixer sur les panneaux d'outils perforés
- Conçu pour l'application d'un profilé thermoplastique avec ruban LED art. 5000 RSC50/PLED ou 5000 RSC50/PLED-ST (non inclus), pour éclairer la zone de travail

1 kg



5000 RSC50/CLL

CHF 158.00 1 050001710

5000 RSC50/CAL

Meuble haut d'angle prévu pour la combinaison d'ameublement d'atelier RSC50

- Dimensions 655x655x30mm
- A fixer sur les panneaux d'outils perforés du module d'angle
- Conçu pour l'application de profilés aluminium avec ruban LED art. 5000 RSC50/PLED ou 5000 RSC50/PLED-ST (non inclus), pour éclairer la zone de travail

1,7 kg



5000 RSC50/CAL

CHF 209.50 1 050001711

5000 RSC50/KFC

Kit comprenant 10 poignées colorées pour tiroir d'ameublement d'atelier RSC50

- Permet la personnalisation de la couleur des façades des tiroirs de la combinaison d'ameublement d'atelier RSC50.
Recommandé pour une utilisation en combinaison avec des plans de travail avec un chant en gris anthracite RAL7016 (-A).



	CHF		
5000 RSC50/KFC2011	110.50	1	050001731
5000 RSC50/KFC3000	110.50	1	050001733
5000 RSC50/KFC5015	110.50	1	050001734
5000 RSC50/KFC7016	110.50	1	050001737

Beta

PROFESSIONNEL, ROBUSTE ET SOIGNÉ

Le **C45PRO** est l'équipement d'atelier professionnel qui permet d'optimiser au mieux votre espace de travail. Avec son nouveau design 2021 et ses améliorations techniques, il est d'un excellent rapport qualité/prix.

L'équipement d'atelier modulaire **C45PRO** permet de créer son propre atelier de travail en fonction de l'espace disponible et des besoins d'utilisation. Cette gamme professionnelle et modulaire basée sur des combinaisons prédéterminées, peut être complétée dans le temps.

Le poste de travail peut être entièrement personnalisé :

- plans de travail en MDF revêtu d'acier inoxydable ou en bois contre-plaqué stratifié
- nombreux éléments et accessoires disponibles.

Optimisez votre atelier afin de vous adaptez à votre environnement de travail.

Choisissez parmi les solutions préassemblées ou créez votre atelier à partir des modules disponibles.



LA COMBINAISON D'ATELIER C45PRO ÉVOLUE ET SE MET AUX COULEURS DE BETA !

Configurez votre atelier en 3D en ligne

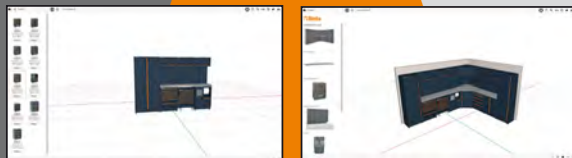

www.beta-tools.com

C45PRO DX

Combinaison d'ameublement d'atelier C45PRO DX

Combinaison comprenant:

- 1 plan de travail en MDF revêtu d'acier inoxydable (C45PX / 3-2,0MT)
- 1 plan de travail en MDF revêtu en acier inoxydable (C45PX / 2-1,3MT)
- 1 module fixe à 7 tiroirs (C45PRO M7)
- 1 cabine roulant mobile à 7 tiroirs (C45PRO C7)
- 1 module de propreté (C45PRO MS)
- 1 module fixe avec 5 tiroirs (C45PRO M5)
- 1 module fixe deux portes (C45PRO MA)
- 1 coin complet autoportant avec plan de travail en MDF revêtu d'acier inoxydable (C45PRO CORNER/X)
- 5 panneaux porte-outils perforés (C45PRO PF)
- 5 armoires murales (C45PRO PM)
- 7 supports muraux, type large (C45PRO SL)
- 2 supports muraux, type étroit (C45PRO SS)
- 2 armoires à une porte (C45PRO AS1)

572,3 kg

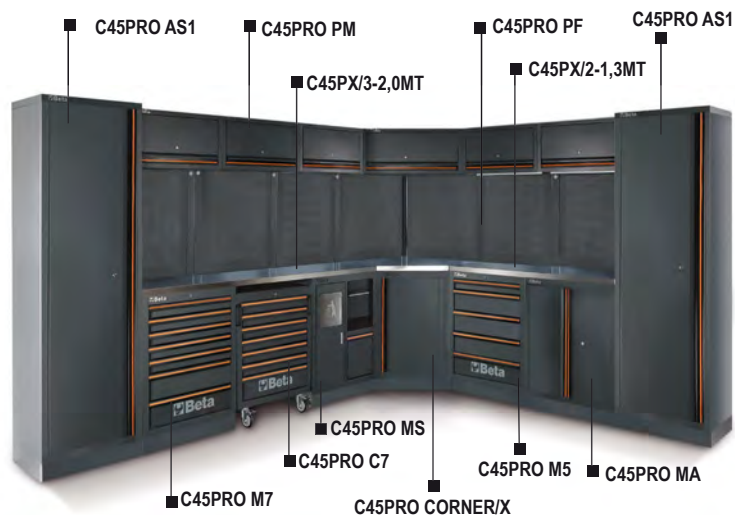

C45PRO DW

Combinaison d'ameublement d'atelier C45PRO DW

Combinaison comprenant:

- 1 plan de travail en bois multiplis (C45PW / 3-2.0MT)
- 1 plan de travail en bois multiplis (C45PW / 2-1.3MT)
- 1 module fixe à 7 tiroirs (C45PRO M7)
- 1 cabine roulant mobile à 7 tiroirs (C45PRO C7)
- 1 module de propreté (C45PRO MS)
- 1 module fixe avec 5 tiroirs (C45PRO M5)
- 1 module fixe à deux portes (C45PRO MA)
- 1 coin complet autoportant avec plan de travail en bois (C45PRO CORNER/W)
- 5 panneaux porte-outils perforés (C45PRO PF)
- 5 armoires murales (C45PRO PM)
- 7 supports muraux, type large (C45PRO SL)
- 2 supports muraux, type étroit (C45PRO SS)
- 2 armoires à une porte (C45PRO AS1)

568,5 kg

C45PRO DW **CHF** 11,840.00 1 045000032

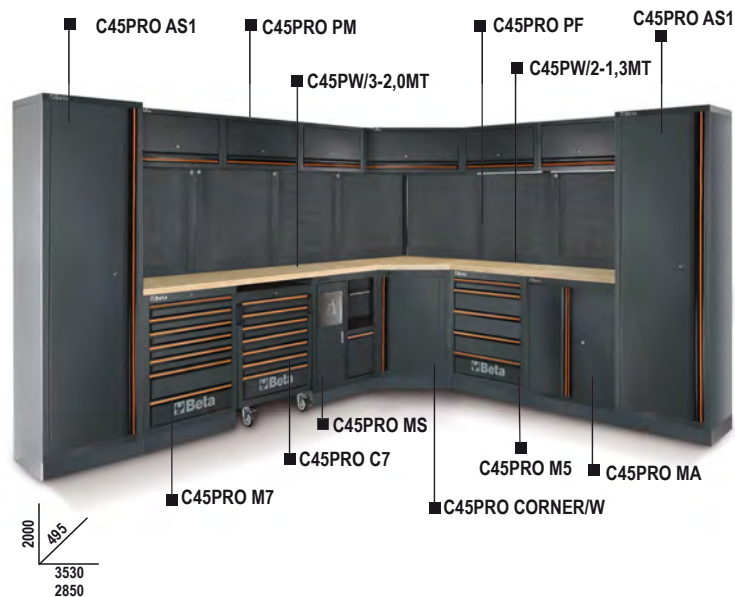

C45PRO FX

Combinaison d'ameublement d'atelier C45PRO

Combinaison comprenant :

- 1 plan de travail en MDF revêtu en acier inoxydable (C45PX/3-2.0MT)
- 1 plan de travail en MDF revêtu en acier inoxydable (C45PX/2-1,3MT)
- 1 module fixe à deux portes (C45PRO MA)
- 1 servante mobile avec 7 tiroirs (C45PRO C7)
- 1 module fixe avec 7 tiroirs (C45PRO M7)
- 1 module fixe avec deux enrouleurs intégrés (C45PRO ACT)
- 1 module fixe de propreté (C45PRO MS)
- 1 angle complet autoportant avec plan de travail en MDF revêtu en acier inoxydable (C45PRO C/X)
- 2 panneaux porte-outils perforés (C45PRO PF)
- 1 panneau porte-outils perforé qui peut être équipé d'une prise de courant (non incluse) (C45PRO PFE)
- 3 meubles hauts muraux (C45PRO PM)
- 1 paroi porte-outils avec volet roulant en aluminium (C45PRO PA)
- 6 étriers type large (C45PRO SL)
- 2 étriers type étroit (C45PRO SS)
- 2 armoires à 1 porte (C45PRO AS1)

576 kg

C45PRO FX **CHF** 12,970.00 1 045000035

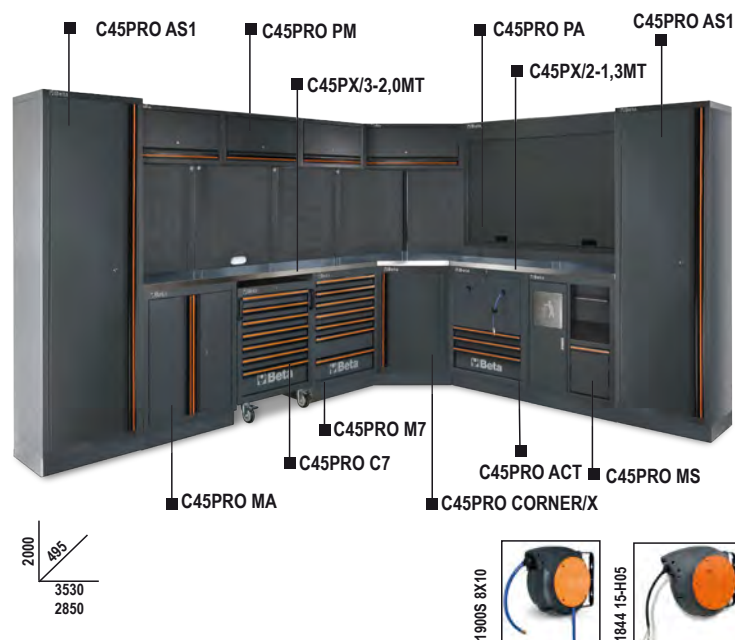

C45PRO FW

Combinaison d'ameublement d'atelier C45PRO

Combinaison comprenant :

- 1 plan de travail en bois contreplaqué stratifié (C45PW/3-2.0MT)
- 1 plan de travail en bois contreplaqué stratifié (C45PW/2-1,3MT)
- 1 module fixe à deux portes (C45PRO MA)
- 1 servante mobile avec 7 tiroirs (C45PRO C7)
- 1 module fixe avec 7 tiroirs (C45PRO M7)
- 1 module fixe avec deux enrouleurs intégrés (C45PRO ACT)
- 1 module fixe de propreté (C45PRO MS)
- 1 angle complet autoportant avec plan de travail en bois contreplaqué stratifié (C45PRO C/W)
- 2 panneaux porte-outils perforés (C45PRO PF)
- 1 panneau porte-outils perforé qui peut être équipé d'une prise de courant (non incluse) (C45PRO PFE)
- 3 meubles hauts muraux (C45PRO PM)
- 1 paroi porte-outils avec volet roulant en aluminium (C45PRO PA)
- 6 étriers de type large (C45PRO SL)
- 2 étriers de type étroit (C45PRO SS)
- 2 armoires à 1 porte (C45PRO AS1)

572 kg

C45PRO FW **CHF** 12,550.00 1 045000045

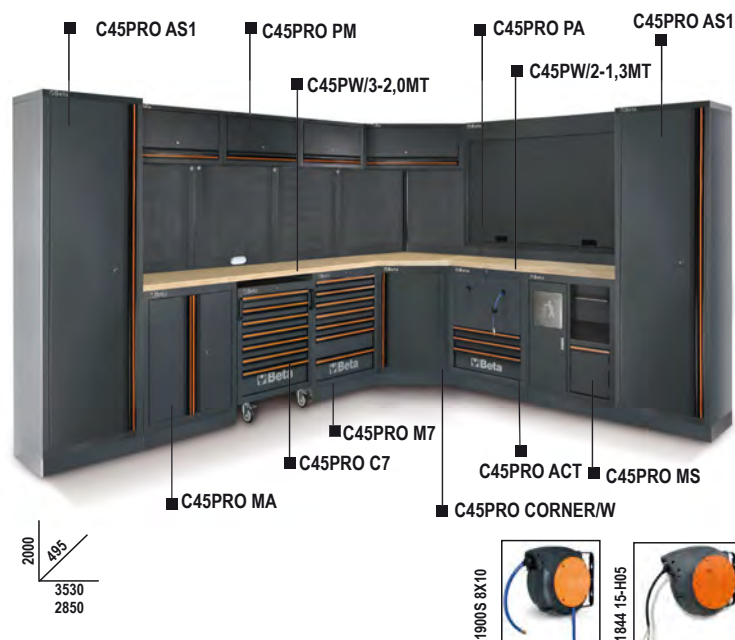

C45PRO GX

Combinaison d'ameublement d'atelier C45PRO

Combinaison comprenant :

- 1 plan de travail en MDF revêtu en acier inoxydable (C45PX/3-2,0MT)
- 1 plan de travail en MDF revêtu en acier inoxydable (C45PX/1-0,7MT)
- 1 module fixe avec deux enrouleurs intégrés (C45PRO ACT)
- 1 servante mobile avec 7 tiroirs (C45PRO C7)
- 1 module fixe avec 7 tiroirs (C45PRO M7)
- 1 module fixe à deux portes (C45PRO MA)
- 1 angle complet autoportant avec plan de travail en MDF revêtu en acier inoxydable (C45PRO CORNER/X)
- 1 panneau porte-outils perforé (C45PRO PF)
- 1 panneau porte-outils perforé qui peut être équipé d'une prise de courant (non incluse) (C45PRO PFE)
- 2 meubles hauts muraux (C45PRO PM)
- 1 paroi porte-outils avec volet volet roulant en aluminium (C45PRO PAS)
- 6 étagères de type large (C45PRO SL)
- 2 étagères de type étroit (C45PRO SS)
- 2 armoires à 1 porte (C45PRO AS1)

507 kg

C45PRO GX **CHF** 11,620.00 1 045000036

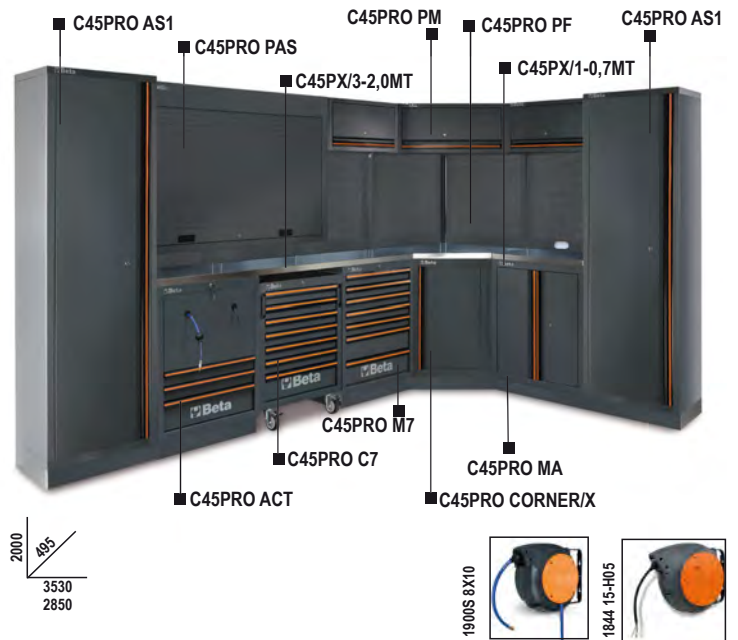

C45PRO GW

Combinaison d'ameublement d'atelier C45PRO

Combinaison comprenant :

- 1 plan de travail en bois contreplaqué stratifié (C45PW/3-2,0MT)
- 1 plan de travail en bois contreplaqué stratifié (C45PW/1-0,7MT)
- 1 module fixe avec deux enrouleurs intégrés (C45PRO ACT)
- 1 servante mobile avec 7 tiroirs (C45PRO C7)
- 1 module fixe avec 7 tiroirs (C45PRO M7)
- 1 module fixe avec évier intégré (C45PRO ML)
- 1 angle complet autoportant avec plan de travail en bois contreplaqué stratifié (C45PRO CORNER/W)
- 1 panneau porte-outils perforé (C45PRO PF)
- 1 panneau porte-outils perforé qui peut être équipé d'une prise de courant (non incluse) (C45PRO PFE)
- 2 meubles hauts muraux (C45PRO PM)
- 1 paroi porte-outils avec volet roulant en aluminium (C45PRO PAS)
- 6 étagères de type large (C45PRO SL)
- 2 étagères de type étroit (C45PRO SS)
- 2 armoires à 1 porte (C45PRO AS1)

504 kg

C45PRO GW **CHF** 11,250.00 1 045000037

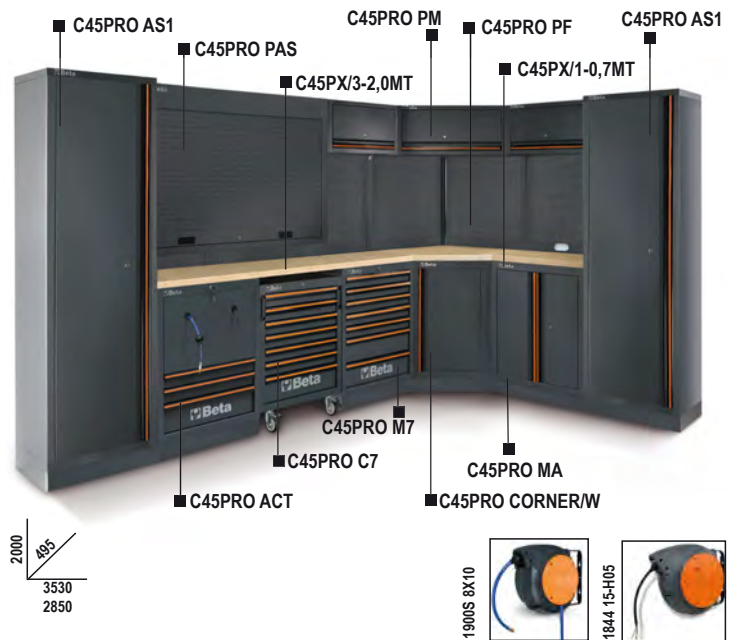

C45PRO X

Combinaison d'ameublement d'atelier C45PRO X

Combinaison comprenant :

- Plan de travail en MDF revêtu d'acier inoxydable (C45PX / 3-2.0MT)
- Module fixe à 7 tiroirs (C45PRO M7)
- Module de propreté (C45PRO MS)
- Cabine mobile à 7 tiroirs (C45PRO C7)
- Armoire à outils à deux portes (C45PRO AS2)
- 3 panneaux porte-outils perforés (C45PRO PF)
- 3 armoires murales (C45PRO PM)
- 3 supports muraux, type large (C45PRO SL)
- 1 support mural, type étroit (C45PRO SS)

305 kg

C45PRO X **CHF** 6,190.00 1 045000001

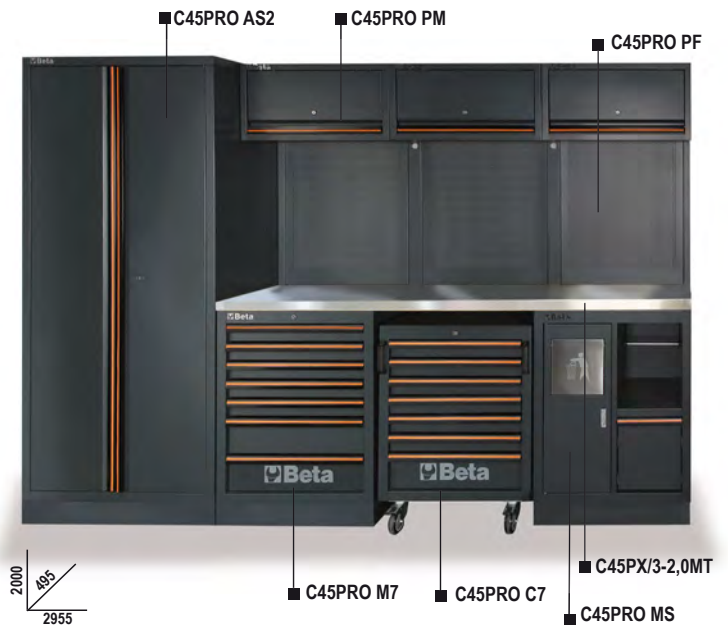

C45PRO W

Combinaison d'ameublement d'atelier C45PRO W

Combinaison comprenant :

- Plan de travail en bois multicouche (C45PW / 3-2.0MT)
- Module fixe à 7 tiroirs (C45PRO M7)
- Module de propreté (C45PRO MS)
- Cabine mobile à 7 tiroirs (C45PRO C7)
- Armoire à outils à deux portes (C45PRO AS2)
- 3 panneaux porte-outils perforés (C45PRO PF)
- 3 armoires murales (C45PRO PM)
- 3 supports muraux, type large (C45PRO SL)
- 1 support mural, type étroit (C45PRO SS)

303 kg

C45PRO W

CHF 6,030.00 1 045000002

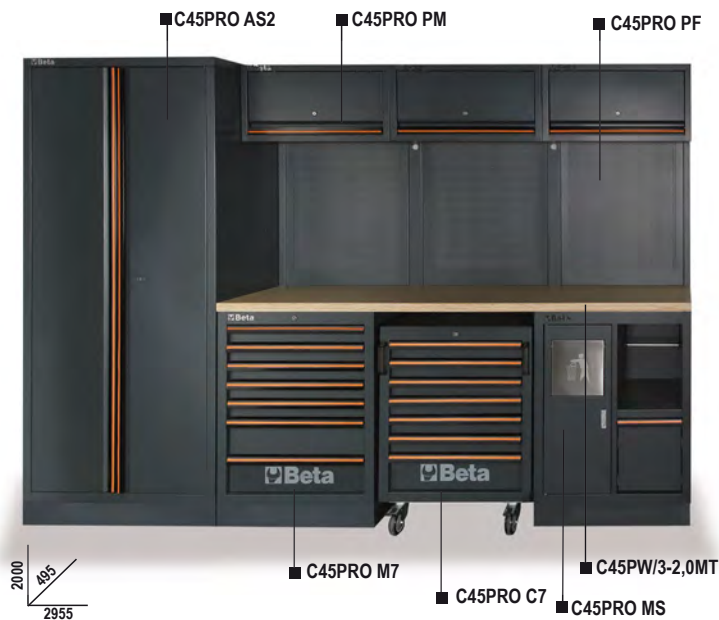

C45PRO HX

Combinaison d'ameublement d'atelier C45PRO

Combinaison comprenant :

- 1 plan de travail en MDF revêtu en acier inoxydable (C45PX/3-2.0MT)
- 1 module fixe avec deux enrouleurs intégrés (C45PRO ACT)
- 1 servante mobile avec 7 tiroirs (C45PRO C7)
- 1 module fixe avec 4 tiroirs (C45PRO M4)
- 3 meubles hauts muraux (C45PRO PM)
- 3 panneaux porte-outils perforés (C45PRO PF)
- 3 étriers de type large (C45PRO SL)
- 1 étrier de type étroit (C45PRO SS)
- 1 armoire à 2 portes (C45PRO AS2)

300 kg

C45PRO HX

CHF 6,660.00 1 045000038

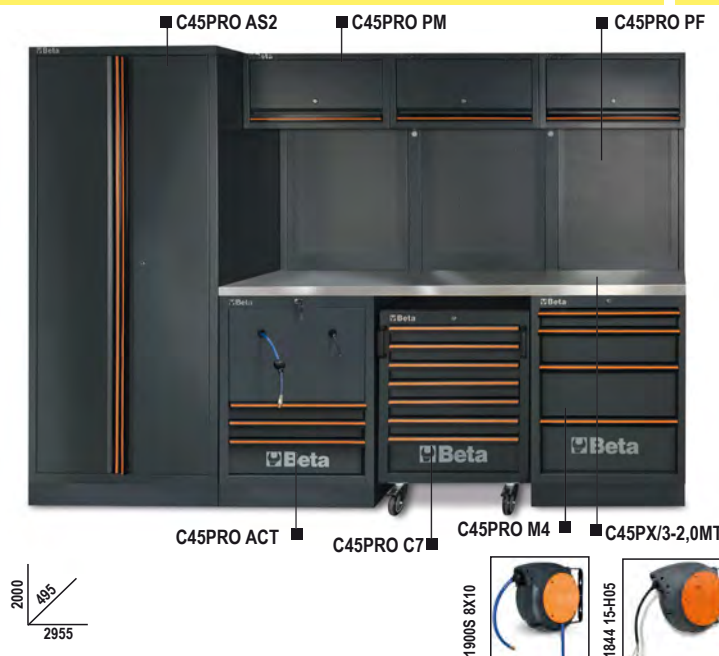

C45PRO HW

Combinaison d'ameublement d'atelier C45PRO

Combinaison comprenant :

- 1 plan de travail en bois contreplaqué stratifié (C45PW/3-2.0MT)
- 1 module fixe avec deux enrouleurs intégrés (C45PRO ACT)
- 1 servante mobile avec 7 tiroirs (C45PRO C7)
- 1 module fixe avec 4 tiroirs (C45PRO M4)
- 3 armoires murales (C45PRO PM)
- 3 panneaux d'outils perforés (C45PRO PF)
- 3 supports muraux de type large (C45PRO SL)
- 1 support mural de type étroit (C45PRO SS)
- 1 armoire à outils à deux portes (C45PRO AS2)

299 kg

C45PRO HW

CHF 6,500.00 1 045000039

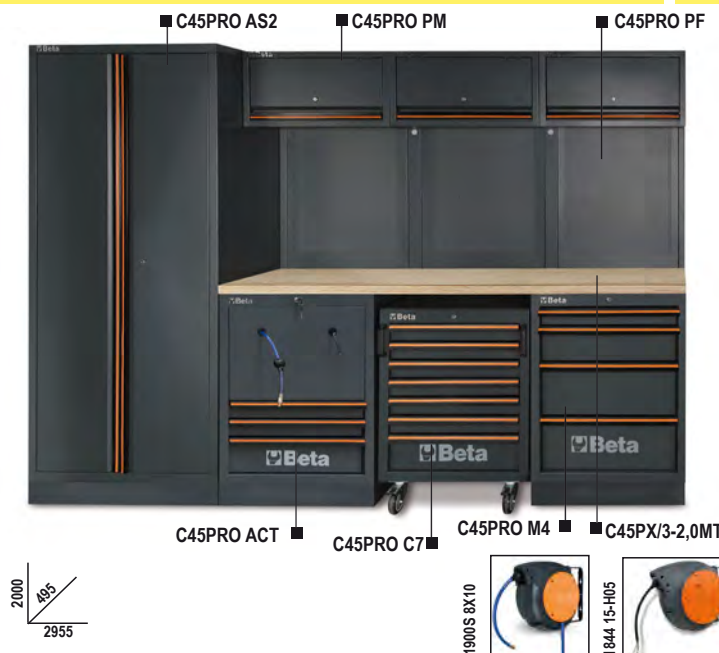

C45PRO AX

Combinaison d'ameublement d'atelier C45PRO AX

Combinaison comprenant:

- Plan de travail en MDF revêtu d'acier inoxydable (C45PX / 3-2.0MT)
- Module fixe à 7 tiroirs (C45PRO M7)
- Module de propreté (C45PRO MS)
- Module fixe à deux portes (C45PRO MA)
- 3 armoires murales (C45PRO PM)
- 3 panneaux porte-outils perforés (C45PRO PF)
- 2 supports muraux, type large (C45PRO SL)
- 2 supports muraux, type étroit (C45PRO SS)

📦 206 kg

C45PRO AX **CHF** 4,300.00 1 045000003



C45PRO AW

Combinaison d'ameublement d'atelier C45PRO AW

Combinaison comprenant:

- Plan de travail en bois multicouche (C45PW / 3-2.0MT)
- Module fixe avec 2 tiroirs (C45PRO MA)
- Module fixe à 7 tiroirs (C45PRO M7)
- Module de propreté (C45PRO MS)
- 3 armoires murales (C45PRO PM)
- 3 panneaux porte-outils perforés (C45PRO PF)
- 2 supports muraux, type étroit (C45PRO SS)
- 2 supports muraux, type large (C45PRO SL)

📦 204 kg

C45PRO AW **CHF** 4,140.00 1 045000004



C45PRO BX

Combinaison d'ameublement d'atelier C45PRO BX

Combinaison comprenant:

- Plan de travail en MDF revêtu d'acier inoxydable (C45PX / 2-1.3MT)
- Module fixe avec 5 tiroirs (C45PRO M5)
- Module fixe à deux portes (C45PRO MA)
- Armoire à outils à une porte (C45PRO AS1)
- 2 armoires murales (C45PRO PM)
- 2 panneaux porte-outils perforés (C45PRO PF)
- 2 supports muraux, type large (C45PRO SL)
- 1 support mural, type étroit (C45PRO SS)

📦 191 kg

C45PRO BX **CHF** 3,880.00 1 045000021



C45PRO BW

Combinaison d'ameublement d'atelier C45PRO BW

Combinaison comprenant:

- Plan de travail en bois multicouche (C45PW / 2-1.3MT)
- Module fixe avec 5 tiroirs (C45PRO M5)
- Module fixe à deux portes (C45PRO MA)
- Armoire à outils à une porte (C45PRO AS1)
- 2 armoires murales (C45PRO PM)
- 2 panneaux porte-outils perforés (C45PRO PF)
- 2 supports muraux, type large (C45PRO SL)
- 1 support mural, type étroit (C45PRO SS)

190 kg

C45PRO BW

CHF
3,720.00



1

045000022

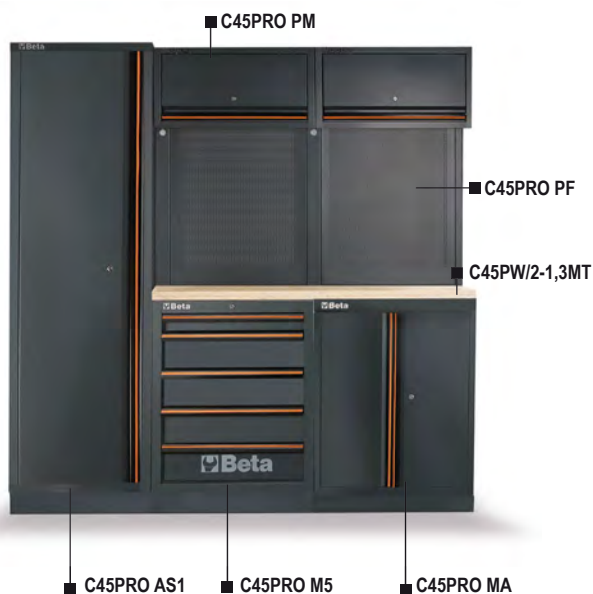

C45PRO EX

combinaison d'équipements d'atelier C45PRO avec plan de travail Inox

Combinaison comprenant:

- 2 panneaux d'outils perforés (C45PRO PF)
- 2 armoires murales (C45PRO PM)
- 2 supports muraux, de type large (C45PRO SL)
- 1 support mural, type étroit (C45PRO SS)
- 1 armoire à une porte (C45PRO AS1)
- Module fixe avec 7 tiroirs et plan de travail MDF revêtu d'acier inoxydable (C45PRO M7A/X):
- 1 tiroir, 1248x406 mm
- 6 tiroirs, 782x406 mm 5 tiroirs, 65 mm de haut 1 tiroir, 145 mm de haut
- 1 compartiment de rangement avec étagère intermédiaire et porte

174,6 kg

C45PRO EX

CHF
4,120.00



1

045000033



C45PRO EW

combinaison d'équipements d'atelier C45PRO avec plan de travail Bois

Combinaison comprenant:

- 2 panneaux d'outils perforés (C45PRO PF)
- 2 armoires murales (C45PRO PM)
- 2 supports muraux, de type large (C45PRO SL)
- 1 support mural, type étroit (C45PRO SS)
- 1 armoire à outils à porte unique (C45PRO AS1)
- Module fixe avec 7 tiroirs et plan de travail en bois multicouche (C45PRO M7A/W):
- 1 tiroir, 1248x406 mm
- 6 tiroirs, 782x406 mm 5 tiroirs, 65 mm de haut 1 tiroir, 145 mm de haut
- 1 compartiment de rangement avec étagère intermédiaire et porte

173,6 kg

C45PRO EW

CHF
3,980.00



1

045000034

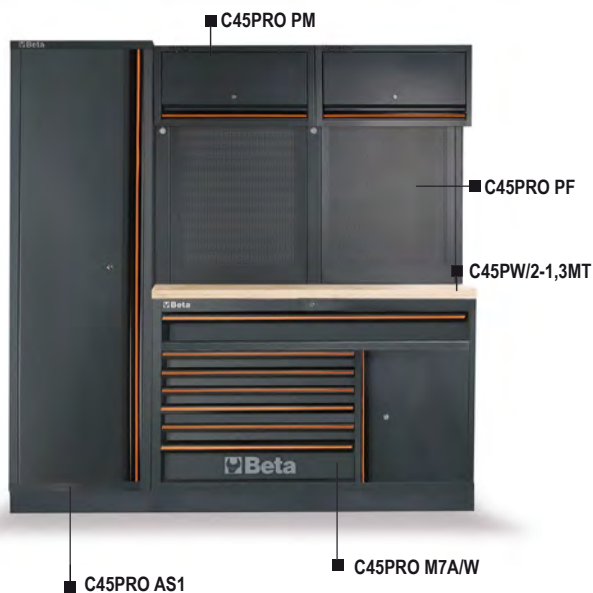

C45PRO CX

Combinaison d'équipements d'atelier C45PRO

Combinaison comprenant :

- Plan de travail en MDF revêtu d'acier inoxydable (C45PX/2-1,3MT)
- Module fixe avec 7 tiroirs (C45PRO M7)
- Module de service fixe (C45PRO MS)
- Armoire à porte unique (C45PRO AS1)
- 2 armoires murales (C45PRO PM)
- 2 panneaux d'outils perforés (C45PRO PF)
- 2 supports muraux, de type large (C45PRO SL)
- 1 support mural, de type étroit (C45PRO SS)

199 kg

C45PRO CX **CHF** 4,150.00 1 045000023



C45PRO CW

combinaison d'équipements d'atelier C45PRO avec plan de travail Bois

Combinaison comprenant:

- Plan de travail en bois multicouche (C45PW/2-1.3MT)
- Module fixe avec 7 tiroirs (C45PRO M7)
- Module de service fixe (C45PRO MS)
- Armoire à porte unique (C45PRO AS1)
- 2 armoires murales (C45PRO PM)
- 2 panneaux d'outils perforés (C45PRO PF)
- 2 supports muraux, de type large (C45PRO SL)
- 1 support mural, type étroit (C45PRO SS)

198 kg

C45PRO CW **CHF** 3,990.00 1 045000024

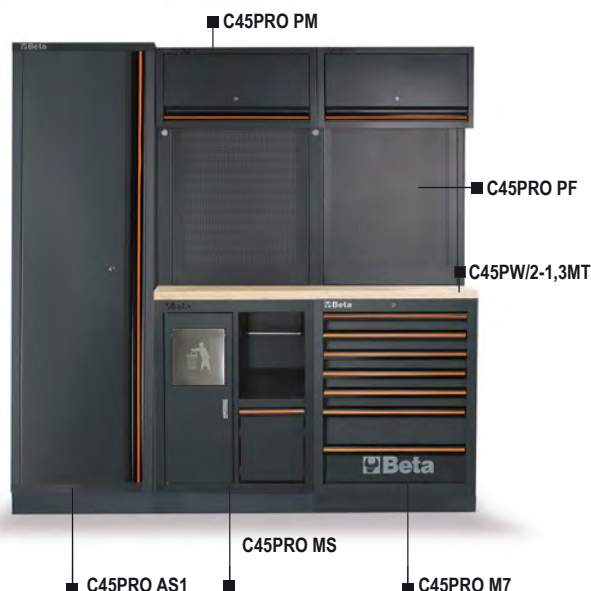

C45PRO BPX-2,0

établis inox 2,0m pour la combinaison d'équipements d'atelier C45PRO

Combinaison comprenant:

- Plan de travail en MDF revêtu d'acier inoxydable (C45PX / 3-2.0MT)
- Module fixe avec 7 tiroirs (C45PRO M7)
- Module fixe avec 5 tiroirs (C45PRO M5)
- 3 panneaux d'outils perforés (C45PRO PF)
- 2 supports muraux, de type large (C45PRO SL)
- 2 supports muraux, de type étroit (C45PRO SS)

158 kg

C45PRO BPX-2,0 **CHF** 3,140.00 1 045000042



C45PRO BPW-2,0

établis bois 2,0m pour la combinaison d'équipements d'atelier C45PRO

Combinaison comprenant:

- Plan de travail en bois multicouche (C45PW/3-2,0MT)
- Module fixe avec 7 tiroirs (C45PRO M7)
- Module fixe avec 5 tiroirs (C45PRO M5)
- 3 panneaux d'outils perforés (C45PRO PF)
- 2 supports muraux, de type large (C45PRO SL)
- 2 supports muraux, de type étroit (C45PRO SS)

156 kg

C45PRO BPW-2,0

CHF 2,980.00 1 045000052



C45PRO BPX-1,3

établis inox 1,3m pour la combinaison d'équipements d'atelier C45PRO

Combinaison comprenant:

- Plan de travail en MDF revêtu d'acier inoxydable (C45PX / 2-1.3MT)
- Module fixe avec 7 tiroirs (C45PRO M7)
- Module fixe avec 5 tiroirs (C45PRO M5)
- 2 panneaux d'outils perforés (C45PRO PF)
- 1 support mural, type large (C45PRO SL)
- 2 supports muraux, de type étroit (C45PRO SS)

140 kg

C45PRO BPX-1,3

CHF 2,780.00 1 045000041

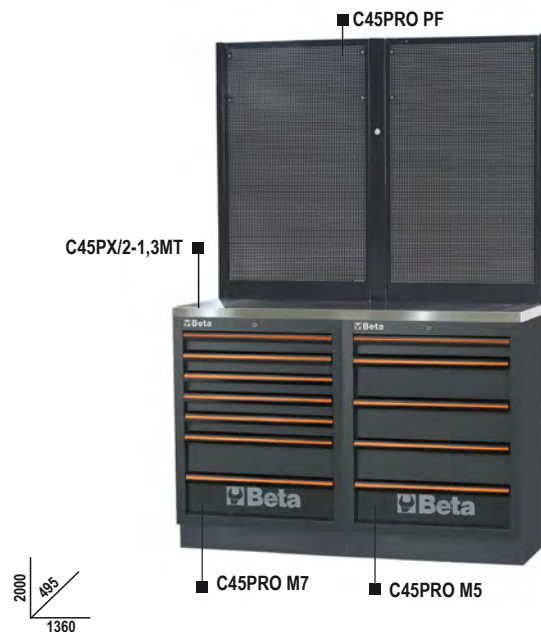

C45PRO BPW-1,3

établis bois 1,3m pour la combinaison d'équipements d'atelier C45PRO

Combinaison comprenant:

- Plan de travail en bois multicouche (C45PW/2-1.3MT)
- Module fixe avec 7 tiroirs (C45PRO M7)
- Module fixe avec 5 tiroirs (C45PRO M5)
- 2 panneaux d'outils perforés (C45PRO PF)
- 1 support mural, type large (C45PRO SL)
- 2 supports muraux, de type étroit (C45PRO SS)

139 kg

C45PRO BPW-1,3

CHF 2,630.00 1 045000051

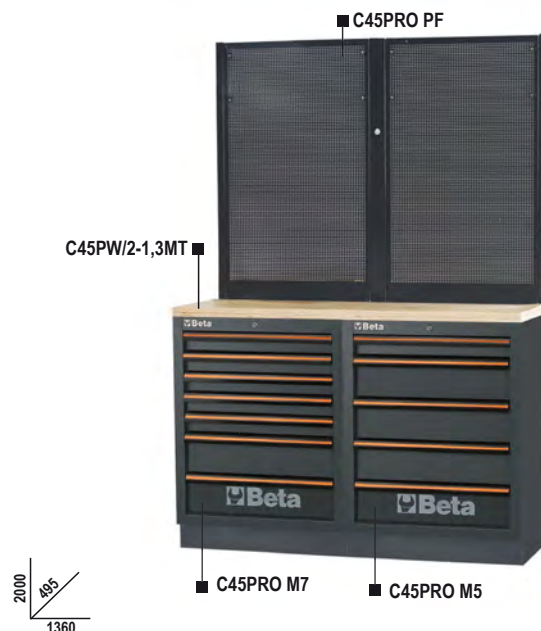

C45PRO M7A/X

Module fixe avec 7 tiroirs, pour l'ameublement d'atelier C45PRO

- Plan de travail (1360 mm) en MDF revêtu en acier inoxydable
- 1 tiroir (1248x406 mm d'une hauteur de 105mm) monté sur glissières à billes de précision.
- 6 tiroirs (782x406 mm) montés sur glissières à billes :
5 tiroirs d'une hauteur de 65 mm
1 tiroir d'une hauteur de 145 mm
- Fonds des tiroirs protégés par un tapis en néoprène
- Serrure centralisée frontale
- Avec pieds réglables en hauteur
- Peut être équipé de modules d'outillage BETA.
- 1 compartiment de rangement équipé d'une porte avec serrure et d'une étagère intermédiaire. Dimensions intérieures 504x424x597 mm
- Prédéposé pour l'installation d'un étau (1599P/150, vendu séparément)

📦 81 kg



h	max
65 mm	25 kg
105 mm	40 kg
145 mm	30 kg

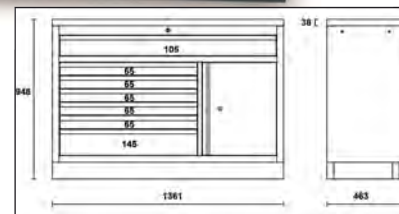

C45PRO M7A/X **CHF** 2,075.00 1 045000161

C45PRO M7A/W

Module fixe avec 7 tiroirs, pour l'ameublement d'atelier C45PRO

- Plan de travail (1360 mm) en bois contreplaqué stratifié.
- 1 tiroir (1248x406 mm d'une hauteur de 105mm) monté sur glissières à billes de précision.
- 6 tiroirs (782x406 mm) montés sur glissières à billes :
5 tiroirs d'une hauteur de 65 mm
1 tiroir d'une hauteur de 145 mm
- Fonds des tiroirs protégés par un tapis en néoprène
- Serrure centralisée frontale
- Avec pieds réglables en hauteur
- Peut être équipé de modules d'outillage BETA.
- 1 compartiment de rangement équipé d'une porte avec serrure et d'une étagère intermédiaire. Dimensions intérieures 504x424x597 mm
- Prédéposé pour l'installation d'un étau (1599P/150, vendu séparément)

📦 80 kg



h	max
65 mm	25 kg
105 mm	40 kg
145 mm	30 kg

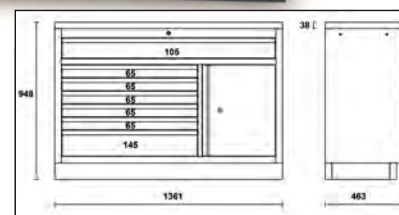

C45PRO M7A/W **CHF** 1,940.00 1 045000171

C45PRO MWS/X

Servante mobile Work Station avec 7 tiroirs et bac à déchets intégré

- Plan de travail (1680 mm) en MDF revêtu en acier inoxydable
- 1 tiroir (1248x406 mm et d'une hauteur de 105mm) montés sur glissières à billes de précision.
- 6 tiroirs (782x406 mm) montés sur glissières à billes de précision :
5 tiroirs d'une hauteur de 65 mm
1 tiroir d'une hauteur de 145 mm
- Fonds des tiroirs protégés par un tapis en néoprène.
- Peut être équipée de modules d'outillage BETA.
- 1 Compartiment de rangement équipé d'une porte avec serrure et d'une étagère intermédiaire, dimensions intérieures 504x424x597 mm
- Poubelle incorporée
- Compartiment à rouleaux de papier intégré
- 4 roulettes robustes grandes capacités Ø 150 mm, 2 fixes et 2 pivotantes avec freins
- Verrouillage centralisé frontale
- Prédéposé pour l'installation d'un étau (1599P/150, vendu séparément)

📦 126 kg



h	max
65 mm	25 kg
105 mm	40 kg
145 mm	30 kg

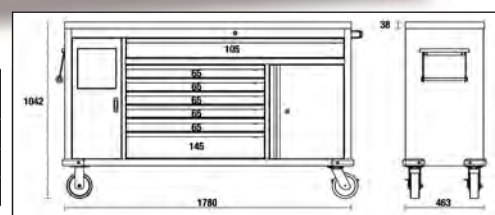

C45PRO MWS/X **CHF** 2,200.00 1 045000181

C45PRO MWS/W

Servante mobile Work Station avec 7 tiroirs et poubelle incorporée

- Plan de travail (1680 mm) en bois contreplaqué stratifié
- 1 tiroir (1248x406 mm et d'une hauteur de 105mm) montés sur glissières à billes de précision.
- 6 tiroirs (782x406 mm) montés sur glissières à billes de précision :
5 tiroirs d'une hauteur de 65 mm
1 tiroir d'une hauteur de 145 mm
- Fonds des tiroirs protégés par un tapis en néoprène.
- Peut être équipée de modules d'outillage BETA.
- 1 Compartiment de rangement équipé d'une porte avec serrure et d'une étagère intermédiaire, dimensions intérieures 504x424x597 mm
- Poubelle incorporée
- Compartiment à rouleaux de papier intégré
- 4 roulettes robustes grandes capacités Ø 150 mm, 2 fixes et 2 pivotantes avec freins
- Verrouillage centralisé frontale
- Prédéposé pour l'installation d'un étau (1599P/150, vendu séparément)

📦 122 kg

C45PRO MWS/W

CHF
2,145.00



1 045000191



h	max
65 mm	25 kg
105 mm	40 kg
145 mm	30 kg

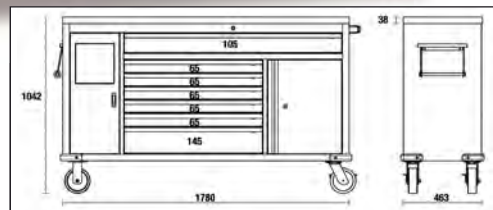

C45PRO CPF

Paire de panneaux à outils perforés pour servante mobile C45PRO MWS

Livré complet avec étrier et Kit GPS de 50 crochets inclus

📦 21 kg

C45PRO CPF

CHF
285.00



1 045000195



C45PX/1-0,7MT

Plan de travail en MDF revêtu en acier inoxydable de dimensions 680x463 mm, pour la combinaison d'ameublement d'atelier C45PRO

- Epaisseur : 38 mm
- Prédéposé pour l'installation d'un étau (1599P/150, vendu séparément)

📦 6 kg

C45PX/1-0,7MT

CHF
267.00



1 045000101



C45PW/1-0,7MT

Plan de travail en bois contreplaqué stratifié de dimensions 680x463 mm, pour la combinaison d'ameublement d'atelier C45PRO

- Epaisseur : 38 mm
- Prédéposé pour l'installation d'un étau (1599P/150, vendu séparément)

📦 6 kg

C45PW/1-0,7MT

CHF
157.50



1 045000111



C45PX/2-1,3MT

Plan de travail en MDF revêtu en acier inoxydable de dimensions 1360x463 mm, pour la combinaison d'ameublement d'atelier C45PRO

- Epaisseur : 38 mm
- Prêdisposé pour l'installation d'un étau (1599P/150, vendu séparément)

📦 21 kg

C45PX/2-1,3MT **CHF** 427.00 1 045000103



C45PW/2-1,3MT

Plan de travail en bois contreplaqué stratifié de dimensions 1360x463 mm, pour la combinaison d'ameublement d'atelier C45PRO

- Epaisseur : 38 mm
- Prêdisposé pour l'installation d'un étau (1599P/150, vendu séparément)

📦 20 kg

C45PW/2-1,3MT **CHF** 272.00 1 045000113



C45PX/3-2,0MT

Plan de travail en MDF revêtu en acier inoxydable de dimensions 2040x463 mm, pour la combinaison d'ameublement d'atelier C45PRO

- Epaisseur : 38 mm
- Prêdisposé pour l'installation d'un étau (1599P/150, vendu séparément)

📦 31,8 kg

C45PX/3-2,0MT **CHF** 572.00 1 045000110



C45PW/3-2,0MT

Plan de travail en bois contreplaqué stratifié de dimensions 2040x463 mm, pour la combinaison d'ameublement d'atelier C45PRO

- Epaisseur : 38 mm
- Prêdisposé pour l'installation d'un étau (1599P/150, vendu séparément)

📦 30 kg

C45PW/3-2,0MT **CHF** 408.00 1 045000120



C45PRO C5

Servante mobile avec 5 tiroirs, pour la combinaison d'équipements d'atelier C45PRO

- 5 tiroirs (532x406 mm) avec glissières à roulement à billes
- 4 roulettes directionnelles, Ø 100 mm (une avec frein)
- Bases de tiroirs protégées par des tapis en caoutchouc moussé
- Serrure centralisée à l'avant
- Peut être équipée de plateaux thermoformés
- Poignées intégrées dans le cadre pour une meilleure facilité de manipulation

📦 46 kg

C45PRO C5 **CHF** 997.00 1 045000225

h	max
65 mm	25 kg
145 mm	30 kg

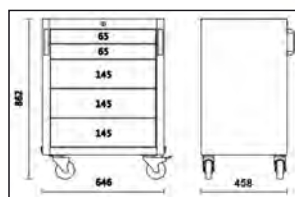
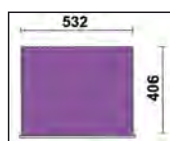

C45PRO C7

servante mobile avec 7 tiroirs, pour la combinaison d'équipements d'atelier C45PRO

- 7 tiroirs (532x406 mm) avec glissières à roulement à billes
- 4 volants, Ø 100 mm (1 avec frein)
- Bases de tiroirs protégées par des tapis en caoutchouc moussé
- Serrure centralisée avant
- Peut être équipé de plateaux thermoformés
- Poignées intégrées dans le cadre pour une meilleure facilité de manipulation

📦 50 kg

h	max
65 mm	25 kg
145 mm	30 kg

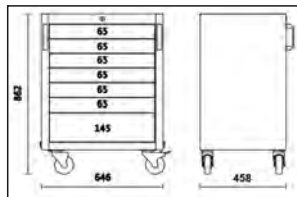
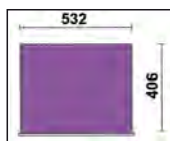

C45PRO C7

CHF 1,044.00 1 045000227

C45PRO M4

module fixe avec 4 tiroirs, pour la combinaison d'équipements d'atelier C45PRO

- 4 tiroirs (566x406 mm) avec glissières à roulement à billes
- Bases de tiroirs protégées par des tapis en caoutchouc moussé
- Serrure centralisée avant
- Avec pieds réglables verticalement
- Peut être équipé de plateaux thermoformés

📦 45,7 kg

h	max
65 mm	25 kg
145 mm	30 kg
225 mm	30 kg

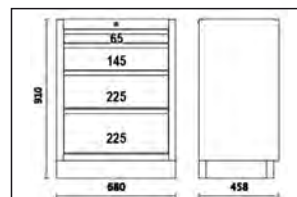
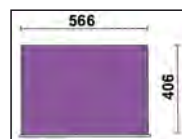

C45PRO M4

CHF 856.00 1 045000234

C45PRO M5

module fixe avec 5 tiroirs, pour la combinaison d'équipements d'atelier C45PRO

- 5 tiroirs (566x406 mm) avec glissières à roulement à billes
- Bases de tiroirs protégées par des tapis en caoutchouc moussé
- Serrure centralisée avant
- Avec pieds réglables verticalement
- Peut être équipé de plateaux thermoformés

📦 49,3 kg

h	max
65 mm	25 kg
145 mm	30 kg

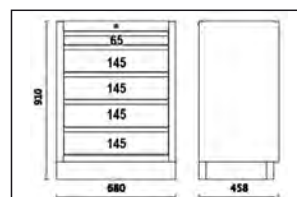
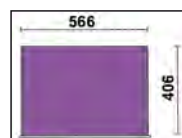

C45PRO M5

CHF 905.00 1 045000235

C45PRO M7

module fixe avec 7 tiroirs, pour la combinaison d'équipements d'atelier C45PRO

- 7 tiroirs (566x406 mm) avec glissières à roulement à billes
- Bases de tiroirs protégées par des tapis en caoutchouc moussé
- Serrure centralisée avant
- Avec pieds réglables verticalement
- Peut être équipé de plateaux thermoformés

📦 54,3 kg

h	max
65 mm	25 kg
145 mm	30 kg

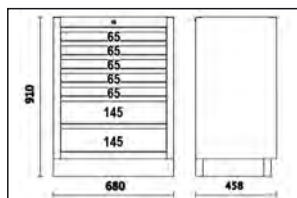
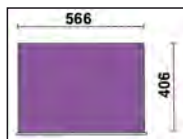

C45PRO M7 **CHF** 1,004.00 1 045000237

C45PRO M8

Module fixe avec 8 tiroirs, pour la combinaison d'équipements d'atelier C45PRO

- 8 tiroirs (566x406 mm) avec glissières à roulement à billes
- Bases de tiroirs protégées par des tapis en caoutchouc moussé
- Serrure centralisée à l'avant
- Avec pieds réglables verticalement
- Peut être équipé de plateaux thermoformés

📦 56,5 kg

h	max
65 mm	25 kg
145 mm	30 kg

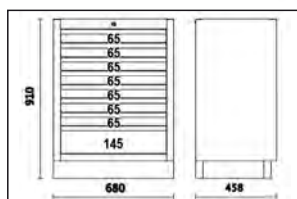
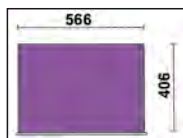

C45PRO M8 **CHF** 1,092.00 1 045000238

C45PRO MS

module fixe de propreté pour la combinaison d'équipements d'atelier C45PRO

- Bac à déchets intégré
- Compartiment rouleau de papier
- Avec pieds réglables verticalement

📦 37 kg

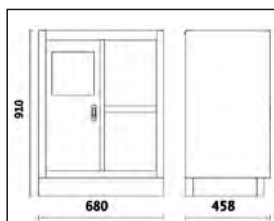

C45PRO MS **CHF** 683.00 1 045000239

C45PRO RD/X

Module fixe de collecte sélective des déchets pour la combinaison d'équipements d'atelier C45PRO

La solution idéale pour la collecte sélective des déchets (verre, papier, plastique...)

- Structure en tôle solide complète avec 4 conteneurs à porte basculante pour collecter les déchets séparément
- Chaque conteneur est équipé de :
 - un panier en plastique amovible, capacité 25 litres
- 4 roues pivotantes Ø 60 mm
- Kit de 4 autocollants colorés inclus dans le packaging
- Équipé de pieds réglables verticalement

80 kg

C45PRO RD/X	CHF	2,110.00	1	045000241
C45PRO RD/W	CHF	1,970.00	1	045000240



C45PRO RD/X



C45PRO RD/W

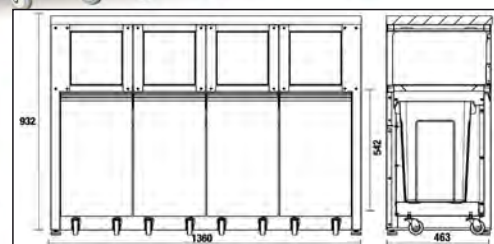

C45PRO MA

module fixe à deux portes pour la combinaison d'équipements d'atelier C45PRO

- Avec serrure
- Étagère intérieure réglable verticalement
- Dimensions intérieures 670x420 mm
- Avec pieds réglables verticalement

29,4 kg

C45PRO MA	CHF	507.00	1	045000232
-----------	-----	--------	---	-----------

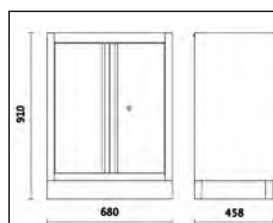

C45PRO MAL

Module fixe 2 portes coulissantes d'une longueur de 1360 mm, pour combinaison d'ameublement d'atelier C45PRO

- Avec serrure de sécurité
- Tablette réglable en hauteur
- Dimensions intérieures : 670x420 mm
- Pieds réglables en hauteur

44,8 kg

C45PRO MAL	CHF	893.00	1	045000229
------------	-----	--------	---	-----------

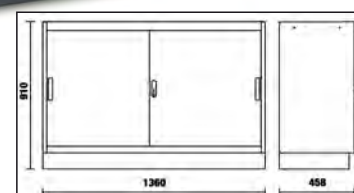

C45PRO MAT

Module fixe 2 portes coulissantes transparentes en polycarbonate d'une longueur de 1360 mm, pour combinaison d'ameublement d'atelier C45PRO

- Avec serrure de sécurité
- Tablette réglable en hauteur
- Dimensions intérieures : 670x420 mm
- Avec pieds réglables en hauteur

📦 44,1 kg

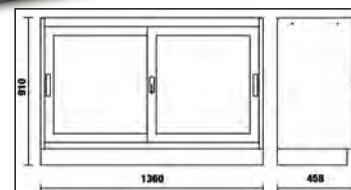

CHF

980.00



1



045000230

C45PRO MAT

C45PRO M3A

Module fixe avec 3 tiroirs et 2 portes pour la combinaison d'équipements d'atelier C45PRO

- 3 tiroirs (566x406 mm) avec glissières à roulement à billes
- Bases de tiroirs protégées par des tapis en caoutchouc moussé
- Peut être équipé de plateaux thermoformés
- Serrure centralisée à l'avant
- Compartiment de rangement avec double porte et serrure (dimensions intérieures 670x440 mm), avec étagère intermédiaire
- Avec pieds réglables verticalement

📦 44 kg

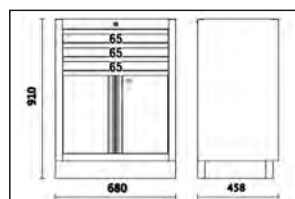
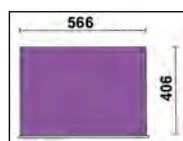

CHF

875.00



1



045000231

C45PRO M3A

C45PRO ML

module fixe avec évier intégré, pour la combinaison d'équipements d'atelier C45PRO

Caractéristiques techniques :

- Bassin en acier inoxydable.
- Livré complet avec: 1 mitigeur 1 unité de vidange 1 bouchon d'évier 1 bouchon filtrant 1 distributeur de savon Module fixe à deux portes avec serrure:
- Dimensions intérieures utiles 600x603x416 mm
- Avec pieds réglables verticalement

📦 44 kg

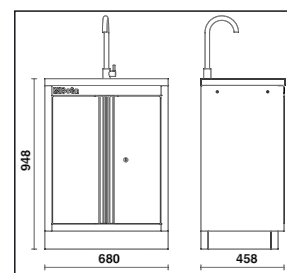

CHF

1,375.00



1



045000233

C45PRO ML

C45PRO ACT

module fixe avec 3 tiroirs et 2 bobines intégrées pour la combinaison d'équipements d'atelier C45PRO

- 3 tiroirs (566x406 mm) avec glissières à roulement à billes
- Bases de tiroirs protégées par des tapis en caoutchouc moussé
- Serrure centralisée avant
- Avec pieds réglables verticalement Livré complet avec:
 - 1 enrouleur de tuyau d'air comprimé ou d'eau froide intégré, Ø 8 mm, longueur 10 m, article 1900S 8x10
 - 1 enrouleur de câble électrique intégré, longueur 15 m, article 1844 15-H05

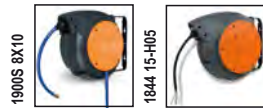

h	max
65 mm	25 kg
145 mm	30 kg

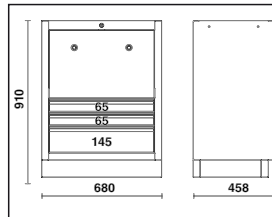
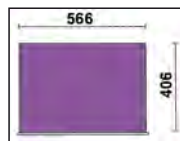

47 kg

C45PRO ACT

CHF 1,300.00 1 045000247

C45PRO TC

Module enrouleur fixe avec 3 tiroirs pour la combinaison d'équipements d'atelier C45PRO, vide

- 3 tiroirs (566x406 mm) avec glissières à roulement à billes
- Bases de tiroirs protégées par des tapis en caoutchouc moussé
- Serrure centralisée à l'avant
- Avec pieds réglables verticalement
- Peut accueillir 2 rouleaux, à choisir parmi les suivants :
 - 2 enrouleurs de tuyaux d'air comprimé ou d'eau froide, Ø 8 mm, longueur 10 m art. 1900S 8x10
 - 2 enrouleurs de câbles électriques, à choisir parmi les suivants : 1843 15-H05, 1844 10-H05, 1844 15-H05, 1844 15-H07, 1845 12-H05, 1846 10-H05, 1846 10-H07 et 1846 15-H05
 - 1 enrouleur de tuyau d'air comprimé ou d'eau froide, Ø 8 mm, longueur 10m art. 1900S 8x10 et 1 enrouleur de câbles électriques à choisir parmi les articles listés ci-dessus

h	max
65 mm	25 kg
145 mm	30 kg

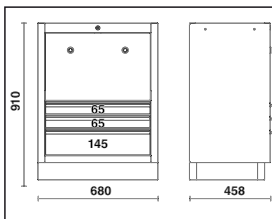
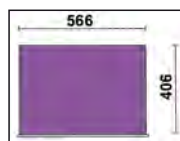

38 kg

C45PRO TC

CHF 796.00 1 045000249

C45PRO T3

Chariot avec 3 étagères, pour la combinaison d'équipements d'atelier C45PRO

- Double possibilité de fixation du plateau central
- Quatre roulettes directionnelles, Ø 100 mm (un avec freins)
- Capacité de charge statique : 200 kg (repartie sur les 3 étagères)

19,2 kg

C45PRO T3

CHF 397.00 1 045000250

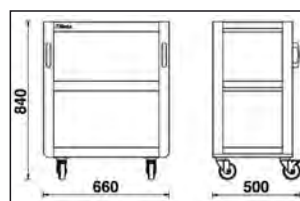

C45PRO SS

supports muraux latéraux, de type étroit, pour la combinaison d'équipements d'atelier C45PRO

- Dimensions 1420x32.5x30 mm

📦 1,5 kg



C45PRO SS

CHF 38.50 1 045000333

C45PRO SL

supports muraux latéraux, de type large, pour la combinaison d'équipements d'atelier C45PRO

- Dimensions 1420x65x30 mm

📦 2 kg



C45PRO SL

CHF 51.50 1 045000366

C45PRO PAS

Paroi porte-outils, pour la combinaison d'équipements d'atelier C45PRO

- Volet roulant en aluminium à mouvement vertical avec serrure
- Deux panneaux d'outils perforés amovibles
- Possibilité d'assortiment à le plan de travail de 1,3 mètres

📦 48,8 kg

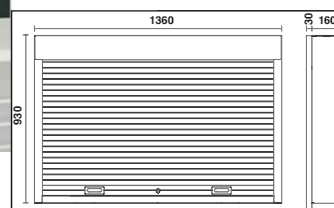

C45PRO PAS

CHF 1,285.00 1 045000290

C45PRO PF

panneau d'outils perforé pour la combinaison d'équipements d'atelier C45PRO

- Dimensions 1052x614.5x24 mm

📦 5,3 kg



C45PRO PF

CHF 159.50 1 045000313

C45PRO PFE

panneau d'outils perforé pour la combinaison d'équipements d'atelier C45PRO

Dimensions 1052x614,5x24 mm

• Peut être équipé d'une prise de courant (non incluse)

5,3 kg



C45PRO PFE

CHF 151.00 1 045000312

C45PRO MP

Etagère métallique pouvant être fixée aux panneaux porte-outils perforés de la combinaison d'ameublement d'atelier C45PRO

Dimensions: 614x160x80 mm

1,8 kg



C45PRO MP

CHF 68.00 1 045000315

C45PRO CORNER/X

Angle complet autoportant pour la combinaison d'équipements d'atelier C45PRO

- Armoire d'angle suspendue avec ressorts à gaz, facilitant l'ouverture et la fermeture de la porte
- 2 panneaux d'outils perforés (1052x860)
- Plan de travail d'angle en acier inoxydable (860x860 mm)
- Module d'angle inférieur avec grand compartiment de rangement
- Avec pieds réglables verticalement

94 kg



C45PRO CORNER/X

CHF 2,600.00 1 045000401

Beta

C45PRO CORNER/W

angle complet autoportant pour la combinaison d'équipements d'atelier C45PRO

- Armoire d'angle suspendue avec serrure et ressorts à gaz, facilitant l'ouverture et la fermeture de la porte
- 2 panneaux d'outils perforés (1052x860 mm)
- Plan de travail d'angle en bois multicouche (860x860 mm)
- Module d'angle inférieur avec grand compartiment de rangement
- Avec pieds réglables verticalement

📦 93 kg

C45PRO CORNER/W **CHF** 2,500.00 1 045000411

C45PRO CAI/X

Module d'angle inférieur, pour la combinaison d'équipements d'atelier C45PRO

- Plan de travail d'angle en MDF revêtu d'acier inoxydable (860x860 mm)
- Module fixe d'angle avec grand compartiment de rangement
- Avec pieds réglables verticalement

📦 62 kg

C45PRO CAI/X **CHF** 1,425.00 1 045000412

C45PRO CAI/W

Module d'angle inférieur, pour la combinaison d'équipements d'atelier C45PRO

- Plan de travail d'angle en bois multicouche (860x860 mm)
- Module fixe d'angle avec grand compartiment de rangement
- Avec pieds réglables verticalement

📦 56 kg

C45PRO CAI/W **CHF** 1,335.00 1 045000402

C45PRO PM

Armoire murale pour la combinaison d'équipements d'atelier C45PRO

- Longueur armoire murale 680 mm
- Avec ressorts à gaz, facilitant l'ouverture et la fermeture de la porte
- Avec serrure

📦 10 kg

C45PRO PM **CHF** 293.00 1 045000302

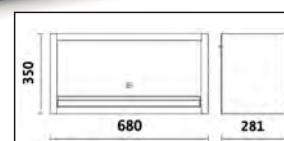

SSPE

Support positionnable sous les meubles hauts muraux pour le rangement des outils électroportatifs.

- Utilisable uniquement sous les meubles hauts muraux C45PRO PM (de l'ameublement d'atelier C45PRO)
- Equipé de 5 emplacements pour le rangement de l'outillage Electroportatif.
- Dimensions : 680 x 280 x 150 mm

📦 5,4 kg



SSPE

CHF 122.50 1 088880482

C45PRO PML

Armoire murale longue, pour la combinaison d'équipements d'atelier C45PRO

- Longueur armoire murale : 1360 mm
- Avec ressorts à gaz, facilitant l'ouverture et la fermeture de la porte
- Avec serrure

📦 18 kg

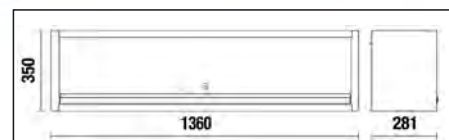

C45PRO PML

CHF 525.00 1 045000303

C45PRO AS1

Armoire à outils métallique à 1 porte avec étrier pour l'ameublement d'atelier C45PRO

- 4 étagères amovibles et réglables en hauteur
- Tringle à vêtements intégrée sous la première étagère
- Avec serrure de sécurité
- Dimensions intérieures : 590x430 mm
- Pieds réglables en hauteur

📦 57,5 kg

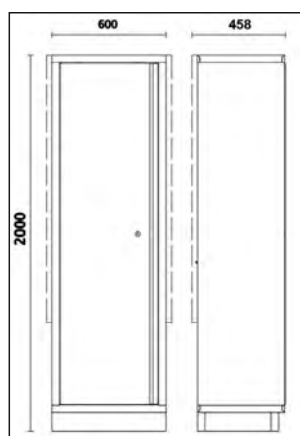

C45PRO AS1

CHF 1,043.00 1 045000451

C45PRO A1/R600

Etagère intérieure pour armoire C45PRO AS1

📦 2,5 kg



C45PRO A1/R600

CHF 63.00 1 045000466

C45PRO A1/RB600

Etagère intérieure munie d'une tringle à vêtements pour armoire C45PRO AS1

📦 2,6 kg



CHF 73.00 1 045000467

C45PRO A1/RB600

C45PRO AS2

armoire à outils en tôle à deux portes avec support, pour la combinaison d'équipements d'atelier C45PRO

- 4 étagères amovibles et réglables verticalement
- Avec serrure
- Dimensions intérieures 590x430 mm
- Avec pieds réglables verticalement

📦 80 kg

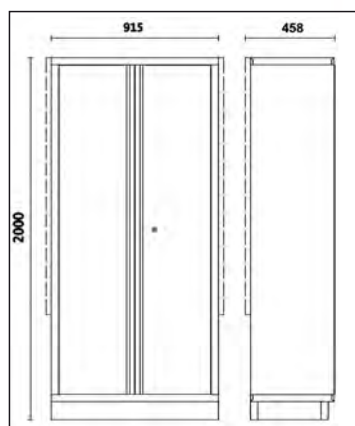

CHF 1,385.00 1 045000481

C45PRO AS2

C45PRO A2/R915

Etagère intérieure pour armoire C45PRO AS2

📦 3,7 kg



CHF 78.50 1 045000496

C45PROA2/R915

C45STR

Ruban adhésif coloré, pour la combinaison d'équipements d'atelier C45PRO

- Permet de personnaliser la couleur des embouts horizontaux et verticaux de la combinaison d'équipements d'atelier C45PRO



RAL2011
RAL9006
RAL3000
RAL5015
RAL1023
RAL6029

	L m	CHF		
C45STR-O/2011	30	82.00	1	045000911
C45STR-G/9006	25	74.50	1	045000912
C45STR-R/3000	25	74.50	1	045000913
C45STR-B/5015	25	74.50	1	045000914
C45STR-Y/1023	25	74.50	1	045000915
C45STR-V/6029	25	74.50	1	045000916

ACCESSORIES RSC55 - RSC50 - C45PRO

		5000 RSC50/PLED-ST	5000 RSC50/PLED	5000 RSC50/ASL	5000 RSC50/CTR
	A	1x	-	1x	-
	B	-	1x	1x	1x
	A	1x	1x	1x	-
	B	-	2x	1x	1x
	A	1x	2x	1x	-
	B	-	3x	1x	1x

5000 RSC50/PLED

Profilé en aluminium avec bande LED, pour combinaison d'ameublement d'atelier RSC50

À installer sous les plans de travail, les meubles hauts muraux, les étagères et les éléments d'angle afin éclairer les zones de travail. Caractéristiques:

- Bande LED IP20 6.5 W d'une longueur de 50cm
- Livré complet avec 2 câbles (d'une longueur de 40 cm et de 170 cm)
- Fixation magnétique pratique



80 g

5000 RSC50/PLED CHF 46.50 1 050001714

5000 RSC50/PLED-ST

Profilé en aluminium avec bande LED et interrupteur SOFT TOUCH, pour combinaison d'ameublement d'atelier RSC50

À installer sous les plans de travail, les meubles hauts muraux, les étagères et les éléments d'angle afin éclairer les zones de travail.

Caractéristiques:

- Bande LED IP20 6.5 W d'une longueur de 50cm
- Livré complet avec 2 câbles (d'une longueur de 40 cm et de 170 cm)
- Fixation magnétique pratique



80 g

5000 RSC50/PLED-ST CHF 51.50 1 050001715

5000 RSC50/ASL

Alimentation pour ruban LED pour la combinaison d'ameublement d'atelier RSC50

Caractéristiques :

- Alimentation 24VDC 22W
- Peut alimenter jusqu'à 3 rubans LED de 6.5 W

200 g



5000 RSC50/ASL CHF 40.50 1 050001716

5000 RSC50/CTR

Télécommande RF (Radiofréquence) permettant le contrôle de la bande LED pour la combinaison d'ameublement d'atelier RSC50

À utiliser uniquement avec la bande LED article 5000 RSC50/PLED

Contenu du kit :

- 1 mini récepteur
- 1 télécommande RF (Radiofréquence) sans fil

Spécifications du mini récepteur :

- Tension d'entrée : 5V -24VDC
- Courant de sortie nominal : 5 A
- Courant de sortie de crête : 12 A
- Température de fonctionnement : -20 à +35 °C

Spécifications de la télécommande RF :

- Bouton marche/arrêt
- Bouton INTENSITÉ +/- : permet le réglage manuel de la puissance d'éclairage
- Bouton 25%/50%/100% : permet le réglage automatique de la puissance d'éclairage
- Pile : 3V CR2025 (incluse)
- Dimensions : 86x40x7 mm

Fonctionnalités intégrées :

- Mémoire
- Mode (luminosité manuelle/automatique)
- Réglage de la luminosité



📦 20 g

5000 RSC50/CTR **CHF** 20.10 1 050001721

CPMB/3C

Bacs de rangement pour établi avec 3 tiroirs

- Structure externe en PP
- Tiroirs avec bacs de rangement en PET
- Empilables

Caractéristiques techniques des tiroirs :

- Dimension interne du tiroir 160x107x105h mm
- Incassable
- Transparence effet verre inchangée dans le temps
- Anti-rayures
- Résistant aux huiles, acides et agents chimiques agressifs
- Convient également pour une utilisation dans des environnements alimentaires



📦 2 kg

CPMB/3C **CHF** 66.50 1 088880443

KIT 6VC/3C

Kit de 6 plateaux amovibles pour bacs de rangement CPMB/3C pour petites pièces

📦 1,1 kg



6x



KIT 6VC/3C **CHF** 36.50 1 088880453

CPMB/5C

Bacs de rangement pour établi avec 5 tiroirs

- Structure externe en PP
- Tiroirs avec bacs de rangement en PET
- Empilables

Caractéristiques techniques des tiroirs :

- Dimension interne du tiroir 90x86x62h mm
- Incassable
- Transparence effet verre inchangée dans le temps
- Anti-rayures
- Résistant aux huiles, acides et agents chimiques agressifs
- Convient également pour une utilisation dans des environnements alimentaires

📦 1,5 kg



CPMB/5C

CHF 79.50 1 088880445

KIT 10VC/5C

Kit de 10 plateaux amovibles pour bacs de rangement CPMB/5C pour petites pièces

📦 800 g



10x



KIT 10VC/5C

CHF 34.00 1 088880455

PM/5C

5 bacs de rangements muraux en matière plastique avec support

- Dimensions internes du bac de rangement : 95x120 mm
- Adaptable sur les panneaux porte-outils perforés C45PRO et RSC55

📦 1,8 kg



PM/5C

CHF 139.50 1 088880450

PM/6C

6 bacs de rangements muraux en matière plastique avec support

- Dimensions internes du bac de rangement : 80x60 mm
- Adaptable sur les panneaux porte-outils perforés C45PRO et RSC55

📦 970 g



PM/6C

CHF 107.00 1 088880440

CP

Panier mural porte-flacons en acier

- Adaptable aux panneaux muraux porte-outils

📦 530 g

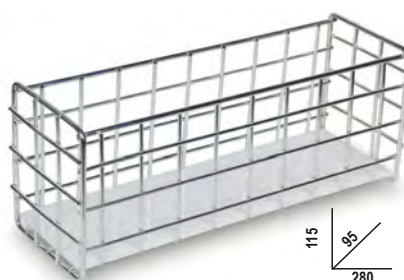

CP

CHF 135.00 1 088880470

SPC

support mural d'ordinateur

- Correspond aux systèmes muraux d'outils RSC55 et C45PRO
- Dimensions 398x243x138 mm

1,5 kg



SPC

CHF 109.00 1 088880480

SP5S

Support mural comprenant 5 compartiments de rangement

- Métallique
- 5 compartiments d hauteurs variables
- Dimensions : 260x60x290 mm

1 kg



SP5S

CHF 135.00 1 088880475



SERVANTES MOBILES D'ATELIER ET COFFRES

OUTILS EN VRAC

MODULES

		pièces		RSC22	RSC23	RSC23C	RSC23T	RSC24/5	RSC24/6	RSC24/7	RSC24A/7	RSC24/8	RSC24A/8	RSC24AXL/9	C25	C27S	RSC28	C30M			
									RSC24A/6	RSC24AXL/7	RSC24L/7	RSC24AXL/8	C39/8								
									C37/6	C39/6	RSC24AXLP/7	RSC24L-CAB	C37/7	C37A/7	C39/7						
sans supports	5902MT	Chantier et agricoles	106	518	518	518															
	5902MT/AS	Chantier et agricoles	99	519	519	519															
	5902VI	Industrie	107	481	481		481								481	481					
	5904VG/3	Automobile	132					522	522	522	522										
	5905VG/1	Automobile	94												525						
	5905VG/2	Automobile	118												526						
	5910VI/3	Industrie	297																	485	
	5954VG	Automobile	138																		
	5954VI	Industrie	133																		
	5957U-P	Maintenance générale	133																		
5957VG	Automobile	174																			
5957VI	Industrie	162																			
5958U	Maintenance générale	85																			
modules soft spécifiques	5904VG/2M	Automobile	170				520	520	520	520	520	520	520	520					520		
	5904VU/1M	Maintenance générale	90				490	490	490	490	490	490	490	490					490		
	5904VU/2M	Maintenance générale	144				491	491	491	491	491	491	491	491					491		
	5927VU/M	Maintenance générale	108	501	501	501													501		
	5935ET/1MB	Microtechnique	96																		
	5935VG/1MB	Automobile	98																		
	5935VI/2MB	Industrie	133																		
	5945VUM	Maintenance générale	231																		
	5988H/7M	Automobile	333										508	508					508		
	5988L/4M	Automobile	273						509	509	509	509	509	509							
	5980U/BIKE-M	Réparation vélos	106										507	507					507		
	5988U6/M	Maintenance générale	214									510	510	510					510		
	5988U/7M	Maintenance générale	215				497	497	497	497	497	497	497	497					497		
	5988VHB-MQ	Microtechnique	66				514	514	514	514	514	514	514	514					514		
	5989 VEM	Automobile	66				517	517	517	517	517	517	517	517					517		
	plateaux thermoformés	5904VI/1T	Industrie	98				481	481	481	481	481	481	481					481		
		5904VI/2T	Industrie	153				482			482	482	482	482					482		
5904VI/3T		Industrie	142										483	483					483		
5904VG/2T		Automobile	99				521	521	521	521	521	521	521	521					521		
5904VG/3T		Automobile	102				523	523	523	523	523	523	523	523					523		
5904VG/5T		Automobile	153				524		524	524	524	524	524	524					524		
5904VU/2T		Maintenance générale	104				492	492	492	492	492	492	492	492					492		
5904VU/3T		Maintenance générale	146				493	493	493	493	493	493	493	493					493		
5904VU/4T		Maintenance générale	197				494	494	494	494	494	494	494	494							
5908VG/2T		Automobile	214																	527	
5908VI/2T		Industrie	232										484	484					484		
5908VU/2T		Maintenance générale	161				495		495	495	495	495	495	495					495		
5910VI/3T		Industrie	261																	486	
5938U/2T		Maintenance générale	210																		

SERVANTES MOBILES D'ATELIER ET COFFRES

OUTILS EN VRAC

MODULES

			pieces													
			C35	C38	C39MD C39SM	C39T	C45PRO	RSC51	C54S RSC55C	RSC55	RSC55PS RSC55PSE	RSC50	C57SA C57SB C57SD C57SP	C58P C45PRO PAS	C59A C59C	C59B
sans supports	5902MT	Chantier et agricoles	106			518										
	5902MT/AS	Chantier et agricoles	99			519										
	5902VI	Industrie	107													
	5904VG/3	Automobile	132							522		522			522	522
	5905VG/1	Automobile	94													
	5905VG/2	Automobile	118													
avec supports	5954VG	Automobile	138						531							
	5954VI	Industrie	133						489	489						
	5957U-P	Maintenance générale	133								503	503	503			
	5957VG	Automobile	174								532		532			
	5957VI	Industrie	162										488			
	5958U	Maintenance générale	85				504			504	504			504		
modules soft spécifiques	5904VG/2M	Automobile	170		520	520				520					520	520
	5904VU/1M	Maintenance générale	90		490	490		490		490					490	490
	5904VU/2M	Maintenance générale	144		491	491				491					491	491
	5927VU/M	Maintenance générale	108													
	5935ET/1MB	Microtechnique	96	511												
	5935VG/1MB	Automobile	98	528												
	5935VI/2MB	Industrie	133	487												
	5945VUM	Maintenance générale	231		530		530									
	5988H/7M	Automobile	333							508						469
	5988L/4M	Automobile	273		470	470				470					470	470
	5980U/BIKE-M	Réparation vélos	106													
	5988U6/M	Maintenance générale	214		510					510						510
	5988U/7M	Maintenance générale	215		497					497					497	497
	5988VHB-MQ	Microtechnique	66		514	514		514		514					514	514
5989 VEM	Automobile	66														
plateaux thermoformés	5904VI/1T	Industrie	98		481	481		481		481					481	481
	5904VI/2T	Industrie	153		482					482					482	482
	5904VI/3T	Industrie	142		483					483						483
	5904VG/2T	Automobile	99		521	521		521		521					521	521
	5904VG/3T	Automobile	102		523	523				523					523	523
	5904VG/5T	Automobile	153		524					524					524	524
	5904VU/2T	Maintenance générale	104		492	492				492					492	492
	5904VU/3T	Maintenance générale	146		493	493				493					493	493
	5904VU/4T	Maintenance générale	197		494	494				494					494	494
	5908VG/2T	Automobile	214													
	5908VI/2T	Industrie	232													484
	5908VU/2T	Maintenance générale	161		495					495					495	495
	5910VI/3T	Industrie	261													
	5938U/2T	Maintenance générale	210		502											

5902VI

Composition de 107 outils

► Maintenance industrielle

Quantité/Description

6	chasse-goupilles Ø 2 - 3 - 4 - 5 - 6 - 8 mm	Réf. Beta	31
1	pointeau Ø 3 mm		32
1	burins nervurés 200 mm		35
26	clé mixte 6÷32 mm		42/S26
12	clés à fourches 6x7 - 8x9 - 10x11 - 12x13 - 14x15 - 16x17 - 18x19 - 20x22 - 21x23 - 24x26 - 25x28 - 30x32 mm		55/S12
9	clés mâles 6 pans coudées Ø 1,5 - 2 - 2,5 - 3 - 4 - 5 - 6 - 8 - 10 mm		96N/SC9
1	Clé à molette à ouverture graduée, chromée 300 mm		111E
13	douilles 6 pans 1/2" sur rail Ø 10÷22 mm		920A/SB13
1	rallonge - 1/2" 125 mm		920/21
1	rallonge - 1/2" 255 mm		920/22
1	cardan 1/2"		920/25
1	poignée coulissante 1/2"		920/42
1	cliquet réversible 1/2" ®		920/55
1	Pince multiprise entrepassée 250 mm		1048N
1	pince - étau à becs droits 240 mm		1052
1	pince coupante diagonale à faible effort de coupe, branchées gainées confort bi-matières, finition industrielle 160 mm		1084GBM
1	cisaille bichantourneuse coupe droite 250 mm		1122
1	ciseaux d'électricien		1128BMX
1	pince universelle, branches gainées confort bi-matières, modèle grande capacité, finition industrielle 180 mm		1150GBM
1	pince à becs demi-ronds longs striés, branches gainées confort bi-matières, finition industrielle 160 mm		1166GBM
8	tournevis pour vis à fente 2,5x50 - 3x75 - 3,5x100 - 4x125 - 5,5x125 - 6,5x150 - 8x200 - 10x200 mm		1260
4	tournevis pour vis Phillips® PH0x60 - PH1x80 - PH2x100 - PH3x150 mm		1262
1	marteau de mécanicien 500 g		1370
1	massette sans rebond Ø 40 mm		1392
1	pointe à tracer en carbure		1688A
1	mètre à ruban 5 m		1692
1	jauge d'épaisseur		1708/20
5	limes demi-douces 200 mm		1719BMA...S5
1	monture de scie à métaux		1726BM
1	Burette tôle 300 cc		1751N
1	cutter à lame sécable 18 mm avec lames		1771BM
1	lampe magnétique articulée à LEDs haute luminosité, en aluminium anodisé renforcé, jusqu'à 500 Lumens		1837F



CHF



5902VI 2,150.00 059021060

Composition conseillée avec RSC22 - RSC23 - RSC23T - C25 - C27S

5904VI/1T

Composition de 98 outils en plateaux thermoformés rigides en ABS

► Maintenance industrielle

Quantité/Description

19	douilles 6 pans avec carré conducteur femelle 1/2" Ø 10÷24 - 26 - 27 - 30 - 32 mm	Réf. Beta	TR
5	douilles tournevis pour vis 6 pans creux carré femelle 1/2" Ø 5 - 6 - 8 - 10 - 12 mm	920A	T80
1	rallonge - 1/2" 125 mm	920ME	T80
1	rallonge - 1/2" 255 mm	920/21	T80
1	cardan 1/2"	920/22	T80
1	poignée coulissante 1/2"	920/25	T80
1	cliquet réversible 1/2" ®	920/42	T80
16	clés mixtes 6÷21 mm	920/55	T80
5	clés mixtes 22-24-27-30-32 mm	42	T05
1	Pince multiprise entrepassée 250 mm	42	T06
1	pince - étau à becs droits 240 mm	1048N	T153
1	Pince coupante diagonale à faible effort de coupe 160 mm	1052	T153
1	pince à becs demi-ronds longs 180 mm	1084	T138
1	Pince à becs demi-ronds longs 160 mm	1150	T138
1	pincettes pour circlips intérieurs à becs droits 180 mm	1166	T138
1	pincettes pour circlips intérieurs à becs coudés 170 mm	1032	T145
1	pincettes pour circlips extérieurs à becs droits 175 mm	1034	T145
1	pincettes pour circlips extérieurs à becs coudés 175 mm	1036	T145
2	burins nervurés 100 - 200 mm	1038	T145
5	limes demi-douces 200 mm	35	T234
1	marteau de mécanicien 300 g	1719BMA8/S5	T236
1	maillet à embouts nylon, manche en bois Ø 35 mm	1370	T234
8	clés à fourches 6x7 - 8x9 - 10x11 - 12x13 - 14x15 - 16x17 - 18x19 - 20x22 mm	1390	T234
9	clés mâles 6 pans coudées Ø 1,5 - 2 - 2,5 - 3 - 4 - 5 - 6 - 8 - 10 mm	55	T33
4	tournevis pour vis à fente 3x75 - 4x100 - 5,5x150 - 6,5x150 mm	96/SC9	T33
3	tournevis pour vis Phillips® PH0x60 - PH1x80 - PH2x100 mm	1260	T208
6	clés mâles 6 pans en T 2,5 - 3 - 4 - 5 - 6 - 8 mm	1262	T208
		951	T68



T80 T05 T06



T153 T138 T145 T236



T234 T33 T208 T68

CHF



5904VI/1T 1,955.00 059041161

Composition conseillée avec RSC24 - RSC24A - RSC24AXL - C37 - C39 à 6 - 7 - 8 tiroirs
RSC23T - C39T - RSC24L - RSC24L-CAB - C59 - C55 - RSC28 - C39MD - C39SM

5904VI/2T

Composition de 153 outils en plateaux thermoformés rigides en ABS

► Maintenance industrielle

Quantité/Description

- 16 clés mixtes 6÷21 mm
- 5 clés mixtes 22 - 24 - 27 - 30 - 32 mm
- 5 chasse-goupilles Ø 2 - 3 - 4 - 5 - 6 mm
- 1 pointeau Ø 4 mm
- 12 clés à fourches 6x7 - 8x9 - 10x11 - 12x13 - 14x15 - 16x17
18x19 - 20x22 - 21x23 - 24x26 - 27x29 - 30x32 mm
- 9 clés mâles 6 pans coudées \odot 1,5 - 2 - 2,5 - 3 - 4 - 5 - 6 - 8 - 10 mm
- 7 clés polygonales contre - coudées 6÷29 mm
- 19 douilles 6 pans avec carré conducteur femelle 1/2" \odot 10÷24 - 26 - 27 - 30 - 32 mm
- 1 rallonge - 1/2" 125 mm
- 1 rallonge - 1/2" 255 mm
- 1 cardan 1/2"
- 1 poignée coulissante 1/2"
- 1 cliquet réversible 1/2" \oplus
- 13 douilles 6 pans avec carré conducteur femelle 1/4" \odot 4÷14 mm
- 6 douilles tournevis pour vis 6 pans creux carré femelle 1/4" \odot 2,5÷8 mm
- 1 rallonge - 1/4" 50 mm
- 1 rallonge - 1/4" 150 mm
- 1 cardan avec carrés mâle et femelle 1/4"
- 1 poignée emmanchée avec carré mâle 1/4"
- 1 poignée coulissante avec carré mâle 1/4"
- 1 cliquet réversible avec carré mâle 1/4" \oplus
- 9 tournevis pour vis à fente \bullet 3x75 - 3x100 - 4x100 - 4x150 - 5,5x100 - 5,5x150 - 6,5x150 - 8x150 - 10x200 mm
- 2 tournevis à lame courte pour vis à fente \bullet 4x30 - 6,5x30 mm
- 7 tournevis pour vis Phillips® \oplus PH0x60 - PH0x100 - PH1x80 - PH1x120 - PH2x100 - PH2x150 - PH3x150 mm
- 2 tournevis à lame courte pour vis Phillips® \oplus PH1x30 - PH2x30 mm
- 1 Pince multiprise entrepassée 250 mm
- 1 pince - étou à becs droits 240 mm
- 1 Pince coupante diagonale à faible effort de coupe \leq 160 mm
- 1 Pince à becs demi-ronds longs \bullet 160 mm
- 1 pince à becs demi-ronds longs \equiv 180 mm
- 1 pinces pour circlips intérieurs à becs droits \odot 180 mm
- 1 pinces pour circlips intérieurs à becs coudés \odot 170 mm
- 1 pinces pour circlips extérieurs à becs droits \bullet 175 mm
- 1 pinces pour circlips extérieurs à becs coudés \bullet 175 mm
- 6 clés mâles 6 pans en T 2,5 - 3 - 4 - 5 - 6 - 8 mm
- 5 limes demi-douces 200 mm
- 2 burins nervurés 100 - 200 mm
- 1 marteau de mécanicien 300 g
- 1 maillet à embouts nylon, manche en bois Ø 35 mm
- 1 pince à riveter
- 100 rivets en aluminium 2,9x6 mm
- 100 rivets en aluminium 3,2x8 mm
- 100 rivets en aluminium 3,8x10 mm
- 100 rivets en aluminium 4x12 mm
- 100 rivets en aluminium 4,8x12 mm
- 1 mètre à ruban
- 1 mini - monture de scie à métaux
- 1 Etui de 10 lames sécables 18 mm, pour 1771 et 1771BM, 1771HD
- 1 cutter à lame sécable 18 mm avec lames

Réf. Beta	TR
42	T05
42	T06
31	T31
32	T31
55	T31
96N/SC9	T31
90	T40
920A	T83
920/21	T83
920/22	T83
920/25	T83
920/42	T83
920/55	T83
900	T91
900ME	T91
900/20	T91
900/21	T91
900/25	T91
900BG/30	T91
900/42	T91
900/55	T91
1260	T167
1260N	T167
1262	T168
1262N	T168
1048N	T153
1052	T153
1084	T138
1166	T138
1150	T138
1032	T145
1034	T145
1036	T145
1038	T145
951	T68
1719BMA8/S5	T236
35	T234
1370	T234
1390	T234
1741B	T281
1741RV...K	T281
1741RV...K	T281
1741RV...K	T281
1741RV...K	T281
1741RV...K	T281
1692	T294
1725CR	T294
1771RL	T294
1771	T294



T05 T06 T31



T40 T83 T91



T167 T168

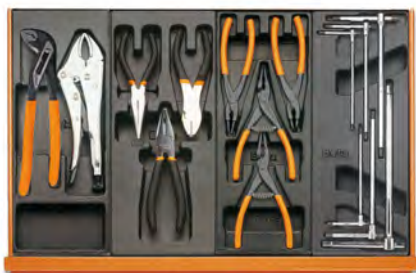

T153 T138 T145 T68



T236 T234 T281 T294

CHF

5904VI/2T

2,770.00 059041164

Composition conseillée avec RSC24 à 7 - 8 tiroirs - RSC24A à 7 - 8 tiroirs - RSC24AXL - C37 à 7 - 8 tiroirs - C39 à 7 - 8 tiroirs
RSC24L - RSC24L-CAB - C59 - C55 - RSC23T - RSC28 - C39MO - C39SM

5904VI/3T

Composition de 142 outils en plateaux thermoformés rigides en ABS

► Maintenance industrielle

Quantité/Description



T05 T06 T31



T167 T202 T205



T80 T73 T68



T137 T153 T145 T146



T231 T297 T281



T279 VP6

- 16 clés mixtes 6+21 mm
- 5 clés mixtes 22 - 24 - 27 - 30 - 32 mm
- 5 chasse-goupilles Ø 2 - 3 - 4 - 5 - 6 mm
- 1 pointe Ø 4 mm
- 12 clés à fourches 6x7 - 8x9 - 10x11 - 12x13 - 14x15 - 16x17
18x19 - 20x22 - 21x23 - 24x26 - 27x29 - 30x32 mm
- 9 clés mâles 6 pans coudées Ø 1,5 - 2 - 2,5 - 3 - 4 - 5 - 6 - 8 - 10 mm
- 9 tournevis pour vis à fente ● 3x75 - 3,5x100 - 4x100 - 4x150 - 5,5x100 - 5,5x150 - 6,5x150 - 8x150 - 10x200 mm
- 2 tournevis à lame courte pour vis à fente ● 4x30 - 6,5x30 mm
- 6 tournevis pour vis Phillips® ● PH0x60 - PH0x100 - PH1x80 - PH1x120 - PH2x100 - PH2x150 mm
- 7 tournevis pour vis Torx® ● T6-T7-T8-T9-T10-T15-T20
- 5 douilles tournevis pour vis 6 pans creux carré femelle 1/2" ○ 5 - 6 - 8 - 10 - 12 mm
- 1 rallonge - 1/2" 125 mm
- 1 rallonge - 1/2" 255 mm
- 1 cardan 1/2"
- 1 poignée coulissante 1/2"
- 1 cliquet réversible 1/2" ⊕
- 19 douilles 6 pans avec carré conducteur femelle 1/2" ○ 10+24 - 26 - 27 - 30 - 32 mm
- 8 Clé en tube droite 12 pans 6x7 - 8x9 - 10x11 - 12x13 - 14x15 - 16x17
18x19 - 20x22 mm
- 1 broches pour articles 930 - 935
- 1 broches pour articles 930 - 935
- 6 clés mâles 6 pans en T 2,5 - 3 - 4 - 5 - 6 - 8 mm
- 1 pince à becs demi-ronds longs = 180 mm
- 1 Pince à becs demi-ronds longs ● 160 mm
- 1 Pince coupante diagonale à faible effort de coupe ☞ 160 mm
- 1 Pince multiprise entrecroisée 250 mm
- 1 pince - étai à becs droits 240 mm
- 1 pinces pour circlips intérieurs à becs droits ○ 170 mm
- 1 pinces pour circlips intérieurs à becs coudés ○ 170 mm
- 1 pinces pour circlips extérieurs à becs droits ● 175 mm
- 1 pinces pour circlips extérieurs à becs coudés ● 175 mm
- 1 pinces pour circlips intérieurs à becs droits ○ 140 mm
- 1 pinces pour circlips intérieurs à becs coudés ○ 225 mm
- 1 pinces pour circlips extérieurs à becs droits ● 140 mm
- 1 pinces pour circlips extérieurs à becs coudés ● 225 mm
- 1 marteau de mécanicien 400 g
- 1 maillet à embouts nylon, manche en bois Ø 35 mm
- 1 limes demi-douces 200 mm
- 1 limes demi-douces 200 mm
- 1 limes demi-douces 200 mm
- 1
- 1 réglet flexible 300 mm
- 1 Mètre à ruban 5 m
- 1 pince à riveter 250 mm
- 100 rivets en aluminium 2,9x6 mm
- 100 rivets en aluminium 3,2x8 mm
- 100 rivets en aluminium 3,8x10 mm
- 100 rivets en aluminium 4x12 mm
- 100 rivets en aluminium 4,8x12 mm
- 1 cisaille type américain coupe droite 250 mm
- 1 ciseaux d'électricien
- 1 monture de scie à métaux
- (5) lames de scies
- 1 Burette tôle 200 cc
- 1 bac de rangement

Réf. Beta	TR
42	T05
42	T06
31	T31
32	T31
55	T31
96N/SC9	T31
1260	T167
1260N	T167
1262	T202
1267TX	T205
920ME	T80
920/21	T80
920/22	T80
920/25	T80
920/42	T80
920/55	T80
920A	T80
930	T73
940/1	T73
940/2	T73
951	T68
1150BM	T137
1166BM	T137
1084BM	T137
1048N	T153
1052	T153
1032	T145
1034	T145
1036	T145
1038	T145
1032	T146
1034	T146
1036	T146
1038	T146
1370	T231
1390	T231
1719BMA8/T	T231
1719BMA8/P	T231
1719BMA8/M	T231
1651DGTB	T297
1682	T297
1691BM	T297
1741B	T281
1741RV..K	T281
1741RV..K	T281
1741RV..K	T281
1741RV..K	T281
1741RV..K	T281
1112	T279
1128BM	T279
1726	T279
1728BM	T279
1751N	T279
VP6	VP6

CHF

5904VI/3T 3,170.00 059041168

Composition conseillée avec RSC24 à 8 tiroirs - RSC24/A à 8 tiroirs - C37 à 8 tiroirs - C39 à 8 tiroirs
RSC24AXL - RSC28 - C39MO - C39SM - C55 - C59B

5908VI/2T

Composition de 232 outils en plateaux thermoformés rigides en ABS

► Maintenance industrielle

Quantité/Description

Réf. Beta TR



T80 T05 T06



T91 T68 T40 T41



T199 T202 T201 T204



T234 T281 T153 T236



T145 T137 T31



T279 VP5



T273 T270

- 5 douilles tournevis pour vis 6 pans creux carré femelle 1/2" \odot 5 - 6 - 8 - 10 - 12 mm
- 1 rallonge - 1/2" 125 mm
- 1 rallonge - 1/2" 255 mm
- 1 cardan 1/2"
- 1 poignée coulissante 1/2"
- 1 cliquet réversible 1/2" \odot
- 19 douilles 6 pans avec carré conducteur femelle 1/2" \odot 10÷24 - 26 - 27 - 30 - 32 mm
- 16 clés mixtes 6÷21 mm
- 5 clés mixtes 22 - 24 - 27 - 30 - 32 mm
- 13 douilles 6 pans avec carré conducteur femelle 1/4" \odot 4÷14 mm
- 6 douilles tournevis pour vis 6 pans creux carré femelle 1/4" \odot 2,5 - 3 - 4 - 5 - 6 - 8 mm
- 1 rallonge - 1/4" 50 mm
- 1 rallonge - 1/4" 150 mm
- 1 poignée emmanchée avec carré mâle 1/4"
- 1 cardan avec carrés mâle et femelle 1/4"
- 1 poignée coulissante avec carré mâle 1/4"
- 1 cliquet réversible avec carré mâle 1/4" \odot
- 6 clés mâles 6 pans en T 2,5 - 3 - 4 - 5 - 6 - 8 mm
- 7 clés polygonales contre - coudées 6x7-8x9-10x11-12x13-14x15-16x17-18x19 mm
- 5 clés polygonales contre - coudées 20x22 - 21x23 - 24x26 - 25x28 - 27x29 mm
- 7 tournevis pour vis à fente \bullet 2,5x50 - 3x75 - 3,5x100 - 4x125 - 5,5x100 - 5,5x150 - 6,5x150 mm
- 6 tournevis pour vis Phillips \oplus PH0x60 - PH0x100 - PH1x80 - PH1x120 - PH2x100 - PH2x150 mm
- 3 tournevis pour vis à fente \bullet 8x200 - 10x150 - 10x200 mm
- 2 tournevis à lame courte pour vis à fente \bullet 4x30 - 6,5x30 mm
- 2 tournevis pour vis Phillips \oplus PH3x150 - PH4x200 mm
- 2 tournevis à lame courte pour vis Phillips \oplus PH1x30 - PH2x30 mm
- 2 burins nervurés 100 - 200 mm
- 1 marteau de mécanicien 300 g
- 1 maillet à embouts nylon, manche en bois \varnothing 35 mm
- 1 pince à riveter 250 mm
- 100 rivets en aluminium 2,9x6 mm
- 100 rivets en aluminium 3,2x8 mm
- 100 rivets en aluminium 3,8x10 mm
- 100 rivets en aluminium 4x12 mm
- 100 rivets en aluminium 4,8x12 mm
- 1 Pince multiprise entrepassée 250 mm
- 1 pince - étou à becs droits 240 mm
- 5 limes demi-douces 200 mm
- 1 pinces pour circlips intérieurs à becs droits \odot 180 mm
- 1 pinces pour circlips intérieurs à becs coudés \odot 170 mm
- 1 pinces pour circlips extérieurs à becs droits \bullet 175 mm
- 1 pinces pour circlips extérieurs à becs coudés \bullet 175 mm
- 1 pince à becs demi-ronds longs \equiv 180 mm
- 1 Pince à becs demi-ronds longs \bullet 160 mm
- 1 Pince coupante diagonale à faible effort de coupe \nless 160 mm
- 5 chasse-goupilles \varnothing 2 - 3 - 4 - 5 - 6 mm
- 1 pointeau \varnothing 4 mm
- 12 clés à fourches 6x7 - 8x9 - 10x11 - 12x13 - 14x15 - 16x17 - 18x19 - 20x22 - 21x23 - 24x26 - 27x29 - 30x32 mm
- 9 clés mâles 6 pans coudées \odot 1,5 - 2 - 2,5 - 3 - 4 - 5 - 6 - 8 - 10 mm
- 1 cisaille type américain coupe droite 250 mm
- 1 ciseaux d'électricien
- 1 monture de scie à métaux
- 5 lames de scies
- 1 Burette tôle 200 cc
- 1 bac de rangement
- 1 tourne - à - gauche extensible M3÷M12
- 1 tourne - à - gauche extensible M5÷M21
- 1 porte - outils à cliquet réversible 2,0÷5,0 mm (M3÷M8)
- 1 porte - outils à cliquet réversible 4,6÷8,0 mm (M5÷M12)
- 1 porte - filières 25,4 mm
- 1 porte - filières 38,1 mm
- 1 jauge de filetage 0,25÷6 W 62÷4x1"
- 26 tarauds à main, pas gros, filetage métrique M3 - 4 - 5 - 6 - 7 - 8 - 9 - 10 - 12 - 14 - 16 - 18 - 20
- 14 tarauds à main, pas fin, filetage métrique M6x0,75 - M8x1 - M10x1,25 - M12x1,5 - M14x1,5 - M16x1,5 - M18x1,5
- 7 filières rondes, pas gros, filetage métrique M3 - 4 - 5 - 6 - 7 - 8 - 9
- 6 filières rondes, pas gros, filetage métrique M10 - 12 - 14 - 16 - 18 - 20
- 2 filières rondes, pas fin, filetage métrique M6x0,75 - M8x0,75
- 5 filières rondes, pas fin, filetage métrique M10x1,25 - M12x1,5 - M14x1,5 - M16x1,5 - M18x1,5

920ME	T80
920/21	T80
920/22	T80
920/25	T80
920/42	T80
920/45	T80
920/55	T80
920A	T80
42	T05
42	T06
900	T91
900ME	T91
900/20	T91
900/21	T91
900BG/30	T91
900/25	T91
900/42	T91
900/55	T91
951	T68
90	T40
90	T41
1260	T199
1262	T202
1260	T201
1260N	T201
1262	T204
1262N	T204
35	T234
1370	T234
1390	T234
1741B	T281
1741RV...K	T281
1741RV...K	T281
1741RV...K	T281
1741RV...K	T281
1741RV...K	T281
1048N	T153
1052	T153
1719BMA...S5	T236
1032	T145
1034	T145
1036	T145
1038	T145
1150BM	T137
1166BM	T137
1084BM	T137
31	T31
32	T31
55	T31
96N/SC9	T31
1112	T279
1128BM	T279
1726	T279
1728BM	T279
1751N	T279
VP5	VP5
435/1,5	T273
435/3	T273
436/1	T273
436/2	T273
444/1	T273
444/2	T273
1707	T273
430	T270
433	T270
440	T270
440A	T270
441	T270
441A	T270

CHF

5908VI/2T 4,200.00 059081105

Composition conseillée avec RSC28 - RSC24AXL à 8-9 tiroirs, RSC24A à 8 tiroirs, RSC24 à 8 tiroirs, C37 à 8 tiroirs, C39 à 8 tiroirs

5910VI/3

Composition de 297 outils



► Maintenance industrielle

Quantité/Description	Réf. Beta
6 Ø 2 - 3 - 4 - 5 - 6 - 8 mm	31/B6N
1 pointeau Ø 4 mm	32
2 burins nervurés 125 - 250 mm	35
1 bédane nervuré 200 mm	37
30 clés mixtes 6-7-8-9-10-11-12-13-14-15-16-17-18-19-20-21-22-23-24-25-26-27-28-29-30-32-35-36-38-41 mm	42
14 clés à fourches 6x7 - 8x9 - 10x11 - 12x13 - 14x15 - 16x17 18x19 - 20x22 - 21x23 - 24x26 - 25x28 - 27x29 - 30x32 - 36x41 mm	55
13 clés polygonales contre - coudées 6x7+30x32 mm	90
14 clés mâles 6 pans coudées Ø 1,5 - 2 - 2,5 - 3 - 4 - 5 - 6 - 8 - 10 - 12 - 13 - 14 - 17 - 19 mm	96N
1 Clé à molette à ouverture graduée, chromée 250 mm	111E
1 clé serre - tubes modèle américain 300 mm	362
25 forets taillés, série courte 1+13x0,5 mm	412/SP25
37 composition de tarauds et de filières en acier HSS	447/C37
1 Clé dynamométrique à déclenchement ZERO-RESET Ⓢ 1/2", 40+200 Nm	666/20
1 poignée à béquille à cardan 1/2"	920/40
4 douilles tournevis pour vis 6 pans creux carré femelle 1/2" Ø 10-12-14-17 mm	920ME
25 20 douilles et 5 accessoires	920A/C20X
17 composition de 12 douilles et 5 accessoires 3/4"	928A/C12
12 clés à pipe débouchées 6 et 12 pans gros effort 8 - 10 - 11 - 13 - 14 - 17 - 19 - 22 - 24 - 27 - 30 - 32 mm	932
14 clés mâles 6 pans en T 2+14 mm	951/S14
5 clés mâles 6 pans à béquille à cardan Ø 3 - 4 - 5 - 6 - 8 mm	953
3 pinces pour circlips intérieurs à becs droits Ø 180 - 225 - 300 mm	1032
3 pinces pour circlips intérieurs à becs coudés Ø 170 - 210 - 290 mm	1034
3 pinces pour circlips extérieurs à becs droits ● 140x1,3 - 175 - 225 mm	1036
3 pinces pour circlips extérieurs à becs coudés ● 135x1,3 - 175 - 220 mm	1038
2 Pince multiprise entrecroisée 250 - 300 mm	1048N
1 pince-étau à becs longs	1051
1 pince coupante diagonale à faible effort de coupe, branchées gainées confort bi-matières, finition industrielle ⚡ 160 mm	1084GBM
1 pince coupante frontale articulée, série lourde ⚡ 180 mm	1092V
1 cisaille type américain coupe droite 300 mm	1112
1 cisaille bichantourneuse bac de canard 250 mm	1114
1 ciseaux d'électricien	1128BMX
1 pince universelle, branches gainées confort bi-matières, modèle grande capacité, finition industrielle ≡ 180 mm	1150GBM
1 pince à becs demi-ronds longs striés, branches gainées confort bi-matières, finition industrielle ● 160 mm	1166GBM
1 pince à becs coudés demi-ronds longs striés, branches gainées confort bi-matières, finition industrielle ● 160 mm	1168GBM
9 tournevis pour vis à fente ● 2,5x50 - 3x75 - 3,5x150 - 4x125 - 5,5x125 - 6,5x150 - 8x200 - 10x200 - 12x250 mm	1260
2 tournevis à lame courte pour vis à fente ● 4x30 - 6,5x30 mm	1260N
5 tournevis pour vis Phillips® ● PH0x100 - PH1x120 - PH2x150 - PH3x150 - PH4x200 mm	1262
2 tournevis à lame courte pour vis Phillips® ● PH1x30 - PH2x30 mm	1262N
7 tournevis pour vis Torx® ⚡ T6 - T8 - T10 - T15 - T20 - T25 - T30	1267TX
2 marteau de mécanicien 300 - 600 g	1370
2 maillet à embouts nylon, manche en bois Ø 35 - 60 mm	1390
5 extracteurs de goujons cassés M3+M18	1430/S5
1 Extracteur universel à 2 griffes 23+70 mm	1500N/1
1 Extracteur universel à 2 griffes 23+100 mm	1500N/2
1 Pied à coulisse	1650
1 réglet semi-rigide 300 mm	1683
1 pointe à tracer en carbure	1688A
1 mètre à ruban 5 m	1692
1 jauge d'épaisseur	1708/13
1 doigt magnétique flexible 1,8 kg	1712E/2
5 limes demi-douces 200 mm	1719BMA8/S5
1 monture de scie à métaux	1726BM
1 pince à riveter	1741B
1 Burette tôle 200 cc	1751N

CHF

5910VI/3

8,750.00 059101044

Composition conseillé en association avec C30M

5910VI/3T

Composition de 261 outils en plateaux thermoformés rigides en ABS

► Maintenance industrielle

Quantité/Description

Réf. Beta TR



T05 T06 T31



T40 T41 T80



T167 T168 +96N



T279
T137 T145 T234 T236



- 16 clés mixtes 6÷21 mm 42 T05
- 5 clés mixtes 22 - 24 - 27 - 30 - 32 mm 42 T06
- 5 chasse-goupilles Ø 2 - 3 - 4 - 5 - 6 mm 31 T31
- 1 pointeau Ø 4 mm 32 T31
- 13 clés à fourches 6x7 - 8x9 - 10x11 - 12x13 - 14x15 - 16x17 55 T31
- 18x19 - 20x22 - 21x23 - 24x26 - 27x29 - 30x32 mm
- 9 clés mâles 6 pans coudées Ø 1,5 - 2 - 2,5 - 3 - 4 - 5 - 6 - 8 - 10 mm 96N/SC9 T31
- 5 clés polygonales contre - coudées 20x22 - 21x23 - 24x26 - 25x28 - 27x29 mm 90 T41
- 7 clés polygonales contre - coudées 6x7 - 8x9 - 10x11 - 12x13 - 14x15 - 16x17 90 T40
- 18x19 mm
- 5 douilles tournevis pour vis 6 pans creux carré femelle 1/2" Ø 5 - 6 - 8 - 10 - 12 mm 920ME T80
- 1 rallonge - 1/2" 125 mm 920Z1 T80
- 1 rallonge - 1/2" 255 mm 920Z2 T80
- 1 cardan 1/2" 920Z5 T80
- 1 poignée coulissante 1/2" 920Z4 T80
- 1 cliquet réversible 1/2" 920Z5 T80
- 19 douilles 6 pans avec carré conducteur femelle 1/2" Ø 10÷24 - 26 - 27 - 30 - 32 mm 920A T80
- 9 tournevis pour vis à fente ● 3x75 - 3x100 - 4x100 - 4x150 - 5,5x100 - 5,5x150 - 6,5x150 - 8x150 - 10x200 mm 1260 T167
- 2 tournevis à lame courte pour vis à fente ● 4x30 - 6,5x30 mm 1260N T167
- 7 tournevis pour vis Phillips® ● PH0x60 - PH0x100 - PH1x80 - PH1x120 - PH2x100 - PH2x150 - PH3x150 mm 1262 T168
- 2 tournevis à lame courte pour vis Phillips® ● PH1x30 - PH2x30 mm 1262N T168
- 4 clés mâles 6 pans coudées Ø 13-14-17-19 mm 96N T168
- 1 cisaille type américain coupe droite 250 mm 1112 T279
- 1 ciseaux d'électricien 1128BM T279
- 1 monture de scie à métaux 1726 T279
- (5) lames de scies 1728BM T279
- 1 Burette tôle 200 cc 1751N T279
- 1 pince à becs demi-ronds longs ≡ 180 mm 1150BM T137
- 1 Pince à becs demi-ronds longs ● 160 mm 1166BM T137
- 1 Pince coupante diagonale à faible effort de coupe ≡ 160 mm 1084BM T137
- 1 pinces pour circlips intérieurs à becs droits Ø 180 mm 1032 T145
- 1 pinces pour circlips intérieurs à becs coudés Ø 170 mm 1034 T145
- 1 pinces pour circlips extérieurs à becs droits ● 175mm 1036 T145
- 1 pinces pour circlips extérieurs à becs coudés ● 175mm 1038 T145
- 2 burins nervurés 100 - 200 mm 35 T234
- 1 marteau de mécanicien 300 g 1370 T234
- 1 maillet à embouts nylon, manche en bois Ø 35 mm 1390 T234
- 1 limes demi-douces 200 mm 1719BMA8/S5 T236
- 4 clés mixtes 35-36-38-41 mm 42
- 1 clés à fourches 36x41 mm 55
- 1 Clé à molette à ouverture graduée, chromée 250 mm 111E
- 1 clé serre - tubes modèle américain 300 mm 362
- 25 forets taillés, série courte 412/SP25
- 37 composition de tarauds et de filières en acier HSS 447/C37
- 1 Clé dynamométrique à déclenchement ZERO-RESET Ⓢ 40÷200 Nm 666/20
- 17 composition de 12 douilles et 5 accessoires 3/4" 928A/C12
- 14 clés mâles 6 pans en T 951/S14
- 5 clés mâles 6 pans à béquille à cardan Ø 3-4-5-6-8 mm 953
- 1 pinces pour circlips intérieurs à becs droits Ø 300 mm 1032
- 1 pinces pour circlips intérieurs à becs coudés Ø 290 mm 1034
- 1 pinces pour circlips extérieurs à becs droits ● 225 mm 1036
- 1 pinces pour circlips extérieurs à becs coudés ● 220 mm 1038
- 1 Pince multiprise entrecroisée 300 mm 1048N
- 1 pince-étai à becs longs 1051
- 1 pince coupante frontale articulée, série lourde ≡ 180 mm 1092V
- 1 marteau de mécanicien 600 g 1370
- 1 maillet à embouts nylon, manche en bois 60 mm 1390
- 5 extracteurs de goujons cassés M3-M18 1430/S5
- 1 Extracteur universel à 2 griffes 1500/3
- 1 Pied à coulisse 1650
- 1 réglet semi-rigide 1683
- 1 pointe à tracer en carbure 1688
- 1 mètre à ruban 5 m 1692
- 1 jauge d'épaisseur 1708/13
- 1 doigt magnétique flexible 1712E/2

CHF

5910VI/3T 7,480.00 059101063

Composition conseillé en association avec C30M

5935VI/2MB

Composition de 133 outils pour coffre C35, en plateaux mousse compacte

► Maintenance industrielle



MB12



MB37



MB44



MB55

Quantité/Description

- 21 clés mixtes 6-7-8-9-10-11-12-13-14-15-16-17-18-19-20-21-22-24-27-30-32 mm
- 8 clés à fourches 6x7-8x9-10x11-12x13-14x15
- 16x17-18x19-20x22 mm
- 1 Pince multiprise entrepassée 250 mm
- 19 douilles 6 pans avec carré conducteur femelle 1/2" ♂ 10-11-12-13-14-15-16-17-18-19-20-21-22-23-24-26-27-30-32 mm
- 1 rallonge angulaire - 1/2" 125 mm
- 1 rallonge angulaire - 1/2" 150 mm
- 1 cardan 1/2"
- 1 poignée coulissante 1/2"
- 1 cliquet réversible 1/2" Ⓢ
- 1 Clé à molette à ouverture graduée, chromée 250 mm
- 1 pince - étau à becs droits 240 mm
- 1 Pince coupante diagonale à faible effort de coupe \leq 160 mm
- 1 pince à becs demi-ronds longs \equiv 180 mm
- 1 Pince à becs demi-ronds longs \bullet 160 mm
- 1 pinces pour circlips intérieurs à becs droits \odot 180 mm
- 1 pinces pour circlips intérieurs à becs coudés \odot 170 mm
- 1 pinces pour circlips extérieurs à becs droits \bullet 175 mm
- 1 pinces pour circlips extérieurs à becs coudés \bullet 175 mm
- 13 douilles 6 pans avec carré conducteur femelle 1/4" ♂ 4-4,5-5-5,5-6-7-8-9-10-11-12-13-14 mm
- 1 rallonge - 1/4" 50 mm
- 1 rallonge - 1/4" 150 mm
- 1 cardan avec carrés mâle et femelle 1/4"
- 1 poignée emmanchée avec carré mâle 1/4"
- 1 cliquet réversible avec carré mâle 1/4" Ⓢ
- 1 poignée coulissante avec carré mâle 1/4"
- 7 tournevis pour vis à fente \bullet 2,5x50-3x75-3,5x100-4x100-5,5x125-6,5x150-8x200 mm
- 2 tournevis à lame courte pour vis à fente \bullet 4x30-6,5x30 mm
- 7 tournevis pour vis Phillips® \oplus PH0x60-PH0x100-PH1x80-PH1x120-PH2x100-PH2x150-PH3x150 mm
- 2 tournevis à lame courte pour vis Phillips® \oplus PH1x30-PH2x30 mm
- 1 tournevis détecteur de tension \bullet 4x30-6,5x30 mm
- 9 clés mâles 6 pans coudées à tête sphérique \odot
- 6 clés mâles 6 pans en T 2,5-3-4-5-6-8 mm
- 5 chasse-goupilles \varnothing 2-3-4-5-6 mm
- 1 pointeau \varnothing 4 mm
- 1 burins nervurés 200 mm
- 1 cisaille type américain coupe droite 250 mm
- 1 ciseaux d'électricien
- 1 marteau de mécanicien 500 g
- 1 maillet à embouts nylon, manche en bois \varnothing 45 mm
- 1 Lime carrée demi-douce 200 mm
- 1 Lime triangulaire demi-douce 200 mm
- 1 Lime plate demi-douce 200 mm
- 1 Lime demi-ronde demi-douce 200 mm
- 1 lime ronde demi-douce 200 mm
- 1 monture de scie à métaux 440 mm

Réf. Beta	TR
42	MB12
55	MB12
1048N	MB12
920A	MB37
920AN/125	MB37
920AN/250	MB37
920/25	MB37
920/42	MB37
920/55	MB37
111E	MB37
1052	MB37
1084BM	MB37
1150BM	MB37
1166BM	MB37
1032	MB37
1034	MB37
1036	MB37
1038	MB37
900	MB37
900/20	MB37
900/21	MB37
900/25	MB37
900BG/30	MB37
900/55	MB37
900/42	MB37
1260	MB44
1260N	MB44
1262	MB44
1262N	MB44
1253	MB44
96BPC/SC9	MB44
951	MB44
31	MB55
32	MB55
35	MB55
1112	MB55
1128BMX	MB55
1370	MB55
1390	MB55
1719BMA...Q	MB55
1719BMA...T	MB55
1719BMA...P	MB55
1719BMA...M	MB55
1719BMA...R	MB55
1726	MB55

CHF

5935VI/2MB

2,880.00 059351316

Composition conseillée avec C35

5957VI

Composition de 162 outils

► Maintenance industrielle



Quantité/Description	Réf. Beta
6 chasse-goupilles Ø 2 - 3 - 4 - 5 - 6 - 8 mm	31/SP6
6 2 chasse - clous, 1 pointeau, 2 burins plats, 1 bédane, sur présentoir	38/SP6
18 clés mixtes 6-7-8-10-11-12-13-14-15-16-17-19-21-22-24-27-30-32 mm	42
12 clés à fourches 6x7 + 30x32 mm	55/S12X
8 clés mâles 6 pans à poignée en T 2 - 2,5 - 3 - 4 - 5 - 6 - 8 - 10 mm	96T/S8
8 clés mâles coudées pour vis Torx® T9 - T10 - T15 - T20 - T25 - T27 - T30 - T40	97TX/SC8
1 Clé à molette à ouverture graduée, chromée 250 mm	111E
13 douilles 12 pans 1/2" sur rail Ø 10+22 mm	920B/SB13
8 douilles 12 pans 1/2" sur rail Ø 23+32 mm	920B/SB8
4 douilles pour vis à fente 1/2" ● 1,2x6,5 - 1,2x8 - 1,6x9 - 2x12 mm	920LP
3 douilles pour vis Phillips® 1/2" ● PH2 - 3 - 4	920PH
1 rallonge - 1/2" 125 mm	920/21
1 rallonge - 1/2" 255 mm	920/22
1 cardan 1/2"	920/25
1 poignée coulissante 1/2"	920/42
1 cliquet réversible 1/2" ⊗	920/55
1 pince levier à broche et palette	963
2 pinces pour circlips intérieurs à becs droits ⊙ 140 - 180 mm	1032
2 pinces pour circlips intérieurs à becs coudés ⊙ 130 - 170 mm	1034
2 pinces pour circlips extérieurs à becs droits ● 140 - 175 mm	1036
2 pinces pour circlips extérieurs à becs coudés ● 135 - 175 mm	1038
1 Pince multiprise entrecroisée 250 mm	1048N
1 pince-étau à becs longs	1051
1 Pince coupante diagonale à faible effort de coupe ≋ 160 mm	1084BM
1 pince coupante frontale articulée, série lourde ≋ 180 mm	1092V
1 cisaille type américain coupe droite 250 mm	1112
1 cisaille bichantourneuse bac de canard 250 mm	1114
1 ciseaux d'électricien	1128BMX
1 pince à becs demi-ronds longs ≡ 180 mm	1150BM
1 Pince à becs demi-ronds longs ● 160 mm	1166BM
1 Pince à becs coudés demi-ronds ● 160 mm	1168BM
7 tournevis pour vis à fente ● 2,5x50 - 3x75 - 4x100 - 5,5x125 - 6,5x150 - 8x200 - 10x200 mm	1260
4 tournevis pour vis Phillips® ⊕ PH0x60 - PH1x80 - PH2x100 - PH3x150 mm	1262
3 marteau de mécanicien 300 - 600 - 1000 g	1370
1 maillet à embouts nylon, manche en bois Ø 35 mm	1390
1 mètre à ruban 5 m	1692
1 doigt magnétique flexible 1,8 kg	1712E/2
1 grattoir feuille de sauge 200 mm	1717A
1 grattoir triangulaire 200 mm	1717B
5 limes demi-douces 200 mm	1719BMA8/S5
1 monture de scie à métaux	1725
1 burette tôle à embout flexible 200 cc	1751
1 burins nervurés 200 mm	35
1 bédane nervuré 200 mm	37
11 clés à pipe débouchées 6 et 12 pans gros effort 8 - 10 - 11 - 12 - 13 - 14 - 16 - 17 - 19 - 22 - 24 mm	932
1 pince - étau à becs droits 240 mm	1052
1 pince - étau à becs droits 280 mm	1060
1 pince - étau à becs droits 290 mm	1062
1 massette sans rebond Ø 50 mm	1392
1 Extracteur universel à 2 griffes 25+130 mm	1500N/2
1 Pied à coulisse	1650
1 réglé semi-rigide 300 mm	1683
1 pointe à tracer en carbure	1688A
1 jauge d'épaisseur	1708/13
1 couteau d'électricien avec dénudeur	1777BM
1 cutter à lame sécable 18 mm avec lames 170 mm	1771BM
1 Pince coupante diagonale ≋ 160 mm	1082BM

CHF



5957VI 4,450.00 059571005

Composition conseillée avec C57S A - C57S B - C57SP - C55PSP

5954VI

Composition de 133 outils

► Maintenance industrielle

Quantité/Description	Réf. Beta
5 chasse-goupilles Ø 2-3-4-5-6 mm	31
1 pointeau Ø 4 mm	32
2 burins nervurés 200-250 mm	35
18 clés mixtes 6+14 - 16 - 17 - 18 - 19 - 21 - 22 - 24 - 27 - 30 mm	42
12 clés à fourches 6x7 - 8x9 - 10x11 - 12x13 - 14x15 - 16x17 - 18x19 - 20x22 - 21x23 - 24x26 - 27x29 - 30x32 mm	55
12 clés mâles 6 pans coudées Ø 2+10 mm	96/SC12
1 Clé à molette à ouverture graduée, chromée 250 mm	111E
1 clé serre - tube modèle suédois tête inclinée à 45° 320 mm	374
20 douilles 6 pans avec carré conducteur femelle 1/2" Ø 10+24 - 26 - 27 - 28 - 30 - 32 mm	920A
6 douilles tournevis pour vis 6 pans creux carré femelle 1/2" Ø 5 - 6 - 8 - 10 - 12 - 14 mm	920ME
1 rallonge - 1/2" 125 mm	920/21
1 rallonge - 1/2" 255 mm	920/22
1 cardan 1/2"	920/25
1 poignée à béquille à cardan 1/2"	920/40
1 poignée coulissante 1/2"	920/42
1 cliquet réversible 1/2" Ⓢ	920/55
6 clés mâles 6 pans en T 2,5 - 3 - 4 - 5 - 6 - 8 mm	951
2 pinces pour circlips intérieurs à bords droits Ø 140 - 180 mm	1032
1 pinces pour circlips intérieurs à bords coudés Ø 170 mm	1034
2 pinces pour circlips extérieurs à bords droits Ø 140x1,3 - 175 mm	1036
1 pinces pour circlips extérieurs à bords coudés Ø 175 mm	1038
1 Pince multiprise entrecroisée 250 mm	1048N
1 pince - étau à bords droits 240 mm	1052
1 Pince coupante diagonale à faible effort de coupe ≤ 160 mm	1084BM
1 pince coupante frontale articulée, série lourde ≤ 180 mm	1092V
1 cisaille type américain coupe droite 250 mm	1112
1 ciseaux d'électricien	1128BMX
1 pince à bords demi-ronds longs = 180 mm	1150BM
1 Pince à bords demi-ronds longs ● 160 mm	1166BM
1 tournevis détecteur de tension ●	1253
2 tournevis pour vis à fente ● 8x150 - 10x200 mm	1260
2 tournevis à lame courte pour vis à fente ● 4x30 - 6,5x30 mm	1260N
2 tournevis pour vis Phillips® ● PH3x150 - PH4x200 mm	1262
2 tournevis à lame courte pour vis Phillips® ● PH1x30 - PH2x30 mm	1262N
8	1263/D8
2 marteau de mécanicien 300 - 500 g	1370
1 maillet à embouts nylon, manche en bois Ø 45 mm	1390
1 mètre à ruban 5 m	1692
1 doigt magnétique flexible 0,5 kg	1712E/1
5 limes demi-douces 200 mm	1719BMA8/S5
1 monture de scie à métaux	1726BM
1 burette plastique 250 cc	1754



CHF

5954VI

3,040.00 059541053

Composition conseillée avec C54S-C55C

5904VU/1M

Composition de 91 outils en plateaux mousse compacte

► Maintenance générale

Quantité/Description

- 16 clés mixtes 6÷21 mm
- 8 clés à fourches 6x7 - 8x9 - 10x11 - 12x13 - 14x15 - 16x17 - 18x19 - 20x22 mm
- 9 clés mâles 6 pans coudées \odot 1,5 - 2 - 2,5 - 3 - 4 - 5 - 6 - 8 - 10 mm
- 6 tournevis pour vis Torx® \odot T8-T10-T15-T20-T25-T30
- 3 tournevis pour vis à fente \bullet 3x75-4x100-6,5x150 mm
- 3 tournevis pour vis Phillips® \oplus PH0x60-PH1x80-PH2x100 mm
- 8 clés mâles 6 pans à poignée en T \odot 2-2,5-3-4-5-6-7-8 mm
- 1 rallonge angulaire - 1/2" 125 mm
- 1 rallonge angulaire - 1/2" 250 mm
- 1 cardan 1/2"
- 1 poignée coulissante 1/2"
- 1 cliquet réversible 1/2" \oplus
- 19 douilles 6 pans avec carré conducteur femelle 1/2" \odot 10÷24 - 26 - 27 - 30 - 32 mm
- 1 Pince coupante diagonale à faible effort de coupe ζ 160 mm
- 1 pince à becs demi-ronds longs \equiv 180 mm
- 1 Pince à becs demi-ronds longs \bullet 160 mm
- 1 Pince multiprise entrepassée 250 mm
- 1 pince - étau à becs droits 240 mm
- 2 burins nervurés 100 - 200 mm
- 1 marteau de mécanicien 300 g
- 1 maillet à embouts nylon, manche en bois \varnothing 35 mm
- 1 pinces pour circlips intérieurs à becs droits \odot 180 mm
- 1 pinces pour circlips intérieurs à becs coudés \odot 170 mm
- 1 pinces pour circlips extérieurs à becs droits \bullet 175 mm
- 1 pinces pour circlips extérieurs à becs coudés \bullet 175 mm

Réf. Beta	TR
42	M05
55	M33
96/SC9	M33
1267TX	M204
1260	M201
1262	M201
96T	M50
920AN/125	M83
920AN/250	M83
920/25	M83
920/42	M83
920/55	M83
920A	M83
1084	M137
1150	M137
1166	M137
1048N	M153
1052	M153
35	M234
1370	M234
1390	M234
1032	M145
1034	M145
1036	M145
1038	M145



M05 M33 M204 M201



M50 M83



M137 M153 M234 M145

CHF

5904VU/1M

1,755.00 059041201

Composition conseillée avec RSC24 - RSC24A - RSC24AXL - C37 - C39 à 6 - 7 - 8 tiroirs
RSC23T - C39T - RSC24L - RSC24L-CAB - C59 - C55 - RSC28 - C39SM - C39MD

5904VU/2M

Composition de 151 outils en plateaux mousse compacte

► Maintenance générale

Quantité/Description

- 16 clés mixtes 6÷21 mm
- 8 clés à fourches 6x7 - 8x9 - 10x11 - 12x13 - 14x15 - 16x17 - 18x19 - 20x22 mm
- 9 clés mâles 6 pans coudées \odot 1,5 - 2 - 2,5 - 3 - 4 - 5 - 6 - 8 - 10 mm
- 3 tournevis pour vis à fente \bullet 3x75-4x100-6,5x150 mm
- 3 tournevis pour vis Phillips® \oplus PH0x60-PH1x80-PH2x100 mm
- 6 tournevis pour vis Torx® \otimes T8-T10-T15-T20-T25-T30
- 8 clés mâles 6 pans à poignée en T \odot 2-2,5-3-4-5-6-7-8 mm
- 1 rallonge angulaire - 1/2" 125 mm
- 1 rallonge angulaire - 1/2" 250 mm
- 1 cardan 1/2"
- 1 poignée coulissante 1/2"
- 1 cliquet réversible 1/2" \oplus
- 19 douilles 6 pans avec carré conducteur femelle 1/2" \odot 10÷24 - 26 - 27 - 30 - 32 mm
- 1 Pince coupante diagonale à faible effort de coupe \leq 160 mm
- 1 pince à becs demi-ronds longs \equiv 180 mm
- 1 Pince à becs demi-ronds longs \bullet 160 mm
- 1 Pince multiprise entrepassée 250 mm
- 1 pince - étou à becs droits 240 mm
- 2 burins nervurés 100 - 200 mm
- 1 marteau de mécanicien 300 g
- 1 maillet à embouts nylon \varnothing 35 mm
- 1 pinces pour circlips intérieurs à becs droits \odot 180 mm
- 1 pinces pour circlips intérieurs à becs coudés \odot 170 mm
- 1 pinces pour circlips extérieurs à becs droits \bullet 175 mm
- 1 pinces pour circlips extérieurs à becs coudés \bullet 175 mm
- 1
- 1 mètre à ruban 5 m
- 1 mini - monture de scie à métaux
- 1 Etui de 10 lames sécables 18 mm, pour 1771 et 1771BM, 1771HD
- 1 cutter à lame sécable 18 mm avec lames
- 5 Embout coloré pour visseuses pour vis à fente \bullet 0,5x3 - 0,6x4,5 - 0,8x5,5 - 1x5,5 - 1,2x6,5 mm
- 8 Embout coloré pour visseuses pour vis 6 pans creux \odot 2 - 2,5 - 3 - 4 - 5 - 6 - 8 - 10 mm
- 5 Embout coloré pour visseuses pour vis Phillips® \oplus PH0 - PH1 - PH2 - PH3 - PH4
- 4 Embout coloré pour visseuses pour vis Pozidriv® - Supadriv® \oplus PZ1 - PZ2 - PZ3 - PZ4
- 11 Embout coloré pour visseuses pour vis Torx® \otimes T6-T7-T8-T9-T10-T15-T20-T25-T27-T30-T40
- 8 Embout coloré pour visseuses pour vis Tamper Resistant Torx® \oplus T9-T10-T15-T20-T25-T27-T30-T40
- 1 Poignée porte-embouts à bague de déverrouillage rapide 230 mm
- 1 Cliquet réversible porte-embouts 100 mm
- 5 limes demi-douces 200 mm
- 1 porte-douille pour visseuses
- 1 rallonge porte-embouts magnétique

Réf. Beta	TR
42	M05
55	M33
96/SC9	M33
1260	M201
1262	M201
1267TX	M204
96T	M50
920AN/125	M83
920AN/250	M83
920/25	M83
920/42	M83
920/55	M83
920A	M83
1084	M137
1150	M137
1166	M137
1048N	M153
1052	M153
35	M237
1370T	M237
1390N	M237
1032	M145
1034	M145
1036	M145
1038	M145
VPM3	VPM3
1692	M294
1725SCR	M294
1771RL	M294
1771	M294
860LP	M85
860PE	M85
860PH	M85
860PZ	M85
860TX	M85
860RTX	M85
851SR	M85
860/55	M85
1719BMA8/S5	M236
892/0	M85
882P	M85



M05 M33 M204 M201



M50 M83



M137 M153 M237 M145



VPM3 M294 M85 M236

CHF

5904VU/2M 2,285.00 059041212

Composition conseillée avec RSC24 - RSC24A - C37 - C39
RSC24L - RSC24L-CAB - C59 - C55 - C23 - RSC28 - C39SM - C39MD - C39T

5904VU/2T

Composition de 104 outils en plateaux thermoformés rigides en ABS

► Maintenance générale

Quantité/Description

- 7 tournevis pour vis à fente ● 2,5x50 - 3x75 - 3,5x100 - 4x125
5,5x100 - 5,5x150 - 6,5x150 mm
- 6 tournevis pour vis Phillips®
● PH0x60 - PH0x100 - PH1x80 - PH1x120 - PH2x100 - PH2x150 mm
- 19 douilles 6 pans avec carré conducteur femelle 1/2" ○ 10-11-12-13-14-15-16-17-18-19
20-21-22-23-24-26-27-30-32 mm
- 1 rallonge - 1/2" 125 mm
- 1 rallonge - 1/2" 255 mm
- 1 cardan 1/2"
- 1 poignée coulissante 1/2" 305 mm
- 1 cliquet réversible 1/2" ⊗
- 1 pinces pour circlips intérieurs à becs droits ○ 180 mm
- 1 pinces pour circlips intérieurs à becs coudés ○ 170 mm
- 1 pinces pour circlips extérieurs à becs droits ● 175 mm
- 1 pinces pour circlips extérieurs à becs coudés ● 175 mm
- 1 Pince multiprise entrepassée 250 mm
- 1 pince - étau à becs droits 240 mm
- 1 Pince coupante diagonale à faible effort de coupe ⚡ 160 mm
- 1 pince à becs demi-ronds longs = 180 mm
- 1 Pince à becs demi-ronds longs ● 160 mm
- 2 burins nervurés 100-200 mm
- 1 marteau de mécanicien 300 g
- 1 maillet à embouts nylon, manche en bois Ø 35 mm
- 6 clés mâles 6 pans en T 2,5-3-4-5-6-8 mm
- 8 clés à fourches 6x7-8x9-10x11-12x13-14x15
16x17-18x19-20x22 mm
- 9 clés mâles 6 pans coudées ○ 1,5±10 mm
- 16 clés mixtes 6-7-8-9-10-11-12-13-14-15-16-17
18-19-20-21 mm
- 5 clés mixtes 22-24-27-30-32 mm
- 1 ciseaux d'électricien
- 1 Ciseaux multifonctions
- 1 Lime carrée demi-douce 200 mm
- 1 Lime plate demi-douce 200 mm
- 1 Lime triangulaire demi-douce 200 mm
- 1 Lime demi-ronde demi-douce 200 mm
- 1 lime ronde demi-douce 200 mm
- 1 monture de scie à métaux
- 1 lames de scies
- 1 cutter à lame sécable 18 mm avec lames 170 mm
- 1 185 mm

Réf. Beta	TR
1260	T199
1262	T202
920A	T83
920/21	T83
920/22	T83
920/25	T83
920/42	T83
920/55	T83
1032	T145
1034	T145
1036	T145
1038	T145
1048N	T153
1052	T153
1084	T138
1150	T138
1166	T138
35	T234
1370	T234
1390	T234
951	T68
55	T33
96/SC9	T33
42	T05
42	T06
1128BMX	T284
1130BMX	T284
1719BMA...Q	T284
1719BMA...P	T284
1719BMA...T	T284
1719BMA...M	T284
1719BMA...R	T284
1726BM	T284
1728BM	T284
1771BM	T284
1778V18	T284



T199 T202 T83



T145 T153 T138 T234



T68 T33 T05 T06



T284

CHF

5904VU/2T 2,100.00 059041070

Composition conseillée avec RSC24 - RSC24A - C37 - C39
RSC24L - RSC24L-CAB - C59 - C55 - RSC23T - RSC28 - C39SM - C39MD - C39T

5904VU/3T

Composition de 146 outils en plateaux thermoformés rigides en ABS

► Maintenance générale

Quantité/Description

- 16 clés mixtes 6+21 mm
- 5 clés mixtes 22 - 24 - 27 - 30 - 32 mm
- 5 chasses-goupilles Ø 2 - 3 - 4 - 5 - 6 mm
- 1 pointeau Ø 4 mm
- 12 clés à fourches 6x7 - 8x9 - 10x11 - 12x13 - 14x15 - 16x17 - 18x19 - 20x22 - 21x23 - 24x26 - 27x29 - 30x32 mm
- 9 clés mâles 6 pans coudées ○ 1,5 - 2 - 2,5 - 3 - 4 - 5 - 6 - 8 - 10 mm
- 6 clés mâles 6 pans à poignée en T ○ 2 - 2,5 - 3 - 4 - 5 - 6 mm
- 6 tournevis pour vis Torx® ⚙ T10-T15-T20-T25-T27-T30
- 5 douilles tournevis pour vis 6 pans creux carré femelle 1/2" ○ 5 - 6 - 8 - 10 - 12 mm
- 1 rallonge - 1/2" 125 mm
- 1 rallonge - 1/2" 255 mm
- 1 cardan 1/2"
- 1 poignée coulissante 1/2"
- 1 cliquet réversible 1/2" ⚙
- 19 douilles 6 pans avec carré conducteur femelle 1/2" ○ 10+24 - 26 - 27 - 30 - 32 mm
- 13 douilles 6 pans avec carré conducteur femelle 1/4" ○ 4-4,5-5-5,5-6-7-8-9-10-11-12-13-14 mm
- 6 douilles tournevis pour vis 6 pans creux carré femelle 1/4" ○ 2,5-3-4-5-6-8 mm
- 1 rallonge - 1/4" 50 mm
- 1 rallonge - 1/4" 150 mm
- 1 cardan avec carrés mâle et femelle 1/4"
- 1 poignée emmanchée avec carré mâle 1/4"
- 1 poignée coulissante avec carré mâle 1/4" 115 mm
- 1 cliquet réversible avec carré mâle 1/4" ⚙
- 1 pinces pour circlips intérieurs à becs droits ○ 180 mm
- 1 pinces pour circlips intérieurs à becs coudés ○ 170 mm
- 1 pinces pour circlips extérieurs à becs droits ● 175 mm
- 1 pinces pour circlips extérieurs à becs coudés ● 175 mm
- 1 pince à becs demi-ronds longs = 180 mm
- 1 Pince à becs demi-ronds longs ● 160 mm
- 1 Pince coupante diagonale à faible effort de coupe ≡ 160 mm
- 1 Pince multiprise entrepassée 250 mm
- 1 pince - étau à becs droits 240 mm
- 4 tournevis pour vis à fente ● 3x75 - 4x100 - 5,5x150 - 6,5x150 mm
- 3 Tournevis pour vis Pozidriv®-Supadriv® ⚙ PZ0 - PZ1 - PZ2
- 7 tournevis pour vis Torx® ⚙ T6-T7-T8-T9-T10-T15-T20
- 2 burins nervurés 100 - 200 mm
- 1 marteau de mécanicien 300 g
- 1 maillet à embouts nylon, manche en bois Ø 35 mm
- 5 limes demi-douces 200 mm

Réf. Beta	TR
42	T05
42	T06
31	T31
32	T31
55	T31
96N/SC9	T31
96T	T52
97TTX	T55
920ME	T80
920/21	T80
920/22	T80
920/25	T80
920/42	T80
920/55	T80
920A	T80
900	T91
900ME	T91
900/20	T91
900/21	T91
900/25	T91
900BG/30	T91
900/42	T91
900/55	T91
1032	T145
1034	T145
1036	T145
1038	T145
1150	T138
1166	T138
1084	T138
1048N	T153
1052	T153
1260	T198
1269PZ	T198
1267TX	T205
35	T234
1370	T234
1390	T234
1719BMA8/S5	T236



T05 T06 T31



T52 T55 T80



T91 T145 T138 T153



T198 T205 T234 T236

CHF

5904VU/3T 2,550.00 059041203

Composition conseillée avec RSC24 - RSC24A - C37 - C39
RSC24L - RSC24AXL - RSC24L-CAB - C59 - C55 - C39T - C39SM - C39MD - RSC23T - RSC28

5904VU/4T

composition de 197 outils en plateaux thermoformés rigides en ABS

► Maintenance générale

Quantité/Description

- 1 chasse-clous Ø 4 mm
- 1 chasse-goupilles Ø 4 mm
- 1 pointeau Ø 4 mm
- 54 jeu de 52 embouts avec entraînement hexagonal de 10 mm et 2 accessoires
- 17 clés mixtes 6-7-8-10-11-12-13-14-16-17-18-19-21-22-24-27-30 mm
- 7 clés polygonales contre - coudées 6x7-8x9-10x11-12x13-14x15-16x17-18x19 mm
- 19 douilles 6 pans avec carré conducteur femelle 1/2" ○ 10-11-12-13-14-15-16-17-18-19-20-21-22-23-24-26-27-30-32 mm
- 1 rallonge - 1/2" 125 mm
- 1 rallonge - 1/2" 250 mm
- 1 cardan 1/2"
- 1 poignée coulissante 1/2" 305 mm
- 1 cliquet réversible 1/2" ⊕
- 13 douilles 6 pans avec carré conducteur femelle 1/4" ○ 4-4,5-5-5,5-6-7-8-9-10-11-12-13-14 mm
- 6 douilles tournevis pour vis 6 pans creux carré femelle 1/4" ○ 2,5-3-4-5-6-8 mm
- 1 rallonge - 1/4" 50 mm
- 1 rallonge - 1/4" 150 mm
- 1 cardan avec carrés mâle et femelle 1/4"
- 1 poignée emmanchée avec carré mâle 1/4"
- 1 poignée coulissante avec carré mâle 1/4" 115 mm
- 1 cliquet réversible avec carré mâle 1/4" ⊕
- 1 Pince coupante diagonale 160 mm
- 1 pince à becs demi-ronds longs 180 mm
- 1 Pince multiprise entrepassée 250 mm
- 7 tournevis pour vis à fente ● 2,5x50 - 3x75 - 3,5x100 - 4x125 - 5,5x100 - 5,5x150 - 6,5x150 mm
- 6 tournevis pour vis phillips® ⊕ PH0x60 - PH1x80 - PH1x120 - PH2x100 - PH2x150 - PH3x150 mm
- 2 tournevis pour vis torx® ⊕ T6-T7-T8-T9-T10-T15-T20
- 7 burins nervurés 100-200 mm
- 1 marteau de mécanicien 300 g
- 1 maillet à embouts nylon, manche en bois Ø 35 mm
- 7 clé mâle 6 pans coudée à tête sphérique, brunie ○ 2,5-3-4-5-6-8-10 mm
- 1 clés mâles 6 pans coudées ○ 12 mm
- 31 coffret de 31 pièces ● ○ ⊕ ⊕ ⊕
- 1 douille porte-embouts

Réf. Beta	TR
	30
	31
	32
867/C52	
42	T01
90	T40
920A	T83
920/21	T83
920/22	T83
920/25	T83
920/42	T83
920/55	T83
900	T91
900ME	T91
900/20	T91
900/21	T91
900/25	T91
900BG/30	T91
900/42	T91
900/55	T91
1082	T156
1150	T156
1048N	T156
1201E	T211
1202E	T213
1207E/TX	T216
35	T234
1370	T234
1390	T234
96BP	T259
96N	T259
860MIX/A31	T259
895/1	T259



T01

T83



T91

T156

T40

T211



T213

T216

T234

T259

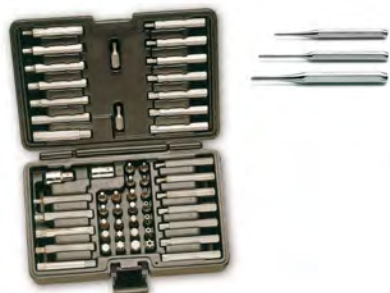

CHF

5904VU/4T

1,975.00 059241100

Composition conseillée avec RSC23T - RSC24 - RSC24A - RSC24AXL - RSC24L - RSC24L-CAB - C37 - C39 - C39T - C39SM - C39MD - RSC55 - C59

5908VU/2T

composition de 161 outils en plateaux thermoformés rigides en ABS

► Maintenance générale

Quantité/Description



T05 T06 T31



T40 T52 T55 T91



T82 T138 T153



T145 T170 T171 T172



T173 T234 T236 VP4

- 16 clés mixtes 6+21 mm
- 5 clés mixtes 22 - 24 - 27 - 30 - 32 mm
- 5 chasse-goupilles Ø 2 - 3 - 4 - 5 - 6 mm
- 1 pointe Ø 4 mm
- 12 clés à fourches 6x7 - 8x9 - 10x11 - 12x13 - 14x15 - 16x17 - 18x19 - 20x22 - 21x23 - 24x26 - 27x29 - 30x32 mm
- 9 clés mâles 6 pans coudées Ø 1,5 - 2 - 2,5 - 3 - 4 - 5 - 6 - 8 - 10 mm
- 7 clés polygonales contre - coudées 6x7-8x9-10x11-12x13-14x15-16x17-18x19 mm
- 6 clés mâles 6 pans à poignée en T Ø 2-2,5-3-4-5-6 mm
- 6 tournevis pour vis Torx® ⚫ T10-T15-T20-T25-T27-T30
- 19 douilles 6 pans avec carré conducteur femelle 1/2" ⚫ 10-11-12-13-14-15-16-17-18-19-20-21-22-23-24-26-27-30-32 mm
- 5 douilles tournevis pour vis 6 pans creux carré femelle 1/2" ⚫ 5-6-8-10-12 mm
- 1 rallonge angulaire - 1/2" 125 mm
- 1 rallonge angulaire - 1/2" 250 mm
- 1 cardan 1/2"
- 1 poignée coulissante 1/2" 305 mm
- 1 cliquet réversible 1/2" ⚫
- 13 douilles 6 pans avec carré conducteur femelle 1/4" ⚫ 4-4,5-5-5,5-6-7-8-9-10-11-12-13-14 mm
- 6 douilles tournevis pour vis 6 pans creux carré femelle 1/4" ⚫ 2,5-3-4-5-6-8 mm
- 1 rallonge - 1/4" 50 mm
- 1 rallonge - 1/4" 150 mm
- 1 cardan avec carrés mâle et femelle 1/4"
- 1 poignée emmanchée avec carré mâle 1/4"
- 1 poignée coulissante avec carré mâle 1/4" 115 mm
- 1 cliquet réversible avec carré mâle 1/4" ⚫
- 1 Pince coupante diagonale à faible effort de coupe 160 mm
- 1 pince à becs demi-ronds longs 180 mm
- 1 Pince à becs demi-ronds longs 160 mm
- 1 pinces pour circlips intérieurs à becs droits ⚫ 180 mm
- 1 pinces pour circlips intérieurs à becs coudés ⚫ 170 mm
- 1 pinces pour circlips extérieurs à becs droits ⚫ 175 mm
- 1 pinces pour circlips extérieurs à becs coudés ⚫ 175 mm
- 1 Pince multiprise entrepassée 250 mm
- 1 pince - étau à becs droits 240 mm
- 7 tournevis pour vis Phillips® ⚫ 2,5x50-3x75-3,5x100-4x125-5,5x100-5,5x150-6,5x150 mm
- 3 tournevis pour vis Phillips® ⚫ 8x150-8x200-10x200 mm
- 2 tournevis à lame courte pour vis à fente ⚫ 4x30-6,5x30 mm
- 6 tournevis pour vis Phillips® ⚫ PH0x60-PH0x100-PH1x80-PH1x120-PH2x100-PH2x150 mm
- 2 tournevis pour vis Phillips® ⚫ PH3x150-PH4x200 mm
- 2 tournevis à lame courte pour vis Phillips® ⚫ PH1x30-PH2x30 mm
- 2 burins nervurés 100-200 mm
- 1 marteau de mécanicien 300 g
- 1 maillet à embouts nylon, manche en bois Ø 35 mm
- 1 Lime carrée demi-douce 200 mm
- 1 Lime triangulaire demi-douce 200 mm
- 1 Lime plate demi-douce 200 mm
- 1 Lime demi-ronde demi-douce 200 mm
- 1 lime ronde demi-douce 200 mm
- 1

Réf. Beta	TR
42	T05
42	T06
31	T31
32	T31
55	T31
96N/SC9	T31
90	T40
96T	T52
97TTX	T55
920A	T82
920ME	T82
920AN/125	T82
920AN/250	T82
920/25	T82
920/42	T82
920/55	T82
900	T91
900ME	T91
900/20	T91
900/21	T91
900/25	T91
900BG/30	T91
900/42	T91
900/55	T91
1084	T138
1150	T138
1166	T138
1032	T145
1034	T145
1036	T145
1038	T145
1048N	T153
1052	T153
1290	T170
1290	T171
1290N	T171
1292	T172
1292	T173
1292N	T173
35	T234
1370	T234
1390	T234
1719BMA...Q	T236
1719BMA...T	T236
1719BMA...P	T236
1719BMA...M	T236
1719BMA...R	T236
VP4	T236

CHF

5908VU/2T 2,910.00 059081136

Composition conseillée avec RSC23T - RSC24 à 6-7-8 tiroirs - RSC24A - RSC24AXL - RSC24L - RSC24L-CAB - RSC28 C37 à 6-7-8 tiroirs - C39 à 6-7-8 tiroirs - C39MD - C39SM - C59 - RSC55

5914VU/M

Assortiment comprenant 109 outils en module mousse pour coffre porte-outils C14.

► Maintenance générale

Quantité/Description

- 31 coffret de 31 pièces ● ○ ⊕ ⊕ ⊕
- 1 douille porte-embouts
- 13 douilles 6 pans avec carré conducteur femelle 1/4" ○ 4-4,5-5-5,5-6-7-8-9-10-11-12-13-14 mm
- 1 rallonge - 1/4" 150 mm
- 1 cardan avec carrés mâle et femelle 1/4"
- 1 poignée emmanchée carré mâle 1/4"
- 1 poignée coulissante avec carré mâle 1/4"
- 1 cliquet réversible avec carré mâle 1/4" ⊕
- 16 douilles 6 pans avec carré conducteur femelle 1/2" ○ 10-11-12-13-14-15-16-17-18-19-21-22-24-27-30-32 mm
- 1 cardan 1/2"
- 1 rallonge angulaire - 1/2"
- 1 poignée coulissante 1/2"
- 1 cliquet réversible 1/2" ⊕
- 16 clés mixtes 6-7-8-9-10-11-12-13-14-15-16-17-18-19-21-22 mm
- 9 clés mâles 6 pans coudées ○
- 1 Clé à molette à ouverture graduée, chromée 250 mm
- 1 ciseaux d'électricien
- 1 mètre à ruban 5 mt
- 1 cutter à lame sécable 18 mm avec lames
- 1 Pince multiprise entrepassée 250 mm
- 1 Pince coupante diagonale 160 mm
- 1 pince à becs demi-ronds longs = 180 mm
- 1 Pince à becs demi-ronds longs ● 160 mm
- 3 tournevis pour vis à fente ● 3,5x100-5,5x125-6,5x150 mm
- 3 tournevis pour vis Phillips® ⊕ PH0x60-PH1x80-PH2x100 mm

Réf. Beta	TR
860MIX/A31	MCT1
895/1	MCT1
900	MCT1
900/...	MCT1
900/25	MCT1
900BG/30C	MCT1
900/42	MCT1
900/55	MCT1
920A	MCT1
920/25	MCT1
920AN/125	MCT1
920/42	MCT1
920/55	MCT1
42	MCT2
96/SC9	MCT2
111E	MCT2
1128BMX	MCT2
1692/5	MCT2
1771	MCT2
1048N	MCT3
1082BM	MCT3
1150BM	MCT3
1166BM	MCT3
1260	MCT3
1262	MCT3



MC T1



MC T2



MC T3

CHF

5914VU/M

1,400.00 059140112

Assortiment recommandé avec le coffre porte-outils C14

NB : Pour une fermeture correcte du module supérieur, le panneau à outils placé sous le couvercle doit être retiré.

5988U/7M

Composition de 215 outils en plateaux mousse compacte

► Maintenance générale



M01



M100

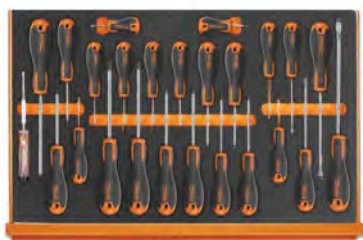

M213



M33 M86 M136 M234

Quantité/Description

Quantité/Description	Réf. Beta	TR
22 clés mixtes 6-7-8-9-10-11-12-13-14-15-16-17-18-19-20-21-22-24-27-30-32-36 mm	42	M01
8 clés à fourches 6x7-8x9-10x11-12x13-14x15-16x17-18x19-20x22 mm	55	M33
9 clés mâles 6 pans coudées Ø 1,5÷10 mm	96SC9	M33
7 embout avec entraînement hexagonal Ø 4-5-6-7-8-10-12 mm	867PE	M86
7 embout avec entraînement hexagonal Ø 4-5-6-7-8-10-12 mm	867PEL	M86
5 embout avec entraînement hexagonal Ø 5-6-8-10-12 mm	867XZN	M86
5 embout avec entraînement hexagonal Ø 5-6-8-10-12 mm	867XZNL	M86
7 embout avec entraînement hexagonal T20-T25-T30-T40-T45-T50-T55	867TX	M86
6 embout avec entraînement hexagonal T25-T30-T40-T45-T50-T55	867TXL	M86
7 Embout avec entraînement hexagonal Tamper Resistant Torx® Ⓢ T20-T25-T30-T40-T45-T50-T55	867RTX	M86
1 douille porte-embouts pour 867	867/1	M86
1 douille porte-embouts pour 867	867/2	M86
1 douille porte-embouts	895/1	M100
1 douille porte-embouts	895/3	M100
1 douille porte-embouts	895/6	M100
13 douilles 6 pans avec carré conducteur femelle 1/4" Ø 4-4,5-5-5,5-6-7-8-9-10-11-12-13-14 mm	900	M100
9 douille 6 pans série longue Ø 5-6-7-8-9-10-11-12-13 mm	900L	M100
5 douilles tournevis pour vis 6 pans creux carré femelle 1/4" Ø 3-4-5-6-7 mm	900ME	M100
4 douille tournevis pour vis à fente Ø 0,8x4-1x5,5-1,2x6,5-1,2x8 mm	900LP	M100
4 douille tournevis pour vis Phillips® Ⓢ PH1-PH2-PH3-PH4	900PH	M100
7 douille tournevis pour vis Torx® Ⓢ T10-T15-T20-T25-T27-T30-T40	900TX	M100
1 rallonge - 1/4" 50 mm	900/20	M100
1 rallonge - 1/4" 100 mm	900/20L	M100
1 rallonge - 1/4" 150 mm	900/21	M100
1 cardan avec carrés mâle et femelle 1/4"	900/25	M100
1 poignée emmanchée avec carré mâle 1/4"	900BG/30	M100
1 poignée coulissante avec carré mâle 1/4"	900/42	M100
1 cliquet réversible avec carré mâle 1/4" Ⓢ	900/55	M100
21 douilles 6 pans avec carré conducteur femelle 1/2" Ø 8-10-11-12-13-14-15-16-17-18-19-20-21-22-23-24-26-27-28-30-32 mm	920A	M100
1 réducteur carré femelle 1/2" et mâle 3/8"	920/15	M100
1 cardan 1/2"	920/25	M100
1 rallonge angulaire - 1/2" 125 mm	920AN/125	M100
1 rallonge angulaire - 1/2" 250 mm	920AN/250	M100
1 poignée coulissante 1/2"	920/42	M100
1 cliquet réversible 1/2" Ⓢ	920/55	M100
8 douilles pour écrous à empreinte Torx®, 1/2" Ø 10-12-14-16-18-20-22-24 mm	920FTX	M100
11 douille 6 pans série longue Ø 10-12-13-14-15-16-17-18-19-21-22	920AL	M100
1 Pince coupante diagonale à faible effort de coupe 160 mm	1084BM	M136
1 pince à becs demi-ronds longs 180 mm	1150BM	M136
1 Pince à becs demi-ronds longs 160 mm	1166BM	M136
6 tournevis pour vis à fente Ø 2,5x50-3x75-4x100-5,5x125-6,5x150-8x200 mm	1201E	M213
1 tournevis à lame courte pour vis à fente Ø 4x30 mm	1201EN	M213
4 tournevis pour vis phillips® Ⓢ PH0x60-PH1x80-PH2x100-PH3x150 mm	1202E	M213
1 tournevis à lame courte pour vis phillips® Ⓢ PH1X30 mm	1202EN	M213
12 tournevis pour vis torx® Ⓢ T6-T7-T8-T9-T10-T15-T20-T25-T27-T30-T40-T45	1207E/TX	M213
1 tournevis détecteur de tension Ⓢ	1253	M213
2 burins nervurés 100-200 mm	35	M234
1 marteau de mécanicien 300 g	1370	M234
1 maillet à embouts nylon, manche en bois Ø 35 mm	1390	M234

CHF

5988U/7M 2,930.00 059881019

Composition conseillée avec RSC23T - RSC24 - RSC24A - RSC24AXL - RSC24L - RSC24L-CAB - RSC28 - C37 - C39 - C39SM - C39MD - RSC55 - C59

5915VU/0

Composition de 35 outils

► Maintenance générale

Quantité/Description

Quantité/Description	Réf. Beta
1 pointeau 4 mm	32
1 burins nervurés 125 mm	35
8 clés à fourches 6x7-8x9-10x11-12x13-14x15-16x17-18x19-20x22 mm	55
7 Clé mâle 6 pans \odot 1,5-2-2,5-3-4-5-6 mm	96/BGS7
1 Clé à molette à ouverture graduée, chromée 150 mm	111E
1 Pince multiprise entrepassée 250 mm	1048N
1 pince coupante diagonale, branches gainées avec double couche de PVC antidérapant, finition industrielle \angle 160 mm	1082G
1 ciseaux d'électricien	1128BMX
1 pince universelle, branches gainées avec double couche de PVC antidérapant, modèle grande capacité, finition industrielle \equiv 180 mm	1150G
1 pince à becs demi-ronds longs striés, branches gainées avec double couche de PVC antidérapant, finition industrielle \bullet 160 mm	1166G
4 tournevis pour vis à fente \bullet 3x75-4x100-5,5x100-6,5x150 mm	1201E
3 tournevis pour vis phillips® \oplus PH0x60-PH1x80-PH2x100 mm	1202E
1 marteau de mécanicien 300 g	1370
1 mètre à ruban 3 m	1692/3
1 cutter à lame sécable 18 mm avec lames 18 mm	1771
1 couteau de survie auto	1778SOS
1 torche LED à haute luminosité, en aluminium anodisé renforcé, jusqu'à 500 Lumens	1833S



CHF



5915VU/0

518.00 059151021

Composition conseillée avec C4 - C5 - C5S - C6T

5915VU/1

Composition de 45 outils

► Maintenance générale

Quantité/Description

Quantité/Description	Réf. Beta
2 chasse-clous \varnothing 2-3 mm	30
1 pointeau \varnothing 4 mm	32
2 burins plats 125-150 mm	34
1 bédanes 150 mm	36
14 clés mixtes 6+14 - 17 - 19 - 21 - 22 - 24 mm	42
9 clés mâles 6 pans coudées \odot 1,5 - 2 - 2,5 - 3 - 4 - 5 - 6 - 8 - 10 mm	96/SC9
1 Clé à molette à ouverture graduée, chromée 250 mm	111E
1 Pince multiprise entrepassée 250 mm	1048N
1 pince coupante diagonale, branches gainées avec double couche de PVC antidérapant, finition industrielle \angle 160 mm	1082G
1 ciseaux d'électricien	1128BMX
1 pince universelle, branches gainées avec double couche de PVC antidérapant, modèle grande capacité, finition industrielle \equiv 180 mm	1150G
1 pince à becs demi-ronds longs striés, branches gainées avec double couche de PVC antidérapant, finition industrielle \bullet 160 mm	1166G
4 tournevis pour vis à fente \bullet 3x75 - 4x100 - 5,5x100 - 6,5x150 mm	1201E
3 tournevis pour vis phillips® \oplus PH0x60 - PH1x80 - PH2x100 mm	1202E
1 marteau de mécanicien 300 g	1370
1 mètre à ruban 5 m	1692
1 cutter à lame sécable 18 mm avec lames	1771



CHF



5915VU/1

629.00 059151024

Composition conseillée avec C8 - C9 - C10 - C10S - C11 - CP15 - CP15L - C16 - CP17 - CP17L - C18



5915VU/2

Composition de 49 outils

► Maintenance générale

Quantité/Description

- 8 6x7 - 8x9 - 10x11 - 12x13 - 14x15
16x17 - 18x19 - 20x22 mm
- 9 clés mâles 6 pans coudées \odot 1,5 - 2 - 2,5 - 3 - 4 - 5 - 6 - 8 - 10 mm
- 13 douilles 6 pans avec carré conducteur femelle 1/4" \odot 4 - 4,5 - 5 - 5,5 - 6 - 7 - 8 - 9 - 10 - 11 - 12 - 13 - 14 mm
- 1 rallonge - 1/4" 150 mm
- 1 cardan avec carrés mâle et femelle 1/4"
- 1 poignée emmanchée avec carré mâle 1/4"
- 1 poignée coulissante avec carré mâle 1/4"
- 1 cliquet réversible avec carré mâle 1/4" \oplus
- 1 Pince multiprise entrepassée 250 mm
- 1 ciseaux d'électricien
- 1 pince universelle, branches gainées avec double couche de PVC antidérapant, modèle grande capacité, finition industrielle \equiv 180 mm
- 4 tournevis pour vis à fente \bullet 3x75 - 4x100 - 5,5x150 - 6,5x150 mm
- 3 tournevis pour vis phillips® \oplus PH0x60 - PH1x80 - PH2x100 mm
- 1 marteau de mécanicien 300 g
- 1 mètre à ruban 3 m
- 1 Etui de 10 lames sécables 18 mm, pour 1771 et 1771BM, 1771HD
- 1 cutter à lame sécable 18 mm avec lames 18 mm

- | Réf. Beta |
|-----------|
| 55/B8N |
| 96/SC9 |
| 900 |
| 900/21 |
| 900/25 |
| 900BG/30 |
| 900/42 |
| 900/55 |
| 1048N |
| 1128BMX |
| 1150G |
| 1201E |
| 1202E |
| 1370 |
| 1692 |
| 1771RL |
| 1771 |

CHF

5915VU/2 548.00 059151027

Composition conseillée avec C7 - CP15 - C20 - C20L



5915VU/3

Composition de 74 outils

► Maintenance générale

Quantité/Description

- 1 chasse-goupilles \varnothing 4 mm
- 1 pointeau \varnothing 4 mm
- 1 burin plats 150 mm
- 14 clés mixtes 6-7-8-10-11-12-13-14-15-16-17-19-22-24 mm
- 9 clés mâles 6 pans coudées \odot 1,5+10 mm
- 3 clés mâles 6 pans à poignée en T \odot 4 - 5 - 6 mm
- 1 Clé à molette à ouverture graduée, chromée 250 mm
- 13 douilles 6 pans avec carré conducteur femelle 1/2" \odot 8+17 - 19 - 22 - 24 mm
- 1 rallonge - 1/2" 125 mm
- 1 rallonge - 1/2" 255 mm
- 1 cardan 1/2"
- 1 poignée coulissante 1/2"
- 1 cliquet réversible 1/2" \oplus
- 8 clés en tube droite 6 pans, série légère 6x7 - 8x9 - 10x11 - 12x13 - 14x15 - 16x17 - 18x19 - 20x22 mm
- 2 broches pour articles 930 - 935
- 1 Pince multiprise entrepassée 250 mm
- 1 pince - étau à becs droits 240 mm
- 1 pince coupante diagonale à faible effort de coupe, branches gainées avec double couche de PVC antidérapant, finition industrielle ∇ 160 mm
- 1 ciseaux d'électricien
- 1 pince universelle, branches gainées avec double couche de PVC antidérapant, modèle grande capacité, finition industrielle \equiv 180 mm
- 1 pince à becs demi-ronds longs striés, branches gainées avec double couche de PVC antidérapant, finition industrielle \bullet 160 mm
- 4 tournevis pour vis à fente \bullet 3x75 - 4x100 - 5,5x150 - 6,5x150 mm
- 3 tournevis pour vis phillips® \oplus PH0x60 - PH1x80 - PH2x100 mm
- 1 marteau de mécanicien 400 g
- 1 mètre à ruban 5 m
- 1 monture de scie à métaux
- 1 burette plastique 150 cc
- 1 cutter à lame sécable 18 mm avec lames

- | Réf. Beta |
|-----------|
| 31 |
| 32 |
| 34 |
| 42 |
| 96/SC9 |
| 96T |
| 111E |
| 920A |
| 920/21 |
| 920/22 |
| 920/25 |
| 920/42 |
| 920/55 |
| 935 |
| 940 |
| 1048VN |
| 1052 |
| 1084G |
| 1128BMX |
| 1150G |
| 1166G |
| 1201E |
| 1202E |
| 1370 |
| 1692 |
| 1726 |
| 1754 |
| 1771 |

CHF

5915VU/3 1,163.00 059151028

Composition conseillée avec C7 - C9 - C10 - C10S - C11 - CP15L - C16 - CP17 - CP17L - C19 - C19L - C20 - C20L

5915VU/4

Composition de 80 outils

► Maintenance générale

Quantité/Description

- 1 chasse-goupilles Ø 4 mm
- 1 pointeau Ø 4 mm
- 1 burins plats 150 mm
- 15 clés mixtes 6-7-8-9-10-11-12-13-14-15-16-17-19-22-24 mm
- 9 clés mâles 6 pans coudées \odot 1,5+10 mm
- 1 Clé à molette à ouverture graduée, chromée 250 mm
- 13 douilles 6 pans avec carré conducteur femelle 1/2" \odot 8+17 - 19 - 22 - 24 mm
- 1 rallonge - 1/2" 255 mm
- 1 cardan 1/2"
- 1 poignée coulissante 1/2"
- 1 cliquet réversible 1/2" \oplus
- 17 clés à pipe débouchées 6 et 12 pans gros effort 6+22 mm
- 1 Pince multiprise entrecroisée 250 mm
- 1 pince - étou à becs droits 240 mm
- 1 pince coupante diagonale à faible effort de coupe, branchées gainées confort bi-matériaux, finition industrielle \nlessgtr 160 mm
- 1 ciseaux d'électricien
- 1 pince universelle, branches gainées confort bi-matériaux, modèle grande capacité, finition industrielle \equiv 180 mm
- 1 pince à becs demi-ronds longs striés, branches gainées confort bi-matériaux, finition industrielle \bullet 160 mm
- 4 tournevis pour vis à fente \bullet 3x75 - 4x100 - 5,5x150 - 6,5x150 mm
- 3 tournevis pour vis phillips® \oplus PH0x60 - PH1x80 - PH2x100 mm
- 1 marteau de mécanicien tête rivoir 32 mm
- 1 mètre à ruban 5 m
- 1 monture de scie à métaux
- 1 burette plastique 150 cc
- 1 cutter à lame sécable 18 mm avec lames

Réf. Beta

- 31
- 32
- 34
- 42
- 96/SC9
- 111E
- 920A
- 920/22
- 920/25
- 920/42
- 920/55
- 932/S17
- 1048N
- 1052
- 1084GBM
- 1128BMX
- 1150GBM
- 1166GBM
- 1201E
- 1202E
- 1370F
- 1692
- 1726
- 1754
- 1771

CHF



5915VU/4

1,505.00 059151045

Composition conseillée avec C20 - C20L

5915VU/5

Composition de 111 outils

► Maintenance générale

Quantité/Description

- 1 chasse-goupilles Ø 4 mm
- 1 pointeau Ø 4 mm
- 1 burins plats 150 mm
- 17 clés mixtes 6-7-8-9-10-11-12-13-14-15-16-17-18-19-20-21-22 mm
- 8 clés à fourches 6x7-8x9-10x11-12x13-14x15-16x17-18x19-20x22 mm
- 9 clés mâles 6 pans coudées à tête sphérique \odot
- 1 Clé à molette à ouverture graduée, chromée 250 mm
- 39 11 douilles 6 pans, 20 embouts pour visseuses et 8 accessoires
- 13 11 douilles et 2 accessoires
- 1 Pince multiprise entrecroisée 250 mm
- 1 pince - étou à becs droits 240 mm
- 1 pince coupante diagonale, branches gainées avec double couche de PVC antidérapant, finition industrielle \nlessgtr 160 mm
- 1 Tenaille type russe 220 mm
- 1 ciseaux d'électricien
- 1 pince universelle, branches gainées avec double couche de PVC antidérapant, modèle grande capacité, finition industrielle \equiv 180 mm
- 1 pince à becs demi-ronds longs striés, branches gainées avec double couche de PVC antidérapant, finition industrielle \bullet 160 mm
- 4 tournevis pour vis à fente \bullet 3x75 - 4x100 - 5,5x100 - 6,5x150 mm
- 3 tournevis pour vis phillips® \oplus PH0x60 - PH1x80 - PH2x100 mm
- 1 marteau de mécanicien 300 g
- 1 maillet à embouts nylon, manche en bois Ø 35 mm
- 1 mètre à ruban 3 m
- 1 limes demi-douces
- 1 monture de scie à métaux 440 mm
- 1 cutter à lame sécable 18 mm avec lames 18 mm
- 1 torche LED d'inspection, en aluminium anodisé renforcé

Réf. Beta

- 31
- 32
- 34
- 42
- 55/S8
- 96BPC/SC9
- 111E
- 900/C11
- 920A/C11
- 1048N
- 1052
- 1082G
- 1098
- 1128BMX
- 1150G
- 1166G
- 1201E
- 1202E
- 1370
- 1390
- 1692/3
- 1719BMA8/M
- 1726
- 1771BM
- 1833XS/2

CHF



5915VU/5

1,475.00 059151046

Composition conseillée avec C12 - C41S - C41H - C42S - C42H

5915VU/AS

Composition de 68 outils

► Maintenance générale

Quantité/Description

- 1 chasse-goupilles Ø 4 mm
- 1 pointeau Ø 4 mm
- 1 burins plats 150 mm
- 13 clés mixtes 1/4 - 5/16 - 3/8 - 7/16 - 1/2 - 9/16 - 5/8 - 11/16 - 3/4 - 13/16 - 7/8 - 15/16 - 1"
- 8 clés polygonales contre - coudées 1/4"+1"
- 9 \bigcirc 3/64"+3/8"
- 1 Clé à molette à ouverture graduée, chromée 250 mm
- 11 douilles 12 pans 1/2" \bigcirc 3/8 - 7/16 - 1/2 - 9/16 - 5/8 - 11/16 - 3/4 - 13/16 - 7/8 - 15/16 - 1"
- 1 rallonge - 1/2" 125 mm
- 1 rallonge - 1/2" 255 mm
- 1 cardan 1/2"
- 1 poignée coulissante 1/2"
- 1 cliquet réversible 1/2" \oplus
- 1 Pince multiprise entrepassée 250 mm
- 1 pince - étau à becs droits 240 mm
- 1 pince coupante diagonale à faible effort de coupe, branchées gainées confort bi-matières, finition industrielle \llcorner 160 mm
- 1 ciseaux d'électricien
- 1 pince universelle, branches gainées confort bi-matières, modèle grande capacité, finition industrielle \equiv 180 mm
- 1 pince à becs demi-ronds longs striés, branches gainées confort bi-matières, finition industrielle \bullet 160 mm
- 4 tournevis pour vis à fente \bullet 3x75 - 4x100 - 5,5x150 - 6,5x150 mm
- 3 tournevis pour vis phillips® \oplus PH0x60 - PH1x80 - PH2x100 mm
- 1 marteau de mécanicien 300 g
- 1 mètre à ruban 5 m
- 1 monture de scie à métaux
- 1 burette plastique 150 cc
- 1 cutter à lame sécable 18 mm avec lames

Réf. Beta
31
32
34
42AS
90AS/8
96AS/SC9
111E
920AS
920/21
920/22
920/25
920/42
920/55
1048N
1052
1084GBM
1128BMX
1150GBM
1166GBM
1201E
1202E
1370
1692
1726
1754
1771

CHF

5915VU/AS 1,280.00 059151032

Composition conseillée avec C10 - C20 - C20L



5927VU/M

Composition de 108 outils en plateaux mousse compacte

► Maintenance générale

Quantité/Description

- 16 clés mixtes 6-7-8-9-10-11-12-13-14-15-16-17-18-19-21-22 mm
- 1 Pince coupante diagonale à faible effort de coupe \llcorner 160 mm
- 9 clés mâles 6 pans coudées \bigcirc 1,5-2-2,5-3-4-5-6-8-10 mm
- 1 pince à becs demi-ronds longs \equiv 180 mm
- 1 Pince à becs demi-ronds longs \bullet 160 mm
- 3 tournevis pour vis à fente \bullet 3,5x100-5,5x150-6,5x150 mm
- 3 tournevis pour vis phillips® \oplus PH0x3x60-PH1x4,5x80-PH2x6x100 mm
- 31 coffret de 31 pièces \bullet \bigcirc \oplus \oplus \oplus
- 1 Pince multiprise entrepassée 250 mm
- 1 marteau de mécanicien 300 mm
- 1 pointeau 4 mm
- 1 bédanes 4 mm
- 13 douilles 6 pans avec carré conducteur femelle 1/4" \bigcirc 4-4,5-5-5,5-6-7-8-9-10-11-12-13-14 mm
- 1 rallonge - 1/4" 150 mm
- 1 cardan avec carrés mâle et femelle 1/4"
- 1 poignée emmanchée carré mâle 1/4"
- 1 poignée coulissante avec carré mâle 1/4"
- 1 cliquet réversible avec carré mâle 1/4" \oplus
- 16 douilles 6 pans avec carré conducteur femelle 1/2" \bigcirc 10-11-12-13-14-15-16-17-18-19-21-22-24-27-30-32 mm
- 1 cardan 1/2"
- 1 rallonge angulaire - 1/2" 125 mm
- 1 poignée coulissante avec carré mâle 1/4"
- 1 cliquet réversible 1/2" \oplus
- 1 douille porte-embouts

Réf. Beta	TR
42	MC10
1084BM	MC10
96/SC9	MC10
1150BM	MC10
1166BM	MC10
1201E	MC10
1202E	MC10
860MIX/A31	MC20
1048N	MC20
1370	MC20
32	MC20
36	MC20
900	MC20
900/21	MC20
900/25	MC20
900BG/30C	MC20
900/42	MC20
900/55	MC20
920A	MC20
920/25	MC20
920AN/125	MC20
900/42	MC20
920/55	MC20
895/1	MC20

CHF

5927VU/M 1,260.00 059271021

Composition conseillée avec RSC22 - C27S - RSC23 - RSC23C



VP-LS

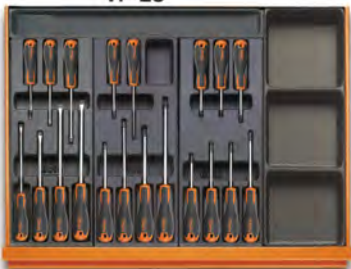

T211 T213 T216 VP3-SC
VP-LS



T145 T153 T137 VP3-SC
VP-LD VP-LD



T85



T234 T294

VP-LS



T80 T239 VP3-SC
VP-LS



T01 T33 VP3-SC
VP-LD VP-LD



T68 T236



T50

5938U/2T

Composition de 210 outils en plateaux thermoformés rigides en ABS

► Maintenance générale

Quantité/Description

- 7 tournevis pour vis à fente ● 2,5x50 - 3x75 - 3,5x100 - 4x125
5,5x100 - 5,5x150 - 6,5x150 mm
- 6 tournevis pour vis phillips® ⊕ PH0x60-PH1x80-PH1x120-PH2x100-PH2x150-PH3x150 mm
- 7 tournevis pour vis torx® ⊖ T6-T7-T8-T9-T10-T15-T20

Réf. Beta	TR
1201E	T211
1202E	T213
1207E/TX	T216

- 1 pinces pour circlips intérieurs à becs droits ○ 180 mm
- 1 pinces pour circlips intérieurs à becs coudés ○ 170 mm
- 1 pinces pour circlips extérieurs à becs droits ● 175 mm
- 1 pinces pour circlips extérieurs à becs coudés ● 175 mm
- 1 Pince multiprise entrepassée 250 mm
- 1 pince - étau à becs droits 240 mm
- 1 Pince coupante diagonale à faible effort de coupe ⚡ 160 mm
- 1 pince à becs demi-ronds longs ≡ 180 mm
- 1 Pince à becs demi-ronds longs ● 160 mm
- 1 clé à cliquet réversible porte-embouts 1/4x5/16
- 13 douilles 6 pans avec carré conducteur femelle 1/4" ○ 4-4,5-5-5,5-6-7-8-9-10-11-12-13-14 mm
- 1 cliquet réversible avec carré mâle 1/4" ⊕ 125 mm
- 1 poignée coulissante avec carré mâle 1/4" 115 mm
- 1 poignée emmanchée avec carré mâle 1/4" 176 mm
- 1 cardan avec carrés mâle et femelle 1/4" 41 mm
- 1 rallonge - 1/4" 150 mm
- 1 Poignée porte-embouts à bague de déverrouillage rapide 230 mm
- 5 embout pour visseuses pour vis Spanner ⊕ 4-6-8-10-12 mm
- 8 embout pour visseuses pour vis Torq-Set® ⊕ 0-1-2-3-4-5-6-8 mm
- 6 embout pour visseuses pour vis Tri-Wing® ⊕ 1-2-3-4-5-6 mm
- 8 embout pour visseuses pour vis à Tamper Resistant Torx® ⊖ T9-T10-T15-T20-T25-T27-T30-T40
- 11 embouts de visseuse pour vis à empreinte Torx® ⊖ T6-T7-T8-T9-T10-T15-T20-T25-T27-T30-T40
- 3 Embout pour visseuses pour vis Pozidriv® -Supadriv® ⊕ PZ1 - PZ2 - PZ3
- 4 Embout pour visseuses pour vis Phillips® ⊕ PH0 - PH1 - PH2 - PH3
- 8 Embout pour visseuses pour vis 6 pans creux ○ 2 - 2,5 - 3 - 4 - 5 - 6 - 8 - 10 mm
- 7 Embout pour visseuses pour vis à fente ● 0,5x3 - 0,6x4,5 - 0,8x5,5 - 1x5,5 - 1,2x6,5 - 1,2x8 - 1,6x8 mm
- 2 burins nervurés 100 - 200 mm
- 1 marteau de mécanicien 300 g
- 1 maillet à embouts nylon, manche en bois Ø 35 mm
- 1 mètre à ruban 5 m
- 1 mini - monture de scie à métaux
- 1 Etui de 10 lames sécables 18 mm, pour 1771 et 1771BM, 1771HD
- 1 cutter à lame sécable 18 mm avec lames
- 19 douilles 6 pans avec carré conducteur femelle 1/2" ○ 10 - 11 - 12+19 - 20 - 21 - 22 - 23 - 24 - 26 - 27 - 30 - 32 mm
- 5 douilles tournevis pour vis 6 pans creux carré femelle 1/2" ○ 5 - 6 - 8 - 10 - 12 mm
- 1 rallonge - 1/2" 125 mm
- 1 rallonge - 1/2" 255 mm
- 1 cardan 1/2"
- 1 poignée coulissante 1/2"
- 1 cliquet réversible 1/2" ⊕
- 1 pointeau Ø 4 mm
- 6 chasse-goupilles gainé confort 2-3-4-5-6-8 mm
- 17 clés mixtes 6-7-8-10-11-12-13-14-16-17-18-19-21-22-24-27-30 mm
- 8 clés à fourches 6x7 - 8x9 - 10x11 - 12x13 - 14x15 - 16x17 - 18x19 - 20x22 mm
- 9 clés mâles 6 pans coudées ○
- 6 clés mâles 6 pans en T 2,5 - 3 - 4 - 5 - 6 - 8 mm
- 5 limes demi-douces 200 mm
- 11 clés mâles 6 pans à poignée en T ○ 2 - 2,5 - 3 - 3,5 - 4 - 4,5 - 5 - 6 mm
- 4 bacs de rangement
- 4 bacs de rangement
- 4 bacs de rangement

1032	T145
1034	T145
1036	T145
1038	T145
1048N	T153
1052	T153
1084BM	T137
1150BM	T137
1166BM	T137
194	T85
900/55	T85
900/55	T85
900/42	T85
900BG/30	T85
900/25	T85
900/21	T85
851SR	T85
861SP	T85
861TQS	T85
861TRW	T85
861RTX	T85
861TX	T85
861PZ	T85
861PH	T85
861PE	T85
861LP	T85
35	T234
1370	T234
1390	T234
1692	T294
1725CR	T294
1771RL	T294
1771	T294
920A	T80
920ME	T80
920/21	T80
920/22	T80
920/25	T80
920/42	T80
920/55	T80
32	T239
31BM	T239
42	T01
55	T33
96/SC9	T33
951	T68
1719BMA&S5	T236
96T	T50
VP-3SC	VP-3SC
VP-LS	VP-LS
VP-LD	VP-LD

CHF 3,120.00 059381062

Composition conseillée avec C38



5957U-P

Composition de 133 outils

► Pour la maintenance générale

Quantité/Description	Réf. Beta
6 chasse-goupilles 2 + 8 mm	31/SP6
6 2 chasse - clous, 1 pointeau, 2 burins plats, 1 bédane, sur présentoir	38/SP6
17 clé mixte 6+22 - 24 - 27 - 30 mm	42/S17X
12 clés à fourches 6x7 + 30x32 mm	55/S12X
8 clés mâles 6 pans à poignée en T 2 + 10 mm	96T/S8
8 clés mâles coudées pour vis Torx® T9 + T40	97TX/SC8
1 Clé à molette à ouverture graduée, chromée 250 mm	111E
13 douilles 6 pans 1/2" sur rail Ø 10 + 22 mm	920A/SB13
8 douilles 6 pans 1/2" sur rail Ø 23 + 32 mm	920A/SB8
7 douille tournevis pour vis Phillips®	920LH/SB7
⊕ 1,2x65 - 1,2x8 - 1,6x9 - 2x12mm - PH1-PH2-PH3	
1 pinces pour circlips intérieurs à becs droits Ø 180 mm	1032
1 pinces pour circlips intérieurs à becs coudés Ø 170 mm	1034
1 pinces pour circlips extérieurs à becs droits ● 175 mm	1036
1 pinces pour circlips extérieurs à becs coudés ● 175 mm	1038
1 Pince multiprise entrepassée 250 mm	1048N
1 pince - étau à becs droits 240 mm	1052
1 cisaille type américain coupe droite 250 mm	1112
1 ciseaux d'électricien	1128BMX
8 2,5x50 - 3x75 - 4x100 - 5,5x125 - 6,5x150 - PH0 - PH1 - PH2	1263/D8
1 marteau de mécanicien 300 - 600 g	1370
1 maillet à embouts nylon, manche en bois 35	1390
1 mètre à ruban 5 m	1692/5
1 doigt magnétique flexible	1712E/2
1 grattoir feuille de sauge 200 mm	1717A
1 grattoir triangulaire 200 mm	1717B
5 limes demi-douces 200 mm	1719BMA8/S5
1 Burette tôle 200 cc	1751N
1 cutter à lame sécable 18 mm avec lames	1771BM
1 rallonge - 1/2" 125 mm	920/21
1 rallonge - 1/2" 250 mm	920/22
1 cardan 1/2"	920/25
1 poignée coulissante 1/2"	920/42
1 cliquet réversible 1/2" ⊕	920/55
1 pince levier à broche et palette	963
1 Pince coupante diagonale ⚡ 160 mm	1082BM
1 Pince coupante diagonale à faible effort de coupe ⚡ 160 mm	1084BM
1 pince coupante frontale articulée, série lourde ⚡ 180 mm	1092V
1 pince à becs demi-ronds longs = 180 mm	1150BM
1 Pince à becs demi-ronds longs ● 160 mm	1166BM
1 Pince à becs coudés demi-ronds ● 160 mm	1168BM
2 tournevis pour vis à fente ● 8x200 - 10x200 mm	1260
1 tournevis pour vis Phillips® ⊕ PH3 8x150mm	1262
1 Pied à coulisse	1650
1 monture de scie à métaux 420 mm	1725

CHF



5957U-P

3,260.00 059571004

Composition conseillée avec C57S A - C57S B - C57SP



5958U

Composition de 85 outils

► Maintenance générale

Quantité/Description	Réf. Beta
17 clés mixtes 6+22 mm	42
12 clés mâles 6 pans coudées \odot 2+10 mm	96N/SC12
13 douilles 6 pans 1/2" sur rail \odot 10+22 mm	920A/SB13
8 douilles 6 pans 1/2" sur rail \odot 23+32 mm	920A/SB8
1 rallonge - 1/2" 125 mm	920/21
1 rallonge - 1/2" 255 mm	920/22
1 cardan 1/2"	920/25
1 poignée coulissante 1/2"	920/42
1 cliquet réversible 1/2" \oplus	920/55
1 pinces pour circlips intérieurs à becs droits \odot 180 mm	1032
1 pinces pour circlips extérieurs à becs droits \bullet 175 mm	1036
1 Pince multiprise entrepassée 250 mm	1048N
1 pince - étau à becs droits 240 mm	1052
1 Pince coupante diagonale à faible effort de coupe ∇ 160 mm	1084BM
1 ciseaux d'électricien	1128BMX
1 pince à becs demi-ronds longs \equiv 180 mm	1150BM
1 Pince à becs demi-ronds longs \bullet 160 mm	1166BM
7 tournevis pour vis à fente \bullet 3x75 - 3,5x100 - 4x125 5,5x150 - 6,5x150 - 8x200 - 10x200 mm	1260
4 tournevis pour vis Phillips® \oplus PH0x60 - PH1x80 PH2x100 - PH3x150 mm	1262/S4
1 marteau de mécanicien 300 g	1370
1 maillet à embouts nylon, manche en bois \varnothing 35 mm	1390
1 mètre à ruban 5 m	1692
5 limes demi-douces 200 mm	1719BMA..S5
1 monture de scie à métaux	1725
1 burette plastique 150 cc	1754
1 cutter à lame sécable 18 mm avec lames	1771

CHF



5958U 1,645.00 059581008

Composition conseillée avec C58P - C45 - C55



5990V1

assortiment de 44 outils pour valise COMBO C99V1, plateau en mousse EVA

► Maintenance générale

Quantité/Description

- 9 clés mâles 6 pans coudées à tête sphérique ○
- 1 cutter à lame sécable 18 mm avec lames 18 mm
- 1 Pince multiprise entrepassée 250 mm
- 6 2 poinçons de dérive, 1 poinçon central, 2 ciseaux plats et 1 ciseau à cape en portefeuille enroulable en polyester
- 3 tournevis pour vis à fente ● 3,5x100-5,5x125-6,5x150 mm
- 3 tournevis pour vis Phillips® ⊕ PH0x60-PH1x80-PH2x100 mm
- 1 ciseaux d'électricien
- 16 clés mixtes 6-7-8-9-10-11-12-13-14-15-16-17-18-19-21-22 mm
- 1 mètre à ruban 5 mt
- 1 marteau de mécanicien 300 g
- 1 Pince coupante diagonale ✂ 160 mm
- 1 pince universelle, branches gainées confort bi-matériaux, modèle grande capacité, finition industrielle = 180 mm

Réf. Beta
96BPC/SC9
1771
1048N
38/B6N
1260
1262
1128BMX
42
1692/5
1370
1082GBM
1150GBM

CHF

5990V1 760.00 059900001

Assortiment recommandé en combinaison avec C99V1



5990V3

assortiment de 116 outils pour valise COMBO C99V3 / 2C, plateau en mousse EVA

► Automobile

Quantité/Description

- 5 clés mâles 6 pans à poignée en T
- 1 Clé à molette à ouverture graduée, chromée 250 mm
- 1 poignée emmanchée avec carré mâle 1/4"
- 1 tournevis détecteur de tension ●
- 1 niveau de poche avec base en "V" magnétique
- 1 torche LED d'inspection, en aluminium anodisé renforcé
- 31 coffret de 31 pièces ● ○ ⊕ ⊕ ⊕
- 1 douille porte-embouts
- 12 douilles 6 pans avec carré conducteur femelle 1/4" ○ 4-4,5-5-5,5-6-7-8-9-10-11-12-13 mm
- 1 rallonge - 1/4" 50 mm
- 1 rallonge - 1/4" 100 mm
- 1 poignée coulissante avec carré mâle 1/4"
- 1 cliquet réversible ⊕
- 38 micro-tournevis avec 36 embouts interchangeables de 4 mm et rallonge magnétique, poignée bi-matériau
- 1 maillet à embouts nylon, manche en bois Ø 35mm
- 1 cardan avec carrés mâle et femelle 1/4"
- 13 douilles 6 pans avec carré conducteur femelle 1/2" ○ 10-11-12-13-14-15-16-17-18-19-20-21-22 mm
- 1 rallonge - 1/2" 125 mm
- 1 rallonge - 1/2" 255 mm
- 1 cardan 1/2"
- 1 poignée coulissante 1/2"
- 1 cliquet réversible 1/2" ⊕

Réf. Beta
96T/S5P
111E
900BG/30
1253
1695XS
1833XS/2
860MIX/A31
895
900
900/20
900/20L
900/42
900/55Z
900/55Z
1256/C36-2
1390
900/25
920A
920/21
920/22
920/25
920/42
920/55

CHF

5990V3 1,092.00 059900003

Assortiment recommandé en combinaison avec C99V3 / 2C

Beta



5980U/BIKE

Composition de 90 outils

► Réparation vélos

Quantité/Description	Réf. Beta
5 clés mixtes 8-9-10-13-14 mm	42
9 clé mâle 6 pans coudée à tête sphérique, brunie ○ 1,5-2-2,5-3-4-5-6-8-10 mm	96BP/SC9
8 clés mâles 6 pans à poignée en T 2-2,5-3-4-5-6-8-10 mm	96T/S8
8 tournevis pour vis Torx® ☉ T8-T10-T15-T20-T25-T27-T30-T40	97TTX/S8
1 Clé à molette courte à ouverture majorée, chromée 170 mm	111CM
1 coupe - tubes pour tubes cuivre et alliages légers	334
1 clé dynamométrique à déclenchement avec cliquet réversible 2÷10 Nm	605E
13 ○ 4-4,5-5-5,5-6-7-8-9-10-11-12-13-14 mm	900/SB13
1 rallonge - 1/4"	900/21
1 cardan avec carrés mâle et femelle 1/4"	900/25
1 cliquet réversible avec carré mâle 1/4" ☉	900/55
1 pince coupante diagonale, branches gainées avec double couche de PVC antidérapant, finition industrielle 160 mm	1082G
1 ciseaux d'électricien 145 mm	1128BM
1 pince universelle, branches gainées avec double couche de PVC antidérapant, modèle grande capacité, finition industrielle 180 mm	1150G
1 pince à becs demi-ronds longs striés, branches gainées avec double couche de PVC antidérapant, finition industrielle 180 mm	1166G
7 3x75-4x125-5,5x150-6,5x150-PH0x60-PH1x80-PH2x100 mm	1203E/D
1 marteau de mécanicien 300 g	1370
1 maillet à embouts nylon, manche en bois Ø 35 mm	1390
1 Pied à coulisse 150 mm	1650
1 mètre à ruban 3 m	1692/3
1 Lime plate demi-douce 200 mm	1719BMA...P
1 Lime demi-ronde demi-douce 200 mm	1719BMA...M
1 lime ronde demi-douce 200 mm	1719BMA...R
1 monture de scie à métaux 300 mm	1725
1 cutter à lame sécable 18 mm avec lames	1771
1 indicateur d'usure de la chaîne 120 mm	3935
1 pince pour fausse maille 170 mm	3937
7 jeu de 7 clés coniques simples 13-14-15-16-17-18-19 mm	3952/S7
1 clé pour pédales 15 mm	3953
1 clé à rayon noire 3,2 mm □	3961 3,2
1 clé à rayon verte 3,3 mm □	3961 3,3
1 clé à rayon rouge 3,5 mm □ 3	3961 3,5
1 clé à rayon professionnelle 3,2 - 4,0 mm □ 3,2 - 4,0 mm	3961U
1 clé fouet démonte-cassette 289 mm	3967
1 levier démonte-pneus 200 mm	3969
3 jeu de 3 leviers démonte-pneus en plastique 113 mm	3969K3
1 levier pour écarter les pastilles des freins à disque 222 mm	3991
1 clé pour redresser les disques des freins 234 mm	3992

CHF



5980U/BIKE 1,955.00 059801040

Composition conseillé en association avec C16 - CP17 - CP17L - C20L

5980U/BIKE-M

Composition de 106 outils pour la réparation et l'entretien des vélos

► Réparation vélos

Quantité/Description

- 16 clé mixte 6-7-8-9-10-11-12-13-14-15-16-17-18-19-20-21 mm
- 8 clés mâles 6 pans à poignée en T 2-2,5-3-4-5-6-7-8 mm
- 5 tournevis pour vis Torx® TX10-TX15-TX20-TX25-TX30
- 1 Pince coupante diagonale à faible effort de coupe 160 mm
- 1 pince à becs demi-ronds longs 160 mm
- 1 Pince à becs demi-ronds longs 160 mm
- 6 tournevis pour vis à fente 2,5x50-3x75-4x100-5,5x125-6,5x150-8x200 mm
- 1 tournevis à lame courte pour vis à fente 4x30 mm
- 4 tournevis pour vis phillips® PH0x60-PH1x80-PH2x100-PH3x150 mm
- 1 tournevis à lame courte pour vis phillips® 4,5x30 mm
- 12 tournevis pour vis torx® TX6-TX7-TX8-TX9-TX10-TX15-TX20-T25-TX27-TX30-TX40-TX45
- 1 tournevis détecteur de tension
- 1 marteau de mécanicien 300 g
- 1 maillet à embouts nylon, manche en bois 35 mm
- 2 burins nervurés 100-200 mm
- 1 limes demi-douces 200 mm
- 1 mètre à ruban 5 m
- 1 mini - monture de scie à métaux 250 mm
- 1 cutter à lame sécable 18 mm avec lames
- 1 Etui de 10 lames sécables 18 mm, pour 1771 et 1771BM, 1771HD
- 1 dérive-chaîne professionnel compatible avec chaînes de 5 à 11 vitesses
- 1 indicateur d'usure de la chaîne
- 1 pince pour fausse maille
- 7 clé conique simple 13-14-15-16-17-18-19 mm
- 1 clé à rayon noire 3,2 mm 3,2 mm
- 1 clé à rayon verte 3,3 mm 3,3 mm
- 1 clé à rayon rouge 3,5 mm 3,5 mm
- 1 clé à rayon professionnelle 3,2 - 4,0 mm 3,2-4,0 mm
- 1 levier démonte-pneus
- 1 jeu de 3 leviers démonte-pneus en plastique
- 1 douille extracteur pour mouvement central à 16 encoches 39 mm
- 1 douille extracteur pour mouvement central à 16 encoches 41 mm
- 1 douille extracteur pour mouvement central à 16 encoches 46 mm
- 1 douille extracteur pour mouvement central à 20 encoches avec pivot central, nickelée 31,5 mm
- 1 clé extracteur pour roues libres bmx à 4 embouts 35 mm
- 1 clé extracteur pour roues libres shimano 22,8 mm
- 1 clé extracteur pour roues libres shimano à cassette avec embout de guide 23,5 mm
- 1 clé extracteur pour roues libres campagnolo avec embout de guide 23 mm
- 1 levier pour écarter les pastilles des freins à disque
- 1 clé pour redresser les disques des freins
- 1 outil pour l'alignement du dérailleur
- 1 extracteur pour manivelle
- 1 clé pour pédales
- 2 clé à fourche pour jeux guidon universels 30x32-32x36 mm
- 1 clé fouet démonte-cassette
- 1 clé pour vis en plastique shimano

Réf. Beta	TR
42	M05
96T	M50
97TTX	M55
1084	M137
1150	M137
1166	M137
1201E	M213
1201EN	M213
1202E	M213
1202EN	M213
1207E/TX	M213
1253	M213
1370	M234
1390	M234
35	M234
1719BMA...S5	M236
1692	M294
1725CR	M294
1771	M294
1771RL	M294
3932U	M400
3935	M400
3937	M400
3952	M400
3961 3,2	M400
3961 3,3	M400
3961 3,5	M400
3961U	M400
3969	M400
3969K3	M400
3973/1	M400
3973/2	M400
3973/3	M400
3973/4	M400
3984/1	M400
3984/2	M400
3984/3	M400
3984/4	M400
3991	M400
3992	M400
3921	M401
3948	M401
3953	M401
3955	M401
3967	M401
3971	M401



M05 M50 M55



M137 M234 M236 M294



M213



M400



M401

CHF

5980U/BIKE-M 2,570.00 059801050

5988H/7M

Composition de 333 outils en en plateaux mousse compacte

► Réparation automobile

Quantité/Description

- 13 douille 6 pans série longue ○ 8-9-10-11-12-13-14-15-16-17-19-21-22 mm
- 16 douille 6 pans série longue ○ 10-12-13-14-15-16-17-18-19-21-22-23-24-27-30-32 mm
- 7 douilles pour écrous à empreinte Torx®, 1/2" ○ E12-E14-E16-E18-E20-E22-E24
- 10 Douille tournevis pour vis 6 pans creux ○ 5-6-6L-7-8-8L-10-10L-12-12L mm
- 13 douilles tournevis pour vis à empreinte Torx® ○ T20-T25-T27-T30-T30L-T40-T40L-T45-T50-T50L-T55-T60-T60L
- 8 Douille tournevis pour vis XZN® ○ 5-6-6-6L-8-8L-10-10L-12L mm
- 18 clés mixtes 6-7-8-9-10-11-12-13-14-15-16-17-18-19-21-22-24-27 mm
- 7 clés polygonales contre - coudées 6x7-8x9-10x11-12x13-14x15-16x17-18x19 mm
- 1 Adaptateur pour douilles 1/4" à déverrouillage rapide, pour clés à cliquet 10 mm
- 1 Adaptateur pour douilles 3/8" à déverrouillage rapide, pour clés à cliquet 13 mm
- 1 Adaptateur pour douilles 1/2" à déverrouillage rapide, pour clés à cliquet 19 mm
- 1 clé mixte à cliquet réversible 8-9-10-11-12-13-14-15-16-17-18-19 mm
- 9 clés mâles 6 pans coudées à tête sphérique ○ 1,5-2-2,5-3-4-5-6-8-10 mm
- 1 douille porte-embouts ○ 1/4-□1/4
- 1 douille porte-embouts ○ 1/4-□3/8
- 1 douille porte-embouts ○ 5/16-□1/2
- 13 douilles 6 pans avec carré conducteur femelle 1/4" ○ 4-4,5-5-5,5-6-7-8-9-10-11-12-13-14 mm
- 9 douille 6 pans série longue ○ 5-6-7-8-9-10-11-12-13 mm
- 4 douille tournevis pour vis à fente ● 0,8x4-1x5,5-1,2x6,5-1,2x8 mm
- 5 douilles tournevis pour vis 6 pans creux carré femelle 1/4" ○ 3-4-5-6-7 mm
- 4 douille tournevis pour vis Phillips® ● PH1-PH2-PH3-PH4
- 7 douille tournevis pour vis Torx® ○ T10-T15-T20-T25-T27-T30-T40
- 1 augmentateur carré femelle 1/4" et mâle 3/8" □1/4-■3/8
- 3 rallonge - 1/4" 50-100-150 mm
- 1 cardan avec carrés mâle et femelle 1/4"
- 1 poignée coulissante avec carré mâle 1/4"
- 1 cliquet réversible avec carré mâle 1/4" ⊕
- 1 poignée emmanchée avec carré mâle 1/4"
- 17 douilles 6 pans 3/8" ○ 6-7-8-9-10-11-12-13-14-15-16-17-18-19-20-21-22 mm
- 1 Réducteur carré femelle 3/8" et mâle 1/4" □3/8-■1/4
- 1 Réducteur carré mâle 1/2" et femelle 3/8" □3/8-■1/2
- 1 rallonge - 3/8" 125 mm
- 1 rallonge - 3/8" 250 mm
- 1 cardan 3/8"
- 1 poignée coulissante 3/8"
- 1 cliquet réversible avec carré mâle 3/8" ⊕
- 21 douilles 6 pans avec carré conducteur femelle 1/2" ○ 8-10-11-12-13-4-15-16-17-18-19-20-21-22-23-24-26-27-28-30-32 mm
- 2 rallonge angulaire - 1/2" 125-250 mm
- 1 réducteur carré femelle 1/2" et mâle 3/8" □1/2-■3/8
- 1 cardan 1/2"
- 1 poignée coulissante 1/2"
- 1 cliquet réversible 1/2" ⊕
- 3 douilles pour bougies 3/8" ○ 16-17,8-20,8 mm
- 31 coffret de 31 pièces ● ○ ⊕ ⊗ ⊙ ⊚ ⊛ ⊜ ⊝ ⊞ ⊟ ⊠ ⊡ ⊢ ⊣ ⊤ ⊥ ⊦ ⊧ ⊨ ⊩ ⊪ ⊫ ⊬ ⊭ ⊮ ⊯ ⊰ ⊱ ⊲ ⊳ ⊴ ⊵ ⊶ ⊷ ⊸ ⊹ ⊺ ⊻ ⊼ ⊽ ⊾ ⊿ ⊿
- 1 Pince multiprise entrecroisée 250 mm
- 1 Pince coupante diagonale ⊥ 160 mm
- 1 pince à becs demi-ronds longs ≡ 180 mm
- 1 Pince à becs plats longs ≡ 160 mm
- 5 tournevis pour vis Phillips® ● 3x75-4x100-5,5x100-6,5x150-8x150 mm
- 1 tournevis à lame courte pour vis à fente ● 6,5x30 mm
- 3 tournevis pour vis Phillips® ● PH1-PH2-PH3
- 1 tournevis à lame courte pour vis Phillips® ● PH2
- 4 tournevis pour vis Torx® ○ T20-T25-T27-T30
- 6 chasse-goupilles 2-3-4-5-6-8 mm
- 1 pointeau 4 mm
- 3 burins plats 125-150-75 mm
- 1 bédanes 125 mm
- 2 marteau de mécanicien 500-1000 g
- 1 aimant télescopique avec tête flexible
- 1 maillet à embouts nylon, manche en bois Ø 35 mm
- 1 mètre à ruban 5 m
- 1 pinces pour circlips intérieurs à becs droits ○ 180 mm
- 1 pinces pour circlips intérieurs à becs coudés ○ 170 mm
- 1 pinces pour circlips extérieurs à becs droits ● 175 mm
- 1 pinces pour circlips extérieurs à becs coudés ● 175 mm
- 1 couteau d'électricien avec dénudeur ● 140 mm
- 1 pince coupante diagonale ⊥ 125 mm
- 4 micro-tournevis pour vis à fente ● 2,0-2,5-3,0-3,5 mm
- 2 micro-tournevis pour vis Phillips® ● 0-00
- 9 tournevis pour vis Torx® ○ T10-T15-T20-T25-T27-T30-T40-T45-T50
- 1 pince - étau à becs droits 240 mm
- 1 pince - étau à becs longs 175 mm
- 1 pinces à durites
- 1 pince à durites
- 1 pince à durites
- 1 Pied à coulisse
- 1 jauge d'épaisseur
- 1 grattoir pour joints
- 7 Clé à douilles articulées 6x7-8x9-10x11-12x13-14x15-16x17-18x19 mm
- 1 poignée articulée carré mâle 1/2
- 1 pince levier plate coudée 450 mm
- 1 miroir d'inspection télescopique 670 mm
- 1 limes demi-douces 200 mm
- 1 limes demi-douces 200 mm
- 1 limes demi-douces 200 mm
- 1 limes demi-douces 200 mm
- 1 limes demi-douces 200 mm
- 1 Brosse à bougies en fils de acier

Réf. Beta	TR
910AL	M125
920AL	M125
920FTX	M125
920PE	M125
920TX	M125
920XZN	M125
42	M25
90	M25
123Q1/4	M25
123Q3/8	M25
123Q1/2	M25
142	M25
96BPC/SC9	M105
895/1	M105
895/3	M105
895/6	M105
900	M105
900L	M105
900LP	M105
900ME	M105
900PH	M105
900TX	M105
900/16	M105
900/...	M105
900/25	M105
900/42	M105
900/55	M105
900B/30	M105
910A	M105
910/15	M105
910/16	M105
910/21	M105
910/22	M105
910/25	M105
910/42	M105
910/55	M105
920A	M105
920AN	M105
920/15	M105
920/25	M105
920/42	M105
920/55	M105
956E	M105
860MIX/A31	M166
1048N	M166
1082BM	M166
1150BM	M166
1162BM	M166
1290	M166
1290N	M166
1292	M166
1292N	M166
1297TX	M166
31	M231
32	M231
34	M231
36	M231
1370	M231
1712TF	M231
1390	M231
1692	M125
1032	M62
1034	M62
1036	M62
1038	M62
1177BM	M62
1188BM	M62
1257LP	M62
1257PH	M62
97TTX	M62
1052	M78
1058	M78
1481PL/A	M78
1481PL/B	M78
1481PL/C	M78
1650	M78
1708/20	M78
1716P	M78
80	M78
920/36A	M78
965	M78
1715	M231
1719BMA/8/M	M231
1719BMA/8/P	M231
1719BMA/8/Q	M231
1719BMA/8/R	M231
1719BMA/8/T	M231
1737NX	M231

CHF

5988H/7M 6.680.00 059881087

Composition conseillé en association avec RSC24/8 - RSC24A/8 - RSC24AXL - C37/8 - C39/8 - RSC28 - C59B



M125



M25



M105



M166



M231



M62



M78

5988L/4M

Composition de 273 outils en plateaux mousse compacte

► Réparation automobile

Quantité/Description

- 13 douilles 6 pans avec carré conducteur femelle 1/4" ○ 4-4,5-5-5,5-6-7-8-9-10-11-12-13-14 mm
- 9 douille 6 pans série longue ○ 5-6-7-8-9-10-11-12-13 mm
- 9 clés mâles 6 pans coudées à tête sphérique ○ 1,5-2-2,5-3-4-5-6-8-10 mm
- 1 douille porte-embouts
- 1 douille porte-embouts
- 1 douille porte-embouts
- 5 douilles tournevis pour vis 6 pans creux carré femelle 1/4" ○ 3-4-5-6-7 mm
- 4 douille tournevis pour vis à fente ● 0,8x4-1x5,5-1,2x6,5-2x8 mm
- 4 douille tournevis pour vis Phillips® PH1-PH2-PH3-PH4
- 7 douille tournevis pour vis Torx® T10-T15-T20-T25-T27-T30-T40
- 1 augmentateur carré femelle 1/4" et mâle 3/8" □ 1/4 - ■ 3/8
- 3 rallonge - 1/4" 50-100-150 mm
- 1 cardan avec carrés mâle et femelle 1/4"
- 1 poignée emmanchée avec carré mâle 1/4"
- 1 poignée coulissante avec carré mâle 1/4"
- 1 cliquet réversible avec carré mâle 1/4" ⊕
- 17 douilles 6 pans 3/8" ○ 6-7-8-9-10-11-12-13-14-15-16-17-18-19-20-21-22 mm
- 1 Réducteur carré femelle 3/8" et mâle 1/4" □ 3/8 - ■ 1/4
- 1 Réducteur carré mâle 1/2" et femelle 3/8" □ 3/8 - ■ 1/2
- 1 rallonge - 3/8" 125 mm
- 1 rallonge - 3/8" 250 mm
- 1 cardan 3/8"
- 1 poignée coulissante 3/8"
- 1 cliquet réversible avec carré mâle 3/8" ⊕
- 17 douilles 6 pans avec carré conducteur femelle 1/2" ○ 8-10-11-12-13-14-15-16-17-18-19-20-21-22-23-24-26-27-28-30-32 mm
- 1 réducteur carré femelle 1/2" et mâle 3/8" □ 1/2 - ■ 3/8
- 1 cardan 3/8"
- 2 rallonge angulaire - 1/2" 125 - 250 mm
- 1 poignée coulissante 1/2"
- 1 cliquet réversible 1/2" ⊕
- 3 douilles pour bougies 3/8" ○ 16-17,8-20,8 mm
- 13 douille 6 pans série longue ○ 8-9-10-11-12-13-14-15-16-17-19-21-22 mm
- 10 Douille tournevis pour vis 6 pans creux ○ 5-6-6L-7-8-8L-10-10L-12-12L mm
- 7 douilles pour écrous à empreinte Torx®, 1/2" ⊙ E12-E14-E16-E18-E20-E22-E24
- 13 douilles tournevis pour vis à empreinte Torx® ⊙ T20-T25-T27-T30-T30L-T40-T40L-T45-T50-T50L-T55-T60-T60L
- 8 Douille tournevis pour vis XZN® ○ 5-6-6L-8-8L-10-10L-12L mm
- 16 douille 6 pans série longue ○ 10-12-13-14-15-16-17-18-19-21-22-23-24-27-30-32 mm
- 1 mètre à ruban 5 m
- 18 clés mixtes 6-7-8-9-10-11-12-13-14-15-16-17-18-19-21-22-24-27 mm
- 7 clés polygonales contre - coudées 6x7-8x9-10x11-12x13-14x15-16x17-18x19 mm
- 1 Adaptateur pour douilles 1/4" à déverrouillage rapide, pour clés à cliquet 10 mm
- 1 Adaptateur pour douilles 3/8" à déverrouillage rapide, pour clés à cliquet 13 mm
- 1 Adaptateur pour douilles 1/2" à déverrouillage rapide, pour clés à cliquet 19 mm
- 12 clé mixte à cliquet réversible 8-9-10-11-12-13-14-15-16-17-18-19 mm
- 31 coffret de 31 pièces ○ ● ⊕ ⊙ ⊙
- 1 Pince multiprise entrecroisée 250 mm
- 1 Pince coupante diagonale 160 mm
- 1 pince à becs demi-ronds longs 180 mm
- 1 Pince à becs plats longs 160 mm
- 5 tournevis pour vis Phillips® ● 3x75-4x100-5,5x100-6,5x150-8x150 mm
- 1 tournevis à lame courte pour vis à fente ● 6,5x30 mm
- 3 tournevis pour vis Phillips® ● 4,5x80-6x100-8x150 mm
- 1 tournevis à lame courte pour vis Phillips® ● 6x30 mm
- 4 tournevis pour vis Torx® ⊙ T20-T25-T27-T30

Réf. Beta	TR
900	M105
900L	M105
96BPCS9	M105
895/1	M105
895/3	M105
895/6	M105
900ME	M105
900LP	M105
900PH	M105
900TX	M105
900/16	M105
900/...	M105
900/25	M105
900BG/30	M105
900/42	M105
900/55	M105
910A	M105
910/15	M105
910/16	M105
910/21	M105
910/22	M105
910/25	M105
910/42	M105
910/55	M105
920A	M105
920/15	M105
910/25	M105
920AN	M105
920/42	M105
920/55	M105
956E	M105
910AL	M125
920PE	M125
920FTX	M125
920TX	M125
920XZN	M125
920AL	M125
1692/5	M125
42	M25
90	M25
123Q1/4	M25
123Q3/8	M25
123Q1/2	M25
142	M25
860MIX/A31	M166
1048N	M166
1082BM	M166
1150BM	M166
1162BM	M166
1290	M166
1290N	M166
1292	M166
1292N	M166
1297TX	M166



M105



M125



M25



M166

CHF

5988L/4M

4,720.00 059881088

Composition conseillée avec RSC24 - RSC24A - RSC24AXL - RSC24L - RSC24L-CAB - C37 - C39 - C39T - C39SM - C39MD - RSC55 - C59

5988U6/M

Composition de 214 outils en plateaux mousse compacte

► Maintenance générale

Quantité/Description

- 22 clés mixtes 6-7-8-9-10-11-12-13-14-15-16-17-18-19-20-21-22-24-27-30-32-36 mm
- 11 clés à fourches 6x7-8x9-10x11-12x13-14x15-16x17-18x19-20x22-21x23-24x27-30x32 mm
- 11 clés polygonales contre - coudées 6x7-8x9-10x11-12x13-14x15-16x17-18x19-20x22-21x23-24x27-30x32 mm
- 9 clés mâles 6 pans coudées à tête sphérique \odot 1,5-2-2,5-3-4-5-6-8-10 mm
- 6 tournevis pour vis à fente \bullet 2,5x50-3x75-4x100-5,5x125-6,5x150-8x200 mm
- 1 tournevis à lame courte pour vis à fente \bullet 4x30 mm
- 4 tournevis pour vis phillips® \oplus PH0x60-PH1x80-PH2x100-PH3x150 mm
- 1 tournevis à lame courte pour vis phillips® \oplus PH1x30 mm
- 12 tournevis pour vis torx® \otimes T6-T7-T8-T9-T10-T15-T20-T25-T27-T30-T40-T45
- 1 tournevis détecteur de tension \bullet
- 3 chasse-clous \emptyset 2-3-4 mm
- 6 chasse-goupilles \emptyset 2-3-4-5-6-8 mm
- 1 pointeau \emptyset 4 mm
- 1 burins plats 150 mm
- 2 burins nervurés 200-250 mm
- 1 bédanes 125 mm
- 1 marteau de mécanicien 500 g
- 1 maillet à embouts nylon, manche en bois \emptyset 35 mm
- 1 mètre à ruban 3 m
- 1 aimant télescopique avec tête flexible
- 1 Lime carrée demi-douce 200 mm
- 1 Lime triangulaire demi-douce 200 mm
- 1 Lime plate demi-douce 200 mm
- 1 Lime demi-ronde demi-douce 200 mm
- 1 lime ronde demi-douce 200 mm
- 1 Brosse à bougies en fils de acier
- 1 cutter à lame sécable 18 mm avec lames 18 mm
- 1 pinces pour circlips intérieurs à bords droits \odot 180 mm
- 1 pinces pour circlips intérieurs à bords coudés \odot 170 mm
- 1 pinces pour circlips extérieurs à bords droits \bullet 175 mm
- 1 pinces pour circlips extérieurs à bords coudés \bullet 175 mm
- 1 Pince multiprise entrepassée 250 mm
- 1 pince - étai à bords droits 240 mm
- 1 Pince coupante diagonale ∇ 160 mm
- 1 Tenaille type russe 220 mm
- 1 cisaille type américain coupe droite 250 mm
- 1 ciseaux d'électricien
- 1 pince à bords demi-ronds longs \equiv 180 mm
- 1 Pince à bords demi-ronds longs \bullet 160 mm
- 1 Pince à bords coudés demi-ronds \bullet 160 mm
- 1 douille porte-embouts
- 1 douille porte-embouts
- 1 douille porte-embouts
- 13 douilles 6 pans avec carré conducteur femelle 1/4" \odot 4-4,5-5-5,5-6-7-8-9-10-11-12-13-14 mm
- 9 douille 6 pans série longue \odot 5-6-7-8-9-10-11-12-13 mm
- 5 douilles tournevis pour vis 6 pans creux carré femelle 1/4" \odot 3-4-5-6-7 mm
- 4 douille tournevis pour vis à fente \bullet 0,8x4-1x5,5-1,2x6,5-1,2x8 mm
- 4 douille tournevis pour vis Phillips® \oplus PH1-PH2-PH3-PH4
- 7 douille tournevis pour vis Torx® \otimes T10-T15-T20-T25-T27-T30-T40
- 1 rallonge - 1/4" 50 mm
- 1 rallonge - 1/4" 100 mm
- 1 rallonge - 1/4" 150 mm
- 1 cardan avec carrés mâle et femelle 1/4"
- 1 poignée emmanchée avec carré mâle 1/4"
- 1 poignée coulissante avec carré mâle 1/4"
- 1 cliquet réversible avec carré mâle 1/4" \otimes
- 21 douilles 6 pans avec carré conducteur femelle 1/2" \odot 8-10-11-12-13-14-15-16-17-18-19-20-21-22-23-24-26-27-28-30-32 mm
- 1 réducteur carré femelle 1/2" et mâle 3/8" 125 mm
- 1 cardan 1/2" 250 mm
- 1 rallonge angulaire - 1/2"
- 1 rallonge angulaire - 1/2"
- 1 poignée coulissante 1/2"
- 1 cliquet réversible 1/2" \otimes
- 8 douilles pour écrous à empreinte Torx®, 1/2" \odot 10-12-14-16-18-20-22-24 mm
- 11 douille 6 pans série longue \odot 10-12-13-14-15-16-17-18-19-21-22 mm

Réf. Beta	TR
42	M01
55	M30
90	M30
96BPC/SC9	M30
1201E	M213
1201EN	M213
1202E	M213
1202EN	M213
1207E/TX	M213
1253	M213
30	M230
31	M230
32	M230
34	M230
35	M230
36	M230
1370	M230
1390	M230
1692	M230
1712TF	M230
1719BMA...Q	M230
1719BMA...T	M230
1719BMA...P	M230
1719BMA...M	M230
1719BMA...R	M230
1737NX	M230
1771	M230
1032	M129
1034	M129
1036	M129
1038	M129
1048N	M129
1052	M129
1082BM	M129
1098	M129
1112	M129
1128BM	M129
1150BM	M129
1166BM	M129
1168BM	M129
895/1	M100
895/3	M100
895/6	M100
900	M100
900L	M100
900ME	M100
900LP	M100
900PH	M100
900TX	M100
900/20	M100
900/20L	M100
900/21	M100
900/25	M100
900B/G/30	M100
900/42	M100
900/55	M100
920A	M100
920/15	M100
920/25	M100
920AN/125	M100
920AN/250	M100
920/42	M100
920/55	M100
920FTX	M100
920AL	M100



M01



M30



M213



M230



M129

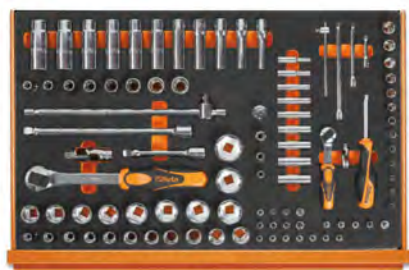

M100

CHF

5988U6/M

3,960.00 059881430

Composition conseillée avec RSC24 à 8 tiroirs - RSC24/A à 8 tiroirs - C37 à 8 tiroirs - C39 à 8 tiroirs
RSC24AXL - RSC28 - C39SM - C39MO - C59B - C55

5935ET/1MB

Composition de 96 outils pour coffre C35, en plateaux mousse compacte

► Microtechnique

Quantité/Description

- 1 pince - étau à becs droits 240 mm
- 1 marteau de mécanicien 500 g
- 1 maillet à embouts nylon, manche en bois Ø 35 mm
- 1 Lime carrée demi-douce 200 mm
- 1 Lime plate demi-douce 200 mm
- 1 Lime triangulaire demi-douce 200 mm
- 1 Lime demi-ronde demi-douce 200 mm
- 1 lime ronde demi-douce 200 mm
- 1 burins nervurés 200 mm
- 1 pinces pour circlips intérieurs à becs droits ○ 180 mm
- 1 pinces pour circlips intérieurs à becs coudés ○ 170 mm
- 1 pinces pour circlips extérieurs à becs droits ● 175 mm
- 1 pinces pour circlips extérieurs à becs coudés ● 175 mm
- 1 Pince coupante diagonale à faible effort de coupe ⚡ 160 mm
- 1 pince à becs demi-ronds longs = 180 mm
- 1 Pince à becs demi-ronds longs ● 160 mm
- 9 clés mâles 6 pans coudées à tête sphérique ○
- 1 tournevis pose - vis à fente ●
- 1 tournevis pose - vis Phillips® ⊕
- 1 tournevis détecteur de tension ●
- 6 clés à douille emmanchées ○ 5,5-6-7-8-10-13 mm
- 4 tournevis pour vis Phillips® 1000V ⊕ PH0x60-PH1x80-PH2x100-PH3x150 mm
- 6 tournevis à lame fraisée pour vis à fente 1000V ● 2,5x75-3x100-4x100-5,5x125-6x150-8x175 mm
- 31 coffret de 31 pièces ● ○ ⊕ ⊕ ⊕ ⊕
- 1 Poignée porte-embouts magnétique isolée ⚡
- 8 clés à fourches 6x7-8x9-10x11-12x13-14x15 16x17-18x19-20x22 mm
- 1 pince multiprise entrepassée 250 mm
- 1 pinces coupantes diagonales 1000V ⚡ 140 mm
- 1 Ciseaux d'électricien lames droites avec évaseur
- 1 coupe-câbles avec branches isolées 230 mm
- 1 pinces à dénuder ⚡ 160 mm
- 1 pince universelle 1000V = 180 mm
- 1 pinces à becs demi - ronds longs 1000V ● 160 mm
- 1 Pince à becs coudés demi-ronds longs ● 160 mm
- 1 clé à molette 1000V 250 mm
- 1 cutter 1000V
- 1 brucelles à becs coudés 1000V
- 1 pince à cosses pré - isolées

Réf. Beta	TR
1052	MB65
1370	MB65
1390	MB65
1719BMA...Q	MB65
1719BMA...P	MB65
1719BMA...T	MB65
1719BMA...M	MB65
1719BMA...R	MB65
35	MB65
1032	MB65
1034	MB65
1036	MB65
1038	MB65
1084BM	MB65
1150BM	MB65
1166BM	MB65
96BPC/SC9	MB63
1250	MB63
1251	MB63
1253	MB63
943MQ	MB63
1272MQ	MB63
1274MQ	MB63
860MIX/A31	MB63
850MQ	MB63
55	MB64
1048MQ	MB64
1082MQ	MB64
1128BSX	MB64
1132MQ	MB64
1142MQ	MB64
1150MQ	MB64
1166MQ	MB64
1168MQ	MB64
110MQ	MB64
1777MQ	MB64
993MQ	MB64
1602	MB64



MB65



MB64

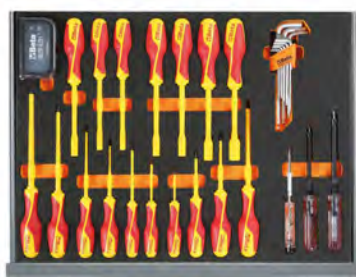

MB63

CHF

5935ET/1MB

2,400.00 059351332

Composition conseillée avec C35



5980ET/A

Composition de 70 outils

► Microtechnique

Quantité/Description	Réf. Beta
1 pointeau Ø 4 mm	32
1 burins nervurés 150 mm	35
8 6x7 - 8x9 - 10x11 - 12x13 - 14x15 - 16x17 - 18x19 - 20x22 mm	55/B8N
8 jeu de 8 clés mâles 6 pans, série longue ⌀ 2+10 mm	96LC/SC8
1 Clé à molette à ouverture graduée, chromée 200 mm	111E
1 Poignée porte-embouts magnétique isolée	850MQ
10 coffret de 11 pièces	860MIX/A10
1 pince multiprise entrepassée 250 mm	1048MQ
1 Pince coupante diagonale 160 mm	1082BM
1 Ciseaux d'électricien lames droites avec évaseur	1128BSX
1 coupe - câbles 170 mm	1132BM
1 pince à becs demi-ronds longs 180 mm	1150BM
1 Pince à becs demi-ronds longs 160 mm	1166BM
1 Pince à becs coudés demi-ronds 160 mm	1168BM
1 tournevis pose - vis à fente 4x125 mm	1250
1 tournevis pose - vis Phillips PH1x125 mm	1251
1 tournevis détecteur de tension	1253
5 tournevis pour vis à fente 2,5x75 - 3,5x100 - 5,5x125 - 6,5x150 mm	1201E
1 tournevis à lame courte pour vis à fente 4x30 mm	1201EN
4 tournevis pour vis phillips PH0x60 - PH1x120 - PH2x150 - PH3x150 mm	1202E
1 tournevis à lame courte pour vis phillips PH2x30 mm	1202EN
4 tournevis pour vis Phillips 1000V PH0x60 - PH1x80 - PH2x100 - PH3x150 mm	1272MQ
5 tournevis à lame fraisée pour vis à fente 1000V 5,5x125 - 3x100 - 4x100 - 6,5x150 - 8x175 mm	1274MQ
1 burin plat de carrossier coupe latérale	1343
1 marteau de mécanicien 300 g	1370
1 maillet à embouts nylon, manche en bois Ø 35 mm	1390
1 pince à cosses pré - isolées	1602
1 25 m	BMESB1925NE
1 mètre à ruban 5 m	1692
1 Lime demi-ronde demi-douce 200 mm	1719BMA...M
1 lime ronde demi-douce 200 mm	1719BMA...R
1 monture de scie à métaux	1725
1 couteau d'électricien avec dénudeur	1777BM

CHF



5980ET/A 1,210.00 059801083

Composition conseillée avec C12 - 2028VV - 2032TV - 2032VV

5980ET/B

Composition de 64 outils

► Pour la microtechnique

Quantité/Description

Quantité/Description	Réf. Beta
3 chasse-goupilles Ø 2 - 3 - 4 mm	31
1 pointeau Ø 4 mm	32
1 burins plats 150 mm	34
8 6x7 - 8x9 - 10x11 - 12x13 - 14x15 - 16x17 - 18x19 - 20x22 mm	55/B8N
9 clés mâles 6 pans coudées à tête sphérique ○ 1,5 - 2 - 2,5 - 3 - 4 - 5 - 6 - 8 - 10 mm	96BPC/SC9
1 ébavureur à lame 150 mm	345SB
6 clés a douilles emmanchée 1000V ○ 5,5 - 6 - 7 - 8 - 10 - 13 mm	943MQ/S6
1 pince multiprise entrepassée 250 mm	1048MQ
1 pinces coupantes diagonales 1000V † 160 mm	1082MQ
1 Ciseaux d'électricien lames droites avec évaseur	1128BSX
1 coupe-câbles avec branches isolées 230 mm	1132MQ
1 pinces à dénuder † 160 mm	1142MQ
1 pince universelle 1000V = 180 mm	1150MQ
1 pinces à becs demi - ronds longs 1000V ● 160 mm	1166MQ
1 tournevis détecteur de tension ●	1253
3 tournevis pour vis Phillips® 1000V ⊕ PH0x60 - PH1x80 - PH2x100 mm	1272MQ
4 tournevis à lame fraisée pour vis à fente 1000V ● 3x100 - 4x100 - 5,5x125 - 6,5x150 mm	1274MQ
1 marteau de mécanicien 300 g	1370
1 maillet à embouts nylon, manche en bois Ø 35 mm	1390
1 pince à cosses pré - isolées	1602
1 réglet flexible 250 mm	1682
1 pointe à tracer en carbure 250 mm	1688
1 mètre à ruban 5 m	1692
1 niveau en aluminium 200 mm	1696
1 ciseau d'électricien 10x200 mm	1701NE3
1 cordeau à tracer	1705
1 miroir d'inspection flexible 600 mm	1715FL/A
1 limes demi-douces 200 mm	1719BMA8/M
1 limes demi-douces 200 mm	1719BMA8/R
1 tire - ressorts	1723
1 monture de scie à métaux	1726BM
1 pinceau de nettoyage	1738
1 pince pour colliers en Nylon	1743
1 burette plastique 150 cc	1754
100 collier en nylon, couleur noir résistant aux UV 3,6x200 mm	1748N
100 collier en nylon, couleur noir résistant aux UV 4,8x300 mm	1748N
1 cutter à lame sécable 18 mm avec lames	1771BM
1 fer à souder bi - avec panne droite pointue 30 W	1814M
1 torche LED d'inspection, en aluminium anodisé renforcé	1833XS/2



CHF



5980ET/B 1,665.00 059801084

Composition conseillée avec C12 - 2029/VV - 2033P/VV - 2036TV

5980MQ

Composition de 46 outils

► Microtechnique

Quantité/Description

Quantité/Description	Réf. Beta
7 clés à fourches 1000V 10 - 12 - 13 - 14 - 17 - 19 - 22 mm	52MQ
1 clé à molette 1000V 250 mm	110MQ
6 clés à douille emmanchées ○ 5,5 - 6 - 7 - 8 - 10 - 13 mm	943MQ
4 clés mâles 6 pans en T ○ 4 - 5 - 6 - 8 mm	951MQ
1 brucelles à becs coudés 1000V	993MQ
1 pince multiprise entrepassée 250 mm	1048MQ
1 pinces coupantes diagonales 1000V † 160 mm	1082MQ
1 ciseaux d'électriciens	1128MQ
1 pinces à dénuder † 160 mm	1142MQ
1 pince universelle 1000V = 180 mm	1150MQ
1 Pince à becs coudés plats longs = 160 mm	1164MQ
1 pinces à becs demi - ronds longs 1000V ● 160 mm	1166MQ
1 tournevis détecteur de tension ●	1253
4 tournevis pour vis Phillips® 1000V ⊕ PH0x60 - PH1x80 - PH2x100 - PH3x150 mm	1272MQ
5 tournevis à lame fraisée pour vis à fente 1000V ● 3x100 - 4x100 - 5,5x125 - 6,5x150 - 8x175 mm	1274MQ
1 marteau de mécanicien 300 g	1370
1 maillet à embouts nylon, manche en bois Ø 35 mm	1390
1 mètre à ruban 5 m	1692
1 200 mm	1701NE/3
1 mini - scie 1000V	1725MQ
2 cutter 1000V	1777MQ
1 fer à souder bi - avec panne droite pointue 30 W	1814M
1 torche LED à haute luminosité, en aluminium anodisé renforcé, jusqu'à 500 Lumens	1833S
1 Testeur combiné de tension et de continuité 12-690V AC/DC	1760PT



CHF



5980MQ 2,255.00 059801257

Composition conseillée avec 2029/VV

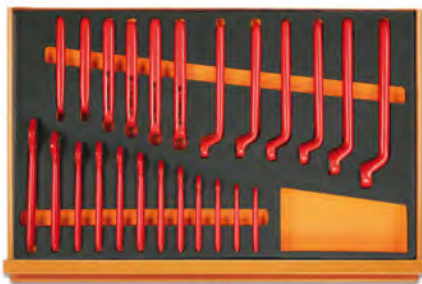

M49



M108



M161

5988 VHB-MQ

Composition de 66 outils en plateaux mousse compacte

► Microtechnique

Quantité/Description

- 12 clés à fourches 1000V 7-8-10-11-12-13-14-15-16-17-19-22 mm
- 12 Clé polygonale contre-coudée 7-8-10-11-12-13-14-15-16-17-19-22 mm
- 4 Douille tournevis pour vis 6 pans creux \odot 4-5-6-8 mm
- 11 Douille 12 pans \odot 7-8-10-11-12-13-14-15-16-17-19 mm
- 6 Douille tournevis pour vis Torx® \odot T15-T20-T25-T27-T30-T40
- 2 Douille tournevis pour vis XZN® \odot 8-10 mm
- 1 Rallonge carrés mâle et femelle 3/8" 125 mm
- 1 Rallonge carrés mâle et femelle 3/8" 250 mm
- 1 Poignée à béquille à cardan carré mâle 3/8"
- 1 Cliquet réversible carré mâle 3/8"
- 1 ciseaux d'électriciens
- 1 pince multiprise entrepassée 250 mm
- 1 pinces coupantes diagonales 1000V ∇ 160 mm
- 1 pince universelle 1000V \equiv 180 mm
- 1 Pince à becs plats longs striés \equiv 160 mm
- 1 Pince à becs coudés plats longs \equiv 160 mm
- 4 tournevis pour vis Phillips® 1000V \oplus PH0x60 - PH1x80 - PH2x100 - PH3x150 mm
- 4 tournevis à lame fraisée pour vis à fente 1000V \bullet 2,5x75 - 3x100 - 4x100 - 5,5x125 mm
- 1 Couteau d'électricien avec dénudeur isolé

Réf. Beta	TR
52MQ	M49
89MQ	M49
910MQ/PE	M108
910MQ/B	M108
910MQ/TX	M108
910MQ/XZN	M108
910MQ/21	M108
910MQ/22	M108
910MQ/T	M108
910MQ/55	M108
1128MQ	M161
1048MQ	M161
1082MQ	M161
1150MQ	M161
1162MQ	M161
1164MQ	M161
1272MQ	M161
1274MQ	M161
1777MQ/U	M161

CHF

5988 VHB-MQ

3,720.00 059880300

Composition conseillée avec RSC23T - RSC24 - RSC24A - RSC24AXL - RSC24L - RSC24L-CAB
RSC28 - C37 - C39 - C39SM - C39MD - C39T - RSC51 - RSC55 - RSC50 - C59

5980EL/A

Composition de 57 outils

► Électronique

Quantité/Description

- 13 4÷14 mm
- 9 clés mâles 6 pans coudées \odot 1,5÷10 mm
- 1 brucelles à becs coudés 130 mm
- 1 brucelles à becs droits avec guide 150 mm
- 1 brucelles à becs droits auto - serrants, pointes larges 155 mm
- 1 ciseaux d'électricien
- 1 pince à dénuder ∇ 160 mm
- 1 Pince à becs demi-ronds longs \bullet 160 mm
- 1 pince à becs plats longs \equiv
- 1 pince de précision à becs coudés demi - ronds longs \bullet
- 1 pince universelle \bullet
- 1 pince coupante diagonale avec becs effilés coupe à ras ζ
- 1 pince coupante diagonale ∇
- 1 tournevis pose - vis à fente \bullet 4x125 mm
- 1 tournevis pose - vis Phillips® \oplus PH0x125 mm
- 8 micro-tournevis
- 1 marteau de mécanicien 200 g
- 1 mètre à ruban 5 m
- 1 miroir d'inspection télescopique
- 3 limes
- 1 tire - ressorts
- 1 pinceau de nettoyage
- 1 Burette stylo
- 1 cutter à lame sécable 18 mm avec lames
- 1 pince à anneaux auto-bloquante, becs arrondis striés, en acier inoxydable
- 1 fer à souder bi - avec panne droite pointue 25 W
- 1 pompe à dessouder
- 1 torche LED d'inspection, en aluminium anodisé renforcé

Réf. Beta	
73/B13N	
96N/SC9	
991	
992	
998	
1128BMX	
1142BM	
1166BM	
1172BM	
1178BM/P	
1178BM	
1185BM	
1188BM	
1250	
1251	
1257LPH/S8	
1370	
1692	
1715	
1720/S3	
1723	
1738	
1756	
1771	
1002	
1814M	
1830T	
1833XS/2	

CHF

5980EL/A

1,200.00 059801081

Composition conseillée avec 2032TV - 2028/VV - 2033P/VV

5980EL/B

Composition de 98 outils

► Électronique

Quantité/Description	Réf. Beta
13 4÷14 mm	73/B13N
9 clés mâles 6 pans coudées \odot 1,5÷10 mm	96/SC9
8 clés mâles pour vis à empreinte Torx® \odot T9 - T10 - T15 - T20 - T25 - T27 - T30 - T40	97TX/BG8
1 Clé à molette à ouverture graduée, chromée 150 mm	111E
18 13 douilles 6 pans et 5 accessoires 1/4"	900/C13-5
1 brucelles à becs droits pointes fines 130 mm	990
1 brucelles à becs coudés 130 mm	991
1 brucelles à becs courts pointes lisses finition semi - polie 120 mm	999A
1 ciseaux d'électricien	1128BMX
1 pince à dénuder frontale autoréglable 170 mm	1149F
1 pince à becs demi-ronds longs \equiv 180 mm	1150BM
1 pince à becs plats longs \equiv 140 mm	1172BM
1 couteau d'électricien avec dénudeur \bullet 140 mm	1177BM
1 pince de précision à becs coudés demi - ronds longs \bullet 140 mm	1178BM/P
1 pince coupante diagonale de précision à becs arrondis, coupe à ras ζ 120 mm	1184BM
1 pince coupante diagonale de précision à becs effilés, coupe à ras ζ 120 mm	1186BM
1 pince coupante frontale de précision tête inclinée, coupe à ras ζ	1191BM
8 micro-tournevis	1257LPH/S8
1 tournevis détecteur de tension \bullet	1253
1 tournevis à lame courte pour vis à fente \bullet 6,5x30 mm	1290N
3 tournevis pour vis Phillips® \odot PH0x60 - PH1x80 - PH2x100 mm	1292
2 tournevis à lame courte pour vis Phillips \odot PH1x30 - PH2x30 mm	1292N
5 tournevis à lame fraisée pour vis à fente \bullet 2,5x60 - 3x75 - 4x100 - 5x125 - 6,5x150 mm	1294
1 marteau de mécanicien 200 g	1370
1 réglet flexible 150 mm	1682
1 pointe à tracer en carbure 220 mm	1688
1 mètre à ruban 5 m	1692
1 miroir d'inspection télescopique 670 mm	1715
1 Lime \bullet	1720R
1 Lime \blacktriangle	1720T
1 Lime \blacksquare	1720P
1 tire - ressorts	1723
1 pinceau de nettoyage	1738
1 Burette stylo	1756
1 cutter à lame sécable 18 mm avec lames	1771BM
1 couteau d'électricien avec dénudeur	1777BM
1 pince à anneaux auto-bloquante, becs arrondis striés, en acier inoxydable	1002
1 fer à souder bi - avec panne droite pointue 25W	1814M
1 pompe à dessouder	1830T
1 torche LED d'inspection, en aluminium anodisé renforcé	1833XS/2

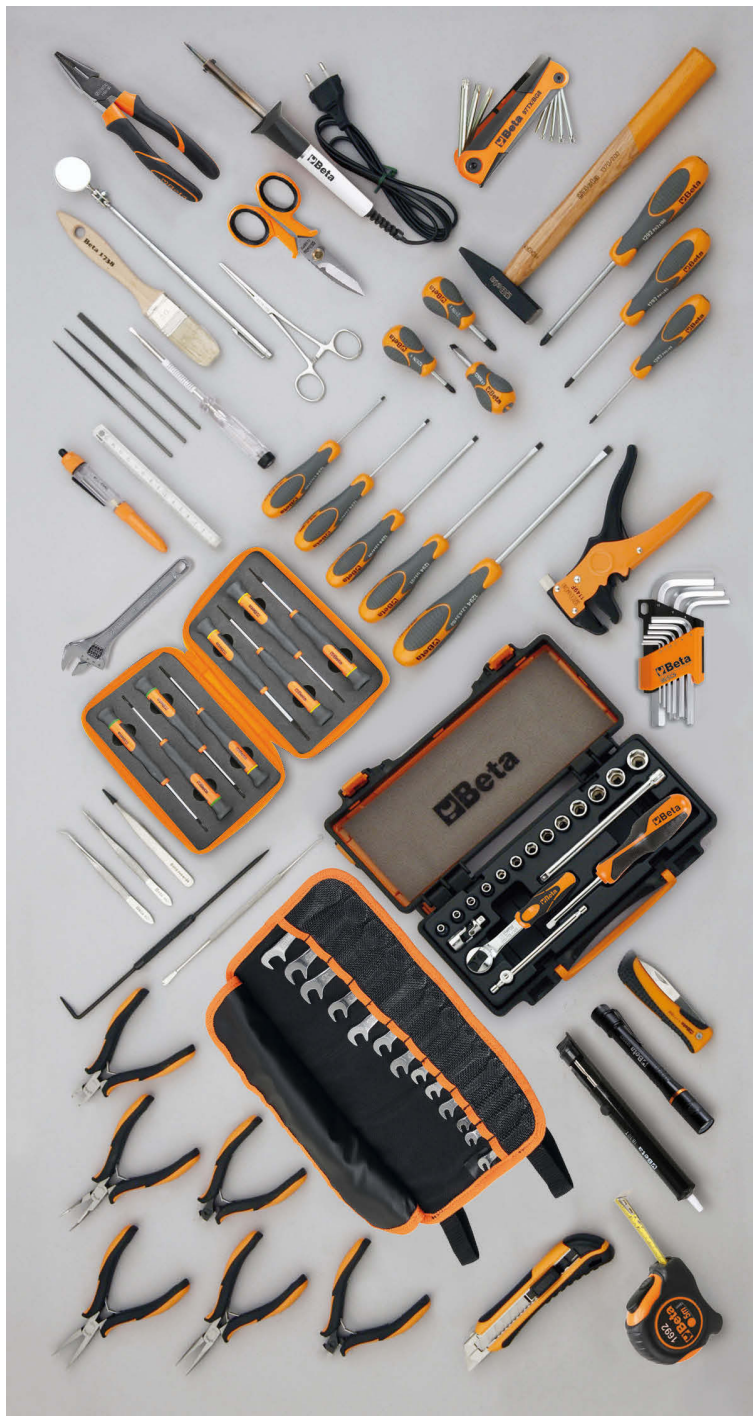

CHF



5980EL/B

1,685.00 059801082

Composition conseillée avec 2029/VV - 2033P/VV - 2036TV

5980ID/1

Assortiment de 24 outils

► Spécial maintenance plomberie

Quantité/Description

Réf. Beta

1	Clé à molette à ouverture graduée, chromée 250 mm	111E
1	Ø 3+28 mm	332/2
1	coupe - tubes pour tubes cuivre et alliages légers Ø 3+30 mm	334
1	Ø 0+42 mm	342
1	140 mm	345SB2
2	320-410 mm	376
2	Pince multiprise entrepassée 175-250 mm	1048N
1	ciseaux d'électricien	1128BMX
1	pince universelle, branches gainées confort bi-matières, modèle grande capacité, finition industrielle = 180 mm	1150GBM
4	tournevis pour vis à fente 3x75-4x100-5,5x150-8x150 mm	1201E
2	tournevis pour vis phillips PH1x80-PH2x100	1202E
1	marteau de mécanicien 500 g	1370
1	mètre pliant en fibre 2 m	1690F
1	mètre à ruban 5 m	1692/5
1	niveau en aluminium 200 mm	1696
1	Lime demi-ronde demi-douce 200 mm	1719BMA...M
1	Râpe plate 200 mm	1719BM/RL
1	monture de scie à métaux	1725



CHF



5980ID/1

701.00 059801086

Beta

► **Réparation automobile**

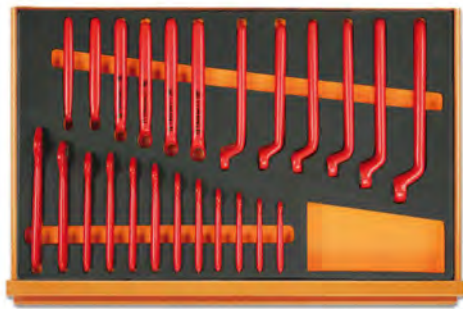

M49

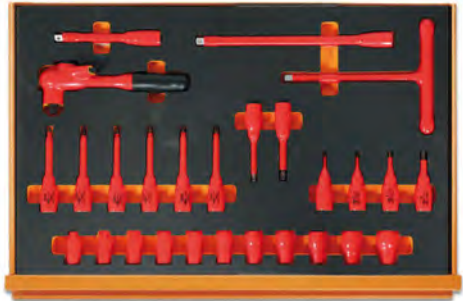

M108



M161



Quantité/Description

- 1 Tapis isolant
- 4 Colonnes en plastique avec base de rangement
- 1 Multimètre/mégohmmètre pour test isolation à haute tension
- 1 Testeur combiné de tension et de continuité 12-690V AC/DC
- 1 Embout pour multimètres numériques et pinces ampérométriques
- 1 Gants isolants composites Gr. 10
- 1
- 1 Chaîne en plastique de délimitation
- 2 Panneaux d'avertissement en aluminium A1, A2
- 2 Panneaux d'interdiction D2, D3
- 12 clés à fourches 1000V 7-8-10-11-12-13-14-15-16-17-19-22 mm
- 12 Clé polygonale contre-coudée 7-8-10-11-12-13-14-15-16-17-19-22 mm
- 4 Douille tournevis pour vis 6 pans creux \odot 4-5-6-8 mm
- 11 Douille 12 pans \odot 7-8-10-11-12-13-14-15-16-17-19 mm
- 6 Douille tournevis pour vis Torx® \odot TX15-TX20-TX25-TX27-TX30-TX40
- 2 Douille tournevis pour vis XZN® \odot M8-M10
- 1 Rallonge carrés mâle et femelle 3/8" 140 mm
- 1 Rallonge carrés mâle et femelle 3/8" 265 mm
- 1 Poignée à béquille à cardan carré mâle 3/8" 200 mm
- 1 Cliquet réversible carré mâle 3/8" 203 mm
- 1 pince multiprise entrepassée 250 mm
- 1 pinces coupantes diagonales 1000V ∇ 160 mm
- 1 ciseaux d'électriciens 145 mm
- 1 pince universelle 1000V \equiv 180 mm
- 1 Pince à becs plats longs striés \equiv 160 mm
- 1 Pince à becs coudés plats longs \equiv 160 mm
- 4 tournevis pour vis Phillips® 1000V \oplus PH0-PH1-PH2-PH3
- 4 tournevis à lame fraisée pour vis à fente 1000V \bullet 2,5x75-3x100-4x100-5.5x125 mm
- 1 Couteau d'électricien avec dénudeur isolé 190 mm

Réf. Beta	TR
1995MQ/T	
7104 90	
1760/OHM	
1760PT	
1760DGT-R3	
1996MQ/GM	
1996VPG	
7105 6	
7109A	
7109D	
52MQ	M49
89MQ	M49
910MQ/PE	M108
910MQ/B	M108
910MQ/TX	M108
910MQ/XZN	M108
910MQ/21	M108
910MQ/22	M108
910MQ/T	M108
910MQ/55	M108
1048MQ	M161
1082MQ	M161
1128MQ	M161
1150MQ	M161
1162MQ	M161
1164MQ	M161
1272MQ	M161
1274MQ	M161
1777MQ/U	M161

5902MT

Composition de 106 outils pour matériel agricole et engins de chantier

► Réparation automobile

Quantité/Description

Quantité/Description	Réf. Beta
2 chasse-clous Ø 3 - 4 mm	30
2 chasse-goupilles Ø 6 - 8 mm	31
1 pointeau Ø 4 mm	32
2 burins nervurés 150 - 200 mm	35
18 clés mixtes 6+14 - 17 - 19 - 22 - 24 - 27 - 30 - 32 - 36 - 41 mm	42
10 clés polygonales contre - coudées 6x7 - 8x9 - 10x11 - 12x13 - 14x15 - 16x17 - 18x19 - 20x22 - 24x27 - 30x32 mm	90
10 clés mâles 6 pans coudées ○ 1,5+12 mm	96N/B10
17 douilles 6 pans avec carré conducteur femelle 1/2" ○ 10+22 - 24 - 27 - 30 - 32 mm	920A
1 rallonge - 1/2" 125 mm	920/21
1 rallonge - 1/2" 255 mm	920/22
1 cardan 1/2"	920/25
1 poignée coulissante 1/2"	920/42
1 cliquet réversible à glissières 1/2" ⊕	920/50
11 douilles 6 pans 3/4" ○ 22 - 24 - 27 - 30 - 32 - 36 - 41 - 46 - 50 - 55 - 60 mm	928A
1 rallonge - 3/4" 200 mm	928/21
1 poignée articulée 3/4"	928/36A
1 poignée coulissante 3/4"	928/42
1 cliquet réversible 3/4" ⊕	928/55
1 pince levier à broche et à bec	964
1 Pince multiprise entrepassée 250 mm	1048N
1 pince-étau à becs arrondis	1055
1 pince coupante diagonale à faible effort de coupe, branchées gainées confort bi-matières, finition industrielle 160 mm	1084GBM
1 ciseaux d'électricien	1128BMX
1 pince universelle, branches gainées confort bi-matières, modèle grande capacité, finition industrielle 180 mm	1150GBM
1 pince à becs demi-ronds longs striés, branches gainées confort bi-matières, finition industrielle 160 mm	1166GBM
4 tournevis avec 6 pans pour vis à fente ● 6,5x150 - 8x175 - 10x200 - 12x250 mm	1260E
3 tournevis avec 6 pans pour vis Phillips® ⊕ PH2x150 - PH3x175 - PH4x200 mm	1262E
1 marteau de mécanicien modèle américain 900 g	1377
1 maillet à embouts nylon, manche en bois Ø 35 mm	1390
1 jauge d'épaisseur	1708/20
1 grattoir triangulaire 200 mm	1717B
5 limes demi-douces 200 mm	1719BMA...S5
1 monture de scie à métaux	1725



CHF



5902MT

2,770.00 059021053

Composition conseillée avec RSC22 - RSC23 - RSC23C - C39T

5902MT/AS

Composition de 99 outils pour engins de chantier

► Réparation automobile

Quantité/Description	Réf. Beta
2 chasse-clous Ø 3 - 4 mm	30
2 chasse-goupilles Ø 6 - 8 mm	31
1 pointeau Ø 4 mm	32
2 burins nervurés 150 - 200 mm	35
20 clés mixtes 1/4+1.1/2"	42AS
6 clés polygonales contre - coudées 1/4x5/16 - 3/8x7/16 - 1/2x9/16 - 5/8x3/4 - 11/16x13/16 - 7/8x15/16"	90AS
11 clés mâles 6 pans coudées Ø 3/64+3/8"	96AS/B11
10 douilles 12 pans 1/2" ○ 7/16 - 1/2 - 9/16 - 5/8 - 11/16 - 3/4 - 13/16 - 7/8 - 15/16 - 1"	920AS
1 rallonge - 1/2" 125 mm	920/21
1 rallonge - 1/2" 255 mm	920/22
1 cardan 1/2"	920/25
1 poignée coulissante 1/2"	920/42
1 cliquet réversible à glissières 1/2" Ⓢ	920/50
12 douilles 6 pans 1/4" ○ □ 3/4", 7/8 - 15/16 - 1 - 1.1/16 - 1.1/8 - 1.1/4 - 1.5/16 1.1/2 - 1.5/8 - 1.11/16 - 1.7/8 - 2"	928AS
1 rallonge - 3/4" 200 mm	928/21
1 poignée articulée 3/4"	928/36A
1 poignée coulissante 3/4"	928/42
1 cliquet réversible 3/4" Ⓢ	928/55
1 pince levier à broche et à bec	964
1 Pince multiprise entrepassée 250 mm	1048N
1 pince-étou à becs arrondis	1055
1 pince coupante diagonale à faible effort de coupe, branchées gainées confort bi-matières, finition industrielle 160 mm	1084GBM
1 ciseaux d'électricien	1128BMX
1 pince universelle, branches gainées confort bi-matières, modèle grande capacité, finition industrielle 180 mm	1150GBM
1 pince à becs demi-ronds longs striés, branches gainées confort bi-matières, finition industrielle 160 mm	1166GBM
4 tournevis avec 6 pans pour vis à fente ● 6,5x150 - 8x175 - 10x200 - 12x250 mm	1260E
3 tournevis avec 6 pans pour vis Phillips® ⚙ PH2x150 - PH3x175 - PH4x200 mm	1262E
1 marteau de mécanicien modèle américain 900 g	1377
1 maillet à embouts nylon, manche en bois Ø 35 mm	1390
1 jauge d'épaisseur 150 - 200 mm	1708/20
1 grattoir triangulaire 200 mm	1717B
5 limes demi-douces 200 mm	1719BMA...S5
1 monture de scie à métaux	1725



CHF



5902MT/AS

2,900.00 059021054

Composition conseillée avec RSC22 - RSC23 - RSC23C - C39T

5904VG/2M

Composition de 170 outils en plateaux mousse compacte

► Réparation automobile

Quantité/Description

- 16 clés mixtes 6÷21 mm
- 5 clés mixtes 22 - 24 - 27 - 30 - 32 mm
- 8 clés mâles 6 pans à poignée en T ⌀ 2-2,5-3-4-5-6-7-8 mm
- 5 tournevis pour vis Torx® ⌀ T10-T15-T20-T25-T30
- 7 embout avec entraînement hexagonal ⌀ 4-5-6-7-8-10-12 mm
- 7 embout avec entraînement hexagonal ⌀ 4-5-6-7-8-10-12 mm
- 5 embout avec entraînement hexagonal ⌀ 5-6-8-10-12 mm
- 5 embout avec entraînement hexagonal ⌀ 5-6-8-10-12 mm
- 7 embout avec entraînement hexagonal ⌀ T20-T25-T30-T40-T45-T50-T55
- 6 embout avec entraînement hexagonal ⌀ T25-T30-T40-T45-T50-T55
- 7 Embout avec entraînement hexagonal Tamper Resistant Torx® ⌀ T20-T25-T30-T40-T45-T50-T55
- 1 douille porte-embouts pour 867
- 1 douille porte-embouts pour 867
- 5 tournevis pour vis à fente ⌀ 3x75 - 3,5x100 - 4x125 - 5,5x150 - 6,5x150 mm
- 3 tournevis pour vis Phillips® ⌀ PH0x60 - PH1x80 - PH2x100 mm
- 1 tournevis à lame courte pour vis à fente ⌀ 4x30 mm
- 1 tournevis à lame courte pour vis Phillips® ⌀ PH1x30 mm
- 5 Embout coloré pour visseuses pour vis à fente ⌀ 0,5x3 - 0,6x4,5 - 0,8x5,5 - 1x5,5 - 1,2x6,5 mm
- 8 Embout coloré pour visseuses pour vis 6 pans creux ⌀ 2 - 2,5 - 3 - 4 - 5 - 6 - 8 - 10 mm
- 5 Embout coloré pour visseuses pour vis Phillips® ⌀ PH0 - PH1 - PH2 - PH3 - PH4
- 4 Embout coloré pour visseuses pour vis Pozidriv® - Supadriv® ⌀ PZ1 - PZ2 - PZ3 - PZ4
- 11 Embout coloré pour visseuses pour vis Torx® ⌀ T6-T7-T8-T9-T10-T15-T20-T25-T27-T30-T40
- 8 Embout coloré pour visseuses pour vis Tamper Resistant Torx® ⌀ T9-T10-T15-T20-T25-T27-T30-T40
- 1 Poignée porte-embouts à bague de déverrouillage rapide 230 mm
- 1 Cliquet réversible porte-embouts 100 mm
- 1 rallonge porte-embouts magnétique 80 mm
- 1 porte-douille pour visseuses ■ 1/4 - □ 1/4
- 2 burins nervurés 100 - 200 mm
- 1 marteau de mécanicien 300 g
- 1 maillet à embouts nylon, manche en bois Ø 35 mm
- 1 rallonge angulaire - 1/2" 125 mm
- 1 rallonge angulaire - 1/2" 250 mm
- 1 cardan 1/2"
- 1 poignée coulissante 1/2"
- 1 cliquet réversible 1/2" ⌀
- 19 douilles 6 pans avec carré conducteur femelle 1/2" ⌀ 10÷24 - 26 - 27 - 30 - 32 mm
- 1 pince à becs demi-ronds longs ≡ 180 mm
- 1 Pince à becs demi-ronds longs ● 160 mm
- 1 Pince coupante diagonale à faible effort de coupe ≡ 160 mm
- 1 pinces pour circlips intérieurs à becs droits ⌀ 180 mm
- 1 pinces pour circlips intérieurs à becs coudés ⌀ 170 mm
- 1 pinces pour circlips extérieurs à becs droits ⌀ 175 mm
- 1 pinces pour circlips extérieurs à becs coudés ● 175 mm

Réf. Beta	TR
42	M05
42	M06
96T	M50
97TTX	M55
867PE	M86
867PE/L	M86
867XZ/N	M86
867XZ/NL	M86
867TX	M86
867TX/L	M86
867RTX	M86
867/1	M86
867/2	M86
1260	M208
1262	M208
1260N	M208
1262N	M208
860LP	M85
860PE	M85
860PH	M85
860PZ	M85
860TX	M85
860RTX	M85
851SR	M85
860/55	M85
882P	M85
892/0	M85
35	M234
1370	M234
1390	M234
920AN/125	M83
920AN/250	M83
920/25	M83
920/42	M83
920/55	M83
920A	M83
1150BM	M136
1166BM	M136
1084BM	M136
1032	M145
1034	M145
1036	M145
1038	M145



M05 M06 VPM3



M50 M55 M86



M208 M85 M234



M83 M136 M145

CHF

5904VG/2M

2,215.00 059041198

Composition conseillée avec RSC24 - RSC24A - RSC24AXL - C37 - C39
RSC24L - RSC24L-CAB - C59 - C55 - C39T - C39SM - C39MD - RSC23T - RSC28

5904VG/2T

Composition de 99 outils en plateaux thermoformés rigides en ABS

► Réparation automobile

Quantité/Description

- 16 clés mixtes 6+21 mm
- 5 clés mixtes 22 - 24 - 27 - 30 - 32 mm
- 19 douilles 6 pans avec carré conducteur femelle 1/2" ⌀ 10+24 - 26 - 27 - 30 - 32 mm
- 5 douilles tournevis pour vis 6 pans creux carré femelle 1/2" ⌀ 5 - 6 - 8 - 10 - 12 mm
- 1 rallonge - 1/2" 125 mm
- 1 rallonge - 1/2" 255 mm
- 1 cardan 1/2"
- 1 poignée coulissante 1/2"
- 1 cliquet réversible 1/2" Ⓢ
- 1 Pince multiprise entrepassée 250 mm
- 1 pince - étau à becs droits 240 mm
- 1 Pince coupante diagonale à faible effort de coupe ⚡ 160 mm
- 1 Pince à becs demi-ronds longs ● 160 mm
- 1 pince à becs demi-ronds longs ≡ 180 mm
- 1 pinces pour circlips intérieurs à becs droits ○ 180 mm
- 1 pinces pour circlips extérieurs à becs droits ● 175 mm
- 1 pinces pour circlips intérieurs à becs coudés ○ 170 mm
- 1 pinces pour circlips extérieurs à becs coudés ● 175 mm
- 2 burins nervurés 100 - 200 mm
- 1 marteau de mécanicien 300 g
- 1 maillet à embouts nylon, manche en bois Ø 35 mm
- 4 tournevis pour vis à fente ● 3x75 - 4x100 - 5,5x150 - 6,5x150 mm
- 3 tournevis pour vis Phillips® Ⓢ PH0x60 - PH1x80 - PH2x100 mm
- 8 clés à fourches 6x7 - 8x9 - 10x11 - 12x13 - 14x15 - 16x17 - 18x19 - 20x22 mm
- 9 clés mâles 6 pans coudées ○ 1,5 - 2 - 2,5 - 3 - 4 - 5 - 6 - 8 - 10 mm
- 6 clés mâles 6 pans à poignée en T ○ 2 - 2,5 - 3 - 4 - 5 - 6 mm
- 6 tournevis pour vis Torx® Ⓢ T10 - T15 - T20 - T25 - T27 - T30

Réf. Beta	TR
42	T05
42	T06
920A	T80
920ME	T80
920/21	T80
920/22	T80
920/25	T80
920/42	T80
920/55	T80
1048N	T153
1052	T153
1084	T138
1166	T138
1150	T138
1032	T145
1036	T145
1034	T145
1038	T145
35	T234
1370	T234
1390	T234
1260	T208
1262	T208
55	T33
96/SC9	T33
96T	T52
97TTX	T55



T05 T06 T80



T153 T138 T145 T234



T208 T33 T52 T55

CHF

5904VG/2T

1,880.00 059041191

Composition conseillée avec RSC24 - RSC24A - RSC24AXL - C37 - C39
RSC23T - C39T - RSC24L - RSC24L-CAB - C59 - C55 - RSC28 - C39SM - C39MD

5904VG/3

Composition de 132 outils

► Réparation automobile

Quantité/Description	Réf. Beta
6 Ø 2+8 mm	31/B6N
1 pointeau Ø 5 mm	32
1 burins nervurés 200 mm	35
17 clés mixtes 6+22 mm	42
8 clés à fourches 6x7 - 8x9 - 10x11 - 12x13 - 14x15 - 16x17 - 18x19 - 20x22 mm	55
9 clés mâles 6 pans coudées Ø 1,5 - 2 - 2,5 - 3 - 4 - 5 - 6 - 8 - 10 mm	96N/SC9
11 clés mâles 6 pans à poignée en T Ø 2+10 mm	96T/SP11
13 clés mâles coudées pour vis à empreinte Torx® ⚙ T6+T50	97TX/B13
1 Clé à molette à ouverture graduée, chromée 300 mm	111E
13 douilles 6 pans 1/2" sur rail Ø 10+22 mm	920A/SB13
1 rallonge - 1/2" 125 mm	920/21
1 rallonge - 1/2" 255 mm	920/22
1 cardan 1/2"	920/25
1 poignée coulissante 1/2"	920/42
1 cliquet réversible à glissières 1/2" ⚙	920/50
6 clés à béquille à cardan Ø 8 - 10 - 12 - 13 - 17 - 19 mm	952
1 pince levier plate coudée 450 mm	965
2 pinces pour circlips intérieurs à becs droits Ø 180 - 225 mm	1032
2 pinces pour circlips intérieurs à becs coudés Ø 170 - 210 mm	1034
2 pinces pour circlips extérieurs à becs droits Ø 175 - 225 mm	1036
2 pinces pour circlips extérieurs à becs coudés Ø 175 - 220 mm	1038
1 Pince multiprise entrecroisée 250 mm	1048N
1 pince - étau à becs droits 240 mm	1057A
1 pince coupante diagonale à faible effort de coupe, branchées gainées confort bi-matières, finition industrielle 200 mm	1084GBM
1 pince coupante frontale articulée, série lourde 200 mm	1092V
1 cisaille type américain coupe droite 250 mm	1112
1 ciseaux d'électricien	1128BMX
1 pince universelle, branches gainées confort bi-matières, modèle grande capacité, finition industrielle 180 mm	1150GBM
4 tournevis pour vis à fente ⚪ 3x75 - 4x100 - 5,5x125 - 6,5x150 mm	1260
1 tournevis à lame courte pour vis à fente ⚪ 6,5x30 mm	1260N
2 tournevis avec 6 pans pour vis à fente ⚪ 8x175 - 10x200 mm	1260E
3 tournevis pour vis Phillips® ⚪ PH0x100 - PH1x120 - PH2x100 mm	1262
1 tournevis à lame courte pour vis Phillips® ⚪ PH2x30 mm	1262N
1 tournevis avec 6 pans pour vis Phillips® ⚪ PH3x175 mm	1262E
1 tournevis à lame longue pour vis Phillips® ⚪ PH2x400 mm	1262L
1 tournevis à lame longue fraisée pour vis à fente ⚪ 6,5x400 mm	1264L
1 marteau de mécanicien 500 g	1370
1 maillet à embouts nylon, manche en bois Ø 45 mm	1390
1 clé à sangle pour filtres à huile	1491
1 jauge d'épaisseur	1708/20
5 limes demi-douces 200 mm	1719BMA...S5
1 monture de scie à métaux	1726BM
1 Burette tôle 200 cc	1751N



CHF



5904VG/3 2,960.00 059041062

Composition conseillée avec RSC24 - RSC24A - RSC24AXL - C37 - C39 à 7 - 8 tiroirs RSC24L - RSC24L-CAB - C59 - C55

5904VG/3T

Composition de 102 outils en plateaux thermoformés rigides en ABS

► Réparation automobile

Quantité/Description

Quantité/Description	Réf. Beta	TR
21 clés mixtes 6-7-8-9-10-11-12-13-14-15-16-17 18-19-20-21-22-24-27-30-32 mm	42	T05-T06
8 clés à fourches 6x7-8x9-10x11-12x13-14x15 16x17-18x19-20x22 mm	55	T33
9 clés mâles 6 pans coudées \odot 1,5÷10 mm	96/SC9	T33
6 clés mâles 6 pans à poignée en T \odot 2-2,5-3-4-5-6 mm	96T	T52
8 clés à béquille à cardan \odot 7-8-10-12-13-14-17-19 mm	952	T63
19 douilles 6 pans avec carré conducteur femelle 1/2" \odot 10-11-12-13-14-15-16-17-18-19 20-21-22-23-24-26-27-30-32 mm	920A	T83
1 rallonge - 1/2" 125 mm	920/21	T83
1 rallonge - 1/2" 255 mm	920/22	T83
1 cardan 1/2"	920/25	T83
1 poignée coulissante 1/2" 305 mm	920/42	T83
1 cliquet réversible 1/2" \oplus	920/55	T83
1 Pince coupante diagonale à faible effort de coupe ∇ 160 mm	1084BM	T137
1 pince à becs demi-ronds longs \equiv 180 mm	1150BM	T137
1 Pince à becs demi-ronds longs \bullet 160 mm	1166BM	T137
1 pinces pour circlips intérieurs à becs droits \odot 180 mm	1032	T145
1 pinces pour circlips intérieurs à becs coudés \odot 170 mm	1034	T145
1 pinces pour circlips extérieurs à becs droits \bullet 175 mm	1036	T145
1 pinces pour circlips extérieurs à becs coudés \bullet 175 mm	1038	T145
1 pince - étau à becs droits 240 mm	1052	T153
1 Pince multiprise entrecroisée 250 mm	1048N	T153
7 tournevis pour vis à fente \bullet 2,5x50 - 3x75 - 3,5x100 - 4x125 - 5,5x100 - 5,5x150 - 6,5x150 mm	1260	T199
6 tournevis pour vis Phillips® \oplus PH0x60 - PH0x100 - PH1x80 PH1x120 - PH2x100 - PH2x150 mm	1262	T202
2 burins nervurés 100-200 mm	35	T234
1 marteau de mécanicien 300 g	1370	T234
1 maillet à embouts nylon, manche en bois \varnothing 35 mm	1390	T234
1 bac de rangement	VP5	



T199 T202 T83



T145 T153 T137 T234



T52 T33 T05 T06



T63 VP5

CHF

5904VG/3T 2,175.00 059041510

Composition conseillée avec C24S - C24SA - C37 - C39
C24SL - C24SL/CAB - C59 - C55 - C23ST - C39T - C28 - C39SM - C39MD

5904VG/5T

Composition de 153 outils en plateaux thermoformés rigides en ABS

► Réparation automobile

Quantité/Description

- 5 douilles tournevis pour vis 6 pans creux carré femelle 1/2" ⌀ 5 - 6 - 8 - 10 - 12 mm
- 1 rallonge - 1/2" 125 mm
- 1 rallonge - 1/2" 255 mm
- 1 cardan 1/2"
- 1 poignée coulissante 1/2"
- 1 cliquet réversible 1/2" Ⓞ
- 19 douilles 6 pans avec carré conducteur femelle 1/2" ⌀ 10+24 - 26 - 27 - 30 - 32 mm
- 16 clés mixtes 6÷21 mm
- 5 clés mixtes 22 - 24 - 27 - 30 - 32 mm
- 8 clés à béquille à cardan ⌀ 7 - 8 - 10 - 12 - 13 - 14 - 17 - 19 mm
- 1 bac de rangement
- 1 pinces pour circlips intérieurs à becs droits ⌀ 180 mm
- 1 pinces pour circlips intérieurs à becs coudés ⌀ 170 mm
- 1 pinces pour circlips extérieurs à becs droits ● 175 mm
- 1 pinces pour circlips extérieurs à becs coudés ● 175 mm
- 7 tournevis pour vis Phillips® ● 2,5x50 - 3x75 - 3,5x100 - 4x125 - 5,5x100 - 5,5x150 - 6,5x150 mm
- 5 tournevis pour vis Torx® Ⓞ T25 - T27 - T30 - T40 - T45
- 6 clés mâles 6 pans à poignée en T ⌀ 2 - 2,5 - 3 - 4 - 5 - 6 mm
- 8 clés à fourches 6x7 - 8x9 - 10x11 - 12x13 - 14x15 - 16x17 - 18x19 - 20x22 mm
- 9 clés mâles 6 pans coudées ⌀ 1,5 - 2 - 2,5 - 3 - 4 - 5 - 6 - 8 - 10 mm
- 3 tournevis pour vis Phillips® ● 8x150 - 8x200 - 10x200 mm
- 2 tournevis à lame courte pour vis à fente ● 4x30 - 6,5x30 mm
- 6 tournevis pour vis Phillips® Ⓞ PH0x60 - PH0x100 - PH1x80 - PH1x120 - PH2x100 - PH2x150 mm
- 2 tournevis pour vis Phillips® Ⓞ PH3x150 - PH4x200 mm
- 2 tournevis à lame courte pour vis Phillips® Ⓞ PH1x30 - PH2x30 mm
- 2 burins nervurés 100 - 200 mm
- 1 marteau de mécanicien 300 g
- 1 maillet à embouts nylon, manche en bois Ø 35 mm
- 1 pince à becs demi-ronds longs = 180 mm
- 1 Pince à becs demi-ronds longs ● 160 mm
- 1 Pince coupante diagonale à faible effort de coupe ≤ 160 mm
- 6 embouts de visseuse pour vis à empreinte Torx® Ⓞ T6+T15
- 8 embouts de visseuse pour vis à empreinte Torx® Ⓞ T20+T55
- 1 douille porte-embouts
- 1 douille porte-embouts
- 6 douilles pour écrous à empreinte Torx®, 1/4" Ⓞ E4+E10
- 7 douilles pour écrous à empreinte Torx®, 1/2" Ⓞ E12+E24
- 3 douilles tournevis pour vis à empreinte Torx® Ⓞ T55L - T60 - T70L
- 1 Pince multiprise entrepassée 250 mm
- 1 pince - étai à becs droits 240 mm

Réf. Beta	TR
920ME	T80
920/21	T80
920/22	T80
920/25	T80
920/42	T80
920/55	T80
920A	T80
42	T05
42	T06
952	T63
VP6	VP6
1032	T145
1034	T145
1036	T145
1038	T145
1290	T170
1297TX	T176
96T	T52
55	T33
96N/SC9	T33
1290	T171
1290N	T171
1292	T172
1292	T173
1292N	T173
35	T234
1370	T234
1390	T234
1150BM	T137
1166BM	T137
1084BM	T137
861TX	T112
866TX	T112
895/1	T112
895/6	T112
900FTX	T112
920FTX	T112
920TX	T112
1048N	T153
1052	T153



T80 T05 T06



T63 VP6



T145 T170 T176 T52



T33 T171 T172 T173



T234 T137 T112 T153

CHF

5904VG/5T

3,030.00 059041196

Composition conseillée avec RSC24 à 7 - 8 tiroirs - RSC24A à 7 - 8 tiroirs - RSC24AXL - C37 à 7 - 8 tiroirs - C39 à 7 - 8 tiroirs RSC24L - RSC24L-CAB - C59 - C55 - RSC23T - RSC28 - C39MD - C39SM



5905VG/1

Composition de 94 outils pour carrossier

► Réparation automobile

Quantité/Description	Réf. Beta
1 chasse-clous Ø 4 mm	30
6 Ø 2 - 3 - 4 - 5 - 6 - 8 mm	31/B6N
1 pointeau Ø 4 mm	32
1 burins plats 150 mm	34
1 bédanes 150 mm	36
17 clés mixtes 6+22 mm	42
10 clés mâles 6 pans coudées Ø 1,5+12 mm	96/B10
1 Clé à molette à ouverture graduée, phosphatée 300 mm	111EN
12 Clé à douille emmanchée, série longue Ø 4+14 mm	943BX
1 pince levier plate coudée 450 mm	965
1 Pince multiprise entrepassée 250 mm	1048N
1 pince - étau à becs droits 240 mm	1052
1 pince-étau pour cornière 280 mm	1060AL
1 pince coupante diagonale à faible effort de coupe, branchées gainées confort bi-matières, finition industrielle 160 mm	1084GBM
1 tenaille type russe 250 mm	1098PL
1 cisaille bichantourneuse coupe droite	1122
1 ciseaux d'électricien	1128BMX
1 pince universelle, branches gainées confort bi-matières, modèle grande capacité, finition industrielle 180 mm	1150GBM
1 tournevis pour vis Dzus®	1201E/DZ
4 tournevis pour vis à fente 3x75 - 4x100 - 5,5x150 - 6,5x150 mm	1260
1 tournevis à lame courte pour vis à fente 4x30 mm	1260N
2 tournevis avec 6 pans pour vis à fente 10x175 - 12x200 mm	1260E
3 tournevis pour vis Phillips® PH0x60 - PH1x80 - PH2x100 mm	1262
1 tournevis à lame courte pour vis Phillips® PH1x30 mm	1262N
1 tournevis avec 6 pans pour vis Phillips® PH3x175 mm	1262E
7 tournevis pour vis Torx® T6 - T8 - T10 - T15 - T20 - T25 - T30	1267TX
1 tas virgule 1350 g	1303
1 tas courbure	1305
1 tas talon	1306
1 tas universel	1310
1	1314
1 palette simple étroite bombée	1326
1 palette simple longue bombée	1327
1 palette double col de cygne	1330
1 monture plate et flexible 9"	1338A
1 burin plat de carrossier	1342PM
1 marteau à planer tête ronde bombée	1345
1 marteau à rétreindre Ø 40 mm	1357Z/45
1 marteau de mécanicien 300 g	1370
1 maillet à embouts nylon, manche en bois Ø 35 mm	1390
1 mètre à ruban 5 m	1692

CHF



5905VG/1

2,680.00 059051058

Composition conseillée avec C25

5905VG/2

Composition de 118 outils

► Réparation automobile

Quantité/Description	Réf. Beta
6 2 poinçons de dérive, 1 poinçon central, 2 ciseaux plats et 1 ciseau à cape en portefeuille enroulable en polyester	38/B6N
13 clés mixtes 6+14 - 17 - 19 - 22 - 24 mm	42
13 clés à fourches 6x7 - 8x9 - 10x11 - 12x13 - 14x15 - 16x17 - 18x19 - 20x22 - 21x23 - 24x26 - 25x28 - 27x29 - 30x32 mm	55
3 clés polygonales demi - lune 11x13 - 14x17 - 19x22 mm	83
10 clés mâles 6 pans coudées \odot 1,5+12 mm	96N/B10
6 tournevis pour vis Torx® \odot T10 - T15 - T20 - T25 - T30 - T40	97TTX
2 douilles à choc carré conducteur femelle 1/2" \odot 17 - 19 mm	720
20 douilles 6 pans avec carré conducteur femelle 1/2" \odot 10+24 - 26 - 27 - 28 - 30 - 32 mm	920A
1 rallonge - 1/2" 125 mm	920/21
1 rallonge - 1/2" 255 mm	920/22
1 cardan 1/2"	920/25
1 poignée coulissante 1/2"	920/42
1 cliquet réversible 1/2" \odot	920/55
8 clés à béquille à cardan \odot 7 - 8 - 10 - 11 - 13 - 14 - 17 - 19 mm	952
1 clés à bougies à cardan	959
1 clé en croix pour écrous de roues \odot 17x19x22x \blacksquare 1/2"	979
1 pinces pour circlips intérieurs à becs droits \odot 180 mm	1032
1 pinces pour circlips intérieurs à becs coudés \odot 170 mm	1034
1 pinces pour circlips extérieurs à becs droits \bullet 175 mm	1036
1 pinces pour circlips extérieurs à becs coudés \bullet 175 mm	1038
1 Pince multiprise entrecassée 250 mm	1048N
1 pince - étau à becs droits 240 mm	1052
1 pince coupante diagonale à faible effort de coupe, branchées gainées confort bi-matières, finition industrielle \llcorner 160 mm	1084GBM
1 cisaille bichantourneuse coupe droite 250 mm	1122
1 ciseaux d'électricien	1128BMX
1 pince universelle, branches gainées confort bi-matières, modèle grande capacité, finition industrielle \equiv 180 mm	1150GBM
1 pince à becs demi-ronds longs striés, branches gainées confort bi-matières, finition industrielle \bullet 160 mm	1166GBM
8 tournevis pour vis à fente \bullet 2,5x50 - 3x75 - 3,5x100 - 4x125 - 5,5x125 - 6,5x150 - 8x200 - 10x200 mm	1260
2 tournevis avec 6 pans pour vis à fente \bullet 10x200 - 12x250 mm	1260E
1 tournevis à lame courte pour vis à fente \bullet 6,5x30 mm	1260N
4 tournevis pour vis Phillips® \oplus PH0x60 - PH1x80 - PH2x100 - PH3x150 mm	1262
1 marteau de mécanicien 400 g	1370
1 maillet à embouts nylon, manche en bois \odot 35 mm	1390
1 clé à sangle pour filtres à huile	1491
1 clé à sangle pour filtre à huile 3+48 V	1498



CHF



5905VG/2

2,510.00 059051044

Composition conseillée avec C25

5908VG/2T

Composition de 212 outils en plateaux thermoformés rigides en ABS

► Réparation automobile

Quantité/Description



T05 T06 T31



T80 T145 T146



T167 T168
+96N +1771



T63 T209



T55 T111 T113 T236



T264 T234 T153 T138



T105 T106 VP6



Quantité/Description	Réf. Beta	TR
16 clés mixtes 6+21 mm	42	T05
5 clés mixtes 22 - 24 - 27 - 30 - 32 mm	42	T06
5 chasse-goupilles Ø 2 - 3 - 4 - 5 - 6 mm	31	T31
1 pointe Ø 4 mm	32	T31
12 clés à fourches 6x7 - 8x9 - 10x11 - 12x13 - 14x15 - 16x17	55	T31
18x19 - 20x22 - 21x23 - 24x26 - 27x29 - 30x32 mm		
9 clés mâles 6 pans coudées ○ 1,5 - 2 - 2,5 - 3 - 4 - 5 - 6 - 8 - 10 mm	96N/SC9	T31
5 douilles tournevis pour vis 6 pans creux carré femelle 1/2" ○ 5 - 6 - 8 - 10 - 12 mm	920ME	T80
1 rallonge - 1/2" 125 mm	920/21	T80
1 rallonge - 1/2" 255 mm	920/22	T80
1 cardan 1/2"	920/25	T80
1 poignée coulissante 1/2"	920/42	T80
1 cliquet réversible 1/2" Ⓢ	920/55	T80
19 douilles 6 pans avec carré conducteur femelle 1/2" ○ 10+24 - 26 - 27 - 30 - 32 mm	920A	T80
1 pincettes pour circlips intérieurs à becs droits ○ 180 mm	1032	T145
1 pincettes pour circlips intérieurs à becs coudés ○ 170 mm	1034	T145
1 pincettes pour circlips extérieurs à becs droits ● 175 mm	1036	T145
1 pincettes pour circlips extérieurs à becs coudés ● 175 mm	1038	T145
1 pincettes pour circlips intérieurs à becs droits ○ 140 mm	1032	T146
1 pincettes pour circlips intérieurs à becs droits ○ 225 mm	1032	T146
1 pincettes pour circlips extérieurs à becs droits ● 140 mm	1036	T146
1 pincettes pour circlips extérieurs à becs droits ● 225 mm	1036	T146
9 tournevis pour vis à fente ● 3x75 - 3x100 - 4x100 - 4x150 - 5,5x100 - 5,5x150 - 6,5x150 - 8x150 - 10x200 mm	1260	T167
2 tournevis à lame courte pour vis à fente ● 4x30 - 6,5x30 mm	1260N	T167
7 tournevis pour vis Phillips®	1262	T168
● PH0x60 - PH0x100 - PH1x80 - PH1x120 - PH2x100 - PH2x150 - PH3x150 mm		
2 tournevis à lame courte pour vis Phillips® ● PH1x30 - PH2x30 mm	1262N	T168
8 clés à béquille à cardan ○ 7 - 8 - 10 - 12 - 13 - 14 - 17 - 19 mm	952	T63
2 tournevis à lame longue pour vis Phillips® ● PH1x400 - PH2x400 mm	1262L	T209
3 tournevis à lame longue fraisée pour vis à fente ● 3x300 - 4x400 - 5x400 mm	1264L	T209
6 tournevis pour vis Torx® ○ T10-T15-T20-T25-T27-T30	97TTX	T55
12 douilles à choc carré conducteur femelle 1/2" ○ 10-13-17-18-19-21-22-24-27-30-32 mm	720	T111
1 Rallonge carrés mâle et femelle 1/2" 125 mm	720/21	T111
3 ○ 17-19-21	720LC	T111
5 Douille tournevis pour vis 6 pans creux ○ 5L - 6L - 7L - 8L - 10L	920PE	T113
4 douilles tournevis pour vis à empreinte Torx® ○ T40L - T45L - T55L - T70L	920TX	T113
3 Douille tournevis pour vis XZN® ○ M6L - M8L - M12L	920XZN	T113
5 limes demi-douces 200 mm	1719BMA8/S5	T236
1 clé à sangle pour filtres à huile 110 mm	1491	T264
1 Douille carrée pour bouchons de vidange moteur ■ 10 mm	1494	T264
7 Douille mâle 6 pans pour bouchons de vidange moteur ○ 8-9-10-11-12-14-17 mm	1494E	T264
4 Douille mâle carrée pour bouchons de vidange moteur ○ 8-9,5-12-13 mm	1494Q	T264
1 Douille mâle triangulaire pour bouchons de vidange moteur Δ	1494T	T264
1 Douille mâle bouchons pour vidange moteur XZN® ○	1494XZN	T264
1 Clé de vidange	1496/C	T264
2 burins nervurés 100 - 200 mm	35	T234
1 marteau de mécanicien 300 g	1370	T234
1 maillet à embouts nylon, manche en bois Ø 35 mm	1390	T234
1 Pince multiprise entrecroisée 250 mm	1048N	T153
1 pince - étau à becs droits 240 mm	1052	T153
1 pince à becs demi-ronds longs = 180 mm	1150	T138
1 Pince à becs demi-ronds longs ● 160 mm	1166	T138
1 Pince coupante diagonale à faible effort de coupe ≧ 160 mm	1084	T138
11 douilles 6 pans 3/4" ○ 22-24-27-30-32-34-36-38-41-46-50 mm	928A	T105
1 rallonge - 3/4" 200 mm	928/21	T106
1 rallonge - 3/4" 380 mm	928/22	T106
1 poignée coulissante 3/4" 450 mm	928/42	T106
1 cliquet réversible 3/4" Ⓢ	928/55	T106
1 bac de rangement	VP6	VP6
4 clés mâles 6 pans coudées ○ 13-14-17-19 mm	96N	
1 Clé à molette à ouverture graduée, chromée 300 mm	111E	
1 pince levier plate coudée	965	
1 cisaille type américain coupe droite 250 mm	1112	
1 ciseaux d'électricien	1128BMX	
1 marteau de mécanicien 1000 g	1370	
1 jauge d'épaisseur	1708/20	
1 doigt magnétique flexible	1712	
1 miroir d'inspection télescopique	1715	
1 grattoir triangulaire 200 mm	1717B	
1 monture de scie à métaux 440 mm	1726	
1 Brosse à bougies en fils de acier	1737NX	
1 Burette tôle 200 cl	1751N	
1 cutter à lame sécable 18 mm avec lames	1771	

CHF

5,110.00 059081017

Composition conseillée avec RSC28

5935VG/1MB

Composition de 98 outils pour coffre C35, en plateaux mousse compacte

► Réparation automobile

Quantité/Description

- 21 clés mixtes 6-7-8-9-10-11-12-13-14-15-16-17-18-19-20-21-22-24-27-30-32 mm
- 8 clés à fourches 6x7-8x9-10x11-12x13-14x15
16x17-18x19-20x22 mm
- 1 Pince multiprise entrepassée 250 mm
- 4 tournevis pour vis à fente ● 3x75-4x100-5x125-6,5x150 mm
- 3 tournevis pour vis Phillips® ⊕ PH0x60-PH1x80-PH2x100 mm
- 6 tournevis pour vis Torx® ⊙ T8-T10-T15-T20-T25-T30
- 9 clés mâles 6 pans coudées à tête sphérique ○
- 6 clés mâles 6 pans à poignée en T ○ 2-2,5-3-4-5-6
- 1 pince - étau à becs droits 240 mm
- 19 douilles 6 pans avec carré conducteur femelle 1/2" ○ 10-11-12-13-14-15-16-17-18-19-20-21-
22-23-24-26-27-30-32 mm
- 1 rallonge - 1/2" 125 mm
- 1 rallonge - 1/2" 250 mm
- 1 cardan 1/2"
- 1 poignée coulissante 1/2"
- 1 cliquet réversible 1/2" ⊗
- 5 Douille tournevis pour vis 6 pans creux ○ 5-6-8-10-12 mm
- 1 pinces pour circlips intérieurs à becs droits ○ 180 mm
- 1 pinces pour circlips intérieurs à becs coudés ○ 170 mm
- 1 pinces pour circlips extérieurs à becs droits ● 175 mm
- 1 pinces pour circlips extérieurs à becs coudés ● 175 mm
- 1 burins nervurés 200 mm
- 1 Pince coupante diagonale à faible effort de coupe ◄ 160 mm
- 1 pince à becs demi-ronds longs ≡ 180 mm
- 1 Pince à becs demi-ronds longs ● 160 mm
- 1 marteau de mécanicien 500 g
- 1 maillet à embouts nylon, manche en bois 35 mm

Réf. Beta	TR
42	MB12
55	MB12
1048N	MB12
1260	MB46
1262	MB46
1267TX	MB46
96BPC/SC9	MB46
96T	MB46
1052	MB46
920A	MB39
920/21	MB39
920/22	MB39
920/25	MB39
920/42	MB39
920/55	MB39
920PE	MB39
1032	MB39
1034	MB39
1036	MB39
1038	MB39
35	MB39
1084BM	MB39
1150BM	MB39
1166BM	MB39
1370	MB39
1390	MB39



MB12



MB39



MB46

CHF

5935VG/1MB

2,130.00 059351321

Composition conseillée avec C35

5940SBK

Composition de 125 outils

► Réparation motocycles

Quantité/Description

- 1 chasse-clous Ø 2 mm
- 1 pointeau Ø 4 mm
- 1 burins plats 125 mm
- 10 clés mixtes 6 - 7 - 8 - 10 - 11 - 12 - 13 - 14 - 17 - 19 mm
- 6 clés à fourches 6x7 - 8x9 - 10x11 - 12x13 - 14x15 - 16x17 mm
- 9 clés mâles 6 pans coudées ○ 1,5 - 2 - 2,5 - 3 - 4 - 5 - 6 - 8 - 10 mm
- 1 Clé dynamométrique à déclenchement ZERO-RESET ⊗ 3/8", 10+50 Nm
- 54 jeu de 52 embouts avec entraînement hexagonal de 10 mm et 2 accessoires
- 17 jeu de 12 douilles et 5 accessoires
- 1 Réducteur carré mâle 1/2" et femelle 3/8"
- 2 douille à bougies ○ 14 - 16 mm
- 1 pince extra - longue à becs demi - ronds ● 283 mm
- 2 pinces pour circlips intérieurs à becs droits ○ 140 - 180 mm
- 1 pinces pour circlips extérieurs à becs droits ● 140x1,3 mm
- 1 pince coupante diagonale, branches gainées avec double couche de PVC antidérapant, finition industrielle ◄ 160 mm
- 1 ciseaux d'électricien
- 1 pince universelle, branches gainées avec double couche de PVC antidérapant, modèle grande capacité, finition industrielle ≡ 180 mm
- 1 tournevis pour vis Dzus® ●
- 4 tournevis pour vis à fente ● 3x75 - 4x100 - 5,5x100 - 6,5x150 mm
- 3 tournevis pour vis phillips® ⊕ PH0x60 - PH1x80 - PH2x100 mm
- 1 Tournevis détecteur de tension à pince crocodile ●
- 1 marteau de mécanicien 300 g
- 1 clé à sangle pour filtres à huile
- 1 jauge d'épaisseur
- 1 mini - monture de scie à métaux
- 1 Brosse à bougies en fils de cuivre
- 1 burette plastique 250 cc

Réf. Beta	TR
30	
32	
34	
42	
55	
96/SC9	
666/5	
867/C52	
920A/C12X	
910/16	
956C	
1009L/A	
1032	
1036	
1082G	
1128BM	
1150G	
1201E/DZ	
1201E	
1202E	
1254	
1370	
1491	
1708/13	
1725CR	
1737	
1754	

CHF

5940SBK

1,605.00 059401082

Composition conseillée en association avec C41S - C41H - C42S - C42H - C42S - C41S

5941VU/M

Composition de 64 outils pour chariot C41H, en plateau mousse compacte

► Maintenance générale

Quantité/Description

- 16 clés mixtes 6-7-8-9-10-11-12-13-14-15-16-17-18-19-21-22 mm
- 9 clés mâles 6 pans coudées
- 1 mètre à ruban 5 m
- 19 douilles 6 pans avec carré conducteur femelle 1/2" 10-11-12-13-14-15-16-17-18-19-20-21-22-23-24-26-27-30-32 mm
- 1 cardan 1/2"
- 1 poignée coulissante 1/2"
- 1 cliquet réversible 1/2"
- 2 rallonge angulaire - 1/2" 125-250 mm
- 1 Clé à molette à ouverture graduée, chromée 250 mm
- 1 Pince multiprise entrepassée 250 mm
- 1 Pince coupante diagonale 160 mm
- 1 ciseaux d'électricien 145 mm
- 1 pince universelle, branches gainées confort bi-matières, modèle grande capacité, finition industrielle 180 mm
- 1 pince à becs demi-ronds longs striés, branches gainées confort bi-matières, finition industrielle 160 mm
- 3 tournevis pour vis à fente 3,5x100-5,5x125-6,5x150 mm
- 3 tournevis pour vis Phillips PH0-PH1-PH2
- 1 marteau de mécanicien 300 g
- 1 cutter à lame sécable 18 mm avec lames 18 mm

Réf. Beta	TR
42	MC12
96/SC9	MC12
1692/5	MC12
920A	MC21
920/25	MC21
920/42	MC21
920/55	MC21
920AN	MC21
111E	
1048N	
1082GBM	
1128BMX	
1150GBM	
1166GBM	
1260	
1262	
1370	
1771	



MC21



MC12



CHF

5941VU/M

1,074.00 059411002

Composition conseillé en association avec C41

Beta

► Maintenance générale

Quantité/Description

- 21 clé mixte 6-7-8-9-10-11-12-13-14-15-16-17-18-19-20-21-22-24-27-30-32 mm
 9 clés mâles 6 pans coudées à tête sphérique \odot 1,5-2-2,5-3-4-5-6-8-10 mm
 1 douille porte-embouts \square 1/4 - \square 3/8
 1 douille porte-embouts \square 1/4 - \square 3/8
 1 douille porte-embouts \square 5/16 - \square 1/2
 13 douilles 6 pans avec carré conducteur femelle 1/4" \odot 4-4,5-5-5,5-6-7-8-9-10-11-12-13-14 mm
 9 douille 6 pans série longue \odot 5-6-7-8-9-10-11-12-13 mm
 5 douilles tournevis pour vis 6 pans creux carré femelle 1/4" \odot 3-4-5-6-7 mm
 4 douille tournevis pour vis à fente \bullet 0,8x4-1x5,5x1,2x6,5-1,2x8 mm
 4 douille tournevis pour vis Phillips® \oplus PH1-PH2-PH3-PH4
 7 douille tournevis pour vis Torx® \otimes T10-T15-T20-T25-T27-T30-T40
 1 augmentateur carré femelle 1/4" et mâle 3/8" \square 1/4 - \blacksquare 3/8
 1 rallonge - 1/4" 50 mm
 1 rallonge - 1/4" 100 mm
 1 rallonge - 1/4" 150 mm
 1 cardan avec carrés mâle et femelle 1/4"
 1 poignée emmanchée avec carré mâle 1/4" 176 mm
 1 poignée coulissante avec carré mâle 1/4" 115 mm
 1 cliquet réversible avec carré mâle 1/4" \oplus 125 mm
 17 douilles 6 pans 3/8" \odot 6-7-8-9-10-11-12-13-14-15-16-17-18-19-20-21-22 mm
 1 Réducteur carré femelle 3/8" et mâle 1/4" \square 3/8 - \blacksquare 1/4
 1 Réducteur carré mâle 1/2" et femelle 3/8" \square 3/8 - \blacksquare 1/2
 1 rallonge - 3/8" 125 mm
 1 rallonge - 3/8" 250
 1 cardan 3/8"
 1 poignée coulissante 3/8" 210 mm
 1 cliquet réversible avec carré mâle 3/8" \oplus 200 mm
 21 douilles 6 pans avec carré conducteur femelle 1/2"
 \odot 8-10-11-12-13-14-15-16-17-18-19-20-21-22-23-24-26-27-28-30-32 mm
 1 réducteur carré femelle 1/2" et mâle 3/8" \square 1/2 - \blacksquare 3/8
 1 cardan 1/2"
 1 rallonge angulaire - 1/2" 125 mm
 1 rallonge angulaire - 1/2" 250 mm
 1 poignée coulissante 1/2" 305 mm
 1 cliquet réversible 1/2" \oplus 275 mm
 3 douilles pour bougies 3/8" \odot 16 mm (5/8")-17,8 (11/16")-20,8 (13/16")
 6 tournevis pour vis à fente \bullet 04x2,5x50-0,5x3x75-0,8x4x100-1,0x5,5x125-1,2x6,5x150-1,2x8x200 mm
 1 tournevis à lame courte pour vis à fente \bullet 0,8x4x30 mm
 4 tournevis pour vis phillips® \oplus PH0x60-PH1x80PH2x100PH3x150 mm
 1 tournevis à lame courte pour vis phillips® \oplus PH1x30 mm
 12 tournevis pour vis torx® \otimes T06-T07-T08-T09-T10-T15-T20-T25-T27-T30-T40-T45
 1 tournevis détecteur de tension \bullet 0,5x3,5x100 mm
 1 pinces pour circlips intérieurs à becs droits \odot 180 mm
 1 pinces pour circlips intérieurs à becs coudés \odot 170 mm
 1 pinces pour circlips extérieurs à becs droits \bullet 175 mm
 1 pinces pour circlips extérieurs à becs coudés \bullet 175 mm
 1 Pince multiprise entrepassée 250 mm
 1 pince - étau à becs droits 240 mm
 1 pince - étau à becs droits 240 mm
 1 Pince coupante diagonale Z 160 mm
 1 Tenaille type russe 220 mm
 1 ciseaux d'électricien
 1 pince à becs demi-ronds longs = 180 mm
 1 Pince à becs demi-ronds longs \bullet 160 mm
 3 chasse-clous \emptyset 2-3-4 mm
 6 chasse-goupilles \emptyset 2-3-4-5-6-8 mm
 1 pointeau \emptyset 4 mm
 1 burins plats 150 mm
 2 burins nervurés 200-250 mm
 1 bédanes 125 mm
 1 marteau de mécanicien 500 g
 1 maillet à embouts nylon, manche en bois \emptyset 35 mm
 1 mètre à ruban 3 m
 1 aimant télescopique avec tête flexible
 1 Lime carrée demi-douce 200 mm
 1 Lime triangulaire demi-douce 200 mm
 1 Lime plate demi-douce 200 mm
 1 Lime demi-ronde demi-douce 200 mm
 1 lime ronde demi-douce 200 mm
 1 Brosse à bougies en fils de acier
 1 cutter à lame sécable 18 mm avec lames

Réf. Beta	TR
42	MM11
96BPC/SC9	MM11
895/1	MM105
895/3	MM105
895/6	MM105
900	MM105
900L	MM105
900ME	MM105
900LP	MM105
900PH	MM105
900TX	MM105
900/16	MM105
900/20	MM105
900/20L	MM105
900/21	MM105
900/25	MM105
900BG/30	MM105
900/42	MM105
900/55	MM105
910A	MM105
910/15	MM105
910/16	MM105
910/21	MM105
910/22	MM105
910/25	MM105
910/42	MM105
910/55	MM105
920A	MM105
920/15	MM105
920/25	MM105
920AN	MM105
920AN	MM105
920/42	MM105
920/55	MM105
956E	MM105
1201E	MM210
1201EN	MM210
1202E	MM210
1202EN	MM210
1207E/TX	MM210
1253	MM210
1032	MM129
1034	MM129
1036	MM129
1038	MM129
1048N	MM129
1052	MM129
1052	MM129
1082BM	MM129
1098	MM129
1128BM	MM129
1150BM	MM129
1166BM	MM129
30	MM230
31	MM230
32	MM230
34	MM230
35	MM230
36	MM230
1370	MM230
1390	MM230
1692	MM230
1712TF	MM230
1719BMA...Q	MM230
1719BMA...T	MM230
1719BMA...P	MM230
1719BMA...M	MM230
1719BMA...R	MM230
1737NX	MM230
1771	MM230

CHF

5945VUM 3.470.00 059451011

Composition conseillée avec C45



5954VG

Composition de 138 outils

► Réparation automobile

Quantité/Description	Réf. Beta
5 chasse-goupilles Ø 2-3-4-5-6 mm	31
1 pointeau Ø 4 mm	32
1 burins plats 125 mm	34
18 clés mixtes 6+22 - 24 mm	42
8 clés à fourches 6x7 - 8x9 - 10x11 - 12x13 - 14x15 - 16x17 - 18x19 - 20x22 mm	55
3 clés polygonales contre - coudées 12x13 - 14x15 - 17x19 mm	90
13 clés mâles 6 pans coudées Ø 2+10 - 12 mm	96
4 douilles à choc carré conducteur femelle 1/2" Ø 17 - 19 - 21 - 22 mm	720
20 douilles 6 pans avec carré conducteur femelle 1/2" Ø 10-11-12-13-14-15-16-17-18-19-20-21-22-23-24-26-27-28-30-32 mm	920A
1 rallonge - 1/2"	920/21
1 rallonge - 1/2"	920/22
1 cardan 1/2"	920/25
1 poignée coulissante 1/2"	920/42
1 cliquet réversible 1/2"	920/55
3 Clé à douille emmanchée, série longue Ø 8 - 10 - 13 mm	943BX
10 clés à béquille à cardan Ø 6 - 7 - 8 - 10 - 11 - 12 - 13 - 14 - 17 - 19 mm	952
3 douille à bougies Ø 16 - 17,8 - 20,8 mm	956C
1 pince levier à broche et à bec	964
1 pinces pour circlips intérieurs à becs droits ☺	1032
1 pinces pour circlips intérieurs à becs coudés ☹	1034
1 pinces pour circlips extérieurs à becs droits ●	1036
1 pinces pour circlips extérieurs à becs coudés ●	1038
1 Pince multiprise entrecroisée 250 mm	1048N
1 pince - étau à becs droits 240 mm	1052
1 pince - étau à becs longs 175 mm	1058
1 Pince coupante diagonale 160 mm	1082BM
1 ciseaux d'électricien	1128BMX
1 pince à becs demi-ronds longs 180 mm	1150BM
1 Pince à becs demi-ronds longs 160 mm	1166BM
1 Tournevis détecteur de tension à pince crocodile 6÷24V	1254
1 tournevis pour vis à fente 8 x 200 mm	1260
1 tournevis à lame courte pour vis à fente 6,5x30 mm	1260N
1 tournevis pour vis Phillips® 8 x 150 mm	1262
1 tournevis à lame courte pour vis Phillips® PH2x30 mm	1262N
5 tournevis pour vis Torx® T8 - T10 - T15 - T20 - T25	1267TX
8	1263/D8
1 marteau de mécanicien 300 g	1370
1 massette sans rebond Ø 35 mm	1392
1 pince pour ressorts de frein 210 mm	1470
1 pince à cosses non isolées	1603
1 mètre à ruban 5 m	1692
1 jauge d'épaisseur	1708/20
1 doigt magnétique flexible 1,8 kg	1712E/2
6 limes 160 mm	1720/B6
1 burette plastique 150 cc	1754

CHF



5954VG

2,960.00 059541054

Composition conseillée avec C54VG

5957VG

Composition de 174 outils

► Réparation automobile



Quantité/Description	Réf. Beta
6 chasse-goupilles Ø 2 - 3 - 4 - 5 - 6 - 8 mm	31/SP6
6 2 chasse - clous, 1 pointeau, 2 burins plats, 1 bédane, sur présentoir	38/SP6
17 clés mixtes 6-7-8-10-11-12-13-14-15-16-17-19-21-22-24-27-30 mm	42
12 clés à fourches 6x7 + 30x32 mm	55/S12X
8 clés mâles 6 pans à poignée en T 2 + 10 mm	96T/S8
1 clés mâles 6 pans coudées Ø 2,5 + 12 mm	96N/G7
8 clés mâles coudées pour vis Torx® T9 + T40	97TX/SC8
5 clé mâle coudée XZN® Ø M5 + M12	98XZN/B5
1 Clé à molette à ouverture graduée, chromée 250 mm	111E
1 Clé dynamométrique à déclenchement ZERO-RESET Ø 1/2", 40+200 Nm	666/20
13 douilles 6 pans 1/2" sur rail Ø 10+22 mm	920A/SB13
8 douilles 6 pans 1/2" sur rail Ø 23+32 mm	920A/SB8
4 douilles pour vis à fente 1/2" ● 1,2x6,5 - 1,2x8 - 1,6x9 - 2x12 mm	920LP
3 douilles pour vis Phillips® 1/2" ● PH2 - 3 - 4	920PH
1 rallonge - 1/2" 125 mm	920/21
1 rallonge - 1/2" 255 mm	920/22
1 cardan 1/2"	920/25
1 poignée coulissante 1/2"	920/42
1 cliquet réversible 1/2" Ⓢ	920/55
2 douilles à choc carré conducteur femelle 1/2" ○ 17 - 19 mm	720
10 clés à béquille à cardan ○ 7 - 8 - 10 - 11 - 12 - 13 - 14 - 15 - 17 - 19 mm	952
3 clés à bougies à cardan 14 - 16 - 20,8 mm	959
1 pince levier à broche et palette	963
1 clé en croix pour écrous de roues ○ ■ 1/2" - 17 - 19 - 22 mm	979
2 pinces pour circlips intérieurs à becs droits ○ 140 - 180 mm	1032
2 pinces pour circlips intérieurs à becs coudés ○ 130 - 170 mm	1034
2 pinces pour circlips extérieurs à becs droits ● 140x1,3 - 175 mm	1036
2 pinces pour circlips extérieurs à becs coudés ● 135x1,3 - 175 mm	1038
1 Pince multiprise entrepassée 250 mm	1048N
1 pince - étau à becs droits 240 mm	1052
1 Pince coupante diagonale ⚡ 160 mm	1082BM
1 Pince coupante diagonale à faible effort de coupe ⚡ 160 mm	1084BM
1 pince coupante frontale articulée, série lourde ⚡ 180 mm	1092V
1 cisaille type américain coupe droite 250 mm	1112
1 ciseaux d'électricien	1128BMX
1 pince à becs demi-ronds longs ≡ 180 mm	1150BM
1 Pince à becs demi-ronds longs ● 160 mm	1166BM
1 Pince à becs coudés demi-ronds ● 200 mm	1168BM
2 tournevis pour vis à fente ● 8x200 - 10x200 mm	1260
1 tournevis pour vis Phillips® Ⓢ PH3x150 mm	1262
8	1263/D8
2 marteau de mécanicien 300 - 600 g	1370
1 maillet à embouts nylon, manche en bois Ø 35 mm	1390
11 extracteur à rouleaux pour goujons M5+M16 mm	1433/C11
1 clé à sangle pour filtres à huile	1491
1 clé à sangle pour filtre à huile	1498
1 mètre à ruban 5 m	1692
1 jauge d'épaisseur	1708/20
1 doigt magnétique flexible 1,8 kg	1712E/2
1 grattoir feuille de sauge 200 mm	1717A
1 grattoir triangulaire 200 mm	1717B
5 limes demi-douces 200 mm	1719BMA8/S5
1 monture de scie à métaux	1725
1 burette tôle à embout flexible 200 cc	1751
1 cutter à lame sécable 18 mm avec lames	1771
1 Pied à coulisse	1650

CHF



5957VG

5,170.00 059571007

Composition conseillé en association avec C57S A - C57S B - C57SP - C55PSP

PLATEAUX THERMOFORMÉS SOUPLES

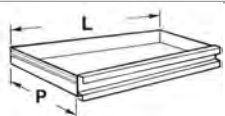

RSC23T
RSC24
RSC24A
RSC24AXL
RSC24L/7
RSC24L-CAB
RSC28
C30M
C37
C37A
C39
C39T
C39MD
C39SM
RSC51
C57S
C59
RSC55

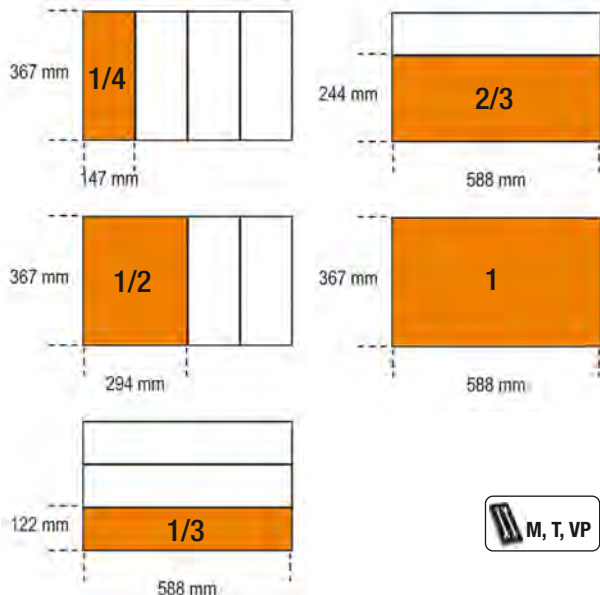

533÷543
549÷558

M01



42 6 - 7 - 8 - 9 - 10 - 11 - 12 - 13 - 14 - 15 - 16 - 17 - 18 - 19 - 20 - 21 - 22 - 24 - 27 - 30 - 32 - 36 mm

4,5 kg



M01	CHF 548.00	1	024500001
MV10	85.50	1	024510010

M02



42 6 - 7 - 8 - 9 - 10 - 11 - 12 - 13 - 14 - 15 - 16 - 17 - 18 - 19 - 20 - 21 - 22 - 23 - 24 - 25 - 26 - 27 - 28 - 29 - 30 - 32 mm

6,3 kg



M02	CHF 620.00	1	024500002
MV02	85.50	1	024510002

M05



42 6-7-8-9-10-11-12 - 13-14-15-16-17 - 18-19-20-21 mm

1,5 kg



M05	CHF 270.00	1	024500005
MV15	44.50	1	024510015

M06



42 22-24-27-30-32 mm

2,1 kg



M06	CHF 191.00	1	024500006
MV16	60.50	1	024510016

M13



42SLIM 8-10-11-12 - 13-14-15-16-17 - 18-19 mm

1,2 kg



M13	CHF 201.50	1	024500013
MV13	44.50	1	024510013

M25



42 6 - 7 - 8 - 9 - 10 - 11 - 12 - 13 - 14 - 15 - 16 - 17 - 18 - 19 - 21 - 22 - 24 - 27 mm

90 6x7 - 8x9 - 10x11 - 12x13 - 14x15 - 16x17 - 18x19 mm

123Q1/4

123Q3/8

123Q1/2

142 8 - 9 - 10 - 11 - 12 - 13 - 14 - 15 - 16 - 17 - 18 - 19 mm

5,1 kg



M25	CHF 894.00	1	024500025
MV25	85.50	1	024510873

M30

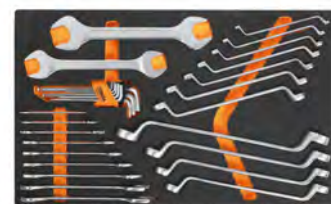

55 6x7 - 8x9 - 10x11 - 12x13 - 14x15 - 16x17 - 18x19 - 20x22 - 21x23 - 24x27 - 30x32 mm

90 6x7 - 8x9 - 10x11 - 12x13 - 14x15 - 16x17 - 18x19 - 20x22 - 21x23 - 24x27 - 30x32 mm

○96BPC/SC9 1,5 - 2 - 2,5 - 3 - 4 - 5 - 6 - 8 - 10 mm

4,2 kg



M30	CHF 522.00	1	024500030
MV30	85.50	1	024510030



M31



42AS 1/4 - 9/32 - 5/16 - 3/8 - 7/16 - 1/2 - 9/16
- 19/32 - 5/8 - 11/16 - 3/4 - 13/16 - 7/8 -
15/16 - 1 - 1.1/16 - 1.1/8 - 1.1/4
96BP/AS-SC9 1/16 - 3/32 - 1/8 - 5/32 - 3/16 - 7/32 - 1/4
- 5/16 - 3/8

5,7 kg



M31	CHF	1	024500031
MV31		1	024510031

M33



55 6x7-8x9-10x11
12x13-14x15
16x17-18x19
20x22 mm
96/SC9 1,5+10 mm

1,1 kg



M33	CHF	1	024500033
MV33		1	024510033

M38



55 21x23-24x26
27x29-30x32 mm

1,7 kg



M38	CHF	1	024500038
MV38		1	024510038

M39



31 2-3-4-5-6-8 mm
32 4 mm
55 6x7 - 8x9 - 10x11 - 12x13 - 14x15 - 16x17
- 18x19 - 20x22 - 21x23 - 24x26 - 25x28
- 27x29 - 30x32 mm
96/SC12 2 - 2,5 - 3 - 3,5 - 4 - 4,5 - 5 - 6 - 7 - 8 - 9
- 10 mm
96 12-14-17-19 mm

5,7 kg



M39	CHF	1	024500039
MV39		1	024510039

M40



90 6x7-8x9-10x11
12x13-14x15
16x17-18x19 mm

810 g



M40	CHF	1	024500040
MV40		1	024510040

M44



141 8-9-10-11-12
13-14-15-16
17-18-19 mm

1,3 kg



M44	CHF	1	024500044
MV44		1	024510044

M45



142 8-9-10-11-12
13-14-15-16
17-18-19 mm

1,3 kg



M45	CHF	1	024500045
MV45		1	024510045

M46



142SN 8-9-10-11-12
13-14-15-16
17-18-19 mm

1,4 kg



M46	CHF	1	024500046
MV46		1	024510046

M49

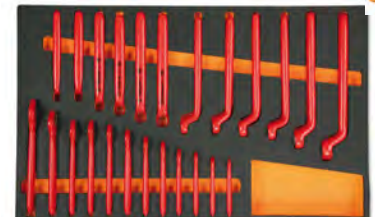

52MQ 7 - 8 - 10 - 11 - 12 - 13 - 14 - 15 - 16 - 17
- 19 - 22 mm
89MQ 7 - 8 - 10 - 11 - 12 - 13 - 14 - 15 - 16 - 17
- 19 - 22 mm

3,3 kg



M49	CHF	1	024500049
MV49		1	024510049

M50



96T 2-2,5-3-4-5
6-7-8 mm

1,1 kg



M50	CHF	1	024500050
MV50		1	024510051

M52



○ 96T 2,5-3-4-5-6 mm



330 g



	CHF		
M52	97.50	1	024500052
MV52	44.50	1	024510052

M53



○ 96TBP 2,5-3-4-5-6 mm



350 g



	CHF		
M53	103.00	1	024500053
MV52	44.50	1	024510052

M55



○ 97TTX T10-T15-T20-T25-T30



330 g



	CHF		
M55	108.00	1	024500055
MV55	44.50	1	024510055

Beta

Quality Tools

M60



- 96T 2 - 2,5 - 3 - 4 - 5 - 6 - 7 - 8 - 10 mm
- 97BTX/SC8 T9 - T10 - T15 - T20 - T25 - T27 - T30 - T40
- 944BX 5-6-7-8-10-13 mm

1,9 Kg



	CHF		
M60	480.00	1	024500060
MV60	85.50	1	024510060

M62



- 97TTX T10 - T15 - T20 - T25 - T27 - T30 - T40 - T45 - T50
- 1032 180 mm
- 1034 170 mm
- 1036 175 mm
- 1038 175 mm
- 1177BM 140 mm
- 1188BM 125 mm
- 1257LP 2-2,5-3-3,5 mm
- 1257PH 0-00

2,3 kg



	CHF		
M62	579.00	1	024500075
MV62	85.50	1	024510075

M63



○ 952 7 - 8 - 10 - 12 - 13 - 14 - 17 - 19 mm

3,4 kg



	CHF		
M63	435.00	1	024500063
MV63	85.50	1	024510063

M65

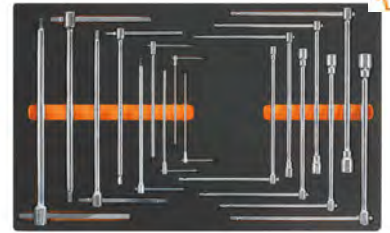

950 8 - 10 - 12 - 13 - 14 - 17 - 19 mm
951 2,5 - 3 - 4 - 5 - 6 - 8 - 10 - 12 - 14 mm

3,6 Kg



	CHF		
M65	670.00	1	024500065
MV65	85.50	1	024510065

M67

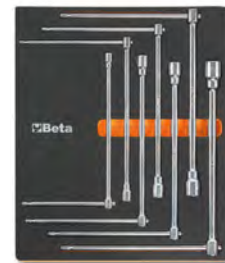

○ 950 7-8-10-12-13-17 mm

1,8 kg



	CHF		
M67	257.00	1	024500067
MV67	60.50	1	024510067

M69



○ 951 2,5-3-4-5-6-8-10-12-14 mm

1,8 kg



	CHF		
M69	379.00	1	024500069
MV69	60.50	1	024510069

M75



○ 933 7-8-9-10-11-12-13-14-15-16-17-18-19-21-22-24 mm

5,5 kg



	CHF		
M75	567.00	1	024500075
MV75	85.50	1	024510075

Beta

M78

17



80 6x7 - 8x9 - 10x11 - 12x13 - 14x15 - 16x17 - 18x19 mm

920/36A
965 450 mm
1052 240 mm
1058 175 mm
1481PL/A
1481PL/B
1481PL/C
1650 150 mm
1708/20
1716P

4,4 kg



M78	CHF 873.00	1	024500878
MV77	85.50	1	024510876

M79

6



80 8x9 - 10x11 - 12x13 - 14x15 - 16x17 - 18x19 mm

1,3 kg



M79	CHF 383.00	1	024500079
MV79	44.50	1	024510079

M82

29



920A 10-11-12-13-14 - 15-16-17-18-19 - 20-21-22-23-24 - 26-27-30-32 mm
920ME 5-6-8-10-12 mm
920AN/125 125 mm
920AN/250 250 mm
920/25
920/42 305 mm
920/55

4,1 kg

12"



M82	CHF 551.00	1	024500082
MV82	60.50	1	024510082

M83

24



920A 10-11-12-13-14 - 15-16-17-18-19 - 20-21-22-23-24 - 26-27-30-32 mm
920AN/125 125 mm
920AN/250 250 mm
920/25 255 mm
920/42 305 mm
920/55

3,7 kg

12"



M83	CHF 430.00	1	024500083
MV83	60.50	1	024510083

M85

45



851SR 230 mm
860LP 0,5x3 - 0,6x4,5 - 0,8x5,5 - 1x5,5 - 1,2x6,5 mm
860PE 2 - 2,5 - 3 - 4 - 5 - 6 - 8 - 10 mm
860PH PH0 - PH1 - PH2 - PH3 - PH4
860PZ PZ1 - PZ2 - PZ3 - PZ4
860TX T6 - T7 - T8 - T9 - T10 - T15 - T20 - T25 - T27 - T30 - T40
860RTX T9 - T10 - T15 - T20 - T25 - T27 - T30 - T40
860/55 100 mm
882P 80 mm
892 1/4 - 1/2

450 g

1/4"



M85	CHF 254.00	1	024500085
MV85	44.50	1	024510085

M86

46



867PE 4-5-6-7-8-10-12 mm
867PE/L 4-5-6-7-8-10-12 mm
867XZN 5-6-8-10-12 mm
867XZN/L 5-6-8-10-12 mm
867TX T20 - T25 - T30 - T40 - T45 - T50 - T55
867TX/L T25 - T30 - T40 - T45 - T50 - T55
867RTX T20 - T25 - T30 - T40 - T45 - T50 - T55
867/1
867/2

1,4 kg

10mm



M86	CHF 183.00	1	024500086
MV86	44.50	1	024510086

M91

25



900 4 - 4,5 - 5 - 5,5 - 6 - 7 - 8 - 9 - 10 - 11 - 12 - 13 - 14 mm
900ME 2,5-3-4-5-6-8 mm
900/20 50 mm
900/21 150 mm
900/25 1/4 - 1/2
900BG/30
900/42
900/55

560 g

1/4"



M91	CHF 296.00	1	024500091
MV90	44.50	1	024510090

M92

22



910A 6-7-8-9-10-11-12-13-14-15-16-17-18-19-20-21-22 mm
910/21 125 mm
910/22 250 mm
910/25
910/42
910/55

1,5 kg

3/8"



M92	CHF 332.00	1	024500092
MV92	44.50	1	024510092

M94

26



900AS/L 3/16 - 7/32 - 1/4 - 9/32 - 5/16 - 11/32 - 3/8 - 7/16 - 1/2 - 9/16
900AS 3/16 - 7/32 - 5/32 - 1/4 - 9/32 - 5/16 - 11/32 - 3/8 - 7/16 - 1/2 - 9/16
900AN 50-100mm
900/25
900/55
900/42

930 g

1/4"



M94	CHF 347.00	1	024500094
MV94	44.50	1	024510094

M96

22



920A/AS 3/8 - 7/16 - 1/2 - 9/16 - 19/32 - 5/8 - 11/16 - 3/4 - 25/32 - 13/16 - 7/8 - 15/16 - 1 - 1.1/16 - 1.1/8 - 1.3/16 - 1.1/4
920/25
920AN 125-250mm
920/42
920/55

3,8 kg

12"



M96	CHF 444.00	1	024500096
MV96	60.50	1	024510096

M100

98



- 895/1
- 895/3
- 895/6
- 900 4 - 4,5 - 5 - 5,5 - 6 - 7 - 8 - 9 - 10 - 11 - 12 - 13 - 14 mm
- 900L 5 - 6 - 7 - 8 - 9 - 10 - 11 - 12 - 13 mm
- 900ME 3-4-5-6-7 mm
- 900LP 0,8x4 - 1x5,5 - 1,2x6,5 - 1,2x8 mm
- ⊕ 900PH PH1-PH2-PH3-PH4
- ⊕ 900TX T10 - T15 - T20 - T25 - T27 - T30 - T40
- 900/20 50 mm
- 900/20L 100 mm
- 900/21 150 mm
- 900/25
- 900BG/30
- 900/42
- ⊕ 900/55
- 920A 8-10-11-12-13-14-15-16-17-18-19-20-21-22-23-24-26-27-28-30-32 mm
- 920/15
- 920/25
- 920AN/125 125 mm
- 920AN/250 250 mm
- 920/42
- ⊕ 920/55
- ⊕ 920FTX 10 - 12 - 14 - 16 - 18 - 20 - 22 - 24 mm
- 920AL 10 - 12 - 13 - 14 - 15 - 16 - 17 - 18 - 19 - 21 - 22

6,7 Kg

14" 12"



M100	CHF 1,510.00	1	024500100
MV100	85.50	1	024510100

M105

116



- 900 4 - 4,5 - 5 - 5,5 - 6 - 7 - 8 - 9 - 10 - 11 - 12 - 13 - 14 mm
- 900L 5 - 6 - 7 - 8 - 9 - 10 - 11 - 12 - 13 mm
- 96BPC/SC9 1,5 - 2 - 2,5 - 3 - 4 - 5 - 6 - 8 - 10 mm
- 895/1
- 895/3
- 895/6
- 900ME 3-4-5-6-7 mm
- 900LP 0,8x4 - 1x5,5 - 1,2x6,5 - 1,2x8 mm
- ⊕ 900PH PH1-PH2-PH3-PH4
- ⊕ 900TX T10 - T15 - T20 - T25 - T27 - T30 - T40
- 900/16 □ 1/4 - ■ 3/8
- 900/... 50-100-150 mm
- 900/25
- 900BG/30
- 900/42
- ⊕ 900/55
- 910A 6 - 7 - 8 - 9 - 10 - 11 - 12 - 13 - 14 - 15 - 16 - 17 - 18 - 19 - 20 - 21 - 22 mm
- 910/15 □ 3/8 - ■ 1/4
- 910/16 □ 3/8 - ■ 1/2
- 910/21 125 mm
- 910/22 250 mm
- 910/25
- 910/42
- ⊕ 910/55
- 920A 8 - 10 - 11 - 12 - 13 - 14 - 15 - 16 - 17 - 18 - 19 - 20 - 21 - 22 - 23 - 24 - 26 - 27 - 28 - 30 - 32 mm
- 920/15 □ 1/2 - ■ 3/8
- 920/25
- 920AN 125 - 250 mm
- 920/42
- ⊕ 920/55
- 956E 16-17,8-20,8 mm

7,7 kg

14" 38" 12"



M105	CHF 1,645.00	1	024500871
MV105	85.50	1	024510871

M108

27



- 910MQ/PE 4-5-6-8 mm
- 910MQ/B 7 - 8 - 10 - 11 - 12 - 13 - 14 - 15 - 16 - 17 - 19 mm
- ⊕ 910MQ/TX T15 - T20 - T25 - T27 - T30 - T40
- 910MQ/XZN 8-10 mm
- 910MQ/21 125 mm
- 910MQ/22 250 mm
- 910MQ/T
- 910MQ/55

2,7 kg



M108	CHF 1,585.00	1	024500108
MV108	85.50	1	024510108

M110

36



- ⊕ 850MQ
- ⊕ 860TX/A10
- 920MQ/A 8 - 9 - 10 - 11 - 12 - 13 - 14 - 15 - 16 - 17 - 18 - 19 - 20 mm
- 920MQ/PE 5-6-8-10-12 mm
- 920MQ/21 125 mm
- 920MQ/22 250 mm
- 920MQ/55A
- 943MQ 6-7-8-10 mm

3,1 kg



M110	CHF 1,600.00	1	024500110
MV110	85.50	1	024510110

M112

32



- ⊕ 861TX ● 1/4-T6+T15
- ⊕ 866TX ● 5/16-T20+T55
- 895/1 ○ 1/4x□1/4
- 895/6 ○ 5/16x□1/2
- ⊕ 900FTX □ 1/4-E4+E10
- ⊕ 920FTX □ 1/2-E12+E24
- ⊕ 920TX □ 1/2-T55L-T60-T70L

1,3 kg

14" 12"



M112	CHF 394.00	1	024500112
MV112	44.50	1	024510112

M115

54



- ⊕ 666/20 40=200 Nm
- 920A 13 - 14 - 15 - 16 - 17 - 18 - 19 - 20 - 21 - 22 - 24 - 26 - 27 - 30 - 32 mm
- ⊕ 920FTX 12 - 14 - 16 - 18 - 20 - 22 - 24 mm
- 920PE 6 - 7 - 8 - 8L - 10 - 10L - 12 - 12L - 14 - 14L
- ⊕ 920TX T20 - T25 - T27 - T30 - T40 - T45 - T50 - T55 - T60 - T20L - T25L - T27L - T30L - T40L - T45L - T50L
- 920/21 125 mm
- 920/22 255 mm
- 920/25
- 920/42 305 mm
- ⊕ 920/55

7,8 Kg

12"



M115	CHF 1,450.00	1	024500115
MV116	85.50	1	024510116

Beta

M120

75



- 920A 10-11-12-13-14-15-16-17-18-19-20-21
22-24-26-27-30-32 mm
- 920AN/125 125 mm
- 920AN/250 250 mm
- 920/25
- 920/42
- 920AL 10 - 12 - 13 - 14 - 15 - 16 - 17 - 18 - 19 -
22 - 24 - 27 - 30 - 32 mm
- 920FTX 10 - 12 - 14 - 16 - 18 - 20 - 22 - 24 mm
- 920/55
- 920PE 5 - 5L - 6 - 6L - 7 - 7L - 8 - 8L - 10 - 10L
- 12 - 12L - 14 - 14L
- 920TX T20-T25-T27-T30-T40-T45-T50-T55-T60
T20L-T25L-T27L-T30L-T40L-T45L-T50L

6,9 Kg

12"



CHF

M120	1,620.00	1	024500120
MV120	85.50	1	024510120

M121

46



- 920BP 5L - 6L - 8L - 10L - 5XL - 6XL - 8XL mm
- 920TX T20 - T25 - T27 - T30 - T40L - T45L
- T50L - T55L - T60L - T70L
- 920XZN 4 - 5 - 6 - 6L - 8 - 8L - 10 - 10L - 12 - 12L
- 14 - 14L - 16 - 18 mm
- 920ES 7 - 9 - 10 - 11 - 12L - 14L - 16L - 7XL -
9XL - 10XL - 11XL - 12XL - 14XL - 16XL
mm

920/36A

6,3 Kg

12"



CHF

M121	1,525.00	1	024500121
MV121	85.50	1	024510121

M125

68



- 910AL 8 - 9 - 10 - 11 - 12 - 13 - 14 - 15 - 16 - 17
- 19 - 21 - 22 mm
- 920PE 5-6-6L-7-8-8L-10-10L-12-12L mm
- 920FTX E12 - E14 - E16 - E18 - E20 - E22 - E24
- 920TX T20 - T25 - T27 - T30 - T30L - T40 - T40L
- T45 - T50 - T50L - T55 - T60 - T60L
- 920XZN 5 - 6 - 6L - 8 - 8L - 10 - 10L - 12L mm
- 920AL 10 - 12 - 13 - 14 - 15 - 16 - 17 - 18 - 19
- 21 - 22 - 23 - 24 - 27 - 30 - 32 mm

1692/5

7,9 kg

38" 12"



CHF

M125	1,595.00	1	024500872
MV125	85.50	1	024510872

M126

26



- 928A 19 - 21 - 22 - 24 - 26 - 27 - 28 - 30 - 32
- 34 - 35 - 36 - 38 - 41 - 46 mm
- 928ME 14-17-19-22 mm
- 928/15 □ 3/4 - ■ 1/2
- 928/16 □ 3/4 - ■ 1
- 928/21 200 mm
- 928/22 380 mm
- 928/25
- 928/42 450 mm
- 928/55

12,4 kg

34"



CHF

M126	1,205.00	1	024500126
MV126	85.50	1	024510126

M127

23



- 728 19 - 21 - 22 - 24 - 27 - 30 - 32 - 33 - 34
- 35 - 36 - 38 - 40 - 41 - 46
20-22-24 mm
- 728FTX
- 728/15 □ 3/4 - ■ 1/2
- 728/16 □ 3/4 - ■ 1
- 728/21 175 mm
- 728/22 250 mm
- 728/25

12,5 kg

34"



CHF

M127	1,166.00	1	024500127
MV127	85.50	1	024510127

M128

50



- 720 10 - 11 - 12 - 13 - 14 - 15 - 16 - 17 - 18
- 19 - 21 - 22 - 24 - 27 - 30 - 32 mm
- 720L 10 - 11 - 12 - 13 - 14 - 15 - 16 - 17 - 18
- 19 - 21 - 22 - 24 - 27 - 30 - 32 mm
- 720TX T30-T40-T45-T50-T55
- 720ME 5 - 6 - 8 - 10 - 12 - 14 - 17 - 19 mm
- 720LC 17-19-21 mm
- 720/21 125 mm
- 720/25

8,9 kg

12"



CHF

M128	1,184.00	1	024500128
MV128	85.50	1	024510128

M129

13



- 1032 180 mm
- 1034 170 mm
- 1036 175 mm
- 1038 175 mm
- 1048N 250 mm
- 1052 240 mm
- 1082BM 160 mm
- 1098 220 mm
- 1112 250 mm
- 1128BM
- 1150BM 180 mm
- 1166BM 160 mm
- 1168BM 160 mm

3,4 Kg

CHF

M129	574.00	1	024500129
MV138	85.50	1	024510138

M133

3



- 1082G 160 mm
- 1150G 180 mm
- 1166G 160 mm

650 g

CHF

M133	107.00	1	024500133
MV133	44.50	1	024510133

M134

3



- 1082GBM 160 mm
- 1150GBM 180 mm
- 1166GBM 160 mm

750 g

CHF

M134	136.50	1	024500134
MV134	44.50	1	024510134

M135



- 1082MQ 160 mm
- 1150MQ 180 mm
- 1166MQ 160 mm

750 g

CHF

M135	228.00	1	024500135
MV135	44.50	1	024510135

M136



- 1084BM 160 mm
- 1150BM 180 mm
- 1166BM 160 mm

750 g

CHF

M136	155.00	1	024500136
MV131	44.50	1	024510131

M137



- 1084 160 mm
- 1150 180 mm
- 1166 160 mm

650 g

CHF

M137	126.50	1	024500137
MV132	44.50	1	024510132

M145



- 1032 180 mm
- 1034 170 mm
- 1036 175 mm
- 1038 175 mm

640 g

CHF

M145	170.50	1	024500145
MV145	44.50	1	024510145

M153



- 1048N 250 mm
- 1052 240 mm

1 kg

CHF

M153	123.50	1	024500153
MV154	44.50	1	024510154

M161



- 1128MQ
- 1048MQ 250 mm
- 1082MQ 160 mm
- 1150MQ 180 mm
- 1162MQ 160 mm
- 1164MQ 160 mm
- 1272MQ PH0x60 - PH1x80 - PH2x100 - PH3x150 mm
- 1274MQ 2,5x75 - 3x100 - 4x100 - 5,5x125 mm
- 1777MQU

3,0 kg

CHF

M161	676.00	1	024500161
MV161	85.50	1	024510161

M162

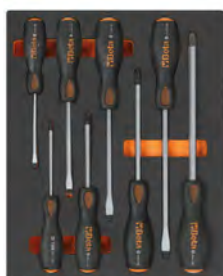

- 1241 5,5x100 - 6,5x125 - 8x150 - 10x200 mm
- 1242 PH1x100 - PH2x100 - PH3x150 - PH4x200 mm

1,4 kg

CHF

M162	187.00	1	024500162
MV162	60.50	1	024510162



M166



860MIX/A31

- 1048N 250 mm
- 1082BM 160 mm
- 1150BM 180 mm
- 1162BM 160 mm
- 1290 3x75 - 4x100 - 5,5x100 - 6,5x150 - 8x150 mm
- 1290N 6,5x30 mm
- 1292 4,5x80 - 6x100 - 8x150 mm
- 1292N 6x30 mm
- 1297TX T20-T25-T27-T30

2,9 kg

CHF

M166	590.00	1	024500879
MV880	85.50	1	024510880

M170



- 1290 2,5x50 - 3x75 - 3,5x100 - 4x125 - 5,5x100 - 5,5x150 - 6,5x150 mm

500 g

CHF

M170	101.50	1	024500170
MV170	44.50	1	024510170

M172



- 1292 PH0x60 - PH0x100 - PH1x80 - PH1x120 - PH2x100 - PH2x150 mm

450 g

CHF

M172	92.50	1	024500172
MV172	44.50	1	024510172



M174



1297TX T8 - T10 - T15 - T20
- T25 - T30



450 g



M174	CHF 135.00	1	024500174
MV174	CHF 44.50	1	024510174

M180



- 1290 3x75
4x100
5,5x150
6,5x150 mm
- 1292 PH0x60
PH1x80
PH2x100 mm



500 g



M180	CHF 105.50	1	024500180
MV180	CHF 44.50	1	024510180

M195



- 1260 2,5x50 - 3x75 - 4x100 - 5,5x125 - 6,5x150 - 8x200 mm
- 1260N 4x30 mm
- 1262 PH0x60 - PH1x80 - PH2x100 - PH3x150 mm
- 1262N PH1x30 mm
- 1267TX T6 - T7 - T8 - T9 - T10 - T15 - T20 - T25 - T27 - T30 - T40 - T45
- 1253 3,5x100 mm



2,3 kg



M195	CHF 409.00	1	024500195
MV195	CHF 85.50	1	024510195

M201



- 1260 3x75 - 4x100 - 6,5x150 mm
- 1262 PH0x60 - PH1x80 - PH2x100 mm



500 g



M201	CHF 104.50	1	024500201
MV201	CHF 44.50	1	024510201

M204



1267TX T8 - T10 - T15 - T20
- T25 - T30



450 g



M204	CHF 103.00	1	024500204
MV204	CHF 44.50	1	024510204

M208



- 1260 3x75
3,5x100
4x125
5,5x150
6,5x150 mm
- 1262 PH0x60
PH1x80
PH2x100 mm
- 1260N 4x30 mm
- 1262N PH1x30 mm



750 g



M208	CHF 118.50	1	024500208
MV208	CHF 60.50	1	024510208

M209



- 1260N 4x30 mm
- 1264 2,5x60 - 3x100 - 4x125 - 5x150 - 6,5x150 mm
- 1262 PH0x60 - PH1x80 - PH2x100 mm
- 1262N PH1x30 mm



820 g



M209	CHF 116.50	1	024500209
MV208	CHF 60.50	1	024510208

M213



- 1201E 2,5x50 - 3x75 - 4x100 - 5,5x125 - 6,5x150 - 8x200 mm
- 1201EN 4x30 mm
- 1202E PH0x60 - PH1x80 - PH2x100 - PH3x150 mm
- 1202EN PH1x30 mm
- 1207E/TX T6 - T7 - T8 - T9 - T10 - T15 - T20 - T25 - T27 - T30 - T40 - T45
- 1253 3,5x100 mm



1,8 Kg



M213	CHF 276.00	1	024500213
MV210	CHF 85.50	1	024510210

M214



- 1201E 2,5x50 - 3x75 - 3,5x100 - 4x125 - 5,5x100 - 5,5x150 - 6,5x150 mm



500 g



M214	CHF 57.00	1	024500214
MV211	CHF 44.50	1	024510211

M216



- 1202E PH0x60 - PH1x80 - PH1x120 - PH2x100 - PH2x150 - PH3x150 mm



450 g



M216	CHF 62.00	1	024500216
MV212	CHF 44.50	1	024510212

M217



- 1207E/TX T6 - T7 - T8 - T9 - T10 - T15 - T20



500 g



M217	CHF 79.50	1	024500217
MV215	CHF 44.50	1	024510215



M218



- 1201E 3x75
4x100
5,5x150
6,5x150 mm
- ⊕ 1202E PH0x60
PH1x80
PH2x100 mm

500 g



	CHF		
M218	60.00	1	024500218
MV220	44.50	1	024510220

M219



- ⊕ 1202E 3x60 - 4,5x80 - 6x100 mm
- 1204E 3x75 - 4x100 - 5x150 - 6,5x150 mm

590 g



	CHF		
M219	60.00	1	024500219
MV220	44.50	1	024510220

M222



- ⊕ 1272MQ PH0x60 mm
- ⊕ 1272MQF PH1x80 - PH2x100 mm
- 1274MQF 3,5x100 - 4,5x100 - 5,5x125 - 6,5x150 mm

540 g



	CHF		
M222	173.00	1	024500222
MV222	44.50	1	024510222

M226



- 1274MQ 3x100
4x100
5,5x125
6,5x150 mm
- ⊕ 1272MQ PH0x60
PH1x80
PH2x100 mm

500 g



	CHF		
M226	131.50	1	024500226
MV226	44.50	1	024510226

M227



- 944BX 6-7-8-10-13 mm

420 g



	CHF		
M227	160.50	1	024500227
MV227	44.50	1	024510227

M230



- 30 Ø 2-3-4 mm
- 31 Ø 2-3-4-5-6-8 mm
- 32 Ø 4 mm
- 34 150 mm
- 35 200-250 mm
- 36 125 mm
- 1370 500 g
- 1390 Ø 35 mm
- 1692 3 m
- 1712TF
- 1719BMA/Q 200 mm
- ▲ 1719BMA/T 200 mm
- 1719BMA/P 200 mm
- ▶ 1719BMA/M 200 mm
- 1719BMA/R 200 mm
- 1737NX
- 1771 18 mm

3,2 Kg



	CHF		
M230	527.00	1	024500230
MV230	85.50	1	024510230



M231



- 31 2-3-4-5-6-8 mm
- 32 4 mm
- 34 125-150-175 mm
- 36 125 mm
- 1370 500-1000 g
- 1390 Ø 35 mm
- 1712TF 590 mm
- 1715 670 mm
- 1719BMA/Q 200 mm
- ▲ 1719BMA/T 200 mm
- 1719BMA/P 200 mm
- ▶ 1719BMA/M 200 mm
- 1719BMA/R 200 mm
- 1737NX

4,7 kg



	CHF		
M231	508.00	1	024500877
MV231	85.50	1	024510877

M234



- 35 100-200 mm
- 1370 300 g
- 1390 Ø 35 mm

1,3 kg



	CHF		
M234	132.50	1	024500234
MV232	44.50	1	024510232

M236



- 1719BMA/Q 200 mm
- ▲ 1719BMA/T 200 mm
- 1719BMA/P 200 mm
- ▶ 1719BMA/M 200 mm
- 1719BMA/R 200 mm

870 g



	CHF		
M236	131.50	1	024500236
MV236	44.50	1	024510236

M237



35 100-200 mm
1370T 300 mm
1390N Ø 35 mm

1,3 kg



CHF

M237	144.50	1	024500237
MV232	44.50	1	024510232

M240



31BM Ø 2-3-4-5-6-8 mm
32 Ø 4 mm

850 g



CHF

M240	172.50	1	024500240
MV240	44.50	1	024510240

M264



1491 Ø 65+110 mm
1494 10 mm
1494E 8-9-10-11-12-14-17 mm
1494Q 8-9,5-12-13 mm
1494T Δ 9,5
1494XZN 16
1496C 8x 10 mm

2,1 kg



CHF

M264	307.00	1	024500264
MV264	44.50	1	024510264

Beta

Quality Tools

M284



1128BMX
1130BMX
1719BMA...Q 200 mm
1719BMA...P 200 mm
1719BMA...M 200 mm
1719BMA...R 200 mm
1726BM 400 mm
1728BM (5)
1771BM 170 mm
1778V18 185 mm

2,4 kg



CHF

M284	310.00	1	024500284
MV284	85.50	1	024510284

M292



111E 250 mm
1128BMX
1692/5 5 m
1771 170 mm

500 g



CHF

M292	148.00	1	024500292
MV293	44.50	1	024510293

M294



1692/5 5 m
1725CR 260 mm
1771 18 mm
1771RL

500 g



CHF

M294	101.00	1	024500294
MV294	44.50	1	024510294

M295



1650
1682 L=300 mm
1707
1708/20

450 g



CHF

M295	150.00	1	024500295
MV295	44.50	1	024510295

M305



1927B
720 12-13-14-15-16-17
18-19-21-22
24-27 mm
720/21

4,2 kg



CHF

M305	521.00	1	024500305
MV305	60.50	1	024510305

M310



1927CD
720 12-13-14-15-16-17
18-19-21-22
24-27 mm
720/21

4,0 kg



CHF

M310	784.00	1	024500310
MV310	60.50	1	024510310

Beta

Beta

M400



3932U	
3935	120 mm
3937	170 mm
3952	13 - 14 - 15 - 16 - 17 - 18 - 19 mm
<input type="checkbox"/> 3961 3,2	
<input type="checkbox"/> 3961 3,3	
<input type="checkbox"/> 3961 3,5	
<input type="checkbox"/> 3961U	3,2 - 4,0 mm
3969	200 mm (x2)
3969K3	113 mm
3973/1	
3973/2	
3973/3	
3973/4	
3984/1	Ø35 mm
3984/2	Ø22,8 mm
3984/3	Ø23,5 mm
3984/4	Ø23 mm
3991	222 mm
3992	234 mm

3,1 kg



	CHF		
M400	784.00	1	024500400
MV400	85.50	1	024510400

M401



3921	440 mm
3948	
3953	
3955	30x32 - 32x36 mm
3967	289 mm
3971	

2,7 kg



	CHF		
M401	474.00	1	024500401
MV401	85.50	1	024510401

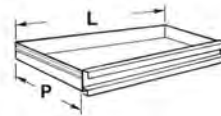

RSC22
RSC23
RSC23C
G27S

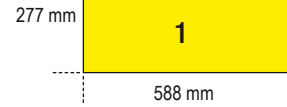
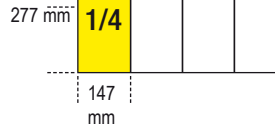

543
559



C41S
C41H

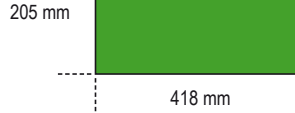

543



MC10



42	6-7-8-9-10-11-12 13-14-15-16-17 18-19-21-22 mm
○96/SC9	1,5 - 2 - 2,5 - 3 - 4 - 5 - 6 - 8 - 10 mm
⚡ 1084BM	160 mm
≡ 1150G	180 mm
● 1166G	160 mm
● 1201E	3,5x100 - 5,5x150 - 6,5x150 mm
⊕ 1202E	PH0x60 - PH1x80 - PH2x100 mm

3,5 kg



	CHF		
MC10	492.00	1	027500011
MCV10	60.50	1	027510010

MC12



42	6 - 7 - 8 - 9 - 10 - 11 - 12 - 13 - 14 - 15 - 16 - 17 - 18 - 19 - 21 - 22 mm
○96/SC9	1,5 - 2 - 2,5 - 3 - 4 - 5 - 6 - 8 - 10 mm
1692/5	5 m

2,2 kg



	CHF		
MC12	325.00	1	041500012
MCV11	60.50	1	041510011

MC20



860MIX/A31	
895/1	
1048N	250 mm
1370	300 g
32	Ø 4 mm
36	Ø 4 mm
900	4 - 4,5 - 5 - 5,5 - 6 - 7 - 8 - 9 - 10 - 11 - 12 - 13 - 14 mm
900/21	150 mm
900/25	
900BG/30C	
900/42	
900/55	
920A	10 - 11 - 12 - 13 - 14 - 15 - 16 - 17 - 18 - 19 - 21 - 22 - 24 - 27 - 30 - 32 mm

920/25	
920AN/125	125 mm
920/42	
920/55	

6 kg



	CHF		
MC20	768.00	1	027500020
MCV20	60.50	1	027510021

MC21



○ 920A	10 - 11 - 12 - 13 - 14 - 15 - 16 - 17 - 18 - 19 - 20 - 21 - 22 - 23 - 24 - 26 - 27 - 30 - 32 mm
920/25	
920/42	
⊕ 920/55	
920AN	125-250 mm

4,3 kg



	CHF		
MC21	430.00	1	041500021
MCV21	60.50	1	041510021

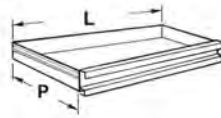

C35

447 mm
1
600 mm

544÷546



MB12

30

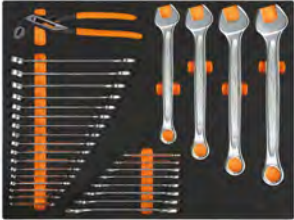

- 42 6-7-8-9-10-11-12-13-14-15-16-17-18-19-20-21-22-24-27-30-32mm
- 55 6x7-8x9-10x11
12x13-14x15
16x17-18x19
20x22mm
- 1048N 250mm

5,4 kg



CHF

MB12	745.00	1	024504212
MBV13	233.00	1	024524213

MB37

52



- 920A 10-11-12-13-14-15-16-17-18-19-20-21-22-23-24-26-27-30-32mm
- 920/21 125mm
- 920/22 150mm
- 920/25
- 920/42
- 920/55
- 111E 250mm
- 1052 240mm
- 1084BM 160mm
- 1150BM 180mm
- 1166BM 160mm
- 1032 180mm
- 1034 170mm
- 1036 175mm
- 1038 175mm
- 900 4-4,5-5-5,5-6-7-8-9-10-11-12-13-14mm
- 900/20 50mm
- 900/21 150mm
- 900/25
- 900BG/30
- 900/55
- 900/42

7,0 kg



CHF

MB37	1,159.00	1	024504237
MBV40	233.00	1	024524240

MB38

80



- 96T 2-2,5-3-4-5-6-7-8 mm
- 851SR 230 mm
- 860LP 0,5x3-0,6x4,5-0,8x5,5-1x5,5-1,2x6,5 mm
- 860PE 2-2,5-3-4-5-6-8-10 mm
- 860PH PH0 - PH1 - PH2 - PH3 - PH4
- 860PZ PZ1 - PZ2 - PZ3 - PZ4
- 860RTX T9 - T10 - T15 - T20 - T25 - T27 - T30 - T40
- 860TX T6 - T7 - T8 - T9 - T10 - T15 - T20 - T25 - T27 - T30 - T40
- 860/55 100 mm
- 882P
- 892/0
- 920A 10-11-12-13-14-15-16-17-18-19-20-21-22-23-24-26-27-30-32 mm
- 920/21 125 mm
- 920/22 255 mm
- 920/25
- 920/42
- 920/55
- 1084BM 160 mm
- 1150BM 180 mm
- 1166BM 160 mm

5,9 kg



CHF

MB38	1,003.00	1	024504238
MBV35	233.00	1	024524235

MB39

39



- 920A 10-11-12-13-14-15-16-17-18-19-20-21-22-23-24-26-27-30-32 mm
- 920/21 125 mm
- 920/22 255 mm
- 920/25
- 920/42
- 920/55
- 920PE 5-6-8-10-12 mm
- 1032 180 mm
- 1034 170 mm
- 1036 175 mm
- 1038 175 mm
- 35 200 mm
- 1084BM 160 mm
- 1150BM 180 mm
- 1166BM 160 mm
- 1370 500 g
- 1390 35 mm

7,2 kg



CHF

MB39	973.00	1	024504239
MBV36	233.00	1	024524236

MB44

34



- 1260 2,5x50-3x75-3,5x100-4x100-5,5x125-6,5x150-8x200 mm
- 1260N 4x30-6,5x30 mm
- 1262 PH0x60 - PH0x100 - PH1x80 - PH1x120 - PH2x100 - PH2x150 - PH3x150 mm
- 1262N PH1x30-PH2x30 mm
- 1253
- 96BPC/SC9 951 2,5-3-4-5-6-8 mm

2,8 kg



CHF

MB44	498.00	1	024504244
MBV44	233.00	1	024524244

MB45

29



- 1260 2,5x50 - 3x75 - 3,5x100 - 4x100 - 5,5x100 - 5x125 - 6,5x150 mm
- ⊕ 1262 PH0x60 - PH0x100 - PH1x80 - PH1x120 - PH2x100 - PH2x150 mm
- ⊗ 1267TX T8 - T10 - T15 - T20 - T25 - T30
- 1052 240 mm
- 96BPC/SC9

2,8 kg

CHF

MB45	370.00	1	024504245
MBV45	233.00	1	024524245

MB46

29



- 1260 3x75 - 4x100 - 5,5x125 - 6,5x150 mm
- ⊕ 1262 PH0x60 - PH1x80 - - - PH2x100 mm
- ⊗ 1267TX T8 - T10 - T15 - T20 - T25 - T30
- 96BPC/SC9
- 96T 2-2,5-3-4-5-6
- 1052 240 mm

2,8 kg

CHF

MB46	414.00	1	024504246
MBV46	233.00	1	024524246

MB47

48



- 1260 3x75 - 4x100 - 5,5x125 - 6,5x150 mm
- ⊕ 1262 PH0x60 - PH1x80 - - - PH2x100 mm
- 1260N 4x30 mm
- ⊕ 1262N PH1x30 mm
- 96T 2,5-3-4-5-6-8 mm
- 96BPC/SC9
- 920A 10 - 11 - 12 - 13 - 14 - 15 - 16 - 17 - 18 - 19 - 20 - 21 - 22 - 23 - 24 - 26 - 27 - 30 - 32 mm
- 920/21 125 mm
- 920/22 250 mm
- 920/25
- 920/42
- ⊗ 920/55

5,6 kg

12

CHF

MB47	792.00	1	024504247
MBV47	233.00	1	024524247

MB56

15

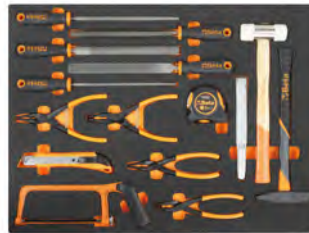

- 1719BMA/Q 200 mm
- ▲ 1719BMA/T 200 mm
- 1719BMA/P 200 mm
- ▶ 1719BMA/M 200 mm
- 1719BMA/R 200 mm
- 1032 180 mm
- 1034 170 mm
- 1036 175 mm
- 1038 175 mm
- 1370T 300 g
- 1390N Ø 35 mm
- 35 200 mm
- 1692 5 mt
- 1725CR 260 mm
- 1771 18 mm

3,7 kg

CHF

MB56	476.00	1	024504256
MBV56	233.00	1	024524256

MB58

17



- 31 Ø 2-3-4-5-6 mm
- 32 Ø 4 mm
- 35 200 mm
- 1112 250 mm
- 1128BMX
- 1370 500 g
- 1390 Ø 45 mm
- 1719BMA...Q 200 mm
- ▲ 1719BMA...T 200 mm
- 1719BMA...P 200 mm
- ▶ 1719BMA...M 200 mm
- 1719BMA...R 200 mm
- 1726 440 mm

4,5 kg

CHF

MB58	476.00	1	024504258
MBV55	233.00	1	024524255

Beta

Quality Tools

MB59

15



- 1719BMA...Q 200 mm
- ▲ 1719BMA...T 200 mm
- 1719BMA...P 200 mm
- ▶ 1719BMA...M 200 mm
- 1719BMA...R 200 mm
- 31 Ø 4-6 mm
- 32 Ø 4 mm
- 35 125-200 mm
- 1370 300 g
- 1390 Ø 35 mm
- 1692 5 mt
- 1725 420 mm
- 1833XS/2

3,4 kg

CHF

MB59	397.00	1	024504259
MBV57	233.00	1	024524257

MB65

16



- 1719BMA...Q 200 mm
- 1719BMA...P 200 mm
- 1719BMA...T 200 mm
- 1719BMA...M 200 mm
- 1719BMA...R 200 mm
- 35 200 mm
- 1032 180 mm
- 1034 170 mm
- 1036 175 mm
- 1038 175 mm
- 1052 240 mm
- 1084BM 160 mm
- 1150BM 180 mm
- 1166BM 160 mm
- 1370 500 g
- 1390 Ø 35 mm

4,8 kg

CHF

MB65	616.00	1	024504265
MBV61	233.00	1	024524261

Beta

Quality Tools

MB63

60

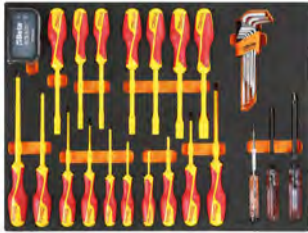

- 96BPC/SC9
- 1250 4x125 mm
- ⊕ 1251 PH1x125 mm
- 1253
- 943MQ 5,5-6-7-8-10-13 mm
- ⊕ 1272MQ PH0x60 - PH1x80 - PH2x100 - PH3x150 mm
- 1274MQ 2,5x75 - 3x100 - 4x100 - 5,5x125 - 6,5x150 - 8x175 mm
- 860LP 0,5x3 - 0,6x4 - 0,8x5,5 - 1,0x5,5 - 1,2x6,5 mm
- 860PE 2 - 2,5 - 3 - 4 - 5 - 6 - 8 - 10 mm
- ⊕ 860PH PH0 - PH1 - PH2 - PH3 - PH4
- ⊕ 860PZ PZ1 - PZ2 - PZ3 - PZ4
- ⊕ 860RTX T9 - T10 - T15 - T20 - T25 - T27 - T30 - T40
- 882MSR 50 ○ 1/4 ● 1/4
- Ⓢ 850MQ

3,2 kg

	CHF	
MB63	639.00	1 024504263
MBV63	233.00	1 024524263

MB64

20



- 55 6x7-8x9-10x11 - 12x13-14x15 - 16x17-18x19 - 20x22 mm
- 1048MQ 250 mm
- 1082MQ 140 mm
- 1128BSX
- 1132MQ 230 mm
- 1142MQ 160 mm
- 1150MQ 180 mm
- 1166MQ 160 mm
- 1168MQ 160 mm
- 110MQ 250 mm
- 1777MQ
- 993MQ
- 1602

4,1 kg

	CHF	
MB64	1,141.00	1 024504264
MBV62	233.00	1 024524262

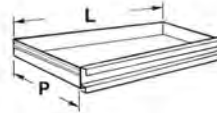

C45PRO

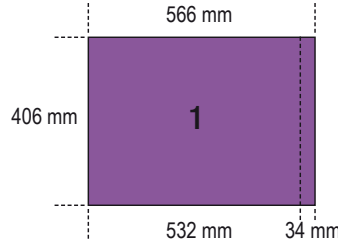

546

MM11

30



- 42 6 - 7 - 8 - 9 - 10 - 11 - 12 - 13 - 14 - 15 - 16 - 17 - 18 - 19 - 20 - 21 - 22 - 24 - 27 - 30 - 32 mm
- 96BPC/SC9 1,5 - 2 - 2,5 - 3 - 4 - 5 - 6 - 8 - 10 mm

4,5 kg

	CHF	
MM11	510.00	1 024580011
MMV10	85.50	1 024590010

MM26

34



- 42 6 - 7 - 8 - 9 - 10 - 11 - 12 - 13 - 14 - 15 - 16 - 17 - 18 - 19 - 21 - 22 - 24 - 27 mm
- 111E 250 mm
- 123Q1/4
- 123Q3/8
- 123Q1/2
- 142 8 - 9 - 10 - 11 - 12 - 13 - 14 - 15 - 16 - 17 - 18 - 19 mm

4,3 kg

	CHF	
MM26	826.00	1 024580026
MMV26	85.50	1 024590026



MM30

31

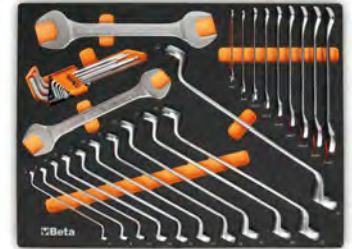

- 55 6x7-8x9-10x11-12x13-14x15-16x17 - 18x19-20x22-21x23-24x27-30x32 mm
- 90 6x7-8x9-10x11-12x13-14x15-16x17 - 18x19-20x22-21x23-24x27-30x32 mm
- 96BPC/SC9 1,5 - 2 - 2,5 - 3 - 4 - 5 - 6 - 8 - 10 mm

4,9 kg

	CHF	
MM30	549.00	1 024580030
MMV30	85.50	1 024590030

MM60

23



- 96T 2 - 2,5 - 3 - 4 - 5 - 6 - 7 - 8 - 10 mm
- ⊕ 97BTX/SC8 T9-T10-T15-T20-T25-T27-T30-T40
- 944BX 5-6-7-8-10-13 mm

2,2 kg

	CHF	
MM60	512.00	1 024580060
MMV60	85.50	1 024590060

MM63

8



- 952 7 - 8 - 10 - 12 - 13 - 14 - 17 - 19 mm

3,4 kg

	CHF	
MM63	472.00	1 024580063
MMV63	85.50	1 024590063

MM100

98



- 895/1
- 895/3
- 895/6
- 900 4 - 4,5 - 5 - 5,5 - 6 - 7 - 8 - 9 - 10 - 11 - 12 - 13 - 14 mm
- 900L 5 - 6 - 7 - 8 - 9 - 10 - 11 - 12 - 13 mm
- 900ME 3-4-5-6-7 mm
- 900LP 0,8x4 - 1x5,5 - 1,2x6,5 - 1,2x8 mm
- ⊕ 900PH PH1-PH2-PH3-PH4
- ⊕ 900TX T10 - T15 - T20 - T25 - T27 - T30 - T40
- 900/20 50 mm
- 900/20L 100 mm
- 900/21 150 mm
- 900/25
- 900BG/30
- 900/42
- ⊕ 900/55
- 920A 8-10-11-12-13-14-15-16-17-18-19-20-21-22-23-24-26-27-28-30-32 mm
- 920/15
- 920/25
- 920AN/125 125 mm
- 920AN/250 250 mm
- 920/42
- ⊕ 920/55
- 920/42 10 - 12 - 14 - 16 - 18 - 20 - 22 - 24 mm
- 920AL 10 - 12 - 13 - 14 - 15 - 16 - 17 - 18 - 19 - 21 - 22

6,7 Kg



	CHF	
MM100	1,510.00	1 024580100
MMV100	85.50	1 024590100



MM105

107



- 895/1 ○1/4-□1/4
- 895/3 ○1/4-□3/8
- 895/6 ○5/16-□1/2
- 900 4 - 4,5 - 5 - 5,5 - 6 - 7 - 8 - 9 - 10 - 11 - 12 - 13 - 14 mm
- 900L 5 - 6 - 7 - 8 - 9 - 10 - 11 - 12 - 13 mm
- 900ME 3-4-5-6-7 mm
- 900LP 0,8x4 - 1x5,5 - 1,2x6,5 - 1,2x8
- ⊕ 900PH PH1-PH2-PH3-PH4
- ⊕ 900TX T10 - T15 - T20 - T25 - T27 - T30 - T40
- 900/16
- 900/... 50-100-150 mm
- 900/25
- 900BG/30 176 mm
- 900/42 115 mm
- ⊕ 900/55 125 mm
- 910A 6 - 7 - 8 - 9 - 10 - 11 - 12 - 13 - 14 - 15 - 16 - 17 - 18 - 19 - 20 - 21 - 22 mm
- 910/15 □3/8-■1/4
- 910/16 □3/8-■1/2
- 910/21 125 mm
- 910/22 250 mm
- 910/25
- 910/42 210 mm
- ⊕ 910/55 200 mm
- 920A 8 - 10 - 11 - 12 - 13 - 14 - 15 - 16 - 17 - 18 - 19 - 20 - 21 - 22 - 23 - 24 - 26 - 27 - 28 - 30 - 32 mm
- 920/15 □1/2-■3/8
- 920/25
- 920AN 125-250 mm
- 920/42 305 mm
- ⊕ 920/55 275 mm
- 956E 16 mm (5/8") - 17,8 (11/16") - 20,8 (13/16")

7,2 kg

14" 38" 12"



	CHF	
MM105	1,585.00	1 024580105
MMV105	85.50	1 024590105

MM129

12



- 1032 180 mm
- 1034 170 mm
- 1036 175 mm
- 1038 175 mm
- 1048N 250 mm
- 1052 240 mm
- ⚡ 1082BM 160 mm
- 1098 220 mm
- 1128BM
- 1150BM 180 mm
- 1166BM 160 mm

2,9 Kg



	CHF	
MM129	536.00	1 024580129
MMV129	85.50	1 024590129



MM210

25



- 1201E 2,5x50 - 3x75 - 4x100 - 5,5x125 - 6,5x150 - 8x200 mm
- 1201EN 4x30 mm
- ⊕ 1202E PH0x60 - PH1x80 - PH2x100 - PH3x150 mm
- ⊕ 1202EN PH1X30 mm
- ⊕ 1207E/TX T6 - T7 - T8 - T9 - T10 - T15 - T20 - T25 - T27 - T30 - T40 - T45
- 1253

2,1 kg



	CHF	
MM210	276.00	1 024580211
MMV210	85.50	1 024590211

MM230

25



30	Ø 2-3-4 mm
31	Ø 2-3-4-5-6-8 mm
32	Ø 4 mm
34	150 mm
35	200-250 mm
36	125 mm
1370	500 g
1390	Ø 35 mm
1692	3 m
1712TF	
1719BMA...Q	200 mm
1719BMA...T	200 mm
1719BMA...P	200 mm
1719BMA...M	200 mm
1719BMA...R	200 mm
1737NX	
1771	

3,2 Kg



CHF



MM230	553.00	1	024580230
MMV230	85.50	1	024590230

MM400

29



3932U	
3935	120 mm
3937	170 mm
3952	13 - 14 - 15 - 16 - 17 - 18 - 19 mm
<input type="checkbox"/> 3961 3,2	
<input type="checkbox"/> 3961 3,3	
<input type="checkbox"/> 3961 3,5	
<input type="checkbox"/> 3961U	3,2 - 4,0 mm
3969	200 mm (x2)
3969K3	113 mm
3973/1	
3973/2	
3973/3	
3973/4	
3984/1	
3984/2	
3984/3	
3984/4	
3991	222 mm
3992	234 mm

3,1 kg



CHF



MM400	784.00	1	024580400
MMV400	85.50	1	024590400

MM401

7



3921	440 mm
3948	
3953	
3955	30x32 mm - 32x36 mm
3967	289 mm
3971	

2,7 kg



CHF



MM401	474.00	1	024580401
MMV401	85.50	1	024590401

VPM0

plateau thermoformé souple

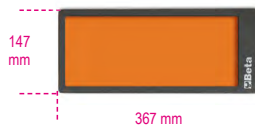

CHF



VPM0	35.50	1	088870350
------	-------	---	-----------

VPM3

plateau thermoformé souple avec 4 bacs de rangement

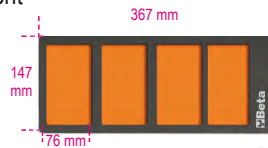

CHF



VPM3	35.50	1	088870353
------	-------	---	-----------

VPM7

plateau thermoformé souple avec 3 bacs de rangement

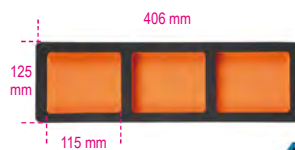

CHF



VPM7	37.00	1	088870356
------	-------	---	-----------

VPM8

plateau thermoformé souple



CHF



VPM8	28.50	1	088870357
------	-------	---	-----------

VPM9

plateau thermoformé souple



CHF
27.50



VPM9	27.50	1	088870358
------	-------	---	-----------

VPM7-C

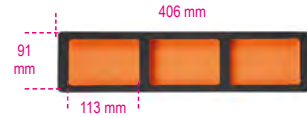

CHF
43.50



VPM7C	43.50	1	088870360
-------	-------	---	-----------



Beta

Plateaux thermoformés rigides série T



Compositions d'outils en plateaux thermoformés pour tous les modèles de servantes et coffres et pour les chariots.

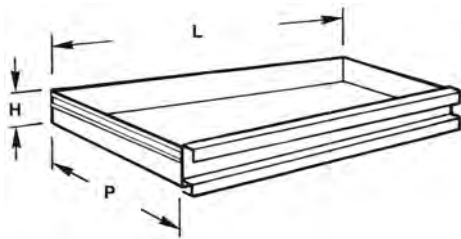

H	LxP
mm	mm
70	588x367

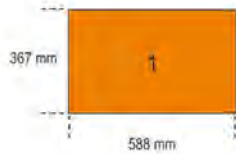
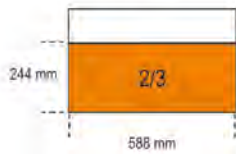
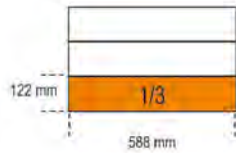
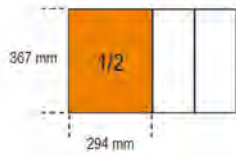
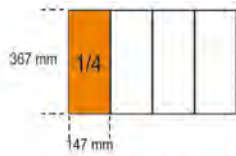

T01



42 6-7-8-10-11-12-13
14-16-17-18-19-21
22-24-27-30 mm

2,7 kg

CHF	1	024240001
T01	334.00	1 024240001
TV10	44.00	1 024000400

T05



42 6-7-8-9-10-11-12
13-14-15-16-17
18-19-20-21 mm

1,5 kg

CHF	1	024240005
T05	254.00	1 024240005
TV15	33.50	1 024000445

T06



42 22-24-27-30-32 mm

2,1 kg

CHF	1	024240006
T06	180.50	1 024240006
TV16	33.50	1 024000446

T18



42MP 6-7-8-9-10-11-12
13-14-15-16-17
18-19-20-21 mm

1,5 kg

CHF	1	024240018
T18	371.00	1 024240018
TV15	33.50	1 024000445

T19



42MP 22-24-27-30-32 mm

2,1 kg

CHF	1	024240019
T19	244.00	1 024240019
TV16	33.50	1 024000446

T22



42AS 5/16-3/8-7/16-1/2
9/16-5/8-11/16-3/4
Ø96AS/BG7 3/32-1/8-5/32-3/16
1/4-5/16-3/8

1 kg

CHF	1	024240022
T22	199.50	1 024240022
TV20	33.50	1 024000488

T23



42INOX 8-10-11-12-13-14-15-17-19 mm
Ø96BPINOX 2,5-3-4-5-6-8-10 mm

1 kg

CHF	1	024240023
T23	346.00	1 024240023
TV23	33.50	1 024249906

T31



31 Ø 2-3-4-5-6 mm
32 Ø 4 mm
55 6x7-8x9-10x11
12x13-14x15
16x17-18x19
20x22-21x23
24x26-27x29
30x32 mm
Ø96N/SC9 1,5+10 mm

3 kg

CHF	1	024240031
T31	281.00	1 024240031
TV30	44.00	1 024000401

T33



55 6x7-8x9-10x11
12x13-14x15
16x17-18x19
20x22 mm
○96/SC9 1,5+10 mm

1 kg



	CHF		
T33	119.50	1	024240033
TV20	33.50	1	024000488

T34



55MP 6x7-8x9-10x11
12x13-14x15
16x17-18x19
20x22 mm
○96/SC9 1,5+10 mm

1 kg



	CHF		
T34	151.00	1	024240034
TV20	33.50	1	024000488

T40



90 6x7-8x9-10x11
12x13-14x15
16x17-18x19 mm

810 g



	CHF		
T40	131.50	1	024240040
TV40	33.50	1	024000456

T41



90 20x22-21x23
24x26-25x28
27x29 mm

1,5 kg



	CHF		
T41	195.50	1	024240041
TV41	33.50	1	024000457

T45



142 8-9-10-11-12
13-14-15-16
17-18-19 mm

1,3 kg



	CHF		
T45	392.00	1	024240045
TV45	33.50	1	024000498

T46



142SN 8-9-10-11-12
13-14-15-16
17-18-19 mm

1,5 kg



	CHF		
T46	467.00	1	024240046
TV46	33.50	1	024000499

T48



○96BPC/SC9 1,5+10 mm
142C 8-9-10-11-12
13-14-15-16
17-18-19 mm

1,4 kg



	CHF		
T48	334.00	1	024240048
TV47	33.50	1	024000763

T50



○96T 2-2,5-3-3,5-4-4,5
5-6-7-8-10 mm

1,3 kg



	CHF		
T50	221.50	1	024240050
TV50	44.00	1	024000764

T52



○96T 2-2,5-3-4-5-6 mm

350 g



	CHF		
T52	108.50	1	024240052
TV52	33.50	1	024000765

T55



○97TTX T10-T15-T20
T25-T27-T30

330 g



	CHF		
T55	125.00	1	024240055
TV55	33.50	1	024000766

T59



111E 250 mm
920/40 ■ 1/2
951 2,5-3-4-5-6-8 mm
○953 4-5-6-8 mm
1370 300 - 500 g

4,7 kg



	CHF		
T59	560.00	1	024240059
TV60	65.50	1	024000420

T63



○952 7 - 8 - 10 - 12 - 13 - 14 - 17 - 19 mm

3,8 kg



	CHF		
T63	424.00	1	024240063
TV63	54.50	1	024000471

T64

8



- 952FTX E10-E12-E14
- 953TX T25 - T27 - T30 - T40 - T45

3,8 kg



	CHF		
T64	520.00	1	024240064
TV63	54.50	1	024000471

T65

8



- 953 3 - 3,5 - 4 - 5 - 6 - 7 - 8 - 10 mm

2,8 kg



	CHF		
T65	404.00	1	024240065
TV63	54.50	1	024000471

T68

6



- 951 2,5-3-4-5-6-8 mm

590 g



	CHF		
T68	181.00	1	024240068
TV68	33.50	1	024000470

T73

8



- 930 6x7 - 8x9 - 10x11 - 12x13 - 14x15 - 16x17 - 18x19 - 20x22 mm
- 940/1
- 940/2

1,3 kg



	CHF		
T73	270.00	1	024240073
TV73	33.50	1	024000418

T75

16



- 933 7-8-9-10-11-12-13 - 14-15-16-17-18-19 - 21-22-24 mm

4,2 kg



	CHF		
T75	551.00	1	024240075
TV75	65.50	1	024000422

T76

16



- 932 7-8-9-10-11-12-13 - 14-15-16-17-18-19 - 21-22-24 mm

4,2 kg



	CHF		
T76	551.00	1	024240076
TV75	65.50	1	024000422

T77

10



- 933 6-7-8-10-11-12-13 - 14-17-19 mm

1,4 kg



	CHF		
T77	275.00	1	024240077
TV77	33.50	1	024000474

T80

29



- 920A 10-11-12-13-14 - 15-16-17-18-19 - 20-21-22-23-24 - 26-27-30-32 mm
- 920ME 5-6-8-10-12 mm
- 920/21 125 mm
- 920/22 255 mm
- 920/25
- 920/42 305 mm
- 920/55

4,1 kg

12"



	CHF		
T80	515.00	1	024240080
TV80	44.00	1	024000403

T81

29



- 920B 10-11-12-13-14 - 15-16-17-18-19 - 20-21-22-23-24 - 26-27-30-32 mm
- 920ME 5-6-8-10-12 mm
- 920/21 125 mm
- 920/22 255 mm
- 920/25
- 920/42 305 mm
- 920/55

4,1 kg

12"



	CHF		
T81	515.00	1	024240081
TV80	44.00	1	024000403

T82

29



- 920A 10-11-12-13-14 - 15-16-17-18-19 - 20-21-22-23-24 - 26-27-30-32 mm
- 920ME 5-6-8-10-12 mm
- 920AN/125 125 mm
- 920AN/250 250 mm
- 920/25
- 920/42 305 mm
- 920/55

4,1 kg

12"



	CHF		
T82	531.00	1	024240082
TV80	44.00	1	024000403

T83

24



- 920A 10-11-12-13-14 - 15-16-17-18-19 - 20-21-22-23-24 - 26-27-30-32 mm
- 920/21 125 mm
- 920/22 255 mm
- 920/25
- 920/42 305 mm
- 920/55

3,6 kg

12"



	CHF		
T83	398.00	1	024240083
TV83	44.00	1	024000402



T85



- 861LP 0,5x3 - 0,6x4,5 - 0,8x5,5 - 1x5,5 - 1,2x6,5 - 1,2x8 - 1,6x8 mm
- 861PE 2 - 2,5 - 3 - 4 - 5 - 6 - 8 - 10 mm
- 861PH PH0 - PH1 - PH2 - PH3
- 861PZ PZ1 - PZ2 - PZ3
- 861TX T6 - T7 - T8 - T9 - T10 - T15 - T20 - T25 - T27 - T30 - T40
- 861RTX T9 - T10 - T15 - T20 - T25 - T27 - T30 - T40
- 861TRW 1-2-3-4-5-6 mm
- 861TQS 0 - 1 - 2 - 3 - 4 - 5 - 6 - 8 - 10 mm
- 861SP 4-6-8-10-12 mm
- 851SR 230 mm
- 900 4-4,5-5-5,5-6-7-8-9 - 10-11-12-13-14 mm
- 900/21 150 mm
- 900/25 41 mm
- 900BG/30 176 mm
- 900/42 115 mm
- 900/55 125 mm
- 194 1/4x5/16

1,0 kg

14"



T85	CHF 436.00	1	024240085
TV85	CHF 44.00	1	024000747

T91



- 900 4-4,5-5-5,5-6 - 7-8-9-10-11 - 12-13-14 mm
- 900ME 2,5-3-4-5-6-8 mm
- 900/20 50 mm
- 900/21 150 mm
- 900/25 41 mm
- 900BG/30 176 mm
- 900/42 115 mm
- 900/55 125 mm

560 g

14"



T91	CHF 278.00	1	024240091
TV90	CHF 33.50	1	024000447

T92



- 910A 6-7-8-9-10-11-12-13 - 14-15-16-17-18-19 - 20-21-22 mm
- 910/21 125 mm
- 910/22 250 mm
- 910/25 41 mm
- 910/42 210 mm
- 910/55 125 mm

1,5 kg

38"



T92	CHF 315.00	1	024240092
TV92	CHF 33.50	1	024000458

T99



- 920INOX-A 10-12-13-14-15-16-17 - 18-19-21-22-24-27 - 30-32 mm
- 920/55INOX



2,7 kg

12"



T99	CHF 1,485.00	1	024240099
TV99	CHF 33.50	1	024249908

T100



- 920A 10-12-13-14-15 - 16-17-18-19-21 - 22-24 mm
- 920/21 125 mm
- 920/25 41 mm
- 920/42 305 mm
- 920/55 125 mm

2,1 kg

12"



T100	CHF 285.00	1	024240100
TV100	CHF 33.50	1	024000495

T101



- 920B 10-12-13-14-15 - 16-17-18-19-21 - 22-24 mm
- 920/21 125 mm
- 920/25 41 mm
- 920/42 305 mm
- 920/55 125 mm

2,1 kg

12"



T101	CHF 285.00	1	024240101
TV100	CHF 33.50	1	024000495

T102



- 920AS 3/8-7/16-1/2 - 9/16-5/8-11/16 - 3/4-13/16-7/8 - 15/16-1-1.1/16
- 920/21 125 mm
- 920/25 41 mm
- 920/42 305 mm
- 920/55 125 mm

2,1 kg

12"



T102	CHF 311.00	1	024240102
TV100	CHF 33.50	1	024000495

T103



- 900L 6-7-8-9-10-11-12 mm
- 920AL 13-14-16-17-18-19 - 21-22-24-27 mm

1,1 kg

14" 12"



T103	CHF 373.00	1	024240103
TV103	CHF 33.50	1	024000748

T105



- 928A 22-24-27-30-32-34 - 36-38-41-46-50 mm

4,9 kg

34"



T105	CHF 372.00	1	024240105
TV105	CHF 33.50	1	024000484

T106



- 928/21 200 mm
- 928/22 380 mm
- 928/42 450 mm
- 928/55 125 mm

4,5 kg

34"



T106	CHF 394.00	1	024240106
TV106	CHF 33.50	1	024000485

T111



- 720 10-13-15-17-18-19-21 - 22-24-27-30-32 mm
- 720LC 17-19-21 mm
- 720/21 125 mm

2,7 kg

12"



T111	CHF 320.00	1	024240111
TV111	CHF 33.50	1	024000476

T112

32



- 861TX ● 1/4-T6+T15
- 866TX ● 5/16-T20+T55
- 895/1 ○ 1/4x□1/4
- 895/6 ○ 5/16x□1/2
- 900FTX □ 1/4-E4+E10
- 920FTX □ 1/2-E12+E24
- 920TX □ 1/2-T55L-T60-T70L

1,3 kg

14" 12"



	CHF		
T112	378.00	1	024240112
TV112	33.50	1	024000480

T113

12



- 920PE 5L-6L-7L-8L-10L
- 920TX T40L-T45L
T55L-T70L
- 920XZN M6L-M8L-M12L

1,5 kg

12"



	CHF		
T113	332.00	1	024240113
TV113	33.50	1	024000489

T122

1



666/20 40 - 200 Nm

1,2 kg

12"



	CHF		
T122	368.00	1	024240122
TV122	33.50	1	024000768

T123

3



- 1082G 160 mm
- 1150G 180 mm
- 1166G 160 mm

550 g

CHF

	CHF		
T123	101.00	1	024240123
TV135	33.50	1	024000762

T124

3



- 1082GBM 160 mm
- 1150GBM 180 mm
- 1166GBM 160 mm

640 g

CHF

	CHF		
T124	129.00	1	024240124
TV135	33.50	1	024000762

T135

3



- 1082MQ 160 mm
- 1150MQ 180 mm
- 1166MQ 160 mm

1000 V

750 g

CHF

	CHF		
T135	214.00	1	024240135
TV135	33.50	1	024000762

T136

2



- 1048MQ 250 mm
- 1777MQ/U

1000 V

700 g

CHF

	CHF		
T136	152.50	1	024240136
TV136	33.50	1	024000438

T137

3



- 1084BM 160 mm
- 1150BM 180 mm
- 1166BM 160 mm

750 g

CHF

	CHF		
T137	144.50	1	024240137
TV130	33.50	1	024000451

T138

3



- 1084 160 mm
- 1150 180 mm
- 1166 160 mm

650 g

CHF

	CHF		
T138	119.50	1	024240138
TV130	33.50	1	024000451

T140

8



- 1032 140x0,9 - 180 mm
- 1034 170 mm
- 1036 140x1,3 - 175 mm
- 1038 175 mm
- 1084 160 mm
- 1128BM

1,1 kg

CHF

	CHF		
T140	294.00	1	024240140
TV140	44.00	1	024000405

T144

4



- 1048N 250 mm
- 1052 240 mm
- 1112 250 mm
- 1150 180 mm

1,8 kg

CHF

	CHF		
T144	169.00	1	024240144
TV143	44.00	1	024000409

T145

4



- 1032 180 mm
- 1034 170 mm
- 1036 175 mm
- 1038 175 mm

640 g

CHF

	CHF		
T145	162.50	1	024240145
TV145	33.50	1	024000448

T146



1032	140x0,9 mm
1032	225 mm
1036	140x1,3 mm
1036	225 mm

700 g



	CHF		
T146	170.50	1	024240146
TV146	33.50	1	024000449

T151



1047	240 mm
1057A	240 mm

1,3 kg



	CHF		
T151	146.50	1	024240151
TV150	33.50	1	024000462

T153



1048N	250 mm
1052	240 mm

1,1 kg



	CHF		
T153	88.50	1	024240153
TV150	33.50	1	024000462

T156



1082	160 mm
1150	180 mm
1048N	250 mm

1 kg



	CHF		
T156	117.00	1	024240156
TV148	33.50	1	024000500

T157



1082BM	160 mm
1150BM	180 mm
1048BM	250 mm

1,1 kg



	CHF		
T157	160.50	1	024240157
TV148	33.50	1	024000500

T160



1290	3x75
	3x100
	4x100
	4x150
	5,5x100
	5,5x150
	6,5x150
	8x150
	10x200 mm
1290N	4x30
	6,5x30 mm

1,3 kg



	CHF		
T160	176.50	1	024240160
TV160	44.00	1	024000706

T161



1292	PH0x60
	PH0x100
	PH1x80
	PH1x120
	PH2x100
	PH2x150
	PH3x150 mm
1292N	PH1x30
	PH2x30 mm

1 kg



	CHF		
T161	139.00	1	024240161
TV161	44.00	1	024000707

T164



952	8-10-13-17-19 mm
959	16 mm (5/8") - 20,8 mm (13/16")
1260	3x75 - 4x100 - 5,5x100 - 6,5x150 - 10x200 mm
1262	PH0x60 - PH1x80 - PH2x100 - PH3x150 mm

5 kg



	CHF		
T164	595.00	1	024240164
TV61	65.50	1	024000721

T167



1260	3x75
	3x100
	4x100
	4x150
	5,5x100
	5,5x150
	6,5x150
	8x150
	10x200 mm
1260N	4x30
	6,5x30 mm

1,3 kg



	CHF		
T167	142.50	1	024240167
TV160	44.00	1	024000706

T168



1262	PH0x60
	PH0x100
	PH1x80
	PH1x120
	PH2x100
	PH2x150
	PH3x150 mm
1262N	PH1x30
	PH2x30 mm

1 kg



	CHF		
T168	113.50	1	024240168
TV161	44.00	1	024000707

T170



1290	2,5x50
	3x75
	3,5x100
	4x125
	5,5x100
	5,5x150
	6,5x150 mm

450 g



	CHF		
T170	96.00	1	024240170
TV170	33.50	1	024000741

T171



1290	8x150
	8x200
	10x200 mm
1290N	4x30
	6,5x30 mm

750 g



	CHF		
T171	106.00	1	024240171
TV171	33.50	1	024000742

T172

Betamax



- 1292 PH0x60
PH0x100
PH1x80
PH1x120
PH2x100
PH2x150 mm

450 g



	CHF	Hand	PC
T172	87.50	1	024240172
TV172	33.50	1	024000743

T173

Betamax



- 1292 PH3x150
PH4x200 mm
- 1292N PH1x30
PH2x30 mm

560 g



	CHF	Hand	PC
T173	85.50	1	024240173
TV173	33.50	1	024000744

T175

Betamax



- 1297TX T6-T7-T8-T9
T10-T15-T20

410 g



	CHF	Hand	PC
T175	136.50	1	024240175
TV175	33.50	1	024000760

T176

Betamax



- 1297TX T25-T27-T30
T40-T45

640 g



	CHF	Hand	PC
T176	126.50	1	024240176
TV176	33.50	1	024000761

T177

Betamax



- 1298RTX T9-T10-T15
T20-T25-T27
T30-T40

680 g



	CHF	Hand	PC
T177	191.00	1	024240177
TV177	33.50	1	024000759

T180

Betamax



- 1290 3x75
4x100
5,5x150
6,5x150 mm
- 1292 PH0x60
PH1x80
PH2x100 mm

480 g



	CHF	Hand	PC
T180	100.00	1	024240180
TV180	33.50	1	024000701

T183

Betamax



- 1292L PH1x400-PH2x400 mm
- 1294L 3x300-4x400-5x400 mm

580 g



	CHF	Hand	PC
T183	135.00	1	024240183
TV183	33.50	1	024000497

T198

- 1260 3x75
4x100
5,5x150
6,5x150 mm
- 1269PZ PZ0 - PZ1 - PZ2

490 g



	CHF	Hand	PC
T198	85.00	1	024240198
TV180	33.50	1	024000701

T199

- 1260 2,5x50
3x75
3,5x100
4x125
5,5x100
5,5x150
6,5x150 mm

490 g



	CHF	Hand	PC
T199	76.00	1	024240199
TV170	33.50	1	024000741

T201

- 1260 8x200
10x150
10x200 mm
- 1260N 4x30
6,5x30 mm

680 g



	CHF	Hand	PC
T201	83.00	1	024240201
TV171	33.50	1	024000742

T202

- 1262 PH0x60
PH0x100
PH1x80
PH1x120
PH2x100
PH2x150 mm

490 g



	CHF	Hand	PC
T202	70.00	1	024240202
TV172	33.50	1	024000743

T204

- 1262 PH3x150
PH4x200 mm
- 1262N PH1x30
PH2x30 mm

610 g



	CHF	Hand	PC
T204	69.00	1	024240204
TV173	33.50	1	024000744

T205



1267TX T6-T7-T8-T9
T10-T15-T20

460 g



	CHF		
T205	100.00	1	024240205
TV175	33.50	1	024000760

T206



1267TX T25-T27-T30
T40-T45

710 g



	CHF		
T206	103.00	1	024240206
TV176	33.50	1	024000761

T207



1268RTX T9-T10-T15
T20-T25-T27-T30

760 g



	CHF		
T207	122.50	1	024240207
TV207	33.50	1	024000758

T208



1260 3x75
4x100
5,5x150
6,5x150 mm
1262 PH0x60
PH1x80
PH2x100 mm

530 g



	CHF		
T208	80.50	1	024240208
TV180	33.50	1	024000701

T209



1262L PH1x400-PH2x400 mm
1264L 3x300 - 4x400 - 5x400 mm

580 g



	CHF		
T209	100.50	1	024240209
TV183	33.50	1	024000497

T211



1201E 2,5x50
3x75
3,5x100
4x125
5,5x100
5,5x150
6,5x150 mm

490 g



	CHF		
T211	54.00	1	024240211
TV170	33.50	1	024000741

T213



1202E PH0x60
PH1x80
PH1x120
PH2x100
PH2x150
PH3x150 mm

490 g



	CHF		
T213	59.00	1	024240213
TV212	33.50	1	024000440

T216



1207E/TX T6-T7-T8-T9
T10-T15-T20

410 g



	CHF		
T216	75.00	1	024240216
TV175	33.50	1	024000760

T221



1201E 3x75
4x100
5,5x150
6,5x150 mm
1202E PH0x60
PH1x80
PH2x100 mm

530 g



	CHF		
T221	57.00	1	024240221
TV180	33.50	1	024000701

T226



1274MQ 3x100
4x100
5,5x125
6,5x150 mm
1272MQ PH0x60
PH1x80
PH2x100 mm

1000 V

460 g



	CHF		
T226	124.00	1	024240226
TV180	33.50	1	024000701

T227



944BX 5-6-7-8-10-13 mm

490 g



	CHF		
T227	174.00	1	024240227
TV227	33.50	1	024000705

T228



1290INOX 3x75 - 4x100 -
5,5x150 - 6,5x150 mm
1292INOX PH0x60
- PH1x80 - PH2x100
mm



480 g



	CHF		
T228	111.50	1	024240228
TV180	33.50	1	024000701

T231



1370 400 g
1390 Ø 35 mm
▲ 1719BMA/T 200 mm
■ 1719BMA/P 200 mm
▶ 1719BMA/M 200 mm

1,7 kg



	CHF		
T231	152.50	1	024240231
TV230	44.00	1	024000411

T233



35 100-200 mm
1370F 32 mm
1390 Ø 35 mm

1,3 kg



	CHF		
T233	139.50	1	024240233
TV232	33.50	1	024000452

T234



35 100-200 mm
1370 300 g
1390 Ø 35 mm

1,3 kg



	CHF		
T234	125.00	1	024240234
TV232	33.50	1	024000452

T236



■ 1719BMA/Q 200 mm
▲ 1719BMA/T 200 mm
■ 1719BMA/P 200 mm
▶ 1719BMA/M 200 mm
● 1719BMA/R 200 mm

870 g



	CHF		
T236	124.00	1	024240236
TV235	33.50	1	024000453

T239



31BM Ø 2-3-4-5-6-8 mm
32 Ø 4 mm

850 g



	CHF		
T239	164.50	1	024240239
TV239	33.50	1	024000439

T241



1500N/1
1500N/3
1516/1

4,2 kg



	CHF		
T241	384.00	1	024240241
TV241	44.00	1	024000414

T259



○ 96BP 2,5-3-4-5
6-8-10 mm
○ 96N 12 mm
● 860MIX/A31
○
○
○
○
895/1

950 g



	CHF		
T259	192.00	1	024240259
TV263	33.50	1	024000492

T264



1491 Ø 65+110 mm
■ 1494 ■ 10 mm
○ 1494E ○ 8 - 9 - 10 - 11 - 12 - 14 - 17 mm
○ 1494Q ○ 8-9,5-12-13 mm
△ 1494T △ 9,5
○ 1494XZN ○ 16
1496C ■ 8x ■ 10 mm

2,1 kg



	CHF		
T264	288.00	1	024240264
TV264	33.50	1	024000466

T270



430 M3 - 4 - 5 - 6 - 7 - 8 - 9
10 - 12 - 14 - 16 - 18 - 20
433 M6x0,75 - M8x1 - M10x1,25
M12x1,5 - M14x1,5
M16x1,5 - M18x1,5
440 M3 - 4 - 5 - 6 - 7 - 8 - 9
440A M10 - 12 - 14 - 16 - 18 - 20
441 M6x0,75 - M8x1,0
441A M10x1,25 - M12x1,5
M14x1,5 - M16x1,5
M18x1,5

4,3 kg



	CHF		
T270	665.00	1	024240270
TV270	44.00	1	024000481

T273



435/1,5 M3=M12
435/3 M5=M21
436/1 □ 2,0+5,0 mm
(M3=M8)
436/2 □ 4,6+8 mm
(M5=M12)
444/1 Ø 25,4 mm
444/2 Ø 38,1 mm
1707 W 62+4x1"

2,1 kg



	CHF		
T273	303.00	1	024240273
TV272	44.00	1	024000482

T281



1741B 250 mm
1741RV2,9K 2,9x6 mm (100)
1741RV3,2K 3,2x8 mm (100)
1741RV3,8K 3,8x10 mm (100)
1741RV4K 4x12 mm (100)

1,4 kg



	CHF		
T281	94.00	1	024240281
TV280	33.50	1	024000478

Beta
Quality Tools

T279



1112	250 mm
1128BM	
1726	400 mm
1728BM	(x5)
1751N	200 cc

1,5 kg



	CHF	
T279	163.50	1 024240279
TV285	54.50	1 024000487

T284



1128BMX	
1130BMX	
■ 1719BMA...Q	200 mm
▲ 1719BMA...T	200 mm
■ 1719BMA...P	200 mm
► 1719BMA...M	200 mm
● 1719BMA...R	200 mm
1726BM	400 mm
1728BM	
1771BM	170 mm
1778V18	185 mm

3,3 kg



	CHF	
T284	325.00	1 024240284
TV286	65.50	1 024249904

T291



1479RB/1
1479RB/2
1479RB/3

600 g



	CHF	
T291	130.00	1 024240291
TV291	33.50	1 024000472

T294



1692	5 m
1725CR	
1771RL	
1771	

590 g



	CHF	
T294	90.00	1 024240294
TV294	33.50	1 024000491

T297



1651DGTB
1682
1691BM

490 g



	CHF	
T297	180.50	1 024240297
TV296	33.50	1 024000749

Beta

Beta

Beta

VP1 - VP2

Bacs de rangement compartimentés en matière plastique pour tous les modèles de coffres: RSC22, RSC23, RSC23C

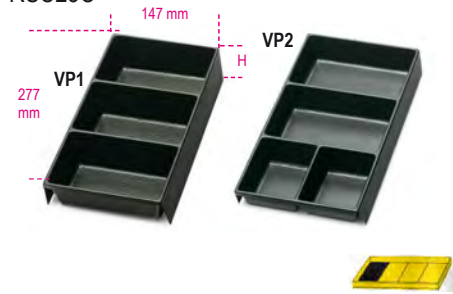

	H mm	CHF		
VP1	50	19.00	1	088880351
VP2	35	19.00	1	088880352

VP3 - VP4

Bacs de rangement compartimentés en matière plastique pour tous les modèles de servants et coffres et pour les chariots

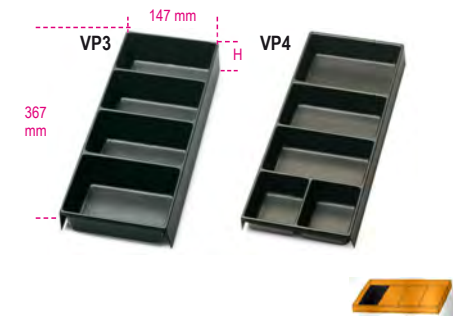

	H mm	CHF		
VP3	50	20.00	1	088880353
VP4	35	20.00	1	088880354

VP5

Bacs de rangement



	CHF		
VP5	22.60	1	088880355

VP6

Bacs de rangement



	CHF		
VP6	22.90	1	088880359

VP-3SC

Bacs de rangement compartimentés en matière plastique pour C38 +C04TSS-7

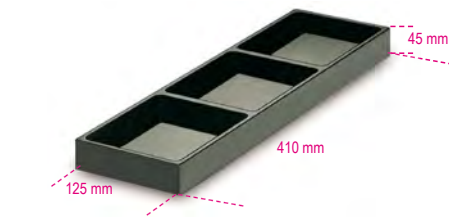

	H mm	CHF		
VP-3SC	45	24.10	1	088880356

VP-LS

Bacs de rangement compartimentés en matière plastique pour C38 +C04TSS-7



	H mm	CHF		
VP-LS	45	16.40	1	088880357

VP-LD

Bacs de rangement compartimentés en matière plastique pour C38



	H mm	CHF		
VP-LD	45	15.80	1	088880358

8889P1

Séparateurs parallèles pour RSC22, RSC23, RSC23C et C27S
Tiroir 588x277 mm

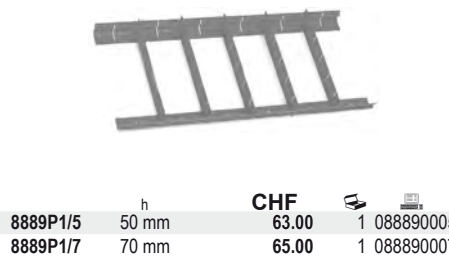

	h	CHF		
8889P1/5	50 mm	63.00	1	088890005
8889P1/7	70 mm	65.00	1	088890007

8889C1

Séparateurs croisés pour RSC22, RSC23, RSC23C et C27S
Tiroir 588x277 mm



	h	CHF		
8889C1/5	50 mm	85.00	1	088890015
8889C1/7	70 mm	87.00	1	088890017

8889P2

Séparateurs parallèles pour tiroir standard 588x367 mm

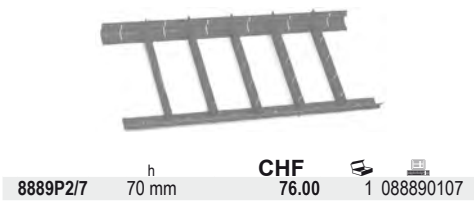

	h	CHF		
8889P2/7	70 mm	76.00	1	088890107

8889C2

Séparateurs croisés pour tiroir standard 588x367 mm

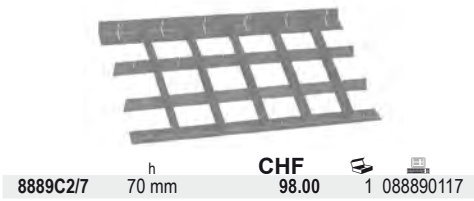

	h	CHF		
8889C2/7	70 mm	98.00	1	088890117

8889P3

Séparateurs parallèles pour RSC24AXL

Tiroir 882x367 mm

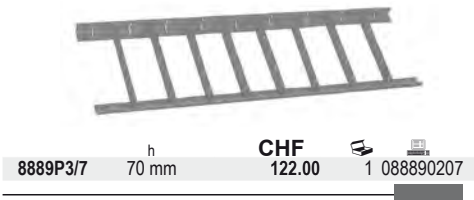

	h	CHF		
8889P3/7	70 mm	122.00	1	088890207

8889C3

Séparateurs croisés pour RSC24AXL

Pour tiroir 882x367 mm

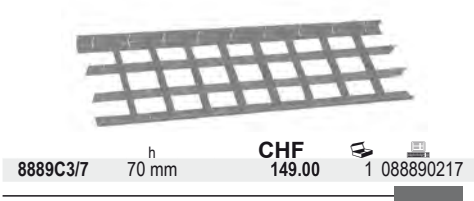

	h	CHF		
8889C3/7	70 mm	149.00	1	088890217

8889P4

Séparateurs parallèles pour chariot C41

Tiroir 418x205 mm

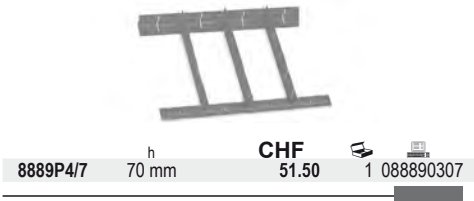

	h	CHF		
8889P4/7	70 mm	51.50	1	088890307

8889I4

Séparateurs croisés pour chariot C41

Tiroir 418x205 mm

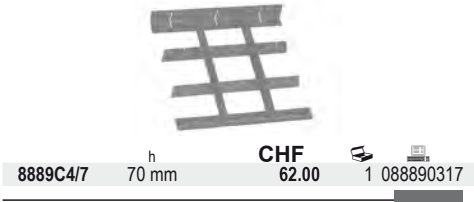

	h	CHF		
8889C4/7	70 mm	62.00	1	088890317

8889PS

Séparateurs parallèles pour C38 - C45PRO M4/M5/M7/M8

Tiroir côté gauche 570x410 mm



8889PS/7 h 70 mm CHF 90.50 1 088890407

8889CS

Séparateurs croisés pour C38 - C45PRO M4/M5/M7/M8

Tiroir côté gauche 570x410 mm



8889CS/7 h 70 mm CHF 110.50 1 088890417

8889PD

Séparateurs parallèles pour C38

Tiroir côté droit 313x410 mm



8889PD/7 h 70 mm CHF 48.50 1 088890427

8889CD

Séparateurs croisés pour C38

Tiroir côté droit 313x410 mm



8889CD/7 h 70 mm CHF 66.50 1 088890437

8889C6

Séparateurs croisés pour C35

Tiroir 600x447 mm



8889C6/7,5 h 75 mm CHF 47.00 1 088890475
8889C6/10 h 100 mm CHF 46.50 1 088890480
8889C6/15 h 150 mm CHF 57.50 1 088890485
8889C6/20 h 200 mm CHF 90.00 1 088890490

SB

Rail porte-douilles



	L mm	CHF		
SB1	210	4.85	10	088880201
SB2	280	5.35	10	088880202
SB3	360	5.65	10	088880203

PM 1/2-Q5

Rail magnétique porte douilles



PM 1/2-Q5 CHF 59.00 1 088880233

MB

Clips porte-douilles pour rail SB



	□	CHF		
MB0	1/4	1.44	50	088880210
MB1	3/8	1.44	50	088880211
MB2	1/2	1.44	50	088880212

KIT/GPS

Jeu de crochets 40 mm avec vis VE1



	CHF		
KIT/GPS-40 mm	2.78	50	088880119
KIT/GPS-90 mm	4.05	50	088880117

VE1

Vis à expansion



VE1 CHF 0.98 20 088880120

GM

Crochet à ressort avec vis à expansion VE1



∅ mm	CHF		
6,5	8.85	5	088880250
9,5	9.25	5	088880251
13	9.25	5	088880252
16	10.90	5	088880253
19	11.40	5	088880254
25	10.70	5	088880255

S55/8

Support pour 8 clés à fourches, en tôle

• Fourni avec 3 vis à expansion VE1

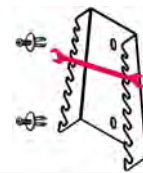

S55/8 CHF 30.50 1 088880420
55/S8
55AS/8
55MP/S8

S55/12

Support pour 12 clés à fourches, en tôle

• Fourni avec 3 vis à expansion VE1

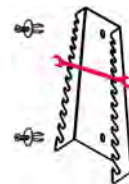

S55/12 CHF 37.00 1 088880421
55/S12
55/S12X
55AS/12
55MP/S12

ST2P

Poche porte-pinces, en tôle

• Fourni avec 3 vis à expansion VE1

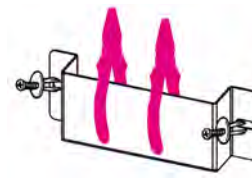

ST2P CHF 33.50 1 088880422

TSPP

Poche porte-outils, en plastique

• Fourni avec 3 vis à expansion VE1



TSPP CHF 7.50 1 088880402

S952/10

Support pour 10 clés à béquille, en tôle

• Fourni avec 4 vis à expansion VE1

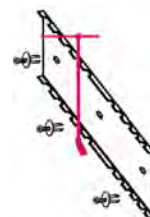

S952/10 CHF 39.50 1 088880423

S1719BM

Support pour 5 limes, en tôle

• Fourni avec 3 vis à expansion VE1



S1719BM	CHF		
1719BMA: Q-T-P-M-R	22.90	1	088880404
1719BMD: Q-T-P-M-R			
1719BMX: Q-T-P-M-R			

SGN

Support pour 2 mini tournevis, en tôle

• Fourni avec 3 vis à expansion VE1



SGN	CHF		
1290N-1292N-1299N/PZ	11.60	1	088880405
1260N-1262N-1269N/PZ			
1201EN-1202EN-1209EN/PZ			

CB/2

Plateau thermoformé rigide vide pour douilles et accessoires de 1/2"

• Uniquement pour C54S

12"



CB/2	CHF		
920A/920B	35.50	1	088880411
10÷24+26-27			
28-30-32 mm			
920/21-920/22-920/25-			
920/42-920/55			

S42/17

Support pour 17 clés mixtes, en tôle

• Fourni avec 3 vis à expansion VE1

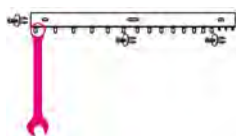

S42/17	CHF		
42/S17	39.00	1	088880428
42MP/S17			
42/S17X			
42AS/17			
142/S17			

S951/6

Support pour 6 clés mâles en T, en tôle

• Fourni avec 3 vis à expansion VE1

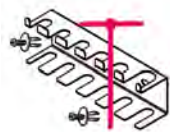

S951/6	CHF		
951/S6	26.00	1	088880429
951AS/S6X			
951TX/S6			

SPG11 - S1203/8

Support pour tournevis, en tôle

• Fourni avec 3 vis à expansion VE1



SPG11	CHF		
n.8 Ø = 7 mm	27.00	1	088880910
n.2 Ø = 10 mm			
n.1 Ø = 12 mm			
S1203/8	CHF		
1203E/S8	28.50	1	088880430
1263/D8			
1293/S8			

S96T/8

Support pour 8 clés mâles 6 pans à poignée en T haute performance, en tôle

• Fourni avec 3 vis à expansion VE1



S96T/8	CHF		
96T/AS8	28.50	1	088880431
96T/S8			
97TTX/S8			

96T/SPV

Support pour 11 clés mâles 6 pans à poignée en T haute performance, en tôle

• Fourni avec 3 vis à expansion VE1



96T/SPV	CHF		
96T/S11	56.00	1	000960958
97TTX/S11			

Beta



Beta CHEMICALS

Serrer un boulon ne suffit pas toujours pour obtenir un serrage sûr. Il faut le nettoyer, le lubrifier, le sceller.

La famille se compose d'agents scellants anaérobies, d'adhésifs cyanoacryliques et d'aérosols pour la maintenance, le nettoyage et lubrification des composants mécaniques.

Produits en milieu anaérobie

Les produits en milieu anaérobie garantissent le remplissage complet des petites irrégularités superficielles du métal, de sorte à garantir la distribution des sollicitations mécaniques sur toute la surface de connexion. Ils se consolident en absence totale d'oxygène et scellent complètement le raccord ou le taraudage pour l'eau, le gaz, les huiles, les carburants et les fluides industriels.

Ils sont disponibles en trois classes de résistances : haute (H), moyenne (M) et basse (L) et en différentes tailles de packaging pour toutes les exigences.

Mastic silicone

Les mastics silicone permettent une étanchéité élastique permanente, empêchant ainsi les petits éléments de pénétrer dans le joint (débris, poussières...) et remplaçant les joints préformés. Grâce à leur capacité élastique, ils peuvent absorber les mouvements sans être affectés par une dilatation intérieure ou une rupture. Les mastics silicone polymérisent en réagissant avec l'humidité atmosphérique et forment des joints élastiques et durables.

Le produit est fourni avec un buse automatique pratique (pack sous pression), ce qui simplifie le travail. Il peut également être utilisé d'une seule main, tout en assurant une diffusion précise et uniforme.

Colle instantanée

Adhésif à l'éthyle cyanoacrylate pour joints structurels de différents matériaux.

Aérosol

Vaste gamme de produits en aérosol conçus pour débloquer, graisser, lubrifier, nettoyer, galvaniser et hygiéniser.

Liquides

Créés pour éliminer les incrustations et la rouille présentes sur les pièces mécaniques et les objets en métal. Idéals pour l'emploi dans les cuves de lavage à ultrasons 1895.



ATTENTION

Countries where the products of the Beta Chemicals range are allowed to be distributed: Austria, Andorra, Belgium, Czech Republic, Dominican Republic, France, Hungary, Italy, Netherlands, New Caledonia, People's Republic of China, Poland, Portugal, Principality of Monaco, Republic of Ireland, Reunion, San Marino, Slovakia, Slovenia, Spain, Switzerland, United Arab Emirates, United Kingdom.

9803H

frein filet-Forte résistance

Idéal pour le blocage permanent.
Idéal pour tous les pièces qui ne doivent pas être démontées ou pour l'application sur les surfaces métalliques passivées telles que le cuivre, l'aluminium, l'acier inox etc.
Ne permet pas le démontage avec outils manuels.



Température (°C)	-50/+150
Jeu diamétral (mm)	0,25
Vitesse de réaction blocage manuel (minutes)	10/15
Durcissement fonctionnel (heures)	3-6
Viscosité (mPa.s) 25°C	800/1200
Couple de dévissage INITIAL ISO-10964	35-45 Nm
Couple de dévissage RESIDUEL ISO-10964	30-40 Nm

ml	CHF		
20 Flaçon	14.80	12	098030002
50 Flaçon	22.50	4	098030005
250 Flaçon	57.00	4	098030025
20 Flaçon		12	098032002
50 Flaçon		4	098032005
250 Flaçon		4	098032025

9802M

frein filet-Moyenne résistance

Idéal pour fixer et bloquer les parties soumises à maintenance périodique.
Permet le démontage avec des outils manuels.



Température (°C)	-50/+150
Jeu diamétral (mm)	0,15
Vitesse de réaction blocage manuel (minutes)	10/15
Durcissement fonctionnel (heures)	3-6
Viscosité (mPa.s) 25°C	500/800
Couple de dévissage INITIAL ISO-10964	22-30 Nm
Couple de dévissage RESIDUEL ISO-10964	20-25 Nm

ml	CHF		
20 Flaçon	14.80	12	098020002
50 Flaçon	22.50	4	098020005
250 Flaçon	57.00	4	098020025
20 Flaçon		12	098022002
50 Flaçon		4	098022005
250 Flaçon		4	098022025

9801L

frein filet-Basse résistance

Idéal pour fixer les détails en alliages légers qui pourraient s'endommager en phase de démontage ou pour les vis de réglage.
Démontage des pièces facilité.



Température (°C)	-50/+150
Jeu diamétral (mm)	0,10
Vitesse de réaction blocage manuel (minutes)	10/15
Durcissement fonctionnel (heures)	3-6
Viscosité (mPa.s) 25°C	500/800
Couple de dévissage INITIAL ISO-10964	6-10 Nm
Couple de dévissage RESIDUEL ISO-10964	4-8 Nm

ml	CHF		
20 Flaçon	14.80	12	098010002
50 Flaçon	22.50	4	098010005
250 Flaçon	57.00	4	098010025
20 Flaçon		12	098012002
50 Flaçon		4	098012005
250 Flaçon		4	098012025

9813H

scellant à filet-Forte résistance

Idéale pour scellage des raccords filetés qui ne doivent pas être démontés.

Pour l'application sur les surfaces métalliques passivées telles que le cuivre, l'aluminium, l'acier inox etc.
Ne permet pas le démontage avec outils manuels.



Température (°C)	-50/+200
Jeu diamétral (mm)	0,15
Vitesse de réaction blocage manuel (minutes)	10/15
Durcissement fonctionnel (heures)	3-6
Viscosité (mPa.s) 25°C	40.000/80.000
Couple de dévissage INITIAL ISO-10964	35-45 Nm
Couple de dévissage RESIDUEL ISO-10964	25-35 Nm

ml	CHF		
20 Flaçon	13.20	12	098130002
50 Flaçon à soufflet	23.10	6	098130305
50 Tube	21.60	4	098130505
250 Tube	53.50	4	098130525
20 Flaçon		12	098132002
50 Flaçon à soufflet		6	098132305
50 Tube		4	098132505
250 Tube		4	098132525

9812M

scellant à filet-Moyenne résistance

Idéale pour scellage des raccords filetés et parties soumises à maintenance périodique.
Permet le démontage avec des outils manuels.



Température (°C)	-50/+150
Jeu diamétral (mm)	0,35
Vitesse de réaction blocage manuel (minutes)	12/18
Durcissement fonctionnel (heures)	3-6
Viscosité (mPa.s) 25°C	20.000/40.000
Couple de dévissage INITIAL ISO-10964	27-35 Nm
Couple de dévissage RESIDUEL ISO-10964	20-30 Nm

ml	CHF		
20 Flaçon	13.20	12	098120002
50 Flaçon à soufflet	23.10	6	098120305
50 Tube	21.60	4	098120505
250 Tube	53.50	4	098120525
20 Flaçon		12	098122002
50 Flaçon à soufflet		6	098122305
50 Tube		4	098122505
250 Tube		4	098122525

9811L

scellant à filet-Basse résistance

Idéal pour sceller les joints de petite taille ou à pas fin.
Démontage des pièces facilité



Température (°C)	-50/+150
Jeu diamétral (mm)	0,20
Vitesse de réaction blocage manuel (minutes)	10/15
Durcissement fonctionnel (heures)	3-6
Viscosité (mPa.s) 25°C	10.000/20.000
Couple de dévissage INITIAL ISO-10964	6-10 Nm
Couple de dévissage RESIDUEL ISO-10964	4-8 Nm

ml	CHF		
20 Flaçon	13.20	12	098110002
50 Flaçon à soufflet	23.10	6	098110305
50 Tube	21.60	4	098110505
250 Tube	53.50	4	098110525
20 Flaçon		12	098112002
50 Flaçon à soufflet		6	098112305
50 Tube		4	098112505
250 Tube		4	098112525

9823H

joint liquide-Forte résistance

Idéal pour sceller les surfaces de manière permanente.
Idéale également pour reconstruire les sièges de roulements
ou les pièces usées.

Ne permet pas le démontage avec outils manuels.



Température (°C)	-50/+150
Jeu diamétral (mm)	0,35
Vitesse de réaction blocage manuel (minutes)	10/16
Durcissement fonctionnel (heures)	3-6
Viscosité (mPa.s) 25°C	100.000/200.000
Couple de dévissage INITIAL ISO-10964	35-45 Nm
Couple de dévissage RESIDUEL ISO-10964	20-30 Nm

ml		CHF		
20	Flacon	13.20	12	098230002
50	Flacon à soufflet	23.10	6	098230305
50	Tube	21.60	4	098230505
250	Tube	53.50	4	098230525
20	Flacon		12	098232002
50	Flacon à soufflet		6	098232305
50	Tube		4	098232505
250	Tube		4	098232525

9822M

joint liquide-Moyenne résistance

Idéal pour sceller les parties soumises à maintenance
périodique.

Permet le démontage avec des outils manuels.



Température (°C)	-50/+150
Jeu diamétral (mm)	0,35
Vitesse de réaction blocage manuel (minutes)	10/15
Durcissement fonctionnel (heures)	3-6
Viscosité (mPa.s) 25°C	40.000/70.000
Couple de dévissage INITIAL ISO-10964	25-35 Nm
Couple de dévissage RESIDUEL ISO-10964	20-30 Nm

ml		CHF		
20	Flacon	13.20	12	098220002
50	Flacon à soufflet	23.10	6	098220305
50	Tube	21.60	4	098220505
250	Tube	53.50	4	098220525
20	Flacon		12	098222002
50	Flacon à soufflet		6	098222305
50	Tube		4	098222505
250	Tube		4	098222525

9821L

joint liquide-Basse résistance

Idéal pour sceller les surfaces des parties soumises à
maintenance périodique.

Tolère la légère contamination d'huiles.

Protège les filetages de corrosion et grippages de corrosion.

Démontage des pièces facilité.



Température (°C)	-50/+150
Jeu diamétral (mm)	0,35
Vitesse de réaction blocage manuel (minutes)	20/30
Durcissement fonctionnel (heures)	3-6
Viscosité (mPa.s) 25°C	60.000/90.000
Couple de dévissage INITIAL ISO-10964	7-11 Nm
Couple de dévissage RESIDUEL ISO-10964	4-9 Nm

ml		CHF		
20	Flacon	13.20	12	098210002
50	Flacon à soufflet	23.10	6	098210305
50	Tube	21.60	4	098210505
250	Tube	53.50	4	098210525
20	Flacon		12	098212002
50	Flacon à soufflet		6	098212305
50	Tube		4	098212505
250	Tube		4	098212525

9833H

bloquant-Forte résistance

Idéal pour fixer tous les pièces qui ne doivent pas être
démontées.

Adapté pour bloquer les dispositifs déjà installés où le
démontage est difficile.

Ne permet pas le démontage avec outils manuels.



Température (°C)	-50/+180
Jeu diamétral (mm)	0,15
Vitesse de réaction blocage manuel (minutes)	10/15
Durcissement fonctionnel (heures)	3-6
Viscosité (mPa.s) 25°C	400/700
Couple de dévissage INITIAL ISO-10964	35-45 Nm
Couple de dévissage RESIDUEL ISO-10964	30-40 Nm

ml		CHF		
20	Flacon	13.90	12	098330002
50	Flacon	21.60	4	098330005
250	Flacon	55.00	4	098330025
20	Flacon		12	098332002
50	Flacon		4	098332005
250	Flacon		4	098332025

9832M

bloquant-Moyenne résistance

Idéal pour fixer les parties soumises à maintenance
périodique.

Permet le démontage avec des outils manuels.



Température (°C)	-50/+180
Jeu diamétral (mm)	0,25
Vitesse de réaction blocage manuel (minutes)	12/20
Durcissement fonctionnel (heures)	3-6
Viscosité (mPa.s) 25°C	2000/4000
Couple de dévissage INITIAL ISO-10964	25-35 Nm
Couple de dévissage RESIDUEL ISO-10964	18-28 Nm

ml		CHF		
20	Flacon	13.90	12	098320002
50	Flacon	21.60	4	098320005
250	Flacon	55.00	4	098320025
20	Flacon		12	098322002
50	Flacon		4	098322005
250	Flacon		4	098322025

9831L

bloquant-Basse résistance

Idéal pour fixer les pièces de petite taille soumises à
maintenance périodique et de petites dimensions.

Démontage des pièces facilité.



Température (°C)	-50/+150
Jeu diamétral (mm)	0,10
Vitesse de réaction blocage manuel (minutes)	10/15
Durcissement fonctionnel (heures)	3-6
Viscosité (mPa.s) 25°C	500/800
Couple de dévissage INITIAL ISO-10964	6-10 Nm
Couple de dévissage RESIDUEL ISO-10964	4-8 Nm

ml		CHF		
20	Flacon	13.90	12	098310002
50	Flacon	21.60	4	098310005
250	Flacon	55.00	4	098310025
20	Flacon		12	098312002
50	Flacon		4	098312005
250	Flacon		4	098312025



9841N

Mastic silicone noir , résistant aux hautes températures,
avec distributeur pratique

Résiste à des températures jusqu'à 240 ° C

Permet une étanchéité élastique permanente. Remplace les joints préformés.

Le distributeur permet un étalement facile, précis et uniforme du produit.

Polymérise en réagissant avec l'humidité atmosphérique et forme un joint élastique et durable.

Idéal pour les carter d'huile, les pompes à huile, les carters, les boîtes de vitesses, les pièces de moteur qui ne sont pas soumises à une pression élevée et les applications qui nécessitent une résistance à des températures élevées.

Adhère aux surfaces non poreuses, y compris le verre, le bois revêtu, la céramique et l'émail. Ne convient pas aux revêtements PE, PP, PC, PMMA, PTFE, plastiques souples, néoprène et bitumineux.

Ne peut pas être peint.



ml	CHF		
200	34.50	12	098410120
200		12	098412120

9841R

Mastic silicone rouge, résistant aux hautes températures,
avec distributeur pratique

Résiste à des températures jusqu'à 300 ° C.

Permet une étanchéité élastique permanente. Remplace les joints préformés.

Le distributeur permet un étalement facile, précis et uniforme du produit.

Polymérise en réagissant avec l'humidité atmosphérique et forme un joint élastique et durable.

Idéal pour les portes, les plaques, les systèmes de chauffage, les sorties, les thermostats, les pompes, les tuyaux de chauffage, les pièces de moteur qui ne sont pas soumis à une pression élevée et les applications qui nécessitent une

résistance à des températures élevées. Adhère aux supports non poreux, y compris le verre, le bois revêtu, la céramique et l'émail. Ne convient pas aux supports PE, PP, PC, PMMA,

PTFE, plastiques souples, néoprène et bitumineux.

Ne peut pas être peint.



ml	CHF		
200	33.00	12	098410020
200		12	098412020

9851

colle instantanée
pour joints structuraux

à base de cyanoacrylate d'éthyle

pour l'adhérence d'une large gamme de matériaux, y compris le métal, les plastiques,

cuir, bois et plusieurs autres types de substrats, qu'ils soient combinés entre eux ou séparés;

se lie rapidement.



Temperature (°C)	
-55/+82	
Viscosité (mPa.s) 25 °C	
80-120	

g		CHF		
5	Tube	7.15	12	098510500
20	Flacon	13.90	12	098510002
50	Flacon	27.00	10	098510005
5	Tube		12	098512500
20	Flacon		12	098512002
50	Flacon		10	098512005

9710 - LUBRIBETA universal

débloquant multiusage 7 fonctions en 1 seul produit

1. Débloquant;
2. Lubrifiant;
3. Détergent, dégraissant;
4. Protecteur anti-rouille;
5. Désoxydant pour contacts électriques;
6. Hydrofuge;
7. Antigél.

Ne contient pas de silicone.



ml	CHF		
400	11.70	12	097100040
400		12	097101040
400		12	097102040



9712 - Ultra Sblock

débloquant, super-pénétrant

Débloquant, désoxydant et hydrofuge.

Idéal pour dissoudre la rouille sur les écrous, les boulons, les vis et les engrenages.



ml	CHF		
400	8.05	12	097120040
400		12	097121040
400		12	097122040

9720 - Multi Grease

graisse multiusage

Particulièrement indiqué pour la lubrification de chaînes, engrenages et pièces métalliques en mouvement.

Résiste aux frottements et aux agents atmosphériques.

Haute adhésif. Ne coule pas.



ml	CHF		
400	9.50	12	097200040
400		12	097201040
400		12	097202040

9722 - Lithium Grease

graisse blanche au lithium

À base de graisses savonneuses de lithium, titane et oxydes de zinc.

Idéal pour engrenages, roulements et raccords.

Spécifique pour applications marines.

Fortement résistant à l'eau, à l'air salin, aux agents atmosphériques et à hautes températures (jusqu'à 150 °C).

Ne coule pas.



ml	CHF		
400	11.00	12	097220040
400		12	097221040
400		12	097222040

9724 - PTFE Grease

graisse à base de P.T.F.E.

Particulièrement indiqué pour la lubrification des chaînes industrielles et les mouvements mécaniques à fortes pressions et rotations non élevées.
Adapté aux applications sur plastique et caoutchouc.
Complètement incolore. Hydrofuge et résistant à l'oxydation.



ml	CHF		
400	12.50	12	097240040
400		12	097241040
400		12	097242040

9726 - Copper Grease

graisse au cuivre

Pour la lubrification de raccords, boulons, engrenages, arbres moteur et autres pièces métalliques sujettes à hautes températures (jusqu'à 1.000 °C).
Protecteur, anti-usure.
Prévient l'oxydation. Ne coule pas.



ml	CHF		
400	14.80	12	097260040
400		12	097261040
400		12	097262040

9729 - Silic Spray

silicone spray

Adapté à la lubrification des pièces en plastiques, caoutchouc et métaux.
Protège de la corrosion. Antiadhérent.
Antistatique. Hydrofuge.
Polissant pour bois, plastique et caoutchouc.
Ne contient pas de solvants.



ml	CHF		
400	8.50	12	097290040
400		12	097291040
400		12	097292040

9738 - Cutting Oil

Huile de coupe

À haut pouvoir lubrifiant et protecteur.
Indiqué pour fraisage, alésage, filetage, perçage, et usinages pour machines automatiques.
Haute résistance à l'oxydation.
Lavable à l'eau. Sans solvants.



ml	CHF		
400	9.25	12	097380040
400		12	097381040
400		12	097382040

9740 - Brake Cleaner

nettoyant pour freins

Idéal pour le nettoyage des disques et des pastilles de freins, des moteurs.
Élimine la graisse et le goudron sans laisser de résidus.
À évaporation rapide.
N'attaque pas le caoutchouc et le plastique.



ml	CHF		
500	8.30	12	097400050
500		12	097401050
500		12	097402050

9741 - Multi Cleaner

Détergent, dégraissant multifonctions

Détergent et dégraissant pour dissoudre le gras, l'huile, le goudron, le silicone et la colle.
Recommandé pour le nettoyage des surfaces en métal, plastique rigide, céramique, acier et aluminium.
Ne laisse pas de résidus huileux.



ml	CHF		
400	9.10	12	097410040
400		12	097411040
400		12	097412040

9742 - Contact Cleaner

nettoyant pour contacts électriques et électroniques

Élimine le gras et la saleté sans laisser de résidus huileux.
À évaporation rapide.
N'attaque pas le plastique et le caoutchouc.



ml	CHF		
400	8.75	12	097420040
400		12	097421040
400		12	097422040

9743 - SURFACE CLEANER

Nettoyant antibactérien moussant

Produit de nettoyage antibactérien moussant, idéal pour tous les types de surfaces, d'outils et de tissus.
À base de sels d'ammonium quaternaire, il crée une mousse active qui nettoie et élimine la saleté et la graisse.
Élimine les mauvaises odeurs. Ne nécessite aucun rinçage n'est pas un désinfectant



ml	CHF		
500	17.60	12	097430050
500		12	097431050
500		12	097432050

9745 - Carb Cleaner

nettoyant pour carburateurs et corps à papillon

Spécifique pour le nettoyage interne et externe de carburateurs, conduits d'aspiration et corps papillon.
Élimine complètement les résidus carbonés, les dépôts et les impuretés.
Ne laisse pas de résidus huileux.



ml	CHF		
400	9.25	12	097450040
400		12	097451040
400		12	097452040

9746 - Clima Cleaner

nettoyant pour climatisation

Nettoyant pour climatiseurs industriels, civils et automobiles. Grâce à sa formulation en mousse épaisse et à la paillette qui l'accompagne, il permet d'éliminer la saleté, les dépôts et les odeurs des conduits tout en laissant un parfum agréable.



ml	CHF		
400	15.30	12	097460040
400		12	097461040
400		12	097462040

9749 - Air Spray

Spray d'air

Spray aérosol de gaz comprimé. Idéal pour éliminer les dépôts de poussière des fissures, équipements, pièces électriques, claviers et mécanismes délicats. La bombe aérosol avec paillette permet d'atteindre facilement les parties difficilement accessibles.



ml	CHF		
400	9.75	12	097490040
400		12	097491040
400		12	097492040

9752 - Zinc 98%

zinc clair

À haut pouvoir couvrant, idéal pour galvaniser les pièces en fer.

Fortement adhésif, forme un film élastique de couleur très claire, semblable à la galvanisation à chaud.

Particulièrement résistant à l'oxydation, à l'abrasion et aux agents atmosphériques.

Peut être surverni. Ne coule pas.



ml	CHF		
400	10.60	12	097520040
400		12	097521040
400		12	097522040

9755 - Welding Spray

anti-adhérent soudure

Spray anti-adhérent soudure sans silicone. Il empêche l'adhérence, rendant ainsi le soudage plus facile et plus rapide. Pour une utilisation sur des pièces à souder et comme protecteur pour les buses de torche de soudage. Il permet d'effectuer des opérations ultérieures, par ex. peinture, galvanisation et chromage. Pas de fumées. Facile à retirer. Sans chlore.



ml	CHF		
400	9.60	12	097550040
400		12	097551040
400		12	097552040

9765 - Deicer Spray

Dégivrant

Spray dégivrant et dégivreur, pour enlever la glace et le givre des fenêtres. Idéal également pour les serrures et mécanismes gelés. Efficace jusqu'à -40 ° C. Non gras, sans frottais. N'affecte pas les surfaces traitées, le caoutchouc et les plastiques.



ml	CHF		
400	16.00	12	097650040
400		12	097651040
400		12	097652040

9775 - Water Stop

Imperméabilisant pour tissus

Spray imperméabilisant et déperlant pour textiles et cuir. Idéal pour les chaussures, les vestes et les vêtements en général. Il permet aux tissus d'être imperméabilisés, sans affecter la respirabilité. En raison de ses propriétés de résistance aux taches, les tissus sont plus faciles à laver. Meilleure résistance à la flexion et à l'abrasion.



ml	CHF		
400	17.20	12	097750040
400		12	097751040
400		12	097752040

9881U

Détergent industriel alcalin pour cuve à ultrasons

Détergent industriel alcalin, concentré, à base d'eau. Pour nettoyage à ultrasons et autres processus de purification.

Permet un nettoyage minutieux et efficace des pièces de rechange et des pièces métalliques en général (injecteurs, carburateurs, vannes etc.).

Élimine les huiles, les graisses, les lubrifiants, les résidus de colle, de résines, de cires. Également adapté au nettoyage de pièces en aluminium.



Lt	CHF		
1	44.50	1	098810010
1		1	098812010

9882R

Liquide détachant sélectif de rouille

Liquide détachant sélectif de rouille à base d'eau pour fer, acier, acier inox, fonte et chromages.

Élimine la couche oxydée sans endommager le substrat métallique.

Dilution : de pur à max. 1:1.

Température minimale d'utilisation : 15 °C.

Durée d'utilisation : 30' - 24/48h (pour rouille résistante).

Biodégradable et 100 % hydrosoluble.



Lt	CHF		
1	54.00	1	098820010
1		1	098822010



Une gamme complète d'abrasifs rigides et flexibles comprenant plus de 500 références entièrement produites en Italie. Conçue et développée pour répondre à toutes les exigences industrielles et professionnelles de coupe et d'élimination de matériau.

Avec le projet Beta Abrasives, Beta Utensili affirme sa volonté de proposer une gamme de produits complète et un service technique absolu aux professionnels du marché, garantis par les compétences de production mises à disposition par AbraBeta.

DISQUES RIGIDES À TRONÇONNER ET D'ÉBAVURAGE



Les disques rigides représentent la principale catégorie de cette nouvelle famille de produits ; pour cette raison, Beta Utensili a accordé la plus grande attention au choix des matériaux utilisés et aux typologies adoptées.

Les disques à tronçonner et d'ébavurage sont les instruments les plus rapides et polyvalents pour l'usinage d'une grande variété de matériaux avec les outils les plus indiqués, qu'il s'agisse de meuleuses à renvoi d'angle ou de machines stationnaires.

DISC SHAPES

 **T42**

disque à tronçonner à moyeu déporté

 **T41**

disque à tronçonner à moyeu plat

 **T27**

disque d'ébavurage à moyeu déporté

TOP
— LINE —

La qualité sans conditions : destinées à des utilisateurs extrêmement exigeants

PREMIUM
— LINE —

Haute qualité pour grandes prestations, avec un prix compétitif pour le meilleur rapport qualité/prix.

CERTIFICATION



PICTOGRAMMES présents sur les disques



Utiliser des lunettes de protection



Utiliser des gants de protection



Utiliser un casque antibruit



Utiliser des vêtements de protection



Utiliser un masque de protection contre la poussière



Consulter le manuel d'instructions



Disque seulement pour le tronçonnage – non adapté à l'ébavurage



Ne pas utiliser le disque s'il est abîmé



Sans fer, soufre ni chlore ($\leq 0,1\%$)

Validité du produit

La validité des disques est de 3 ans à compter de la date de fabrication. L'expression "V01" gravée sur la rondelle métallique au centre du disque indique le trimestre d'expiration. Exemple : l'inscription "V07/2022" indique que le disque a été fabriqué au cours du 3ème trimestre 2019 et peut être utilisé jusqu'à la fin du 3ème trimestre 2022.



V01	Jan-Mar
V04	Avr-Jui
V07	Jui-Sep
V10	Oct-Déc



MEULES SUR TIGE

Meules sur tige pour utilisation avec meuleuses droites. Réalisées en différentes formes pour s'adapter aux différents usinages et avec trois typologies d'abrasif.



ROUES SUR TIGE

Les roues à lamelles sur tige sont fabriquées avec des lamelles flexibles pour obtenir des finitions précises et homogènes sur des formes et des surfaces irrégulières.



DISQUES À LAMELLES

Les disques à lamelles sont composés de lamelles de toile abrasive collées à un support ; ils représentent le choix parfait pour les opérations de dégrossissage et de finition. Par rapport aux disques d'ébavurage, ils garantissent une élimination plus rapide, une finition plus homogène, réduisent les vibrations, le bruit et permettent de travailler à des températures inférieures. Ils sont disponibles avec des toiles de différents matériaux abrasifs avec plusieurs granulométries et deux types de support.

Exécutions



Profil plat

à utiliser avec un angle maximal de 15° par rapport au plan de travail et permet le travail sur surfaces plates et saillies.

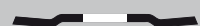

Profil conique

Simplifie les opérations sur les surfaces irrégulières et s'utilise avec un angle compris entre 15° et 25° par rapport au plan de travail. Garantit une plus grande surface de contact entre le disque et la surface de travail. Les lamelles peuvent être utilisées jusqu'à leur usure complète.

TOP

— LINE —

La qualité sans conditions : destinées à des utilisateurs extrêmement exigeants.

PREMIUM

— LINE —

Haute qualité pour grandes prestations, avec un prix compétitif pour le meilleur rapport qualité/prix.



ROUES AVEC ALÉSAGE

Les roues à lamelles sur bride sont des produits aptes à l'usinage de bords, contours et surfaces irrégulières grâce à la grande flexibilité des lamelles.



ROUES POUR SATINEUSES

Les roues (ou rouleaux) pour satineuses Beta représentent la solution idéale pour la finition de tout matériau.

Degrés de grain/finition

C	Grossier
M	Moyen
F	Fin
VF	Très fin
UF	Ultra fin



DISQUES ABRASIFS ET DISQUES FIBRES

Disques spéciaux non-tissés avec grande capacité de polissage qui permettent des usinages rapides et précises.



ROULEAUX

Vaste gamme de rouleaux de toile et papier abrasif et non-tissés, d'excellente qualité pour toutes les utilisations.

Pour toute autre information, veuillez consulter le catalogue en ligne sur le site de Beta Utensili : www.beta-tools.com

11001

Disques à tronçonner à moyeu déporté pour l'acier Performance élevée et bonne durée de vie

A30S EN 12413



	Ø mm	S mm	F mm	max. rpm	CHF		
11001	115	3,2	22,23	13300	2.32	10	110010118
11001	125	3,2	22,23	12200	2.46	10	110010128
11001	230	3,2	22,23	6600	5.35	10	110010233

11001H

Disques à tronçonner à moyeu déporté pour l'acier Performance élevée et bonne durée de vie

HARD

A30T EN 12413



	Ø mm	S mm	F mm	max. rpm	CHF		
11001H	230	3,2	22,23	6600	5.35	10	110010733

11003

Disques à tronçonner plat pour l'acier Performance élevée et bonne durée de vie

A30T EN 12413



	Ø mm	S mm	F mm	max. rpm	CHF		
11003	115	2,5	22,23	13300	2.19	10	110030117
11003	125	2,5	22,23	12200	2.19	10	110030127
11003	180	2,5	22,23	8500	4.55	10	110030182
11003	230	2,5	22,23	6600	5.05	10	110030232

11011

Disques à ébarber pour l'acier à moyeu déporté Enlèvement de matière élevé

A24N EN 12413



	Ø mm	S mm	F mm	max. rpm	CHF		
11011	115	6,5	22,23	13300	3.15	10	110110115
11011	125	6,5	22,23	12200	3.40	10	110110125
11011	180	6,5	22,23	8500	6.60	10	110110180
11011	230	6,5	22,23	6600	9.80	10	110110230

11011H

Disques à ébarber pour l'acier à moyeu déporté Enlèvement de matière élevé et bonne durée de vie

HARD

A24R EN 12413



	Ø mm	S mm	F mm	max. rpm	CHF		
11011H	115	6,5	22,23	13300	3.15	10	110110615
11011H	125	6,5	22,23	12200	3.40	10	110110625
11011H	180	6,5	22,23	8500	6.60	10	110110680
11011H	230	6,5	22,23	6600	9.80	10	110110730

11018

Disques Stationnaire à tronçonner plat pour l'acier

60 m/s

A46N EN 12413



	Ø mm	S mm	F mm	max. rpm	CHF		
11018	300	2,5	25,40	4010	8.75	10	110180030
11018	350	3,0	25,40	3440	13.60	10	110180035
11018	400	3,2	25,40	3010	17.40	10	110180040

11019

Disques Stationnaire à tronçonner plat pour l'acier

80 m/s

A24N EN 12413



A24N



	Ø mm	S mm	F mm	max. rpm	CHF		
11019	300	3,8	25,40	5100	10.70	10	110190030
11019	350	4,2	25,40	4400	16.10	10	110190035
11019	400	4,5	25,40	3800	20.80	10	110190040

11021

Disques à tronçonner à moyeu déporté pour l'acier et l'inco Performance élevée et bonne durée de vie

A30Q EN 12413



A30Q



	Ø mm	S mm	F mm	max. rpm	CHF		
11021	115	3,2	22,23	13300	2.32	10	110210118
11021	125	3,2	22,23	12200	2.46	10	110210128
11021	180	3,2	22,23	8500	4.65	10	110210183
11021	230	3,2	22,23	6600	5.35	10	110210233

11023

Disques à ébarber pour l'acier et l'inco à moyeu déporté Enlèvement de matière élevé

A24Q EN 12413



A24Q



	Ø mm	S mm	F mm	max. rpm	CHF		
11023	115	6,5	22,23	13300	3.15	10	110230115
11023	125	6,5	22,23	12200	3.40	10	110230125
11023	230	6,5	22,23	6600	9.80	10	110230230

11024

Disques à tronçonner épaisseur fine, à moyeu déporté pour l'acier et l'inco Performance élevée et bonne durée de vie

TOP LINE

A46U EN 12413



TOP
LINE

A46U



	Ø mm	S mm	F mm	max. rpm	CHF		
11024	230	2,0	22,23	6600	6.60	10	110240230

11031÷11038

Disques à tronçonner épaisseur fine, à moyeu plat pour l'acier et l'inco Haute performance et très longue durée de vie

TOP LINE

Ø 65 mm

A46U EN 12413



TOP
LINE

A46U



	Ø mm	S mm	F mm	max. rpm	CHF		
11031	65	1,0	6,00	24000	2.05	25	110310006
11031	65	1,0	10,00	24000	2.05	25	110310010
11031	65	1,6	10,00	24000	2.05	25	110310020

	Ø mm	S mm	F mm	max. rpm	CHF		
11032	76	1,0	6,00	20200	2.05	25	110320006
11032	76	1,0	10,00	20200	2.05	25	110320010
11032	76	1,6	10,00	20200	2.05	25	110320020

	Ø mm	S mm	F mm	max. rpm	CHF		
11034	115	1,0	22,23	13300	3.00	25	110340022
11034	115	1,2	22,23	13300	3.00	25	110340042
11034	115	1,6	22,23	13300	3.00	25	110340062

	Ø mm	S mm	F mm	max. rpm	CHF		
11035	125	1,0	22,23	12200	3.30	25	110350022
11035	125	1,2	22,23	12200	3.30	25	110350042
11035	125	1,6	22,23	12200	3.30	25	110350062

	Ø mm	S mm	F mm	max. rpm	CHF		
11037	180	2,0	22,23	8500	5.35	10	110370022

	Ø mm	S mm	F mm	max. rpm	CHF		
11038	230	2,0	22,23	6600	6.15	10	110380022

11040

Disques à tronçonner épaisseur fine, à moyeu déporté pour l'acier et l'inox Haute performance et très longue durée de vie

PREMIUM LINE

A36Q EN 12413



A36Q



	Ø mm	S mm	F mm	max. rpm	CHF		
11040	230	2,0	22,23	6600	5.05	10	110400230

11045-11046

Disques à tronçonner épaisseur fine, à moyeu plat pour l'acier et l'inox Performance élevée et très bonne durée de vie

PREMIUM LINE

Ø 115 mm

A46Q EN 12413



A46Q

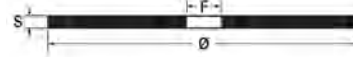

	Ø mm	S mm	F mm	max. rpm	CHF		
11045	115	1,0	22,23	13300	2.32	25	110450010
11045	115	1,2	22,23	13300	2.32	25	110450012
11045	115	1,6	22,23	13300	2.32	25	110450016

	Ø mm	S mm	F mm	max. rpm	CHF		
11046	125	1,0	22,23	12200	2.46	25	110460010
11046	125	1,2	22,23	12200	2.46	25	110460012
11046	125	1,6	22,23	12200	2.46	25	110460016

11048-11049

Disques à tronçonner épaisseur fine, à moyeu plat pour l'acier et l'inox Performance élevée et très bonne durée de vie

Ø 180 mm

A36Q EN 12413



A36Q



	Ø mm	S mm	F mm	max. rpm	CHF		
11048	180	2,0	22,23	8500	3.55	10	110480019

	Ø mm	S mm	F mm	max. rpm	CHF		
11049	230	2,0	22,23	6600	4.80	10	110490019

11050

Disques à ébarber en corindon zirconium Très haut enlèvement de matière et très bonne durée de vie

ZA24R - EN 12413



ZA24R



	Ø mm	S mm	F mm	max. rpm	CHF		
11050	115	6,5	22,23	13300	5.35	10	110500115
11050	125	6,5	22,23	12200	6.40	10	110500125
11050	230	7,0	22,23	6600	16.10	10	110500230

11069

Disques à tronçonner à moyeu déporté pour matériaux de construction, béton, marbre

C30S EN 12413



C30S

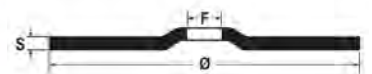

	Ø mm	S mm	F mm	max. rpm	CHF		
11069	115	3,2	22,23	13300	2.46	10	110690115
11069	125	3,2	22,23	12200	2.60	10	110690125
11069	230	3,2	22,23	6600	5.70	10	110690230

Beta

11100

Meule forme cylindrique sur tige au corindon rose avec liant céramique

tige Ø 3 x 37 mm

EN 12413

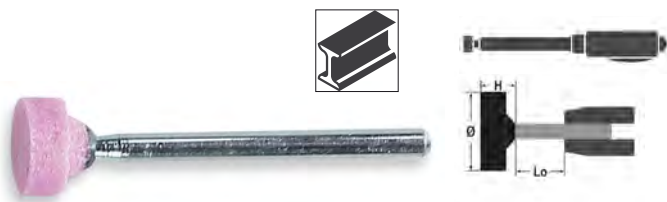

	Ø mm	h mm	max. rpm Lo=13 mm		CHF		
11100	4	8	130.000	AR60P5V	1.33	25	111000004
11100	6	10	93.100	AR60P5V	1.33	25	111000006
11100	8	12	64.500	AR60P5V	1.33	25	111000008
11100	10	10	60.100	AR60P5V	1.33	25	111000011
11100	10	12	52.700	AR60P5V	1.33	25	111000012
11100	12	15	37.300	AR60P5V	1.47	25	111000013

11101

Meule forme cylindrique sur tige au corindon rose avec liant céramique

tige Ø 6 x 40 mm

EN 12413

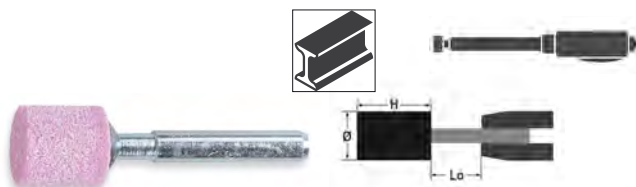

	Ø mm	h mm	max. rpm Lo=13 mm		CHF		
11101	4	8	130.000	AR60P5V	1.55	25	111010004
11101	5	10	130.000	AR60P5V	1.55	25	111010005
11101	6	10	130.000	AR60P5V	1.55	25	111010006
11101	8	10	119.300	AR60P5V	1.55	25	111010008
11101	10	10	95.400	AR60P5V	1.55	25	111010010
11101	10	15	95.400	AR60P5V	1.55	25	111010011
11101	10	20	86.600	AR60P5V	1.69	25	111010012
11101	10	25	72.700	AR60P5V	1.88	25	111010013
11101	10	32	58.700	AR60P5V	1.96	25	111010014
11101	12	10	79.500	AR60P5V	1.44	25	111010015
11101	12	15	79.500	AR60P5V	1.47	25	111010016
11101	12	20	79.500	AR60P5V	1.60	25	111010017
11101	15	3	63.600	AR60P5V	1.44	25	111010018
11101	15	15	63.600	AR60P5V	1.55	25	111010019
11101	16	20	59.600	AR46P5V	1.75	25	111010020
11101	16	25	56.900	AR46P5V	1.88	25	111010021
11101	16	32	45.100	AR46P5V	2.10	25	111010022
11101	20	4	47.700	AR60P5V	1.44	25	111010023
11101	20	15	47.700	AR46P5V	1.55	25	111010024
11101	20	20	47.700	AR46P5V	1.88	25	111010025
11101	20	25	46.100	AR46P5V	1.96	25	111010026
11101	20	30	38.900	AR46P5V	2.16	25	111010027
11101	20	40	29.000	AR46P5V	2.71	25	111010028
11101	25	10	38.100	AR60P5V	1.55	25	111010030
11101	25	25	37.200	AR36/46P5V	2.16	25	111010031
11101	25	40	23.300	AR36/46P5V	3.15	10	111010032
11101	30	10	31.800	AR60P5V	1.75	25	111010034
11101	30	30	26.200	AR36/46P5V	2.58	25	111010035
11101	30	40	19.500	AR36/46P5V	3.45	10	111010036
11101	32	20	29.800	AR36P5V	2.42	25	111010037
11101	32	32	23.100	AR36P5V	3.30	10	111010038
11101	40	10	23.800	AR36/46P5V	2.58	25	111010041
11101	40	20	23.800	AR36P5V	3.45	10	111010042
11101	40	25	23.400	AR36P5V	3.60	10	111010043
11101	40	30	19.700	AR36P5V	3.95	10	111010044
11101	40	40	14.700	AR36P5V	4.80	10	111010045
11101	50	15	19.000	AR36P5V	3.85	10	111010051
11101	50	25	18.800	AR36P5V	4.60	10	111010052
11101	60	10	15.900	AR36P5V	4.20	10	111010060

11102

Meule forme cylindrique sur tige au corindon rose avec liant céramique

tige Ø 6 x 80 mm

EN 12413

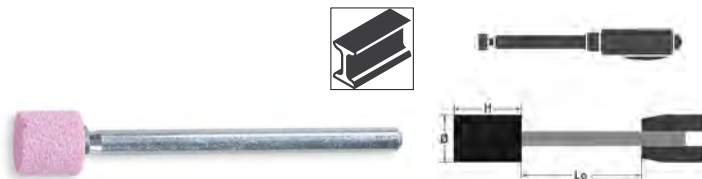

	Ø mm	h mm	max. rpm Lo=13 mm		CHF		
11102	8	20	100.500	AR60P5V	2.03	25	111020008
11102	10	15	95.400	AR60P5V	1.91	25	111020010
11102	10	30	62.200	AR60P5V	2.34	25	111020020
11102	12	15	79.500	AR60P5V	1.96	25	111020022
11102	15	15	63.600	AR60P5V	2.10	25	111020035
11102	15	30	51.000	AR46P5V	2.62	25	111020040
11102	20	30	38.900	AR46P5V	2.65	25	111020060

11105

Meule forme spéciale cylindrique triangulaire sur tige au corindon rose avec liant céramique

tige Ø 6 x 40 mm

EN 12413



	Ø mm	h mm	max. rpm Lo=13 mm		CHF		
11105	20	65	16.200	AR36/46P5V	5.05	25	111050020

11106

Meule forme trapézoïdale sur tige au corindon rose avec liant céramique

tige Ø 3 x 37 mm

EN 12413

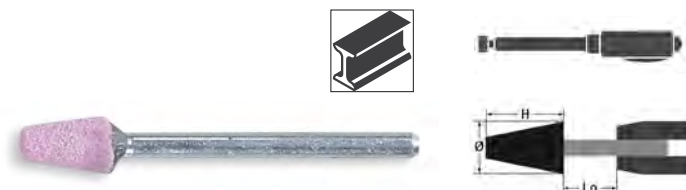

	Ø mm	h mm	max. rpm Lo=13 mm		CHF		
11106	6	10	93.100	AR60P5V	1.75	25	111060006

11107

Meule forme trapézoïdale sur tige au corindon rose avec liant céramique

tige Ø 6 x 40 mm

EN 12413

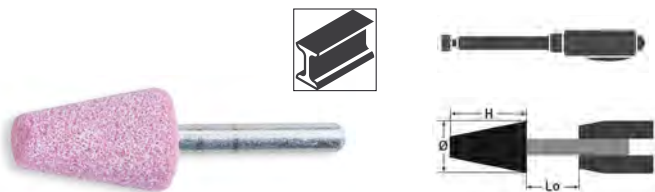

	Ø mm	h mm	max. rpm Lo=13 mm		CHF		
11107	12	20	79.500	AR60P5V	1.96	25	111070012
11107	15	25	60.400	AR46P5V	2.34	25	111070015
11107	20	30	38.900	AR46P5V	2.71	25	111070020
11107	25	40	23.300	AR36/46P5V	3.95	10	111070025

11110

Meule forme conique bout arrondi sur tige au corindon rose avec liant céramique

tige Ø 3 x 37 mm

EN 12413

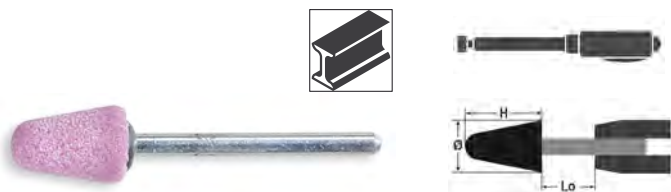

	Ø mm	h mm	max. rpm Lo=13 mm		CHF		
11110	10	15	44.300	AR60P5V	1.75	25	111100010

11111

Meule forme conique bout arrondi sur tige au corindon rose avec liant céramique

tige Ø 6 x 40 mm

EN 12413

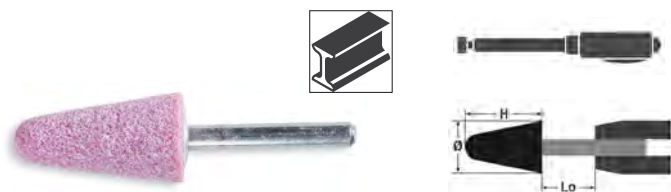

	Ø mm	h mm	max. rpm Lo=13 mm		CHF		
11111	10	20	86.600	AR60P5V	2.03	25	111110010
11111	15	30	51.000	AR46P5V	2.65	25	111110015
11111	16	45	31.400	AR46P5V	3.60	25	111110016
11111	20	28	41.500	AR46P5V	2.71	25	111110020
11111	20	40	29.000	AR46P5V	3.45	25	111110021
11111	30	50	15.100	AR36/46P5V	5.05	10	111110030

11115

Meule forme ogive sur tige au corindon rose avec liant céramique

tige Ø 3 x 37 mm

EN 12413

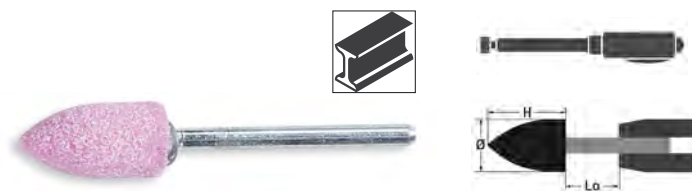

	Ø mm	h mm	max. rpm Lo=13 mm		CHF		
11115	10	20	34.700	AR60P5V	1.88	25	111150010

11116

Meule forme ogive sur tige au corindon rose avec liant céramique

tige Ø 6 x 40 mm

EN 12413

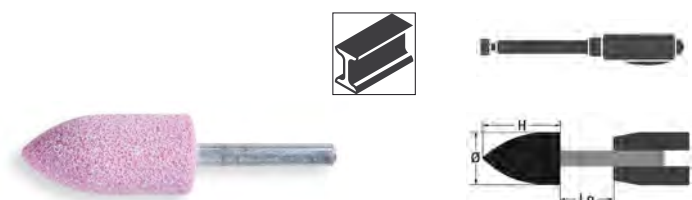

	Ø mm	h mm	max. rpm Lo=13 mm		CHF		
11116	10	20	86.600	AR60P5V	2.03	25	111160010
11116	18	30	43.000	AR46P5V	2.71	25	111160018
11116	20	50	22.500	AR36/46P5V	4.20	25	111160020
11116	22	70	13.400	AR36/46P5V	6.40	10	111160022

11120

Meule forme spéciale cylindrique pyramidale sur tige au corindon rose avec liant céramique

tige Ø 3 x 37 mm

EN 12413

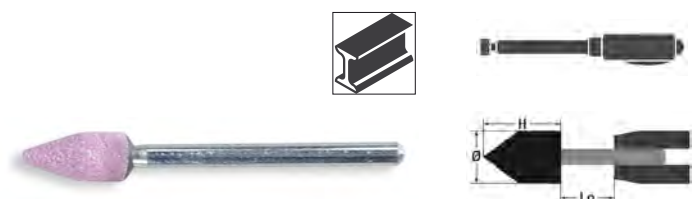

	Ø mm	h mm	max. rpm Lo=13 mm		CHF		
11120	6	13	77.800	AR60P5V	1.75	25	111200006

Beta

11121

Meule forme spéciale cylindrique pyramidale sur tige au corindon rose avec liant céramique

tige Ø 6 x 40 mm

EN 12413

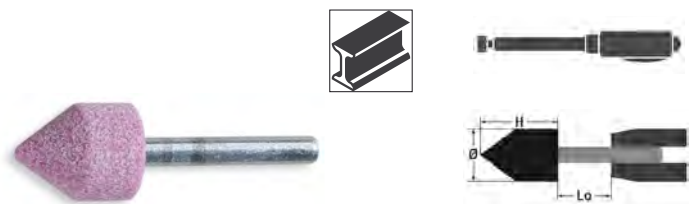

	Ø mm	h mm	max. rpm Lo=13 mm		CHF		
11121	6	25	100.700	AR60P5V	2.71	25	111210007
11121	12	20	79.500	AR60P5V	1.96	25	111210012
11121	20	25	46.100	AR46P5V	2.45	25	111210020
11121	25	25	37.200	AR36/46P5V	2.71	25	111210025
11121	30	30	26.200	AR36/46P5V	3.25	25	111210030

11125

Meule forme cylindrique bout arrondi sur tige au corindon rose avec liant céramique

tige Ø 6 x 40 mm

EN 12413

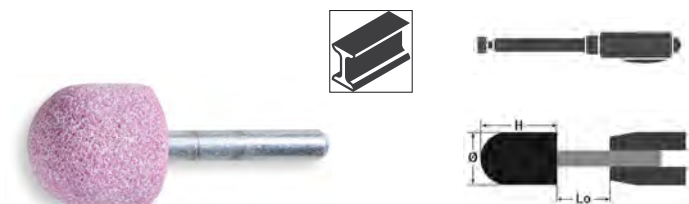

	Ø mm	h mm	max. rpm Lo=13 mm		CHF		
11125	6	20	117.700	AR60P5V	2.20	25	111250006
11125	25	25	37.200	AR36/46P5V	2.71	25	111250025
11125	30	50	15.100	AR36/46P5V	5.05	10	111250030
11125	40	40	14.700	AR36P5V	6.15	10	111250040

11130

Meule forme cylindrique bout arrondi sur tige au corindon rose avec liant céramique

tige Ø 3 x 37 mm

EN 12413

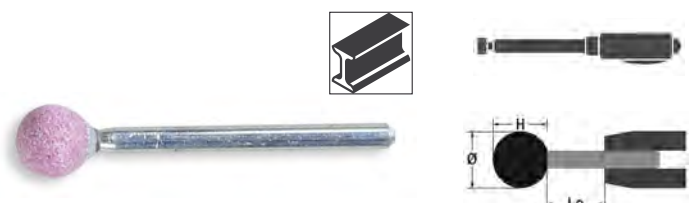

	Ø mm	h mm	max. rpm Lo=13 mm		CHF		
11130	6	6	124.900	AR60P5V	1.75	25	111300006
11130	8	8	84.800	AR60P5V	1.75	25	111300008
11130	10	10	60.100	AR60P5V	1.75	25	111300010

11131

Meule forme sphérique sur tige au corindon rose avec liant céramique

tige Ø 6 x 40 mm

EN 12413

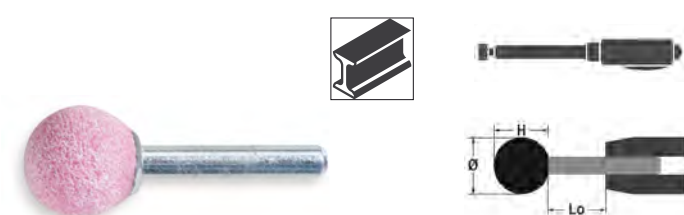

	Ø mm	h mm	max. rpm Lo=13 mm		CHF		
11131	10	10	95.400	AR60P5V	1.88	25	111310010
11131	15	15	63.600	AR60P5V	1.96	25	111310015
11131	20	20	47.700	AR46P5V	2.34	25	111310020
11131	25	25	37.200	AR36/46P5V	2.71	25	111310025
11131	30	30	26.200	AR36/46P5V	3.25	25	111310030

11132

Meule forme sphérique sur tige au corindon rose avec liant céramique

tige Ø 6 x 80 mm

EN 12413

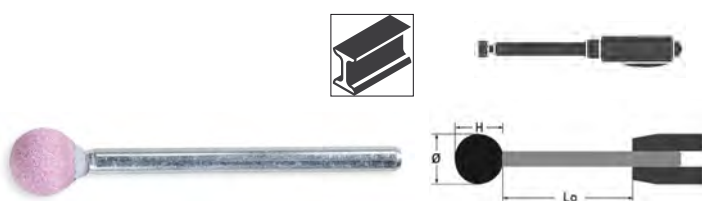

	Ø mm	h mm	max. rpm Lo=13 mm		CHF		
11132	10	10	95.400	AR60P5V	2.20	25	111320010
11132	15	15	63.600	AR60P5V	2.45	25	111320015
11132	20	20	47.700	AR46P5V	2.89	25	111320020

11135

Meule en forme de disque sur tige au corindon rose avec liant céramique

tige Ø 6 x 40 mm

EN 12413

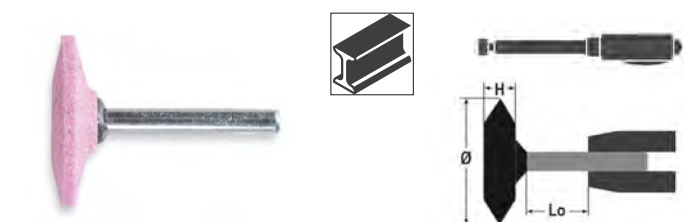

	Ø mm	h mm	max. rpm Lo=13 mm		CHF		
11135	30	6	31.800	AR60P5V	2.16	25	111350030
11135	40	10	23.800	AR36/46P5V	3.30	25	111350040

11140

Meule forme cylindrique sur tige au corindon gris/rose

tige Ø 6 x 40 mm

EN 12413



	Ø mm	h mm	max. rpm Lo=13 mm		CHF		
11140	20	30	38.900	A/AR24R5V	2.16	25	111400020
11140	25	25	37.200	A/AR24R5V	2.16	25	111400025
11140	30	30	26.200	A/AR24R5V	2.58	25	111400030
11140	50	10	19.000	A/AR24R5V	3.45	10	111400050

11141

Meule forme cylindrique sur tige au corindon gris/rose

tige Ø 6 x 80 mm

EN 12413

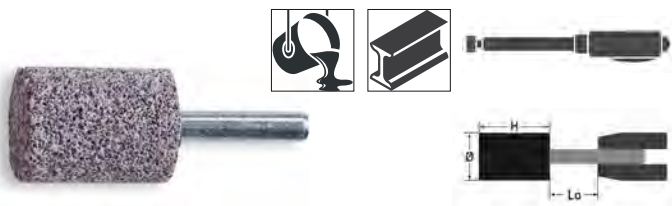

	Ø mm	h mm	max. rpm Lo=13 mm		CHF		
11141	20	40	46.800	A/AR24R5V	3.05	25	111410020
11141	30	40	31.800	A/AR24R5V	3.70	10	111410030
11141	40	40	23.800	A/AR24R5V	5.20	10	111410040

11145

Meule en forme d'ogive sur tige au corindon gris/rose

tige Ø 6 x 40 mm

EN 12413

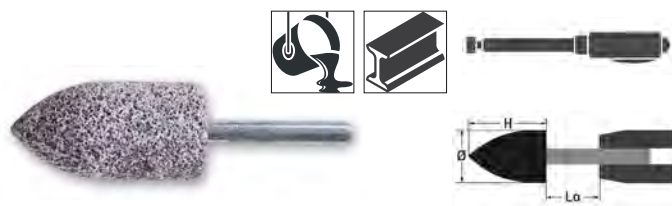

	Ø mm	h mm	max. rpm Lo=13 mm		CHF		
11145	20	30	38.900	A/AR24R5V	2.71	25	111450020
11145	25	50	18.100	A/AR24R5V	4.80	10	111450025

11200A-11200B

Disque à lamelles plat Zirconium avec support plastique. Gamme Premium avec double lamelles pour enlèvement plus agressif et longue durée de vie

Exécution plate

PREMIUM LINE

Ø 115 mm

EN 13743

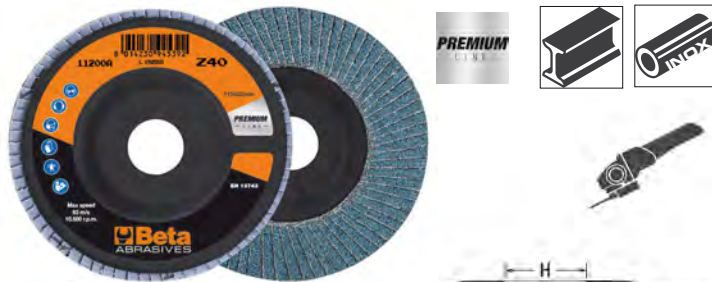

	Ø mm	P	F mm		CHF		
11200A	115	40	22,23		3.85	10	112000004
11200A	115	60	22,23		3.85	10	112000006
11200A	115	80	22,23		3.85	10	112000008
11200A	115	120	22,23		3.85	10	112000012

	Ø mm	P	F mm		CHF		
11200B	125	40	22,23		4.65	10	112000104
11200B	125	60	22,23		4.65	10	112000106
11200B	125	80	22,23		4.65	10	112000108

11202A÷11202C

Disque à lamelles plat Zirconium avec support plastique. Gamme Premium avec double lamelles pour enlèvement plus agressif et longue durée de vie

Exécution plate

PREMIUM LINE

Ø 115 mm

EN 13743

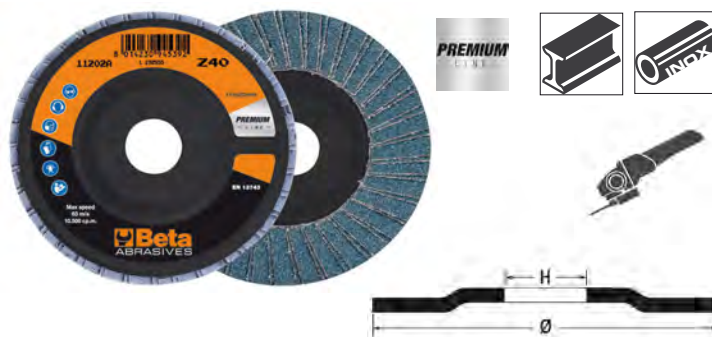

	Ø mm	P	F mm		CHF		
11202A	115	40	22,23		3.85	10	112020004
11202A	115	60	22,23		3.85	10	112020006
11202A	115	80	22,23		3.85	10	112020008
11202A	115	120	22,23		3.85	10	112020012

	Ø mm	P	F mm		CHF		
11202B	125	40	22,23		4.65	10	112020104
11202B	125	60	22,23		4.65	10	112020106
11202B	125	80	22,23		4.65	10	112020108

	Ø mm	P	F mm		CHF		
11202C	180	40	22,23		9.80	10	112020204
11202C	180	60	22,23		9.80	10	112020206

11204A-11204B

Disque à lamelles plat Zirconium avec support fibre de verre. Gamme Premium avec simple lamelle pour un enlèvement de matière élevé et longue durée de vie

Exécution plate
PREMIUM LINE
Ø 115 mm
EN 13743

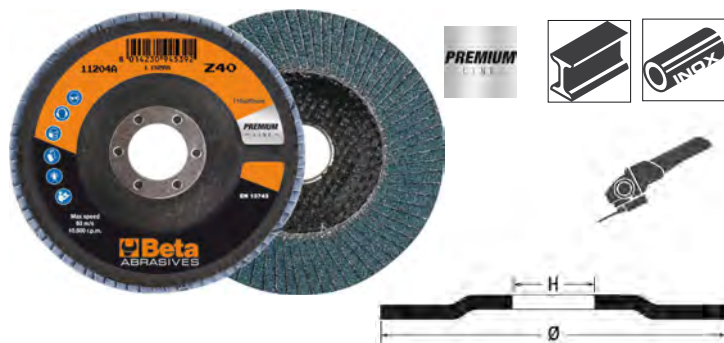

	Ø mm	P mm	F mm	CHF		
11204A	115	40	22,23	3.85	10	112040004
11204A	115	60	22,23	3.85	10	112040006
11204A	115	80	22,23	3.85	10	112040008
11204A	115	120	22,23	3.85	10	112040012

	Ø mm	P mm	F mm	CHF		
11204B	125	40	22,23	4.65	10	112040104
11204B	125	60	22,23	4.65	10	112040106
11204B	125	80	22,23	4.65	10	112040108

11208A-11208B

Disque à lamelles plat Zirconium avec support fibre de verre. Gamme Premium avec double lamelles pour enlèvement plus agressif et longue durée de vie

Exécution plate
PREMIUM LINE
Ø 115 mm
EN 13743



	Ø mm	P mm	F mm	CHF		
11208A	115	40	22,23	3.85	10	112080004
11208A	115	60	22,23	3.85	10	112080006

	Ø mm	P mm	F mm	CHF		
11208B	125	40	22,23	4.65	10	112080104
11208B	125	60	22,23	4.65	10	112080106

11210A-11210B

Disque à lamelles conique Zirconium avec support fibre de verre. Gamme Premium avec simple lamelle pour un enlèvement de matière élevé et longue durée de vie

Exécution conique
PREMIUM LINE
Ø 115 mm
EN 13743



	Ø mm	P mm	F mm	CHF		
11210A	115	40	22,23	3.85	10	112100004
11210A	115	60	22,23	3.85	10	112100006
11210A	115	80	22,23	3.85	10	112100008
11210A	115	120	22,23	3.85	10	112100012

	Ø mm	P mm	F mm	CHF		
11210B	125	40	22,23	4.65	10	112100104
11210B	125	60	22,23	4.65	10	112100106
11210B	125	80	22,23	4.65	10	112100108

11212A-11212B

Disque à lamelles plat Zirconium avec support plastique. Gamme TOP LINE avec simple lamelle pour un enlèvement de matière maximum et très longue durée de vie

Exécution plate
TOP LINE
Ø 115 mm
EN 13743

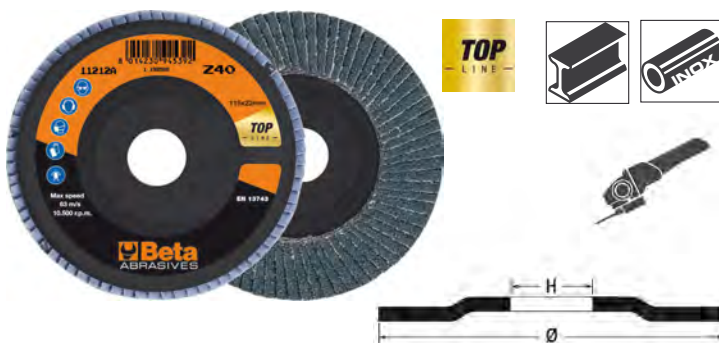

	Ø mm	P mm	F mm	CHF		
11212A	115	40	22,23	4.80	10	112120004
11212A	115	60	22,23	4.80	10	112120006
11212A	115	80	22,23	4.80	10	112120008
11212A	115	120	22,23	4.80	10	112120012

	Ø mm	P mm	F mm	CHF		
11212B	125	40	22,23	5.90	10	112120104
11212B	125	60	22,23	5.90	10	112120106
11212B	125	80	22,23	5.90	10	112120108

Beta

11214A-11214C

Disque à lamelles plat Zirconium avec support plastique. Gamme TOP LINE avec double lamelles pour un enlèvement de matière très agressif et très longue durée de vie

Exécution plate
TOP LINE
Ø 115 mm
EN 13743

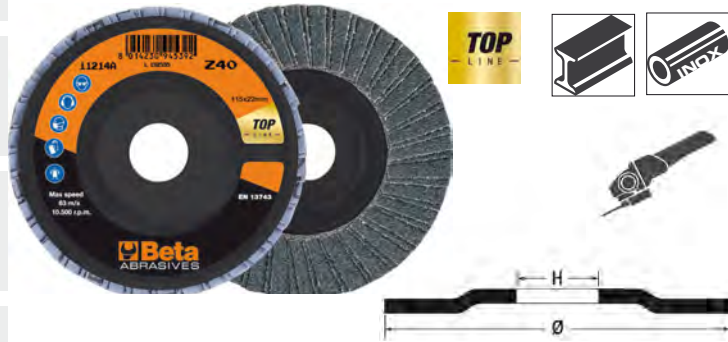

Ø	P	F	CHF	Icon	Icon
mm	mm	mm			
11214A	115	40	22,23	4.80	10 112140004
11214A	115	60	22,23	4.80	10 112140006
11214A	115	80	22,23	4.80	10 112140008
11214A	115	120	22,23	4.80	10 112140012

Ø	P	F	CHF	Icon	Icon
mm	mm	mm			
11214B	125	40	22,23	5.90	10 112140104
11214B	125	60	22,23	5.90	10 112140106
11214B	125	80	22,23	5.90	10 112140108

Ø	P	F	CHF	Icon	Icon
mm	mm	mm			
11214C	180	40	22,23	12.00	10 112140204
11214C	180	60	22,23	12.00	10 112140206

11216A-11216B

Disque à lamelles plat Zirconium avec support fibre de verre. Gamme TOP LINE avec simple lamelle pour un enlèvement de matière maximum et très longue durée de vie

Exécution plate
TOP LINE
Ø 115 mm
EN 13743



Ø	P	F	CHF	Icon	Icon
mm	mm	mm			
11216A	115	40	22,23	4.80	10 112160004
11216A	115	60	22,23	4.80	10 112160006
11216A	115	80	22,23	4.80	10 112160008
11216A	115	120	22,23	4.80	10 112160012

Ø	P	F	CHF	Icon	Icon
mm	mm	mm			
11216B	125	40	22,23	5.90	10 112160104
11216B	125	60	22,23	5.90	10 112160106
11216B	125	80	22,23	5.90	10 112160108

11218A-11218B

Disque à lamelles plat Zirconium avec support fibre de verre. Gamme TOP LINE avec double lamelles pour un enlèvement de matière très agressif et très longue durée de vie

Exécution plate
TOP LINE
Ø 115 mm
EN 13743



Ø	P	F	CHF	Icon	Icon
mm	mm	mm			
11218A	115	40	22,23	4.80	10 112180004
11218A	115	60	22,23	4.80	10 112180006

Ø	P	F	CHF	Icon	Icon
mm	mm	mm			
11218B	125	40	22,23	5.90	10 112180104
11218B	125	60	22,23	5.90	10 112180106

11220A-11220B

Disque à lamelles conique Zirconium avec support fibre de verre. Gamme TOP LINE avec simple lamelle pour un enlèvement de matière maximum et très longue durée de vie

Exécution conique
TOP LINE
Ø 115 mm
EN 13743



Ø	P	F	CHF	Icon	Icon
mm	mm	mm			
11220A	115	40	22,23	4.80	10 112200004
11220A	115	60	22,23	4.80	10 112200006
11220A	115	80	22,23	4.80	10 112200008
11220A	115	120	22,23	4.80	10 112200012

Ø	P	F	CHF	Icon	Icon
mm	mm	mm			
11220B	125	40	22,23	5.90	10 112200104
11220B	125	60	22,23	5.90	10 112200106
11220B	125	80	22,23	5.90	10 112200108

11222B

Disques à lamelles conique avec toile abrasive au zirconium, support en fibre de verre Gamme TOP avec double lamelle pour un enlèvement de matière très agressif et très longue durée de vie

Exécution conique

TOP LINE
Ø 115 mm
EN 13743

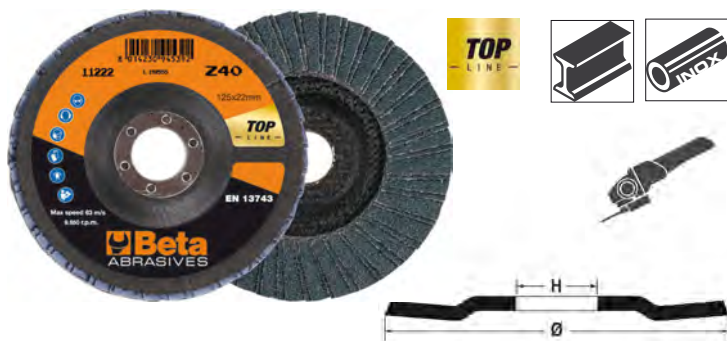

	Ø mm	P	F mm	CHF		
11222B	125	40	22,23	5.90	10	112220104
11222B	125	60	22,23	5.90	10	112220106
11222B	125	80	22,23	5.90	10	112220108

11230A-11230B

Disque à lamelles plat Corindon avec support plastique. Gamme Premium avec simple lamelle pour un bon enlèvement de matière et bonne durée de vie

Exécution plate

PREMIUM LINE
Ø 115 mm
EN 13743



	Ø mm	P	F mm	CHF		
11230A	115	40	22,23	3.55	10	112300004
11230A	115	60	22,23	3.55	10	112300006
11230A	115	80	22,23	3.55	10	112300008
11230A	115	120	22,23	3.55	10	112300012

	Ø mm	P	F mm	CHF		
11230B	125	40	22,23	4.35	10	112300104
11230B	125	60	22,23	4.35	10	112300106

Beta

11232A

Disque à lamelles plat Corindon avec support plastique. Gamme TOP LINE avec double lamelles un très bon enlèvement de matière et très bonne durée de vie

Exécution plate

PREMIUM LINE
Ø 115 mm
EN 13743

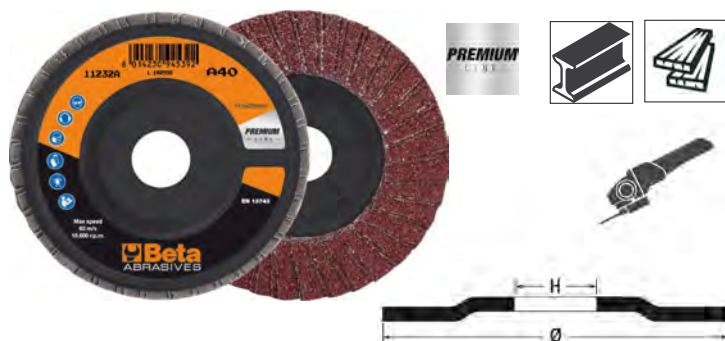

	Ø mm	P	F mm	CHF		
11232A	115	40	22,23	3.55	10	112320004
11232A	115	60	22,23	3.55	10	112320006
11232A	115	80	22,23	3.55	10	112320008
11232A	115	120	22,23	3.55	10	112320012

11234A

Disque à lamelles plat Corindon avec support fibre de verre. Gamme TOP avec simple lamelle pour un bon enlèvement de matière et bonne durée de vie

Exécution plate

TOP LINE
Ø 115 mm
EN 13743



	Ø mm	P	F mm	CHF		
11234A	115	40	22,23	4.20	10	112340004
11234A	115	60	22,23	4.20	10	112340006
11234A	115	80	22,23	4.20	10	112340008
11234A	115	120	22,23	4.20	10	112340012

Beta

11240A-11240B

Disque à lamelles plat Zirconium Céramique avec support plastique. Gamme TOP LINE avec simple lamelle pour agressivité maximum et très longue durée de vie

Exécution plate
Ø 115 mm
EN 13743



	Ø mm	P	F mm	CHF		
11240A	115	40	22,23	6.70	10	112400004
11240A	115	60	22,23	6.70	10	112400006

	Ø mm	P	F mm	CHF		
11240B	125	40	22,23	8.05	10	112400104
11240B	125	60	22,23	8.05	10	112400106

11242A-11242B

Disque à lamelles plat Zirconium Céramique avec support plastique. Gamme TOP avec simple lamelle pour agressivité maximum et très longue durée de vie

Exécution plate
Ø 115 mm
EN 13743

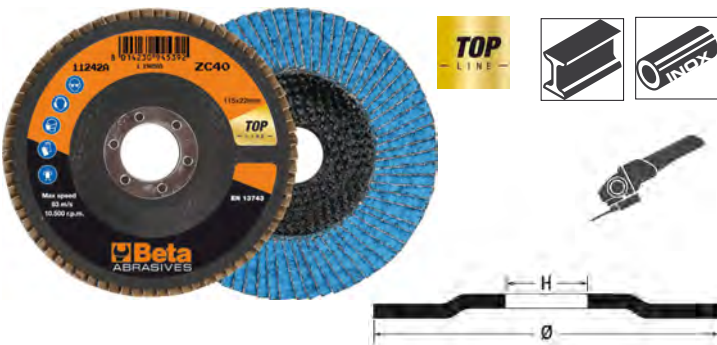

	Ø mm	P	F mm	CHF		
11242A	115	40	22,23	6.70	10	112420004
11242A	115	60	22,23	6.70	10	112420006

	Ø mm	P	F mm	CHF		
11242B	125	40	22,23	8.05	10	112420104
11242B	125	60	22,23	8.05	10	112420106

11246A

Disque à lamelles plat Zirconium Céramique avec support plastique. Gamme TOP LINE avec simple lamelle pour agressivité maximum et très longue durée de vie

Exécution plate
Ø 115 mm
EN 13743



	Ø mm	P	F mm	CHF		
11246A	115	40	22,23	8.20	10	112460004
11246A	115	60	22,23	8.20	10	112460006

11248A-11248B

Disque à lamelles plat Céramique avec support fibre de verre. Gamme TOP LINE avec simple lamelle pour un rendement maximal

Exécution plate
Ø 115 mm
EN 13743



	Ø mm	P	F mm	CHF		
11248A	115	40	22,23	8.20	10	112480004
11248A	115	60	22,23	8.20	10	112480006

	Ø mm	P	F mm	CHF		
11248B	125	40	22,23	10.70	10	112480104
11248B	125	60	22,23	10.70	10	112480106

11259

Disques à lamelles en feutre pour polissage, support en fibre de verre et lamelle simple

Exécution plate



	Ø mm	F mm	CHF		
11259	115	22,23	13.40	10	112590115
11259	125	22,23	15.40	10	112590125

Beta

11260÷11268

Roue à lamelles sur tige

tige Ø 3 mm

EN 13743



	Ø mm	h mm	S mm	P	CHF		
11260	10	10	3	60	6.70	10	112600010
11260	15	15	3	60	5.35	10	112600015

	Ø mm	h mm	S mm	P	CHF		
11263	30	10	6	60	3.55	10	112630006
11263	30	15	6	60	3.55	10	112630016
11263	30	15	6	80	3.55	10	112630018
11263	30	20	6	40	3.55	10	112630024
11263	30	20	6	60	3.70	10	112630026
11263	30	20	6	80	3.70	10	112630028
11263	30	20	6	120	3.70	10	112630032

	Ø mm	h mm	S mm	P	CHF		
11264	40	15	6	60	3.85	10	112640006
11264	40	15	6	80	3.85	10	112640008
11264	40	15	6	120	3.85	10	112640012
11264	40	20	6	40	3.95	10	112640014
11264	40	20	6	60	3.95	10	112640016
11264	40	30	6	40	4.55	10	112640024
11264	40	30	6	60	4.55	10	112640026

	Ø mm	h mm	S mm	P	CHF		
11265	50	20	6	60	4.65	10	112650006
11265	50	20	6	80	4.65	10	112650008
11265	50	30	6	40	5.20	10	112650014
11265	50	30	6	60	5.20	10	112650016
11265	50	30	6	80	5.20	10	112650018
11265	50	30	6	120	5.45	10	112650022

	Ø mm	h mm	S mm	P	CHF		
11266	60	20	6	40	5.45	10	112660004
11266	60	20	6	60	5.45	10	112660006
11266	60	30	6	40	6.15	10	112660014
11266	60	30	6	60	6.15	10	112660016
11266	60	30	6	80	6.15	10	112660018
11266	60	30	6	120	6.70	10	112660022
11266	60	40	6	60	7.05	10	112660026
11266	60	40	6	80	7.05	10	112660028

	Ø mm	h mm	S mm	P	CHF		
11268	80	30	6	60	8.45	10	112680006
11268	80	30	6	80	8.45	10	112680008

Beta

11271A÷11271C

Roue abrasive non – tissé en corindon

Ø 40 mm
tige Ø 6 mm



	Ø mm	h mm	S mm	P	CHF		
11271A	40	20	6	C	8.85	10	112710001
11271A	40	20	6	M	8.85	10	112710002
11271A	40	20	6	F	8.85	10	112710003
11271A	40	20	6	VF	8.85	10	112710004

	Ø mm	h mm	S mm	P	CHF		
11271B	60	30	6	C	10.00	10	112710011
11271B	60	30	6	M	10.00	10	112710012
11271B	60	30	6	F	10.00	10	112710013
11271B	60	30	6	VF	10.00	10	112710014

	Ø mm	h mm	S mm	P	CHF		
11271C	80	50	6	C	11.00	10	112710021
11271C	80	50	6	M	11.00	10	112710022
11271C	80	50	6	F	11.00	10	112710023
11271C	80	50	6	VF	11.00	10	112710024

11276A÷11276C

Roue abrasive non-tissé avec toile abrasive intercalée en corindon

Ø 40 mm
tige Ø 6 mm



	Ø mm	h mm	S mm	P	CHF		
11276A	40	20	6	M/60	10.10	10	112760006
11276A	40	20	6	M/80	10.10	10	112760008
11276A	40	20	6	M/120	10.10	10	112760012

	Ø mm	h mm	S mm	P	CHF		
11276B	60	30	6	M/60	11.00	10	112760016
11276B	60	30	6	M/80	11.00	10	112760018
11276B	60	30	6	M/120	11.00	10	112760022

Beta

	Ø mm	h mm	S mm	P	CHF		
11276C	80	50	6	M/60	13.30	10	112760036
11276C	80	50	6	M/80	13.30	10	112760038
11276C	80	50	6	M/120	13.30	10	112760042

11300A÷11300G

Roue à lamelles avec alésage pour touret

Ø 165 x 30 mm

EN 13743



	Ø mm	H mm	P	F mm	CHF		
11300A	165	30	40	54	36.50	3	113000004
11300A	165	30	60	54	38.50	3	113000006
11300A	165	30	80	54	39.50	3	113000008
11300A	165	30	120	54	43.50	3	113000012
11300A	165	30	180	54	45.00	3	113000018
11300A	165	30	220	54	47.50	3	113000022

	Ø mm	H mm	P	F mm	CHF		
11300B	165	50	40	54	50.00	2	113000104
11300B	165	50	60	54	53.50	2	113000106
11300B	165	50	80	54	54.50	2	113000108
11300B	165	50	120	54	60.00	2	113000112
11300B	165	50	180	54	67.00	2	113000118
11300B	165	50	220	54	70.50	2	113000122

	Ø mm	H mm	P	F mm	CHF		
11300C	200	30	40	54	43.50	3	113000204
11300C	200	30	60	54	46.50	3	113000206
11300C	200	30	80	54	50.00	3	113000208
11300C	200	30	120	54	53.50	3	113000212
11300C	200	30	180	54	57.00	3	113000218

	Ø mm	H mm	P	F mm	CHF		
11300D	200	50	40	54	60.00	2	113000304
11300D	200	50	60	54	67.00	2	113000306
11300D	200	50	80	54	70.50	2	113000308
11300D	200	50	120	54	77.50	2	113000312
11300D	200	50	180	54	84.50	2	113000318
11300D	200	50	220	54	91.00	2	113000322

	Ø mm	H mm	P	F mm	CHF		
11300E	250	30	40	100	77.50	3	113000404
11300E	250	30	60	100	82.00	3	113000406
11300E	250	30	80	100	84.50	3	113000408
11300E	250	30	120	100	90.00	3	113000412

	Ø mm	H mm	P	F mm	CHF		
11300F	250	50	40	100	111.50	2	113000504
11300F	250	50	60	100	114.50	2	113000506
11300F	250	50	80	100	117.00	2	113000508
11300F	250	50	120	100	121.50	2	113000512
11300F	250	50	180	100	143.00	2	113000518
11300F	250	50	220	100	157.00	2	113000522

	Ø mm	H mm	P	F mm	CHF		
11300G	300	50	40	100	150.00	2	113000604
11300G	300	50	60	100	157.00	2	113000606
11300G	300	50	80	100	161.00	2	113000608

11320

Roue abrasive non tissée avec alésage pour touret

Ø 200 x 50 mm

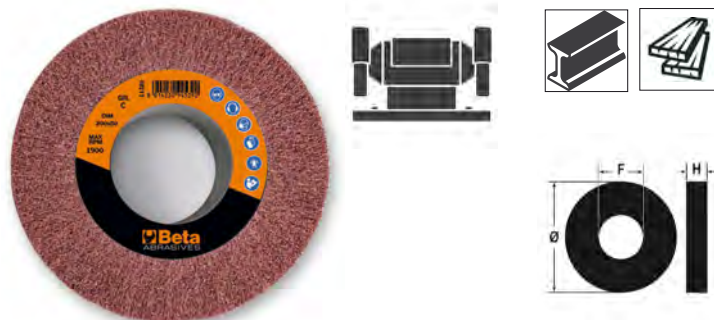

	Ø mm	H mm	P	F mm	CHF		
11320	200	50	C	76,2	45.00	2	113200006
11320	200	50	M	76,2	45.00	2	113200008
11320	200	50	F	76,2	45.00	2	113200012
11320	200	50	VF	76,2	45.00	2	113200024

11411

Rouleau à lamelles pour satineuse

Ø 100 x 100 mm

EN 13743

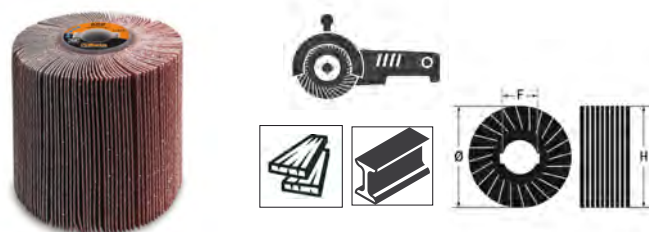

	Ø mm	H mm	P	F mm	CHF		
11411	100	100	40	19,1	38.50	2	114110004
11411	100	100	60	19,1	42.00	2	114110006
11411	100	100	80	19,1	43.50	2	114110008
11411	100	100	120	19,1	45.00	2	114110012
11411	100	100	240	19,1	46.50	2	114110024

11415B

Roue abrasive non-tissée pour satineuse

Ø 100 x 100 mm

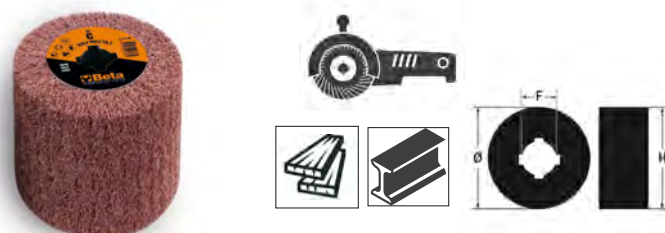

	Ø mm	H mm	P	F mm	CHF		
11415B	100	100	C	19,1	33.00	2	114150106
11415B	100	100	M	19,1	33.00	2	114150108
11415B	100	100	F	19,1	33.00	2	114150112
11415B	100	100	VF	19,1	33.00	2	114150124

11420B

Roue abrasive non-tissé avec lamelles toile intercalées pour satinéeuse

Ø 100 x 100 mm

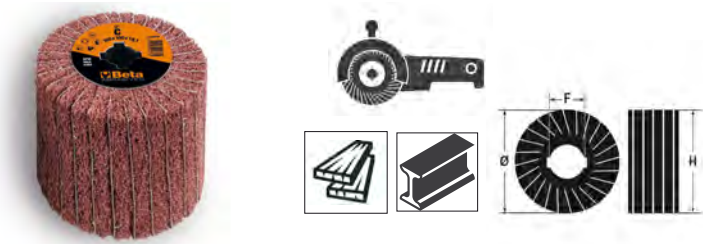

	Ø mm	H mm	P	F mm	CHF		
11420B	100	100	C/60	19,1	35.50	2	114200106
11420B	100	100	M/80	19,1	35.50	2	114200108
11420B	100	100	F/120	19,1	35.50	2	114200112
11420B	100	100	VF/240	19,1	35.50	2	114200124

11431

Disque abrasif non-tissé

Ø 115 mm



	Ø mm	P	F mm	CHF		
11431	115	C	22,23	20.50	4	114310006
11431	115	M	22,23	20.50	4	114310008
11431	115	F	22,23	20.50	4	114310012
11431	115	VF	22,23	20.50	4	114310024

11440A÷11440C

Disque fibre zirconium

Ø 115 mm



	Ø mm	P	F mm	CHF		
11440A	115	24	22	1.78	25	114400024
11440A	115	36	22	1.78	25	114400036
11440A	115	60	22	1.64	25	114400060
11440A	115	120	22	1.64	25	114400120

	Ø mm	P	F mm	CHF		
11440B	125	24	22	2.05	25	114400224
11440B	125	36	22	2.05	25	114400236
11440B	125	60	22	1.91	25	114400260
11440B	125	120	22	1.91	25	114400320

	Ø mm	P	F mm	CHF		
11440C	180	24	22	3.30	25	114400424
11440C	180	36	22	3.30	25	114400436
11440C	180	60	22	3.15	25	114400460
11440C	180	120	22	3.15	25	114400520

11450A÷11450C

Disque fibre corindon

Ø 115 mm



	Ø mm	P	F mm	CHF		
11450A	115	24	22	1.37	25	114500024
11450A	115	36	22	1.37	25	114500036
11450A	115	60	22	1.23	25	114500060
11450A	115	120	22	1.23	25	114500120

	Ø mm	P	F mm	CHF		
11450B	125	24	22	1.51	25	114500224
11450B	125	36	22	1.51	25	114500236
11450B	125	60	22	1.51	25	114500260
11450B	125	120	22	1.51	25	114500320

	Ø mm	P	F mm	CHF		
11450C	180	24	22	2.32	25	114500424
11450C	180	36	22	2.32	25	114500436
11450C	180	60	22	2.19	25	114500460
11450C	180	120	22	2.19	25	114500520

11488PF

Plateau de fixation pour disques fibrés avec écrou M14



	Ø mm	CHF		
11488P	115	10.40	1	114880115
11488P	125	11.40	1	114880125
11488P	180	17.40	1	114880180

11491-11493-11495

Rouleau de toile abrasif

h 38 mm x 50 m



	H mm	L m	P	CHF		
11491	38	50	40	67.00	1	114910004
11491	38	50	60	65.50	1	114910006
11491	38	50	80	64.00	1	114910008
11491	38	50	100	62.50	1	114910010
11491	38	50	120	62.50	1	114910012
11491	38	50	150	62.50	1	114910015
11491	38	50	180	62.50	1	114910018
11491	38	50	220	62.50	1	114910022
11491	38	50	240	62.50	1	114910024
11491	38	50	320	62.50	1	114910032
11491	38	50	400	62.50	1	114910040

	H mm	L m	P	CHF		
11493	50	50	40	106.50	1	114930004
11493	50	50	60	96.50	1	114930006
11493	50	50	80	95.50	1	114930008
11493	50	50	100	90.00	1	114930010
11493	50	50	120	90.00	1	114930012
11493	50	50	150	90.00	1	114930015
11493	50	50	180	90.00	1	114930018
11493	50	50	220	90.00	1	114930022
11493	50	50	240	90.00	1	114930024
11493	50	50	320	90.00	1	114930032
11493	50	50	400	90.00	1	114930040

	H mm	L m	P	CHF		
11495	120	25	40	125.00	1	114950004
11495	120	25	60	122.00	1	114950006
11495	120	25	80	118.50	1	114950008
11495	120	25	100	116.00	1	114950010
11495	120	25	120	116.00	1	114950012
11495	120	25	180	116.00	1	114950018
11495	120	25	240	116.00	1	114950024
11495	120	25	400	116.00	1	114950040

11498

Rouleau de bande non-tissé

h 100 mm x 10 m



	H mm	L m	P	CHF		
11498	100	10	M	56.00	1	114980008
11498	100	10	F	45.00	1	114980012
11498	100	10	VF	45.00	1	114980015
* 11498	100	10	UF	49.00	1	114980018



PINCES À SERTIR POUR COSSES

		Terminaux	Dimensions de la matrice	Range (mm ²)	Utilisations
1601/PC					Pour connecteurs téléphoniques et transmission de données 4P/6P/8P
1602				0,75-6	Pour cosSES isolées, série légère
1602A				0-6	Pour cosSES isolées, modèle standard
1603				1,25-5,5	Pour cosSES non isolées, série légère
1603A				0-8	Pour cosSES fermées non isolées, modèle standard
1603B				0-8	Pour cosSES ouvertes non isolées, modèle standard
1606/2				0,14-10	Pour cosSES cylindriques
1606A				0,5-6 6-16	Pour cosSES cylindriques
1606T				0,1-10	Pour cosSES cylindriques, sertissage 4 côtés
1607				6,48 5,41 1,69	Robuste, pour câbles coaxiaux BNC RG 58, RG 59, RG 62, RG 71
1608				0,5-6	Pour cosSES isolées, avec régulateur de pression
1608A				0,75-6	Pour bornes isolées série légère
1609				0,5-2,5	Pour bornes non isolées
1609A				0,5-6	Pour bornes isolées série légère
1609B				10-120	Pour bornes non isolées

1601/PC

Pince à cliquet pour connecteurs téléphoniques et transmission de données

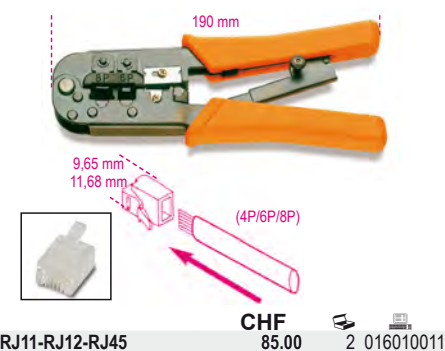

RJ11-RJ12-RJ45 CHF 85.00 2 016010011

1602

Pince à cosSES préisolées, série légère

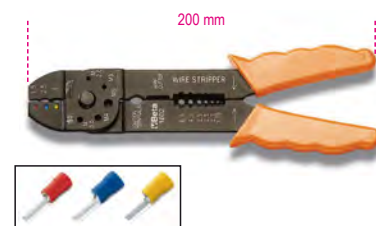

mm² CHF 0,75÷6 21.20 5 016020001

1602/C9

Pince à cosSES préisolées série légère avec assortiment de 450 cosSES



CHF 183.00 1 016020045

1602		n.
BM00180	R/6,3	50
BM00280	B/6,3	50
BM00380	G/6,3	50
BM00191	R/6,3	50
BM00291	B/6,3	50
BM00392	G/6,3	50
BM00160	R/1,6	50
BM00260	B/2,3	50
BM00360	G/3,6	50

420x185x60 mm - 1,5 kg



1602A

Pince à cosses préisolées,
modèle standard



mm²
0÷6

CHF 77.50

2 016020005

1603

Pince à cosses non-isolées,
série légère

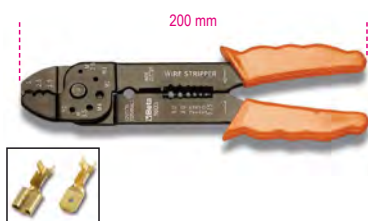

mm²
1,25÷5,5

CHF 21.20

5 016030001

1603A

Pince à cosses non-isolées fermées,
modèle standard

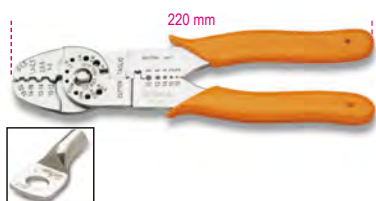

mm²
0÷8

CHF 77.50

2 016030005

1603B

Pince à cosses non-isolées ouvertes,
modèle standard

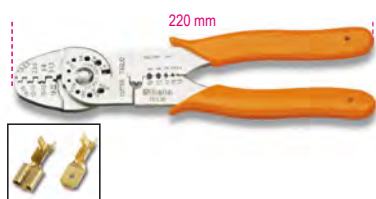

mm²
0÷8

CHF 79.50

2 016030010

1606/2

pince à cosses cylindriques,
modèle grande capacité



mm²
0,14÷10

L mm 175

A mm 65

B mm 20

CHF 464.00

1 016060002

1606A

Pince pour cosses tubulaires



mm²
0,5÷6

CHF 124.50

1 016060010

1606A16 6÷16

CHF 124.50

1 016060016

1606A/C9

pince pour cosses tubulaires

avec assortiment de 450 cosses



CHF 202.50

1 016060045

1606A6		n.
BM00601	W/0,5	1
BM00604	N/1,5	50
BM00506	B/2,5	100
BM00508	G/4	100
BM00610	Y/6	100

420x185x60 mm - 2,5 kg

Beta

1606T

Pince à sertir auto-ajustable pour cosses
cylindriques

Moindre effort de soulèvement.



mm²
0,1÷10

L mm 173

A mm 61

B mm 13

CHF 414.00

1 016060005

1607

Pince à cosses coaxiales,
modèle professionnel, pour connecteurs
BNC RG 58, RG 59, RG 62, RG 71



L mm 220

A mm 73

B mm 19

CHF 408.00

1 016070001

1608

Pince à cosses préisolées,
avec régulateur de pression

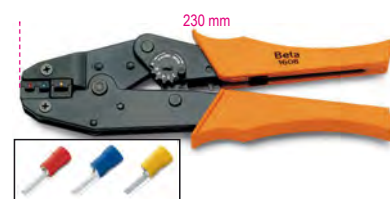

mm²
0,5÷6

CHF 159.50

1 016080001



1608/C9

Pince avec assortiment de 450 cosses



1608/C9 CHF 321.00 1 016080045

1608		n.
BM00180	R/6,3	50
BM00280	B/6,3	50
BM00380	G/6,3	50
BM00191	R/6,3	50
BM00291	B/6,3	50
BM00392	G/6,3	50
BM00160	R/1,6	50
BM00260	B/2,3	50
BM00360	G/3,6	50

420x185x60 mm - 2 kg

1608A

Pince à cosses préisolées, modèle grande capacité



mm² 0,75÷6 CHF 322.00 1 016080005

Beta

1609

Pince à cosses non-isolées automatique, modèle professionnel



mm² 0,5÷2,5 CHF 159.50 1 016090001

1609A

Pince pour cosses non-isolées, modèle grande capacité



mm² 0,5÷6 CHF 626.00 1 016090005

1609B

Pince à sertir mécanique

pour cosses non isolées de 10 à 120 mm²



L mm 600 mm² 10÷120 CHF 424.00 1 016090101

1609C/C5

Pince à sertir oléohydraulique en mallette

pour cosses non isolées de 50 à 240 mm²



mm² 50÷240 CHF 2,720.00 1 016090210

500x300x110 mm - 4 kg

1609M

Matrices pour 1609C

sertissages hexagonaux



	mm ²	CHF	
1609M/16	10-16	98.00	1 016090221
1609M/35	25-35	98.00	1 016090223
1609M/70	50-70	98.00	1 016090225
1609M/120	95-120	98.00	1 016090227
1609M/150	150	98.00	1 016090229
1609M/185	185	98.00	1 016090231
1609M/240	240	98.00	1 016090233

1639S

Sonde tire-fils en nylon

avec têtes interchangeables



L m 10 Ø mm 4 CHF 27.50 1 016390010



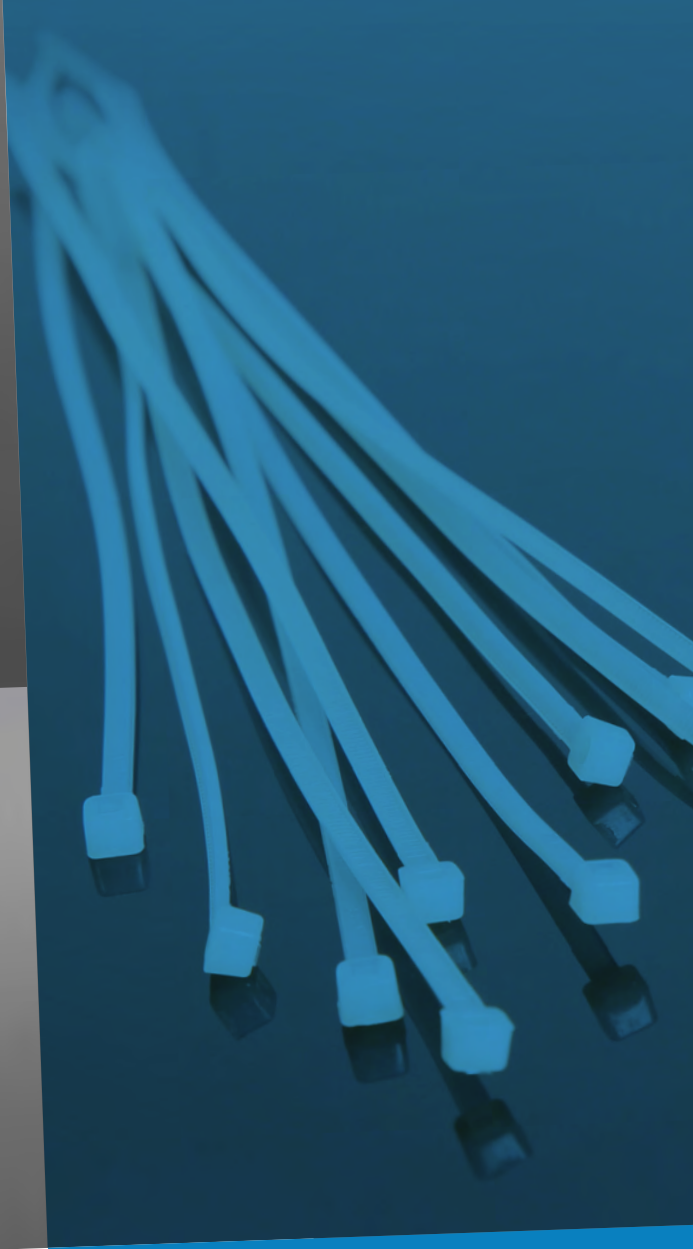
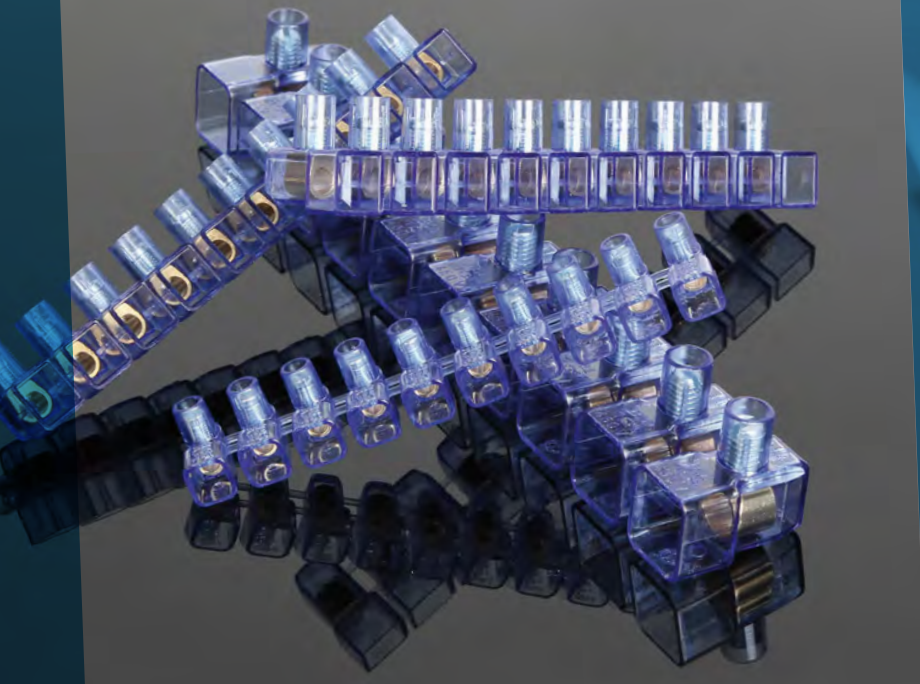

**PRODUITS DE MARQUE BM :
COLLIERS, BORNIERES,
RUBANS ISOLANTS**

Depuis 1958, BM Group conçoit, fabrique et distribue des éléments de raccord et des produits pour l'installation électrique. Qualité, sécurité et fiabilité sont depuis toujours les valeurs de BM qui, associées à la passion pour l'excellence, ont amené la société à devenir, au fur et à mesure, la référence du marché du matériel électrique.

Depuis 2018, BM Group fait partie de Beta Utensili. Une sélection attentive de produits de la marque BM est présentée dans cette section qui intègre la gamme Beta.

QUALITÉ CERTIFIÉE



1610-B

Cosse pré-isolée à œillet



D mm	mm ²	L mm	CHF	100	BM00119
4	0,25-1,5	20,6	10.50	100	BM00119
5	0,25-1,5	21,8	10.40	100	BM00125
5	1,5-2,5	22,4	10.60	100	BM00225
6	1,5-2,5	26	11.90	100	BM00231
8	1,5-2,5	29,8	14.10	100	BM00237
6	4-6	29,1	18.60	50	BM00331
8	4-6	34,5	22.90	50	BM00337

- Indiquer dans la commande le nombre d'embouts et non pas le nombre de boîtes
- Les prix indiqués se réfèrent à 100 pièces

1614-P

Cosse pré-isolée à embout



D mm	mm ²	L mm	CHF	100	BM00151
1,9	0,25-1,5	19	10.50	100	BM00151
1,9	1,5-2,5	19	11.00	100	BM00251
2,7	4-6	28	18.40	50	BM00350

- Indiquer dans la commande le nombre d'embouts et non pas le nombre de boîtes
- Les prix indiqués se réfèrent à 100 pièces

1616-SM

Cosse pré-isolée à fiche mâle



D mm	mm ²	L mm	CHF	100	BM00130
4	0,25-1,5	21	20.70	100	BM00130

- Indiquer dans la commande le nombre d'embouts et non pas le nombre de boîtes
- Les prix indiqués se réfèrent à 100 pièces

1618-SF

Cosse pré-isolée à fiche femelle



D mm	mm ²	L mm	CHF	100	BM00140
3,8	0,25-1,5	23,5	24.10	100	BM00140

- Indiquer dans la commande le nombre d'embouts et non pas le nombre de boîtes
- Les prix indiqués se réfèrent à 100 pièces

1620-M

Cosse pré-isolée rapide mâle

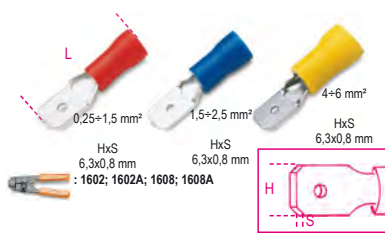

HxS mm	mm ²	L mm	CHF	100	BM00180
6,3x0,8	0,25-1,5	21	20.00	100	BM00180
6,3x0,8	1,5-2,5	21	20.70	100	BM00280
6,3x0,8	4-6	24,5	22.70	50	BM00380

- Indiquer dans la commande le nombre d'embouts et non pas le nombre de boîtes
- Les prix indiqués se réfèrent à 100 pièces

1622-F

Cosse pré-isolée rapide femelle

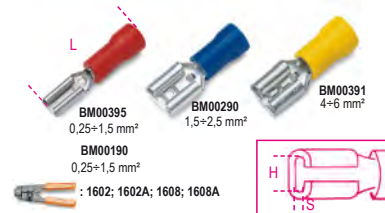

HxS mm	mm ²	L mm	CHF	100	BM00190
6,3x0,8	0,25-1,5	20,7	20.30	100	BM00190
2,8x0,5	0,25-1,5	18,5	17.10	100	BM00395
6,3x0,8	1,5-2,5	20,7	20.70	100	BM00290
6,3x0,8	4-6	24,5	29.50	50	BM00391

- Indiquer dans la commande le nombre d'embouts et non pas le nombre de boîtes
- Les prix indiqués se réfèrent à 100 pièces

1624-FI

Cosse rapide femelle isolée



HxS mm	mm ²	L mm	CHF	100	BM00191
6,3x0,8	0,25-1,5	22	22.50	100	BM00191
6,3x0,8	1,5-2,5	22	22.80	50	BM00291
6,3x0,8	4-6	25	28.50	50	BM00392

- Indiquer dans la commande le nombre d'embouts et non pas le nombre de boîtes
- Les prix indiqués se réfèrent à 100 pièces

1628-C

Connecteur de ligne pré-isolé

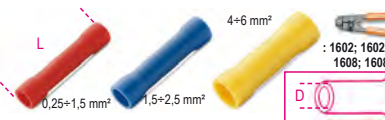

D mm	mm ²	L mm	CHF	100	BM00160
1,8	0,25-1,5	25	16.90	100	BM00160
2,5	1,5-2,5	26,5	20.00	100	BM00260
3,7	4-6	27	27.50	50	BM00360

- Indiquer dans la commande le nombre d'embouts et non pas le nombre de boîtes
- Les prix indiqués se réfèrent à 100 pièces

1630-CR

Connecteur rapide



mm ²	L mm	CHF	500	BM00110
0,25-1	15,3	17.50	500	BM00110
1,25-2,5	15,9	17.00	500	BM00210

- Indiquer dans la commande le nombre d'embouts et non pas le nombre de boîtes
- Les prix indiqués se réfèrent à 100 pièces

1632-TS

Cosse tubulaire simple



mm ²	L mm	CHF	500	BM00601
0,5	14	2.09	500	BM00601
0,75	14	2.09	500	BM00602
1	14	2.09	500	BM00603
1,5	14	2.09	500	BM00604
2,5	14	2.73	250	BM00506
4	17	4.35	200	BM00508
6	20	7.00	100	BM00610
0,5	14	2.00	500	BM00501
0,75	14	2.00	500	BM00502
1	14	2.00	500	BM00503
1,5	14	1.99	500	BM00504
6	20	6.70	100	BM00510

- Indiquer dans la commande le nombre d'embouts et non pas le nombre de boîtes
- Les prix indiqués se réfèrent à 100 pièces

1634-TD

Cosse tubulaire double



mm ²	L mm	CHF	200	BM00651
2x0,5	15	6.90	200	BM00651
2x0,75	15	5.35	200	BM00652
2x1	15	5.35	200	BM00654
2x1,5	16	5.75	200	BM00656
2x2,5	18,5	6.50	100	BM00558
2x4	23	19.40	100	BM00560
2x6	26	25.50	50	BM00661
2X0,5	15	5.15	200	BM00551
2X0,75	15	5.15	200	BM00552
2X1	15	5.15	200	BM00554
2X1,5	16	5.45	200	BM00556
2X6	26	24.10	50	BM00561

- Indiquer dans la commande le nombre d'embouts et non pas le nombre de boîtes
- Les prix indiqués se réfèrent à 100 pièces



1635-D

Bornes multiples en polypropylène, barrettes 12 pôles

Corps isolant : polypropylène (PP) naturel
Corps conducteur : cuivre

Vis imperdable : acier galvanisé

Autoextinguibilité : EN 60335-1: 2002+A2:2006 (par. 30.2.3), EN 60695-2-10 à 850 °C, EN 60695-2-11

Température de fonctionnement : max. 85 °C

Indice de protection : IP20

Normes de référence : EN 60998-1: 2004, EN 60998-2-1: 2004, EN 60335-1: 2002 + A2: 2006 (par. 30.2.3), IEC/EN 60695-2-11



mm ²	L mm	L1 mm	mm ²	CHF	🔧	📦
16	93,7	14,7	2,5	1.78	50	BM9200
20,5	116,5	17,2	4	2.20	50	BM9201
23,5	139,5	20,1	6	3.20	50	BM9202
25,3	175,5	22,5	16	5.65	25	BM9203
35,2	228	33,5	25	15.50	10	BM9204

1635-S

Borne terminale pour connexions volants

Corps isolant : polycarbonate transparent UL94 V0

Corps conducteur : cuivre

Vis imperdable : acier galvanisé

Autoextinguibilité : EN60695-2-10 à 850 °C, EN 60335-1:2002 + A2:2006, EN60695-2-11

Température de température : max. 85 °C

Indice de protection : IP20

Normes de référence : EN60998-1: EN60998-2-1:2004



mm ²	L mm	L1 mm	S mm	mm ²	N	CHF	🔧	📦
1.5	15	7.5	14.5	1.5	2	1.60	10	BM991
					1 2÷3			
2.5	17.5	9	18.2	2.5	2	1.64	10	BM992
					0.75 2÷4			
					1.5 2÷3			
4	21	10.3	20	4	2	2.20	10	BM9924
					1 2÷4			
					2.5 2÷3			
					1.5 2÷4			
6	22.5	11.8	23	6	2	2.56	10	BM993
					4 2÷3			
					2.5 2÷4			
					10 2			
10	26	14.7	26	10	2	4.35	10	BM994
					6 2÷3			
					4 2÷4			
					16 2			
16	31.8	18.8	32.2	16	2	10.30	10	BM995
					10 2÷3			
					6 2÷4			
					10 2÷3			

1635-S



mm ²	L mm	L1 mm	S mm	mm ²	N	CHF	🔧	📦
25	36.3	22.5	41.9	25	2	4.80	25	BM9960
					16 2÷3			
35	43.5	26.1	49.4	35	2	6.15	25	BM9961
					25 2÷3			
					16 2÷4			



1748-BV2

Collier en nylon, couleur naturelle

Matériau : Polyamide PA 6.6

Classe d'autoextinguibilité : UL 94-V2

Température de fonctionnement : -40 °C ÷ +85 °C

Température minimum d'installation : -10 °C

Résistance aux agents chimiques : Bonne résistance aux bases, aux huiles, aux graisses, aux solvants de chlorure.

Résistance aux acides limitée. Non résistant aux phénols

Normes de référence : EN 62275:2015-02

Classification : type 1 (EN) ; type 21 (UL)



A mm	L mm	Ø MAX mm	F MAX N	CHF	🔧	📦
2.5	80	14	80	1.75	100	BMB0824
2.5	100	20.5	80	1.63	100	BMB1025
2.5	120	27	80	2.86	100	BMB1225
2.5	160	40	80	3.85	100	BMB1625
2.5	200	52.5	80	4.20	100	BMB2025
3.6	140	33	180	4.35	100	BMB1436
3.6	200	52.5	180	5.95	100	BMB2036
3.6	300	106	180	8.35	100	BMB2936
3.6	370	105	180	13.30	100	BMB3736
4.6	120	24	220	5.85	100	BMB1248
4.6	160	36	220	6.20	100	BMB1648
4.8	188	46	220	7.45	100	BMB1948
4.8	200	50	220	7.30	100	BMB2048
4.8	250	65	220	10.60	100	BMB2548
4.8	300	81	220	10.90	100	BMB3048
4.8	370	103.5	220	13.80	100	BMB3748
4.8	390	110	220	18.70	100	BMB3948
4.8	430	122.5	220	24.20	100	BMB4348
4.8	530	160	220	40.50	100	BMB5348
7.6	150	24	550	20.00	100	BMB1576
7.6	200	51	550	20.60	100	BMB2076
7.6	300	83	550	22.90	100	BMB2976
7.6	370	103.5	550	27.50	100	BMB3776
7.6	450	130.5	550	47.00	100	BMB4576
7.6	540	159	550	60.50	100	BMB5476
7.6	750	226	550	96.50	100	BMB7576
8.8	550	163.5	800	57.00	100	BMB5390
8.8	710	195	800	80.50	100	BMB7190
8.8	780	235.5	800	90.00	100	BMB7890
9.0	430	130.5	800	47.50	100	BMB4390
9.0	810	245	800	107.00	100	BMB8190
9.0	1020	295	800	147.50	100	BMB1090
9.0	1220	375.5	800	191.50	100	BMB1290
9.0	1530	460	800	262.00	100	BMB1590

- Indiquer dans la commande le nombre de colliers et non pas le nombre de boîtes

- Les prix indiqués se réfèrent à 100 pièces

1748V

Collier en nylon, couleur vert

Matériau : Polyamide PA 6.6

Classe d'autoextinguibilité : UL 94-V2

Température de fonctionnement : -40 °C ÷ +85 °C

Température minimum d'installation : -10 °C

Résistance aux agents chimiques : Bonne résistance aux bases, aux huiles, aux graisses, aux solvants de chlorure.

Résistance aux acides limitée. Non résistant aux phénols

Normes de référence : EN 62275:2015-02

Classification : type 1 (EN) ; type 21 (UL)



A mm	L mm	Ø MAX mm	F MAX N	CHF	🔧	📦
2.5	100	20.5	80	1.60	100	BMV1025
3.6	140	33	180	3.90	100	BMV1436
4.8	200	50	220	6.65	100	BMV2048
4.8	300	81	220	9.85	100	BMV3048

- Indiquer dans la commande le nombre de colliers et non pas le nombre de boîtes

- Les prix indiqués se réfèrent à 100 pièces

1748N

Collier en nylon, couleur noir

résistant aux UV

Matériau : Polyamide PA 6.6 + carbon black

Classe d'autoextinguibilité : UL 94-V2

Température de fonctionnement : -40 °C ÷ +85 °C

Température minimum d'installation : -10 °C

Résistance aux agents chimiques : Bonne résistance aux bases, aux huiles, aux graisses, aux solvants de chlorure.

Résistance aux acides limitée. Non résistant aux phénols

Normes de référence : EN 62275:2015-02

Classification : type 1 (EN)



A mm	L mm	Ø mm	F MAX N	CHF	🔧	📦
2.5	80	14	80	1.75	100	BMN0824
2.5	100	20.5	80	1.63	100	BMN1025
2.5	120	27	80	2.89	100	BMN1225
2.5	160	40	80	3.85	100	BMN1625
2.5	200	52.5	80	4.20	100	BMN2025
3.6	140	33	180	4.35	100	BMN1436
3.6	200	52.5	180	5.95	100	BMN2036
3.6	300	106	180	8.35	100	BMN2936
3.6	370	105	180	13.50	100	BMN3736
4.6	120	24	220	5.85	100	BMN1248
4.6	160	36	220	6.35	100	BMN1648
4.8	188	46	220	7.50	100	BMN1948
4.8	200	50	220	7.30	100	BMN2048
4.8	250	65	220	10.60	100	BMN2548
4.8	300	81	220	10.90	100	BMN3048
4.8	370	103.5	220	13.80	100	BMN3748
4.8	390	110	220	18.70	100	BMN3948
4.8	430	122.5	220	24.20	100	BMN4348
4.8	530	160	220	40.50	100	BMN5348
7.6	150	24	550	20.00	100	BMN1576
7.6	200	51	550	20.60	100	BMN2076
7.6	300	83	550	22.90	100	BMN2976
7.6	370	103.5	550	27.00	100	BMN3776
7.6	450	130.5	550	47.00	100	BMN4576
7.6	540	159	550	60.50	100	BMN5476
7.6	750	226	550	96.50	100	BMN7576
8.8	550	163.5	800	57.00	100	BMN5390
8.8	710	195	800	80.50	100	BMN7190
8.8	780	235.5	800	90.00	100	BMN7890
9.0	430	130.5	800	47.50	100	BMN4390
9.0	810	245	800	106.50	100	BMN8190
9.0	1020	295	800	148.00	100	BMN1090
9.0	1220	375.5	800	191.50	100	BMN1290
9.0	1530	460	800	262.00	100	BMN1590

- Indiquer dans la commande le nombre de colliers et non pas le nombre de boîtes

- Les prix indiqués se réfèrent à 100 pièces



1748-UL

Collier en nylon pour charges lourdes, couleur noir, résistant aux UV et aux chocs

Matériel : Polyamide PA 6.6 + carbon black
 Classe d'autoextinguibilité : UL 94-V2
 Température de fonctionnement : -40 °C ÷ +85 °C
 Température minimum d'installation : -10 °C
 Résistance aux agents chimiques : Bonne résistance aux bases, aux huiles, aux graisses, aux solvants de chlorure.
 Résistance aux acides limitée. Non résistant aux phénols.
 Normes de référence : EN 62275:2015-02
 Classification : type 1 (EN); type 21 (UL)

CE



A	L	Ø MAX	F MAX	CHF		
mm	mm	mm	N			
12.4	230	57	1200	59.00	100	BMN2412
12.4	480	136.5	1200	101.50	100	BMN4912
12.4	730	216.1	1200	141.50	100	BMN7412
12.4	880	263.9	1200	169.00	100	BMN8912
12.4	1000	305	1200	202.00	100	BMN1012

- Indiquer dans la commande le nombre des collier et non pas le nombre de boîtes
 - Les prix indiqués se réfèrent à 100 pièces

1748-N2D

Collier en nylon, couleur noir, résistant aux UV

Matériel : Polyamide PA 6.6 + carbon black
 Classe d'autoextinguibilité : UL 94-V2
 Température de fonctionnement : -40 °C ÷ +85 °C
 Température minimum d'installation : -10 °C
 Résistance aux agents chimiques : Bonne résistance aux bases, aux huiles, aux graisses, aux solvants de chlorure.
 Résistance aux acides limitée. Non résistant aux phénols.
 Normes de référence : EN 62275:2015-02
 Classification : type 1 (EN)

CE



A	L	Ø MAX	F MAX	CHF		
mm	mm	mm	N			
9.0	180	40	400	30.50	100	BMN1890
9.0	265	62	540	47.50	100	BMN2690
9.0	360	93	540	57.50	100	BMN3690

- Indiquer dans la commande le nombre des collier et non pas le nombre de boîtes
 - Les prix indiqués se réfèrent à 100 pièces

Beta

1748-BVO

Collier en nylon autoextinguible, couleur blanche

Matériel : Polyamide PA 6.6 + carbon black
 Classe d'autoextinguibilité : UL 94-V0
 Température de fonctionnement : -40 °C ÷ +85 °C
 Température minimum d'installation : -10 °C
 Résistance aux agents chimiques : Bonne résistance aux bases, aux huiles, aux graisses, aux solvants de chlorure.
 Résistance aux acides limitée. Non résistant aux phénols.
 Normes de référence : EN 62275:2015-02
 Classification : type 1 (EN)

CE V0

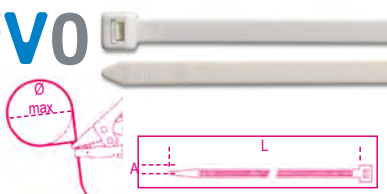

A	L	Ø MAX	F MAX	CHF		
mm	mm	mm	N			
2.5	100	20.5	80	2.55	100	BMB1025V0
3.6	150	36.0	180	6.15	100	BMB1536V0
3.6	200	52.5	180	8.80	100	BMB2036V0
4.8	200	49.5	230	9.60	100	BMB2048V0
4.8	300	81.0	230	14.00	100	BMB3048V0
4.8	370	106.7	230	20.10	100	BMB3848V0
7.6	370	106.7	540	35.50	100	BMB3876V0

- Indiquer dans la commande le nombre des colliers et non pas le nombre de boîtes
 - Les prix indiqués se réfèrent à 100 pièces

1748-BX

Collier en nylon, couleur bleue, détectable par les détecteurs de métaux

Matériel : Polyamide PA 6.6 + poudre métallique
 Classe d'autoextinguibilité : UL 94-V2
 Température de fonctionnement : -40 °C ÷ +85 °C
 Température minimum d'installation : -10 °C
 Résistance aux agents chimiques : Bonne résistance aux bases, aux huiles, aux graisses, aux solvants de chlorure.
 Résistance aux acides limitée. Non résistant aux phénols.
 Normes de référence : EN 62275:2015-02
 Classification : type 1 (EN)

CE

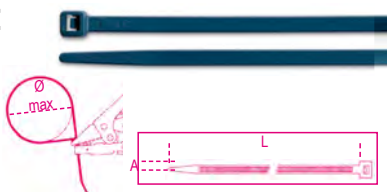

A	L	Ø MAX	F MAX	CHF		
mm	mm	mm	N			
2.5	100	20.5	80	3.05	100	BMBX1025
3.6	150	36.0	180	8.00	100	BMBX1536
3.6	200	52.5	180	10.80	100	BMBX2036
4.8	200	49.5	230	13.20	100	BMBX2048
4.8	300	81.0	230	19.10	100	BMBX3048
4.8	370	106.7	230	26.00	100	BMBX3848
7.6	370	106.7	540	47.00	100	BMBX3876

1748-BL

Collier en nylon avec dent en acier, couleur naturelle

Matériel : Polyamide PA 6.6 + acier
 Classe d'autoextinguibilité : UL 94-V2
 Température de fonctionnement : -40 °C ÷ +85 °C
 Température minimum d'installation : -10 °C
 Résistance aux agents chimiques : Bonne résistance aux bases, aux huiles, aux graisses, aux solvants de chlorure.
 Résistance aux acides limitée. Non résistant aux phénols.
 Normes de référence : EN 62275:2015-02
 Classification : type 1 (EN)

CE

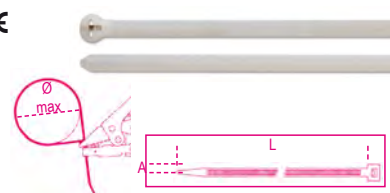

A	L	Ø MAX	F MAX	CHF		
mm	mm	mm	N			
2.5	100	20.5	180	6.10	100	BMBL1025
2.5	200	52.5	180	7.95	100	BMBL2025
3.6	140	33.0	250	13.60	100	BMBL1436
4.8	200	49.5	360	19.00	100	BMBL2048
4.8	300	81.0	360	24.30	100	BMBL3048
4.8	370	103.5	360	29.00	100	BMBL3748
7.6	370	103.5	780	55.00	100	BMBL3776

- Indiquer dans la commande le nombre de colliers et non pas le nombre de boîtes
 - Les prix indiqués se réfèrent à 100 pièces

1748-NL

Collier en nylon avec dent en acier, couleur noir, résistant aux UV

Matériel : Polyamide PA 6.6 + acier + carbon black
 Classe d'autoextinguibilité : UL 94-V2
 Température de fonctionnement : -40 °C ÷ +85 °C
 Température minimum d'installation : -10 °C
 Résistance aux agents chimiques : Bonne résistance aux bases, aux huiles, aux graisses, aux solvants de chlorure.
 Résistance aux acides limitée. Non résistant aux phénols.
 Normes de référence : EN 62275:2015-02
 Classification : type 1 (EN)

CE

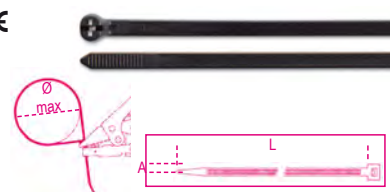

A	L	Ø MAX	F MAX	CHF		
mm	mm	mm	N			
2.5	100	20.5	180	6.10	100	BMNL1025
2.5	200	52.5	180	7.95	100	BMNL2025
3.6	140	33.0	250	13.60	100	BMNL1436
4.8	200	49.5	360	19.00	100	BMNL2048
4.8	300	81.0	360	24.30	100	BMNL3048
4.8	370	103.5	360	29.00	100	BMNL3748
7.6	370	103.5	780	54.00	100	BMNL3776

- Indiquer dans la commande le nombre de colliers et non pas le nombre de boîtes
 - Les prix indiqués se réfèrent à 100 pièces

Beta

Beta

1748-BR

Collier en nylon réutilisable,
couleur naturelle

Matériel : Polyamide PA 6.6
Classe d'autoextinguibilité : UL 94-V2
Température de fonctionnement : -40 °C + +85 °C
Température minimum d'installation : -10 °C
Résistance aux agents chimiques : Bonne résistance aux bases, aux huiles, aux graisses, aux solvants de chlorure.
Résistance aux acides limitée. Non résistant aux phénols
Normes de référence : EN 62275:2015-02
Classification: type 1 (EN) ; type 21 (UL)

CE

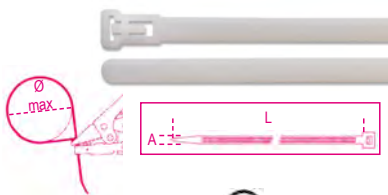

UL FILE N° E223175

A mm	L mm	Ø MAX mm	F MAX N	CHF	100	BMBR
7.6	150	40	230	21.00	100	BMBR1576
7.6	200	55	230	22.50	100	BMBR2076
7.6	300	82	230	38.00	100	BMBR3076

1748-BH

Collier en nylon avec œillet,
couleur naturelle

Matériel : Polyamide PA 6.6
Classe d'autoextinguibilité : UL 94-V2
Température de fonctionnement : -40 °C + +85 °C
Température minimum d'installation : -10 °C
Résistance aux agents chimiques : Bonne résistance aux bases, aux huiles, aux graisses, aux solvants de chlorure.
Résistance aux acides limitée. Non résistant aux phénols
Normes de référence : EN 62275:2015-02
Classification: type 1 (EN) ; type 21 (UL)

CE

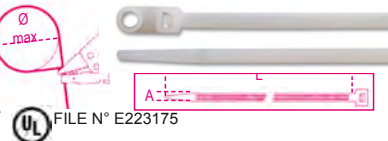

UL FILE N° E223175

A mm	L mm	Ø MAX mm	F MAX N	CHF	100	BMBH
2.5	110	19.0	80	5.60	100	BMBH1125
* 4.8	200	49.8	230	13.80	100	BMBH2048
* 7.6	305	78.7	550	45.00	100	BMBH3076

1748-BP

Collier en nylon à insertion,
couleur naturelle

Matériel : Polyamide PA 6.6
Classe d'autoextinguibilité : UL 94-V2
Température de fonctionnement : -40 °C + +85 °C
Température minimum d'installation : -10 °C
Résistance aux agents chimiques : Bonne résistance aux bases, aux huiles, aux graisses, aux solvants de chlorure.
Résistance aux acides limitée. Non résistant aux phénols
Normes de référence : EN 62275:2015-02
Classification: type 1 (EN) ; type 21 (UL)

CE

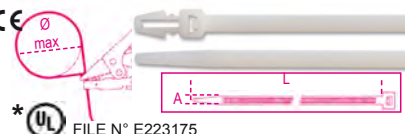

UL FILE N° E223175

A mm	L mm	Ø MAX mm	F MAX N	CHF	100	BMBP
3.6	155	37.9	180	8.50	100	BMBP1536
* 4.8	200	50.8	230	14.80	100	BMBP2048

1748-BT

Collier en nylon avec plaque transversale 25x8
mm,
couleur naturelle

Matériel : Polyamide PA 6.6
Classe d'autoextinguibilité : UL 94-V2
Température de fonctionnement : -40 °C + +85 °C
Température minimum d'installation : -10 °C
Résistance aux agents chimiques : Bonne résistance aux bases, aux huiles, aux graisses, aux solvants de chlorure.
Résistance aux acides limitée. Non résistant aux phénols
Normes de référence : EN 62275:2015-02
Classification: type 1 (EN) ; type 21 (UL)

CE

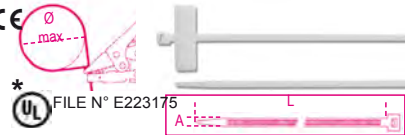

UL FILE N° E223175

A mm	L mm	Ø MAX mm	F MAX N	CHF	100	BMBT
2.5	100	22.0	80	9.55	100	BMBT1025
2.5	200	53.5	80	15.00	100	BMBT2025

- Indiquer dans la commande le nombre de colliers et non pas le nombre de boîtes
- Les prix indiqués se réfèrent à 100 pièces

1748-BT2

Collier en nylon avec plaque longitudinale
13x27 mm,
couleur naturelle

Matériel : Polyamide PA 6.6
Classe d'autoextinguibilité : UL 94-V2
Température de fonctionnement : -40 °C + +85 °C
Température minimum d'installation : -10 °C
Résistance aux agents chimiques : Bonne résistance aux bases, aux huiles, aux graisses, aux solvants de chlorure.
Résistance aux acides limitée. Non résistant aux phénols
Normes de référence : EN 62275:2015-02
Classification: type 1 (EN)

CE



A mm	L mm	Ø MAX mm	F MAX N	CHF	100	BMBT
4.8	190	51	230	17.70	100	BMBT12248

1748-BT3

Collier en nylon avec plaque externe 20x9
mm,
couleur naturelle

Matériel : Polyamide PA 6.6
Classe d'autoextinguibilité : UL 94-V2
Température de fonctionnement : -40 °C + +85 °C
Température minimum d'installation : -10 °C
Résistance aux agents chimiques : Bonne résistance aux bases, aux huiles, aux graisses, aux solvants de chlorure.
Résistance aux acides limitée. Non résistant aux phénols
Normes de référence : EN 62275:2015-02
Classification: type 1 (EN)

CE

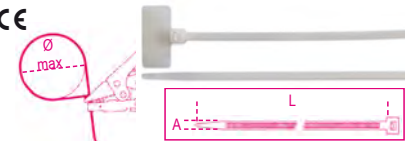

A mm	L mm	Ø MAX mm	F MAX N	CHF	100	BMBT
2.5	110	22	80	9.75	100	BMBT1125

- Indiquer dans la commande le nombre de colliers et non pas le nombre de boîtes
- Les prix indiqués se réfèrent à 100 pièces

1748-BA1

Embase de fixation

Matériel : Polyamide PA 6.6
Classe d'autoextinguibilité : UL 94-V2
Température de fonctionnement : -40 °C + +85 °C
Température minimum d'installation : -10 °C
Résistance aux agents chimiques: Bonne résistance aux bases, aux huiles, aux graisses, aux solvants de chlorure.
Résistance aux acides limitée. Non résistant aux phénols



SxDxH mm	Ø mm	F mm	CHF	100	BMB
15.2x9.4x6.8	3.3	3.6	13.30	100	BMB0905
22x16.2x10.8	5.2	9	30.00	100	BMB0906

- Indiquer dans la commande le nombre de colliers et non pas le nombre de boîtes
- Les prix indiqués se réfèrent à 100 pièces

1748-NA1

Embase de fixation

Matériel : Polyamide PA 6.6
Classe d'autoextinguibilité : UL 94-V2
Température de fonctionnement : -40 °C + +85 °C
Température minimum d'installation : -10 °C
Résistance aux agents chimiques: Bonne résistance aux bases, aux huiles, aux graisses, aux solvants de chlorure.
Résistance aux acides limitée. Non résistant aux phénols



SxDxH mm	Ø mm	F mm	CHF	100	BMN
15.2x9.4x6.8	3.3	3.6	13.60	100	BMN0905
22x16.2x10.8	5.2	9	24.30	100	BMN0906

- Indiquer dans la commande le nombre de colliers et non pas le nombre de boîtes
- Les prix indiqués se réfèrent à 100 pièces

Beta

1748-BA2

Embase de fixation bidirectionnelle

Matériel : Polyamide PA 6.6

Classe d'autoextinguibilité : UL 94-V2

Température de fonctionnement : -40 °C ÷ +85 °C

Température minimum d'installation : -10 °C

Résistance aux agents chimiques: Bonne résistance aux bases, aux huiles, aux graisses, aux solvants de chlorure.
Résistance aux acides limitée. Non résistant aux phénols

CE

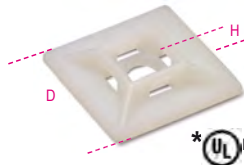

*UL FILE N° E223175

SxDxH mm	F mm	CHF		
19x19x5.4	3.6	16.50	100	BMB0901
* 28x28x7	4.8	22.80	100	BMB0902
* 28x28x5.8	4.8	20.80	100	BMB0903

1748-NA2

Embase de fixation bidirectionnelle, résistante aux UV

Matériel : Polyamide PA 6.6

Classe d'autoextinguibilité : UL 94-V2

Température de fonctionnement : -40 °C ÷ +85 °C

Température minimum d'installation : -10 °C

Résistance aux agents chimiques: Bonne résistance aux bases, aux huiles, aux graisses, aux solvants de chlorure.
Résistance aux acides limitée. Non résistant aux phénols

CE

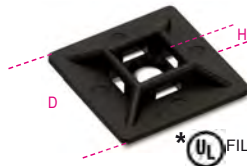

*UL FILE N° E223175

SxDxH mm	F mm	CHF		
19x19x5.4	3.6	16.50	100	BMN0901
* 28x28x7	4.8	22.80	100	BMN0902
* 28x28x5.8	4.8	20.70	100	BMN0903

- Indiquer dans la commande le nombre de colliers et non pas le nombre de boîtes
- Les prix indiqués se réfèrent à 100 pièces

1748-S

Collier autobloquant en acier inoxydable

Matériel : acier inox AISI 304 + polyester

Dispositif de fixation : à billes

Classe d'autoextinguibilité : non inflammable

Plenum rating : AH-1

Résistance aux rayons UV : excellente

Température de fonctionnement : -60 °C ÷ +300 °C

Température minimum d'installation : -60 °C

Résistance aux agents chimiques : excellente

Normes de référence : EN 62275:2015-02

Classification : type 2 (EN) ; type 2 (UL)

CE

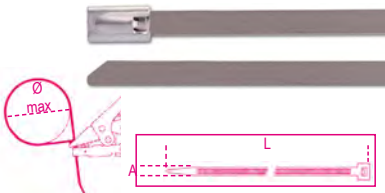

A mm	L mm	Ø MAX mm	Trazione N	CHF		
4.6	125	38	890	100.50	100	BMS1345
4.6	200	61.9	890	104.00	100	BMS2045
7.9	200	61.9	1500	110.50	100	BMS2079
4.6	290	90.6	890	112.00	100	BMS3045
7.9	300	90.6	1500	127.50	100	BMS3079
4.6	360	112.8	890	122.00	100	BMS3745
7.9	360	112.8	1500	139.00	100	BMS3779
7.9	500	163.8	1500	165.00	100	BMS5079
4.6	520	163.8	890	122.00	100	BMS5245
4.6	680	214.8	890	129.50	100	BMS6845
7.9	680	214.8	1500	188.00	100	BMS6879
4.6	840	265.7	890	135.50	100	BMS8445
7.9	840	265.7	1500	222.50	100	BMS8479

1748-SC

Collier autobloquant en acier inoxydable, revêtement en polyester noir

Matériel : acier inox AISI 304 + polyester

Dispositif de fixation : à billes

Classe d'autoextinguibilité : non inflammable

Plenum rating : AH-1

Résistance aux rayons UV : excellente

Température de fonctionnement : -60 °C ÷ +300 °C

Température minimum d'installation : -60 °C

Résistance aux agents chimiques : excellente

Normes de référence : EN 62275:2015-02

Classification : type 2 (EN) ; type 2 (UL)

CE

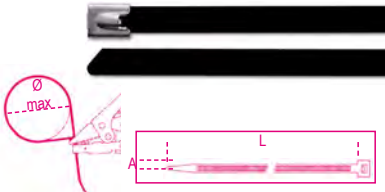

A mm	L mm	Ø MAX mm	Trazione N	CHF		
4.6	125	38	450	104.00	100	BMSC1345
4.6	200	61.9	450	121.50	100	BMSC2045
7.9	200	61.9	800	123.50	100	BMSC2079
4.6	290	90.6	450	135.50	100	BMSC3045
7.9	300	90.6	800	145.00	100	BMSC3079
4.6	360	112.8	450	150.00	100	BMSC3745
7.9	360	112.8	800	163.50	100	BMSC3779
7.9	520	163.8	800	205.00	100	BMSC5079
4.6	520	163.8	450	152.00	100	BMSC5245
4.6	680	214.8	450	173.00	100	BMSC6845
7.9	680	214.8	800	233.50	100	BMSC6879
4.6	840	265.7	450	184.00	100	BMSC8445
7.9	840	265.7	800	281.00	100	BMSC8479

1748-BV

Collier velcro, réouverture par arrachage couleur blanche

Matériau : polyéthylène-polyamide (PE-PA)

Température de fonctionnement : -20 °C ÷ +60 °C



A mm	L mm	Ø MAX mm	F MAX N	CHF		
12,7	229	55	180	294.00	10	BMBV2312
19	229	55	220	337.00	10	BMBV2319

- Indiquer dans la commande le nombre de colliers et non pas le nombre de boîtes
- Les prix indiqués se réfèrent à 100 pièces

1748-NV

Collier velcro, réouverture par arrachage couleur noir

Matériau : polyéthylène-polyamide (PE-PA)

Température de fonctionnement : -20 °C ÷ +60 °C



A mm	L mm	Ø MAX mm	F MAX N	CHF		
12,7	229	55	180	294.00	10	BMNV2312

- Indiquer dans la commande le nombre de colliers et non pas le nombre de boîtes
- Les prix indiqués se réfèrent à 100 pièces

1743

Pince pour colliers en Nylon

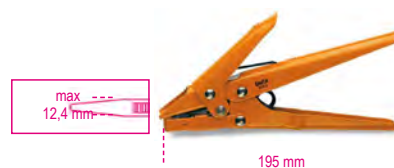

CHF		
72.00	1	017430001

1743T

Pince pour colliers

• Indiqué également pour couper de petits câbles (3x1.5mm²; 1x17mm²)



CHF		
42.50	1	017430100



1748-N

Pince pour colliers en nylon d'une largeur de 2,5 à 4,8 mm

Coupe automatique lorsque la tension programmée est atteinte.

Équipée d'un réglage de la tension de serrage

Matériau : structure en polymère et fibre de verre, pièces internes en métal.



BM1100 CHF 80.00 1 BM1100

1748-ST

Pince automatique pour colliers en acier inoxydable, pour colliers de 4,6 à 9 mm, avec contrôle automatique de la tension et coupe



BM1105 CHF 308.00 1 BM1105

1638M

Gaine thermorétractable de faible épaisseur, en minibox

Taux de rétrécissement : 2 : 1

Matériau : polyéthylène

Température de fonctionnement : -55 °C + +125 °C

Température de rétraction : +70 °C + +125 °C

VRMS maximal : 600V

Degré d'auto-extinction de la gaine : VW-1 (UL 224)

Sans halogènes



mm	L	Ø 1	Ø 2	CHF		
	m	mm	mm			
1,6	12	1,6	0,8	23.40	1	BMGBS016MNE
2,4	11	2,4	1,2	23.40	1	BMGBS024MNE
3,2	11	3,2	1,6	23.40	1	BMGBS032MNE
4,8	10	4,8	2,4	23.40	1	BMGBS048MNE
6,4	9	6,4	3,2	23.40	1	BMGBS064MNE
9,5	7	9,5	4,8	23.40	1	BMGBS095MNE
12,7	6	12,7	6,4	23.40	1	BMGBS127MNE
19	5	19,1	9,5	23.90	1	BMGBS190MNE
25,4	3,5	25,4	12,7	24.40	1	BMGBS254MNE

1639ESB

Ruban isolant en PVC

Température de fonctionnement : 0-90 °C

Charge de rupture : 28N/cm équivalent à 18,6 N/mm²

Allongement à rupture : 200 %

Adhérence à l'acier : 2.2N/cm

Adhérence sur l'arrière : 2 N/cm

Rigidité diélectrique : 45kV/mm

Inflammabilité : retardateur de flamme

Normes de référence : IEC 60454-2

Classification : CEI EN 60454-3-1-5/F-PVCP/90



S	A	L	CHF		
mm	mm	m			
0.15	15	10	1.08	10	BMESB1510BI
0.15	15	10	1.08	10	BMESB1510BL
0.15	15	10	1.08	10	BMESB1510GI
0.15	15	10	1.08	10	BMESB1510GR
0.15	15	10	1.21	10	BMESB1510GV
0.15	15	10	1.08	10	BMESB1510MA
0.15	15	10	1.08	10	BMESB1510NE
0.15	15	10	1.08	10	BMESB1510RO
0.15	15	10	1.08	10	BMESB1510VE
0.15	15	25	2.63	10	BMESB1525BI
0.15	15	25	2.63	10	BMESB1525BL
0.15	15	25	2.63	10	BMESB1525GI
0.15	15	25	2.63	10	BMESB1525GR
0.15	15	25	2.76	10	BMESB1525GV
0.15	15	25	2.63	10	BMESB1525MA
0.15	15	25	2.63	10	BMESB1525NE
0.15	15	25	2.63	10	BMESB1525RO
0.15	15	25	2.63	10	BMESB1525VE
0.15	19	25	2.88	10	BMESB1925BI
0.15	19	25	2.88	10	BMESB1925BL
0.15	19	25	2.88	10	BMESB1925GI
0.15	19	25	2.88	10	BMESB1925GR
0.15	19	25	2.99	10	BMESB1925GV
0.15	19	25	2.88	10	BMESB1925MA
0.15	19	25	2.88	10	BMESB1925NE
0.15	19	25	2.88	10	BMESB1925RO
0.15	19	25	2.88	10	BMESB1925VE
0.15	25	25	4.10	8	BMESB2525BI
0.15	25	25	4.10	8	BMESB2525BL
0.15	25	25	4.10	8	BMESB2525GI
0.15	25	25	4.10	8	BMESB2525GR
0.15	25	25	4.20	8	BMESB2525GV
0.15	25	25	4.10	8	BMESB2525MA
0.15	25	25	4.10	8	BMESB2525NE
0.15	25	25	4.10	8	BMESB2525RO
0.15	25	25	4.10	8	BMESB2525VE
0.15	50	25	6.20	4	BMESB5025NE

1639ESC

Ruban isolant en PVC

Température de fonctionnement : 0-80 °C

Charge de rupture : 28N/cm équivalent à 18,6 N/mm²

Allongement à rupture : 200 %

Adhérence à l'acier : 2.2N/cm

Adhérence sur l'arrière : 2.2 N/cm

Rigidité diélectrique : 38kV/mm

Inflammabilité : retardateur de flamme

Normes de référence : ASTM-D-1000 ; UL510

Classification: CEI EN 60454-3-1-5/F-PVCP/90



S mm 0.18 A mm 19 L m 20 CHF 3.85 10 BMESC1920NE

1639ETA

Ruban isolant en PVC pour températures extrêmes

Température de fonctionnement : -18 ÷ +105 °C

Charge de rupture : 35N/cm équivalent à 19,4 N/mm²

Allongement à rupture : 300 %

Adhérence à l'acier : 3.1N/cm

Adhérence sur l'arrière : 2.7 N/cm

Rigidité diélectrique : 55.5kV/mm

Inflammabilité : retardateur de flamme

Normes de référence : ASTM-D-1000 ; UL510

Classification: CEI EN 60454-3-1-5/F-PVCP/90



S mm 0.18 A mm 19 L m 20 CHF 11.50 1 BMETA1920NE

1639EAB

Ruban isolant autoagglomérant à base d'EPR

Température de fonctionnement : -40 ÷ +90 °C

Charge de rupture : 2,4 N/mm²

Allongement à rupture : 750%

Rigidité diélectrique : 29,5kV/mm

Inflammabilité : retardateur de flamme

Normes de référence : ASTM-D-4388; ASTM-D-4325

Excellente résistance à l'humidité, à la corrosion et aux agents chimiques



S mm 0.76 A mm 19 L m 9 CHF 23.40 1 BMEAB1909NE





GAMME BLISTER

pour la vente
en libre service!

- **Meilleure visibilité**
- **Efficacité d'exposition**
- **Code à barres**



SUPPORT BLISTER:

- PVC indéchirable
- 4 formats pour optimiser l'espace d'exposition
- Système de fixation de nouvelle génération avec bande élastique

42K



mm	CHF	Hand	Code
5,5x5,5	10.70	5	000429505
6x6	10.90	5	000429506
7x7	11.00	5	000429507
8x8	11.30	5	000429508
9x9	11.90	5	000429509
10x10	12.20	5	000429510
11x11	13.00	5	000429511
12x12	13.20	5	000429512
13x13	13.20	5	000429513
14x14	15.00	5	000429514
15x15	16.60	5	000429515
16x16	17.10	5	000429516
17x17	18.00	5	000429517
18x18	19.00	5	000429518
19x19	19.70	5	000429519
20x20	22.10	3	000429520
21x21	23.70	3	000429521
22x22	24.40	3	000429522
23x23	26.00	3	000429523
24x24	27.50	3	000429524
25x25	29.00	2	000429525
26x26	31.50	2	000429526
27x27	34.00	2	000429527
28x28	34.50	2	000429528
29x29	38.50	2	000429529
30x30	39.50	2	000429530
32x32	44.00	2	000429532

55K



mm	CHF	Hand	Code
6x7	7.20	5	000559012
8x9	7.30	5	000559021
10x11	7.70	5	000559030
10x12	10.40	5	000559033
10x13	11.40	5	000559035
12x13	8.60	5	000559042
12x14	11.60	5	000559045
13x17	13.60	5	000559051
14x15	10.80	5	000559054
14x17	14.60	5	000559057
16x17	12.30	5	000559060
17x19	16.40	2	000559063
18x19	14.40	2	000559066
19x22	18.50	2	000559069
20x22	16.40	2	000559075
21x23	17.40	2	000559078
22x24	20.10	2	000559081
24x26	20.60	2	000559087
24x27	22.50	2	000559090
25x28	23.40	2	000559096
27x29	26.00	2	000559099
27x30	30.00	2	000559102
30x32	29.00	2	000559108

90K



mm	CHF	Hand	Code
6x7	13.30	5	000909006
8x9	14.10	5	000909012
10x11	15.60	5	000909018
12x13	17.00	5	000909027
14x15	18.50	5	000909033
16x17	21.10	5	000909039
18x19	24.70	5	000909045

mm	CHF	Hand	Code
20x22	28.00	3	000909051
21x23	31.50	2	000909057
24x26	35.50	2	000909063
24x27	39.00	2	000909067
25x28	42.50	2	000909070
27x29	46.00	2	000909073
30x32	51.50	2	000909080

93K



mm	CHF	Hand	Code
21x22	53.50	3	000939021

94K



mm	CHF	Hand	Code
8x10	22.90	2	000949008
9x11	23.80	2	000949009
10x11	24.90	2	000949010
11x13	25.50	2	000949011
12x14	27.00	2	000949012
13x15	27.00	2	000949013
14x15	31.50	2	000949014
14x17	33.00	2	000949015
17x19	33.50	2	000949017
19x22	35.50	2	000949019
22x24	44.00	2	000949022
24x27	47.50	2	000949024
30x32	62.00	2	000949030

96/SC9



96/SC9	CHF	Hand	Code
1,5-2-2,5-3-4-5-6-8-10 mm	27.00	1	000960374

96/ST6K



96/ST6K	CHF	Hand	Code
2,5-3-4-5-6-8 mm	19.10	3	000969370

96N/ST6K



96N/ST6K	CHF	Hand	Code
2,5-3-4-5-6-8 mm	13.50	3	000969640

96BPA/SC9



96BPA/SC9	CHF	Hand	Code
1,5-2-2,5-3-4-5-6-8-10 mm	62.00	1	000961974

96BP-CL/SC9



96BP-CL/SC9	CHF	Hand	Code
1,5-2-2,5-3-4-5-6-8-10 mm	69.00	1	000961619

96BPC/SC9



96BPC/SC9	CHF	Hand	Code
1,5-2-2,5-3-4-5-6-8-10 mm	56.50	1	000960354

96C/AS



	CHF	Hand	Code
1/16	2.22	20	000961702
3/32	3.10	20	000961706
1/8	3.25	20	000961710
5/32	3.80	20	000961714
3/16	4.30	20	000961716
7/32	4.85	20	000961718
1/4	5.40	20	000961720
5/16	6.00	10	000961724
3/8	7.45	10	000961728

96LBP/SC9



96LBP/SC9
1,5-2-2,5-3-4-5-6-8-10 mm

CHF 65.50 1 000961354

96/BGS7



96/BGS7
1,5-2-2,5-3-4-5-6 mm

CHF 40.50 1 000960367

96/BG7



96/BG7
2,5-3-4-5-6-8-10 mm

CHF 42.50 1 000960368

96TK



mm	CHF	Hand	Part No.
2	15.60	5	000969934
2,5	15.60	5	000969935
3	16.40	5	000969936
4	16.90	5	000969938
5	17.20	5	000969940
6	19.70	5	000969941
8	24.90	3	000969943
10	28.50	3	000969945

97BTX/SC8



97BTX/SC8
T9-T10-T15-T20-T25-T27-T30-T40

CHF 101.00 1 000970164

97BTXL/SC8



97BTXL/SC8
T9-T10-T15-T20-T25-T27-T30-T40

CHF 116.50 1 000970364

111E



L mm	CHF	Hand	Part No.
100	32.00	3	001110110
150	33.50	3	001110115
200	41.00	3	001110120
250	49.50	3	001110125
300	65.50	3	001110130
380	129.00	3	001110138
450	214.50	2	001110145
600	297.00	1	001110160

111EN



L mm	CHF	Hand	Part No.
100	29.50	3	001110410
150	31.00	3	001110415
200	36.00	3	001110420
250	44.50	3	001110425
300	60.00	3	001110430
380	119.00	3	001110438
450	202.50	2	001110445

111ER



L mm	CHF	Hand	Part No.
200	42.50	3	001110520
250	52.50	3	001110525
300	69.00	2	001110530



123/K4



123/K4

CHF 42.50 1 001230504

142K



mm	CHF	Hand	Part No.
6	23.20	3	001429006
7	23.20	3	001429007
8	23.90	3	001429008
9	25.50	3	001429009
10	26.00	3	001429010
11	27.00	3	001429011
12	28.00	3	001429012
13	30.00	3	001429013
14	31.00	2	001429014
15	33.00	2	001429015
16	35.50	2	001429016
17	36.50	2	001429017
18	39.00	2	001429018
19	39.50	2	001429019
21	51.50	1	001429021
22	53.50	1	001429022
24	62.00	1	001429024

192/S2

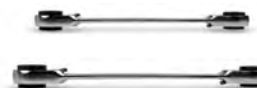

192/S2
8x10/12x13 mm
16x17/18x19 mm

CHF 83.00 1 001920070

195K



mm	CHF	Hand	Part No.
8x10	26.50	2	001959010
12x13	30.00	2	001959013
14x15	31.50	2	001959015
16x18	37.00	2	001959018
17x19	39.00	2	001959019

374K



L mm 240
CHF 49.50 1 003749024

850MQ



L mm	CHF		
233	31.50	1	008500910

855P



L1 mm	CHF		
240	95.50	1	008550010

860/58K



L mm	CHF		
126	101.50	1	008609884

860LP



SxA mm	CHF		
0,5x3	2.51	5	008600005
0,6x4,5	2.51	5	008600010
0,8x5,5	2.51	5	008600015
1x5,5	2.51	5	008600020
1,2x6,5	2.51	5	008600025

860PH



PH	CHF		
0	2.51	5	008600220
1	2.51	5	008600225
2	2.51	5	008600230
3	2.51	5	008600245
4	3.65	5	008600250

860PZ



PZ	CHF		
1	2.51	5	008600320
2	2.51	5	008600325
3	2.51	5	008600330
4	3.65	5	008600335

860PE



mm	CHF		
2	2.67	5	008600101
2,5	2.67	5	008600102
3	2.67	5	008600103
4	2.67	5	008600104
5	2.67	5	008600105
6	2.67	5	008600106
8	3.35	5	008600108
10	3.35	5	008600110

860TX



T6	CHF		
T7	3.35	5	008600704
T8	3.35	5	008600705
T9	3.35	5	008600710
T10	3.35	5	008600715
T15	2.67	5	008600720
T20	2.67	5	008600725
T25	2.67	5	008600730
T27	2.67	5	008600735
T30	2.67	5	008600740
T40	2.67	5	008600745
T50	2.67	5	008600750

860RTX



T9	CHF		
T10	3.65	5	008600550
T15	3.65	5	008600555
T20	3.65	5	008600560
T25	3.65	5	008600565
T27	3.65	5	008600570
T30	3.65	5	008600575
T40	3.65	5	008600580
T50	3.65	5	008600585

860/C27



860/C27	CHF		
	116.00	1	008600880

860MIX/A10



860MIX/A10	CHF		
	48.50	1	008600900

860TX/A10



860TX/A10	CHF		
	51.50	1	008600970

860MIX/A31



860MIX/A31	CHF		
	114.00	1	008600902

862F/A7



862F/A7	CHF		
	66.50	1	008620950

900K



mm	CHF		
4	5.50	10	009009040
4,5	5.50	10	009009045
5	5.50	10	009009050
5,5	5.50	10	009009055
6	5.50	10	009009060
7	5.50	10	009009070
8	5.50	10	009009080
9	5.50	10	009009090
10	5.50	10	009009100
11	5.50	10	009009110
12	5.50	10	009009120
13	5.60	10	009009130
14	5.70	10	009009140

900/20LK



L mm	CHF		
100	12.30	5	009009819

900/25K

14"



L mm	CHF		
41	22.70	5	009009830

900BG/30K

14"



L mm	CHF		
128	11.90	5	009009834

900/55K

14"



L mm	CHF		
125	60.50	5	009009870

900/55ZK

14"



L mm	CHF		
125	60.50	3	009009882

900/58K

14"



L mm	CHF		
126	92.50	2	009009884

910AK

38"



mm	CHF		
6	8.55	5	009109006
7	8.55	5	009109007
8	8.55	5	009109008
9	8.55	5	009109009
10	8.55	5	009109010
11	8.55	5	009109011
12	8.85	5	009109012
13	8.85	5	009109013
14	8.85	5	009109014
15	8.85	5	009109015
16	9.90	5	009109016
17	9.90	5	009109017
18	9.90	5	009109018
19	9.90	5	009109019
20	10.60	5	009109020
21	10.60	5	009109021
22	10.90	5	009109022

910/21K

38"



L mm	CHF		
125	15.80	5	009109822

910/25K

38"



L mm	CHF		
54,6	28.00	5	009109830

910/55K

38"



L mm	CHF		
200	65.50	3	009109882

910/58K

38"



L mm	CHF		
222	101.00	1	009109884

920AK

12"



mm	CHF		
10	8.70	10	009209010
11	8.70	10	009209011
12	8.70	10	009209012
13	9.00	10	009209013
14	9.00	10	009209014
15	9.00	10	009209015
16	10.10	10	009209016
17	10.10	10	009209017
18	10.10	10	009209018
19	10.10	10	009209019
20	10.90	5	009209020
21	10.90	5	009209021
22	10.90	5	009209022
23	12.80	5	009209023
24	12.80	5	009209024
25	12.80	5	009209025
26	13.20	5	009209026
27	13.20	5	009209027
28	13.20	5	009209028
29	13.50	5	009209029
30	13.50	5	009209030
32	14.30	5	009209032

920/21K

12"



L mm	CHF		
125	21.30	5	009209822

920/25K

12"



L mm	CHF		
75	33.50	5	009209830

920/55K

12"



L mm	CHF		
275	80.00	3	009209882

920/58K

12"



L mm	CHF		
281	120.00	1	009209926

935K

mm	CHF		
6x7	10.70	5	009359105
8x9	11.50	5	009359111
10x11	12.90	5	009359115
12x13	14.30	5	009359117
14x15	16.60	5	009359126
16x17	18.10	5	009359128
18x19	21.30	5	009359131
20x22	25.50	3	009359138

937K

mm	CHF		
6x6	11.50	5	009379006
7x7	12.00	5	009379007
8x8	12.50	5	009379008
9x9	13.30	5	009379009
10x10	13.60	5	009379010
11x11	14.30	5	009379011
12x12	16.00	5	009379012
13x13	16.40	5	009379013
14x14	17.90	5	009379014
15x15	19.70	5	009379015
16x16	21.20	5	009379016
17x17	22.10	5	009379017
18x18	22.60	5	009379018
19x19	23.40	5	009379019
20x20	26.00	5	009379020
21x21	28.50	3	009379021
22x22	30.00	3	009379022

943BKK



mm	CHF	5	009439005
5,5	22.60	5	009439005
6	22.60	5	009439006
7	24.10	5	009439007
8	24.10	5	009439008
10	26.00	3	009439010
13	27.50	3	009439013

951K



mm	CHF	5	009519521
2	24.90	5	009519521
2,5	24.90	5	009519525
3	24.90	5	009519530
3,5	25.50	5	009519535
4	25.50	5	009519540
4,5	28.00	5	009519545
5	28.00	5	009519550
6	32.00	5	009519560
8	34.50	5	009519580
10	44.00	5	009519610

1032K



L mm	CHF	5	010329013
140x0,9	33.50	5	010329013
140x1,3	33.00	5	010329014
180	35.50	5	010329017

1033K



L mm	CHF	5	010339013
140x0,9	38.00	5	010339013
140x1,3	36.50	5	010339014
180	38.50	5	010339017

1034K



L mm	CHF	5	010349013
130x0,9	38.00	5	010349013
130x1,3	36.50	5	010349014
170	38.50	5	010349017

1036K



L mm	CHF	5	010369013
140x0,9	36.00	5	010369013
140x1,3	35.50	5	010369014
175	36.50	5	010369017

1037K



L mm	CHF	5	010379013
140x0,9	40.50	5	010379013
140x1,3	38.50	5	010379014
175	40.50	5	010379017

1038K



L mm	CHF	5	010389013
135x0,9	40.50	5	010389013
135x1,3	38.50	5	010389014
175	40.50	5	010389017

1044NK



L mm	CHF	5	010449025
250	33.50	5	010449025

1048NK



L mm	CHF	3	010489910
175	36.00	3	010489910
250	38.00	5	010489915

1048VNK



L mm	CHF	3	010489111
175	35.50	3	010489111
250	40.50	5	010489116

1052K



L mm	CHF	3	010529014
140	36.00	3	010529014
190	40.50	3	010529019
240	44.00	3	010529024

1082K



L mm	CHF	5	010829004
140	34.50	5	010829004
160	36.00	5	010829006

1082GK



L mm	CHF	5	010829064
140	29.50	5	010829064
160	31.00	5	010829066

1082BMK



L mm	CHF	3	010829034
140	43.50	3	010829034
160	47.00	3	010829036

1082GBMK



L mm	CHF	3	010829264
140	38.00	3	010829264
160	42.50	3	010829266

1084K



L mm	CHF	3	010849006
160	40.50	3	010849006

1084GK



L mm	CHF		
160	35.50	5	010849066

1084BMK



L mm	CHF		
160	49.00	3	010849036

1084GBMK



L mm	CHF		
160	54.00	3	010849266

1088K



L mm	CHF		
160	49.50	2	010889006

1088BMK



L mm	CHF		
160	60.50	2	010889036

1096K



L mm	CHF		
200	31.00	5	010969020

1098K



L mm	CHF		
190	26.50	5	010989190
220	30.00	5	010989220

1098PLK



L mm	CHF		
220	33.50	5	010989320

1112K



L mm	CHF		
200	35.50	2	011129020

1122K



L mm	CHF		
250	47.50	2	011229020

1123K



L mm	CHF		
250	47.50	2	011239020

1124K



L mm	CHF		
250	47.50	2	011249020

1128BAX

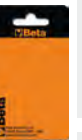

L mm	CHF		
150	44.00	5	011280088

1128BMX

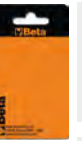

L mm	CHF		
147	23.40	5	011280051

1128BSX



L mm	CHF		
148	40.50	5	011280061

1128FX



L mm	CHF		
145	42.50	5	011280090

1128FXS

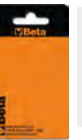

L mm	CHF		
145	51.00	5	011280095

1129BMK

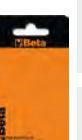

L mm	CHF		
145	22.80	5	011299000

1130BMX



L mm	CHF	Icon	Code
185	26.00	1	011300002

1132K



L mm	CHF	Icon	Code
170	67.50	2	011329107

1132BMK



L mm	CHF	Icon	Code
170	83.00	2	011329137

1142BMK



L mm	CHF	Icon	Code
160	54.50	3	011429036

1144T



L mm	CHF	Icon	Code
112	28.00	1	011440060

1149F



L mm	CHF	Icon	Code
175	23.10	1	011490010

1150K



L mm	CHF	Icon	Code
160	30.50	5	011509046
180	33.50	5	011509048
200	36.00	5	011509050
220	39.50	2	011509052

1150GK



L mm	CHF	Icon	Code
160	28.50	5	011509066
180	31.00	5	011509068
200	34.50	5	011509070
220	36.00	2	011509072

1150BMK



L mm	CHF	Icon	Code
160	38.00	3	011509146
180	42.00	3	011509148
200	46.00	3	011509150
220	49.00	2	011509152

1150GBMK



L mm	CHF	Icon	Code
160	35.50	3	011509266
180	38.00	3	011509268
200	43.50	3	011509270
220	46.00	2	011509272

1162K



L mm	CHF	Icon	Code
160	36.00	5	011629006
200	42.00	5	011629010

1162GK



L mm	CHF	Icon	Code
160	30.50	5	011629066
200	35.50	5	011629070

1162BMK



L mm	CHF	Icon	Code
160	44.00	3	011629036
200	49.00	3	011629040

1162GBMK



L mm	CHF	Icon	Code
160	38.00	3	011629266
200	44.50	3	011629270

1164K



L mm	CHF	Icon	Code
160	39.00	5	011649006
200	44.00	5	011649010

1164BMK



L mm	CHF	Icon	Code
160	47.50	3	011649036
200	54.00	3	011649040

1166K



L mm	CHF	Icon	Code
160	36.00	5	011669006
200	42.00	5	011669010

1166GK



L mm	CHF	Hand	Quantity	Part No.
160	30.50	Right	5	011669066
200	35.50	Right	5	011669070

1166BMK



L mm	CHF	Hand	Quantity	Part No.
160	44.00	Right	3	011669036
200	49.00	Right	3	011669040

1166GBMK



L mm	CHF	Hand	Quantity	Part No.
160	38.00	Right	3	011669266
200	44.50	Right	3	011669270

1168K



L mm	CHF	Hand	Quantity	Part No.
160	39.00	Right	5	011689006
200	44.00	Right	5	011689010

1168GK



L mm	CHF	Hand	Quantity	Part No.
160	33.50	Right	5	011689066
200	38.00	Right	5	011689070

1168BMK



L mm	CHF	Hand	Quantity	Part No.
160	47.50	Right	3	011689036
200	54.00	Right	3	011689040

1168GBMK



L mm	CHF	Hand	Quantity	Part No.
160	42.50	Right	3	011689266
200	47.50	Right	3	011689270

1201E/K



SxAxL mm	CHF	Hand	Quantity	Part No.
0,4x2,5x50	5.60	Right	5	012019203
0,4X2,5x75	5.85	Right	5	012019206
0,5x3x75	5.90	Right	5	012019209
0,5x3x100	6.35	Right	5	012019212
0,6x3,5X75	6.35	Right	5	012019218
0,6x3,5x100	6.50	Right	5	012019221
0,8x4x100	6.60	Right	5	012019230
0,8x4x125	6.95	Right	5	012019233
0,8x4X150	7.50	Right	5	012019236
1,0x5,5x100	8.15	Right	5	012019239
1,0x5,5X125	8.55	Right	5	012019240
1,0x5,5x150	8.70	Right	5	012019242
1,2x6,5x100	9.70	Right	5	012019248
1,2x6,5x125	10.00	Right	5	012019250
1,2x6,5x150	10.20	Right	5	012019251
1,2x8x150	13.20	Right	3	012019257
1,2x8X200	13.90	Right	3	012019260
1,6x10x200	16.10	Right	3	012019266

1201EN/K



SxAxL mm	CHF	Hand	Quantity	Part No.
0,8x4x30	8.05	Right	3	012019303
1,2x6,5x30	8.35	Right	3	012019306

1202E/K



PHxDxL mm	CHF	Hand	Quantity	Part No.
0x3x60	5.85	Right	5	012029203
0x3X100	6.50	Right	5	012029206
1x4,5x80	7.45	Right	5	012029209
1x4,5x120	8.30	Right	5	012029212
2x6x100	10.00	Right	5	012029218
2x6x150	10.70	Right	5	012029221
3x8x150	13.50	Right	3	012029224
4x9,5x200	17.60	Right	3	012029227

1202EN/K



PHxDxL mm	CHF	Hand	Quantity	Part No.
1x4,5x30	8.05	Right	3	012029303
2x6x30	8.35	Right	3	012029306

1204E/K



SxDxL mm	CHF	Hand	Quantity	Part No.
0,4x2,5x60	5.75	Right	5	012049103
0,6x3x75	5.90	Right	5	012049106
0,5x3x100	6.00	Right	5	012049109
0,8x4x100	6.75	Right	5	012049112
0,8x4x125	7.05	Right	5	012049115
1,0x5x125	8.20	Right	5	012049118
1,0x5x150	8.85	Right	5	012049121
1,2x6,5x150	9.70	Right	5	012049124

1207E TX/K



Size	CHF	Hand	Quantity	Part No.
T5	8.55	Right	5	012079105
T6	9.05	Right	5	012079106
T7	9.25	Right	5	012079107
T8	9.45	Right	5	012079108
T9	9.85	Right	5	012079109
T10	11.20	Right	5	012079110
T15	11.30	Right	5	012079115
T20	11.50	Right	5	012079120
T25	11.80	Right	5	012079125
T27	12.50	Right	5	012079127
T30	12.70	Right	5	012079130
T40	14.80	Right	2	012079140
T45	16.30	Right	2	012079145

1208E RTX/K



Size	CHF	Hand	Quantity	Part No.
T9	10.00	Right	5	012089109
T10	11.20	Right	5	012089110
T15	11.80	Right	5	012089115
T20	12.00	Right	5	012089120
T25	12.30	Right	5	012089125
T27	13.20	Right	5	012089127
T30	13.80	Right	5	012089130
T40	16.40	Right	2	012089140

1209E PZ/K



Size	CHF	Hand	Quantity	Part No.
PZ 0	6.75	Right	5	012099200
1	8.70	Right	5	012099203
2	11.20	Right	5	012099206
3	16.70	Right	3	012099209
4	18.20	Right	3	012099212



1209EN-PZ/K



	CHF	🔧	📄
1	8.05	3	012099303
2	8.35	3	012099306

1253



SxAxL mm	CHF	🔧	📄
0,5x3,5x100	12.80	5	012530001

1254



SxAxL mm	CHF	🔧	📄
0,5x3x44	14.00	5	012540001

1260K



SxAxL	CHF	🔧	📄
0,4x2,5x50	7.75	5	012609003
0,4x2,5x75	8.00	5	012609006
0,5x3x75	8.20	5	012609009
0,5x3x100	8.50	5	012609012
0,6x3,5x75	8.75	5	012609018
0,6x3,5x100	8.85	5	012609021
0,8x4x100	9.70	5	012609030
0,8x4x125	10.10	5	012609033
0,8x4x150	10.50	5	012609036
1x5,5x100	11.00	5	012609039
1x5,5x150	12.30	5	012609042
1,5x6,5x100	13.20	5	012609048
1,2x6,5x150	14.10	5	012609051
1,2x8x150	17.20	3	012609057
1,2x8x200	17.70	3	012609060
1,6x10x200	21.50	3	012609066

1260NK



SxAxL mm	CHF	🔧	📄
0,8x4x30	10.20	5	012609103
1,2x6,5x30	11.40	5	012609106

1260EK



SxAxL mm	CHF	🔧	📄
1,2x6,5x150	18.20	3	012609156
1,2x8x175	22.50	3	012609157
1,6x10x200	25.50	2	012609159
2x12x250	29.50	2	012609162

1262K



PHxDxL mm	CHF	🔧	📄
0x3x60	8.20	5	012629003
0x3x100	8.70	5	012629006
1x4,5x80	10.70	5	012629009
1x4,5x120	11.70	5	012629012
2x6x100	13.20	5	012629018
2x6x150	14.30	5	012629021
3x8x150	19.00	3	012629024
4x10x200	24.20	3	012629027

1262NK



PHxDxL	CHF	🔧	📄
1x4,5x30	10.20	5	012629103
2x6x30	11.40	5	012629106

1262EK



PHxDxL mm	CHF	🔧	📄
2x6x150	18.20	3	012629153
3x8x175	22.20	3	012629156
4x10x200	27.50	3	012629159

1264K



SxDxL mm	CHF	🔧	📄
0,5x2,5x60	7.75	5	012649003
0,6x3x75	8.20	5	012649006
0,6x3x100	8.50	5	012649009
0,8x4x100	9.70	5	012649012
0,8x4x125	10.10	5	012649015
1x5x125	11.40	5	012649018
1x5x150	11.90	5	012649021
1,2x6,5x150	14.10	5	012649024

1267TKK



Ø	CHF	🔧	📄
T5	11.50	5	012679005
T6	11.90	5	012679006
T7	12.30	5	012679007
T8	12.90	5	012679008
T9	13.30	5	012679009
T10	13.80	5	012679010
T15	14.50	5	012679015
T20	15.30	5	012679020
T25	16.60	5	012679025
T27	17.20	5	012679027
T30	18.10	5	012679030
T40	21.00	2	012679040
T45	23.10	2	012679045

1268RTKK



Ø	CHF	🔧	📄
T9	14.40	3	012689009
T10	14.90	3	012689010
T15	15.30	3	012689015
T20	16.60	3	012689020
T25	17.00	3	012689025
T27	18.10	3	012689027
T30	18.40	3	012689030
T40	21.20	2	012689040

1269PZK



PZ	CHF	🔧	📄
0	9.35	5	012699000
1	12.20	5	012699001
2	14.40	5	012699002
3	20.50	3	012699003
4	26.00	3	012699004

1269N/PZK



PZ	CHF	🔧	📄
1	10.20	5	012699011
2	11.40	5	012699012

1290K



SxAxL mm	CHF		
0,4x2,5x50	9.85	5	012909003
0,4x2,5x75	10.20	5	012909006
0,5x3x75	10.40	10	012909009
0,5x3x100	10.90	10	012909012
0,6x3,5x75	11.80	10	012909018
0,6x3,5x100	12.00	10	012909021
0,8x4x100	12.20	10	012909030
0,8x4x125	12.50	10	012909033
0,8x4x150	13.20	10	012909036
1x5,5x100	13.40	10	012909039
1x5,5x150	14.80	10	012909042
1,2x6,5x100	16.60	10	012909048
1,2x6,5x150	17.50	10	012909051
1,2x8x150	21.80	3	012909057
1,2x8x200	23.20	3	012909060
1,6x10x200	27.00	3	012909066

1290NK



SxAxL mm	CHF		
0,8x4x30	12.80	5	012909103
1,2x6,5x30	14.00	5	012909106

1290K/INOX



SxAxL mm	CHF		
0,4x2,5x50	12.70	4	012909403
0,5x3x75	13.00	4	012909409
0,8x4x100	13.30	4	012909430
1,0x5,5x150	16.90	4	012909442
1,2x6,5x150	19.20	4	012909451

1292K



PHxDxL mm	CHF		
0x3x60	9.45	10	012929003
0x3x100	10.70	5	012929006
1x4,5x80	12.90	10	012929009
1x4,5x120	14.10	10	012929012
2x6x100	16.90	10	012929018
2x6x150	18.00	10	012929021
3x8x150	22.90	3	012929024
4x10x200	31.00	3	012929027

1292NK



PHxDxL mm	CHF		
1x4,5x30	12.30	5	012929103
2x6x30	13.30	5	012929106

1292K/INOX



PHxDxL mm	CHF		
0x3x60	11.80	4	012929403
1x4,5x80	13.80	4	012929409
2x6x100	16.90	4	012929418

1294K



SxDxL mm	CHF		
0,5x2,5x60	9.20	5	012949003
0,6x3x75	9.75	5	012949006
0,8x4x100	12.20	5	012949012
1x5x125	14.90	5	012949018

1298RTXK



	CHF		
T9	20.00	5	012989009
T10	20.30	5	012989010
T15	21.60	5	012989015
T20	21.70	5	012989020
T25	22.30	5	012989025
T27	23.90	5	012989027
T30	24.70	5	012989030
T40	26.50	2	012989040

1299PZK



PZ	CHF		
0	13.40	5	012999000
1	15.80	5	012999003
2	21.20	5	012999006

1299N/PZK



PZ	CHF		
1	15.10	5	012999021
2	16.90	5	012999024

1472VW



L mm	CHF		
200	61.50	1	014720051

1473P



A Max mm	CHF		
53	47.50	1	014730020

1497BS

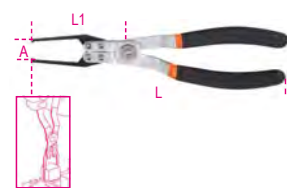

L mm	CHF		
230	30.50	1	014970190

1497SS



L mm	CHF		
245	27.50	1	014970195

Beta
Quality Tools

1497RC



1497RC CHF 99.00 1 014970351

1600Q 8



1600Q 8 CHF 38.50 1 016000008

1600Q 10



1600Q 10 CHF 49.00 1 016000010

1603K



mm² 0÷8 CHF 22.30 5 016039001

1603BK



mm² 0÷8 CHF 82.50 2 016039010

1651DGTB

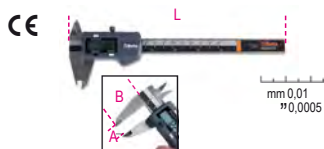

A Max mm	CHF		
150	135.00	1	016510211
200	176.00	1	016510212
300	230.00	1	016510213

Beta

Quality Tools

1651DGTB/IP

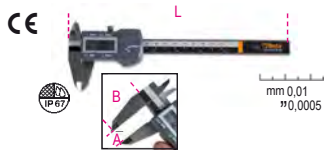

A Max mm 150 CHF 220.50 1 016510711

1691BM



L m	CHF		
5	21.10	1	016910205
8	31.50	1	016910208
10	38.50	1	016910210

1691MG



L m	CHF		
5	19.00	1	016910405
8	26.50	1	016910408
10	28.00	1	016910410

1692



L m	CHF		
2	10.20	5	016920052
3	12.80	5	016920053
5	18.20	5	016920055
8	26.00	5	016920058

1693

CE



IP54



H mm 100 CHF 162.00 1 016930020

1729CG



L mm 310 CHF 31.00 2 017290200

1729DM 450



L mm 450 CHF 35.50 4 017290450

1741U



Ø mm	2.4	3	3.2	4	4.8
Aluminium	•	•	•	•	•
Acier	•	•	•	•	
Acier inoxydable	•	•	•	•	

1741U CHF 60.50 1 017410450



1741B



250 mm

Ø mm	2,4	3,2	4	4,8	5
Aluminium	•	•	•	•	•
Acier	•	•	•	•	•
Inox	•	•	•		

1741B CHF 51.50 1 017410000

1760K

CE



180 mm

CAT III-1000V

1760K CHF 49.00 1 017600140

1762K



Ø mm 2-2,5-3 3,5-4-4,5 CHF 42.00 2 017629001

1771



18 mm

170 mm

1771 CHF 12.30 10 017710000

1770BM



L mm 140 CHF 16.60 10 017700050

1771BM



L mm 170 CHF 27.00 10 017710050

1771HD



L mm 190 CHF 30.00 5 017710100

1772R



L mm 125 CHF 22.70 5 017720006

1773A



L mm 180 CHF 23.90 10 017730000

1773S



L mm 190 CHF 11.20 1 017730100

1777BMT



L mm 170 CHF 36.50 5 017770050

1777T



L mm 160 CHF 34.00 5 017770030

1778MT



L mm 180 CHF 130.00 1 017780055

1783



L mm 215 CHF 20.00 5 017830021
240 CHF 22.30 5 017830024

1820



1820 30 30W CHF 64.00 1 018200003
L = 210mm
1820 60 60W CHF 73.00 1 018200006
L = 220mm
1820 80 80W CHF 103.50 1 018200008
L = 260mm



1822



1822 120 120W LxA = 250x125 mm	CHF 158.00	1	018220012
1822 180 180W LxA = 250x125mm	167.50	1	018220018
1822 320 320W LxA = 250x140mm	208.50	1	018220032

1833XSW



L mm 145	CHF 61.50	1	018330011
----------------	--------------	---	-----------

1833S



L mm 150	CHF 49.00	1	018330002
----------------	--------------	---	-----------

1833M



L mm 162	CHF 61.50	1	018330003
----------------	--------------	---	-----------

1833MW



L mm 160	CHF 112.00	1	018330013
----------------	---------------	---	-----------



1833L



L mm 196	CHF 102.50	1	018330004
----------------	---------------	---	-----------

1833XL



L mm 300	CHF 128.50	1	018330005
----------------	---------------	---	-----------

1833L/USB



L mm 240	CHF 150.50	1	018330054
----------------	---------------	---	-----------

1836AW



1836AW	CHF 92.50	1	018360051
--------	--------------	---	-----------

1836B



1836B	CHF 167.50	1	018360200
-------	---------------	---	-----------

1837F



L mm 460	CHF 111.00	1	018370050
----------------	---------------	---	-----------

1837F/USB



L mm 460	CHF 164.50	1	018370060
----------------	---------------	---	-----------

1838COB



1838COB	CHF 120.00	1	018380010
---------	---------------	---	-----------



1838P



1838P CHF 103.00 1 018380005

1838POCKET



L mm 98 CHF 87.50 1 018380080

1838SLIM

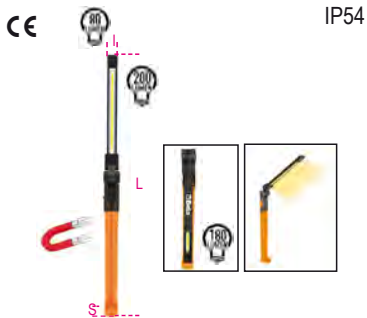

L mm 307 CHF 93.50 1 018380221

1838SW



L mm 260 CHF 124.50 1 018380142

1839BRW



L mm 101 CHF 118.00 1 018390002

1860M

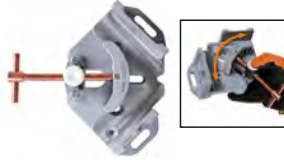

L max mm 30 CHF 121.50 1 018600301

1875SP/K3



1875SP/K3 CHF 24.10 1 018750010

1949F2



g 125 CHF 22.30 1 019490028

1949XS



g 20 CHF 8.85 25 019490025

6888B1/4

Broche blister pour douilles 1/4"



6888B1/4 CHF 0.87 50 068880900

6888B3/8

Broche blister pour douilles 3/8"



6888B3/8 CHF 1.03 50 068880910

6888B1/2

Broche blister pour douilles 1/2"



6888B1/2 CHF 1.03 50 068880920

Beta

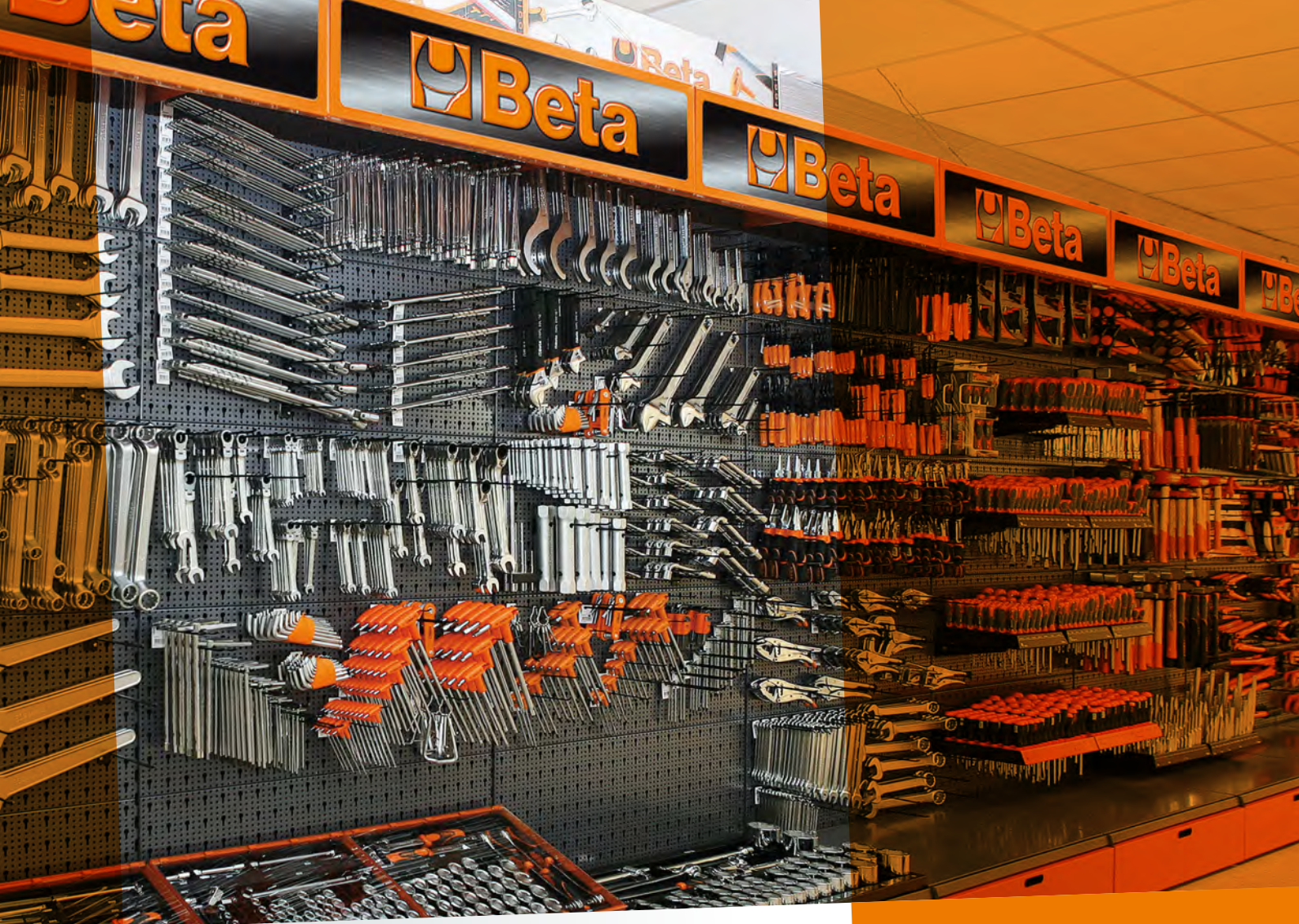

SOLUTIONS POUR LE POINT DE VENTE

Beta
SHOP
in shop

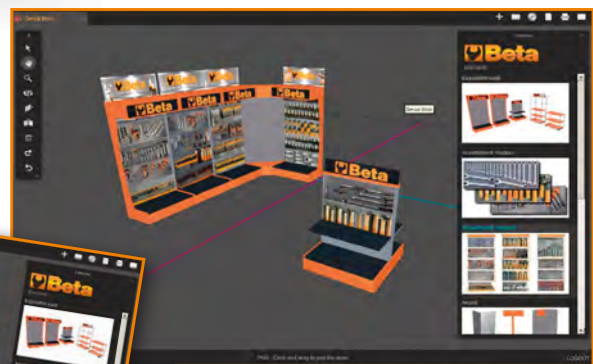

CONSTRUISEZ VOTRE CORNER BETA
www.beta-tools.com/planner3d/

38/DS1

Présentoir mural avec 75 outils à frapper



495x260x332 mm

Présentoir avec composition **CHF** 931.00 1 000380701

		n.
30	Ø 2 - 3 - 4 - 5 - 6 mm	5
31	Ø 2 - 3 - 4 - 5 - 6 - 8 - 10 mm	5
32	Ø 3 - 4 - 5 mm	5

Présentoir vide **CHF** 145.50 1 000380751

38/DS2

Présentoir mural avec 65 outils à frapper

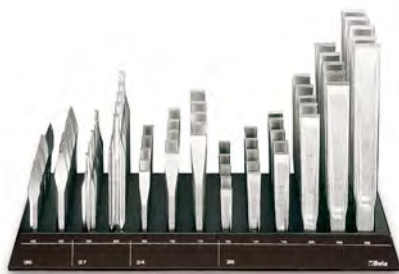

495x260x332 mm

Présentoir avec composition **CHF** 1,760.00 1 000380702

		n.
34	125 - 150 - 175 mm	5
35	100 - 125 - 150 - 200 - 250 - 300 mm	5
36	125 - 150 mm	5
37	150 - 200 mm	5

Présentoir vide **CHF** 145.50 1 000380752

942BX/DG

Présentoir mural avec 43 clés a douille emmanchées, série courte



330x260x332 mm

Présentoir avec composition **CHF** 934.00 1 009420701

		n.
942BX	5 - 5,5 mm	3
	6 - 7 mm	6
	8 - 9 - 10 mm	5
	11 mm	2
	12 mm	3
	13 mm	5

Présentoir vide **CHF** 129.00 1 009420751

943BX/DG

Présentoir mural avec 43 clés a douille emmanchées, série longue



330x260x332 mm

Présentoir avec composition **CHF** 1,003.00 1 009430701

		n.
943BX	5 - 5,5 mm	3
	6 - 7 mm	6
	8 - 9 - 10 mm	5
	11 mm	2
	12 mm	3
	13 mm	5

Présentoir vide **CHF** 129.00 1 009430751

944BX/DG

Présentoir mural avec 43 clés à douille profondes emmanchées, série longue
Présentoir mural avec 43 tournevis emmenché emmanchées, série longue



330x260x332 mm

Présentoir avec composition **CHF** 1,161.00 1 009440701

		n.
944BX	5 - 5,5 mm	3
	6 - 7 mm	6
	8 - 9 - 10 mm	5
	11 mm	2
	12 mm	3
	13 mm	5

Présentoir vide **CHF** 129.00 1 009430751

943MQ/BG

Présentoir mural avec 30 clés a douille emmanchées



△1000 V ⊕

330x260x332 mm

Présentoir avec composition **CHF** 815.00 1 009430281

		n.
943MQ	5,5 - 6 - 7 - 8 - 10 - 13 mm	5

Présentoir vide **CHF** 129.00 1 009430285

1203/E1P

Présentoir mural avec 82 tournevis



495x260x310 mm

Présentoir avec composition
1203E/E1P CHF 611.00 1 012031301

Code	Description	Quantité
1201	0,4x2,5x50 - 0,5x3x75 - 0,6x3,5x100 0,8x4x100 - 0,8x4x125 mm	7
	1,0x5,5x100 - 1,0x5,5x150 - 1,2x6,5x150 mm	6
	1,2x8x150 mm	5
1202	PH0x3x60 mm	7
	PH1x4,5x80 - PH2x6x100 mm	6
	PH3x8x150 mm	5

Présentoir vide
1203E/EV1P CHF 161.00 1 012031351

1203/E4P

Présentoir mural avec 82 tournevis



495x260x310 mm

Présentoir avec composition
1203E/E4P CHF 588.00 1 012031304

Code	Description	Quantité
1201	0,4x2,5x50 - 0,5x3x75 - 0,8x4x125 mm	7
	1,0x5,5x100 - 1,0x5,5x150 - 1,2x6,5x150 mm	6
1204	0,4x2,5x60 - 0,5x3x100 - 0,8x4x100 mm	7
	1,0x5x125 mm	6
1209PZ	PZ0x3x60 mm	7
	PZ1x4,5x80 - PZ2x6x100 mm	6

Présentoir vide
1203E/EV4P CHF 161.00 1 012031354

1203/E5P

Présentoir mural avec 82 tournevis



495x260x310 mm

Présentoir avec composition
1203E/E5P CHF 622.00 1 012031305

Code	Description	Quantité
1202	PH0x3x60 mm	7
	PH1x4,5x80 - PH1x4,5x120	6
	PH2x6x100 - PH2x6x150 mm	5
	PH3x8x150 mm	5
1204	0,4x2,5x60 - 0,5x3x100 - 0,8x4x100 mm	7
	1,0x5x125 mm	6
1209PZ	PZ0x3x60 mm	7
	PZ1x4,5x80 - PZ2x6x100 mm	6

Présentoir vide
1203E/EV5P CHF 161.00 1 012031355

1203/E10P

Présentoir mural avec 82 tournevis



495x260x310 mm

Présentoir avec composition
1203E/E10P CHF 837.00 1 012031310

Code	Description	Quantité
1207TX	T6	4
	T7	3
	T8	7
	T9 - T10 - T15 - T20 - T25	6
	T27 - T30	3
1208RTX	T9 - T10	3
	T15 - T20 - T25	6
	T27 - T30	3

Présentoir vide
1203E/EV10P CHF 161.00 1 012031360

1263/E78

Présentoir mural avec 78 tournevis



495x260x310 mm

Présentoir avec composition
1263/E78 CHF 808.00 1 012630510

Code	Description	Quantité
1260	2,5x75-3x75-3,5x100 mm	7
	4x100-4x125-5,5x100-5,5x150-6,5x150 mm	6
	8x150 mm	4
1262	PH0x60 mm	7
	PH1x80-PH2x100 mm	6
	PH3x150	4

Présentoir vide
1263/EV78 CHF 149.00 1 012630511

1263/E74

Présentoir avec 74 tournevis



495x260x310 mm

Présentoir avec composition
1263/E74 CHF 756.00 1 012630540

Code	Description	Quantité
1264	2,5x60 mm	7
	3x75 mm	3
	3x100 - 4x100 mm	4
	4x125 - 5x150 mm	2
	5x125 - 6,5x150 mm	4
1262	PH 8x150	3
	PH 3x60 - 3x100 mm	7
	PH 4,5x80 - 4,5x120 mm	6
	PH 6x100 mm	10
	PH 6x150 mm	5

Présentoir vide
1263/EV74 CHF 149.00 1 012630541

1263/E85

Présentoir mural
avec 85 tournevis



495x260x377 mm

Présentoir
avec composition
1263/E85

CHF
900.00



1

012630550

	n.
● 1260 2,5x50 mm	7
2,5x75 mm	6
3x75 - 3x100 - 3,5x100 mm	7
4x100 - 4x125 - 5,5x125	6
5,5x150 - 6,5x150 mm	4
8x150 mm	4
● 1260E 10x200 mm	3
12x250 mm	2
4x30 - 6,5x30 mm	6

Présentoir
vide
1263/EV85

CHF
149.00



1

012630551

1263/E70

Présentoir mural
avec 70 tournevis



495x260x327 mm

Présentoir
avec composition
1263/E70

CHF
887.00



1

012630560

	n.
⊕ 1262 PH0x60 - PH0x100 mm	7
PH1x80 - PH1x120 mm	6
PH2x100 mm	9
PH2x150 - PH3x150 mm	5
PH4x200 mm	4
⊕ 1262E PH2x150 mm	5
PH3x175 mm	4
⊕ 1262N PH1x30 - PH2x30 mm	6

Présentoir
vide
1263/EV70

CHF
149.00



1

012630561

1263/E50

Présentoir mural
avec 50 tournevis



330x260x269 mm

Présentoir
avec composition
1263/E50

CHF
465.00



1

012630570

	n.
● 1264 2,5x60 - 3x75 - 3x100 mm	7
4x100 - 4x125 - 5x125 - 5x150 mm	6
6,5x150 mm	5

Présentoir
vide
1263/EV50

CHF
129.00



1

012630571

1263/E62

Présentoir mural
avec 62 tournevis



495x260x257 mm

Présentoir
avec composition
1263/E62

CHF
857.00



1

012630590

	n.
⊕ 1267TX T5	5
T6	6
T7	5
T8	6
T9	5
T10 - T15 - T20	6
T25	5
T27 - T30	4
T40 - T45	2

Présentoir
vide
1263/EV62

CHF
149.00



1

012630591

1263/E39

Présentoir mural
avec 39 tournevis



330x260x257 mm

Présentoir
avec composition
1263/E39

CHF
606.00



1

012630595

	n.
⊕ 1268RTX T9x60 - T10x80 - T15x80	6
T20x100 - T25x100 mm	4
T27x115 mm	3
T30x115 mm	3
T40x130 mm	2

Présentoir
vide
1263/EV39

CHF
129.00



1

012630596

1263/E40

Présentoir mural
avec 40 tournevis



330x260x327 mm

Présentoir
avec composition
1263/E40

CHF
538.00



1

012630580

	n.
⊕ 1269 PZ0x60 mm	7
PZ1x80 mm	6
PZ2x100 - PZ3x150 - PZ4x200 mm	5
⊕ 1269N PZ1x30 - PZ2x30 mm	6

Présentoir
vide
1263/EV40

CHF
129.00



1

012630581

1273MQ/E1

Présentoir mural avec 40 tournevis



△ 1000 V ⚡

330x260x332 mm

Présentoir avec composition
1273MQ/E1 **CHF 683.00** 1 012730312

	n.
➕ 1272MQ PH0x60 - PH1x80 mm	5
PH2x100 mm	3
PH3x150 mm	2
● 1274MQ 3x100 - 4x100 - 5,5x125 - 6,5x150 mm	5
8x175 mm	3
10x200 mm	2

Présentoir vide
1273BG-MQ/DV **CHF 129.00** 1 012730651

1273MQ/E4

écran mural avec 43 tournevis



△ 1000 V ⚡

330x260x332 mm

Présentoir avec composition
1273MQ/E4 **CHF 928.00** 1 012730315

➕ 1272MQF 4,5x80 - 6x100 mm	3
● 1274MQF 3,5x100 - 4,5x100 - 5,5x125 - 6,5x150 mm	3
➕ 1275MQ/C 4,5x80 - 6x100 mm	5
➕ 1276MQ/C 4,5x80 - 6x100 mm	5
➕ 1279MQ/F 4,5x80 mm	3
6x100 mm	2

Présentoir vide
1273BG-MQ/DV4 **CHF 129.00** 1 012730655

1293BX/DA

Présentoir mural avec 90 tournevis



495x260x332 mm

Présentoir avec composition
1293BX/DA **CHF 1,205.00** 1 012930701

● 1290 3x75 - 3,5x100 - 4x100 - 4x125 5,5x100 - 5,5x150 mm 6,5x150 mm	7 6 3
8x150 mm	3
10x200 mm	2
● 1290N 4x30 - 6,5x30 mm	3
➕ 1292 PH0x60 - PH1x80 mm	7
PH2x100 mm	6
PH3x150 mm	5
➕ 1292N PH1x30 - PH2x30 mm	3

Présentoir vide
1293BX/DVA **CHF 149.50** 1 012930751

1293BX/DD

Présentoir mural avec 48 tournevis



330x260x332 mm

Présentoir avec composition
1293BX/DD **CHF 570.00** 1 012930704

● 1294 2,5x60 - 3x75 - 3x100 - 4x100 4x150 - 5x125 mm 6,5x150 mm	7 6
--	--------

Présentoir vide
1293BX/DVD **CHF 130.00** 1 012930754

1293BX/DE

Présentoir mural avec 42 tournevis



330x260x332 mm

Présentoir avec composition
1293BX/DE **CHF 851.00** 1 012930705

➕ 1299PZ PZ0x60 - PZ1x80 mm	7
PZ2x100 mm	6
PZ3x150 - PZ4x200 mm	5
➕ 1299N/PZ PZ1x30 - PZ2x30 mm	6

Présentoir vide
1293BX/DVE **CHF 130.00** 1 012930755

1293BX/DF

Présentoir mural avec 59 tournevis



330x260x332 mm

Présentoir avec composition
1293BX/DF **CHF 1,126.00** 1 012930706

● 1297TX T6 - T8 - T10 - T15 - T20 - T25 T27 - T30	7 6
T40	5

Présentoir vide
1293BX/DVF **CHF 130.00** 1 012930756

C68

Présentoir mural, vide



1000x560x2200 mm

		CHF		
C68/1	1 m	2,770.00	1	068000001
C68/2	2 m	4,820.00	1	068000002
C68/3	3 m	6,880.00	1	068000003
C68/4	4 m	8,940.00	1	068000004
C68/5	5 m	10,990.00	1	068000005
C68/6	6 m	13,040.00	1	068000006
C68/7	7 m	15,100.00	1	068000007
C68/8	8 m	17,160.00	1	068000008
C68/9	9 m	19,210.00	1	068000009
C68/10	10 m	21,270.00	1	068000010

C68N

Présentoir mural Beta, vide



1000x560x2200 mm

		CHF		
C68N/1	1 m	2,385.00	1	068000031
C68N/2	2 m	4,440.00	1	068000032
C68N/3	3 m	6,500.00	1	068000033
C68N/4	4 m	8,560.00	1	068000034
C68N/5	5 m	10,600.00	1	068000035
C68N/6	6 m	12,660.00	1	068000036
C68N/7	7 m	14,720.00	1	068000037
C68N/8	8 m	16,780.00	1	068000038
C68N/9	9 m	18,820.00	1	068000039
C68N/10	10 m	20,880.00	1	068000040

C68 G

Présentoir gondole vide



1000x1120x1600 mm

		CHF		
C68G/1	1 m	2,520.00	1	068000051
C68G/2	2 m	4,650.00	1	068000052
C68G/3	3 m	6,770.00	1	068000053
C68G/4	4 m	8,890.00	1	068000054

C88 R/1

Présentoir mural Robur, vide



1000x560x2200 mm

		CHF		
C88R/1	1 m	2,770.00	1	088000001

C88NR/1

Présentoir mural Robur, vide



1000x560x2200 mm

		CHF		
C88NR/1	1 m	2,385.00	1	088000031

C88VE

Plateau d'exposition pour présentoir mural C88

Apte au rangement de rouleaux de chaîne art. 8120



		CHF		
C88VE		296.00	1	088000120

C88SE

Présentoir pour bobines chaîne type "Genovese"



		CHF		
C88SE		714.00	1	088000130

1700x600x600 mm



6888

Crochets pour présentoirs
C60 - C61 - C68 - C88

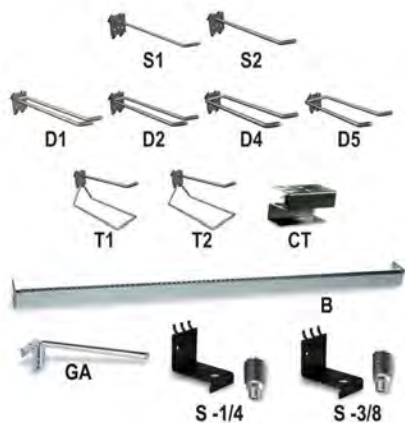

	CHF		
6888S1	5.70	10	068880011
6888S2	5.70	10	068880012
6888D1	9.00	5	068880021
6888D2	9.00	5	068880022
6888D4	9.25	5	068880024
6888D5	9.25	5	068880025
6888T1	12.80	5	068880031
6888T2	12.80	5	068880032
6888CT	24.10	1	068880044
6888B	85.50	1	068880100
6888GA	28.00	3	068880120
6888S-1/4	51.50	1	068880605
6888S-3/8	51.50	1	068880610

6800 VE

Vitrine pour paroi d'exposition C68 et C68 R/1

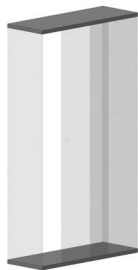

	CHF		
6800VE/1 1 m	1,380.00	1	068000401
6800VE/2 2 m	2,110.00	1	068000402
6800VE/3 3 m	2,830.00	1	068000403
6800VE/4 4 m	3,560.00	1	068000404
6800VE/5 5 m	4,290.00	1	068000405



	CHF		
6800AE	276.00	1	068000145
6800AI	570.00	1	068000140
6800AD/P	970.00	1	068000143



	CHF		
6800CB/100	319.00	1	068000104
6800FB/100	112.00	1	068000109
6800FO/100	77.00	1	068000108
6800PL	324.00	1	068000137
6800RP/100	102.50	1	068000150
6800GR/37	43.50	1	068000159



	CHF		
6800PM/40	102.50	1	068000171
6800PM/80	138.00	1	068000172

6600 M/14

Composition de 154 outils,
avec crochets sans panneau



	CHF		
6600 M/14	3,020.00	1	066000014

6600 M/22

Composition de 108 outils,
avec crochets sans panneau



	CHF		
6600 M/22	2,045.00	1	066000022

6600 M/27

Composition de 25 outils,
avec crochets sans panneau



	CHF		
6600 M/27	1,425.00	1	066000027

6600 M/29

Composition de 173 outils,
avec crochets sans panneau

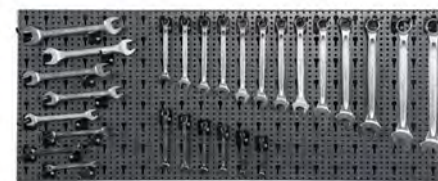

	CHF		
6600 M/29	2,670.00	1	066000029

6600 M/33

Composition de 37 outils, avec crochets sans
panneau



	CHF		
6600 M/33	2,275.00	1	066000033

6600 M/40

Composition de 100 outils,
avec crochets sans panneau



6600 M/40 CHF 3,390.00 1 066000040

6600 M/42

Composition de 65 outils,
avec crochets sans panneau



6600 M/42 CHF 2,180.00 1 066000042

6600 M/44

Composition de 48 outils,
avec crochets sans panneau

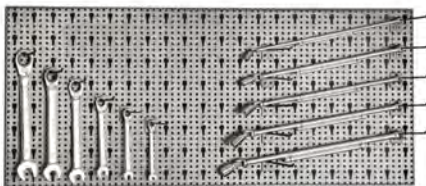

6600 M/44 CHF 1,890.00 1 066000044

6600 M/47

Composition de 65 outils,
avec crochets sans panneau



6600 M/47 CHF 2,025.00 1 066000047

6600 M/51

Composition de 257 outils,
avec crochets sans panneau



6600 M/51 CHF 3,610.00 1 066000051

6600 M/52

Composition de 176 outils,
avec crochets sans panneau



6600 M/52 CHF 2,355.00 1 066000052

6600 M/58

Composition de 150 outils,
avec crochets sans panneau



6600 M/58 CHF 2,560.00 1 066000058

6600 M/59

Composition de 220 outils,
avec crochets sans panneau



6600 M/59 CHF 2,730.00 1 066000059

6600 M/61

Composition de 71 outils,
avec crochets sans panneau

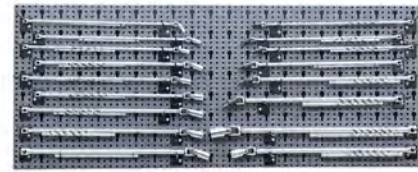

6600 M/61 CHF 3,260.00 1 066000061

6600 M/62

Composition de 28 outils,
avec crochets sans panneau



6600 M/62 CHF 766.00 1 066000062

6600 M/63

Composition de 110 outils,
avec crochets sans panneau

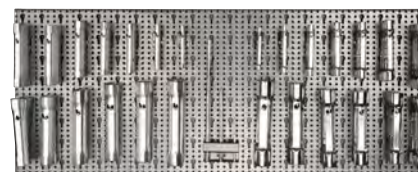

6600 M/63 CHF 2,960.00 1 066000063

6600 M/73

Composition de 68 outils,
avec crochets sans panneau

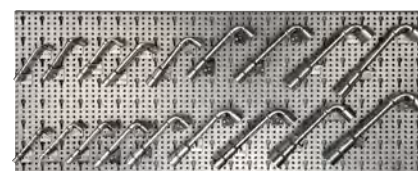

6600 M/73 CHF 1,935.00 1 066000073

6600 M/112

Composition de 329 outils,
avec crochets sans panneau



6600 M/112 CHF 3,190.00 1 066000112

6600 M/116

Composition de 306 outils,
avec crochets sans panneau



6600 M/116 CHF 2,980.00 1 066000116

6600 M/120

Composition de 163 outils,
avec crochets sans panneau



6600 M/120 CHF 2,155.00 1 066000120

6600 M/125

Composition de 133 outils,
avec crochets sans panneau



6600 M/125 CHF 1,860.00 1 066000125

6600 M/126

Composition de 58 outils,
avec crochets sans panneau



6600 M/126 CHF 1,147.00 1 066000126

6600 M/131

Composition de 92 outils,
avec crochets sans panneau



6600 M/131 CHF 3,560.00 1 066000131

6600 M/174

Composition de 13 outils, avec crochets sans
panneau



6600 M/174 CHF 5,410.00 1 066000174

6600 M/175

Composition de 12 outils,
avec crochets sans panneau



6600 M/175 CHF 3,910.00 1 066000175

6600 M/217

Composition de 74 outils,
avec crochets sans panneau



6600 M/217 CHF 3,520.00 1 066000217

6600 M/218

Composition de 58 outils,
avec crochets sans panneau



6600 M/218 CHF 1,860.00 1 066000218

6600 M/222

Composition de 74 outils,
avec crochets sans panneau

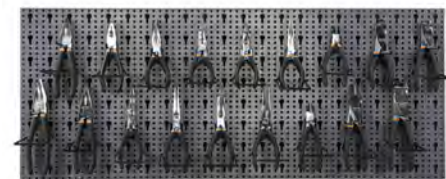

6600 M/222 CHF 2,860.00 1 066000222

6600 M/223

Composition de 58 outils,
avec crochets sans panneau



6600 M/223 CHF 2,430.00 1 066000223

INDUSTRIAL
FINISHING

6600 M/230

Composition de 78 outils,
avec crochets sans panneau



6600 M/230 CHF 3,120.00 1 066000230

6600 M/236

Composition de 31 outils,
avec crochets sans panneau



6600 M/236 CHF 1,760.00 1 066000236

6600 M/241

Composition de 43 outils,
avec crochets sans panneau



6600 M/241 CHF 1,510.00 1 066000241

6600 M/242

Composition de 91 outils,
avec crochets sans panneau



6600 M/242 CHF 3,610.00 1 066000242

6600 M/253

Composition de 60 outils,
avec crochets sans panneau



6600 M/253 CHF 2,520.00 1 066000253

6600 M/311

Composition de 114 outils,
avec crochets sans panneau



6600 M/311 CHF 1,535.00 1 066000311

6600 M/315

Composition de 149 outils,
avec crochets sans panneau



6600 M/315 CHF 2,550.00 1 066000315

6600 M/320

Composition de 98 outils,
avec crochets sans panneau



6600 M/320 CHF 2,215.00 1 066000320

6600 M/326

Composition de 155 outils,
avec crochets sans panneau



6600 M/326 CHF 1,785.00 1 066000326

6600 M/327

Composition de 101 outils,
avec crochets sans panneau



6600 M/327 CHF 1,465.00 1 066000327

6600 M/330

Composition de 110 outils,
avec crochets sans panneau



6600 M/330 CHF 1,200.00 1 066000330

6600 M/371

Composition de 162 outils,
avec crochets sans panneau



6600 M/371 CHF 1,450.00 1 066000371

6600 M/380

assortiment de 71 outils, avec crochets sans panneau



6600 M/380 CHF 931.00 1 066000380

6600 M/406

Composition de 107 outils, avec crochets sans panneau



6600 M/406 CHF 1,560.00 1 066000406

6600 M/417

Composition de 43 outils, avec crochets sans panneau



6600 M/417 CHF 1,350.00 1 066000417

6600 M/423

Composition de 30 outils, avec crochets sans panneau



6600 M/423 CHF 1,340.00 1 066000423

6600 M/424

Composition de 36 outils, avec crochets sans panneau



6600 M/424 CHF 1,430.00 1 066000424

6600 M/427

Composition de 24 outils, avec crochets sans panneau



6600 M/427 CHF 1,460.00 1 066000427

6600 M/430

Composition de 29 outils, avec crochets sans panneau



6600 M/430 CHF 1,425.00 1 066000430

6600 M/440

Composition de 140 outils, avec crochets sans panneau

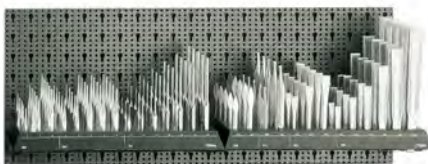

6600 M/440 CHF 2,690.00 1 066000440

6600 M/456

Composition de 41 outils, avec crochets sans panneau



6600 M/456 CHF 1,930.00 1 066000456

6600 M/465

Composition de 36 outils, avec crochets sans panneau



6600 M/465 CHF 2,465.00 1 066000465

6600 M/480

Composition de 18 outils, avec crochets sans panneau



6600 M/480 CHF 1,555.00 1 066000480

6600 M/485

Composition de 12 outils, avec crochets sans panneau



6600 M/485 CHF 1,121.00 1 066000485

6600 M/510

Composition de 16 outils,
avec crochets sans panneau



6600 M/510 CHF 1,545.00 1 066000510

6600 M/532

Composition de 24 outils,
avec crochets sans panneau



6600 M/532 CHF 1,260.00 1 066000532

6600 M/534

Composition de 51 outils,
avec crochets sans panneau



6600 M/534 CHF 2,015.00 1 066000534

6600 M/542

Composition de 53 outils,
avec crochets sans panneau



6600 M/542 CHF 1,250.00 1 066000542

6600 M/548

Composition de 37 outils,
avec crochets sans panneau



6600 M/548 CHF 1,142.00 1 066000548

6600 M/561

Composition de 60 outils,
avec crochets sans panneau



6600 M/561 CHF 1,645.00 1 066000561

6600 M/583

Composition de 22 outils,
avec crochets sans panneau



6600 M/583 CHF 1,146.00 1 066000583

6600 M/643

assortiment de 90 outils, avec crochets sans
panneau



6600 M/643 CHF 2,760.00 1 066000643

6600 M/650

Composition de 28 outils,
avec crochets sans panneau



6600 M/650 CHF 3,370.00 1 066000650

6600 M/657

Composition de 17 outils,
avec crochets sans panneau



6600 M/657 CHF 2,730.00 1 066000657

6600 M/658

Composition de 14 outils,
avec crochets sans panneau

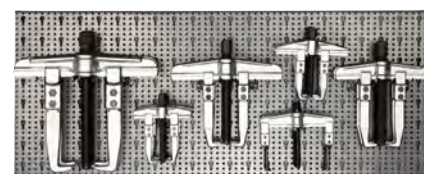

6600 M/658 CHF 3,060.00 1 066000658



6600 M/716

Composition de 64 outils, avec crochets sans panneau



6600 M/716 CHF 3,320.00 1 066000716

6600 M/813

Composition de 25 outils, avec crochets sans panneau



6600 M/813 CHF 1,555.00 1 066000813

6600 M/842

Composition de 36 outils, avec crochets sans panneau



6600 M/842 CHF 2,020.00 1 066000842

6600 M/852

Composition de 560 disques abrasifs rigides, avec crochets sans panneau



6600 M/852 CHF 1,955.00 1 066000852

6600 M/856

Composition de 560 disques abrasifs rigides, avec crochets sans panneau



6600 M/856 CHF 2,050.00 1 066000856

6600 M/857

Composition de 560 disques abrasifs rigides, avec crochets sans panneau



6600 M/857 CHF 2,155.00 1 066000857

6600 M/871

Composition de 120 abrasifs avec crochets sans panneau



6600 M/871 CHF 875.00 1 066000871

6600 M/878

Composition de 100 abrasifs avec crochets sans panneau



6600 M/878 CHF 822.00 1 066000878

6600 M/881

Composition de 410 abrasifs avec plateau d'exposition



6600 M/881 CHF 2,430.00 1 066000881

Robur

8600 R/11

Composition de 374 accessoires pour câbles, avec crochets sans panneau



8600 R/11 CHF 2,140.00 1 086000011

8600 R/12

Composition de 259 accessoires pour câbles, avec crochets sans panneau

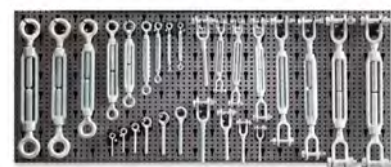

8600 R/12 CHF 2,090.00 1 086000012



8600 R/13

Composition de 230 accessoires pour câbles, avec crochets sans panneau



8600 R/13 CHF 1,765.00 1 086000013

8600 R/113

Composition de 1862 accessoires pour câbles, avec crochets sans panneau



8600 R/113 CHF 2,465.00 1 086000113

8600 R/114

Composition de 1045 accessoires pour câbles, avec crochets sans panneau



8600 R/114 CHF 2,430.00 1 086000114

8600 R/225

Composition de 64 accessoires GRADE 8 avec crochets sans panneau



8600 R/225 CHF 1,660.00 1 086000225

8600 R/412

Composition de 348 accessoires inoxydables pour câbles, avec crochets sans panneau

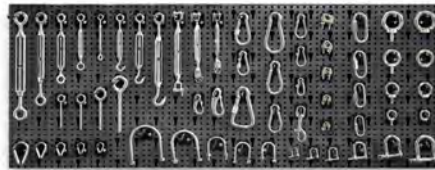

8600 R/412 CHF 2,450.00 1 086000412

8600 R/511

Assortiment de 11 bobines chaîne type "Genovese" avec plateau d'exposition



8600 R/511 CHF 2,040.00 1 086000511

8600 R/601

Composition de 50 cliquets d'arrimage avec grilles, rayon et crochets sans panneau



8600 R/601 CHF 1,345.00 1 086000601
C88/R601 399.00 1 088000160

8600 R/611

Assortiment de 52 sangles de levage avec grilles, sans panneau



8600 R/611 CHF 1,066.00 1 086000611
C88/R611 233.00 1 088000161

Beta

CHAUSSURES DE PROTECTION

LEGENDA



Avec semelle intérieure anti-perforation



Avec embout



Chaussures antistatiques



Absorption d'énergie au niveau du talon



Semelle extérieure résistante aux huiles, aux hydrocarbures et aux solvants



Semelle extérieure antidérapante



Résistance à la flexion répétée > 60 000



Semelle extérieure résistante à la chaleur (300 °C/min.)



Chaussures non magnétiques, sans aucunes pièces métalliques



Chaussures développées pour assurer une dissipation constante des charges électrostatiques du corps de l'utilisateur vers le sol



Chaussures large (Taille 11) permettant un confort optimal pour les pieds larges



Chaussures permettant l'isolation contre le froid (-20 °C)

AVERTISSEMENTS

Avant l'emploi, vérifier que les chaussures correspondent aux exigences d'utilisation et que la catégorie de protection soit correcte en fonction du type et du lieu de travail. Les chaussures fabriquées par Beta Utensili sont conformes aux NORMES EUROPÉENNES en vigueur. La loi responsabilise l'employeur quant à la conformité des EPI par rapport au type de risque présent (caractéristiques des EPI et catégorie d'appartenance).

OBSOLESCENCE

En raison de nombreux facteurs (humidité lors du stockage et modification de la structure des matériaux dans le temps), il n'est pas possible d'établir avec certitude la durée de stockage de la chaussure. En général, pour les chaussures entièrement en polyuréthane ou avec un fond en polyuréthane, une durée maximale de trois ans à compter de la date de fabrication peut être supposée. Pour les chaussures entièrement en PVC, une durée de cinq ans à compter de la date de fabrication peut être supposée, tandis que pour les chaussures à tige en cuir, les chaussures en caoutchouc, en matière thermoplastique et en EVA, une durée maximale de dix ans à compter de la date de fabrication peut être envisagée. Ce délai fait référence à des chaussures neuves, emballées et stockées dans des conditions contrôlées, évitant les fortes différences de température et d'humidité relative.

NORMES EUROPÉENNES ET SIGNIFICATION EN ISO 20345:2011 - EN ISO 20347:2012

CONFORMITÉ À LA NORME EN ISO 20345:2011

La norme spécifie les exigences fondamentales et additionnelles (optionnelles) pour les chaussures de sécurité d'usage général. Les chaussures conformes à la norme EN ISO 20345:2011 sont marquées de la lettre "S" (Safety = Sécurité) dont l'embout peut résister à 200 Joules.

CONFORMITÉ À LA NORME EN ISO 20347:2012

La norme spécifie les exigences fondamentales et additionnelles (facultatives) relatives aux chaussures de travail qui n'exigent pas de protection contre les risques mécaniques (choc ou écrasement). Les chaussures conformes à la norme EN ISO 20347:2012 portent la lettre "O" (Occupational = Professionnel). Leurs caractéristiques sont semblables à celles des chaussures précédemment indiquées, les seules différences sont l'absence de l'embout de protection et de la semelle anti-perforation.

En sus des exigences fondamentales obligatoires au sens de la norme EN ISO 20345:2011, les chaussures peuvent également répondre à des exigences additionnelles. Ces exigences doivent être identifiées par des symboles ou classes et reportées sur l'étiquette apposée sur la languette de la chaussure.

NORMES EUROPÉENNES ET SIGNIFICATION EN ISO 20345:2022 - EN ISO 20347:2022

CONFORMITÉ À LA NORME EN ISO 20345:2022

La norme spécifie les exigences fondamentales et additionnelles (optionnelles) pour les chaussures de sécurité d'usage général. Les chaussures conformes à la norme EN ISO 20345:2011 sont marquées de la lettre "S" (Safety = Sécurité) dont l'embout peut résister à 200 Joules.

CONFORMITÉ À LA NORME EN ISO 20347:2022

La norme spécifie les exigences fondamentales et additionnelles (facultatives) relatives aux chaussures de travail qui n'exigent pas de protection contre les risques mécaniques (choc ou écrasement). Les chaussures conformes à la norme EN ISO 20347:2012 portent la lettre "O" (Occupational = Professionnel). Leurs caractéristiques sont semblables à celles des chaussures précédemment indiquées, les seules différences sont l'absence de l'embout de protection et de la semelle anti-perforation.

En sus des exigences fondamentales obligatoires au sens de la norme EN ISO 20345:2011, les chaussures peuvent également répondre à des exigences additionnelles. Ces exigences doivent être identifiées par des symboles ou classes et reportées sur l'étiquette apposée sur la languette de la chaussure.

Informations pour les chaussures avec insert anti-perforation

La résistance à la perforation de cette chaussure a été mesurée en laboratoire à l'aide de pointes et de force standardisés. Des pointes de plus petit diamètre et des charges statiques ou dynamiques plus élevées augmentent le risque de perforation. Dans de telles circonstances, des mesures préventives supplémentaires doivent être envisagées. Trois types différents d'inserts résistants à la perforation sont actuellement disponibles pour les chaussures EPI. Il peut s'agir d'inserts métalliques et non métalliques, à choisir sur la base d'une évaluation des risques liés au type de travail. Tous les inserts offrent une protection contre le risque de perforation, mais chacun d'entre eux présente plusieurs avantages ou inconvénients supplémentaires, en particulier :

- **Insert anti-perforation métallique** : la résistance à la perforation est moins concernée par la forme de l'objet coupant (par exemple le diamètre, la géométrie ou la forme pointue), mais en raison des limitations des dimensions nécessaires à la production de la chaussure, la résistance ne couvre pas toute la surface de la partie inférieure de la chaussure.
- **Insert anti-perforation non métallique (PL)** : il peut être plus léger, plus flexible et offrir une plus grande surface de couverture par rapport au métal, mais la résistance à la perforation peut varier davantage en fonction de la forme de l'objet coupant (par exemple le diamètre, la géométrie ou forme pointue).

CLASSIFICATION

I = Chaussures en cuir et autres matériaux, à l'exception du caoutchouc ou matériau polymère

II = Chaussures entièrement en caoutchouc ou entièrement polymère (bottes)

EXIGENCES DE BASE

- **Chaussure complète** : hauteur de la tige ; zone du talon ; performances de fabrication de la semelle (fabrication et résistance au décollement de la tige/semelle) ; caractéristiques de protection des doigts de pied et de l'embout (sauf EN ISO 20347), propriétés antidérapantes.
- **Tige** : caractéristiques des matériaux de la tige, doublure, languette, première de propreté (résistance à la déchirure, à l'abrasion, caractéristiques de traction, perméabilité à la vapeur d'eau, pH, absorption et désorption pour la première de propreté et la semelle intérieure).
- **Semelle** : construction et résistance à la déchirure, à l'abrasion, à la flexion, à l'hydrolyse, au décollement des semelles et aux huiles hydrocarbonées.

CLASSE DE PROTECTION	EN ISO 20345:2011				EN ISO 20347:2012				EN ISO 20345:2011		EN ISO 20347:2012		VALEURS MINIMALES REQUISES	
	SB	S1	S2	S3	OB	O1	O2	O3	S4	S5	O4	O5		
	Zone du talon fermée	0	X	X	X	0	X	X	X	X	X	X	X	
	Résistance au choc de l'embout 200 Joules	X	X	X	X	-	-	-	-	X	X	-	-	
A	Chaussures antistatiques	0	X	X	X	0	X	X	X	X	X	X	X	Résistance électrique > 100 kΩ, ≤ 1000 MΩ
E	Absorption d'énergie dans la zone du talon	0	X	X	X	0	X	X	X	X	X	X	X	> 20 Joules
WRU	Tige résistante à la pénétration et à l'absorption d'eau	0	-	X	X	0	-	X	X	-	-	-	-	Pénétration: < 0,2 g x 60 mn Absorption : < 30% x 60 mn
P	Résistance de la semelle à la perforation	0	0	-	X	0	0	-	X	0	X	0	X	> 1100 N
CI	Isolation contre le froid	0	0	0	0	0	0	0	0	0	0	0	0	Réduction temp. surface interne semelle : < 10° C
HI	Isolation contre la chaleur	0	0	0	0	0	0	0	0	0	0	0	0	Augmentation temp. surface interne semelle : < 22° C
HRO	Résistance de la semelle à la chaleur par contact	0	0	0	0	0	0	0	0	0	0	0	0	Résistant jusqu'à 300 °C
WR	Chaussure résistante à l'eau	0	0	0	0	0	0	0	0	-	-	-	-	Absorption : < 3 cm²
FO	Résistance de la semelle aux hydrocarbures	0	X	X	X	0	0	0	0	X	X	0	0	Augmentation du volume de la semelle < 12 %
SRC	Résistance de la semelle à la glisse	X	X	X	X	X	X	X	X					Exigence SRA + SRB

X	Exigence obligatoire de la catégorie de protection
O	Exigence facultative associée aux exigences obligatoires, si indiqué par le marquage
-	Exigence non obligatoire , contrôler le marquage de la chaussure

Chaussures antistatiques :

Les chaussures antistatiques doivent être utilisées en cas de nécessité de réduire au minimum l'accumulation de charges électrostatiques de sorte à exclure le risque de combustion de substances inflammables et de vapeurs et si persiste le risque de secousses électriques provenant d'éléments sous tension. Les chaussures antistatiques ne protègent pas contre le choc électrique car elles procurent uniquement une résistance électrique entre le sol et le pied. Si les risques de choc électrique ne peuvent pas être complètement exclus, il sera nécessaire d'adopter des précautions supplémentaires à planifier selon un programme périodique de prévention des accidents du travail. Afin de préserver les propriétés antistatiques, les chaussures ne devront pas subir de modifications.

Chaussures isolantes contre le risque électrique

Les chaussures isolantes contre le risque électrique apportent une protection électrique contre les contacts accidentels jusqu'à 1000 V sous réserve que les conditions d'utilisation ne devront pas modifier ou altérer la résistance électrique avec l'influence de l'humidité. Il est précisé que la résistance électrique se réfère uniquement au fond de la chaussure et non pas à la tige.

Classes électriques des chaussures :

Classe 00 500V CA ou 750V CC

Classe 0 1000V CA ou 1500V CC

Chaussures dissipatives pour les milieux EPA :

Les chaussures dissipatives sont conçues pour les milieux EPA (ESDS) et permettent aux charges électrostatiques présentes sur le corps d'être dissipées de manière continue et contrôlée, de sorte à protéger les composants et les dispositifs électroniques contre les phénomènes électrostatiques. La valeur de référence de la résistance au sol selon CEI EN 61340-5-1: 2016, pour la personne qui la porte / chaussures / sol, se situe entre < 1 × 10⁹ Ω.

CLASSIFICATION

I = Chaussures en cuir et autres matériaux, à l'exception du caoutchouc ou matériau polymère

II = Chaussures entièrement en caoutchouc ou entièrement polymère (bottes)

EXIGENCES DE BASE

- **Chaussure complète** : hauteur de la tige ; zone du talon ; performances de fabrication de la semelle (fabrication et résistance au décollement de la tige/semelle) ; caractéristiques de protection des doigts de pied et de l'embout (sauf EN ISO 20347), propriétés antidérapantes.
- **Tige** : caractéristiques des matériaux de la tige, doublure, languette, première de propreté (résistance à la déchirure, à l'abrasion, caractéristiques de traction, perméabilité à la vapeur d'eau, pH, absorption et désorption pour la première de propreté et la semelle intérieure).
- **Semelle** : construction et résistance à la déchirure, à l'abrasion, à la flexion, à l'hydrolyse, au décollement des semelles et aux huiles hydrocarbonées.

CLASSE DE PROTECTION	EN ISO 20345:2022											EN ISO 20347:2022						VALEURS MINIMALES REQUISES
	SB	S1	S2	S3	S3L	S3S	S6	S7	S7L	S7S	OB	O1	O2	O3	O3L	O3S		
Classe	I o II	I	I	I	I	I	I	I	I	I	I o II	I	I	I	I	I		
Zone du talon fermée	0	X	X	X	X	X	X	X	X	X	0	X	X	X	X	X		
Résistance aux chocs de l'embout 200 Joules	X	X	X	X	X	X	X	X	X	X	-	-	-	-	-	-		
Semelle crantée	0	0	0	X	X	X	0	X	X	X	0	0	0	X	X	X		
P Résistance de la semelle à la perforation (avec un embout métallique P)	0	0	0	X	-	-	0	X	-	-	0	0	0	X	-	-	Force de perforation ≥ 1100 N	
PL Résistance de la semelle à la perforation (embout non métallique, test avec pointe large Ø 4,5 mm)	0	0	0	-	X	-	0	-	X	-	0	0	0	-	X	-		
PS Résistance de la semelle à la perforation (embout non métallique, test avec pointe fine Ø 3,0 mm)	0	0	0	-	-	X	0	-	-	X	0	0	0	-	-	X		
A Chaussures antistatiques	0	X	X	X	X	X	X	X	X	X	0	X	X	X	X	X	Résistance électrique > 100 kΩ ≤ 1000 kΩ	
HI Isolation thermique contre la chaleur continue de l'ensemble de la semelle intérieure	0	0	0	0	0	0	0	0	0	0	0	0	0	0	0	0	Augmentation T ≤ 22 °C en cas de positionnement sur une plaque avec T de 150 °C pendant 30'	
CI Isolation thermique contre le froid de l'ensemble de la semelle intérieure	0	0	0	0	0	0	0	0	0	0	0	0	0	0	0	0	Diminution T ≤ 10 °C en environnement à -17 °C pendant 30'	
E Absorption d'énergie dans la zone du talon	0	X	X	X	X	X	X	X	X	X	0	X	X	X	X	X	> 20 Joules	
WR Résistance à l'eau	0	0	0	0	0	0	X	X	X	X	0	0	0	0	0	0	Aucune pénétration de l'eau	
SC Résistance à l'abrasion des pare-pierres	0	0	0	0	0	0	0	0	0	0	0	0	0	0	0	0	Aucun trou sur toute l'épaisseur après 8.000 cycles	
SR Résistance au glissement sur sol en céramique avec glycérine	X	X	X	X	X	X	X	X	X	X	X	X	X	X	X	X	Test sur sol en céramique avec glycérine.	
WPA Résistance à l'eau des matériaux de la tige	0	0	X	X	X	X	-	-	-	-	0	0	X	X	X	X	Absorption de l'eau après 60' ≤ 30 %	
HRO Résistance à la chaleur de la semelle extérieure	0	0	0	0	0	0	0	0	0	0	0	0	0	0	0	0	Contact à 300 °C pendant 60'' - ne fond pas	
FO Résistance aux hydrocarbures	0	0	0	0	0	0	0	0	0	0	0	0	0	0	0	0	Augmentation du volume de l'échantillon de semelle < 12 %	
LG Adhérence de grip talon décroché	0	0	0	0	0	0	0	0	0	0	0	0	0	0	0	0	Largeur de la zone centrale de la semelle > 35 mm	

X	Exigence obligatoire de la catégorie de protection
O	Exigence facultative associée aux exigences obligatoires, si indiqué par le marquage
-	Exigence non obligatoire , contrôler le marquage de la chaussure

Chaussures partiellement conductrices



Des chaussures partiellement conductrices doivent être utilisées s'il est nécessaire de minimiser les charges électrostatiques dans les plus brefs délais, par exemple lors de la manipulation d'explosifs.

Elles ne doivent pas être utilisées si le risque d'électrocution d'équipements électriques ou de pièces sous tension à tension alternative ou continue n'a pas été complètement éliminé. Pour s'assurer que cette chaussure est partiellement conductrice, il est indiqué que la limite supérieure de résistance est de 100 kΩ à l'état neuf.

Chaussures antistatiques :

Les chaussures antistatiques doivent être utilisées en cas de nécessité de réduire au minimum l'accumulation de charges électrostatiques de sorte à exclure le risque de combustion de substances inflammables et de vapeurs et si persiste le risque de secousses électriques provenant d'éléments sous tension. Les chaussures antistatiques ne protègent pas contre le choc électrique car elles procurent uniquement une résistance électrique entre le sol et le pied. Si les risques de choc électrique ne peuvent pas être complètement exclus, il sera nécessaire d'adopter des précautions supplémentaires à planifier selon un programme périodique de prévention des accidents du travail. Afin de préserver les propriétés antistatiques, les chaussures ne devront pas subir de modifications.

NB Toutes les chaussures certifiées avec les anciennes normes maintiennent la validité du certificat jusqu'à son échéance.

EN ISO 20345:2011		S1P SRC									
LIGNE	ARTICLE	CONDITIONS REQUISES				SECTEURS PRÉCONISÉS					📄
		ADDITIONAL REQUIREMENTS			SECTEUR AUTOMOBILE	CONSTRUCTION EN BÂTIMENT	ÉLECTRICITÉ	INDUSTRIE	LOGISTIQUE SERVICES	PLOMBERIE	
FLEX 	7212G	ESD	X	X	X	X	X	X	X	X	635
	7212B	ESD	X	X	X	X	X	X	X	X	634
	7213G	ESD	X	X	X	X	X	X	X	X	635
EASY PLUS 	7222PEK		X	X	X	X	X	X	X	X	633
	7223PEK		X	X	X	X	X	X	X	X	633
BASIC 	7241BK				X	X	X	X	X	X	630
	7243BK				X	X	X	X	X	X	630
	7246BK				X	X	X	X	X	X	632
	7247BK				X	X	X	X	X	X	632
EASY 	7246E				X		X	X	X	X	629
TREKKING 	7249GK	RS			X		X		X	X	638
ACTIVE 	7314AF			X	X	X	X	X	X	X	639
	7316NB	ESD		X	X	X	X	X	X	X	639
	7316NG	ESD		X	X	X	X	X	X	X	640
	7317NA			X	X	X	X	X	X	X	640
O-GRAVITY 	7352A	HRO		X	X	X	X	X	X	X	642
	7352B	HRO		X	X	X	X	X	X	X	642
	7352G	HRO ESD	X	X	X	X	X	X	X	X	642
	7353Y	HRO			X	X	X	X	X	X	643
	7372B	HRO	X	X	X	X	X	X	X	X	646
O-GRAVITY LADY 	7376A	HRO	X	X	X	X	X	X	X	X	646
O-GRAVITY LADY 	7352LG	HRO		X	X	X	X	X	X	X	643

EN ISO 20347:2012		O1 SRC									
O-GRAVITY 	7362B	FO HRO		X	X		X	X			645

EN ISO 20345:2022		S1PS SR									
O-GRAVITY 	7371V	HRO FO ESD	X	X	X		X	X	X	X	645

EN ISO 20347:2012		O2 SRC									
BASIC 	7243FT	FO			X		X			X	631
O-GRAVITY 	7363N	FO HRO		X	X		X	X			645

EN ISO 20345:2011		S3 SRC									
LIGNE	ARTICLE	CONDITIONS REQUISES				SECTEURS PRÉCONISÉS					📄
		CONDITIONS REQUISES SUPPLÉMENTAIRES			AGRICULTURE	SECTEUR AUTOMOBILE	CONSTRUCTION EN BÂTIMENT	INDUSTRIE	ÉLECTRICITÉ	LOGISTIQUE SERVICES	
FLEX 	7214FN			X	X	X	X	X	X	X	635
	7214G	ESD		X	X	X	X	X	X	X	636
	7215FN			X	X	X	X	X	X	X	636
	7218FN	RS		X	X	X	X	X	X	X	636
	7218G	RS ESD		X	X	X	X	X	X	X	636
EASY PLUS 	7220PEK			X	X	X	X	X	X	X	633
	7221PEK	RS		X	X	X	X	X	X	X	633
TREKKING 	7236BK	RS			X	X	X			X	638
	7238WR	RS HRO WR			X	X	X			X	638
EASY 	7241EN				X	X	X		X	X	629
	7243EN	RS			X	X	X			X	629
BASIC 	7241CK				X	X	X	X	X	X	630
	7243CK	RS			X	X	X	X		X	631
	7243CR	RS HRO			X	X	X		X	X	631
	7245BK	RS			X	X	X	X		X	631
HEAVY DUTY 	7293HM	HRO HI	X		X	X			X	X	647
	7294HM	HRO HI	X		X	X			X	X	647
	7294HMC	HRO HI CI WR	X		X	X			X	X	647
ACTIVE 	7315AN			X	X	X	X	X	X	X	639
	7318AN			X	X	X	X	X	X	X	640
	7320NA			X	X	X	X	X	X	X	640
	7321NA	RS		X	X	X	X	X	X	X	641
	7322SA			X	X	X	X	X	X	X	641
	7323SA	RS		X	X	X	X	X	X	X	641
O-GRAVITY 	7354N	HRO		X	X	X	X	X	X	X	643
	7355V	HRO		X	X	X	X	X	X	X	643
	7356G	HRO		X	X	X	X	X	X	X	644
	7357G	HRO		X	X	X	X	X	X	X	644
	7356V	HRO		X	X	X	X	X	X	X	644
O-GRAVITY LADY 	7357V	HRO		X	X	X	X	X	X	X	645
O-GRAVITY LADY 	7356LN	HRO		X	X	X	X	X	X	X	644
O-GRAVITY 	7381N	HRO WR	X	X	X	X	X	X	X	X	646
	7382N	HRO WR	X	X	X	X	X	X	X	X	646

EN ISO 20345:2011		S5 SRC										
BASIC 	7328A				X	X	X			X	X	632
	7328N				X	X	X			X	X	632

EASY



7241EN

Chaussure basse en cuir pigmenté hydrofuge

- Embout en acier
- Semelle anti-perforation en acier souple

**EN ISO
20345
2011**



EU	UK	mm	CHF		
35	2,5	230	52.00	1	072410835
36	3,5	237	52.00	1	072410836
37	4,5	244	52.00	1	072410837
38	5	250	52.00	1	072410838
39	6	257	52.00	1	072410839
40	6,5	264	52.00	1	072410840
41	7	270	52.00	1	072410841
42	8	277	52.00	1	072410842
43	9	284	52.00	1	072410843
44	10	290	52.00	1	072410844
45	10,5	297	52.00	1	072410845
46	11	304	52.00	1	072410846
47	12	310	52.00	1	072410847
48	13	317	52.00	1	072410848



CE

S3 SRC

7243EN

Chaussure montante en cuir pigmenté hydrofuge, délaçage rapide

- Embout en acier
- Semelle anti-perforation en acier souple

**EN ISO
20345
2011**



EU	UK	mm	CHF		
35	2,5	230	53.50	1	072430835
36	3,5	237	53.50	1	072430836
37	4,5	244	53.50	1	072430837
38	5	250	53.50	1	072430838
39	6	257	53.50	1	072430839
40	6,5	264	53.50	1	072430840
41	7	270	53.50	1	072430841
42	8	277	53.50	1	072430842
43	9	284	53.50	1	072430843
44	10	290	53.50	1	072430844
45	10,5	297	53.50	1	072430845
46	11	304	53.50	1	072430846
47	12	310	53.50	1	072430847
48	13	317	53.50	1	072430848



CE

S3 RS SRC

7246E

Chaussure basse type tennis aérée en croûte de velours

- Embout en acier
- Semelle anti-perforation en acier souple

**EN ISO
20345
2011**



EU	UK	mm	CHF		
35	2,5	230	53.50	1	072460435
36	3,5	237	53.50	1	072460436
37	4,5	244	53.50	1	072460437
38	5	250	53.50	1	072460438
39	6	257	53.50	1	072460439
40	6,5	264	53.50	1	072460440
41	7	270	53.50	1	072460441
42	8	277	53.50	1	072460442
43	9	284	53.50	1	072460443
44	10	290	53.50	1	072460444
45	10,5	297	53.50	1	072460445
46	11	304	53.50	1	072460446
47	12	310	53.50	1	072460447
48	13	317	53.50	1	072460448



CE

S1P SRC

BASIC



7241BK

Chaussure basse en cuir pigmenté

- Embout en acier
- Semelle anti-perforation en fibre composite

EU	UK	mm	CHF		
35	2,5	228	62.50	1	072411235
36	3,5	235	62.50	1	072411236
37	4,5	242	62.50	1	072411237
38	5	248	62.50	1	072411238
39	6	255	62.50	1	072411239
40	6,5	262	62.50	1	072411240
41	7	268	62.50	1	072411241
42	8	275	62.50	1	072411242
43	9	282	62.50	1	072411243
44	10	288	62.50	1	072411244
45	10,5	295	62.50	1	072411245
46	11	302	62.50	1	072411246
47	12	308	62.50	1	072411247
48	13	315	62.50	1	072411248



CE

S1P SRC

**EN ISO
20345
2011**



7241CK

Chaussure basse en cuir pigmenté hydrofuge

- Embout en acier
- Semelle anti-perforation en fibre composite

EU	UK	mm	CHF		
35	2,5	228	63.50	1	072411535
36	3,5	235	63.50	1	072411536
37	4,5	242	63.50	1	072411537
38	5	248	63.50	1	072411538
39	6	255	63.50	1	072411539
40	6,5	262	63.50	1	072411540
41	7	268	63.50	1	072411541
42	8	275	63.50	1	072411542
43	9	282	63.50	1	072411543
44	10	288	63.50	1	072411544
45	10,5	295	63.50	1	072411545
46	11	302	63.50	1	072411546
47	12	308	63.50	1	072411547
48	13	315	63.50	1	072411548



CE

S3 SRC

**EN ISO
20345
2011**



7243BK

Chaussure montante en cuir pigmenté

- Embout en acier
- Semelle anti-perforation en fibre composite

EU	UK	mm	CHF		
35	2,5	228	63.50	1	072431235
36	3,5	235	63.50	1	072431236
37	4,5	242	63.50	1	072431237
38	5	248	63.50	1	072431238
39	6	255	63.50	1	072431239
40	6,5	262	63.50	1	072431240
41	7	268	63.50	1	072431241
42	8	275	63.50	1	072431242
43	9	282	63.50	1	072431243
44	10	288	63.50	1	072431244
45	10,5	295	63.50	1	072431245
46	11	302	63.50	1	072431246
47	12	308	63.50	1	072431247
48	13	315	63.50	1	072431248



CE

S1P SRC

**EN ISO
20345
2011**



7243CK

Chaussure montante en cuir pigmenté hydrofuge, délaçage rapide

- Embout en acier
- Semelle anti-perforation en fibre composite

EU	UK	mm	CHF		
35	2,5	228	65.50	1	072431335
36	3,5	235	65.50	1	072431336
37	4,5	242	65.50	1	072431337
38	5	248	65.50	1	072431338
39	6	255	65.50	1	072431339
40	6,5	262	65.50	1	072431340
41	7	268	65.50	1	072431341
42	8	275	65.50	1	072431342
43	9	282	65.50	1	072431343
44	10	288	65.50	1	072431344
45	10,5	295	65.50	1	072431345
46	11	302	65.50	1	072431346
47	12	308	65.50	1	072431347
48	13	315	65.50	1	072431348

CE



S3 RS SRC

EN ISO 20345 2011



7243CR

Chaussure montante type Brodequin en cuir pigmenté hydrofuge avec semelle en caoutchouc haute résistance, délaçage rapide

- Embout en acier
- Semelle anti-perforation en acier souple

EU	UK	mm	CHF		
35	2,5	231	97.00	1	072430735
36	3,5	238	97.00	1	072430736
37	4,5	245	97.00	1	072430737
38	5	251	97.00	1	072430738
39	6	258	97.00	1	072430739
40	6,5	265	97.00	1	072430740
41	7	271	97.00	1	072430741
42	8	278	97.00	1	072430742
43	9	285	97.00	1	072430743
44	10	291	97.00	1	072430744
45	10,5	298	97.00	1	072430745
46	11	305	97.00	1	072430746
47	12	311	97.00	1	072430747
48	13	318	97.00	1	072430748

CE



S3 RS HRO SRC

EN ISO 20345 2011



7243FT

Chaussure montante type Brodequin en cuir pigmenté hydrofuge sans embout ni semelle anti-perforation

- Sans embout
- Sans semelle anti-perforation

EU	UK	mm	CHF		
35	2,5	228	57.00	1	072430635
36	3,5	235	57.00	1	072430636
37	4,5	242	57.00	1	072430637
38	5	248	57.00	1	072430638
39	6	255	57.00	1	072430639
40	6,5	262	57.00	1	072430640
41	7	268	57.00	1	072430641
42	8	275	57.00	1	072430642
43	9	282	57.00	1	072430643
44	10	288	57.00	1	072430644
45	10,5	295	57.00	1	072430645
46	11	302	57.00	1	072430646
47	12	308	57.00	1	072430647
48	13	315	57.00	1	072430648

CE



O2 FO SRC

EN ISO 20347 2012



7245BK

Chaussure montante type "soudeur" à lacets en cuir pleine fleur pigmenté hydrofuge, délaçage rapide, protection frontale avec languette d'ouverture rapide type "scratch"

- Embout en acier
- Semelle anti-perforation en fibre composite

EU	UK	mm	CHF		
35	2,5	228	75.50	1	072451235
36	3,5	235	75.50	1	072451236
37	4,5	242	75.50	1	072451237
38	5	248	75.50	1	072451238
39	6	255	75.50	1	072451239
40	6,5	262	75.50	1	072451240
41	7	268	75.50	1	072451241
42	8	275	75.50	1	072451242
43	9	282	75.50	1	072451243
44	10	288	75.50	1	072451244
45	10,5	295	75.50	1	072451245
46	11	302	75.50	1	072451246
47	12	308	75.50	1	072451247
48	13	315	75.50	1	072451248

CE



S3 RS SRC

EN ISO 20345 2011



7246BK

Chaussure basse type tennis aérée en croûte de velours

- Embout en acier
- Semelle anti-perforation en fibre composite

EU	UK	mm	CHF		
35	2,5	228	65.50	1	072461235
36	3,5	235	65.50	1	072461236
37	4,5	242	65.50	1	072461237
38	5	248	65.50	1	072461238
39	6	255	65.50	1	072461239
40	6,5	262	65.50	1	072461240
41	7	268	65.50	1	072461241
42	8	275	65.50	1	072461242
43	9	282	65.50	1	072461243
44	10	288	65.50	1	072461244
45	10,5	295	65.50	1	072461245
46	11	302	65.50	1	072461246
47	12	308	65.50	1	072461247
48	13	315	65.50	1	072461248



CE

S1P SRC

EN ISO 20345 2011



7247BK

Chaussure basse type sandale aérée en cuir pigmenté

- Embout en acier
- Semelle anti-perforation en fibre composite

EU	UK	mm	CHF		
35	2,5	228	65.00	1	072471235
36	3,5	235	65.00	1	072471236
37	4,5	242	65.00	1	072471237
38	5	248	65.00	1	072471238
39	6	255	65.00	1	072471239
40	6,5	262	65.00	1	072471240
41	7	268	65.00	1	072471241
42	8	275	65.00	1	072471242
43	9	282	65.00	1	072471243
44	10	288	65.00	1	072471244
45	10,5	295	65.00	1	072471245
46	11	302	65.00	1	072471246
47	12	308	65.00	1	072471247
48	13	315	65.00	1	072471248



CE

S1P SRC

EN ISO 20345 2011



7328A

Botte de sécurité "haute visibilité" en PVC nitrile. Avec semelle extérieure antidérapante autonettoyante.

- Embout en acier
- Semelle anti-perforation en acier souple

EU	UK	mm	CHF		
38	5	253	51.50	1	073280638
39	6	260	51.50	1	073280639
40	6,5	267	51.50	1	073280640
41	7	273	51.50	1	073280641
42	8	280	51.50	1	073280642
43	9	287	51.50	1	073280643
44	10	293	51.50	1	073280644
45	10,5	300	51.50	1	073280645
46	11	307	51.50	1	073280646
47	12	313	51.50	1	073280647



CE

S5 SRC

EN ISO 20345 2011



7328N

Botte de sécurité en PVC nitrile. Avec semelle extérieure antidérapante autonettoyante.

- Embout en acier
- Semelle anti-perforation en acier souple

EU	UK	mm	CHF		
38	5	253	51.50	1	073280838
39	6	260	51.50	1	073280839
40	6,5	267	51.50	1	073280840
41	7	273	51.50	1	073280841
42	8	280	51.50	1	073280842
43	9	287	51.50	1	073280843
44	10	293	51.50	1	073280844
45	10,5	300	51.50	1	073280845
46	11	307	51.50	1	073280846
47	12	313	51.50	1	073280847



CE

S5 SRC

EN ISO 20345 2011



EASY PLUS



7220PEK

Chaussure basse en cuir pigmenté hydrofuge avec inserts en nylon
et couvre-embout anti-abrasion

- Embout en composite
- Semelle anti-perforation en fibre composite

EU	UK	mm	CHF		
35	2,5	228	86.50	1	072200235
36	3,5	235	86.50	1	072200236
37	4,5	242	86.50	1	072200237
38	5	248	86.50	1	072200238
39	6	255	86.50	1	072200239
40	6,5	262	86.50	1	072200240
41	7	268	86.50	1	072200241
42	8	275	86.50	1	072200242
43	9	282	86.50	1	072200243
44	10	288	86.50	1	072200244
45	10,5	295	86.50	1	072200245
46	11	302	86.50	1	072200246
47	12	308	86.50	1	072200247
48	13	315	86.50	1	072200248

CE



S3 SRC

EN ISO
20345
2011

METAL
FREE



7221PEK

Chaussure montante en cuir pigmenté hydrofuge avec inserts en nylon,
couvre-embout anti-abrasion, délaçage rapide

- Embout en composite
- Semelle anti-perforation en fibre composite

EU	UK	mm	CHF		
35	2,5	228	90.50	1	072210235
36	3,5	235	90.50	1	072210236
37	4,5	242	90.50	1	072210237
38	5	248	90.50	1	072210238
39	6	255	90.50	1	072210239
40	6,5	262	90.50	1	072210240
41	7	268	90.50	1	072210241
42	8	275	90.50	1	072210242
43	9	282	90.50	1	072210243
44	10	288	90.50	1	072210244
45	10,5	295	90.50	1	072210245
46	11	302	90.50	1	072210246
47	12	308	90.50	1	072210247
48	13	315	90.50	1	072210248

CE



S3 RS SRC

EN ISO
20345
2011

METAL
FREE



7222PEK

Chaussure basse en daim perforée grise, avec empiècements en mesh hautement respirant -S1P SRC

- Embout composite
- Semelle antiperforation en fibre composite

EU	UK	mm	CHF		
35	2,5	228	83.00	1	072220135
36	3,5	235	83.00	1	072220136
37	4,5	242	83.00	1	072220137
38	5	248	83.00	1	072220138
39	6	255	83.00	1	072220139
40	6,5	262	83.00	1	072220140
41	7	268	83.00	1	072220141
42	8	275	83.00	1	072220142
43	9	282	83.00	1	072220143
44	10	288	83.00	1	072220144
45	10,5	295	83.00	1	072220145
46	11	302	83.00	1	072220146
47	12	308	83.00	1	072220147
48	13	315	83.00	1	072220148

CE



S1P SRC

EN ISO
20345
2011

METAL
FREE



7223PEK

Chaussure basse en croûte de velours avec inserts en maille à ventilation élevée et couvre-embout anti-abrasion • Embout en composite
• Semelle anti-perforation en fibre composite

EU	UK	mm	CHF		
35	2,5	228	89.50	1	072230135
36	3,5	235	89.50	1	072230136
37	4,5	242	89.50	1	072230137
38	5	248	89.50	1	072230138
39	6	255	89.50	1	072230139
40	6,5	262	89.50	1	072230140
41	7	268	89.50	1	072230141
42	8	275	89.50	1	072230142
43	9	282	89.50	1	072230143
44	10	288	89.50	1	072230144
45	10,5	295	89.50	1	072230145
46	11	302	89.50	1	072230146
47	12	308	89.50	1	072230147
48	13	315	89.50	1	072230148



CE

S1P SRC

EN ISO
20345
2011

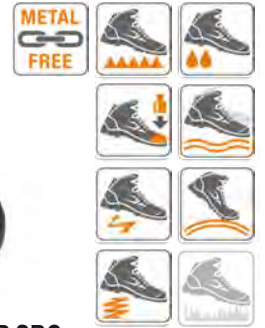

FLEX

7212B

Chaussure basse en croûte de velours aérée avec inserts en tissu mesh. Avec insert anti-abrasion sur l'embout Extrêmement flexible et légère - Poids approximatif pour la taille 42: 490 g Non indiquée pour des utilisations contraignantes (bâtiment, agriculture, industrie lourde) • Embout en composite
• Semelle anti-perforation en fibre composite

EU	UK	mm	CHF		
35	2,5	228	96.00	1	072120235
36	3,5	235	96.00	1	072120236
37	4,5	242	96.00	1	072120237
38	5	248	96.00	1	072120238
39	6	255	96.00	1	072120239
40	6,5	262	96.00	1	072120240
41	7	268	96.00	1	072120241
42	8	275	96.00	1	072120242
43	9	282	96.00	1	072120243
44	10	288	96.00	1	072120244
45	10,5	295	96.00	1	072120245
46	11	302	96.00	1	072120246
47	12	308	96.00	1	072120247
48	13	315	96.00	1	072120248



CE

S1P SRC ESD

EN ISO
20345
2011



Beta

7212G

chaussure basse aérée en croûte de velours. Avec insert anti-abrasion sur l'embout Extrêmement flexible et légère - Poids approximatif pour la taille 42 : 490 g Non indiquée pour des utilisations contraignantes (bâtiment, agriculture, industrie lourde)

- Embout en composite
- Semelle anti-perforation en fibre composite

EU	UK	mm	CHF		
35	2.5	228	96.00	1	072120335
36	3.5	235	96.00	1	072120336
37	4.5	242	96.00	1	072120337
38	5	248	96.00	1	072120338
39	6	255	96.00	1	072120339
40	6.5	262	96.00	1	072120340
41	7	268	96.00	1	072120341
42	8	275	96.00	1	072120342
43	9	282	96.00	1	072120343
44	10	288	96.00	1	072120344
45	10.5	295	96.00	1	072120345
46	11	302	96.00	1	072120346
47	12	308	96.00	1	072120347
48	13	315	96.00	1	072120348



CE

S1P SRC ESD



EN ISO 20345 2011



7213G

Chaussure basse en croûte de velours aérée avec inserts en tissu mesh hautement respirant Extrêmement flexible et légère - Poids approximatif pour la taille 42: 490 g Non indiquée pour des utilisations contraignantes (bâtiment, agriculture, industrie lourde)

- Embout en composite
- Semelle anti-perforation en fibre composite

EU	UK	mm	CHF		
35	2.5	228	96.00	1	072130135
36	3.5	235	96.00	1	072130136
37	4.5	242	96.00	1	072130137
38	5	248	96.00	1	072130138
39	6	255	96.00	1	072130139
40	6.5	262	96.00	1	072130140
41	7	268	96.00	1	072130141
42	8	275	96.00	1	072130142
43	9	282	96.00	1	072130143
44	10	288	96.00	1	072130144
45	10.5	295	96.00	1	072130145
46	11	302	96.00	1	072130146
47	12	308	96.00	1	072130147
48	13	315	96.00	1	072130148



CE

S1P SRC ESD



EN ISO 20345 2011



7214FN

Chaussure basse en Nubuck Action hydrofuge avec insert anti-abrasion sur l'embout Extrêmement flexible et légère - poids indicatif pointure 42: 500 g Non indiquée pour des utilisations contraignantes (bâtiment, agriculture, industrie lourde)

- Embout en composite
- Semelle anti-perforation en fibre composite

EU	UK	mm	CHF		
35	2.5	228	104.00	1	072140035
36	3.5	235	104.00	1	072140036
37	4.5	242	104.00	1	072140037
38	5	248	104.00	1	072140038
39	6	255	104.00	1	072140039
40	6.5	262	104.00	1	072140040
41	7	268	104.00	1	072140041
42	8	275	104.00	1	072140042
43	9	282	104.00	1	072140043
44	10	288	104.00	1	072140044
45	10.5	295	104.00	1	072140045
46	11	302	104.00	1	072140046
47	12	308	104.00	1	072140047
48	13	315	104.00	1	072140048



CE

S3 SRC



EN ISO 20345 2011



 **Beta**

7214G

Chaussure basse en Nubuck Action hydrofuge avec insert anti-abrasion sur l'embout Extrêmement flexible et légère - Poids approximatif pour la taille 42: 500 g Non indiquée pour des utilisations contraignantes (bâtiment, agriculture, industrie lourde)

- Embout en composite
- Semelle anti-perforation en fibre composite

EU	UK	mm	CHF		
35	2.5	228	104.00	1	072140235
36	3.5	235	104.00	1	072140236
37	4.5	242	104.00	1	072140237
38	5	248	104.00	1	072140238
39	6	255	104.00	1	072140239
40	6.5	262	104.00	1	072140240
41	7	268	104.00	1	072140241
42	8	275	104.00	1	072140242
43	9	282	104.00	1	072140243
44	10	288	104.00	1	072140244
45	10.5	295	104.00	1	072140245
46	11	302	104.00	1	072140246
47	12	308	104.00	1	072140247
48	13	315	104.00	1	072140248



CE

S3 SRC ESD



EN ISO 20345 2011



7215FN

Mocassin en Nubuck Action hydrofuge avec insert anti-abrasion sur l'embout Extrêmement flexible et légère - poids indicatif pointure 42: 490 g Non indiquée pour des utilisations contraignantes (bâtiment, agriculture, industrie lourde)

- Embout en composite
- Semelle anti-perforation en fibre composite

EU	UK	mm	CHF		
35	2.5	228	105.50	1	072150135
36	3.5	235	105.50	1	072150136
37	4.5	242	105.50	1	072150137
38	5	248	105.50	1	072150138
39	6	255	105.50	1	072150139
40	6.5	262	105.50	1	072150140
41	7	268	105.50	1	072150141
42	8	275	105.50	1	072150142
43	9	282	105.50	1	072150143
44	10	288	105.50	1	072150144
45	10.5	295	105.50	1	072150145
46	11	302	105.50	1	072150146
47	12	308	105.50	1	072150147
48	13	315	105.50	1	072150148



CE

S3 SRC



EN ISO 20345 2011



7218FN

Chaussure montante en Nubuck Action hydrofuge avec insert anti-abrasion sur l'embout, délaçage rapide Extrêmement flexible et légère - poids indicatif pointure 42 : 510 g Non indiquée pour des utilisations contraignantes (bâtiment, agriculture, industrie lourde)

- Embout en composite
- Semelle anti-perforation en fibre composite

EU	UK	mm	CHF		
35	2.5	228	108.50	1	072180035
36	3.5	235	108.50	1	072180036
37	4.5	242	108.50	1	072180037
38	5	248	108.50	1	072180038
39	6	255	108.50	1	072180039
40	6.5	262	108.50	1	072180040
41	7	268	108.50	1	072180041
42	8	275	108.50	1	072180042
43	9	282	108.50	1	072180043
44	10	288	108.50	1	072180044
45	10.5	295	108.50	1	072180045
46	11	302	108.50	1	072180046
47	12	308	108.50	1	072180047
48	13	315	108.50	1	072180048



CE

S3 RS SRC



EN ISO 20345 2011



7218G

Chaussure montante en Nubuck Action hydrofuge avec insert anti-abrasion sur l'embout. Délaçage rapide Extrêmement flexible et légère - Poids approximatif pour la taille 42: 550 g Non indiquée pour des utilisations contraignantes (bâtiment, agriculture, industrie lourde)

- Embout en composite
- Semelle anti-perforation en fibre composite

EU	UK	mm	CHF		
35	2.5	228	108.50	1	072180135
36	3.5	235	108.50	1	072180136
37	4.5	242	108.50	1	072180137
38	5	248	108.50	1	072180138
39	6	255	108.50	1	072180139
40	6.5	262	108.50	1	072180140
41	7	268	108.50	1	072180141
42	8	275	108.50	1	072180142
43	9	282	108.50	1	072180143
44	10	288	108.50	1	072180144
45	10.5	295	108.50	1	072180145
46	11	302	108.50	1	072180146
47	12	308	108.50	1	072180147
48	13	315	108.50	1	072180148



CE

S3 RS SRC ESD



EN ISO 20345 2011



BASIC PLUS



7201BKK

Chaussure montante en cuir pleine fleur, imperméable
NON DISPONIBLE A LA VENTE

- Embout composite
- Semelle intérieure anti-pénétration en fibres composites

EU	UK	mm	
35	2,5	228	1 072010435
36	3,5	235	1 072010436
37	4,5	242	1 072010437
38	5	248	1 072010438
39	6	255	1 072010439
40	6,5	262	1 072010440
41	7	268	1 072010441
42	8	275	1 072010442
43	9	282	1 072010443
44	10	288	1 072010444
45	10,5	295	1 072010445
46	11	302	1 072010446
47	12	308	1 072010447
48	13	315	1 072010448



CE

S3 SRC

EN ISO
20345
2011

METAL
FREE



7210BKK

Chaussure montante en cuir pleine fleur, imperméable
NON DISPONIBLE A LA VENTE

- Embout composite
- Semelle intérieure anti-pénétration en fibres composites

EU	UK	mm	
35	2,5	228	1 072100335
36	3,5	235	1 072100336
37	4,5	242	1 072100337
38	5	248	1 072100338
39	6	255	1 072100339
40	6,5	262	1 072100340
41	7	268	1 072100341
42	8	275	1 072100342
43	9	282	1 072100343
44	10	288	1 072100344
45	10,5	295	1 072100345
46	11	302	1 072100346
47	12	308	1 072100347
48	13	315	1 072100348



CE

S1P SRC

EN ISO
20345
2011

METAL
FREE



7216BKK

Chaussure basse type sandale en croûte de velour souple,
avec fermeture type scratch
NON DISPONIBLE A LA VENTE

- Embout composite
- Semelle intérieure anti-pénétration en fibres composites

EU	UK	mm	
35	2,5	228	1 072160335
36	3,5	235	1 072160336
37	4,5	242	1 072160337
38	5	248	1 072160338
39	6	255	1 072160339
40	6,5	262	1 072160340
41	7	268	1 072160341
42	8	275	1 072160342
43	9	282	1 072160343
44	10	288	1 072160344
45	10,5	295	1 072160345
46	11	302	1 072160346
47	12	308	1 072160347
48	13	315	1 072160348



CE

S1P SRC

EN ISO
20345
2011

METAL
FREE



TREKKING



7236BK

Chaussure montante en Nubuck Action hydrofuge à délaçage rapide, avec couvre-embout renforcé en polyuréthane

- Embout en acier
- Semelle anti-perforation en fibre composite

EU	UK	mm	CHF		
35	2,5	228	99.00	1	072360335
36	3,5	235	99.00	1	072360336
37	4,5	242	99.00	1	072360337
38	5	248	99.00	1	072360338
39	6	255	99.00	1	072360339
40	6,5	262	99.00	1	072360340
41	7	268	99.00	1	072360341
42	8	275	99.00	1	072360342
43	9	282	99.00	1	072360343
44	10	288	99.00	1	072360344
45	10,5	295	99.00	1	072360345
46	11	302	99.00	1	072360346
47	12	308	99.00	1	072360347
48	13	315	99.00	1	072360348



CE

S3 RS SRC

**EN ISO
20345
2011**



7238WR

Chaussure montante en cuir velours avec inserts en nylon, semelle en caoutchouc haute résistance, délaçage rapide soumise à test dans un cuve avec 3 cm d'eau, après 1000 longueurs, la zone totale mouillée à l'intérieur de la chaussure ne doit pas dép

- Embout en composite
- Semelle anti-perforation en fibre composite

EU	UK	mm	CHF		
35	2,5	228	132.50	1	072380235
36	3,5	235	132.50	1	072380236
37	4,5	242	132.50	1	072380237
38	5	248	132.50	1	072380238
39	6	255	132.50	1	072380239
40	6,5	262	132.50	1	072380240
41	7	268	132.50	1	072380241
42	8	275	132.50	1	072380242
43	9	282	132.50	1	072380243
44	10	288	132.50	1	072380244
45	10,5	295	132.50	1	072380245
46	11	302	132.50	1	072380246
47	12	308	132.50	1	072380247
48	13	315	132.50	1	072380248



CE

S3 RS WR HRO SRC

**EN ISO
20345
2011**



7249GK

Chaussure montante en croûte de velours à délaçage rapide, avec inserts en nylon et couvre-embout renforcé en polyuréthane

- Embout en acier
- Semelle anti-perforation en fibre composite

EU	UK	mm	CHF		
35	2,5	231	83.00	1	072490235
36	3,5	238	83.00	1	072490236
37	4,5	245	83.00	1	072490237
38	5	251	83.00	1	072490238
39	6	258	83.00	1	072490239
40	6,5	265	83.00	1	072490240
41	7	271	83.00	1	072490241
42	8	278	83.00	1	072490242
43	9	285	83.00	1	072490243
44	10	291	83.00	1	072490244
45	10,5	298	83.00	1	072490245
46	11	305	83.00	1	072490246
47	12	311	83.00	1	072490247
48	13	318	83.00	1	072490248



CE

S1P RS SRC

**EN ISO
20345
2011**



ACTIVE



7314AF

Chaussure basse en cuir velours avec inserts en nylon mesh et carbone

- Embout en composite
- Semelle antiperforation en fibre composite

EN ISO 20345 2011

METAL FREE



EU	UK	mm	CHF	CE	Code
35	2,5	228	132.00		1 073140235
36	3,5	235	132.00		1 073140236
37	4,5	242	132.00		1 073140237
38	5	248	132.00		1 073140238
39	6	255	132.00		1 073140239
40	6,5	262	132.00		1 073140240
41	7	268	132.00		1 073140241
42	8	275	132.00		1 073140242
43	9	282	132.00		1 073140243
44	10	288	132.00		1 073140244
45	10,5	295	132.00		1 073140245
46	11	302	132.00		1 073140246
47	12	308	132.00		1 073140247
48	13	315	132.00		1 073140248



CE

S1P SRC

7315AN

Chaussure basse en cuir velours et microfibre hydrofuges avec inserts en carbone

- Embout en composite
- Semelle antiperforation en fibre composite

EN ISO 20345 2011

METAL FREE



EU	UK	mm	CHF	CE	Code
35	2,5	228	152.00		1 073150535
36	3,5	235	152.00		1 073150536
37	4,5	242	152.00		1 073150537
38	5	248	152.00		1 073150538
39	6	255	152.00		1 073150539
40	6,5	262	152.00		1 073150540
41	7	268	152.00		1 073150541
42	8	275	152.00		1 073150542
43	9	282	152.00		1 073150543
44	10	288	152.00		1 073150544
45	10,5	295	152.00		1 073150545
46	11	302	152.00		1 073150546
47	12	308	152.00		1 073150547
48	13	315	152.00		1 073150548



CE

S3 SRC

7316NB

Chaussure basse en tissu mesh à haute respirabilité et croûte de velours avec maintien de la stabilité du talon

- Embout en composite
- Semelle anti-perforation en fibre composite

EN ISO 20345 2011

ESD

METAL FREE



EU	UK	mm	CHF	CE	Code
35	2,5	228	114.50		1 073160735
36	3,5	235	114.50		1 073160736
37	4,5	242	114.50		1 073160737
38	5	248	114.50		1 073160738
39	6	255	114.50		1 073160739
40	6,5	262	114.50		1 073160740
41	7	268	114.50		1 073160741
42	8	275	114.50		1 073160742
43	9	282	114.50		1 073160743
44	10	288	114.50		1 073160744
45	10,5	295	114.50		1 073160745
46	11	302	114.50		1 073160746
47	12	308	114.50		1 073160747
48	13	315	114.50		1 073160748



CE

S1P SRC ESD

7316NG

Chaussure basse en tissu mesh à haute respirabilité et croûte de velours avec maintien de la stabilité du talon

- Embout en composite
- Semelle anti-perforation en fibre composite

EU	UK	mm	CHF		
35	2.5	228	114.50	1	073160635
36	3.5	235	114.50	1	073160636
37	4.5	242	114.50	1	073160637
38	5	248	114.50	1	073160638
39	6	255	114.50	1	073160639
40	6.5	262	114.50	1	073160640
41	7	268	114.50	1	073160641
42	8	275	114.50	1	073160642
43	9	282	114.50	1	073160643
44	10	288	114.50	1	073160644
45	10.5	295	114.50	1	073160645
46	11	302	114.50	1	073160646
47	12	308	114.50	1	073160647
48	13	315	114.50	1	073160648



CE

S1P SRC ESD

7317NA

Chaussure basse aérée en croûte de velours avec renfort en microfibre dans la zone du talon

- Embout en composite
- Semelle anti-perforation en fibre composite

EU	UK	mm	CHF		
35	2.5	228	98.00	1	073170135
36	3.5	235	98.00	1	073170136
37	4.5	242	98.00	1	073170137
38	5	248	98.00	1	073170138
39	6	255	98.00	1	073170139
40	6.5	262	98.00	1	073170140
41	7	268	98.00	1	073170141
42	8	275	98.00	1	073170142
43	9	282	98.00	1	073170143
44	10	288	98.00	1	073170144
45	10.5	295	98.00	1	073170145
46	11	302	98.00	1	073170146
47	12	308	98.00	1	073170147
48	13	315	98.00	1	073170148



CE

S1P SRC

7318AN

Chaussure montante en croûte de velours et microfibre, hydrofuge, avec inserts en carbone

- Embout en composite
- Semelle anti-perforation en fibre composite

EU	UK	mm	CHF		
35	2.5	228	158.00	1	073180535
36	3.5	235	158.00	1	073180536
37	4.5	242	158.00	1	073180537
38	5	248	158.00	1	073180538
39	6	255	158.00	1	073180539
40	6.5	262	158.00	1	073180540
41	7	268	158.00	1	073180541
42	8	275	158.00	1	073180542
43	9	282	158.00	1	073180543
44	10	288	158.00	1	073180544
45	10.5	295	158.00	1	073180545
46	11	302	158.00	1	073180546
47	12	308	158.00	1	073180547
48	13	315	158.00	1	073180548



CE

S3 SRC

7320NA

Chaussure basse en Nubuck hydrofuge avec renfort anti-abrasion dans la zone de l'embout

- Embout en composite
- Semelle anti-perforation en fibre composite

EU	UK	mm	CHF		
35	2.5	228	103.50	1	073200435
36	3.5	235	103.50	1	073200436
37	4.5	242	103.50	1	073200437
38	5	248	103.50	1	073200438
39	6	255	103.50	1	073200439
40	6.5	262	103.50	1	073200440
41	7	268	103.50	1	073200441
42	8	275	103.50	1	073200442
43	9	282	103.50	1	073200443
44	10	288	103.50	1	073200444
45	10.5	295	103.50	1	073200445
46	11	302	103.50	1	073200446
47	12	308	103.50	1	073200447
48	13	315	103.50	1	073200448



CE

S3 SRC

7321NA

Chaussure haute en Nubuck hydrofuge, délaçage rapide, avec renfort anti-abrasion dans la zone de l'embout

- Embout en composite
- Semelle anti-perforation en fibre composite

EU	UK	mm	CHF		
35	2,5	228	106.50	1	073210435
36	3,5	235	106.50	1	073210436
37	4,5	242	106.50	1	073210437
38	5	248	106.50	1	073210438
39	6	255	106.50	1	073210439
40	6,5	262	106.50	1	073210440
41	7	268	106.50	1	073210441
42	8	275	106.50	1	073210442
43	9	282	106.50	1	073210443
44	10	288	106.50	1	073210444
45	10,5	295	106.50	1	073210445
46	11	302	106.50	1	073210446
47	12	308	106.50	1	073210447
48	13	315	106.50	1	073210448



CE

S3 RS SRC



EN ISO 20345 2011



7322SA

Chaussure Basse en tissu, très résistante à l'abrasion, avec support de stabilité du talon - S3 SRC

- Embout composite
- Semelle antiperforation en fibre composite

EU	UK	mm	CHF		
35	2,5	228	112.00	1	073220435
36	3,5	235	112.00	1	073220436
37	4,5	242	112.00	1	073220437
38	5	248	112.00	1	073220438
39	6	255	112.00	1	073220439
40	6,5	262	112.00	1	073220440
41	7	268	112.00	1	073220441
42	8	275	112.00	1	073220442
43	9	282	112.00	1	073220443
44	10	288	112.00	1	073220444
45	10,5	295	112.00	1	073220445
46	11	302	112.00	1	073220446
47	12	308	112.00	1	073220447
48	13	315	112.00	1	073220448



CE

S3 SRC



EN ISO 20345 2011



7323SA

Chaussure Montante en tissu, très résistante à l'abrasion, avec système délaçage rapide et support de stabilité du talon - S3 SRC

- Embout composite
- Semelle antiperforation en fibre composite

EU	UK	mm	CHF		
35	2,5	228	115.00	1	073230435
36	3,5	235	115.00	1	073230436
37	4,5	242	115.00	1	073230437
38	5	248	115.00	1	073230438
39	6	255	115.00	1	073230439
40	6,5	262	115.00	1	073230440
41	7	268	115.00	1	073230441
42	8	275	115.00	1	073230442
43	9	282	115.00	1	073230443
44	10	288	115.00	1	073230444
45	10,5	295	115.00	1	073230445
46	11	302	115.00	1	073230446
47	12	308	115.00	1	073230447
48	13	315	115.00	1	073230448



CE

S3 RS SRC



EN ISO 20345 2011



Beta

O-GRAVITY



7352A

Chaussure basse en tissu mesh à haute respirabilité avec inserts en TPU

Support de stabilité talon, col "slip on" élastifié pour faciliter le maintien et semelle en EVA avec semelle extérieure en caoutchouc nitrile à haute résistance

- Embout en composite
- Semelle anti-perforation en fibre composite
- LÉGÈRETÉ EXCEPTIONNELLE : poids indicatif taille 42 : 450 grammes

EN ISO
20345
2011

EU	UK	mm	CHF		
38	5	254	171.50	1	073520038
39	6	261	171.50	1	073520039
40	6,5	268	171.50	1	073520040
41	7	274	171.50	1	073520041
42	8	281	171.50	1	073520042
43	9	288	171.50	1	073520043
44	10	294	171.50	1	073520044
45	10,5	301	171.50	1	073520045
46	11	308	171.50	1	073520046
47	12	314	171.50	1	073520047
48	13	321	171.50	1	073520048



CE

S1P HRO SRC

7352B

Chaussure basse en tissu mesh à haute respirabilité avec inserts en TPU

Support de stabilité talon, col "slip on" élastifié pour faciliter le maintien et semelle en EVA avec semelle extérieure en caoutchouc nitrile à haute résistance

- Embout en composite
- Semelle anti-perforation en fibre composite
- LÉGÈRETÉ EXCEPTIONNELLE : poids indicatif taille 42 : 450 grammes

EN ISO
20345
2011

EU	UK	mm	CHF		
38	5	254	171.50	1	073520138
39	6	261	171.50	1	073520139
40	6,5	268	171.50	1	073520140
41	7	274	171.50	1	073520141
42	8	281	171.50	1	073520142
43	9	288	171.50	1	073520143
44	10	294	171.50	1	073520144
45	10,5	301	171.50	1	073520145
46	11	308	171.50	1	073520146
47	12	314	171.50	1	073520147
48	13	321	171.50	1	073520148



CE

S1P HRO SRC

7352G

chaussure en tissu maillé, très respirante, avec inserts en TPU
Support de stabilité du talon, laçage traditionnel, coupe large.
Semelle extérieure en EVA avec bande de roulement en caoutchouc nitrile durable

- embout composite
- Semelle intérieure résistante à la pénétration en fibre composite
- EXTREMEMENT LÉGER: poids approximatif pour la taille 42: 450 grammes

EN ISO
20345
2011

EU	UK	mm	CHF		
38	5	254	177.50	1	073520338
39	6	261	177.50	1	073520339
40	6,5	268	177.50	1	073520340
41	7	274	177.50	1	073520341
42	8	281	177.50	1	073520342
43	9	288	177.50	1	073520343
44	10	294	177.50	1	073520344
45	10,5	301	177.50	1	073520345
46	11	308	177.50	1	073520346
47	12	314	177.50	1	073520347
48	13	321	177.50	1	073520348



CE

S1P HRO SRC ESD

7352LG

Chaussure Basse en tissu mesh pour femme, hautement respirante, avec inserts en TPU
Tige en mesh réfléchissant haute visibilité
Maintien de la stabilité du talon, col à enfiler extensible et semelle extérieure en EVA avec bande de roulement en caoutchouc nitrile durable - S1P HRO SRC

- Embout en fibre de verre
- Semelle antiperforation en fibre composite
- ULTRA LÉGER: poids approximatif pour la taille 38: 390 grammes

EN ISO 20345 2011

EU	UK	mm	CHF		
34	2	228	177.00	1	073520234
35	2,5	234	177.00	1	073520235
36	3,5	241	177.00	1	073520236
37	4,5	248	177.00	1	073520237
38	5	254	177.00	1	073520238
39	6	261	177.00	1	073520239
40	6,5	268	177.00	1	073520240
41	7	274	177.00	1	073520241
42	8	281	177.00	1	073520242

CE



S1P HRO SRC



7353Y

Chaussure basse en tissu mesh à haute respirabilité avec inserts en TPU Tige dotée de mailles spéciales réfléchissantes à haute visibilité Support de stabilité talon, col "slip on" élastifié pour faciliter le maintien et semelle en EVA avec semelle extérieure en caoutchouc nitrile à haute résistance

- Embout en fibre de carbone
- Semelle anti-perforation en fibre composite
- LÉGÈRETÉ EXCEPTIONNELLE : poids indicatif taille 42 : 420 grammes

EN ISO 20345 2011

EU	UK	mm	CHF		
38	5	254	220.50	1	073530038
39	6	261	220.50	1	073530039
40	6,5	268	220.50	1	073530040
41	7	274	220.50	1	073530041
42	8	281	220.50	1	073530042
43	9	288	220.50	1	073530043
44	10	294	220.50	1	073530044
45	10,5	301	220.50	1	073530045
46	11	308	220.50	1	073530046
47	12	314	220.50	1	073530047
48	13	321	220.50	1	073530048

CE



S1P HRO SRC



7354N

Chaussure basse en tissu mesh avec inserts en TPU Support de stabilité talon, col "slip on" élastifié pour faciliter le maintien et semelle en EVA avec semelle extérieure en caoutchouc nitrile à haute résistance

- Embout en composite
- Semelle anti-perforation en fibre composite
- LÉGÈRETÉ EXCEPTIONNELLE : poids indicatif taille 42 : 460 grammes

EN ISO 20345 2011

EU	UK	mm	CHF		
38	5	254	177.00	1	073540038
39	6	261	177.00	1	073540039
40	6,5	268	177.00	1	073540040
41	7	274	177.00	1	073540041
42	8	281	177.00	1	073540042
43	9	288	177.00	1	073540043
44	10	294	177.00	1	073540044
45	10,5	301	177.00	1	073540045
46	11	308	177.00	1	073540046
47	12	314	177.00	1	073540047
48	13	321	177.00	1	073540048

CE



S3 HRO SRC



7355V

Chaussure montante en tissu mesh avec inserts en TPU Support de stabilité talon, col "slip on" élastifié pour faciliter le maintien et semelle en EVA avec semelle extérieure en caoutchouc nitrile à haute résistance

- Embout en composite
- Semelle anti-perforation en fibre composite
- LÉGÈRETÉ EXCEPTIONNELLE : poids indicatif taille 42 : 465 grammes

EN ISO 20345 2011

EU	UK	mm	CHF		
38	5	254	189.00	1	073550038
39	6	261	189.00	1	073550039
40	6,5	268	189.00	1	073550040
41	7	274	189.00	1	073550041
42	8	281	189.00	1	073550042
43	9	288	189.00	1	073550043
44	10	294	189.00	1	073550044
45	10,5	301	189.00	1	073550045
46	11	308	189.00	1	073550046
47	12	314	189.00	1	073550047
48	13	321	189.00	1	073550048

CE



S3 HRO SRC



7356G

Chaussure basse en microfibre hydrofuge avec inserts en TPU
Support de stabilité talon, col "slip on" élastifié pour faciliter le maintien et semelle en EVA avec semelle extérieure en caoutchouc nitrile à haute résistance

- Embout en composite
- Semelle anti-perforation en fibre composite
- LÉGÈRETÉ EXCEPTIONNELLE : poids indicatif taille 42 : 460 grammes

EN ISO 20345 2011

EU	UK	mm	CHF		
38	5	254	182.50	1	073560038
39	6	261	182.50	1	073560039
40	6,5	268	182.50	1	073560040
41	7	274	182.50	1	073560041
42	8	281	182.50	1	073560042
43	9	288	182.50	1	073560043
44	10	294	182.50	1	073560044
45	10,5	301	182.50	1	073560045
46	11	308	182.50	1	073560046
47	12	314	182.50	1	073560047
48	13	321	182.50	1	073560048



METAL FREE



CE

S3 HRO SRC

7356V

Chaussure Basse en microfibre, hydrofuge, avec inserts en TPU
Maintien de la stabilité du talon, col à enfiler extensible et semelle extérieure en EVA avec bande de roulement en caoutchouc nitrile durable - S3 HRO SRC

- Embout composite
- Semelle antiperforation en fibre composite
- ULTRA LÉGER: poids approximatif pour la taille 42: 460 grammes

EN ISO 20345 2011

EU	UK	mm	CHF		
38	5	254	182.50	1	073560138
39	6	261	182.50	1	073560139
40	6,5	268	182.50	1	073560140
41	7	274	182.50	1	073560141
42	8	281	182.50	1	073560142
43	9	288	182.50	1	073560143
44	10	294	182.50	1	073560144
45	10,5	301	182.50	1	073560145
46	11	308	182.50	1	073560146
47	12	314	182.50	1	073560147
48	13	321	182.50	1	073560148



METAL FREE



CE

S3 HRO SRC

7356LN

chaussure en microfibre pour femme, déperlante, avec inserts en TPU
Maintien de la stabilité du talon, col à enfiler extensible et semelle extérieure en EVA avec bande de roulement en caoutchouc nitrile durable

- Embout en fibre de verre
- Semelle intérieure résistante à la pénétration de fibre composite
- REMARQUABLEMENT LÉGER: poids approximatif pour la taille 38: 400 grammes

EN ISO 20345 2011

EU	UK	mm	CHF		
34	2	228	181.50	1	073560234
35	2,5	234	181.50	1	073560235
36	3,5	241	181.50	1	073560236
37	4,5	248	181.50	1	073560237
38	5	254	181.50	1	073560238
39	6	261	181.50	1	073560239
40	6,5	268	181.50	1	073560240
41	7	274	181.50	1	073560241
42	8	281	181.50	1	073560242



lady



METAL FREE



CE

S3 HRO SRC

7357G

Chaussure montante en microfibre hydrofuge avec inserts en TPU
Support de stabilité talon, col élastifié pour faciliter le maintien et semelle en EVA con semelle extérieure en caoutchouc nitrile à haute résistance

- Embout en composite
- Semelle anti-perforation en fibre composite
- LÉGÈRETÉ EXCEPTIONNELLE : poids indicatif taille 42 : 480 grammes

EN ISO 20345 2011

EU	UK	mm	CHF		
38	5	254	202.00	1	073570038
39	6	261	202.00	1	073570039
40	6,5	268	202.00	1	073570040
41	7	274	202.00	1	073570041
42	8	281	202.00	1	073570042
43	9	288	202.00	1	073570043
44	10	294	202.00	1	073570044
45	10,5	301	202.00	1	073570045
46	11	308	202.00	1	073570046
47	12	314	202.00	1	073570047
48	13	321	202.00	1	073570048



METAL FREE



CE

S3 HRO SRC

7357V

Chaussure Montante en microfibre, hydrofuge, avec inserts en TPU
 Maintien de la stabilité du talon, glissement extensible sur le col et semelle extérieure en EVA avec bande de roulement en caoutchouc nitrile durable - S3 HRO SRC

- Embout composite
- Semelle antiperforation en fibre composite
- ULTRA LÉGER: poids approximatif pour la taille 42: 480 grammes

EN ISO 20345 2011

EU	UK	mm	CHF		
38	5	254	202.00	1	073570138
39	6	261	202.00	1	073570139
40	6,5	268	202.00	1	073570140
41	7	274	202.00	1	073570141
42	8	281	202.00	1	073570142
43	9	288	202.00	1	073570143
44	10	294	202.00	1	073570144
45	10,5	301	202.00	1	073570145
46	11	308	202.00	1	073570146
47	12	314	202.00	1	073570147
48	13	321	202.00	1	073570148



CE

S3 HRO SRC

7362B

Chaussure basse "occupational" en tissu mesh à haute respirabilité avec inserts en TPU
 Support de stabilité talon, col "slip on" élastifié pour faciliter le maintien
 et semelle en EVA avec semelle extérieure en caoutchouc nitrile haute résistance

- Sans embout
- Sans semelle anti-perforation
- LÉGÈRETÉ EXCEPTIONNELLE : poids indicatif taille 42: 330 grammes

EN ISO 20347 2012

EU	UK	mm	CHF		
39	6	261	155.50	1	073620039
40	6,5	268	155.50	1	073620040
41	7	274	155.50	1	073620041
42	8	281	155.50	1	073620042
43	9	288	155.50	1	073620043
44	10	294	155.50	1	073620044
45	10,5	301	155.50	1	073620045
46	11	308	155.50	1	073620046
47	12	314	155.50	1	073620047
48	13	321	155.50	1	073620048



CE

O1 FO HRO SRC

7363N

Chaussure basse "occupational" en tissu mesh hydrofuge avec inserts en TPU
 Support de stabilité talon, col "slip on" élastifié pour faciliter le maintien
 et semelle en EVA avec semelle extérieure en caoutchouc nitrile haute résistance

- Sans embout
- Sans semelle anti-perforation
- LÉGÈRETÉ EXCEPTIONNELLE : poids indicatif taille 42 : 330 grammes

EN ISO 20347 2012

EU	UK	mm	CHF		
39	6	261	162.00	1	073630039
40	6,5	268	162.00	1	073630040
41	7	274	162.00	1	073630041
42	8	281	162.00	1	073630042
43	9	288	162.00	1	073630043
44	10	294	162.00	1	073630044
45	10,5	301	162.00	1	073630045
46	11	308	162.00	1	073630046
47	12	314	162.00	1	073630047
48	13	321	162.00	1	073630048



CE

O2 FO HRO SRC

7371V

chaussure basse en tissu maillé à haute respirabilité.
 Maintien de la stabilité du talon, laçage traditionnel, chausse large.
 Semelle en EVA avec bande de roulement en caoutchouc nitrile durable.

- Embout en composite
- Semelle anti-perforation en fibre composite
- LÉGÈRETÉ EXCEPTIONNELLE : poids indicatif taille 42 : 450 grammes

EN ISO 20345 2022

EU	UK	mm	CHF		
38	5	254	177.50	1	073710038
39	6	261	177.50	1	073710039
40	6,5	268	177.50	1	073710040
41	7	274	177.50	1	073710041
42	8	281	177.50	1	073710042
43	9	288	177.50	1	073710043
44	10	294	177.50	1	073710044
45	10,5	301	177.50	1	073710045
46	11	308	177.50	1	073710046
47	12	314	177.50	1	073710047
48	13	321	177.50	1	073710048



CE

S1PS HRO FO SR ESD

7372B

Chaussure basse en tissu sans couture et à haute respirabilité. Maintien de la stabilité du talon, laçage traditionnel. Semelle extérieure en EVA avec bande de roulement en caoutchouc nitrile durable.

- Embout en composite
- Semelle anti-perforation en fibre composite
- EXTRÊMEMENT LÉGÈRE : poids approximatif pour la taille 42: 450 grammes

EN ISO 20345 2011

EU	UK	mm	CHF		
38	5	254	181.50	1	073720038
39	6	261	181.50	1	073720039
40	6.5	268	181.50	1	073720040
41	7	274	181.50	1	073720041
42	8	281	181.50	1	073720042
43	9	288	181.50	1	073720043
44	10	294	181.50	1	073720044
45	10.5	301	181.50	1	073720045
46	11	308	181.50	1	073720046
47	12	314	181.50	1	073720047
48	13	321	181.50	1	073720048



CE

S1P HRO SRC

7376A

Chaussure basse type sandale en microfibre aérée et tissu mesh à haute respirabilité. Maintien de la stabilité du talon, laçage traditionnel avec lacets extensibles. Semelle extérieure en EVA avec bande de roulement en caoutchouc nitrile durable.

- Embout en composite
- Semelle anti-perforation en fibre composite
- EXTRÊMEMENT LÉGÈRE : poids approximatif pour la taille 42: 490 grammes

EN ISO 20345 2011

EU	UK	mm	CHF		
38	5	254	184.00	1	073760038
39	6	261	184.00	1	073760039
40	6.5	268	184.00	1	073760040
41	7	274	184.00	1	073760041
42	8	281	184.00	1	073760042
43	9	288	184.00	1	073760043
44	10	294	184.00	1	073760044
45	10.5	301	184.00	1	073760045
46	11	308	184.00	1	073760046
47	12	314	184.00	1	073760047
48	13	321	184.00	1	073760048



CE

S1P HRO SRC

7381N

Chaussure basse imperméable en tissu hautement résistant à l'abrasion avec empiècements en TPU. Support de stabilité talon, laçage traditionnel, chausse large. Semelle extérieure en EVA avec bande de roulement en caoutchouc nitrile durable.

- Embout en composite
- Semelle anti-perforation en fibre composite
- Membrane imperméabilisante Beta TECH, avec système "bootie"
- LÉGÈRE : poids approximatif pour la taille 42 : 500 grammes

EN ISO 20345 2011

EU	UK	mm	CHF		
38	5	254	210.50	1	073810038
39	6	261	210.50	1	073810039
40	6.5	268	210.50	1	073810040
41	7	274	210.50	1	073810041
42	8	281	210.50	1	073810042
43	9	288	210.50	1	073810043
44	10	294	210.50	1	073810044
45	10.5	301	210.50	1	073810045
46	11	308	210.50	1	073810046
47	12	314	210.50	1	073810047
48	13	321	210.50	1	073810048



CE

S3 SRC HRO WR

7382N

Chaussure montante imperméable en tissu hautement résistant à l'abrasion avec empiècements en TPU. Support de stabilité talon, laçage traditionnel et chausse large. Semelle extérieure en EVA avec bande de roulement en caoutchouc nitrile durable.

- Embout en composite
- Semelle anti-perforation en fibre composite
- Membrane imperméabilisante Beta TECH, avec système "bootie"
- LÉGÈRE : poids approximatif pour la taille 42 : 550 grammes

EN ISO 20345 2011

EU	UK	mm	CHF		
38	5	254	236.00	1	073820038
39	6	261	236.00	1	073820039
40	6.5	268	236.00	1	073820040
41	7	274	236.00	1	073820041
42	8	281	236.00	1	073820042
43	9	288	236.00	1	073820043
44	10	294	236.00	1	073820044
45	10.5	301	236.00	1	073820045
46	11	308	236.00	1	073820046
47	12	314	236.00	1	073820047
48	13	321	236.00	1	073820048



CE

S3 SRC HRO WR

HEAVY DUTY



7293HM

Chaussure basse en cuir pleine fleur gras hydrofuge avec semelle extérieure en caoutchouc VIBRAM® à hautes prestations, insert anti-abrasion sur le talon et couvre-embout renforcé en polyuréthane

- Embout en fibre de verre
- Semelle anti-perforation en fibre composite

EN ISO 20345 2011



EU	UK	mm	CHF		
39	6	263	236.00	1	072930639
40	6,5	270	236.00	1	072930640
41	7	276	236.00	1	072930641
42	8	283	236.00	1	072930642
43	9	289	236.00	1	072930643
44	10	296	236.00	1	072930644
45	10,5	302	236.00	1	072930645
46	11	309	236.00	1	072930646
47	12	315	236.00	1	072930647
48	13	322	236.00	1	072930648



CE

S3 HRO HI SRC

7294HM

Chaussure montante en cuir pleine fleur gras hydrofuge avec semelle extérieure en caoutchouc VIBRAM® ad à hautes prestations, insert anti-abrasion sur le talon et couvre-embout renforcé en polyuréthane

- Embout en fibre de verre
- Semelle anti-perforation en fibre composite

EN ISO 20345 2011



EU	UK	mm	CHF		
39	6	263	249.50	1	072940639
40	6,5	270	249.50	1	072940640
41	7	276	249.50	1	072940641
42	8	283	249.50	1	072940642
43	9	289	249.50	1	072940643
44	10	296	249.50	1	072940644
45	10,5	302	249.50	1	072940645
46	11	309	249.50	1	072940646
47	12	315	249.50	1	072940647
48	13	322	249.50	1	072940648



CE

S3 HRO HI SRC

7294HMC

Chaussure montante en cuir pleine fleur gras hydrofuge avec semelle extérieure en caoutchouc VIBRAM® à hautes prestations, embout anti-abrasion sur le talon et couvre-embout renforcé en polyuréthane. Dotée de membrane Tepor, résistante à l'eau et au vent et extrêmement respirante

- Embout en fibre de verre
- Semelle anti-perforation en fibre composite

EN ISO 20345 2011



EU	UK	mm	CHF		
39	6	263	278.00	1	072940739
40	6,5	270	278.00	1	072940740
41	7	276	278.00	1	072940741
42	8	283	278.00	1	072940742
43	9	289	278.00	1	072940743
44	10	296	278.00	1	072940744
45	10,5	302	278.00	1	072940745
46	11	309	278.00	1	072940746
47	12	315	278.00	1	072940747
48	13	322	278.00	1	072940748



CE

S3 HRO HI CI WR SRC

ACCESSORIES

7398 0/G

Semelle intérieure anatomique en mousse EVA avec coussinet amortissant dans la zone du talon (pièce de rechange préconisée pour la ligne de chaussures 0-Gravity)



EU	UK	CHF		
38	5	9.55	1	073981238
39	6	9.55	1	073981239
40	6,5	9.55	1	073981240
41	7	9.55	1	073981241
42	8	9.55	1	073981242
43	9	9.55	1	073981243
44	10	9.55	1	073981244
45	10,5	9.55	1	073981245
46	11	9.55	1	073981246
47	12	9.55	1	073981247
48	13	9.55	1	073981248

7398ESD

Semelle intérieure de propreté anatomique, couche supérieure respirante et antibactérienne, empêche la formation de mauvaises odeurs. Remplacement pour chaussures avec certification ESD (ElectroStatic Discharge)



EU	UK	CHF		
35	2,5	11.00	1	073981435
36	3,5	11.00	1	073981436
37	4,5	11.00	1	073981437
38	5	11.00	1	073981438
39	6	11.00	1	073981439
40	6,5	11.00	1	073981440
41	7	11.00	1	073981441
42	8	11.00	1	073981442
43	9	11.00	1	073981443
44	10	11.00	1	073981444
45	10,5	11.00	1	073981445
46	11	11.00	1	073981446
47	12	11.00	1	073981447
48	13	11.00	1	073981448

7398T

Semelle anatomique WINTHERM, 70% polyester aluminisé, 30% polyéthylène, fabriqués en fibres synthétiques non tissées. Antistatique, respirante, absorbante, anti-odeur, antibactérien, antifongicide.



WINTHERM

EU	UK	CHF		
35	2,5	19.10	1	073981335
36	3,5	19.10	1	073981336
37	4,5	19.10	1	073981337
38	5	19.10	1	073981338
39	6	19.10	1	073981339
40	6,5	19.10	1	073981340
41	7	19.10	1	073981341
42	8	19.10	1	073981342
43	9	19.10	1	073981343
44	10	19.10	1	073981344
45	10,5	19.10	1	073981345
46	11	19.10	1	073981346
47	12	19.10	1	073981347
48	13	19.10	1	073981348

7398U

Semelle intérieure anatomique en TPR GEL avec effet amortissant prononcé, support de la voûte plantaire et coussinet dans la zone du talon



EU	UK	CHF		
36 - 40	3,5 - 6,5	17.70	1	073980058
41 - 46	7 - 11	17.70	1	073980063



7398UP

Semelles anatomique en TPE GEL parfumé aux agrumes, avec support de la voûte plantaire



EU	UK	CHF		
36 - 40	3,5 - 6	16.10	1	073980076
41 - 46	7 - 11	16.10	1	073980081

7398GEL

semelles anatomiques avec insert en gel



EU	UK	CHF		
35	2,5	5.85	1	073980835
36	3,5	5.85	1	073980836
37	4,5	5.85	1	073980837
38	5	5.85	1	073980838
39	6	5.85	1	073980839
40	6,5	5.85	1	073980840
41	7	5.85	1	073980841
42	8	5.85	1	073980842
43	9	5.85	1	073980843
44	10	5.85	1	073980844
45	10,5	5.85	1	073980845
46	11	5.85	1	073980846
47	12	5.85	1	073980847
48	13	5.85	1	073980848

7398EF

Semelle intérieure anatomique en mousse de polyuréthane avec talonnette amortissante



EU	UK	CHF		
35	2,5	11.20	1	073981135
36	3,5	11.20	1	073981136
37	4,5	11.20	1	073981137
38	5	11.20	1	073981138
39	6	11.20	1	073981139
40	6,5	11.20	1	073981140
41	7	11.20	1	073981141
42	8	11.20	1	073981142
43	9	11.20	1	073981143
44	10	11.20	1	073981144
45	10,5	11.20	1	073981145
46	11	11.20	1	073981146
47	12	11.20	1	073981147
48	13	11.20	1	073981148

7399 A/N...

Lot de 10 paires de lacets



cm	CHF		
100	21.10	1	073990010
120	24.80	1	073990012
140	30.00	1	073990017

Les prix indiqués se réfèrent aux 10 paires

7421

Chaussettes longues en éponge à élasto-compression renforcées en nylon et coton sur pointe et talon
Plante de pied en fibre de bambou, résistante, antimycotique et respirante



	EU	CHF		
M	39-42	22.40	1	074210002
L	43-46	22.40	1	074210004

7422P

Chaussettes courtes en éponge de coton recyclé, avec pointe et talon en éponge effet tremor
2 paires
choix de couleur :
noir avec inserts gris, orange et marron
gris avec inserts noirs, orange et marron



	EU	CHF		
M	39-42	19.50	1	074220102
L	43-46	19.50	1	074220104

7425

Chaussettes courtes avec inserts en texture respirante renforcées en nylon/coton sur pointe et talon
Plante de pied en nylon tressé avec fibre de bambou, antimycotique et respirante



	EU	CHF		
M	39-42	14.70	1	074250002
L	43-46	14.70	1	074250004

7426P

Chaussettes maxi sneaker en coton recyclé, avec plante du pied en coton éponge, pointe et talon avec effet tremor
2 paires
choix de couleur :
gris avec inserts noirs et bleu électrique
noir avec inserts bleu électrique et gris



	EU	CHF		
M	39-42	18.20	1	074260102
L	43-46	18.20	1	074260104

7427

Chaussettes maxi sneaker avec inserts de protection et respirantes sur la zone du tibia et du cou-de-pied.
Renforts en nylon et coton sur pointe et talon et plante de pied en fibre de bambou, résistante, antimycotique et respirante



	EU	CHF		
M	39-42	12.40	1	074270002
L	43-46	12.40	1	074270004

7430T

Chaussettes sneaker en coton recyclé, avec pointe et talon éponge effet tremor
3 paires
choix de couleur :
gris chiné avec inserts noirs et bordeaux
noir avec inserts gris
gris chiné avec inserts noirs



	EU	CHF		
M	39-42	23.40	1	074300202
L	43-46	23.40	1	074300204

7431P

Deux paires de chaussettes sneaker avec inserts en texture respirante et renforts en nylon/coton sur pointe et talon.

Plante de pied en nylon tressé avec fibre de bambou, résistante, antimycotique et respirante.
Une paire couleur noir/orange et une paire couleur noir/gris.



	EU	CHF		
M	39-42	11.00	1	074310102
L	43-46	11.00	1	074310104

VÊTEMENTS TECHNIQUES



La ligne de vêtements de travail a su gagner au fil des ans la confiance et la préférence des professionnels les plus exigeants. Le succès obtenu a généré une évolution et un enrichissement constants de la gamme d'offre.

Les vêtements produits par Beta Utensili S.p.A. sont conformes à la norme suivante: **EN ISO 13688:2013**
L'EPI protège l'utilisateur contre les risques physiques légers, tels que : petites abrasions, rayons solaires, vent, froid, poussières non nocives et souillure par des matériaux non toxiques. Cette protection correspond à la catégorie I du D.-L. italien n°. 475 du 04/12/1992.

MODE D'EMPLOI ET CONSERVATION

Ce vêtement doit être endossé correctement afin qu'il protège les parties du corps de l'utilisateur. Il doit être conservé en un lieu frais et sec, dans son emballage d'origine, à l'abri des sources de chaleur, des rayons solaires, de la poussière et des agents.

RÉTRÉCISSEMENT

Toutes les fibres naturelles rétrécissent après lavage à l'eau - Le rétrécissement peut varier de 1 % à 5 % en fonction de différents paramètres, notamment le type de fibre et la température de l'eau.

CORRESPONDANCE DES TAILLES

		I F D E UK USA					I F D E UK USA								
HOMME	XS	46	38	42	40	30	32	FEMME	XS	38	34	32	34	6	2
	S	48	40	44	42	32	34		S	40	36	34	36	8	4
	M	50	42	46	44	34	36		M	42	38	36	38	10	6
	L	52	44	48	46	36	38		L	44	40	38	40	12	8
	XL	54	46	50	48	38	40		XL	46	42	40	42	14	10
	2XL	56	48	52	50	40	42		2XL	48	44	42	44	16	12
3XL	58	50	54	52	42	44	3XL	50	46	44	46	18	14		
4XL	60	52	56	54	44	46									
5XL	62	54	58	56	46	48									

MESURES ANATOMIQUES EN ISO 13688:2013

HOMME		A		B		H				
		XS	S	M	L	XL	2XL	3XL	4XL	5XL
A	88-92	92-96	96-104	104-108	108-116	116-124	124-132	132-140	140-148	
B	79-83	83-87	87-91	91-95	95-100	100-107	107-112	112-120	120-128	
H	158-164	164-170	170-176	176-182	182-188	188-194	194-200	200-206	206-212	

FEMME		A		B		H		
		XS	S	M	L	XL	2XL	3XL
A	72-77	77-82	82-87	87-93	93-99	99-105	105-111	
B	162-165	164-167	168-171	170-173	172-175	174-177	176-179	

GUIDE DE SÉLECTION DES VÊTEMENTS PROGRAMME GÉNÉRAL 2024

Catégorie	Références Articles	Ligne	Page	Couleur	Assortiments conseillés (tissus et couleurs identiques au pantalon)										
					Bermuda	Page	Cotte	Page	Combinaison	Page	Gilet	Page	Veste	Page	
PANTALONS DE TRAVAIL LÉGERS	7610G	Trekking	653	■	7611G	657									
	7610N		653	■											
	7660B	Top Line	653	■	7661B	657									
	7660G		653	■	7661G	657									
	7830SN	Stretch	654	■	7831SN	657									
	7860G	Beta Easy	655	■	7861G	658	7863G	658	7865G	659	7867G	661	7869G	660	
	7860B		655	■	7861B	658			7865B	659	7867B	661			
7930MG	Cotton	656	■	7931MG	658			7935MG	659	7937MG	662				
PANTALONS DE TRAVAIL MULTI-SAISONS	7600G	Trekking	652	■											
	7600N		652	■											
	7650	Top Line	653	■								7653G	660		
	7650B		653	■											
	7818BL		654	■											
	7818CM		654	■	7815CM	657									
	7818G		654	■											
	7819G		654	■											
	7830ST	Stretch	655	■	7831ST	657									
	7840BL	Beta Easy	655	■								7849BL	660		
	7850G		655	■											
	7880SC	Stretch	655	■											
	7900B		656	■								7909B	660		
	7900G	Beta Easy	656	■	7901G	658	7903G	659	7905G	659	7907G	662	7909G	660	
7900P	656		■			7903P	659				7909P	660			
7900V	656		■								7909V	660			
7940	Multiprotection	656	■								7949	661			
7818LN	Lady	654	■												

GUIDE DE SÉLECTION DES VÊTEMENTS PROGRAMME GÉNÉRAL 2024

Catégorie	Références Articles	Ligne	Page	Couleur	Assortiments conseillés (tissus et couleurs identiques au pantalon)									
					Bermuda	Page	Cotte	Page	Combinaison	Page	Gilet	Page	Veste	Page
JEANS DE TRAVAIL	7530		652											
	7528		652		7529	657								
	7527		652											
POLOS	7547AZ		664		CORRESPOND À TOUS LES AUTRES ARTICLES SELON LES COMBINAISONS DE COULEURS									
	7547BL		665											
	7547G		665											
	7547N		665											
	7547R		665											
	7557BL		666											
T-SHIRTS	7548M		665		CORRESPOND À TOUS LES AUTRES ARTICLES SELON LES COMBINAISONS DE COULEURS									
	7548C		665											
	7549AZ		665											
	7549BL		665											
	7549G		665											
	7549N		666											
	7549NE		666											
	7549R		666											
	7550G	Top Line	666											
	7550N		666											
CHEMISES	7545F		664											
SWEATSHIRTS	7637G		663		CORRESPOND À TOUS LES AUTRES ARTICLES SELON LES COMBINAISONS DE COULEURS									
	7642G		663											
	7664G	Top Line	664											
	7664N		664											
	7665G		664											
	7665N		664											
VESTES ET PULLS MICRO-POLAIRES	7636N		663		CORRESPOND À TOUS LES AUTRES ARTICLES SELON LES COMBINAISONS DE COULEURS									
	7654B	Top Line	663											
	7654N		664											
	7657B		664											
	7657N		667											
GILETS SANS MANCHES	7575N		661		CORRESPOND À TOUS LES AUTRES ARTICLES SELON LES COMBINAISONS DE COULEURS									
	7579QN		661											
	7673NG	Top Line	661											
VESTES ET SOFTSHELLS	7658CM	Top Line	662		CORRESPOND À TOUS LES AUTRES ARTICLES SELON LES COMBINAISONS DE COULEURS									
	7659N		662											
	7669N		662											
VESTES REMBOURREES	7670G	Top Line	662		CORRESPOND À TOUS LES AUTRES ARTICLES SELON LES COMBINAISONS DE COULEURS									
	7674NG		663											
	7780QN		663											
	7750N		663											

GUIDE TO CHOOSING CLOTHING – PRICE LIST 2024

Catégorie	Références Articles	Ligne	Page	Couleur	Assortiments conseillés (tissus et couleurs identiques au pantalon)									
					Bermuda	Page	Cotte	Page	Combinaison	Page	Gilet	Page	Veste	Page
VÊTEMENTS IMPERMÉABLES	7970	Pantalons	666										7979	667
	7971L	Pantalons	667										7978L	667
	7981N	bob de pluie	668											
ACCESSOIRES	7980NC	Bonnet	668		CORRESPOND À TOUS LES AUTRES ARTICLES SELON LES COMBINAISONS DE COULEURS									
	7980RN	Bonnet	668											
	7980L	Bonnet avec lumière	668											
	7982N	Casquette	668											
	7984EG	Ceinture	668											
	7984G	Ceinture	668											
	7985N	Cache-cou	668											
	7996N	Sous vêtements techniques	667											

PANTS



7527

Jean de travail
en tissu 70 % coton, 27 % polyester et 3 %
stretch
Regular fit

CE

Jeans



TAILLE	I	CHF	👤	📄
XS	46	71.50	1	075270046
S	48	71.50	1	075270048
M	50	71.50	1	075270050
L	52	71.50	1	075270052
XL	54	71.50	1	075270054
XXL	56	71.50	1	075270056
XXXL	58	71.50	1	075270058

7528

Pantalon jeans de travail élastifié,
98 % coton et 2 % tissu élastifié,
Portabilité sèche

CE

Jeans



TAILLE	I	CHF	👤	📄
XS	46	78.50	1	075280046
S	48	78.50	1	075280048
M	50	78.50	1	075280050
L	52	78.50	1	075280052
XL	54	78.50	1	075280054
XXL	56	78.50	1	075280056
XXXL	58	78.50	1	075280058

7530

Pantalon jeans de travail extensible,
98 % coton et 2 % tissu stretch, avec renforts
en polyester
Slim fit

CE

Jeans



TAILLE	I	CHF	👤	📄
XS	46	92.50	1	075300046
S	48	92.50	1	075300048
M	50	92.50	1	075300050
L	52	92.50	1	075300052
XL	54	92.50	1	075300054
XXL	56	92.50	1	075300056
XXXL	58	92.50	1	075300058

7600G

Pantalon "work trekking" HEAVY
90 % nylon, 10 % tissu stretch, 265 g/m²,
tissu renforcé sur les genoux et le dos, bas de
jambes élastiqué avec fermeture éclair
verticale

Gris foncé avec détails vert fluo
Portabilité sèche

CE

**TREKKING
HEAVY**



TAILLE	I	CHF	👤	📄
XS	46	96.00	1	076000000
S	48	96.00	1	076000001
M	50	96.00	1	076000002
L	52	96.00	1	076000003
XL	54	96.00	1	076000004
XXL	56	96.00	1	076000005
XXXL	58	96.00	1	076000006

7600N

Pantalon "work trekking" HEAVY
90 % nylon, 10 % tissu stretch, 265 g/m²,
tissu renforcé sur les genoux et le dos, bas de
jambes élastiqué avec fermeture éclair
verticale

Noir avec détails vert fluo
Portabilité sèche

CE

**TREKKING
HEAVY**



TAILLE	I	CHF	👤	📄
XS	46	96.00	1	076000100
S	48	96.00	1	076000101
M	50	96.00	1	076000102
L	52	96.00	1	076000103
XL	54	96.00	1	076000104
XXL	56	96.00	1	076000105
XXXL	58	96.00	1	076000106

7610G

Pantalon "work trekking" LIGHT
90 % nylon, 10 % tissu 10 stretch, 140 g/m²,
tissu renforcé aux genoux et au dos, bas de
jambe élastiqué et réglable par cordons de
serrage
Gris foncé avec détails jaunes
Portabilité sèche

CE

TREKKING
LIGHT

	I	CHF		
XS	46	93.50	1	076100000
S	48	93.50	1	076100001
M	50	93.50	1	076100002
L	52	93.50	1	076100003
XL	54	93.50	1	076100004
XXL	56	93.50	1	076100005
XXXL	58	93.50	1	076100006

7610N

Pantalon "work trekking" LIGHT
90 % nylon, 10 % tissu 10 stretch, 140 g/m²,
tissu renforcé aux genoux et au dos, bas de
jambe élastiqué et réglable par cordon de
serrage
Noir avec détails jaunes
Portabilité sèche

CE

TREKKING
LIGHT

	I	CHF		
XS	46	93.50	1	076100100
S	48	93.50	1	076100101
M	50	93.50	1	076100102
L	52	93.50	1	076100103
XL	54	93.50	1	076100104
XXL	56	93.50	1	076100105
XXXL	58	93.50	1	076100106

7650

Pantalon de travail multipoches élastique
90 % nylon - 10 % spandex, 260 g/m², gris
anthracite
Poches pour genouillères, poches arrière et
bas de jambe renforcés en
polyester 600D, entrejambe antidéchirure

CE

TOP
line

	I	CHF		
XS	46	121.50	1	076500000
S	48	121.50	1	076500001
M	50	121.50	1	076500002
L	52	121.50	1	076500003
XL	54	121.50	1	076500004
XXL	56	121.50	1	076500005
XXXL	58	121.50	1	076500006

7650B

pantalon de travail stretch, multipoches,
90 % nylon - 10 % élasthanne, 260 g/m², bleu
Poches pour genouillères, poches arrière et
bas de jambe renforcées en polyester 600D,
rempiècement à l'entrejambe

CE

TOP
line

	I	CHF		
XS	46	121.50	1	076500100
S	48	121.50	1	076500101
M	50	121.50	1	076500102
L	52	121.50	1	076500103
XL	54	121.50	1	076500104
XXL	56	121.50	1	076500105
XXXL	58	121.50	1	076500106

7660B

pantalon de travail Bleu stretch, léger,
multipoches,
86% nylon - 14% élasthanne, 140 g / m²,
Poches pour genouillères, poches arrière
renforcées en polyester 300D, Rempiècement
à l'entrejambe.
Coupe ajustée

CE

TOP
line

	I	CHF		
XS	46	104.50	1	076600100
S	48	104.50	1	076600101
M	50	104.50	1	076600102
L	52	104.50	1	076600103
XL	54	104.50	1	076600104
XXL	56	104.50	1	076600105
XXXL	58	104.50	1	076600106

7660G

pantalon de travail Gris stretch, léger,
multipoches, 86% nylon - 14% élasthanne,
140 g / m², Poches pour genouillères, poches
arrière renforcées en polyester 300D,
Rempiècement à l'entrejambe.
Coupe ajustée

CE

TOP
line

	I	CHF		
XS	46	104.50	1	076600000
S	48	104.50	1	076600001
M	50	104.50	1	076600002
L	52	104.50	1	076600003
XL	54	104.50	1	076600004
XXL	56	104.50	1	076600005
XXXL	58	104.50	1	076600006

7818G

Pantalon de travail multipoches en T/C canvas, 260 g/m², gris

Poches pour genouillères et bas de jambes renforcés en polyester 300D, entrejambe antidéchirure et inserts en tissu extensible à l'intérieur de la jambe et dans la zone lombaire pour faciliter le mouvement

CE



TAILLE	I	CHF	👤	📄
XS	46	93.50	1	078180000
S	48	93.50	1	078180001
M	50	93.50	1	078180002
L	52	93.50	1	078180003
XL	54	93.50	1	078180004
XXL	56	93.50	1	078180005
XXXL	58	93.50	1	078180006

7818BL

Pantalon de travail multipoches en T/C canvas, 260 g/m², bleu

Insert en tissu extensible à l'intérieur de la jambe Poches pour genouillères et bas de jambes renforcés en polyester 300D, entrejambe antidéchirure et inserts en tissu extensible à l'intérieur de la jambe et dans la zone lombaire pour faciliter le mouvement

CE



TAILLE	I	CHF	👤	📄
XS	46	93.50	1	078180100
S	48	93.50	1	078180101
M	50	93.50	1	078180102
L	52	93.50	1	078180103
XL	54	93.50	1	078180104
XXL	56	93.50	1	078180105
XXXL	58	93.50	1	078180106

7818CM

Pantalon de travail multipoches en T/C canvas, 260 g/m², gris camouflage

Poches pour genouillères et bas de jambes renforcés en polyester 300D, empiècement à l'entrejambe et inserts en tissu extensible dans l'entrejambe et dans la zone lombaire pour faciliter le mouvement

CE



TAILLE	I	CHF	👤	📄
XS	46	99.00	1	078180300
S	48	99.00	1	078180301
M	50	99.00	1	078180302
L	52	99.00	1	078180303
XL	54	99.00	1	078180304
XXL	56	99.00	1	078180305
XXXL	58	99.00	1	078180306

7818LN

Pantalon de travail multipoches pour femme, noir avec inserts roses,

100% coton extensible, 220 g/m² Poches pour genouillères et bas de jambes renforcés en polyester 300D, rempiècement à l'entrejambe et insert en tissu extensible à l'intérieur de la jambe pour faciliter le mouvement

CE

lady



TAILLE	I	CHF	👤	📄
XS	38	93.50	1	078180200
S	40	93.50	1	078180201
M	42	93.50	1	078180202
L	44	93.50	1	078180203
XL	46	93.50	1	078180204
XXL	48	93.50	1	078180205
XXXL	50	93.50	1	078180206

7819G

Pantalon de travail multipoches avec poches amovibles flying pockets, en T/C Canvas 260 g/m², gris

Poches pour genouillères et bas de jambes renforcés en polyester 300D, empiècement stretch à l'entrejambe et dans la zone lombaire pour faciliter le mouvement

CE



TAILLE	I	CHF	👤	📄
XS	46	93.50	1	078190000
S	48	93.50	1	078190001
M	50	93.50	1	078190002
L	52	93.50	1	078190003
XL	54	93.50	1	078190004
XXL	56	93.50	1	078190005
XXXL	58	93.50	1	078190006

7830SN

Pantalon de travail extensible

en T/C twill, 200 g/m², noir Coupe slim, rempiècement à l'entrejambe et taille extensible sur les côtes

CE

STRETCH



TAILLE	I	CHF	👤	📄
XS	46	83.00	1	078300100
S	48	83.00	1	078300101
M	50	83.00	1	078300102
L	52	83.00	1	078300103
XL	54	83.00	1	078300104
XXL	56	83.00	1	078300105
XXXL	58	83.00	1	078300106

7830ST

pantalon de travail élastifié coupe ajustée en T/C twill 250 g/m², gris entrejambe antidéchirure et taille élastiquée

CE

STRETCH



taille	I	CHF	👤	📦
XS	46	83.00	1	078300000
S	48	83.00	1	078300001
M	50	83.00	1	078300002
L	52	83.00	1	078300003
XL	54	83.00	1	078300004
XXL	56	83.00	1	078300005
XXXL	58	83.00	1	078300006

7840BL

Pantalon de travail en T/C twill, 245 g/m², bleu Taille élastiquée

CE

Beta EASY



taille	I	CHF	👤	📦
XS	46	53.50	1	078400100
S	48	53.50	1	078400101
M	50	53.50	1	078400102
L	52	53.50	1	078400103
XL	54	53.50	1	078400104
XXL	56	53.50	1	078400105
XXXL	58	53.50	1	078400106
XXXXL	60	53.50	1	078400107

7850G

Pantalon de travail "cargo", 100 % coton, 240 g/m², taille extensible sur les côtés et grandes poches latérales avec inserts réfléchissants, gris avec détails vert fluo Coupe slim

CE



taille	I	CHF	👤	📦
XS	46	60.50	1	078500100
S	48	60.50	1	078500101
M	50	60.50	1	078500102
L	52	60.50	1	078500103
XL	54	60.50	1	078500104
XXL	56	60.50	1	078500105
XXXL	58	60.50	1	078500106
XXXXL	60	60.50	1	078500107

7860B

Pantalon de travail léger Bleu en tissu Sergé T/C, 180 g/m², avec inserts Oxford

CE



taille	I	CHF	👤	📦
XS	46	69.00	1	078600700
S	48	69.00	1	078600701
M	50	69.00	1	078600702
L	52	69.00	1	078600703
XL	54	69.00	1	078600704
XXL	56	69.00	1	078600705
XXXL	58	69.00	1	078600706
XXXXL	60	69.00	1	078600707
5XL	62	69.00	1	078600708

7860G

Pantalon de travail léger en T/C twill, 180 g/m², avec empiècements en Oxford, gris Nouveau design - Confort amélioré

CE

Beta EASY

LIGHT



taille	I	CHF	👤	📦
XS	46	69.00	1	078600800
S	48	69.00	1	078600801
M	50	69.00	1	078600802
L	52	69.00	1	078600803
XL	54	69.00	1	078600804
XXL	56	69.00	1	078600805
XXXL	58	69.00	1	078600806
XXXXL	60	69.00	1	078600807
5XL	62	69.00	1	078600808

7880SC

Pantalon de travail élastifié en T/C canvas 290 g/m², noir Coupe ajustée, entrejambe antidéchirure et taille élastiquée

CE

STRETCH



taille	I	CHF	👤	📦
XS	46	84.50	1	078800000
S	48	84.50	1	078800001
M	50	84.50	1	078800002
L	52	84.50	1	078800003
XL	54	84.50	1	078800004
XXL	56	84.50	1	078800005
XXXL	58	84.50	1	078800006

7900B

Pantalon de travail
en T/C canvas, 260 g/m², avec empiècements
en Oxford, bleu

CE

Beta EASY



taille	I	CHF	📄	📄
XS	46	76.00	1	079000700
S	48	76.00	1	079000701
M	50	76.00	1	079000702
L	52	76.00	1	079000703
XL	54	76.00	1	079000704
XXL	56	76.00	1	079000705
XXXL	58	76.00	1	079000706
XXXXL	60	76.00	1	079000707

7900G

Pantalon de travail
en T/C canvas, 260 g/m², avec empiècements
en Oxford, gris
Nouveau design - Confort amélioré

CE

Beta EASY



taille	I	CHF	📄	📄
XS	46	76.00	1	079000800
S	48	76.00	1	079000801
M	50	76.00	1	079000802
L	52	76.00	1	079000803
XL	54	76.00	1	079000804
XXL	56	76.00	1	079000805
XXXL	58	76.00	1	079000806
XXXXL	60	76.00	1	079000807

7900P

Pantalon de travail
en T/C canvas, 260 g/m², avec empiècements
en Oxford, bleu pétrole

CE

Beta EASY



taille	I	CHF	📄	📄
XS	46	76.00	1	079000600
S	48	76.00	1	079000601
M	50	76.00	1	079000602
L	52	76.00	1	079000603
XL	54	76.00	1	079000604
XXL	56	76.00	1	079000605
XXXL	58	76.00	1	079000606
XXXXL	60	76.00	1	079000607

7900V

Pantalon de travail
en T/C canvas, 260 g/m², avec empiècements
en Oxford, vert

CE

Beta EASY



taille	I	CHF	📄	📄
XS	46	76.00	1	079000500
S	48	76.00	1	079000501
M	50	76.00	1	079000502
L	52	76.00	1	079000503
XL	54	76.00	1	079000504
XXL	56	76.00	1	079000505
XXXL	58	76.00	1	079000506
XXXXL	60	76.00	1	079000507

7930MG

Pantalon de travail gris, multipoches, 97%
coton, 3% tissu stretch, 220 g/m²

CE

Cotton



taille	I	CHF	📄	📄
XS	46	77.50	1	079300400
S	48	77.50	1	079300401
M	50	77.50	1	079300402
L	52	77.50	1	079300403
XL	54	77.50	1	079300404
XXL	56	77.50	1	079300405
XXXL	58	77.50	1	079300406

7940

pantalon de travail multi-protection
250 g/m², bleu,
pour la protection contre la chaleur, les
flammes, les effets d'arc électrique, les risques
de soudage et les produits chimiques.

CE



DPI: III^A Categoria
EN ISO 11611:2015 - Classe 1
EN ISO 11612:2015 - A1 B1 C1
EN 1149-5:2018
EN13034:2005+A1:2009 - Type 6
IEC 61482-2:2018 - APC 1

taille	I	CHF	📄	📄
XS	46	111.00	1	079400000
S	48	111.00	1	079400001
M	50	111.00	1	079400002
L	52	111.00	1	079400003
XL	54	111.00	1	079400004
XXL	56	111.00	1	079400005
XXXL	58	111.00	1	079400006
XXXXL	60	111.00	1	079400007

BERMUDA



7529

Bermuda jeans de travail élastifié
98 % coton et 2 % tissu élastifié
Portabilité sèche

CE

Jeans



	I	CHF		
XS	46	62.50	1	075290046
S	48	62.50	1	075290048
M	50	62.50	1	075290050
L	52	62.50	1	075290052
XL	54	62.50	1	075290054
XXL	56	62.50	1	075290056
XXXL	58	62.50	1	075290058

7611G

Bermuda "work trekking" LIGHT
90 % nylon, 10 % tissu stretch, 140 g/m²,
tissu renforcé au dos.
Gris foncé avec détails jaunes
Portabilité sèche

CE

TREKKING
LIGHT



	I	CHF		
XS	46	71.50	1	076110000
S	48	71.50	1	076110001
M	50	71.50	1	076110002
L	52	71.50	1	076110003
XL	54	71.50	1	076110004
XXL	56	71.50	1	076110005
XXXL	58	71.50	1	076110006

7661B

Bermuda de travail Bleu stretch, léger, style
multipoches,
86% nylon - 14% élasthanne, 140 g / m²,
Poches arrière renforcées en polyester 300D,
entrejambe indéchirable
Coupe ajustée

CE



TOP
line



	I	CHF		
XS	46	91.00	1	076610100
S	48	91.00	1	076610101
M	50	91.00	1	076610102
L	52	91.00	1	076610103
XL	54	91.00	1	076610104
XXL	56	91.00	1	076610105
XXXL	58	91.00	1	076610106

7661G

Bermuda de travail Gris stretch, léger, style
multipoches,
86% nylon - 14% élasthanne, 140 g / m²,
Poches arrière renforcées en polyester 300D,
entrejambe indéchirable
Coupe ajustée

CE



TOP
line



	I	CHF		
XS	46	91.00	1	076610000
S	48	91.00	1	076610001
M	50	91.00	1	076610002
L	52	91.00	1	076610003
XL	54	91.00	1	076610004
XXL	56	91.00	1	076610005
XXXL	58	91.00	1	076610006

Beta

7815CM

bermuda de travail multipoches en T/C
canvas, 260 g/m², gris camouflage,
empiècement à l'entrejambe et inserts en tissu
extensible dans l'entrejambe et dans la zone
lombaire pour faciliter le mouvement

CE



	I	CHF		
XS	46	77.50	1	078150300
S	48	77.50	1	078150301
M	50	77.50	1	078150302
L	52	77.50	1	078150303
XL	54	77.50	1	078150304
XXL	56	77.50	1	078150305
XXXL	58	77.50	1	078150306

7831SN

Bermuda de travail extensible
en T/C twill, 200 g/m², noir
Coupe slim, rempiècement à l'entrejambe et
taille extensible sur les côtes

CE



	I	CHF		
XS	46	63.00	1	078310100
S	48	63.00	1	078310101
M	50	63.00	1	078310102
L	52	63.00	1	078310103
XL	54	63.00	1	078310104
XXL	56	63.00	1	078310105
XXXL	58	63.00	1	078310106

7831ST

Bermuda de travail élastifié
en T/C twill 250 g/m², gris
Coupe ajustée, entrejambe antidéchirure et
taille élastifié

CE



	I	CHF		
XS	46	63.00	1	078310000
S	48	63.00	1	078310001
M	50	63.00	1	078310002
L	52	63.00	1	078310003
XL	54	63.00	1	078310004
XXL	56	63.00	1	078310005
XXXL	58	63.00	1	078310006

7861G

Bermuda de travail léger
en T/C twill, 180 g/m², avec empiècements en
Oxford, gris
Nouveau design - Confort amélioré

BetaEASY

CE

LIGHT



		CHF		
XS	46	57.00	1	078610800
S	48	57.00	1	078610801
M	50	57.00	1	078610802
L	52	57.00	1	078610803
XL	54	57.00	1	078610804
XXL	56	57.00	1	078610805
XXXL	58	57.00	1	078610806
XXXXL	60	57.00	1	078610807
5XL	62	57.00	1	078610808

7861B

Bermuda de travail léger bleu,
en tissu sergé T/C, 180 g/m², avec inserts
Oxford

BetaEASY

CE

LIGHT



		CHF		
XS	46	57.00	1	078610700
S	48	57.00	1	078610701
M	50	57.00	1	078610702
L	52	57.00	1	078610703
XL	54	57.00	1	078610704
XXL	56	57.00	1	078610705
XXXL	58	57.00	1	078610706
XXXXL	60	57.00	1	078610707
5XL	62	57.00	1	078610708

Beta

7901G

Bermuda de travail
en T/C canvas, 260 g/m², avec empiècements
en Oxford, gris
Nouveau design - Confort amélioré

BetaEASY

CE



		CHF		
XS	46	61.50	1	079010800
S	48	61.50	1	079010801
M	50	61.50	1	079010802
L	52	61.50	1	079010803
XL	54	61.50	1	079010804
XXL	56	61.50	1	079010805
XXXL	58	61.50	1	079010806
XXXXL	60	61.50	1	079010807

7931MG

Bermuda de travail gris, 97% coton, 3% tissu
stretch, 220 g/m²

CE

Cotton



		CHF		
XS	46	62.50	1	079310400
S	48	62.50	1	079310401
M	50	62.50	1	079310402
L	52	62.50	1	079310403
XL	54	62.50	1	079310404
XXL	56	62.50	1	079310405
XXXL	58	62.50	1	079310406

OVERALLS

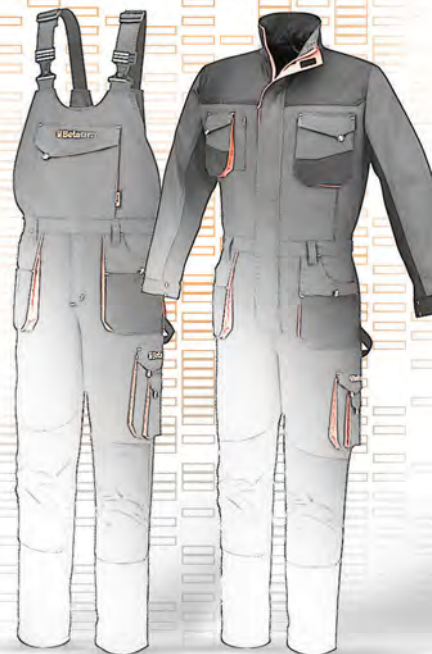

7863G

Cotte de travail légère
en T/C twill, 180 g/m², avec empiècements en
Oxford, grise
Nouveau design - Confort amélioré

BetaEASY

CE

LIGHT



		CHF		
XS		84.50	1	078630800
S		84.50	1	078630801
M		84.50	1	078630802
L		84.50	1	078630803
XL		84.50	1	078630804
XXL		84.50	1	078630805
XXXL		84.50	1	078630806
XXXXL		84.50	1	078630807
5XL		84.50	1	078630808

7903G

Cotte de travail
en T/C canvas, 260 g/m², avec empiècements
en Oxford, grise
Nouveau design - Confort amélioré

CE 



	CHF		
XS	95.50	1	079030800
S	95.50	1	079030801
M	95.50	1	079030802
L	95.50	1	079030803
XL	95.50	1	079030804
XXL	95.50	1	079030805
XXXL	95.50	1	079030806
XXXXL	95.50	1	079030807

7903P

Cotte de travail
en T/C canvas, 260 g/m², avec empiècements
en Oxford, bleu pétrole

CE 



	CHF		
XS	95.50	1	079030600
S	95.50	1	079030601
M	95.50	1	079030602
L	95.50	1	079030603
XL	95.50	1	079030604
XXL	95.50	1	079030605
XXXL	95.50	1	079030606
XXXXL	95.50	1	079030607

7865B

Combinaison de travail légère bleu en sergé
T/C, 180 g/m², avec inserts Oxford

CE 

LIGHT



	CHF		
XS	110.00	1	078650700
S	110.00	1	078650701
M	110.00	1	078650702
L	110.00	1	078650703
XL	110.00	1	078650704
XXL	110.00	1	078650705
XXXL	110.00	1	078650706
XXXXL	110.00	1	078650707
5XL	110.00	1	078650708

7865G

Combinaison de travail légère
en T/C twill, 180 g/m², avec empiècements en
Oxford, grise
Nouveau design - Confort amélioré

CE 

LIGHT



	CHF		
XS	110.00	1	078650800
S	110.00	1	078650801
M	110.00	1	078650802
L	110.00	1	078650803
XL	110.00	1	078650804
XXL	110.00	1	078650805

	CHF		
XXXL	110.00	1	078650806
XXXXL	110.00	1	078650807
5XL	110.00	1	078650808

7905G

Combinaison de travail
en T/C canvas, 260 g/m², avec empiècements
en Oxford, grise
Nouveau design - Confort amélioré

CE 



	CHF		
XS	119.00	1	079050800
S	119.00	1	079050801
M	119.00	1	079050802
L	119.00	1	079050803
XL	119.00	1	079050804
XXL	119.00	1	079050805
XXXL	119.00	1	079050806
XXXXL	119.00	1	079050807

7935MG

Combinaison de travail grise 97% coton, 3%
tissu stretch, 220 g/m²

CE 



	CHF		
XS	136.00	1	079350400
S	136.00	1	079350401
M	136.00	1	079350402
L	136.00	1	079350403
XL	136.00	1	079350404
XXL	136.00	1	079350405
XXXL	136.00	1	079350406

WORK JACKETS



7653G

Veste de travail extensible multipoches
90% nylon -10% spandex, 260 g/m², gris anthracite

CE



TOP line



TAILLE	CHF	ART.
XS	122.00	1 076530000
S	122.00	1 076530001
M	122.00	1 076530002
L	122.00	1 076530003
XL	122.00	1 076530004
XXL	122.00	1 076530005
XXXL	122.00	1 076530006

7849BL

Veste de travail en T/C twill, 245 g/m², bleu
Taille élastiquée

CE

Beta EASY



TAILLE	CHF	ART.
XS	57.00	1 078490100
S	57.00	1 078490101
M	57.00	1 078490102
L	57.00	1 078490103
XL	57.00	1 078490104
XXL	57.00	1 078490105
XXXL	57.00	1 078490106
XXXXL	57.00	1 078490107

7869G

Veste de travail légère
en T/C twill, 180 g/m², avec empiècements en Oxford, grise
Nouveau design - Confort amélioré

CE

Beta EASY

LIGHT



TAILLE	CHF	ART.
XS	74.50	1 078690800
S	74.50	1 078690801
M	74.50	1 078690802
L	74.50	1 078690803
XL	74.50	1 078690804
XXL	74.50	1 078690805
XXXL	74.50	1 078690806
XXXXL	74.50	1 078690807
5XL	74.50	1 078690808

7909B

Veste de travail
en T/C canvas, 260 g/m², avec empiècements en Oxford, bleu

CE

Beta EASY



TAILLE	CHF	ART.
XS	84.50	1 079090700
S	84.50	1 079090701
M	84.50	1 079090702
L	84.50	1 079090703
XL	84.50	1 079090704
XXL	84.50	1 079090705
XXXL	84.50	1 079090706
XXXXL	84.50	1 079090707

7909G

Veste de travail
en T/C canvas, 260 g/m², avec empiècements en Oxford, grise
Nouveau design - Confort amélioré

CE

Beta EASY



TAILLE	CHF	ART.
XS	84.50	1 079090800
S	84.50	1 079090801
M	84.50	1 079090802
L	84.50	1 079090803
XL	84.50	1 079090804
XXL	84.50	1 079090805
XXXL	84.50	1 079090806
XXXXL	84.50	1 079090807

7909P

Veste de travail
en T/C canvas, 260 g/m², avec empiècements en Oxford, bleu pétrole

CE

Beta EASY



TAILLE	CHF	ART.
XS	84.50	1 079090600
S	84.50	1 079090601
M	84.50	1 079090602
L	84.50	1 079090603
XL	84.50	1 079090604
XXL	84.50	1 079090605
XXXL	84.50	1 079090606
XXXXL	84.50	1 079090607

7909V

Veste de travail
en T/C canvas, 260 g/m², avec empiècements en Oxford, vert

CE

Beta EASY



TAILLE	CHF	ART.
XS	84.50	1 079090500
S	84.50	1 079090501
M	84.50	1 079090502
L	84.50	1 079090503
XL	84.50	1 079090504
XXL	84.50	1 079090505
XXXL	84.50	1 079090506
XXXXL	84.50	1 079090507

Beta

7949

veste de travail multi-protection,
250 g / m², bleu,
pour la protection contre la chaleur, les
flammes, les effets d'arc électrique, soudure et
produits chimiques.

CE

DPI: III^A Categoria
EN ISO 11611:2015 - Classe 1
EN ISO 11612:2015 - A1 B1 C1
EN 1149-5:2018
EN13034:2005+A1:2009 - Type 6
IEC 61482-2:2018 - APC 1



	CHF		
XS	128.00	1	079490000
S	128.00	1	079490001
M	128.00	1	079490002
L	128.00	1	079490003
XL	128.00	1	079490004
XXL	128.00	1	079490005
XXXL	128.00	1	079490006
XXXXL	128.00	1	079490007

SLEEVELESS JACKETS



7575N

Gilet en Softshell
90 % nylon, 10 % tissu élastifié, 250 g/m²



	CHF		
S	112.50	1	075750301
M	112.50	1	075750302
L	112.50	1	075750303
XL	112.50	1	075750304
XXL	112.50	1	075750305
XXXL	112.50	1	075750306

7579QN

Gilet de travail multipoches en double matière.
100% nylon imperméable 300D et tissu
softshell 96 % polyester, 4 % spandex,
matelassé en polyester 160 g/m²
noir/gris anthracite

CE



	CHF		
S	97.00	1	075790201
M	97.00	1	075790202
L	97.00	1	075790203
XL	97.00	1	075790204
XXL	97.00	1	075790205
XXXL	97.00	1	075790206

7673NG

veste de travail sans manches avec
rembourrage en GRAPHENE, 80 g/m², torse
renforcé en tissu softshell - 96 % polyester,
4% élasthanne et dos en 100 % nylon 20D
gris anthracite (sur le devant), noir (sur le
derrière)
Empiècement stretch aux emmanchures,
antistatique, antibactérien et coupe-vent

CE

TOP
LINE



	CHF		
S	123.50	1	076730001
M	123.50	1	076730002
L	123.50	1	076730003
XL	123.50	1	076730004
XXL	123.50	1	076730005
XXXL	123.50	1	076730006

Beta

Beta

7867B

Gilet de travail léger bleu, en sergé T/C, 180 g/ m², avec inserts Oxford

CE

Beta EASY

LIGHT



	CHF		
XS	63.50	1	078670700
S	63.50	1	078670701
M	63.50	1	078670702
L	63.50	1	078670703
XL	63.50	1	078670704
XXL	63.50	1	078670705
XXXL	63.50	1	078670706
XXXXL	63.50	1	078670707
5XL	63.50	1	078670708

7867G

Gilet de travail léger
en T/C twill, 180 g/m², avec empiècements en
Oxford, gris
Nouveau design - Confort amélioré

CE

Beta EASY

LIGHT



	CHF		
XS	63.50	1	078670800
S	63.50	1	078670801
M	63.50	1	078670802
L	63.50	1	078670803
XL	63.50	1	078670804
XXL	63.50	1	078670805
XXXL	63.50	1	078670806
XXXXL	63.50	1	078670807
5XL	63.50	1	078670808

7907G

Gilet de travail
en T/C canvas, 260 g/m², avec empiècements
en Oxford, gris
Nouveau design - Confort amélioré

CE

Beta EASY



	CHF	
XS	71.00	1 079070800
S	71.00	1 079070801
M	71.00	1 079070802
L	71.00	1 079070803
XL	71.00	1 079070804
XXL	71.00	1 079070805
XXXL	71.00	1 079070806
XXXXL	71.00	1 079070807

7937MG

Gilet de travail gris 97% coton, 3% tissu
stretch, 220 g/m²

CE

Cotton



	CHF	
XS	72.00	1 079370400
S	72.00	1 079370401
M	72.00	1 079370402
L	72.00	1 079370403
XL	72.00	1 079370404
XXL	72.00	1 079370405
XXXL	72.00	1 079370406

JACKETS



7658CM

veste softshell, 94% polyester, 6% élasthanne,
290 g/m², gris camouflage
Avec membrane TPU imperméable, respirante
et coupe-vent
(résistance aux colonnes d'eau jusqu'à 8 000
mm - respirabilité 8 000 mvp)

TOP line



	CHF	
S	153.50	1 076580101
M	153.50	1 076580102
L	153.50	1 076580103
XL	153.50	1 076580104
XXL	153.50	1 076580105
XXXL	153.50	1 076580106

7659N

Veste en Softshell, 94 % polyester, 6 % spandex,
290 g/m², avec capuche et manches amovibles,
noire Munie de membrane TPU imperméabilisée,
coupe-vent et transpirante (résistance à colonnes
d'eau 8.000 mm -transpirabilité 8.000 mvp)

TOP line



	CHF	
S	197.50	1 076590001
M	197.50	1 076590002
L	197.50	1 076590003
XL	197.50	1 076590004
XXL	197.50	1 076590005
XXXL	197.50	1 076590006

7669N

veste de travail noire extensible, légère, style
multipoches, 86% nylon, 14% élasthane, 140
g-m²,
Avec manches amovibles et capuche
rétractable.
Résistant à l'eau, coupe-vent



TOP line



	CHF	
XS	138.00	1 076690000
S	138.00	1 076690001
M	138.00	1 076690002
L	138.00	1 076690003
XL	138.00	1 076690004
XXL	138.00	1 076690005
XXXL	138.00	1 076690006

7670G

Anorak en polyester Oxford 300D,
imperméable, enduit PU, gris anthracite
Avec capuche amovible et manches
renforcées, coupe-vent et respirante
(résistance aux colonnes d'eau jusqu'à 2 000
mm - respirabilité 2 000 mvp)
Doublure en polyester 210T, rembourrage en
polyester, corps en 120 g/m², manches en 100
g/m²

CE

TOP line



	CHF	
S	138.00	1 076700001
M	138.00	1 076700002
L	138.00	1 076700003
XL	138.00	1 076700004
XXL	138.00	1 076700005
XXXL	138.00	1 076700006

Beta

Beta



7674NG

veste de travail matelassée avec rembourrage en GRAPHENE, 80 g/m², torse et avant-bras renforcés en tissu softshell - 96 % polyester, 4% élasthanne, dos et manches en 100 % nylon 20D, gris anthracite (sur le devant), noir (sur le derrière), poignets extensibles

CE
TOP
line



	CHF		
S	153.50	1	076740001
M	153.50	1	076740002
L	153.50	1	076740003
XL	153.50	1	076740004
XXL	153.50	1	076740005
XXXL	153.50	1	076740006

7780QN

Blouson bomber de travail multipoches en double matière.
100% nylon imperméable 300D et tissu softshell 96 % polyester, 4 % spandex, rembourrage en polyester 160 g/m² avec capuche fixe
noir/gris anthracite

CE



	CHF		
S	164.00	1	077800201
M	164.00	1	077800202
L	164.00	1	077800203
XL	164.00	1	077800204
XXL	164.00	1	077800205
XXXL	164.00	1	077800206

7750N

Blouson bomber de travail multipoches 100 % polyester, rembourrage 100 % polyester 120 g/m² noir

CE



	CHF		
XS	103.50	1	077500000
S	103.50	1	077500001
M	103.50	1	077500002
L	103.50	1	077500003
XL	103.50	1	077500004
XXL	103.50	1	077500005
XXXL	103.50	1	077500006

FLEECE



7636N

Pull en micro-polaire avec fermeture éclair courte 180 g/m² noir avec détails réfléchissants



	CHF		
XS	34.00	1	076360500
S	34.00	1	076360501
M	34.00	1	076360502
L	34.00	1	076360503
XL	34.00	1	076360504
XXL	34.00	1	076360505
XXXL	34.00	1	076360506

7637G

Sweat-shirt technique avec fermeture éclair longue, 250 g/m², avec capuche polaire 100 % polyester avec empiècements en tissu softshell 100D avec polaire couplé, 270 g/m² gris mélange/noir



	CHF		
XS	109.00	1	076370000
S	109.00	1	076370001
M	109.00	1	076370002
L	109.00	1	076370003
XL	109.00	1	076370004
XXL	109.00	1	076370005
XXXL	109.00	1	076370006

7642G

Sweatshirt ras du cou 240 g/m² 60 % coton, 40 % polyester gris chiné et inserts noirs



	CHF		
XS	41.50	1	076420000
S	41.50	1	076420001
M	41.50	1	076420002
L	41.50	1	076420003
XL	41.50	1	076420004
XXL	41.50	1	076420005
XXXL	41.50	1	076420006

7654B

pull micropolaire stretch avec fermeture éclair courte, 180 g/m², bleu 95% polyester, 5% élasthanne

4-WAY
STRETCH

TOP
line



	CHF		
XS	58.50	1	076540100
S	58.50	1	076540101
M	58.50	1	076540102
L	58.50	1	076540103
XL	58.50	1	076540104
XXL	58.50	1	076540105
XXXL	58.50	1	076540106

7654N

Pull en micro-polaire, fermeture éclair courte, élastique, 180 g/m², noir
95 % polyester, 5 % spandex



	CHF		
XS	58.50	1	076540000
S	58.50	1	076540001
M	58.50	1	076540002
L	58.50	1	076540003
XL	58.50	1	076540004
XXL	58.50	1	076540005
XXXL	58.50	1	076540006

7657B

pull en molleton stretch avec fermeture éclair longue, 280 g/m², bleu
95% polyester, 5% élasthanne



	CHF		
XS	74.50	1	076570100
S	74.50	1	076570101
M	74.50	1	076570102
L	74.50	1	076570103
XL	74.50	1	076570104
XXL	74.50	1	076570105
XXXL	74.50	1	076570106

7657N

Pull polaire, fermeture éclair longue, élastique, 280 g/m², noir,
95 % polyester, 5 % spandex



	CHF		
XS	74.50	1	076570000
S	74.50	1	076570001
M	74.50	1	076570002
L	74.50	1	076570003
XL	74.50	1	076570004
XXL	74.50	1	076570005
XXXL	74.50	1	076570006

7664G

sweatshirt, longue fermeture éclair, 280 g/m², gris
60 % coton, 40 % polyesters



	CHF		
XS	68.00	1	076640100
S	68.00	1	076640101
M	68.00	1	076640102
L	68.00	1	076640103
XL	68.00	1	076640104
XXL	68.00	1	076640105
XXXL	68.00	1	076640106

7664N

sweatshirt avec fermeture éclair longue, 280 g/m², noir
60 % coton, 40 % polyesters



	CHF		
XS	68.00	1	076640000
S	68.00	1	076640001
M	68.00	1	076640002
L	68.00	1	076640003
XL	68.00	1	076640004
XXL	68.00	1	076640005
XXXL	68.00	1	076640006

7665G

sweatshirt à capuche, longue fermeture éclair, 280 g/m², gris
60 % coton, 40 % polyester



	CHF		
XS	73.50	1	076650100
S	73.50	1	076650101
M	73.50	1	076650102
L	73.50	1	076650103
XL	73.50	1	076650104
XXL	73.50	1	076650105
XXXL	73.50	1	076650106

7665N

sweatshirt à capuche, longue fermeture éclair, 280 g/m², noir
60 % coton, 40 % polyester



	CHF		
XS	73.50	1	076650000
S	73.50	1	076650001
M	73.50	1	076650002
L	73.50	1	076650003
XL	73.50	1	076650004
XXL	73.50	1	076650005
XXXL	73.50	1	076650006

SHIRT & T-SHIRT

7545F

Chemise flanelle de travail à carreaux, 100 % coton, 190 g/m²



	CHF		
XS	52.00	1	075450200
S	52.00	1	075450201
M	52.00	1	075450202
L	52.00	1	075450203
XL	52.00	1	075450204
XXL	52.00	1	075450205
XXXL	52.00	1	075450206

7547AZ

Polo 3 boutons, 100% coton, 200 g/m², bleu clair



	CHF		
XS	37.50	2	075470500
S	37.50	2	075470501
M	37.50	2	075470502
L	37.50	2	075470503
XL	37.50	2	075470504
XXL	37.50	2	075470505
XXXL	37.50	2	075470506

7547BL

Polo 3 boutons
100 % coton 200 g/m², bleu



	CHF		
XS	37.50	2	075470200
S	37.50	2	075470201
M	37.50	2	075470202
L	37.50	2	075470203
XL	37.50	2	075470204
XXL	37.50	2	075470205
XXXL	37.50	2	075470206

7547G

Polo 3 boutons
100 % coton 200 g/m², gris



	CHF		
XS	37.50	2	075470300
S	37.50	2	075470301
M	37.50	2	075470302
L	37.50	2	075470303
XL	37.50	2	075470304
XXL	37.50	2	075470305
XXXL	37.50	2	075470306

7547N

Polo 3 boutons
100% coton, 200 g/m², noir



	CHF		
XS	37.50	2	075470400
S	37.50	2	075470401
M	37.50	2	075470402
L	37.50	2	075470403
XL	37.50	2	075470404
XXL	37.50	2	075470405
XXXL	37.50	2	075470406

7547R

Polo 3 boutons,
100% coton, 200 g/m², rouge



	CHF		
XS	37.50	2	075470600
S	37.50	2	075470601
M	37.50	2	075470602
L	37.50	2	075470603
XL	37.50	2	075470604
XXL	37.50	2	075470605
XXXL	37.50	2	075470606

7548M

T-shirt imprimé moderne, 100% coton, 150 g/m²



	CHF		
XS	32.50	1	075480400
XL	32.50	1	075480404
S	32.50	1	075480401
M	32.50	1	075480402
L	32.50	1	075480403
XXL	32.50	1	075480405
XXXL	32.50	1	075480406

7548C

T-shirt imprimé classique, 100% coton, 150 g/m²



	CHF		
XS	32.50	1	075480500
S	32.50	1	075480501
M	32.50	1	075480502
L	32.50	1	075480503
XL	32.50	1	075480504
XXL	32.50	1	075480505
XXXL	32.50	1	075480506

7549AZ

T-shirt de travail, 100% coton, 150 g/m², bleu clair



	CHF		
XS	24.70	5	075490500
S	24.70	5	075490501
M	24.70	5	075490502
L	24.70	5	075490503
XL	24.70	5	075490504
XXL	24.70	5	075490505
XXXL	24.70	5	075490506

7549BL

T-shirt de travail 100 % coton, 150 g/m², bleu



	CHF		
XS	24.70	5	075490200
S	24.70	5	075490201
M	24.70	5	075490202
L	24.70	5	075490203
XL	24.70	5	075490204
XXL	24.70	5	075490205
XXXL	24.70	5	075490206

7549G

T-shirt de travail 100 % coton, 150 g/m², gris



	CHF		
XS	24.70	5	075490300
S	24.70	5	075490301
M	24.70	5	075490302
L	24.70	5	075490303
XL	24.70	5	075490304
XXL	24.70	5	075490305
XXXL	24.70	5	075490306

7549NE

T-shirt de travail en 100 % coton, 150 g/m², noir



	CHF		
XS	24.70	5	075490700
S	24.70	5	075490701
M	24.70	5	075490702
L	24.70	5	075490703
XL	24.70	5	075490704
XXL	24.70	5	075490705
XXXL	24.70	5	075490706

7549N

T-shirt de travail 100% coton, 150 g/m², noir



	CHF		
XS	24.70	5	075490400
S	24.70	5	075490401
M	24.70	5	075490402
L	24.70	5	075490403
XL	24.70	5	075490404
XXL	24.70	5	075490405
XXXL	24.70	5	075490406

7549R

T-shirt de travail, 100% coton, 150 g/m², rouge



	CHF		
XS	24.70	5	075490600
S	24.70	5	075490601
M	24.70	5	075490602
L	24.70	5	075490603
XL	24.70	5	075490604
XXL	24.70	5	075490605
XXXL	24.70	5	075490606

7550G

T-shirt de travail technique en polyester, 120 g/m² avec la technologie 37.5®, gris avec détails noirs, orange et réfléchissants.



	CHF		
XS	52.50	1	075500400
S	52.50	1	075500401
M	52.50	1	075500402
L	52.50	1	075500403
XL	52.50	1	075500404
XXL	52.50	1	075500405
XXXL	52.50	1	075500406

7550N

T-shirt de travail technique en polyester, 120 g/m² avec la technologie 37.5®, noir avec détails gris, orange et réfléchissants



	CHF		
XS	52.50	1	075500500
S	52.50	1	075500501
M	52.50	1	075500502
L	52.50	1	075500503
XL	52.50	1	075500504
XXL	52.50	1	075500505
XXXL	52.50	1	075500506

7557BL

Polo 3 boutons, manches longues, 100% coton, 200 g/m², Bleu



	CHF		
XS	45.00	1	075570200
S	45.00	1	075570201
M	45.00	1	075570202
L	45.00	1	075570203
XL	45.00	1	075570204
XXL	45.00	1	075570205
XXXL	45.00	1	075570206

RAIN

7970

Pantalon imperméable bleu en tricot PVC

JUSQU'À ÉPUISEMENT DES STOCKS

CE



EN 343

	CHF		
XS	57.00	1	079700000
S	57.00	1	079700001
M	57.00	1	079700002
L	57.00	1	079700003
XL	57.00	1	079700004
XXL	57.00	1	079700005
XXXL	57.00	1	079700006

Beta

7971L

Pantalon imperméable en polyester enduit PVC

avec coutures étanches, bleu
Doté d'élastique à la taille et bas de jambe réglable avec boutons pression

CE



EN 343

	CHF		
XS	32.00	1	079710100
S	32.00	1	079710101
M	32.00	1	079710102
L	32.00	1	079710103
XL	32.00	1	079710104
XXL	32.00	1	079710105
XXXL	32.00	1	079710106

7978L

Manteau imperméable en polyester enduit PVC

avec capuche fixe et coutures étanches, bleu
Doté de boutons pression qui permettent de le raccourcir à 3/4

CE



EN 343

	CHF		
XS	44.00	1	079780100
S	44.00	1	079780101
M	44.00	1	079780102
L	44.00	1	079780103
XL	44.00	1	079780104
XXL	44.00	1	079780105
XXXL	44.00	1	079780106

7979

Veste imperméable bleu en tricot PVC

JUSQU'À ÉPUISEMENT DES STOCKS

CE



EN 343

	CHF		
S	93.50	1	079790001
M	93.50	1	079790002
L	93.50	1	079790003
XL	93.50	1	079790004
XXL	93.50	1	079790005
XXXL	93.50	1	079790006

UNDERWEAR

7996N

ensemble de sous-vêtements techniques -
maillot de corps manches longues + collant
technique, 92 % polyester, 8 % élasthanne,
160 g/m², noir



	CHF		
XS-S	53.50	1	079960000
M-L	53.50	1	079960002
XL-XXL	53.50	1	079960004

Beta

ACCESSORIES

7800G

Paire de genouillères de travail



7800G CHF 19.10 1 078000500

7980L

Bonnet à LED rechargeable intégré 100% acrylique
Lumière LED avec 3 intensités lumineuses jusqu'à 60 lumens
Taille unique
Noir

- Rechargeable par port USB
- Intensité lumineuse : jusqu'à 60 lumens
- Temps de recharge : 80 minutes
- Autonomie de la batterie : 85 à 290 minutes



7980L CHF 18.30 10 079800200

7980NC

bonnet d'hiver polaire, 100 % polyester, réversible, noir/camouflage



7980NC CHF 16.80 10 079800112

7980RN

Bonnet d'hiver avec revers 100 % acrylique intérieur doublé avec 3M Thinsulate™, taille unique noir



7980RN CHF 15.70 10 079800120

7981N

Bob anti-pluie
100 % nylon enduit PU
avec traitement hydrofuge



7981N CHF 27.50 1 079810158
L = Ø 58 cm
XL = Ø 60 cm CHF 27.50 1 079810160

7982N

Casquette à visière incurvée, 100% polyester, Ajustable
noire



7982N CHF 12.90 10 079820000

7984EG

Ceinture de travail grise en tissu extensible, avec boucle à crochet en métal zingué satiné. Taille unique de 120 cm (qui peut être raccourcie) et d'une largeur de 37 mm.



7984EG CHF 32.50 1 079840520

7984G

Ceinture 100% TPE avec boucle en métal zinc chromé
taille unique 125 cm réglable, largeur 35 mm, noir



7984G CHF 22.40 1 079840525

7985N

Cache-cou en micro-polaire avec régulateur à coulisse, utilisable également comme bonnet noir avec détails gris et réfléchissants



7985N CHF 15.70 10 079850000



7104 90

Colonnes en plastique avec base de rangement



7104 90 H mm 90 CHF 33.50 4 071040004

7105 6

Chaîne en plastique de délimitation



7105 6 Ø mm 6 L m 25 CHF 80.50 1 071050006

7109A

Panneaux d'avertissement en aluminium



7109A 1 H mm 140 CHF 14.00 1 071090001
7109A 2 140 CHF 14.00 1 071090002
7109A 3 140 CHF 14.00 1 071090003
7109A 4 140 CHF 14.00 1 071090004

7109D

Panneaux d'interdiction



7109D 1 H mm 115 CHF 14.00 1 071090051
7109D 2 115 CHF 14.00 1 071090052
7109D 3 115 CHF 14.00 1 071090053

7061TC

Lunettes de protection avec verres en polycarbonate transparent

CE

EN166:2001
EN170
2C-1.2 1F



7061TC

CHF
12.40



1 070610001

7076BC

Lunettes de protection avec verres en polycarbonate transparent

CE

EN166:2001
EN172
5-1.7 1F



7076BC

CHF
28.00



1 070760009

7076BD

Lunettes de protection avec verres en polycarbonate

CE

EN166:2001
EN172
5-3.1 1F



7076BD

CHF
28.00



1 070760019

7076BP

Lunettes de protection avec verres en polycarbonate polarisé

CE

EN ISO 12312-1:2013+A1:2015
EN 1836
3P



7076BP

CHF
45.00



1 070760029

7076BU

lunettes de sécurité avec verres en polycarbonate orange pour la détection des fuites avec lampe UV

CE

EN ISO 12311:2013
UV 500



7076BU

CHF
23.10



1 070760039

7093BC

Lunettes de protection avec verres en polycarbonate transparent

CE

EN166:2001
EN170
2C-1.2 1F



7093BC

CHF
42.00



1 070930009

7093BD

Lunettes de protection avec verres en polycarbonate foncé

CE

EN166:2001
EN172
5-3.1 1F



7093BD

CHF
42.00



1 070930019



C62M/WW

Mannequin de taille réaliste avec socle en métal



185
cm

C62M/WW

CHF
326.00



1 062000362

C64

présentoir mural pour vêtements et chaussures, vide



2400
mm

560
mm

L	CHF	Icon	Code
1 m	1,825.00		1 064000021
2 m	3,320.00		1 064000022
3 m	4,800.00		1 064000023
4 m	6,280.00		1 064000024

C64G

présentoir « gondole » pour vêtements et chaussures, vide

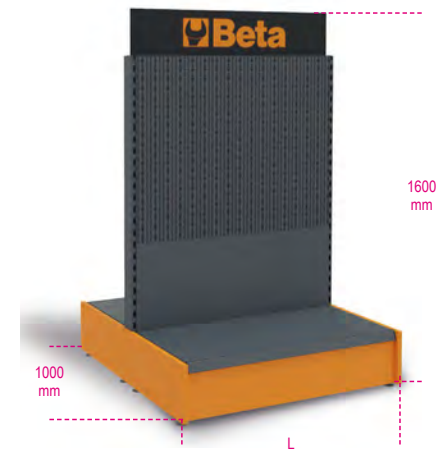

L	CHF	Quantité	Code
1 m	2,250.00	1	064000051
2 m	4,080.00	1	064000052

C64CW

vestiaire



C64CW	CHF	Quantité	Code
	777.00	1	064000610

6200AP/S10

Série de 10 cintres



6200AP/S10	CHF	Quantité	Code
	56.00	1	062000331

6800BA



6800BA	CHF	Quantité	Code
	155.50	1	068000130

6800RS



6800RS	CHF	Quantité	Code
	134.00	1	068000135

6888GS

crochet de chaussure pour affichage C64



6888GS	CHF	Quantité	Code
	33.50	2	068880122
170x120 mm			

6888GW

crochet pour affichage C64



6888GW	CHF	Quantité	Code
	9.30	2	068880121
400 mm			

9562TB

Tapis pour essuyage chaussures, avec partie arrière en caoutchouc antiglisse



9562TB	L mm	H mm	CHF	Quantité	Code
	800	600	61.50	1	095620500

9565S

Fût en tôle d'acier avec chaise en similicuir déhoussable.



9565S	H cm	ø cm	CHF	Quantité	Code
	60	38	272.00	1	095650300

Beta



Robur

Robur fabrique depuis 1930 des lignes d'accessoires pour câbles dans la lignée de la qualité reconnue de Beta Utensili, dont elle complète la gamme de production.

L'expérience, l'organisation et la technologie sont à la base d'un développement constant à l'écoute des besoins du marché.

La marque Robur est produite depuis 1984 dans une usine moderne située à Sulmona



Formats de vente spéciaux pour libre service

CHARGE

WLL: charge constante (pour accessoires de levage)

WFL: force limite de travail (pour accessoires non destinés au levage)

BF: Force maximum atteinte par l'article lors de l'essai de traction statique

LC: tension d'ancrage

nouveauté 2024

8134

Élévateur magnétique permanent

CE

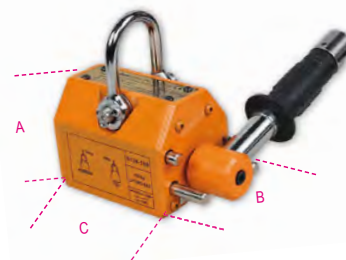

EN13155

Données techniques :
 • Coefficient de sécurité : 3
 • Plaque d'identification série

Certificats disponibles :
 • Certificat du Fabricant
 • Déclaration de Conformité DM2006/42/CE
 • Rapport d'essai type 2.2 UNI EN10204
 • Manuel d'utilisation et d'entretien

dimensions

conditionnement

WLL	A	B	C	CHF	code commande
kg	mm	mm	mm		
100	70	64	92	567.00	1 081340010
300	96	88	165	994.00	1 081340030
600	120	118	230	1,845.00	1 081340060
1000	168	168	264	3,060.00	1 081340100

prix

code commande

8105

Tendeur à deux oeillets en acier allié galvanisé à chaud

CE



CARACTÉRISTIQUES TECHNIQUES

- coefficient de sécurité : 5
- traitement thermique cage : normalisation
- traitement thermique oeillets : bonification

ANALYSES DE LABORATOIRE

- analyse chimique

- essai de traction

CERTIFICATS DISPONIBLES

- Spécification produit
- Rapport d'essai type 2.2 UNI EN10204

ØxE	≈	WLL	CHF		
"	mm	kg			
3/8x6	M10x150	540	17.90	5	081050010
1/2x6	M12x150	1000	29.50	5	081050011
1/2x9	M12x230	1000	38.00	5	081050012
5/8x6	M16x150	1590	45.00	2	081050014
5/8x9	M16x230	1590	56.00	2	081050016
5/8X12	M16X300	1590	67.00	2	081050015
3/4x6	M20x150	2360	72.00	2	081050017
3/4x9	M20x230	2360	83.50	2	081050020
3/4x12	M20x300	2360	100.00	2	081050018
3/4x18	M20x460	2360	131.50	2	081050021
7/8x12	M22x300	3270	141.50	1	081050022
1x6	M24x150	4540	150.00	1	081050024
1x12	M24x300	4540	215.50	1	081050025
1x18	M24x460	4540	254.00	1	081050026
1.1/4x12	M33x300	6900	368.00	1	081050031
1.1/4x18	M33x460	6900	379.00	1	081050032
1.1/4x24	M33x610	6900	515.00	1	081050033
1.1/2x12	M39x300	9710	455.00	1	081050034
1.1/2x18	M39x460	9710	553.00	1	081050035
1.3/4x18	M45x460	12700	837.00	1	081050036

autres mesures disponibles sur demande

formats de vente spéciaux pour libre service



ØxE	CHF		
"			
3/8x6	19.50	1	081059010
1/2x9	39.50	1	081059012

Robur

8109

Tendeur à deux chapes en acier allié galvanisé à chaud

CE

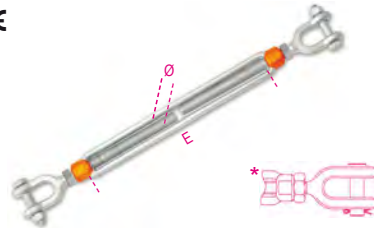

CARACTÉRISTIQUES TECHNIQUES

- coefficient de sécurité : 5
- traitement thermique cage : normalisation
- traitement thermique chapes : bonification

ANALYSES DE LABORATOIRE

- analyse chimique

- essai de traction

CERTIFICATS DISPONIBLES

- Spécification produit
- Rapport d'essai type 2.2 UNI EN10204

ØxE	≈	WLL	CHF		
"	mm	kg			
3/8x6	M10x150	540	23.20	5	081090010
1/2x6	M12x150	1000	38.50	5	081090011
1/2x9	M12x230	1000	46.00	5	081090012
1/2x12	M12x300	1000	58.00	5	081090013
5/8x6	M16x150	1590	70.00	2	081090015
5/8x9	M16x230	1590	83.00	2	081090016
5/8X12	M16X300	1590	93.00	2	081090017
3/4x6	M20x150	2360	98.00	2	081090018
3/4x9	M20x230	2360	113.50	2	081090020
3/4x12	M20x300	2360	126.50	2	081090019
3/4x18	M20x460	2360	150.50	2	081090021
7/8x12	M22x300	3270	189.50	1	081090022
7/8x18	M22x460	3270	229.50	1	081090023
1x6	M24x150	4540	188.00	1	081090024
1x12	M24x300	4540	270.00	1	081090025
1x18	M24x460	4540	311.00	1	081090026
* 1.1/4x12	M33x300	6900	438.00	1	081090031
* 1.1/4x18	M33x460	6900	491.00	1	081090032
* 1.1/4x24	M33x610	6900	681.00	1	081090033
* 1.1/2x12	M39x300	9710	635.00	1	081090034
* 1.1/2x18	M39x460	9710	727.00	1	081090038
* 1.1/2x24	M39x610	9710	870.00	1	081090039
* 1.3/4x18	M45x460	12700	1,059.00	1	081090036

formats de vente spéciaux pour libre service



ØxE	CHF		
"			
3/8x6	24.80	1	081099010
1/2x9	47.00	1	081099012

8110

Tendeur œillet et chape à haute résistance zingué à chaud

CE

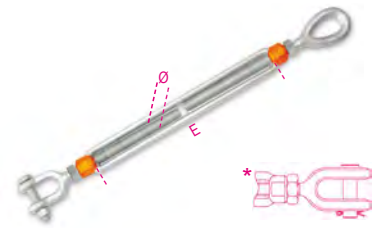

CARACTÉRISTIQUES TECHNIQUES

- Coefficient de sécurité : 5
- Traitement thermique cage : normalisation
- Traitement thermique chapes : bonification

ANALYSES DE LABORATOIRE

- analyse chimique

- essai de traction

CERTIFICATS DISPONIBLES

- Spécification produit
- Rapport d'essai type 2.2 UNI EN10204
- Certificat de contrôle type 3.1 UNI EN10204
- Déclaration de Conformité CE

ØxE	≈	WLL	CHF		
"	mm	kg			
3/8x6	M10x150	540	21.10	5	081100004
1/2x6	M12x150	1000	33.50	5	081100006
1/2x9	M12x230	1000	41.50	5	081100010
5/8x6	M16x150	1590	58.00	2	081100014
5/8x9	M16x230	1590	68.00	2	081100015
5/8x12	M16x300	1590	79.50	2	081100016
3/4x6	M20x150	2360	86.00	2	081100019
3/4x9	M20x230	2360	99.00	2	081100020
3/4x12	M20x300	2360	113.00	2	081100021
7/8x12	M22x300	3270	165.00	1	081100022
1x6	M24x150	4540	169.00	1	081100027
1x12	M24x300	4540	242.50	1	081100029
*1.1/4x12	M33x300	6900	404.00	1	081100034
*1.1/4x18	M33x460	6900	480.00	1	081100035
*1.1/4x24	M33x610	6900	595.00	1	081100036
*1.1/2x12	M39x300	9710	567.00	1	081100038
*1.1/2x18	M39x460	9710	642.00	1	081100039
*1.3/4x18	M45x460	12700	980.00	1	081100044

* Fourche avec axe traversant et gouppie

Robur

Robur

TENDEURS



La conception originale des tendeurs **Robur** est extrêmement populaire parmi les concepteurs et ingénieurs en structure italiens, basée sur des tolérances dimensionnelles précises, des valeurs de résistance supérieures aux modèles DIN 1480 ainsi qu'une traçabilité garantie à la fois par le fabricant et par le code d'identification sur les corps.

Une galvanisation électrolytique qualitative, avec des dépôts uniformes sans chrome, se traduit par une bonne résistance aux intempéries et un aspect soigné des éléments structurels exposés.



8005Z

Tendeur à deux œillets, zingué

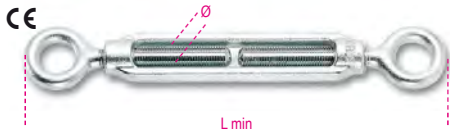

CARACTÉRISTIQUES TECHNIQUES

- coefficient de sécurité : 4
- ANALYSES DE LABORATOIRE
- analyse chimique
- essai de traction
- CERTIFICATS DISPONIBLES
- Spécification produit
- Rapport d'essai type 2.2 UNI EN10204
- Déclaration de Conformité CE

Ø mm	≈	L min mm	WFL kg	CHF	📦	🚚
M5	3/16	118	115	2.98	400	080050105
M6	1/4	130	160	3.30	300	080050106
M8	5/16	158	300	5.05	200	080050108
M10	3/8	192	470	7.20	100	080050110
M11	7/16	206	580	9.45	80	080050111
M12	1/2	226	690	11.00	60	080050112
M14	9/16	256	940	15.10	15	080050114
M16	5/8	290	1290	22.80	10	080050116
M18	11/16	358	1660	33.50	1	080050118
M20	3/4	358	2130	38.00	1	080050120
M22	7/8	400	2630	52.00	1	080050122
M24	1"	436	3060	65.00	1	080050124
M27	1 1/8	474	4000	95.00	1	080050125
M30	1 3/16	498	4860	114.50	1	080050130
M33	1 1/4	516	6040	133.50	1	080050126
M36	1 3/8	532	6500	165.50	1	080050136
M39	1 1/2	544	7900	195.50	1	080050139

Filetage whitworth jusqu'à épaisseur des stocks
Nouveaux lots avec filetage métrique

Emballages spéciaux



Ø mm	≈	📦	CHF	🚚
M5	3/16	30	100.50	1 080050705
M6	1/4	30	111.00	1 080050706
M8	5/16	20	113.00	1 080050708
M10	3/8	15	121.50	1 080050710
M11	7/16	15	158.50	1 080050711
M12	1/2	15	186.00	1 080050712

formats de vente spéciaux pour libre service

Ø mm	📦	CHF	🚚
M5	2	7.00	1 080059305
M6	2	8.00	1 080059306
M8	1	6.65	1 080059108
M10	1	8.75	1 080059110
M11	1	11.40	1 080059111
M12	1	12.70	1 080059112
M14	1	16.40	1 080059114
M16	1	24.40	1 080059116

8005TZ

Tendeur à deux œillets, cage en tube galvanisé



CARACTÉRISTIQUES TECHNIQUES

- coefficient de sécurité : 4
- ANALYSES DE LABORATOIRE
- analyse chimique
- essai de traction
- CERTIFICATS DISPONIBLES
- Spécification produit
- Rapport d'essai type 2.2 UNI EN10204
- Déclaration de Conformité CE

Ø mm	≈	WFL kg	CHF	📦	🚚
M12	1/2	690	15.00	15	080050512
M16	5/8	1290	26.00	1	080050516
M20	3/4	2130	37.00	1	080050520
M24	1"	3060	67.50	1	080050524
M27	1 1/8	4000	91.50	1	080050527
M30	1 3/16	4860	106.00	1	080050530
M36	1 3/8	6500	170.00	1	080050536

formats de vente spéciaux pour libre service

Ø mm	📦	CHF	🚚
M12	1	17.90	1 080059512



8006Z

Tendeur œillet et crochet, zingué

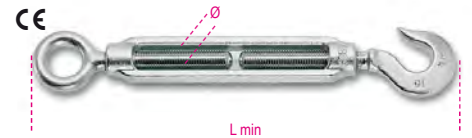

CARACTÉRISTIQUES TECHNIQUES

- coefficient de sécurité : 4
- ANALYSES DE LABORATOIRE
- analyse chimique
- essai de traction
- CERTIFICATS DISPONIBLES
- Spécification produit
- Rapport d'essai type 2.2 UNI EN10204
- Déclaration de Conformité CE

Ø mm	≈	L min mm	WFL kg	CHF	📦	🚚
M5	3/16	121	25	3.15	400	080060105
M6	1/4	132	45	3.50	250	080060106
M8	5/16	170	95	5.25	180	080060108
M10	3/8	204	140	7.80	100	080060110
M11	7/16	221	165	10.20	15	080060111
M12	1/2	244	300	12.10	15	080060112
M14	9/16	284	420	17.40	10	080060114
M16	5/8	322	570	25.50	1	080060116
M18	11/16	373	700	37.00	1	080060118
M20	3/4	391	900	44.50	1	080060120
M22	7/8	433	1100	59.50	1	080060122
M24	1"	470	1300	80.00	1	080060124
M27	1 1/8	503	2300	109.00	1	080060127

Emballages spéciaux



Ø mm	≈	📦	CHF	🚚
M5	3/16	30	106.50	1 080060705
M6	1/4	30	117.00	1 080060706
M8	5/16	20	118.50	1 080060708
M10	3/8	15	132.00	1 080060710

formats de vente spéciaux pour libre service

Ø mm	📦	CHF	🚚
M5	2	7.95	1 080069305
M6	2	8.85	1 080069306
M8	1	6.75	1 080069108
M10	1	9.25	1 080069110
M11	1	11.90	1 080069111
M12	1	13.40	1 080069112
M14	1	19.20	1 080069114

8007Z

Tendeur à deux crochets, zingué

CE

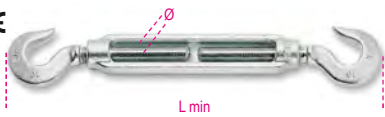

CARACTÉRISTIQUES TECHNIQUES

- coefficient de sécurité : 4
- ANALYSES DE LABORATOIRE
- analyse chimique
- essai de traction
- CERTIFICATS DISPONIBLES
- Spécification produit
- Rapport d'essai type 2.2 UNI EN10204
- Déclaration de Conformité CE

Ø mm	≈	L min mm	WFL kg	CHF	📦	🚚
M5	3/16	124	25	3.35	30	080070105
M6	1/4	134	45	3.65	30	080070106
M8	5/16	181	95	5.60	20	080070108
M10	3/8	211	140	8.45	15	080070110
M11	7/16	231	165	11.00	15	080070111
M12	1/2	262	300	13.30	15	080070112
M14	9/16	312	420	19.70	1	080070114
M16	5/8	354	570	28.50	1	080070116
M18	11/16	388	700	40.50	1	080070118
M20	3/4	424	900	52.00	1	080070120
M22	7/8	466	1100	67.00	1	080070122
M24	1"	504	1300	95.00	1	080070124
M27	1 1/8	532	2300	123.50	1	080070127

formats de vente spéciaux pour libre service



Ø mm	≈	CHF	📦	🚚
M5	2	8.30	1	080079305
M6	2	8.85	1	080079306
M8	1	6.70	1	080079108
M10	1	9.05	1	080079110
M11	1	12.30	1	080079111
M12	1	14.50	1	080079112

8008N

Tendeur à deux tiges à souder, noir

CE

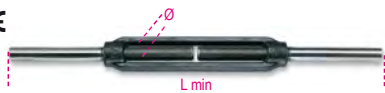

CARACTÉRISTIQUES TECHNIQUES

- coefficient de sécurité : 4
- ANALYSES DE LABORATOIRE
- analyse chimique
- essai de traction
- CERTIFICATS DISPONIBLES
- Spécification produit
- Rapport d'essai type 2.2 UNI EN10204
- Déclaration de Conformité CE

Ø mm	≈	L min mm	WFL kg	CHF	📦	🚚
M5	3/16	160	115	2.92	30	080080205
M6	1/4	180	160	3.25	30	080080206
M8	5/16	210	300	4.45	20	080080208
M10	3/8	250	470	6.00	15	080080210
M12	1/2	280	690	8.95	15	080080212
M14	9/16	340	940	12.50	5	080080214
M16	5/8	380	1290	16.90	5	080080216
M18	11/16	410	1660	25.00	3	080080218
M20	3/4	440	2130	29.50	3	080080220
M22	7/8	480	2630	37.00	2	080080222
M24	1"	520	3060	48.50	2	080080224
M27	1 1/8	560	4000	75.50	1	080080227
M30	1 3/8	560	4860	95.00	1	080080230
M33	1 1/4	600	6040	101.50	1	080080233
M36	1 3/8	600	6500	131.50	1	080080236
M39	1 1/2	600	7900	150.00	1	080080239

Filetage whitworth jusqu'à épauement des stocks
Nouveaux lots avec filetage métrique

formats de vente spéciaux pour libre service



Ø mm	≈	CHF	📦	🚚
M5	2	8.05	1	080089305
M6	2	8.20	1	080089306
M8	1	6.00	1	080089208
M10	1	7.95	1	080089210
M12	1	10.10	1	080089212
M14	1	14.00	1	080089214

8008TZN

Tendeur à deux tiges à souder, cage en tube DIN 1478, embouts noirs, corps galvanisé

CE



CARACTÉRISTIQUES TECHNIQUES

- coefficient de sécurité : 4
- ANALYSES DE LABORATOIRE
- analyse chimique
- essai de traction
- CERTIFICATS DISPONIBLES
- Spécification produit
- Rapport d'essai type 2.2 UNI EN10204
- Déclaration de Conformité CE

Ø mm	≈	WFL kg	CHF	📦	🚚
M12	1/2	690	12.30	10	080080512
M16	5/8	1290	20.30	1	080080516
M20	3/4	2130	30.00	1	080080520
M24	1	3060	52.50	1	080080524
M27	1.1/8	4000	77.00	1	080080527
M30	1.3/16	4860	91.00	1	080080530
M36	1.3/8	6500	143.00	1	080080536

8009Z

Tendeur à deux chapes, zingué

CE

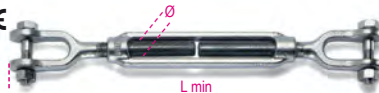

CARACTÉRISTIQUES TECHNIQUES

- coefficient de sécurité : 4
- ANALYSES DE LABORATOIRE
- analyse chimique
- essai de traction
- CERTIFICATS DISPONIBLES
- Spécification produit
- Rapport d'essai type 2.2 UNI EN10204
- Déclaration de Conformité CE

Ø mm	≈	L min mm	WFL kg	CHF	📦	🚚
M8	5/16	192	300	16.40	15	080090008
M10	3/8	234	470	19.60	15	080090010
M12	1/2	274	690	26.00	15	080090012
M14	9/16	342	940	36.50	1	080090014
M16	5/8	372	1290	42.50	1	080090016
M18	11/16	406	1660	62.50	1	080090018
M20	3/4	406	2130	66.50	1	080090020
M22	7/8	466	2630	91.50	1	080090022
M24	1"	486	3060	107.00	1	080090024
M27	1 1/8	510	4000	168.00	1	080090027
M30	1 3/16	566	4860	215.50	1	080090030

Packs spéciaux



Ø mm	≈	CHF	📦	🚚
M8	5/16	5	91.50	1 080090708
M10	3/8	5	110.50	1 080090710
M12	1/2	5	147.50	1 080090712

formats de vente spéciaux pour libre service



Ø mm	≈	CHF	📦	🚚
M8	1	18.60	1	080099008
M10	1	21.20	1	080099010
M12	1	28.50	1	080099012

8009TZ

Ridoir à deux chapes
DIN 1478
galvanisé

CE



CARACTÉRISTIQUES TECHNIQUES

- coefficient de sécurité : 4
- ANALYSES DE LABORATOIRE
- analyse chimique
- essai de traction
- CERTIFICATS DISPONIBLES
- Spécification produit
- Rapport d'essai type 2.2 UNI EN10204
- Déclaration de Conformité CE

Ø mm	≈	WFL kg	CHF	📦	🚚
M12	1/2	690	29.50	10	080090512
M16	5/8	1290	46.00	1	080090516
M20	3/4	2130	65.00	1	080090520
M24	1	3060	109.00	1	080090524
M27	1.1/8	4000	165.00	1	080090527
M30	1.3/16	4860	207.00	1	080090530

formats de vente spéciaux pour libre service



Ø mm	≈	CHF	📦	🚚
M12	1	29.50	1	080099512



8010Z

Tendeur œillet et chape, zingué



CARACTÉRISTIQUES TECHNIQUES

- coefficient de sécurité : 4
- ANALYSES DE LABORATOIRE
- analyse chimique
- essai de traction
- CERTIFICATS DISPONIBLES
- Spécification produit
- Rapport d'essai type 2.2 UNI EN10204
- Déclaration de Conformité CE

Ø mm	≈	L min mm	WFL kg	CHF		
M8	5/16	175	300	10.70	20	080100008
M10	3/8	215	470	13.40	15	080100010
M12	1/2	250	690	18.70	10	080100012
M14	9/16	299	940	26.00	10	080100014
M16	5/8	331	1290	33.00	1	080100016
M18	11/16	382	1660	47.50	1	080100018
M20	3/4	382	2130	52.00	1	080100020
M22	7/8	433	2630	72.00	1	080100022
M24	1"	461	3060	86.00	1	080100024
M27	1 1/8	492	4000	131.50	1	080100027
M30	1 3/16	529	4860	165.50	1	080100030

formats de vente spéciaux pour libre service

Ø mm	CHF		
M8	12.00	1	080109008
M10	14.90	1	080109010
M12	20.20	1	080109012
M14	28.50	1	080109014

8010TZ

Tendeur œillet et chape cage en tube DIN 1478, zingué



CARACTÉRISTIQUES TECHNIQUES

- coefficient de sécurité : 4
- ANALYSES DE LABORATOIRE
- analyse chimique
- essai de traction
- CERTIFICATS DISPONIBLES
- Spécification Produit
- Rapport d'essai type 2.2 UNI EN10204
- Déclaration de Conformité CE

Ø mm	≈	WFL kg	CHF		
M12	1/2	690	22.00	10	080100612
M16	5/8	1290	36.00	1	080100616
M20	3/4	2130	51.50	1	080100620
M24	1	3060	88.00	1	080100624
M27	1.1/8	4000	128.50	1	080100627
M30	1.3/16	4860	156.00	1	080100630

8011Z

Tendeurs à crochet et à chape galvanisé



CARACTÉRISTIQUES TECHNIQUES

- Coefficient de sécurité : 4
- ANALYSE EN LABORATOIRE
- Analyse chimique
- Essai de traction
- CERTIFICATS DISPONIBLES
- Spécification de produit
- Rapport d'essai UNI EN10204 type 2.2
- Déclaration de conformité CE

Ø mm	≈	L min mm	WFL kg	CHF		
M12	1/2	270	300	16.90	1	080110112
M16	5/8	360	570	34.50	1	080110116
M20	3/4	420	900	57.50	1	080110120
M24	1"	490	1300	96.50	1	080110124
M27	1 1/8	500	2300	134.00	1	080110127

8011TZ

Tendeurs à crochet et à chape galvanisé DIN 1478



CARACTÉRISTIQUES TECHNIQUES

- Coefficient de sécurité : 4
- ANALYSE EN LABORATOIRE
- Analyse chimique
- Essai de traction
- CERTIFICATS DISPONIBLES
- Spécification de produit
- Rapport d'essai UNI EN10204 type 2.2
- Déclaration de conformité CE

Ø mm	≈	L min mm	WFL kg	CHF		
M12	1/2	260	300	19.40	1	080110612
M16	5/8	350	570	35.50	1	080110616
M20	3/4	400	900	54.00	1	080110620
M24	1"	490	1300	93.00	1	080110624
M27	1 1/8	500	2300	123.50	1	080110627

8001Z

Cage pour tendeurs, zinguée



CARACTÉRISTIQUES TECHNIQUES

- coefficient de sécurité : 5
- code lot de fabrication
- ANALYSES DE LABORATOIRE
- analyse chimique
- essai de traction
- CERTIFICATS DISPONIBLES
- Spécification produit
- Rapport d'essai type 2.2 UNI EN10204
- Déclaration de Conformité CE

Ø mm	≈	L mm	WFL kg	CHF		
M5	3/16	80	115	1.79	100	080010105
M6	1/4	80	160	1.88	100	080010106
M8	5/16	105	300	2.94	25	080010108
M10	3/8	125	470	3.80	20	080010110
M11	7/16	135	580	4.65	15	080010111
M12	1/2	140	690	5.05	20	080010112
M14	9/16	170	940	7.05	15	080010114
M16	5/8	190	1290	9.60	15	080010116
M18	11/16	205	1660	15.30	10	080010118

Ø mm	≈	L mm	WFL kg	CHF		
M20	3/4	220	2130	17.60	10	080010120
M22	7/8	240	2630	22.30	8	080010122
M24	1"	260	3060	27.00	5	080010124
M27	1 1/8	270	4000	42.50	1	080010127
M30	1 3/16	280	4860	54.00	1	080010130
M33	1 1/4	290	6040	59.50	1	080010133
M36	1 3/8	300	6500	76.00	1	080010136
M39	1 1/2	300	7900	91.00	1	080010139

Filetage whitworth jusqu'à épauement des stocks
Nouveaux lots avec filetage métrique

formats de vente spéciaux pour libre service

Ø mm	CHF		
M5	2	5.40	1 080019305
M6	2	5.90	1 080019306
M8	1	4.65	1 080019108
M10	1	5.45	1 080019110
M11	1	6.60	1 080019111
M12	1	6.80	1 080019112
M14	1	9.05	1 080019114
M16	1	11.50	1 080019116
M18	1	17.10	1 080019118
M20	1	19.20	1 080019120
M22	1	24.30	1 080019122
M24	1	29.00	1 080019124

8001TZ

Cage en tube pour tendeurs, galvanisé



DIN 1478

CARACTÉRISTIQUES TECHNIQUES

- coefficient de sécurité : 5
- code lot de fabrication
- ANALYSES DE LABORATOIRE
- analyse chimique
- essai de traction
- CERTIFICATS DISPONIBLES
- Spécification produit
- Rapport d'essai type 2.2 UNI EN10204
- Déclaration de Conformité CE

Ø mm	≈	L mm	WFL kg	CHF		
M12	1/2	125	690	8.30	10	080010512
M16	5/8	170	1290	12.70	5	080010516
M20	3/4	200	2130	16.70	5	080010520
M24	1	255	3060	29.50	3	080010524
M27	1.1/8	255	4000	39.50	1	080010527
M30	1.3/16	255	4860	44.50	1	080010530
M36	1.3/8	295	6500	80.50	1	080010536
M42	1.5/8	330	9700	113.50	1	080010542

*Tailles non prévues par la norme

formats de vente spéciaux pour libre service

Ø mm	CHF		
M12	1	10.00	1 080019512
M16	1	14.00	1 080019516
M20	1	18.20	1 080019520
M24	1	30.50	1 080019524

8002ZD

Œillet pour tendeurs filetage à droite zingué

Sur demande, avec filetage à gauche

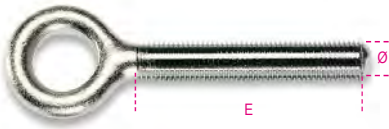

CARACTÉRISTIQUES TECHNIQUES

- coefficient de sécurité : 4
- ANALYSES DE LABORATOIRE
- analyse chimique
- essai de traction
- CERTIFICATS DISPONIBLES
- Spécification produit
- Rapport d'essai type 2.2 UNI EN10204

Ø mm	≈ "	E mm	WFL kg	CHF		
M5	3/16	37	115	0.62	200	080020105
M6	1/4	40	160	0.76	150	080020106
M8	5/16	52	300	1.12	100	080020108
M10	3/8	60	470	1.79	100	080020110
M11	7/16	65	580	2.53	1	080020111
M12	1/2	72	690	3.15	50	080020112
M14	9/16	85	940	3.90	1	080020114
M16	5/8	95	1290	6.60	1	080020116
M18	11/16	103	1660	9.60	1	080020118
M20	3/4	110	2130	10.80	1	080020120
M22	7/8	120	2630	15.80	1	080020122
M24	1"	130	3060	20.00	1	080020124
M27	1 1/8	135	4000	27.50	1	080020127
M30	1 3/16	140	4860	32.00	1	080020130
M33	1 1/4	148	6040	39.00	1	080020133
M36	1 3/8	150	6500	47.00	1	080020198
M39	1 1/2	150	7900	55.00	1	080020199

Filetage whitworth jusqu'à épauement des stocks
Nouveaux lots avec filetage métrique

Ø mm	≈ "	E mm	WFL kg	CHF		
M5	3/16	37	115	0.62	1	080020305
M6	1/4	40	160	0.76	1	080020306
M8	5/16	52	300	1.12	1	080020308
M10	3/8	60	470	1.79	1	080020310
M11	7/16	65	580	2.53	1	080020311
M12	1/2	72	690	3.15	1	080020312
M14	9/16	85	940	3.90	1	080020314
M16	5/8	95	1290	6.60	1	080020316
M18	11/16	103	1660	9.60	1	080020318
M20	3/4	110	2130	10.80	1	080020320
M22	7/8	120	2630	15.80	1	080020322
M24	1"	130	3060	20.00	1	080020324
M27	1 1/8	135	4000	27.50	1	080020327
M30	1 3/16	140	4860	32.00	1	080020330
M33	1 1/4	148	6040	39.00	1	080020333
M36	1 3/8	150	6500	47.00	1	080020398
M39	1 1/2	150	7900	55.00	1	080020399



8003ZD

Crochet pour tendeurs filetage à droite zingué

Sur demande, avec filetage à gauche



CARACTÉRISTIQUES TECHNIQUES

- coefficient de sécurité : 4
- ANALYSES DE LABORATOIRE
- analyse chimique
- essai de traction
- CERTIFICATS DISPONIBLES
- Spécification produit
- Rapport d'essai type 2.2 UNI EN10204

Ø mm	≈ "	E mm	WFL kg	CHF		
M5	3/16	40	25	0.82	150	080030105
M6	1/4	40	45	0.93	120	080030106
M8	5/16	52	95	1.38	100	080030108
M10	3/8	60	140	2.46	70	080030110
M11	7/16	65	165	3.35	1	080030111
M12	1/2	70	300	4.30	30	080030112
M14	9/16	85	420	6.60	1	080030114
M16	5/8	95	570	9.80	1	080030116
M18	11/16	103	700	13.20	1	080030118
M20	3/4	110	900	17.90	1	080030120
M22	7/8	120	1100	23.20	1	080030122
M24	1"	130	1300	35.50	1	080030124
M27	1 1/8	135	2300	42.00	1	080030127

Ø mm	≈ "	WFL kg	E mm	CHF		
M5	3/16	40	25	0.82	1	080030305
M6	1/4	40	45	0.93	1	080030306
M8	5/16	52	95	1.38	1	080030308
M10	3/8	60	140	2.46	1	080030310
M11	7/16	65	165	3.35	1	080030311
M12	1/2	70	300	4.30	1	080030312
M14	9/16	85	420	6.60	1	080030314
M16	5/8	95	570	9.80	1	080030316
M18	11/16	103	700	13.20	1	080030318
M20	3/4	110	900	17.90	1	080030320
M22	7/8	120	1100	23.20	1	080030322
M24	1"	130	1300	35.50	1	080030324
M27	1 1/8	135	2300	42.00	1	080030327

8004ND

Tige pour tendeurs filetage à droite - noir

Sur demande avec filetage à gauche



CARACTÉRISTIQUES TECHNIQUES

- coefficient de sécurité : 4
- ANALYSES DE LABORATOIRE
- analyse chimique
- essai de traction
- CERTIFICATS DISPONIBLES
- Spécification produit
- Rapport d'essai type 2.2 UNI EN10204

Ø mm	≈ "	E mm	WFL kg	CHF		
M5	3/16	40	115	0.65	1	080040005
M6	1/4	44	160	0.76	1	080040006
M8	5/16	53	300	0.90	1	080040008
M10	3/8	63	470	1.32	1	080040010
M12	1/2	70	690	2.20	1	080040012
M14	9/16	85	940	3.00	1	080040014
M16	5/8	95	1290	4.15	1	080040016
M18	11/16	103	1660	5.65	1	080040018
M20	3/4	110	2130	7.05	1	080040020
M22	7/8	120	2630	8.75	1	080040022
M24	1"	130	3060	12.40	1	080040024
M27	1 1/8	135	4000	19.80	1	080040027
M30	1 3/16	140	4860	24.60	1	080040030
M33	1 1/4	150	6040	25.50	1	080040033
M36	1 3/8	150	6500	33.50	1	080040098
M39	1 1/2	150	7900	36.00	1	080040099

Filetage whitworth jusqu'à épauement des stocks
Nouveaux lots avec filetage métrique

Ø mm	≈ "	E mm	WFL kg	CHF		
M5	3/16	40	115	0.65	1	080040105
M6	1/4	44	160	0.76	1	080040106
M8	5/16	53	300	0.90	1	080040108
M10	3/8	63	470	1.32	1	080040110
M12	1/2	70	690	2.20	1	080040112
M14	9/16	85	940	3.00	1	080040114
M16	5/8	95	1290	4.15	1	080040116
M18	11/16	103	1660	5.65	1	080040118
M20	3/4	110	2130	7.05	1	080040120
M22	7/8	120	2630	8.75	1	080040122
M24	1"	130	3060	12.40	1	080040124
M27	1 1/8	135	4000	19.80	1	080040127
M30	1 3/16	140	4860	24.60	1	080040130
M33	1 1/4	150	6040	25.50	1	080040133
M36	1 3/8	150	6500	33.50	1	080040198
M39	1 1/2	150	7900	36.00	1	080040199



8009FD

Chape pour tendeurs
filetage à droite - galvanisée



CARACTÉRISTIQUES TECHNIQUES

- coefficient de sécurité : 4
- ANALYSES DE LABORATOIRE
- analyse chimique
- essai de traction
- CERTIFICATS DISPONIBLES
- Spécification produit
- Rapport d'essai type 2.2 UNI EN10204

Ø mm	≈ "	E mm	WFL kg	CHF		
M8	5/16	53	300	6.95	1	080090208
M10	3/8	63	470	8.20	1	080090210
M12	1/2	70	690	11.00	1	080090212
M14	9/16	85	940	15.30	1	080090214
M16	5/8	95	1290	17.40	1	080090216
M18	11/16	103	1660	24.60	1	080090218
M20	3/4	110	2130	25.50	1	080090220
M22	7/8	120	2630	36.00	1	080090222
M24	1"	130	3060	41.50	1	080090224
M27	1 1/8	135	4000	65.00	1	080090227
M30	1 3/16	140	4860	84.50	1	080090230

chape pour tendeur à droite - zinguée

Ø mm	≈ "	WFL kg	G mm	CHF		
M8	5/16	53	300	6.95	1	080090408
M10	3/8	63	470	8.20	1	080090410
M12	1/2	70	690	11.00	1	080090412
M14	9/16	85	940	15.30	1	080090414
M16	5/8	95	1290	17.40	1	080090416
M18	11/16	103	1660	24.60	1	080090418
M20	3/4	110	2130	25.50	1	080090420
M22	7/8	120	2630	36.00	1	080090422
M24	1"	130	3060	41.50	1	080090424
M27	1 1/8	135	4000	65.00	1	080090427
M30	1 3/16	140	4860	84.50	1	080090430

8048

Chape mâle filetage à droite, noire



UNI 6058

ØxL mm	WFL kg	F mm	E mm	CHF		
M8x50	430	6	39	4.35	20	080480108
M8x65	430	6	54	4.65	20	080480109
M10x80	690	8	66	7.25	10	080480110
M10x100	690	8	86	7.25	10	080480210
M10x130	690	8	116	8.20	10	080480111
M12x70	1020	10	53	7.50	8	080480212
M12x95	1020	10	78	7.70	8	080480112
M12x125	1020	10	108	9.45	8	080480113
M14x110	1420	12	91	10.60	6	080480114
M16x100	1980	14	79	8.75	6	080480115
M16x130	1980	14	109	9.05	6	080480116
M18x150	2390	16	126	20.50	2	080480118
M20x160	3100	18	134	25.50	2	080480120
M22x180	3890	18	152	39.50	1	080480122
M24x200	4460	20	168	45.00	1	080480124
M24x220	4460	20	188	48.50	1	080480125
M27x220	5900	22	185	59.00	1	080480127

8302Z

Vis à œil pour chevilles filetage à droite
zinguée



CARACTÉRISTIQUES TECHNIQUES

- coefficient de sécurité : 4
- CERTIFICATS DISPONIBLES
- Spécification produit
- Rapport d'essai type 2.2 UNI EN10204

Ø mm	E mm	F mm	WFL kg	CHF		
M5	48	8	115	0.70	200	083020005
M6	55	10	160	0.85	150	083020006
M8	60	12	300	1.15	100	083020008
M10	73	14	470	1.95	100	083020010
M12	90	17	690	3.80	50	083020012

Packs spéciaux



Ø mm	E mm	WFL kg	CHF		
M5	48	100	78.00	1	083020705
M6	55	75	71.50	1	083020706
M8	60	50	64.00	1	083020708
M10	73	50	109.50	1	083020710
M12	90	25	106.00	1	083020712

8303Z

Crochet pour chevilles filetage à droite
zingué



CARACTÉRISTIQUES TECHNIQUES

- coefficient de sécurité : 4
- CERTIFICATS DISPONIBLES
- Spécification produit
- Rapport d'essai type 2.2 UNI EN10204

Ø mm	C mm	E mm	WFL kg	CHF		
M5	6,0	48	25	0.82	120	083030005
M6	8,0	55	45	0.90	100	083030006
M8	10,0	60	95	1.46	75	083030008
M10	12,5	73	140	2.46	50	083030010
M12	16,0	90	220	4.10	20	083030012

Packs spéciaux



Ø mm	C mm	WFL kg	CHF		
M5	6,0	60	55.00	1	083030705
M6	8,0	50	50.00	1	083030706
M8	10,0	30	49.00	1	083030708
M10	12,5	25	69.00	1	083030710
M12	16,0	10	46.00	1	083030712

8702N - 8702Z - 8702ZC

Cosse à presser en acier forgé,
embout à sertir à œil
noir



CARACTÉRISTIQUES TECHNIQUES

- Code lot de fabrication
- ANALYSES DE LABORATOIRE
- Analyse chimique
- Essai de traction
- CERTIFICATS DISPONIBLES
- Spécification produit
- Rapport d'essai type 2.2 UNI EN10204
- Certificat de contrôle type 3.1 UNI EN10204

M	Ø B mm	Ø A mm	Ø D mm	CHF		
6	6,8	13	19	59.00	1	087020106
8	8,8	20	22	70.50	1	087020108
9	9,8	20	22	70.50	1	087020109
10	10,8	20	22	70.50	1	087020110
11	11,8	25	27	87.50	1	087020111
12	12,8	25	27	87.50	1	087020112
13	13,8	25	27	87.50	1	087020113
14	14,8	32	32	121.50	1	087020114
15	15,9	32	32	121.50	1	087020115
16	17,0	32	32	121.50	1	087020116
18	19,0	39	37	157.50	1	087020118
19	20,0	39	37	157.50	1	087020119
20	21,1	39	37	157.50	1	087020120
22	23,2	43	43	219.00	1	087020122
24	25,4	50	52	252.00	1	087020124
25	26,4	50	52	252.00	1	087020125
26	27,4	50	52	252.00	1	087020126

Le pressage de la cosse nécessite de presses et de
moules spéciaux et peut être effectué exclusivement par
un personnel spécialisé.

8702Z galvanisé

M	Ø B mm	Ø A mm	Ø D mm	CHF		
6	6,8	13	19	61.50	1	087020306
8	8,8	20	22	74.50	1	087020308
9	9,8	20	22	74.50	1	087020309
10	10,8	20	22	74.50	1	087020310
11	11,8	25	27	91.00	1	087020311
12	12,8	25	27	91.00	1	087020312
13	13,8	25	27	91.00	1	087020313
14	14,8	32	32	127.50	1	087020314
15	15,9	32	32	127.50	1	087020315
16	17,0	32	32	127.50	1	087020316
18	19,0	39	37	165.00	1	087020318
19	20,0	39	37	165.00	1	087020319
20	21,1	39	37	165.00	1	087020320
22	23,2	43	43	226.50	1	087020322
24	25,4	50	52	263.00	1	087020324
25	26,4	50	52	263.00	1	087020325
26	27,4	50	52	263.00	1	087020326

8702ZC galvanisé à chaud

M	Ø B mm	Ø A mm	Ø D mm	CHF		
6	6,8	13	19	65.00	1	087020206
8	8,8	20	22	80.50	1	087020208
9	9,8	20	22	80.50	1	087020209
10	10,8	20	22	80.50	1	087020210
11	11,8	25	27	100.00	1	087020211
12	12,8	25	27	100.00	1	087020212
13	13,8	25	27	100.00	1	087020213
14	14,8	32	32	147.50	1	087020214
15	15,9	32	32	147.50	1	087020215
16	17,0	32	32	147.50	1	087020216
18	19,0	39	37	190.50	1	087020218
19	20,0	39	37	190.50	1	087020219
20	21,1	39	37	190.50	1	087020220
22	23,2	43	43	259.00	1	087020222
24	25,4	50	52	302.00	1	087020224
25	26,4	50	52	302.00	1	087020225
26	27,4	50	52	302.00	1	087020226

8709N - 8709Z - 8709ZC

Cossé à presser en acier forgé
embout à sertir à chape
noir



CARACTÉRISTIQUES TECHNIQUES

- Code lot de fabrication
- ANALYSES DE LABORATOIRE
- Analyse chimique
- Essai de traction
- CERTIFICATS DISPONIBLES
- Spécification produit
- Rapport d'essai type 2.2 UNI EN10204
- Certificat de contrôle type 3.1 UNI EN10204

M	ø B mm	ø A mm	ø C mm	CHF		
6	6,8	13	17	80.50	1	087090106
8	8,8	20	21	104.00	1	087090108
9	9,8	20	21	104.00	1	087090109
10	10,8	20	21	104.00	1	087090110
11	11,8	25	25	130.00	1	087090111
12	12,8	25	25	130.00	1	087090112
13	13,8	25	25	130.00	1	087090113
14	14,8	32	30	181.50	1	087090114
15	15,9	32	30	181.50	1	087090115
16	17,0	32	30	181.50	1	087090116
18	19,0	39	35	235.50	1	087090118
19	20,0	39	35	235.50	1	087090119
20	21,1	39	35	235.50	1	087090120
22	23,2	43	41	301.00	1	087090122
24	25,4	50	51	309.00	1	087090124
25	26,4	50	51	309.00	1	087090125
26	27,4	50	51	309.00	1	087090126

Le pressage de la cosse nécessite de presses et de moules spéciaux et peut être effectué exclusivement par un personnel spécialisé.

8709Z galvanisé

M	ø B mm	ø A mm	ø C mm	CHF		
6	6,8	13	17	83.00	1	087090306
8	8,8	20	21	109.00	1	087090308
9	9,8	20	21	109.00	1	087090309
10	10,8	20	21	109.00	1	087090310
11	11,8	25	25	135.50	1	087090311
12	12,8	25	25	135.50	1	087090312
13	13,8	25	25	135.50	1	087090313
14	14,8	32	30	190.50	1	087090314
15	15,9	32	30	190.50	1	087090315
16	17,0	32	30	190.50	1	087090316
18	19,0	39	35	246.50	1	087090318
19	20,0	39	35	246.50	1	087090319
20	21,0	39	35	246.50	1	087090320
22	23,2	43	41	324.00	1	087090322
24	25,4	50	51	324.00	1	087090324
25	26,4	50	51	324.00	1	087090325
26	27,4	50	51	324.00	1	087090326

8709ZC galvanisé à chaud

M	ø B mm	ø A mm	ø C mm	CHF		
6	6,8	13	17	86.00	1	087090206
8	8,8	20	21	114.50	1	087090208
9	9,8	20	21	114.50	1	087090209
10	10,8	20	21	114.50	1	087090210
11	11,8	25	25	148.00	1	087090211
12	12,8	25	25	148.00	1	087090212
13	13,8	25	25	148.00	1	087090213
14	14,8	32	30	215.00	1	087090214
15	15,9	32	30	215.00	1	087090215
16	17,0	32	30	215.00	1	087090216
18	19,0	39	35	274.00	1	087090218
19	20,0	39	35	274.00	1	087090219
20	21,1	39	35	274.00	1	087090220
22	23,2	43	41	350.00	1	087090222
24	25,4	50	51	384.00	1	087090224
25	26,4	50	51	384.00	1	087090225
26	27,4	50	51	384.00	1	087090226

SERRRES-CABLES

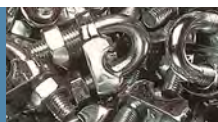

Les serre-câbles professionnels permettent d'obtenir des passages pour câbles acier, et s'utilisent avec des systèmes d'arrimage et de tension. Contrairement à de nombreux produits disponibles dans le commerce, les serre-câbles Beta ne possèdent pas de corps en fonte.

En effet, afin d'assurer des performances mécaniques optimales lors de travaux lourds, les bases sont forgées à chaud et sont souvent plus lourdes que des pièces similaires.

Une galvanisation électrolytique qualitative, sans chrome, offre une bonne résistance à la corrosion et améliore son apparence. Au cours des plusieurs décennies de l'histoire de l'entreprise, tous ces points ont fait de l'article 8016 l'icône de la marque Robur, permettant aux serre-câbles « à l'italienne » de se démarquer dans le monde entier.

8015

Pince pour câble, type Américain, corps en acier, galvanisé à chaud

CE

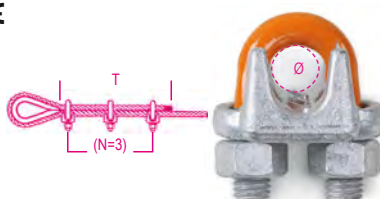

dimensioni EN 13411-5 tipo B

DONNÉES TECHNIQUES

- code de traçabilité TESTS DE LABORATOIRE
- analyse chimique
- essai de couple CERTIFICATS DISPONIBLES
- Spécifications techniques du produit
- Rapport d'essai UNI EN10204 type 2.2
- Certificat de fabricant UNI EN13411-5
- Déclaration de conformité CE

ø mm	ø"	NxT	Nm	CHF		
8	5/16	3x133	40,7	2.94	12	080150808
10	3/8	3x165	61	4.10	12	080150810
13	1/2	3x292	88	6.35	6	080150813
16	5/8	3x305	129	8.95	6	080150816
20	3/4	4x460	176	12.30	6	080150820
22	7/8	4x480	305	19.50	6	080150822
26	1	5x660	305	21.20	5	080150826
30	1-1/8	6x860	305	22.70	2	080150830

8016

Serre-câble en acier, estampé à chaud zingué

CE

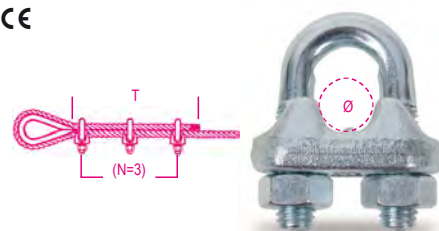

ANALYSES DE LABORATOIRE

- analyse chimique
- essai de couple de serrage
- CERTIFICATS DISPONIBLES
- Spécification produit
- Rapport d'essai type 2.2 UNI EN10204
- Certificat de Conformité CE

ø mm	ø"	N x T	Nm	CHF		
3	1/8	3x80	1,53	0.80	500	080160003
5	3/16	3x110	3,02	1.01	300	080160005
6	1/4	3x120	5,19	1.12	200	080160006
8	5/16	5x210	5,19	1.38	150	080160008
10	3/8	5x240	12,54	2.08	70	080160010
11	7/16	5x260	12,54	2.24	70	080160011
12-13	1/2	5x300	24,76	2.99	40	080160013
14	9/16	5x295	24,76	3.25	35	080160014
16	5/8	5x335	24,76	3.85	30	080160016
18	11/16	5x380	42,42	5.20	30	080160018
20	3/4	5x540	42,42	5.65	30	080160020
22	7/8	7x595	42,42	6.60	25	080160022
24-26	1"	7x700	67,56	9.05	15	080160026
28	1"1/16	8x840	67,56	11.30	5	080160028
30-32	1"1/8	8x990	67,56	11.40	5	080160030
34-36	1"1/4	8x1155	105,80	15.00	4	080160034
38-40	1"1/2	8x1320	105,80	20.20	2	080160040
45-50	2"	8x1500	206	31.00	1	080160050

Emballages spéciaux



ø mm	ø"	N x T	Nm	CHF		
3	1/8	100		89.00	1	080160703
5	3/16	50		56.50	1	080160705
6	1/4	50		62.50	1	080160706
8	5/16	30		46.50	1	080160708
10	3/8	30		70.00	1	080160710
11	7/16	25		62.50	1	080160711
12-13	1/2	15		50.00	1	080160713

formats de vente spéciaux pour libre service



ø mm	CHF		
3	5.95	1	080169403
5	5.25	1	080169405
6	5.90	1	080169406
8	6.80	1	080169408
10	5.45	1	080169410
11	3.95	1	080169011
12-13	4.65	1	080169013
14	4.90	1	080169014
16	5.45	1	080169016
18	6.95	1	080169018
20	7.05	1	080169020
22	8.30	1	080169022
24-26	10.90	1	080169026

8016FR

Serre-câble en acier
avec corps moulé a froid galvanisés

CE

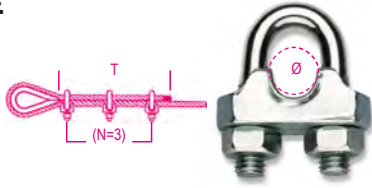

ANALYSES DE LABORATOIRE

- analyse chimique
- CERTIFICATS DISPONIBLES
- Spécification produit
- Rapport d'essai type 2.2 UNI EN10204
- Certificat de Conformité CE

Ø mm	Ø mm	N x T	Nm	CHF		
3	1/8	3x80	1,25	0.74	500	080160253
5	3/16	3x110	2,46	0.87	300	080160255
6	1/4	3x120	4,24	1.06	200	080160256
8	5/16	5x210	4,24	1.23	150	080160258

8018E

Serre-câble, type ENEL,
galvanisé a chaud



ANALYSES DE LABORATOIRE

- analyse chimique
- CERTIFICATS DISPONIBLES
- Spécification produit
- Rapport d'essai type 2.2 UNI EN10204

Ø mm	A mm	L mm	Nm	CHF		
4÷6	M6	34	4,24	1.60	100	080180001

Robur

8016U2

Serre-câbles, type Acorp en fonte, zingué

CE

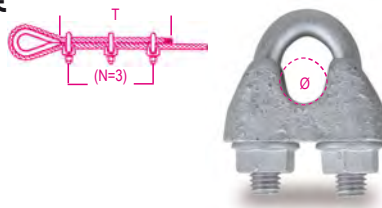

dimensioni EN 13411-5 tipo A

CARACTÉRISTIQUES TECHNIQUES • code d'identification ANALYSES DE LABORATOIRE • analyse chimique • essai de couple de serrage CERTIFICATS DISPONIBLES • Spécification produit • Rapport d'essai type 2.2 UNI EN10204 • Certificat du Fabricant UNI EN13411-5 • Certificat de Conformité CE

Ø mm	Ø mm	N x T	Nm	CHF		
5	3/16	3x156	2,0	0.44	300	080160855
6,5	1/4	3x192	3,5	0.59	150	080160856
8	5/16	4x320	6	1.20	70	080160858
10	3/8	4x320	9	1.24	60	080160860
12	1/2	4x384	20	2.36	25	080160862
14	9/16	4x448	33	3.70	15	080160864
16	5/8	4x512	49	5.45	10	080160866
19	3/4	4x512	68	6.35	10	080160869
22	7/8	5x680	107	9.05	10	080160872
26	1	5x760	147	16.40	5	080160876
30	1.1/8	6x984	212	21.00	5	080160880
34	1.1/4	6x1080	296	28.50	5	080160884
40	1.1/2	6x1176	363	35.50	5	080160890

formats de vente spéciaux pour libre service



Ø mm		CHF	
5	4	5.20	1
6	4	6.60	1
8	4	10.10	1
10	2	6.80	1
12	1	6.60	1
14	1	7.50	1
16	1	10.10	1
19	1	11.00	1
22	1	14.40	1
26	1	23.60	1

8016UGK

Serre-câble,
type Acorp en fonte,
corps GALVANISÉ À CHAUD
étrier et écrous GEOMET-GEOKOTE

CE

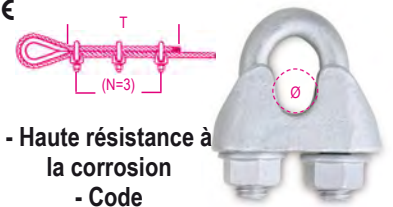

- Haute résistance à
la corrosion
- Code
d'identification

dimensioni EN 13411-5 tipo A

CARACTÉRISTIQUES TECHNIQUES

- Code d'identification
- ANALYSES DE LABORATOIRE
- Analyse chimique
- Essai de couple de serrage
- CERTIFICATS DISPONIBLES
- Spécification produit
- Rapport d'essai type 2.2 UNI EN10204
- Certificat du Fabricant UNI EN13411-5
- Déclaration de Conformité CE

Ø mm	Ø mm	N x T	Nm	CHF		
8	5/16	4x320	6	2.36	70	080160758
10	3/8	4x320	9	2.61	60	080160760
12	1/2	4x448	33	4.65	25	080160762
14	9/16	4x384	20	6.80	15	080160764
16	5/8	4x512	49	10.10	10	080160766
19	3/4	4x512	68	11.40	10	080160769
22	7/8	5x680	107	16.40	10	080160772
26	1	5x760	147	26.50	5	080160776
30	1,1/8	6x984	212	32.00	1	080160780
34	1,1/4	6x1080	296	46.00	1	080160784
40	1,1/2	6x1176	363	57.00	1	080160790

8018T

Serre-câble, type TELECOM,
corp en fonte
zingué



RUM-MU-21:1980

ANALYSES DE LABORATOIRE

- analyse chimique
- CERTIFICATS DISPONIBLES
- Spécification produit
- Rapport d'essai type 2.2 UNI EN10204

Ø mm	A mm	L mm	Nm	CHF		
8÷10	M8	42	10,20	1.64	200	080180003

Robur

Robur

8020A

Cosse cœur type léger, zinguée

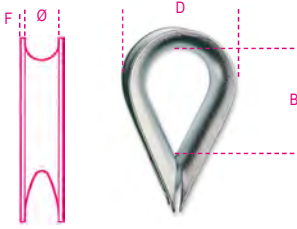

CERTIFICATS DISPONIBLES

- Spécification produit
- Rapport d'essai type 2.2 UNI EN10204

Ø mm	F mm	B mm	D mm	CHF		
2-3	1,0	20	18	0.30	150	080200503
4	1,2	23	19	0.31	150	080200504
5	1,2	24	23	0.36	100	080200505
6	1,2	27	28	0.38	100	080200506
8	1,4	33	32	0.59	50	080200508
10	1,8	41	38	0.86	30	080200510
12	2,2	44	45	1.13	30	080200512
14	2,2	52	49	1.46	50	080200514
16	3,0	58	58	2.04	50	080200516
18	3,7	64	68	2.87	50	080200518
20	3,7	73	74	3.70	35	080200520
22	3,7	83	79	4.15	30	080200522
24	3,7	93	88	5.45	20	080200525

Emballages spéciaux



Ø mm	S mm	CHF		
2-3	0,8	150	44.50	1 080200703
4	1,0	150	46.50	1 080200704
5	1,0	100	36.00	1 080200705
6	1,0	100	37.00	1 080200706
8	1,2	50	29.00	1 080200708
10	1,5	30	25.50	1 080200710

8021A

Cosse-cœur type lourd, zingué

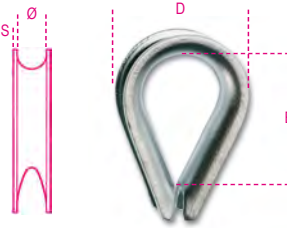

CERTIFICATS DISPONIBLES

- Spécification produit
- Rapport d'essai type 2.2 UNI EN10204

Ø mm	S mm	B mm	D mm	CHF		
2-3	0,6	15	16	0.49	150	080210103
5	1,7	29	28	0.70	120	080210105
6	1,8	33	30	0.77	100	080210106
8	2,5	36	37	1.05	80	080210108
10	2,5	42	43	1.27	80	080210110
12	2,5	48	50	1.64	100	080210112
14	2,7	58	57	2.20	70	080210114
16	3	61	62	2.68	50	080210116
18	3,5	71	71	3.50	70	080210118
20	4	79	79	5.20	30	080210120
22	4	87	84	6.00	25	080210122
24	4	93	92	7.05	25	080210124
26	4	103	103	8.75	20	080210126
28	5	107	116	20.50	1	080210128
30	5	118	121	20.50	1	080210130
32	5,5	138	135	24.60	1	080210132
35	6	140	147	34.00	1	080210135
40	6,0	174	170	48.50	1	080210140

CHAINES



Contrairement aux produits similaires, les manilles à haute résistance de Robur sont entièrement fabriquées à partir d'acier allié au chrome-molybdène trempé, et conçues pour dépasser 20 000 cycles à pleine charge lors de tests en laboratoire. Ils se distinguent donc dans leur catégorie comme la meilleure option pour les travaux lourds, avec un facteur de sécurité dépassant les exigences des normes de référence (6:1 au lieu de 5:1) et une excellente résistance aux basses températures.

Les manilles en acier doux de Robur sont synonymes de fiabilité et d'efficacité dans le temps, basées sur un choix rigoureux des matières premières, une finition mécanique soignée et un traitement thermique (normalisation), qui permettent d'atteindre une charge de travail et un facteur de sécurité élevés par rapport à d'autres concurrents disponibles dans le commerce. Un marquage clair et indélébile sur chaque pièce permet d'identifier l'origine de la manille, par ex. en cas de contrôles effectués par des sociétés d'audit ou des organismes équivalents.

8026R

Manille droite haute résistance, axe à œil, an acier allié, bride galvanisée à chaud

CE

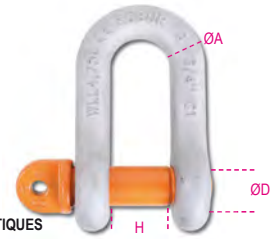

EN 13889

CARACTÉRISTIQUES TECHNIQUES

- coefficient de sécurité minimum: 6 • traitement thermique: bonification
- code lot de fabrication sur pivot et bride
- ANALYSES DE LABORATOIRE
- analyse chimique • analyse métallographique
- essai de traction • essai de fatigue (min. 20.000 cycles)
- test charge d'essai (WLL x 2)

CERTIFICATS DISPONIBLES

- Spécification produit • Rapport d'essai type 2.2 UNI EN10204
- Certificat de contrôle type 3.1 UNI EN10204

Déclaration de Conformité CE

ØD mm	ØA mm	H mm	WLL kg	CHF		
11	10	17	1000	7.95	5	080260210
16	13	21	2000	14.80	5	080260212
19	16	27	3250	24.90	3	080260216
22	19	32	4750	36.00	2	080260219
25	22	37	6500	55.00	2	080260222

formats de vente spéciaux pour libre service



ØD mm	CHF		
16	1	16.10	1 080269212
19	1	26.50	1 080269216

8029R

Manille lyre haute résistance en acier allié, axe carré femelle, bride galvanisée à chaud

CE

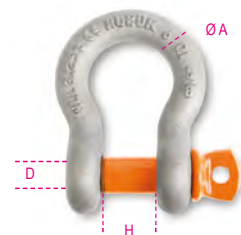

EN 13889

CARACTÉRISTIQUES TECHNIQUES

- coefficient de sécurité minimum : 6
- traitement thermique : bonification
- code lot de fabrication sur pivot et bride

ANALYSES DE LABORATOIRE

- analyse chimique
- analyse métallographique
- essai de traction
- essai de fatigue (min. 20.000 cycles)
- test charge d'essai (WLL x 2)

CERTIFICATS DISPONIBLES

- Spécification produit
- Rapport d'essai type 2.2 UNI EN10204
- Certificat de contrôle type 3.1 UNI EN10204
- Déclaration de Conformité CE

ØD mm	ØA mm	H mm	WLL kg	CHF		
8	6	13	500	4.85	20	080290106
10	8	13,5	750	5.90	15	080290108
11	10	17	1000	8.30	15	080290110
13	11	18,5	1500	11.00	10	080290111
16	13	20,5	2000	11.40	8	080290112
19	16	27	3250	19.50	8	080290116
22	19	32	4750	28.50	4	080290120
25	22	37	6500	42.50	4	080290122
28	26	43,5	8500	59.00	1	080290124

Robur

ØD mm	ØA mm	H mm	WLL kg	CHF		
32	29	48	9500	109.50	1	080290128
35	32	53	12000	147.00	1	080290132
38	35	59	13500	193.00	1	080290135
42	38	62	17000	252.00	1	080290138
50	45	75	25000	432.00	1	080290145
57	50	83	35000	755.00	1	080290150
65	57	95	42500	1,300.00	1	080290157
70	65	105	55000	1,490.00	1	080290165

formats de vente spéciaux pour libre service



ØD mm		CHF		
8	1	6.60	1	080299106
10	1	7.50	1	080299108
11	1	10.10	1	080299110
13	1	12.80	1	080299111
16	1	13.00	1	080299112
19	1	22.00	1	080299116

Packs spéciaux



ØD mm	ØA mm		CHF		
8	6	10	54.50	1	080290706
10	8	10	66.50	1	080290708
11	10	10	93.50	1	080290710
13	11	5	62.00	1	080290711
16	13	4	51.00	1	080290712
19	16	4	87.50	1	080290716
22	19	2	64.50	1	080290720
25	22	2	96.00	1	080290722

8031R

Manille lyre haute résistance en acier allié, axe avec écrou à goupille, bride galvanisée à chaud

CE



EN 13889

CARACTÉRISTIQUES TECHNIQUES

- coefficient de sécurité minimum : 6
- traitement thermique : bonification
- code lot de fabrication sur pivot et bride

ANALYSES DE LABORATOIRE

- analyse chimique
- analyse métallographique
- essai de traction
- essai de fatigue (min. 20.000 cycles)
- test charge d'essai (WLL x 2)

CERTIFICATS DISPONIBLES

- Spécification produit
- Rapport d'essai type 2.2 UNI EN10204
- Certificat de contrôle type 3.1 UNI EN10204
- Déclaration de Conformité CE

ØD mm	ØA mm	H mm	WLL kg	CHF		
11	10	17	1000	8.95	5	080310110
13	11	18	1500	13.80	5	080310111
16	13	21	2000	14.00	5	080310112
19	16	27	3250	24.10	3	080310116
22	19	32	4750	34.00	2	080310120
25	22	37	6500	47.00	2	080310122
28	26	43	8500	70.00	1	080310124

ØA mm	ØD mm	H mm	WLL kg	CHF		
29	32	48	9500	120.00	1	080310128
32	35	53	12000	155.50	1	080310132
35	38	59	13500	219.00	1	080310135
38	42	62	17000	267.00	1	080310138
45	50	75	25000	467.00	1	080310145
50	57	83	35000	821.00	1	080310150
65	70	105	55000	1,680.00	1	080310165
75	83	127	85000	2,550.00	1	080310183

formats de vente spéciaux pour libre service



ØD mm		CHF		
16	1	17.40	1	080319112
19	1	29.50	1	080319116

8032

Manille lyre haute résistance en acier allié, axe carré femelle, bride galvanisée à chaud

CE



CARACTÉRISTIQUE TECHNIQUES

- coefficient de sécurité minimum: 6
- traitement thermique: bonification
- code lot de fabrication sur pivot et bride

ANALYSES DE LABORATOIRE

- analyse chimique
- analyse métallographique
- essai de traction
- essai de fatigue (min. 20.000 cycles)
- test charge d'essai (WLL x 2)

CERTIFICATS DISPONIBLES

- Spécification produit
- Rapport d'essai type 2.2 UNI EN10204
- Certificat de contrôle type 3.1 UNI EN10204
- Déclaration de Conformité CE

ØD mm	ØA mm	H mm	WLL kg	CHF		
11	10	17	1000	10.60	5	080320010
16	13	21	2000	13.40	5	080320012
19	16	27	3250	24.40	3	080320016
22	19	32	4750	42.00	2	080320020
25	22	37	6500	61.50	2	080320022

formats de vente spéciaux pour libre service



ØD mm		CHF		
16	1	16.10	1	080329012
19	1	26.50	1	080329016



8025

Manille droite, type large, estampée à chaud, zinguée

CE



CARACTÉRISTIQUES TECHNIQUES

- coefficient de sécurité : 5
- traitement thermique : normalisation
- code lot de fabrication

ANALYSES DE LABORATOIRE

- analyse chimique
- analyse métallographique
- essai de traction

CERTIFICATS DISPONIBLES

- Spécification produit
- Rapport d'essai type 2.2 UNI EN10204
- Certificat de contrôle type 3.1 UNI EN10204
- Déclaration de Conformité CE

Ø mm	≈ "	B x C mm	WLL kg	CHF		
5	3/16	21x10	70	1.88	250	080250005
6	1/4	25x12	100	2.53	250	080250006
8	5/16	33x16	250	4.20	150	080250008
10	3/8	42x20	400	4.65	180	080250010
11	7/16	46x22	500	5.70	130	080250011
12	1/2	50x24	600	6.15	100	080250012
14	9/16	57x28	800	8.00	70	080250014
16	5/8	61x32	1000	10.40	10	080250016
18	11/16	65x36	1300	15.10	10	080250018
20	3/4	70x40	1600	17.70	10	080250020
22	7/8	74x44	2000	24.60	10	080250022
25	1"	80x48	2800	33.00	2	080250025

Emballages spéciaux



Ø mm		CHF			
5	3/16	25	52.50	1	080250705
6	1/4	25	71.50	1	080250706
8	5/16	25	118.50	1	080250708
10	3/8	15	78.00	1	080250710
11	7/16	12	77.00	1	080250711
12	1/2	12	83.00	1	080250712
14	9/16	10	90.00	1	080250714

formats de vente spéciaux pour libre service



Ø mm		CHF		
5	4	9.45	1	080259205
6	4	12.00	1	080259206
8	2	10.10	1	080259208
10	2	10.80	1	080259210
11	1	7.05	1	080259011
12	1	7.70	1	080259012
14	1	9.45	1	080259014
16	1	11.90	1	080259016
18	1	17.70	1	080259018
20	1	20.00	1	080259020
22	1	26.00	1	080259022
25	1	34.00	1	080259025

8026A

Manille droite, type UNI 1947, estampée à chaud, zinguée

CE

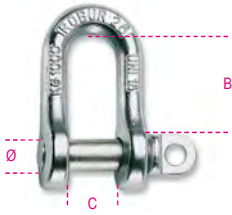

CARACTÉRISTIQUES TECHNIQUES

- coefficient de sécurité : 5
- traitement thermique : normalisation
- code lot de fabrication

ANALYSES DE LABORATOIRE

- analyse chimique
- analyse métallographique
- essai de traction

CERTIFICATS DISPONIBLES

- Spécification produit
- Rapport d'essai type 2.2 UNI EN10204
- Certificat de contrôle type 3.1 UNI EN10204
- Déclaration de Conformité CE

Ø mm	"	B x C mm	WLL kg	CHF	📦	🚚
12	1/2	42x20	630	5.90	35	080260012
14	9/16	46x22	800	7.30	30	080260014
16	5/8	50x24	1000	9.45	20	080260016
18	11/16	54x26	1300	13.30	15	080260018
20	3/4	58x28	1600	16.70	10	080260020
22	7/8	69x32	2000	22.00	10	080260022
25	1"	79x36	2500	31.00	5	080260025
28	1.1/8	90x40	3150	42.50	2	080260028
32	1.1/4	100x45	4000	59.00	1	080260032
36	1.3/8	110x50	5000	84.50	1	080260036
40	1.9/16	120x55	6300	116.50	1	080260040
42	1.5/8	131x60	8000	159.50	1	080260042
45	1.3/4	143x65	10000	217.50	1	080260045
50	2"	155x70	12500	270.00	1	080260050

formats de vente spéciaux pour libre service



Ø mm	"	CHF	📦	🚚
12	1	7.55	1	080269012
14	1	9.05	1	080269014
16	1	10.60	1	080269016
18	1	16.10	1	080269018
20	1	19.20	1	080269020
22	1	24.60	1	080269022
25	1	34.00	1	080269025

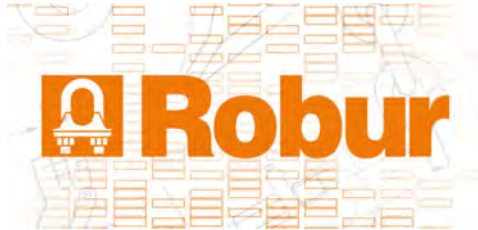

8028

Manille lyre, estampée à chaud, zinguée

CE

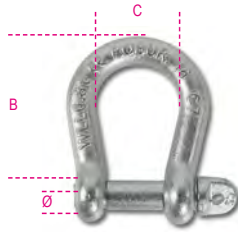

CARACTÉRISTIQUES TECHNIQUES

- coefficient de sécurité : 5
- traitement thermique : normalisation
- code lot de fabrication

ANALYSES DE LABORATOIRE

- analyse chimique
- analyse métallographique
- essai de traction

CERTIFICATS DISPONIBLES

- Spécification produit
- Rapport d'essai type 2.2 UNI EN10204
- Certificat de contrôle type 3.1 UNI EN10204
- Déclaration de Conformité CE

Ø mm	"	B x C mm	WLL kg	CHF	📦	🚚
5	3/16	20x16	80	1.62	100	080280105
6	1/4	24x20	100	2.41	70	080280106
8	5/16	32x24	200	4.15	35	080280108
10	3/8	40x33	300	4.80	25	080280110
12	1/2	48x39	500	7.55	15	080280112
14	9/16	56x46	600	10.80	7	080280114
16	5/8	64x46	800	16.30	10	080280116
18	11/16	71x59	950	20.00	5	080280118
20	3/4	80x65	1100	28.50	5	080280120
22	7/8	88x72	1500	36.00	5	080280122
25	1"	100x81	2000	55.00	2	080280125
28	1.1/8	112x91	2600	85.50	1	080280128
32	1.1/4	128x104	3200	117.00	1	080280132
38	1.1/2	152x124	4500	233.00	1	080280138

formats de vente spéciaux pour libre service



Ø mm	"	CHF	📦	🚚
5	4	8.00	1	080289305
6	4	11.50	1	080289306
8	2	10.40	1	080289308
10	2	11.20	1	080289310
12	1	9.25	1	080289112
14	1	12.40	1	080289114
16	1	17.60	1	080289116
18	1	22.30	1	080289118
20	1	31.00	1	080289120
22	1	39.50	1	080289122

8049 WLL (t)

	A°	M8	M10	M12	M16	M20	M24	M30
	0°	0,3	0,6	1	1,6	2,5	4	6,3
	90°	0,3	0,6	1	1,6	2,5	4	6,3
	45°	0,4	0,8	1,4	2,2	3,5	5,6	8,8
	46° 60°	0,3	0,6	1	1,6	2,5	4	6,3
	45° 60°	0,6	1,3	2,1	3,4	5,3	8,4	13,2
	46° 60°	0,3	0,6	1	1,6	2,3	4	6,3

8049

Anneau de levage mâle orientable double articulation, acier allié haute résistance

CE

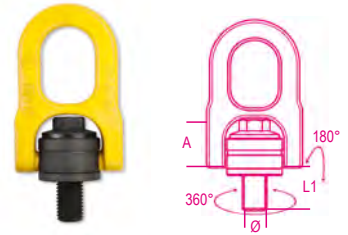

CARACTÉRISTIQUES TECHNIQUES

- coefficient de sécurité : 5
- traitement thermique : bonification
- code lot de fabrication

ANALYSES DE LABORATOIRE

- analyse chimique
- analyse métallographique
- essai de traction







CERTIFICATS DISPONIBLES

- Spécification produit
- Rapport d'essai type 2.2 UNI EN10204
- Certificat de contrôle type 3.1 UNI EN10204
- Déclaration de Conformité CE

Ø mm	A mm	L1 mm	WLL 90° kg	CHF	📦	🚚
M8	31,5	14	300	161.00	1	080490008
M10	31,5	17	600	168.00	1	080490010
M12	31,5	21	1000	172.50	1	080490012
M16	45	27	1600	198.50	1	080490016
M20	45	30	2500	203.50	1	080490020
M24	60,5	36	4000	348.00	1	080490024
M30	60,5	45	6300	363.00	1	080490030



8049A WLL (kg)

	Ø"	M6	M8	M10	M12	M16	M20	M24	M30	M36
	0°	400	600	900	1000	2000	4000	6300	10600	11800
	0°	800	1200	1800	2000	4000	8000	12600	21200	23600
	90°	200	300	450	500	1120	2000	3150	5300	8000
	90°	400	600	900	1000	2000	4000	6300	10600	16000
	0° 45°	250	400	600	700	1400	2800	4250	7100	10700
	46° 60°	200	300	450	500	1120	2000	3150	5300	8000
	0° 45°	400	600	900	1000	2100	4200	6300	11200	16000
	46° 60°	250	400	600	750	1500	3000	4750	8000	10700

8049A

Anneau de levage mâle orientable double articulation, pivotant sous charge avec anneau soudé, acier allié haute résistance

CE



CARACTÉRISTIQUES TECHNIQUES

- Coefficient de sécurité : 4
- Traitement thermique : bonification
- Code lot de fabrication

ANALYSES DE LABORATOIRE

- Analyse chimique
- Analyse métallographique
- Essai de traction
- Essai de fatigue (20.000 cycles)

CERTIFICATS DISPONIBLES

- Spécification produit
- Rapport d'essai type 2.2 UNI EN10204
- Certificat de contrôle type 3.1 UNI EN10204
- Déclaration de Conformité CE

Ø mm	E mm	A mm	WLL 90° kg	CHF		
M6	13	30	200	53.50	1	080490106
M8	13	30	300	54.50	1	080490108
M10	19	30	450	57.00	1	080490110
M12	19	30	500	60.50	1	080490112
M16	20	30	1120	64.50	1	080490116
M20	30	40	2000	93.00	1	080490120
M24	30	40	3150	136.50	1	080490124
M30	35	50	5300	235.50	1	080490130
M36	54	50	8000	248.00	1	080490136

8049V

Anneau de levage avec support décalé
Alliage d'acier haute résistance
anneau pivotant à 360° et support pivotant

CE



DONNÉES TECHNIQUES

- facteur de sécurité: 4
- traitement thermique : durcissement et revenu
- code de traçabilité TESTS DE LABORATOIRE
- analyse chimique
- analyse métallographique
- essai de traction
- essai de fatigue (20 000 cycles)
- charge d'essai (100% du lot) CERTIFICATS DISPONIBLES
- Spécifications techniques du produit
- Rapport d'essai UNI EN10204 type 2.2
- Certificat d'inspection UNI EN10204 type 3.1
- Déclaration de conformité CE

Ø mm	E mm	B mm	WLL kg	CHF		
M10	13,5	37	630	89.00	1	080490310
M12	18	37,5	1000	109.00	1	080490312
M16	24	37,5	1500	116.50	1	080490316
M20	35,5	54	2500	169.00	1	080490320
M24	35,5	54	4000	174.00	1	080490324

8068S

Étrier à souder pour le levage base simple avec ressort de positionnement, corps en acier allié à haute résistance

- Encombrement minimal pour les opérations de levage
- Dimensionné pour 20.000 cycles de travail à pleine charge
- Test de charge appliqué sur 100 % des pièces avant vente
- Coefficient de sécurité 4 dans toutes les directions

CE



CARACTÉRISTIQUES TECHNIQUES

- Coefficient de sécurité : 4
 - Traitement thermique : bonification
 - Code lot de fabrication
- ### ANALYSES DE LABORATOIRE
- Analyse chimique
 - Analyse métallographique
 - Essai de traction
 - Essai de fatigue (20.000 cycles)
 - Test charge d'essai (100% du lot)
- ### CERTIFICATS DISPONIBLES
- Spécifications techniques du produit
 - Rapport d'essai type 2.2 UNI EN10204
 - Certificat de contrôle type 3.1 UNI EN10204
 - Déclaration de Conformité CE

WLL Kg	B mm	M mm	A mm	CHF		
1500	78	37	41	13.20	1	080680115
2500	88	40	42	17.20	1	080680125
4000	94	42	45	24.70	1	080680140
6700	118	51	55	46.00	1	080680167

Attention : - L'élément de couplage doit garantir une résistance mécanique suffisante et être apte au soudage.
- Le soudage doit être effectué par un personnel compétent et dûment instruit.

8041

Anneau de levage mâle en acier allié, traitement thermique d'amélioration

CE



CARACTÉRISTIQUES TECHNIQUES

- coefficient de sécurité : 4
 - traitement thermique : normalisation
 - code lot de fabrication
- ### ANALYSES DE LABORATOIRE
- analyse chimique
 - analyse métallographique
 - essai de traction
 - essai de fatigue (20.000 cycles)
 - test charge d'essai (100% du lot) CERTIFICATS DISPONIBLES
- ### CERTIFICATS DISPONIBLES
- Spécification produit
 - Rapport d'essai type 2.2 UNI EN10204
 - Certificat de contrôle type 3.1 UNI EN10204
 - Déclaration de Conformité CE

Ø mm	E mm	WLL kg	CHF			
M6	11	400	4.35	10	080410206	
* M8	1,25	13	800	4.35	10	080410208
* M10	1,5	17	1000	6.70	6	080410210
* M12	1,75	20,5	1600	10.10	4	080410212
M14	2	20,5	3000	16.70	2	080410214
M16	2,5	27	4000	25.50	2	080410217
M18	2,5	27	5000	25.50	2	080410218
M20	3,0	30	6000	47.00	2	080410221
M22	2,5	30	7000	47.00	2	080410222
M24	3	36	8000	57.00	2	080410225
M27	3	41	10000	87.00	1	080410227
* M30	3,5	45	12000	87.00	1	080410230

(* Caractéristiques dimensionnelles DIN 580:2010
WLL augmenté en fonction du Fascicule Technique Robur

formats de vente spéciaux pour libre service



Ø mm	CHF		
* M8	6.95	1	080419208
* M10	9.75	1	080419210
* M12	13.40	1	080419212

 Robur

 Robur

8043

Anneau de levage femelle en acier allié, traitement thermique d'amélioration

CE

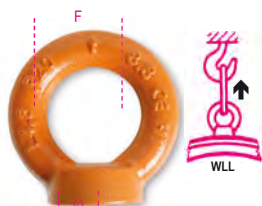

CARACTÉRISTIQUES TECHNIQUES

- coefficient de sécurité : 4
- traitement thermique : normalisation
- code lot de fabrication

ANALYSES DE LABORATOIRE

- analyse chimique
- analyse métallographique
- essai de traction
- essai de fatigue (20.000 cycles)
- test charge d'essai (100% du lot)

CERTIFICATS DISPONIBLES

- Spécification produit
- Rapport d'essai type 2.2 UNI EN10204
- Certificat de contrôle type 3.1 UNI EN10204
- Déclaration de Conformité CE

Ø mm	F mm	WLL kg	CHF	1	10	60
M6	20	400	4.20	1	10	080430206
* M8	1,25 20	800	4.20	1	10	080430208
* M10	1,50 25	1000	6.60	1	6	080430210
* M12	1,75 30	1600	10.00	1	4	080430212
M14	2 35	3000	16.40	1	2	080430214
M16	2 40	4000	23.70	1	2	080430217
M18	2,5 40	5000	23.70	1	2	080430218
M20	2,5 50	6000	46.00	1	2	080430221
M22	2,5 50	7000	46.00	1	2	080430222
M24	3 55	8000	53.50	1	2	080430225
M27	3 60	10000	83.00	1	1	080430227
* M30	3,5 60	12000	83.00	1	1	080430230

(* Caractéristiques dimensionnelles DIN 582:2010
WLL augmenté en fonction du Fascicule Technique Robur

formats de vente spéciaux pour libre service



Ø mm	CHF	1	10
* M8	6.60	1	080439208
* M10	9.45	1	080439210
* M12	12.80	1	080439212

ÉCROUS ET BOULONS À ŒIL DE LEVAGE

Les écrous et boulons à œil de levage de Robur sont fabriqués en acier au carbone doux, avec un ajout minimal en aluminium, et doivent répondre à des paramètres stricts relatifs à la granulométrie du matériau, conformément à la norme DIN580-582. Un travail mécanique précis fait également la différence : la rainure en relief des colliers à la base des œillets/écrous de levage permet une meilleure adhérence et un contact complet avec la surface du corps à soulever. Basés sur ces caractéristiques, nos écrous/boulons à œil de levage sont idéaux pour les tâches de levage complexes et une utilisation intensive, par ex. dans des environnements avec fonctionnement à cycle continu ou dans une plage de température de -20 °C ÷ +200 °C.



8040EZ

Anneau de levage mâle galvanisé

CE

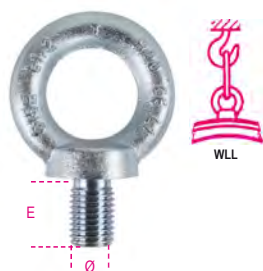

DIN 580:2018-04(**)

DONNEES TECHNIQUES

- facteur de sécurité : 6
- traitement thermique : normalisation
- codes de traçabilité

ESSAIS EN LABORATOIRE

- analyse chimique
- analyse métallographique
- essais de traction

CERTIFICATS DISPONIBLES

- Spécifications techniques du produit
- Rapport d'essai UNI EN10204 type 2.2
- Certificat d'inspection UNI EN10204 type 3.1
- Déclaration de conformité CE

Ø mm	E mm	WLL kg	CHF	60	60
* M6	1 11	90	2.36	60	080400406
M8	1,25 13	140	2.36	60	080400408
M10	1,5 17	230	3.15	40	080400410
M12	1,75 20,5	340	4.20	20	080400412
* M14	2 20,5	480	5.60	20	080400414
M16	2 27	700	6.95	10	080400416
* M18	2,5 27	930	8.45	10	080400418
M20	2,5 30	1200	10.80	10	080400420
* M22	2,5 30	1450	13.90	10	080400422
M24	3 36	1800	20.50	5	080400424
* M27	3 41	2400	25.50	5	080400427
M30	3,5 45	3200	42.00	2	080400430
* M33	3,5 54	3900	59.00	2	080400433
* M33F	2 54	3900	59.00	2	080400434
M36	4 54	4600	60.50	2	080400436
* M36F	3 54	4600	60.50	2	080400437
M42	4,5 63	6300	111.50	1	080400442
* M42F	3 63	6300	111.50	1	080400443
M48	5 68	8600	179.00	1	080400448
* M48F	3 68	8600	179.00	1	080400449
M56	5,5 78	11500	293.00	1	080400456
* M56F	4 78	11500	293.00	1	080400457
M64	6 90	16000	430.00	1	080400464
* M64F	4 90	16000	430.00	1	080400465

*Tailles dimensionnées selon la fiche technique ROBUR

Packs spéciaux



Ø mm	CHF	1	10
M6	52.50	1	080400906
M8	52.50	1	080400908
M10	71.50	1	080400910
M12	71.50	1	080400912

formats de vente spéciaux pour libre service



Ø mm	CHF	1	10
M6	11.70	1	080409606
M8	11.70	1	080409608
M10	8.75	1	080409610
M12	6.00	1	080409412
* M14	7.05	1	080409414
M16	8.75	1	080409416
* M18	10.30	1	080409418
M20	12.40	1	080409420

Ø mm	CHF	1	10
* M22	16.40	1	080409422
M24	22.10	1	080409424
* M27	27.50	1	080409427
M30	43.50	1	080409430

8040EN

Anneau de levage mâle unicolor

CE



DIN 580:2018-04(**)

DONNEES TECHNIQUES

- facteur de sécurité : 6
- traitement thermique : normalisation
- codes de traçabilité

ESSAIS EN LABORATOIRE

- analyse chimique
- analyse métallographique
- essais de traction

CERTIFICATS DISPONIBLES

- Spécifications techniques du produit
- Rapport d'essai UNI EN10204 type 2.2
- Certificat d'inspection UNI EN10204 type 3.1
- Déclaration de conformité CE

Ø mm	E mm	WLL kg	CHF	60	60
* M6	1 11	90	2.27	60	080400306
M8	1,25 13	140	2.27	60	080400308
M10	1,5 17	230	3.10	40	080400310
M12	1,75 20,5	340	4.20	20	080400312
* M14	2 20,5	480	5.25	20	080400314
M16	2 27	700	6.60	10	080400316
* M18	2,5 27	930	8.20	10	080400318
M20	2,5 30	1200	10.10	10	080400320
* M22	2,5 30	1450	13.30	10	080400322
M24	3 36	1800	18.70	5	080400324
* M27	3 41	2400	23.60	5	080400327
M30	3,5 45	3200	39.50	2	080400330
* M33	3,5 54	3900	55.00	2	080400333
* M33F	2 54	3900	55.00	2	080400334
M36	4 54	4600	58.00	2	080400336
* M36F	3 54	4600	58.00	2	080400337
M42	4,5 63	6300	107.00	1	080400342
* M42F	3 63	6300	107.00	1	080400343
M48	5 68	8600	175.50	1	080400348
* M48F	3 68	8600	175.50	1	080400349
M56	5,5 78	11500	280.00	1	080400356
* M56F	4 78	11500	280.00	1	080400357
M64	6 90	16000	407.00	1	080400364
* M64F	4 90	16000	407.00	1	080400365

*Tailles dimensionnées selon la fiche technique ROBUR

formats de vente spéciaux pour libre service



Ø mm	CHF	1	10
M6	11.00	1	080409506
M8	11.00	1	080409508
M10	8.05	1	080409510
M12	5.70	1	080409312
* M14	6.80	1	080409314
M16	8.05	1	080409316
* M18	9.60	1	080409318
M20	11.20	1	080409320
* M22	15.30	1	080409322
M24	20.50	1	080409324
* M27	25.50	1	080409327
M30	41.00	1	080409330

8042EZ

Anneau de levage femelle galvanisé

CE



DIN582:2018-04(**)

DONNEES TECHNIQUES

- facteur de sécurité : 6
- traitement thermique : normalisation
- codes de traçabilité

ESSAIS EN LABORATOIRE

- analyse chimique
- analyse métallographique
- essais de traction

CERTIFICATS DISPONIBLES

- Spécifications techniques du produit
- Rapport d'essai UNI EN10204 type 2.2
- Certificat d'inspection UNI EN10204 type 3.1
- Déclaration de conformité CE

Ø mm	mm	F mm	WLL kg	CHF		
* M6	1	14	90	2.36	60	080420406
M8	1,25	20	140	2.36	60	080420408
M10	1,5	25	230	3.15	40	080420410
M12	1,75	30	340	4.35	30	080420412
* M14	2	30	480	5.60	30	080420414
M16	2	35	700	6.95	20	080420416
* M18	2,5	35	930	8.45	20	080420418
M20	2,5	40	1200	10.60	10	080420420
* M22	2,5	40	1450	13.80	10	080420422
M24	3	50	1800	20.50	5	080420424
* M27	3	55	2400	24.60	5	080420427
M30	3,5	60	3200	39.50	3	080420430
M36	4	70	4600	60.00	2	080420436
* M36F	3	70	4600	60.00	2	080420437
M42	4,5	80	6300	109.00	1	080420442
* M42F	3	80	6300	109.00	1	080420443
M48	5	90	8600	176.50	1	080420448
* M48F	3	90	8600	176.50	1	080420449

*Tailles dimensionnées selon la fiche technique ROBUR

Packs spéciaux



Ø mm	mm	F mm	WLL kg	CHF		
M6	1	20	20	51.00	1	080420906
M8	1,25	20	20	51.00	1	080420908
M10	1,5	20	20	69.50	1	080420910
M12	1,75	15	15	71.50	1	080420912

formats de vente spéciaux pour libre service



Ø mm		CHF		
M6	4	11.40	1	080429606
M8	4	11.40	1	080429608
M10	2	8.20	1	080429610
M12	1	6.00	1	080429412
* M14	1	6.80	1	080429414
M16	1	8.45	1	080429416
* M18	1	9.75	1	080429418
M20	1	12.00	1	080429420
* M22	1	15.30	1	080429422
M24	1	23.60	1	080429424
* M27	1	26.00	1	080429427
M30	1	40.50	1	080429430



8042EN

Anneau de levage femelle unicolor

CE



DIN582:2018-04(**)

DONNEES TECHNIQUES

- facteur de sécurité : 6
- traitement thermique : normalisation
- codes de traçabilité

ESSAIS EN LABORATOIRE

- analyse chimique
- analyse métallographique
- essais de traction

CERTIFICATS DISPONIBLES

- Spécifications techniques du produit
- Rapport d'essai UNI EN10204 type 2.2
- Certificat d'inspection UNI EN10204 type 3.1
- Déclaration de conformité CE

Ø mm	mm	F mm	WLL kg	CHF		
* M6	1	14	90	2.27	60	080420306
M8	1,25	20	140	2.27	60	080420308
M10	1,5	25	230	3.00	40	080420310
M12	1,75	30	340	4.20	30	080420312
* M14	2	30	480	5.40	30	080420314
M16	2	35	700	6.35	20	080420316
* M18	2,5	35	930	8.05	20	080420318
M20	2,5	40	1200	9.75	10	080420320
* M22	2,5	40	1450	13.00	10	080420322
M24	3	50	1800	18.70	5	080420324
* M27	3	55	2400	22.70	5	080420327
M30	3,5	60	3200	36.00	3	080420330
M36	4	70	4600	55.00	2	080420336
* M36F	3	70	4600	55.00	2	080420337
M42	4,5	80	6300	102.50	1	080420342
* M42F	3	80	6300	102.50	1	080420343
M48	5	90	8600	168.00	1	080420348
* M48F	3	90	8600	168.00	1	080420349

*Tailles dimensionnées selon la fiche technique ROBUR

formats de vente spéciaux pour libre service



Ø mm		CHF		
M6	4	11.00	1	080429506
M8	4	11.00	1	080429508
M10	2	8.05	1	080429510
M12	1	5.60	1	080429312
* M14	1	6.60	1	080429314
M16	1	8.05	1	080429316
* M18	1	9.45	1	080429318
M20	1	11.40	1	080429320
* M22	1	14.80	1	080429322
M24	1	21.20	1	080429324
* M27	1	25.50	1	080429327
M30	1	38.50	1	080429330

8044

Anneau de levage femelle, UNI 2948 noir

CE



UNI 2948

CARACTÉRISTIQUES TECHNIQUES

- coefficient de sécurité : 4
- traitement thermique : normalisation
- code lot de fabrication

ANALYSES EN LABORATOIRE

- analyse chimique
- analyse métallographique
- essai de traction

CERTIFICATS DISPONIBLES

- Spécification produit
- Rapport d'essai type 2.2 UNI EN10204
- Certificat de contrôle type 3.1 UNI EN10204
- Déclaration de Conformité CE

Ø mm	mm	WLL kg	CHF		
M8	1,25	80	3.00	4	080440008
M10	1,5	160	4.90	4	080440010
M12	1,75	250	8.60	4	080440012
M14	2	250	13.90	2	080440014
M16	2	400	14.00	2	080440016
M20	2,5	630	23.60	2	080440020
M24	3	1000	41.00	2	080440024



WLL Ton		UNI EN 818	
Ø D mm	0° < β ≤ 45°		45° < β ≤ 60°
		WLL 1	WLL 2
6	1,12	1,6	1,12
7	1,5	2,12	1,5
8	2	2,8	2
10	3,15	4,25	3,15
13	5,3	7,5	5,3
16	8	11,2	8
Ø D mm	0° < β ≤ 45°		45° < β ≤ 60°
		WLL 3	
6	2,36	1,7	
7	3,15	2,24	
8	4,25	3	
10	6,7	4,75	
13	11,2	8	
16	17	11,2	

8091

Élingue chaîne à un brin
grade 8

CE

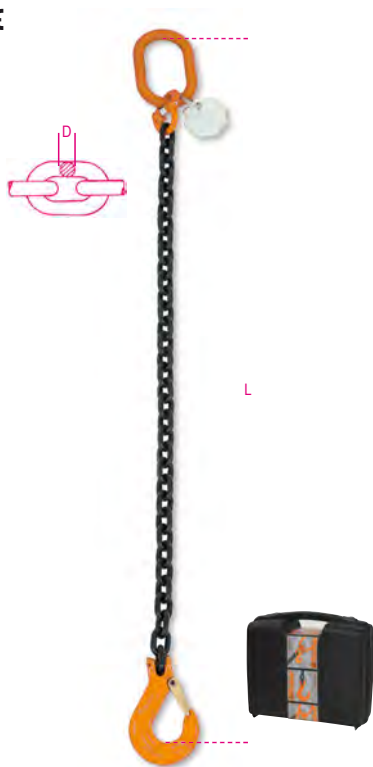

UNI EN 818-4

CARACTÉRISTIQUES TECHNIQUES

- coefficient de sécurité : 4
 - plaque d'identification série
- CERTIFICATS ANNEXES**
- Certificat du Fabricant UNI EN818-4
 - Déclaration de Conformité CE
- CERTIFICATS DISPONIBLES**
- Spécification produit

D mm	L m	WLL ton	CHF		
6*	1	1,12	111.00	1	080910001
6*	2	1,12	135.50	1	080910002
6*	3	1,12	161.00	1	080910003
6*	4	1,12	186.00	1	080910004
7*	1	1,5	121.50	1	080910021
7*	2	1,5	153.50	1	080910022
7*	3	1,5	186.00	1	080910023
7*	4	1,5	218.00	1	080910024
8*	1	2	135.50	1	080910041
8*	2	2	173.50	1	080910042
8*	3	2	211.50	1	080910043
8*	4	2	267.00	1	080910044
10*	1	3,15	174.00	1	080910051
10*	2	3,15	230.50	1	080910052
10*	3	3,15	305.00	1	080910053
10*	4	3,15	361.00	1	080910054
13*	1	5,3	282.00	1	080910131
13*	2	5,3	379.00	1	080910132
13*	3	5,3	471.00	1	080910133
13*	4	5,3	568.00	1	080910134
16*	1	8	553.00	1	080910161
16*	2	8	696.00	1	080910162
16*	3	8	842.00	1	080910163
16*	4	8	990.00	1	080910164
20	1	12,5	1,066.00	1	080910171
20	2	12,5	1,330.00	1	080910172
20	3	12,5	1,595.00	1	080910173
20	4	12,5	1,855.00	1	080910174

* Emballage en coffret

8091SL

Élingue chaîne à 1 brin
chaîne à 1 bras, avec crochet Self-Locking,
grade 8

CE

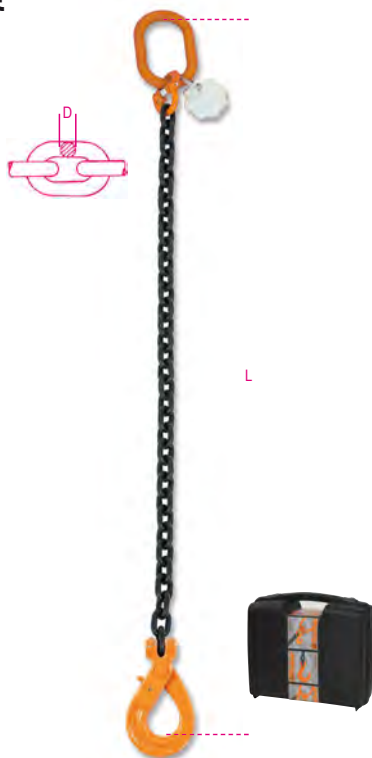

UNI EN 818-4

CARACTÉRISTIQUES TECHNIQUES

- Coefficient de sécurité : 4
 - Plaque d'identification série
- CERTIFICATS ANNEXES**
- Certificat du Fabricant UNI EN818-4
 - Déclaration de Conformité CE
- CERTIFICATS DISPONIBLES**
- Spécification Produit

D mm	L m	WLL ton	CHF		
6*	1	1,12	140.00	1	080910201
6*	2	1,12	165.00	1	080910202
6*	3	1,12	190.50	1	080910203
6*	4	1,12	215.00	1	080910204
7*	1	1,5	160.50	1	080910221
7*	2	1,5	193.00	1	080910222
7*	3	1,5	225.00	1	080910223
7*	4	1,5	257.00	1	080910224
8*	1	2	175.00	1	080910241
8*	2	2	205.00	1	080910242
8*	3	2	250.00	1	080910243
8*	4	2	306.00	1	080910244
10*	1	3,15	219.50	1	080910251
10*	2	3,15	276.00	1	080910252
10*	3	3,15	350.00	1	080910253
10*	4	3,15	424.00	1	080910254
13*	1	5,3	388.00	1	080910331
13*	2	5,3	513.00	1	080910332
13*	3	5,3	582.00	1	080910333
13*	4	5,3	702.00	1	080910334
16*	1	8	730.00	1	080910361
16*	2	8	916.00	1	080910362
16*	3	8	1,019.00	1	080910363
16*	4	8	1,210.00	1	080910364
20	1	12,5	1,610.00	1	080910401
20	2	12,5	1,870.00	1	080910402
20	3	12,5	2,140.00	1	080910403
20	4	12,5	2,400.00	1	080910404

* Emballage en coffret

8092

Élingue chaîne à deux brins
grade 8

CE



EN 818-4

CARACTÉRISTIQUES TECHNIQUES

- coefficient de sécurité : 4
 - plaque d'identification série
- CERTIFICATS ANNEXES**
- Certificat du Fabricant UNI EN818-4
 - Déclaration de Conformité CE
- CERTIFICATS DISPONIBLES**
- Spécification produit

D mm	L m	WLL ton	CHF		
6*	1	1,6	163.50	1	080920001
6*	2	1,6	214.00	1	080920002
6*	3	1,6	263.00	1	080920003
6*	4	1,6	332.00	1	080920004
7*	1	2,12	190.50	1	080920021
7*	2	2,12	255.00	1	080920022
7*	3	2,12	337.00	1	080920023
7*	4	2,12	402.00	1	080920024
8*	1	2,8	215.50	1	080920041
8*	2	2,8	291.00	1	080920042
8*	3	2,8	384.00	1	080920043
8*	4	2,8	460.00	1	080920044
10*	1	4,25	314.00	1	080920051
10*	2	4,25	427.00	1	080920052
10*	3	4,25	536.00	1	080920053
10*	4	4,25	649.00	1	080920054
13*	1	7,5	502.00	1	080920131
13*	2	7,5	691.00	1	080920132
13	3	7,5	857.00	1	080920133
13	4	7,5	1,112.00	1	080920134
16*	1	11,2	1,003.00	1	080920161
16	2	11,2	1,330.00	1	080920162
16	3	11,2	1,625.00	1	080920163
16	4	11,2	1,915.00	1	080920164
20	2	17,0	2,420.00	1	080920172
20	3	17,0	2,950.00	1	080920173
20	4	17,0	3,470.00	1	080920174

* Emballage en coffret



8092SL

Élingue chaîne à 2 brins, avec crochet Self-Locking, grade 8

CE



EN 818-4

CARACTÉRISTIQUES TECHNIQUES

- Coefficient de sécurité : 4
- Plaque d'identification série
- CERTIFICATS ANNEXES
- Certificat du Fabricant UNI EN818-4
- Déclaration de Conformité CE
- CERTIFICATS DISPONIBLES
- Spécification Produit

D mm	L m	WLL ton	CHF		
6*	1	1,6	222.00	1	080920201
6*	2	1,6	262.00	1	080920202
6*	3	1,6	312.00	1	080920203
6*	4	1,6	389.00	1	080920204
7*	1	2,12	268.00	1	080920221
7*	2	2,12	320.00	1	080920222
7*	3	2,12	415.00	1	080920223
7*	4	2,12	480.00	1	080920224
8*	1	2,8	278.00	1	080920241
8*	2	2,8	372.00	1	080920242
8*	3	2,8	448.00	1	080920243
8*	4	2,8	538.00	1	080920244
10*	1	4,25	439.00	1	080920251
10*	2	4,25	517.00	1	080920252
10*	3	4,25	626.00	1	080920253
10*	4	4,25	773.00	1	080920254
13*	1	7,5	770.00	1	080920331
13*	2	7,5	822.00	1	080920332
13*	3	7,5	1,126.00	1	080920333
13*	4	7,5	1,380.00	1	080920334
16*	1	11,2	1,480.00	1	080920361
16*	2	11,2	1,775.00	1	080920362
16*	3	11,2	2,070.00	1	080920363
16*	4	11,2	2,360.00	1	080920364
20	2	17,0	3,510.00	1	080920402
20	3	17,0	4,030.00	1	080920403
20	4	17,0	4,560.00	1	080920404

* Emballage en coffret

8094

Élingue chaîne à quatre brins grade 8

CE



EN 818-4

CARACTÉRISTIQUES TECHNIQUES

- coefficient de sécurité : 4
- plaque d'identification série
- CERTIFICATS ANNEXES
- Certificat du Fabricant UNI EN818-4
- Déclaration de Conformité CE
- CERTIFICATS DISPONIBLES
- Spécification produit

D mm	L m	WLL ton	CHF		
6*	1	2,36	341.00	1	080940001
6*	2	2,36	460.00	1	080940002
6*	3	2,36	560.00	1	080940003
6*	4	2,36	656.00	1	080940004
7*	1	3,15	402.00	1	080940021
7*	2	3,15	531.00	1	080940022
7*	3	3,15	656.00	1	080940023
7*	4	3,15	785.00	1	080940024
8*	1	4,25	484.00	1	080940041
8*	2	4,25	630.00	1	080940042
8*	3	4,25	781.00	1	080940043
8	4	4,25	967.00	1	080940044
10*	1	6,7	639.00	1	080940051
10	2	6,7	877.00	1	080940052
10	3	6,7	1,125.00	1	080940053
10	4	6,7	1,350.00	1	080940054
13	1	11,2	1,060.00	1	080940131
13	2	11,2	1,445.00	1	080940132
13	3	11,2	1,835.00	1	080940133
13	4	11,2	2,220.00	1	080940134
16	1	17	2,085.00	1	080940161
16	2	17	2,670.00	1	080940162
16	3	17	3,260.00	1	080940163
16	4	17	3,840.00	1	080940164
20	2	26,5	4,630.00	1	080940172
20	3	26,5	5,680.00	1	080940173
20	4	26,5	6,720.00	1	080940174

* Emballage en coffret

8094SL

Élingue chaîne à 4 brins, avec crochet Self-Locking, grade 8

CE



EN 818-4

CARACTÉRISTIQUES TECHNIQUES

- Coefficient de sécurité : 4
- Plaque d'identification série
- CERTIFICATS ANNEXES
- Certificat du Fabricant UNI EN818-4
- Déclaration de Conformité CE
- CERTIFICATS DISPONIBLES
- Spécification Produit

D mm	L m	WLL ton	CHF		
6*	1	2,36	458.00	1	080940201
6*	2	2,36	575.00	1	080940202
6*	3	2,36	676.00	1	080940203
6*	4	2,36	773.00	1	080940204
7*	1	3,15	558.00	1	080940221
7*	2	3,15	687.00	1	080940222
7*	3	3,15	811.00	1	080940223
7*	4	3,15	940.00	1	080940224
8*	1	4,25	609.00	1	080940241
8*	2	4,25	756.00	1	080940242
8*	3	4,25	937.00	1	080940243
8	4	4,25	1,123.00	1	080940244
10*	1	6,7	831.00	1	080940251
10	2	6,7	1,058.00	1	080940252
10	3	6,7	1,315.00	1	080940253
10	4	6,7	1,545.00	1	080940254
13	1	11,2	1,500.00	1	080940331
13	2	11,2	1,885.00	1	080940332
13	3	11,2	2,275.00	1	080940333
13	4	11,2	2,660.00	1	080940334
16	1	17	2,820.00	1	080940361
16	2	17	3,410.00	1	080940362
16	3	17	3,990.00	1	080940363
16	4	17	4,590.00	1	080940364
20	2	26,5	6,990.00	1	080940402
20	3	26,5	8,040.00	1	080940403
20	4	26,5	9,090.00	1	080940404

* Emballage en coffret

8096

Élingue chaîne à un brin,
avec raccourcisseur,
grade 8

CE



EN 818-4

CARACTÉRISTIQUES TECHNIQUES

- coefficient de sécurité : 4
- plaque d'identification série
- CERTIFICATS ANNEXES
- Certificat du Fabricant UNI EN818-4
- Déclaration de Conformité CE
- CERTIFICATS DISPONIBLES
- Spécification produit

D mm	L m	WLL ton	CHF		
6*	1	1,12	132.00	1	080960001
6*	2	1,12	157.00	1	080960002
6*	3	1,12	181.50	1	080960003
6*	4	1,12	202.00	1	080960004
7*	1	1,5	146.50	1	080960021
7*	2	1,5	178.50	1	080960022
7*	3	1,5	204.00	1	080960023
7*	4	1,5	236.00	1	080960024
8*	1	2	161.00	1	080960041
8*	2	2	199.00	1	080960042
8*	3	2	237.00	1	080960043
8*	4	2	293.00	1	080960044
10*	1	3,15	224.00	1	080960051
10*	2	3,15	298.00	1	080960052
10*	3	3,15	355.00	1	080960053
10*	4	3,15	412.00	1	080960054
13*	1	5,3	368.00	1	080960131
13*	2	5,3	436.00	1	080960132
13*	3	5,3	529.00	1	080960133
13*	4	5,3	655.00	1	080960134
16*	1	8	727.00	1	080960161
16*	2	8	825.00	1	080960162
16*	3	8	972.00	1	080960163
16	4	8	1,153.00	1	080960164
20	1	12,5	1,390.00	1	080960171
20	2	12,5	1,655.00	1	080960172
20	3	12,5	1,915.00	1	080960173
20	4	12,5	2,175.00	1	080960174

* Emballage en coffret

8096SL

Élingue chaîne à 1 brin,
avec crochet Self-Locking et raccourcisseurs,
grade 8

CE



EN 818-4

CARACTÉRISTIQUES TECHNIQUES

- Coefficient de sécurité : 4
- Plaque d'identification série
- CERTIFICATS ANNEXES
- Certificat du Fabricant UNI EN818-4
- Déclaration de Conformité CE
- CERTIFICATS DISPONIBLES
- Spécification Produit

D mm	L m	WLL ton	CHF		
6*	1	1,12	155.50	1	080960201
6*	2	1,12	181.00	1	080960202
6*	3	1,12	206.00	1	080960203
6*	4	1,12	231.00	1	080960204
7*	1	1,5	178.50	1	080960221
7*	2	1,5	211.00	1	080960222
7*	3	1,5	243.00	1	080960223
7*	4	1,5	275.00	1	080960224
8*	1	2	193.00	1	080960241
8*	2	2	230.50	1	080960242
8*	3	2	268.00	1	080960243
8*	4	2	325.00	1	080960244
10*	1	3,15	269.00	1	080960251
10*	2	3,15	343.00	1	080960252
10*	3	3,15	401.00	1	080960253
10*	4	3,15	456.00	1	080960254
13*	1	5,3	474.00	1	080960331
13*	2	5,3	570.00	1	080960332
13*	3	5,3	663.00	1	080960333
13*	4	5,3	760.00	1	080960334
16*	1	8	904.00	1	080960361
16*	2	8	1,047.00	1	080960362
16*	3	8	1,193.00	1	080960363
16	4	8	1,330.00	1	080960364
20	1	12,5	1,985.00	1	080960401
20	2	12,5	2,245.00	1	080960402
20	3	12,5	2,500.00	1	080960403
20	4	12,5	2,770.00	1	080960404

* Emballage en coffret

8097

Élingue chaîne à deux brins,
avec raccourcisseurs,
grade 8

CE



EN 818-4

CARACTÉRISTIQUES TECHNIQUES

- coefficient de sécurité : 4
- plaque d'identification série
- CERTIFICATS ANNEXES
- Certificat du Fabricant UNI EN818-4
- Déclaration de Conformité CE
- CERTIFICATS DISPONIBLES
- Spécification produit

D mm	L m	WLL ton	CHF		
6*	1	1,6	205.00	1	080970001
6*	2	1,6	245.00	1	080970002
6*	3	1,6	305.00	1	080970003
6*	4	1,6	363.00	1	080970004
7*	1	2,12	239.50	1	080970021
7*	2	2,12	291.00	1	080970022
7*	3	2,12	373.00	1	080970023
7*	4	2,12	438.00	1	080970024
8*	1	2,8	267.00	1	080970041
8*	2	2,8	345.00	1	080970042
8*	3	2,8	435.00	1	080970043
8*	4	2,8	511.00	1	080970044
10*	1	4,25	414.00	1	080970051
10*	2	4,25	527.00	1	080970052
10*	3	4,25	635.00	1	080970053
10*	4	4,25	748.00	1	080970054
13*	1	7,5	671.00	1	080970131
13*	2	7,5	864.00	1	080970132
13	3	7,5	1,034.00	1	080970133
13	4	7,5	1,225.00	1	080970134
16	1	11,2	1,295.00	1	080970161
16	2	11,2	1,585.00	1	080970162
16	3	11,2	1,885.00	1	080970163
16	4	11,2	2,175.00	1	080970164
20	2	17,0	2,950.00	1	080970172
20	3	17,0	3,470.00	1	080970173
20	4	17,0	3,990.00	1	080970174

* Emballage en coffret



8097SL

Élingue chaîne à 2 brins, avec crochet Self-Locking et raccourcisseurs, grade 8



CE



EN 818-4

CARACTÉRISTIQUES TECHNIQUES

- Coefficient de sécurité : 4
 - Plaque d'identification série
- CERTIFICATS ANNEXES**
- Certificat du Fabricant UNI EN818-4
 - Déclaration de Conformité CE
- CERTIFICATS DISPONIBLES**
- Spécification Produit

D mm	L m	WLL ton	CHF		
6*	1	1,6	253.00	1	080970201
6*	2	1,6	293.00	1	080970202
6*	3	1,6	353.00	1	080970203
6*	4	1,6	422.00	1	080970204
7*	1	2,12	304.00	1	080970221
7*	2	2,12	373.00	1	080970222
7*	3	2,12	438.00	1	080970223
7*	4	2,12	502.00	1	080970224
8*	1	2,8	330.00	1	080970241
8*	2	2,8	408.00	1	080970242
8*	3	2,8	498.00	1	080970243
8*	4	2,8	574.00	1	080970244
10*	1	4,25	505.00	1	080970251
10*	2	4,25	618.00	1	080970252
10*	3	4,25	725.00	1	080970253
10*	4	4,25	838.00	1	080970254
13*	1	7,5	882.00	1	080970331
13*	2	7,5	1,075.00	1	080970332
13	3	7,5	1,305.00	1	080970333
13	4	7,5	1,440.00	1	080970334
16	1	11,2	1,740.00	1	080970361
16	2	11,2	2,035.00	1	080970362
16	3	11,2	2,325.00	1	080970363
16	4	11,2	2,530.00	1	080970364
20	2	17,0	4,130.00	1	080970402
20	3	17,0	4,650.00	1	080970403
20	4	17,0	5,180.00	1	080970404

* Emballage en coffret

8098

Élingue chaîne à quatre brins, avec raccourcisseurs, grade 8



CE



EN 818-4

CARACTÉRISTIQUES TECHNIQUES

- coefficient de sécurité : 4
 - plaque d'identification série
- CERTIFICATS ANNEXES**
- Certificat du Fabricant UNI EN818-4
 - Déclaration de Conformité CE
- CERTIFICATS DISPONIBLES**
- Spécification produit

D mm	L m	WLL ton	CHF		
6*	1	2,36	424.00	1	080980001
6*	2	2,36	523.00	1	080980002
6*	3	2,36	619.00	1	080980003
6*	4	2,36	719.00	1	080980004
7*	1	3,15	500.00	1	080980021
7*	2	3,15	603.00	1	080980022
7*	3	3,15	728.00	1	080980023
7*	4	3,15	857.00	1	080980024
8*	1	4,25	556.00	1	080980041
8*	2	4,25	702.00	1	080980042
8*	3	4,25	853.00	1	080980043
8	4	4,25	1,039.00	1	080980044
10*	1	6,7	770.00	1	080980051
10	2	6,7	1,030.00	1	080980052
10	3	6,7	1,255.00	1	080980053
10	4	6,7	1,480.00	1	080980054
13	1	11,2	1,290.00	1	080980131
13	2	11,2	1,675.00	1	080980132
13	3	11,2	2,085.00	1	080980133
13	4	11,2	2,450.00	1	080980134
16	1	17	2,600.00	1	080980161
16	2	17	3,190.00	1	080980162
16	3	17	3,780.00	1	080980163
16	4	17	4,360.00	1	080980164
20	2	26,5	5,850.00	1	080980172
20	3	26,5	6,910.00	1	080980173
20	4	26,5	7,960.00	1	080980174

* Emballage en coffret

8098SL

Élingue chaîne à 4 brins, avec crochet Self-Locking et raccourcisseurs, grade 8



CE



EN 818-4

CARACTÉRISTIQUES TECHNIQUES

- Coefficient de sécurité : 4
 - Plaque d'identification série
- CERTIFICATS ANNEXES**
- Certificat du Fabricant UNI EN818-4
 - Déclaration de Conformité CE
- CERTIFICATS DISPONIBLES**
- Spécification Produit

D mm	L m	WLL ton	CHF		
6*	1	2,36	521.00	1	080980201
6*	2	2,36	639.00	1	080980202
6*	3	2,36	714.00	1	080980203
6*	4	2,36	835.00	1	080980204
7*	1	3,15	630.00	1	080980221
7*	2	3,15	733.00	1	080980222
7*	3	3,15	857.00	1	080980223
7*	4	3,15	986.00	1	080980224
8*	1	4,25	712.00	1	080980241
8*	2	4,25	828.00	1	080980242
8	3	4,25	980.00	1	080980243
8*	4	4,25	1,166.00	1	080980244
10*	1	6,7	951.00	1	080980251
10	2	6,7	1,210.00	1	080980252
10	3	6,7	1,435.00	1	080980253
10	4	6,7	1,660.00	1	080980254
13	1	11,2	1,710.00	1	080980331
13	2	11,2	2,095.00	1	080980332
13	3	11,2	2,500.00	1	080980333
13	4	11,2	2,870.00	1	080980334
16	1	17	3,340.00	1	080980361
16	2	17	3,930.00	1	080980362
16	3	17	4,510.00	1	080980363
16	4	17	5,070.00	1	080980364
20	2	26,5	8,220.00	1	080980402
20	3	26,5	9,280.00	1	080980403
20	4	26,5	10,330.00	1	080980404

* Emballage en coffret

8100

Chaîne en acier allié, classe 8, traitement thermique d'amélioration

CE

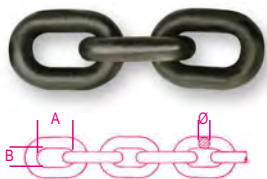

EN 818-2

CARACTÉRISTIQUES TECHNIQUES

- coefficient de sécurité : 4
- traitement thermique : bonification
- code lot de fabrication

ANALYSES DE LABORATOIRE

- analyse chimique
- analyse métallographique
- essai de traction

CERTIFICATS DISPONIBLES

- Spécification produit
- Rapport d'essai type 2.2 UNI EN10204
- Certificat du Fabricant EN818-2
- Déclaration de Conformité CE

WLL kg	Ø mm	A mm	B min mm	CHF/m	📄	🏭
1120	6	18	7,8	25.00	1	081000011
1500	7	21	11,0	32.00	1	081000016
2000	8	24	12,0	38.00	1	081000020
3150	10	30	14,5	56.50	1	081000032
5300	13	39	20,0	96.50	1	081000053
8000	16	48	20,8	147.00	1	081000080
12500	20	60	26,0	263.00	1	081000125

8085R

Anneau de tête simple en acier allié, traitement thermique d'amélioration

CE



EN 1677-4

CARACTÉRISTIQUES TECHNIQUES

- Coefficient de sécurité : 4
- Traitement thermique : bonification
- Code lot de fabrication

ANALYSES DE LABORATOIRE

- Analyse chimique, analyse métallographique
- Test charge d'essai (WLL x 2,5)
- Essai de traction

- Essai de fatigue (min. 20.000 cycles)

CERTIFICATS DISPONIBLES

- Spécification produit
- Rapport d'essai type 2.2 UNI EN10204
- Certificat de contrôle type 3.1 UNI EN10204
- Déclaration de Conformité CE

WLL kg	Ø mm	A mm	B mm	CHF	📄	🏭
1600	7	110	60	13.30	1	080850215
2120	8	110	60	18.90	1	080850220
3150	10	135	75	26.50	1	080850232
5300	13	160	90	46.50	1	080850253
8000	16	180	100	93.50	1	080850280
11200	19	200	110	152.00	1	080850311
16000	20	260	140	250.00	1	080850316
17000	22	300	160	355.00	1	080850317

La charge de travail est relative à l'utilisation des élingues. avec 1 bras. (*) Combiné avec une chaîne ø 6, WLL= 1120 kg.

8086

Anneau de tête triple en acier allié, traitement thermique d'amélioration

CE

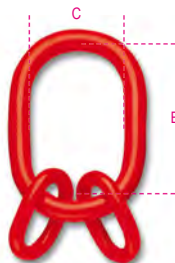

EN 1677-4

CARACTÉRISTIQUES TECHNIQUES

- coefficient de sécurité : 4
- traitement thermique : bonification
- code lot de fabrication

ANALYSES DE LABORATOIRE

- analyse chimique, analyse métallographique
- test charge d'essai (WLL x 2,5)
- essai de traction

- essai de fatigue (min. 20000 cycles)

CERTIFICATS DISPONIBLES

- Spécification produit
- Rapport d'essai type 2.2 UNI EN10204
- Certificat de contrôle type 3.1 UNI EN10204
- Déclaration de Conformité CE

WLL kg	Ø mm	B mm	C mm	CHF	📄	🏭
3150	7	135	75	86.00	1	080860021
4250	8	160	90	132.50	1	080860042
6700	10	180	100	170.50	1	080860067
11200	13	200	110	277.00	1	080860100
17000	16	260	140	404.00	1	080860117
21200	18	340	180	723.00	1	080860121
26500	20	350	190	1,025.00	1	080860126

La charge de travail se réfère à des slings 3 ou 4 bras et un angle β inférieur à 45°.

(*) Combiné avec une chaîne de ø 6mm, WLL= 2360 kg

8090R

Maillon d'assemblage en acier allié, traitement thermique d'amélioration

CE

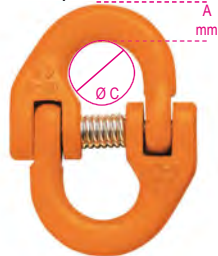

EN 1677-1

CARACTÉRISTIQUES TECHNIQUES

- coefficient de sécurité : 4
- traitement thermique : bonification
- code lot de fabrication

ANALYSES DE LABORATOIRE

- analyse chimique, analyse métallographique
- test charge d'essai (WLL x 2,5)
- essai de traction

- essai de fatigue (min. 20000 cycles)

CERTIFICATS DISPONIBLES

- Spécification produit
- Rapport d'essai type 2.2 UNI EN10204
- Certificat de contrôle type 3.1 UNI EN10204
- Déclaration de Conformité CE

WLL kg	Ø mm	ØC max	A mm	CHF	📄	🏭
1120	6	13	7,5	11.30	1	080900111
1500	7	18	9	14.60	1	080900115
2000	8	18	11	17.90	1	080900120
3150	10	22	13,0	21.80	1	080900131
5300	13	30	16	39.50	1	080900153
8000	16	32	22	86.00	1	080900180
12500	20	40	25	197.00	1	080900312

8060R

Crochet à chape standard en acier allié, traitement thermique d'amélioration

CE



EN 1677-2

CARACTÉRISTIQUES TECHNIQUES

- coefficient de sécurité : 4
- traitement thermique : bonification
- code lot sur pivot, languette, corps

ANALYSES DE LABORATOIRE

- analyse chimique, analyse métallographique
- test charge d'essai (WLL x 2,5)
- essai de traction

- essai de fatigue (min. 20.000 cycles)

CERTIFICATS DISPONIBLES

- Spécification produit
- Rapport d'essai type 2.2 UNI EN10204
- Certificat de contrôle type 3.1 UNI EN10204
- Déclaration de Conformité CE

WLL kg	Ø mm	C mm	CHF	📄	🏭
1120	6	19	21.20	1	080600111
1500	7	19	22.70	1	080600115
2000	8	21	23.70	1	080600120
3150	10	27	41.00	1	080600132
5300	13	35	65.00	1	080600153
8000	16	48	207.00	1	080600180
12500	20	54	368.00	1	080600225

8058R

Crochet à verrouillage automatique à chape, acier allié, traitement thermique d'amélioration

CE



EN 1677-3

CARACTÉRISTIQUES TECHNIQUES

- coefficient de sécurité : 4
- traitement thermique : normalisation
- code lot de fabrication

ANALYSES DE LABORATOIRE

- analyse chimique, analyse métallographique
- essai de traction
- essai de fatigue (min. 20.000 cycles)

- test charge d'essai (100% du lot)

CERTIFICATS DISPONIBLES

- Spécification produit
- Rapport d'essai type 2.2 UNI EN10204
- Certificat de contrôle type 3.1 UNI EN10204
- Déclaration de Conformité CE

WLL kg	Ø mm	J min mm	CHF	📄	🏭
1120	6	28	45.00	1	080580112
2000	7-8	34	55.00	1	080580120
3150	10	44	86.00	1	080580132
5300	13	52	170.50	1	080580153
8000	16	67	384.00	1	080580180
12500	20	77	960.00	1	080580225

8061R

Crochet parallèle à chape, avec sécurité de blocage, acier allié, traitement thermique d'amélioration

CE



EN 1677-1

CARACTÉRISTIQUES TECHNIQUES

- coefficient de sécurité: 4
- traitement thermique : normalisation
- code lot de fabrication

ANALYSES DE LABORATOIRE

- analyse chimique, analyse métallographique
- essai de traction
- essai de fatigue (min. 20.000 cycles)
- test charge d'essai (100% du lot)

CERTIFICATS DISPONIBLES

- Spécification produit
- Rapport d'essai type 2.2 UNI EN10204
- Certificat de contrôle type 3.1 UNI EN10204
- Déclaration de Conformité CE

WLL kg	Ø mm	E mm	CHF	📄	📄
1120	6	8	15.80	1	080610211
2000	7-8	11	18.00	1	080610220
3150	10	13	33.00	1	080610231
5300	13	17	57.50	1	080610253
8000	16	20	129.50	1	080610280
12500	20	24	309.00	1	080610312

8052

Crochet de levage à œil pour câble, haute résistance en acier allié

CE



EN 1677-2

CARACTÉRISTIQUES TECHNIQUES

- coefficient de sécurité: 4
- traitement thermique: bonification
- code lot de fabrication

ANALYSES DE LABORATOIRE

- analyse chimique, analyse métallographique
- essai de traction
- essai de fatigue (min. 20.000 cycles)
- test charge d'essai (WLL x 2)

CERTIFICATS DISPONIBLES

- Spécification produit
- Rapport d'essai type 2.2 UNI EN10204
- Certificat de contrôle type 3.1 UNI EN10204
- Déclaration de Conformité CE

WLL kg	C mm	CHF	📄	📄	
8052 0,8	800	18	8.05	1	080520008
8052 1,12	1120	22,5	10.80	1	080520011
8052 2	2000	30	22.80	1	080520020
8052 3,15	3150	36	34.50	1	080520031
8052 4	4000	39,5	45.00	1	080520040

8055S 5,4	5400	32	88.00	1	080550145
8055S 8,0	8000	43	153.50	1	080550170
8055S 11,5	11500	53	306.00	1	080550215
8055S 16,0	16000	58	412.00	1	080550260
8055S 22,0	22000	78	965.00	1	080550320

8057R

Crochet à verrouillage automatique à œil, acier allié, traitement thermique d'amélioration

CE



EN 1677-3

CARACTÉRISTIQUES TECHNIQUES

- coefficient de sécurité : 4
- traitement thermique : normalisation
- code lot de fabrication

ANALYSES DE LABORATOIRE

- analyse chimique, analyse métallographique
- essai de traction
- essai de fatigue (min. 20.000 cycles)
- test charge d'essai (100% du lot)

CERTIFICATS DISPONIBLES

- Spécification produit
- Rapport d'essai type 2.2 UNI EN10204
- Certificat de contrôle type 3.1 UNI EN10204
- Déclaration de Conformité CE

WLL kg	Ø mm	J min mm	ØB mm	CHF	📄	📄
1120	6	28	22	36.50	1	080570112
2000	7-8	34	25	43.50	1	080570120
3150	10	44	32	78.00	1	080570132
5300	13	54	40	273.00	1	080570153

8063

Crochet de levage orientable (horse charge), acier allié, traitement thermique d'amélioration

CE

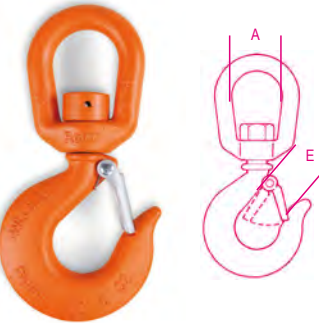

EN 1677-1

CARACTÉRISTIQUES TECHNIQUES

- coefficient de sécurité : 4
- traitement thermique : normalisation
- code lot de fabrication

ANALYSES DE LABORATOIRE

- analyse chimique, analyse métallographique
- essai de traction
- essai de fatigue (min. 20.000 cycles)
- test charge d'essai (100% du lot)

CERTIFICATS DISPONIBLES

- Spécification produit
- Rapport d'essai type 2.2 UNI EN10204
- Certificat de contrôle type 3.1 UNI EN10204
- Déclaration de Conformité CE

WLL kg	A mm	E mm	CHF	📄	📄
800	32	20,5	18.00	1	080630008
1120	38	20,5	22.70	1	080630011
2000	44,5	22	27.50	1	080630020
3150	44,5	27	34.00	1	080630031

8063SL

crochets pivotants auto-bloquant (pas de sous charge) Alliage d'acier haute résistance Niveau 8

CE

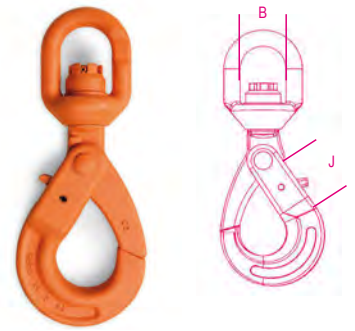

EN 1677-1

DONNÉES TECHNIQUES

- facteur de sécurité : 4
- traitement thermique : durcissement et revenu
- code de traçabilité TESTS DE LABORATOIRE
- analyse chimique, analyse métallographique
- essai de traction
- essai de fatigue (min. 20 000 cycles)
- test de charge (100% du lot) CERTIFICATS DISPONIBLES
- Spécifications techniques du produit
- Rapport d'essai UNI EN10204 type 2.2
- Certificat d'inspection UNI EN10204 type 3.1
- Déclaration de conformité CE

WLL kg	Ø mm	B mm	J mm	CHF	📄	📄
1120	6	32	45	47.00	1	080630311
2000	8	35	59	65.50	1	080630320
3150	10	42	54	114.00	1	080630331
5300	13	49	83	174.00	1	080630353

8064S

Crochet à touret, en acier au carbone, traitement thermique d'amélioration

CE

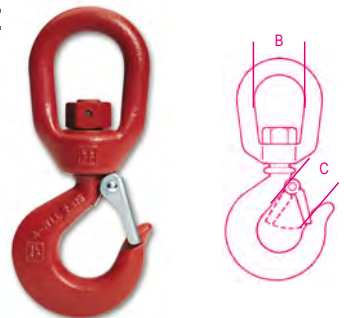

EN 1677-5

CARACTÉRISTIQUES TECHNIQUES

- coefficient de sécurité : 5
- traitement thermique : bonification
- code lot de fabrication

ANALYSES DE LABORATOIRE

- analyse chimique, analyse métallographique
- test charge d'essai (WLL x 2,5)
- essai de traction
- essai de fatigue (min. 20000 cycles)

CERTIFICATS DISPONIBLES

- Spécification produit
- Rapport d'essai type 2.2 UNI EN10204
- Certificat de contrôle type 3.1 UNI EN10204
- Déclaration de Conformité CE

WLL kg	B mm	C mm	CHF	📄	📄
800	31	20	44.00	1	080640107
1000	40	22	62.00	1	080640110
1600	47	23	81.00	1	080640115
2000	47	27	88.50	1	080640120
3200	64	35	155.00	1	080640130
5000	77	43	283.00	1	080640150
7500	90	53	413.00	1	080640175
10000	96	58	686.00	1	080640199

8065SC

Crochet à touret pivotant sous charge en acier au carbone, traitement thermique d'amélioration

CE



EN 1677-5

CARACTÉRISTIQUES TECHNIQUES

- coefficient de sécurité : 5
- traitement thermique : bonification
- code lot de fabrication

ANALYSES DE LABORATOIRE

- analyse chimique, analyse métallographique
- test charge d'essai (WLL x 2,5)
- essai de traction

- essai de fatigue (min. 20000 cycles)

CERTIFICATS DISPONIBLES

- Spécification produit
- Rapport d'essai type 2.2 UNI EN10204
- Certificat de contrôle type 3.1 UNI EN10204
- Déclaration de Conformité CE

WLL kg	B mm	C mm	CHF	📦	🚚
800	38	20	88.00	1	080650107
1000	38	22	96.00	1	080650110
1600	47	23	119.00	1	080650115
2000	47	27	135.50	1	080650120
3200	54	35	238.50	1	080650130
5000	72	43	353.00	1	080650150
7500	82	53	599.00	1	080650175

8062

Crochet coulissant en acier allié

CE

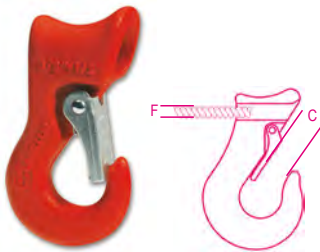

CARACTÉRISTIQUES TECHNIQUES

- coefficient de sécurité : 5
- traitement thermique : bonification
- code lot de fabrication

ANALYSES DE LABORATOIRE

- analyse chimique, analyse métallographique
- test charge d'essai (WLL x 2,5)
- essai de traction

CERTIFICATS DISPONIBLES

- Spécification produit
- Rapport d'essai type 2.2 UNI EN10204
- Certificat de contrôle type 3.1 UNI EN10204
- Déclaration de Conformité CE

WLL kg	C mm	F mm	CHF	📦	🚚
1500	19	10-13	53.50	1	080620013
2000	21	16	75.00	1	080620016
3000	26	18	125.00	1	080620018

8051S

Crochet à œil avec sûreté de blocage, zingué, acier au carbone

CE



CARACTÉRISTIQUES TECHNIQUES

- coefficient de sécurité : 4
- traitement thermique : normalisation
- code lot de fabrication

ANALYSES DE LABORATOIRE

- analyse chimique
- analyse métallographique
- essai de traction

CERTIFICATS DISPONIBLES

- Spécification produit
- Rapport d'essai type 2.2 UNI EN10204
- Certificat de contrôle type 3.1 UNI EN10204
- Déclaration de Conformité CE

WLL kg	C mm	F mm	CHF	📦	🚚
250	14	12	3.90	10	080510202
500	18	16,5	8.60	5	080510205

formats de vente spéciaux pour libre service



WLL kg	📦	CHF	📦	🚚
250	1	5.50	1	080519202
500	1	10.70	1	080519205

8134

Élévateur magnétique permanent

CE

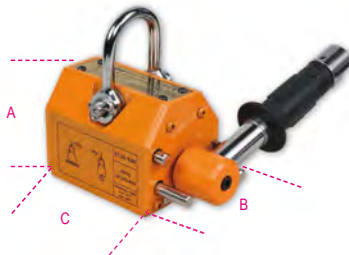

EN13155

Données techniques :

- Coefficient de sécurité : 3
- Plaque d'identification série

Certificats disponibles :

- Certificat du Fabricant
- Déclaration de Conformité DM2006/42/CE
- Rapport d'essai type 2.2 UNI EN10204
- Manuel d'utilisation et d'entretien

WLL kg	A mm	B mm	C mm	CHF	📦	🚚
100	70	64	92	567.00	1	081340010
300	96	88	165	994.00	1	081340030
600	120	118	236	1,845.00	1	081340060
1000	168	168	264	3,060.00	1	081340100

8135

Pincettes de levage pour surfaces planes en acier d'une dureté maximale de 30HRC/300HB équipées d'œillets de levage articulés

CE



EN13155

DONNÉES TECHNIQUES

- Facteur de sécurité: 3
- Plaque d'identification du numéro de série

CERTIFICATS DISPONIBLES

- Certificat du fabricant
- Déclaration de conformité CE
- Rapport d'essai UNI EN10204 type 2.2
- Spécifications techniques du produit

WLL t	A mm	E mm	📦	🚚	CHF
0,75	0-15	2	2	1	162.50
1,0	0-20	5	5	1	219.50
2,0	0-25	8	8	1	326.00
3,0	0-30	15	15	1	553.00
5,0	0-50	23	23	1	777.00

8143

Palans manuels à chaîne

CE



EN13157

Certificato TUV

WLL t	📦	sforz / effort Lm	kg	CHF	📦	🚚
0,5	3	27	262.00	1	081430005	
1	3	44	309.00	1	081430010	
1,5	3	44	409.00	1	081430015	
2	3	44	449.00	1	081430020	
3	3	45	579.00	1	081430030	
5	3	47	861.00	1	081430050	

0,5	6	27	393.00	1	081430105
1	6	44	441.00	1	081430110
1,5	6	44	573.00	1	081430115
2	6	44	622.00	1	081430120
3	6	45	890.00	1	081430130
5	6	47	1,260.00	1	081430150

8146

palans à levier

CE

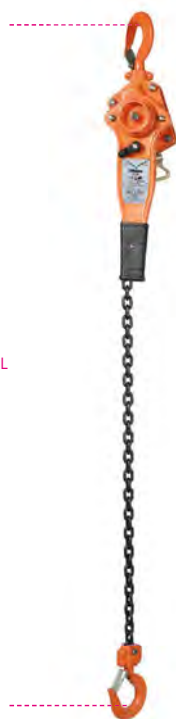

EN13157
Certificato TUV

WLL t	L m	sforzo / effort kg	CHF		
0,75	1,5	21*	320.00	1	081460008
1,5	1,5	41*	455.00	1	081460015
3,0	1,5	41	609.00	1	081460030
6,0	1,5	46	990.00	1	081460060

0,75	3,0	21*	358.00	1	081460108
1,5	3,0	41*	506.00	1	081460115
3,0	3,0	41	698.00	1	081460130
6,0	3,0	46	1,187.00	1	081460160

H= distance minimale entre les crochets
(*) dotée de système de protection contre le surcharge

8146C

Palans à levier compact

CE



EN13157
Certificato TUV

WLL t	L m	sforzo / effort kg	CHF		
0,25	1,5	20,7	294.00	1	081460002

8147C

Chariot de translation à chaîne pour palans manuels

Adapté aux poutres structurales INP, IPB, IPE, HEA, HEB, par exemple.

CE



EN 13157

Caractéristiques techniques :
• coefficient de sécurité : 4
• plaque d'identification du numéro de série

Certificats disponibles :
• certificat du fabricant
• Déclaration de Conformité CE
• Rapport d'essai type 2.2 UNI EN10204
• Spécifications techniques du produit

WLL t	L min mm	L max mm	Lm	CHF		
1,0	58	220	3	327.00	1	081470510
2,0	66	220	3	419.00	1	081470520
3,0	74	220	3	641.00	1	081470530
5,0	90	220	3	884.00	1	081470550

Article livré démonté : il doit être assemblé avant utilisation conformément au mode d'emploi.

8147S

Chariot à pousser pour palans manuels

Adapté aux poutres structurales INP, IPB, IPE, HEA, HEB, par exemple.

CE



EN 13157

Caractéristiques techniques :
• coefficient de sécurité : 4
• plaque d'identification du numéro de série

Certificats disponibles :
• certificat du fabricant
• Déclaration de Conformité CE
• rapport d'essai type 2.2 UNI EN10204
• spécifications techniques du produit

WLL t	L min mm	L max mm	øF mm	CHF		
0,5	50	220	25	211.00	1	081470005
1,0	58	220	30	270.00	1	081470010
2,0	66	220	40	343.00	1	081470020

Article livré démonté : il doit être assemblé avant utilisation conformément au mode d'emploi.

8147P

Pince d'ancrage pour palans manuels

Adaptée aux poutres structurales INP, IPB, IPE, HEA, HEB, par exemple.

CE

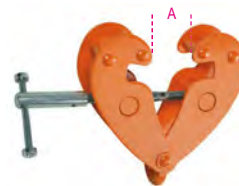

Caractéristiques techniques :
• Coefficient de sécurité : 4
• Plaque d'identification du numéro de série

Certificats disponibles :
• certificat du fabricant
• Déclaration de Conformité CE
• rapport d'essai type 2.2 UNI EN10204
• spécifications techniques du produit

WLL t	A min mm	A max mm	CHF		
1,0	90	180	139.00	1	081470210
2,0	90	190	168.00	1	081470220
3,0	85	280	284.00	1	081470230
5,0	85	280	414.00	1	081470250

8148

Treuil manuel à câble,
corps en alliage d'aluminium
avec levier de commande, câble et crochet

Léger et portable, le treuil manuel à câble Robur est conforme à la norme EN 13157, fabriqué avec des matériaux de haute qualité et adapté pour soulever, tracter, tendre et sécuriser des charges dans toutes les directions au moyen du levier de commande.

Habituellement utilisé en se servant d'une connexion à un point d'ancrage fixe, il permet une grande précision dans le positionnement de la charge et garantit un fonctionnement sûr dans toutes les directions : horizontale, verticale ou inclinée. Son design compact et pratique le rend facile à installer et à utiliser.

Le treuil manuel Robur permet d'utiliser des cordes sans limites de longueur et, après vérification de la structure de support, il est possible d'en augmenter la portée d'un facteur 2, 3, 4 ou plus, par le biais de rouleaux de renvoi et de crochets, conformément à la norme de référence.

CE



EN 13157

• Coefficient de sécurité : 4:1

WLL t	L m	A mm	ø f mm	CHF		
0,8	20	426	8,3	470.00	1	081480008
1,6	20	545	11	737.00	1	081480016
3,2	20	660	16	1,210.00	1	081480032

0,8	30	426	8,3	523.00	1	081480108
1,6	30	545	11	818.00	1	081480116
3,2	30	660	16	1,360.00	1	081480132

0,8	50	426	8,3	632.00	1	081480308
1,6	50	545	11	947.00	1	081480316
3,2	50	660	16	1,650.00	1	081480332

8148F

Câble métallique en acier galvanisé gainé en croix
avec crochet haute résistance

CE



WLL t	L m	ØF	CHF		
0,8	20	8,3	127.50	1	081480520
1,6	20	11	202.00	1	081480521
3,2	20	16	393.00	1	081480523

0,8	30	8,3	181.00	1	081480530
1,6	30	11	283.00	1	081480531
3,2	30	16	543.00	1	081480533

0,8	50	8,3	290.00	1	081480550
1,6	50	11	413.00	1	081480551
3,2	50	16	831.00	1	081480553

8120

Chaîne type "Genovese"
pour connexions statiques,
galvanisée



CARACTÉRISTIQUES TECHNIQUES

- Coefficient de sécurité : 4
- CERTIFICATS DISPONIBLES
- Spécification produit
- Rapport d'essai type 2.2 UNI EN10204

Ø mm	nr	WFL kg	m	CHF		
1,5	10	8	150	244.00	1	081200015
1,6	12	15	150	254.00	1	081200016
2,2	14	25	75	149.00	1	081200022
2,7	16	40	75	184.00	1	081200027
3,0	17	55	75	203.50	1	081200030
3,4	18	100	60	207.00	1	081200034
3,8	19	110	50	200.00	1	081200038
4,4	20	200	40	185.50	1	081200044
4,8	21	250	30	176.50	1	081200048
5,5	22	300	25	176.50	1	081200055
5,8	23	310	25	200.00	1	081200058
6,5	24	400	25	227.00	1	081200065
7,0	25	450	25	277.00	1	081200070
7,5	26	550	20	246.50	1	081200075
* 8,0	27	600	25	357.00	1	081200080
* 9,0	28	800	25	449.00	1	081200090
* 10,0	30	1000	20	454.00	1	081200100
* 12,0	32	1400	15	481.00	1	081200120

Attention : produit NON destiné au levage

(*) emballées en ÉCHEVEAUX

8120B

Chaîne type "Genovese"
pour connexions statiques,
galvanisée



CARACTÉRISTIQUES TECHNIQUES

- coefficient de sécurité: 4
- CERTIFICATS DISPONIBLES
- Spécification produit
- Rapport d'essai type 2.2 UNI EN10204

Ø mm	nr	WFL kg	m	CHF		
1,5	10	8	200	304.00	1	081200315
1,6	12	15	200	321.00	1	081200316
2,2	14	25	100	189.50	1	081200322
2,7	16	40	100	243.00	1	081200327
3,0	17	55	75	202.50	1	081200330
3,4	18	100	100	322.00	1	081200334
3,8	19	110	75	286.00	1	081200338
4,4	20	200	50	221.50	1	081200344
4,8	21	250	50	286.00	1	081200348
5,5	22	300	40	274.00	1	081200355
5,8	23	310	30	234.50	1	081200358
6,5	24	400	30	267.00	1	081200365
7,0	25	450	25	270.00	1	081200370
7,5	26	550	25	298.00	1	081200375
8,0	27	600	15	229.50	1	081200380
9,0	28	800	15	271.00	1	081200390
10,0	30	1000	10	222.00	1	081200400
12,0	32	1400	8	257.00	1	081200420

Attention : produit NON destiné au levage

8121MZC

Chaînes génoises galvanisées à chaud



CERTIFICATS DISPONIBLES

- Spécification de produit
- Rapport d'essai UNI EN10204 type 2.2

Ø mm	nr	WFL kg	m	CHF		
6,0	23	310	50	438.00	1	081210306
8,0	27	600	50	748.00	1	081210308
10,0	30	1000	50	1,183.00	1	081210310
12,0	32	1400	50	1,700.00	1	081210312
14,0	34	1800	50	2,385.00	1	081210314

8120D

Chânes calibrées DIN766
galvanisé par électrolyse
disponible dans n'importe quelle longueur sur demande
(>30m)



TECHNIQUES

- facteur de sécurité: 4 CERTIFICATS DISPONIBLES
- Spécifications techniques du produit
- Rapport d'essai UNI EN10204 type 2.2

Ø mm	P mm	WFL kg	m	CHF		
4	16	200	30	152.50	1	081200640
5	18,5	320	30	215.00	1	081200650
6	18,5	400	30	326.00	1	081200660
7	22	630	30	392.00	1	081200670
8	24	800	30	518.00	1	081200680
10	28	1250	30	791.00	1	081200700

Chânes calibrées DIN766
galvanisé à chaud

Ø mm	P mm	WFL kg	m	CHF		
4	16	200	30	189.50	1	081200840
5	18,5	320	30	260.00	1	081200850
6	18,5	400	30	386.00	1	081200860
7	22	630	30	453.00	1	081200870
8	24	800	30	601.00	1	081200880
10	28	1250	30	910.00	1	081200900

8129

Chaîne de délimitation
en métal galvanisé verni blanc et rouge



Ø mm	m	CHF		
5	30	322.00	1	081290050

Attention : produit NON destiné au levage ou à l'ancrage

8130

Chaîne antivol en acier allié,
cimentée et normalisée,
galvanisée



Ø mm	L mm	CHF		
6	800	19.50	1	081300068
8	1000	42.00	1	081300081
8	1200	47.50	1	081300082
10	1500	73.00	1	081300105

8074

Mousqueton, zingué

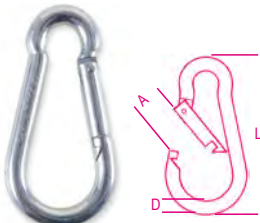

DIN 5299 tipo C

CARACTÉRISTIQUES TECHNIQUES

- coefficient de sécurité : 4
- CERTIFICATS DISPONIBLES
- Spécification produit
- Rapport d'essai type 2.2 UNI EN10204

DxL mm	A mm	WFL kg	CHF		
* 4x40	6	20	0.80	100	080740040
5x50	7	30	0.81	100	080740050
6x60	8	40	0.90	100	080740060
7x70	9	60	1.15	50	080740070
8x80	11	75	1.38	50	080740080
9x90	12	100	1.88	25	080740090
10x100	13	120	2.53	25	080740100
11x120	16	140	3.45	20	080740101
12x140	22	140	4.80	15	080740102
13x160	24	200	6.60	10	080740103
* 14x180	32	250	13.80	5	080740104

Packs spéciaux



DxL mm	A mm		CHF		
6x60	8	50	50.00	1	080740760
7x70	9	25	32.00	1	080740770
8x80	11	25	38.50	1	080740780
9x90	12	15	31.50	1	080740790
10x100	13	15	42.50	1	080740800
11x120	16	10	38.50	1	080740801
12x140	22	10	54.00	1	080740802

8074A

Mousqueton avec anneau, zingué

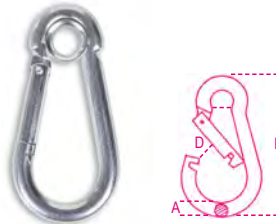

DIN 5299 tipo A

CARACTÉRISTIQUES TECHNIQUES

- coefficient de sécurité : 4
- CERTIFICATS DISPONIBLES
- Spécification produit
- Rapport d'essai type 2.2 UNI EN10204

øAxL mm	D mm	WFL kg	CHF		
5x50	7,4	30	1.10	50	080740405
6x60	8,7	40	1.26	50	080740406
8x80	10,5	75	1.72	25	080740408
10x100	13,3	120	3.00	10	080740410

8074G

Mousqueton à vis, zingué

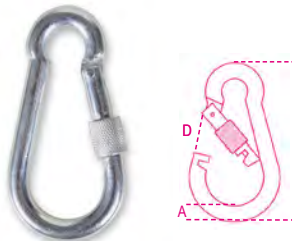

CARACTÉRISTIQUES TECHNIQUES

- coefficient de sécurité : 4
- CERTIFICATS DISPONIBLES
- Spécification produit
- Rapport d'essai type 2.2 UNI EN10204

øAxL mm	D mm	WFL kg	CHF		
5x50	7,5	30	1.23	50	080740305
6x60	8,5	40	1.41	50	080740306
8x80	10,3	75	1.88	25	080740308
10x100	10,6	120	3.15	10	080740310

8080

Maillon rapide, zingué



CARACTÉRISTIQUES TECHNIQUES

- coefficient de sécurité : 4
- CERTIFICATS DISPONIBLES
- Spécification produit
- Rapport d'essai type 2.2 UNI EN10204

DxL mm	A mm	WFL kg	CHF		
3,5x36	5	20	0.65	100	080800003
4x40	6	30	0.70	100	080800004
5x49	6	50	0.85	100	080800005
6x57	8	60	1.06	100	080800006
7x66	8	100	1.38	50	080800007
8x74	11	140	1.64	50	080800008
9x80	11	160	2.36	25	080800009
10x89	11	220	2.77	25	080800010
12x105	15	300	4.80	20	080800012
14x122	16,5	400	10.30	3	080800014

8080FM

Câbles manquants/missing links,
galvanisés

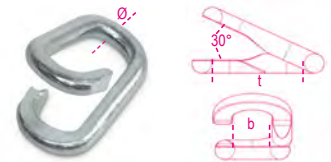

TECHNIQUES

- coefficient de sécurité : 4 CERTIFICATS DISPONIBLES
- Spécifications techniques du produit
- Rapport d'essai UNI EN10204 type 2.2

M	ød mm	b mm	t mm	CHF		
4	3,8	8,6	21,5	0.51	100	080800204
5	4,7	11,1	25,8	0.84	50	080800205
6	5,3	13,8	32,0	1.62	30	080800206
7	6,5	16,8	37,0	1.93	10	080800207
8	8,0	18,0	38,0	2.83	10	080800208

8082

Œillet
acier galvanisé

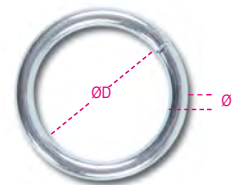

Ø mm	ØD mm	WFL kg	CHF		
4	20	75	0.50	50	080820004
5	30	125	0.65	20	080820005
6	40	185	1.06	10	080820006
7	50	265	1.64	5	080820007
8	60	350	2.20	5	080820008

8083

Crochet en "S"
acier galvanisé



Ø mm	L mm	WFL kg	CHF		
3	33	4	0.10	100	080830003
4	40	5	0.15	60	080830004
5	47	12	0.28	50	080830005
6	59	18	0.51	30	080830006
8	79	33	1.27	10	080830008

8114

Trous oblongs pivotant et galvanisés

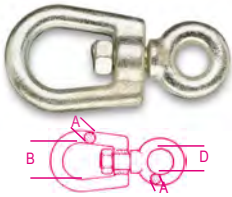

DONNEES TECHNIQUES :

- facteur de sécurité : 4
- codes de traçabilité

TESTS EN LABORATOIRE

- Essais de traction

CERTIFICATS DISPONIBLES

- Spécifications techniques du produit
- Rapport d'essai UNI EN10204 type 2.2
- Certificat d'inspection UNI EN10204 type 3.1

A mm	B mm	D mm	WFL kg	CHF		
8	30	16	250	5.20	10	081140008
10	38	18	300	9.60	10	081140010
12	42	20	650	13.90	5	081140012
14	48	22	820	21.60	5	081140014
16	57	24	1000	29.50	3	081140016
18	64	26	1600	35.50	3	081140018
20	72	30	2000	49.50	1	081140020
22	80	34	2500	69.50	1	081140022

8116

Emerillon à anneau double, zingué

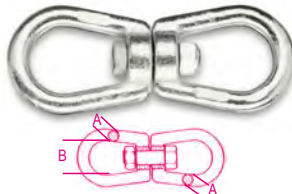

CARACTÉRISTIQUES TECHNIQUES

- coefficient de sécurité : 4
- code d'identification

ANALYSES DE LABORATOIRE

- essai de traction

CERTIFICATS DISPONIBLES

- Spécification produit
- Rapport d'essai type 2.2 UNI EN10204

A mm	B mm	WFL kg	CHF		
6	23	140	5.60	10	081160006
8	30	250	6.95	10	081160008
10	38	300	12.70	5	081160010
12	42	650	20.80	5	081160012
14	48	820	31.00	3	081160014
16	57	1000	39.00	3	081160016
18	64	1600	47.00	1	081160018
20	72	2000	67.00	1	081160020
22	80	2500	103.50	1	081160022

8317SZ

Serre-câble plat, 1 boulons,
zingué

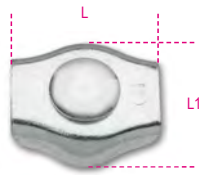

CERTIFICATS DISPONIBLES

- Rapport d'essai type 2.2 UNI EN10204

Ø mm	L mm	L1 mm	CHF		
2	15	14	0.31	100	083170102
3	18	16	0.33	100	083170103
4	20	19	0.46	100	083170104
5	24	23	0.53	50	083170105
6	30	27	0.62	30	083170106
8	36	34	1.20	20	083170108
10	42	37	1.79	10	083170110

8317DZ

Serre-câble plat, 2 boulons,
zingué



CERTIFICATS DISPONIBLES

- Rapport d'essai type 2.2 UNI EN10204

Ø mm	L mm	L1 mm	CHF		
2	30	14	0.41	50	083170002
3	35	15	0.56	50	083170003
4	40	18	0.65	50	083170004
5	50	21	0.82	25	083170005
6	60	25	1.10	20	083170006
8	76	33	2.36	10	083170008
10	95	37	3.55	10	083170010

8381SL

étrier avec 2 écrous et 2 rondelles, série
légère
zingué

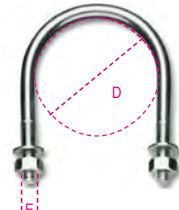

CERTIFICATS DISPONIBLES

- Spécification produit
- Rapport d'essai type 2.2 UNI EN10204

D mm	D gas	E mm	CHF		
11	1/8"	M6	0.65	100	083810201
14	1/4"	M6	0.70	100	083810202
18	3/8"	M6	0.70	100	083810203
22	1/2"	M6	0.80	100	083810204
27	3/4"	M6	0.80	100	083810205
34	1"	M6	0.87	100	083810206
43	1 1/4"	M6	0.87	100	083810207
49	1 1/2"	M8	1.55	50	083810208
61	2"	M8	1.64	50	083810209
77	2 1/2"	M8	1.95	25	083810210
89	3"	M8	2.09	25	083810211
102	3 1/2"	M8	2.36	25	083810212
115	4"	M8	2.61	25	083810213
140	5"	M8	5.70	25	083810215
168	6"	M10	6.20	25	083810218
220	8"	M10	12.70	10	083810220

8381SP

étrier avec 2 écrous et 2 rondelles, série
lourde
zingué

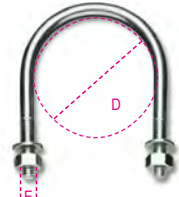

CERTIFICATS DISPONIBLES

- Spécification produit
- Rapport d'essai type 2.2 UNI EN10204

D mm	D gas	E mm	CHF		
22	1/2"	M8	1.15	100	083810301
27	3/4"	M8	1.24	100	083810302
34	1"	M8	1.34	100	083810303
43	1 1/4"	M8	1.46	100	083810304
49	1 1/2"	M10	2.46	25	083810305
61	2"	M10	2.68	25	083810306
77	2 1/2"	M10	3.10	25	083810307
89	3"	M10	3.25	25	083810308
102	3 1/2"	M12	5.20	25	083810309
115	4"	M12	5.70	15	083810310
140	5"	M12	8.85	15	083810312
168	6"	M16	14.90	15	083810315
220	8"	M16	26.00	10	083810320
274	10"	M16	27.50	1	083810374
274	10"	M20	39.50	1	083810375
324	12"	M20	84.50	1	083810386
408	16"	M24	124.00	1	083810508

Robur

Robur

8383C

Etrier fileté carré pour agriculture galvanisé à chaud
Ecrous bridés

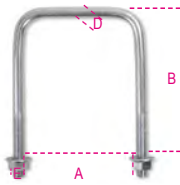

CERTIFICATS DISPONIBLES

- Spécification produit
- Rapport d'essai type 2.2 UNI EN10204

A mm	E mm	B mm	D mm	CHF		
70	M10	110	8,55	2.61	130	083830070
80	M10	120	8,55	3.00	110	083830080
90	M10	130	8,55	3.25	100	083830090
100	M10	155	8,55	3.90	90	083830100
120	M10	175	8,55	4.55	70	083830120

8383P

Plaque pour étriers filetés carrés galvanisé à chaud

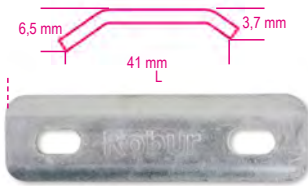

CERTIFICATS DISPONIBLES

- Spécification produit
- Rapport d'essai type 2.2 UNI EN10204

	L mm	CHF		
8383P 150	150	3.25	150	083830214
8383C/70-80/90-100				
8383P 170	170	3.90	120	083830217
8383C/100-120				

8515Z

raidisseurs zingué



D mm	H mm	L mm	CHF		
20	25	93	1.72	50	085150002
24,5	30	100	2.36	50	085150003

8515V

raidisseurs peint



D mm	H mm	L mm	CHF		
20	25	93	2.27	50	085150102
24,5	30	100	2.87	50	085150103

8515CH

Clé pour raidisseurs galvanisée



L mm	OA mm	OB mm	CHF		
90	8	7,5	0.82	20	085150901

8531

Manille type pêche zinguée à chaud

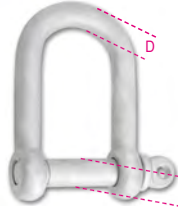

CERTIFICATS DISPONIBLES

- Rapport d'essai type 2.2 UNI EN10204

Ø mm	D mm	WFL kg	CHF		
20	18	1600	23.40	1	085310018
22	20	2500	34.00	1	085310020

8532

Manille type pêche, axe carré peint en noir



CERTIFICATS DISPONIBLES

- Rapport d'essai type 2.2 UNI EN10204

Ø mm	D mm	WFL kg	CHF		
20	20	1600	11.50	1	085320020
22	22	2500	17.60	1	085320022

8535

Crochet type pêche zingué

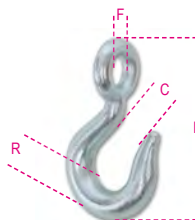

CERTIFICATS DISPONIBLES

- Rapport d'essai type 2.2 UNI EN10204

R mm	C mm	F mm	L mm	CHF		
26	27,5	34	156	26.00	1	085350006
30	36,5	40	185	36.00	1	085350007

8050 D1+D45

Kit cran de sécurité et pièces de rechange pour crochets de levage



	CHF		
8050D1	10.20	1	080500945
8064S-8065SC/800-8055S/1250			
8050D2	11.90	1	080500946
8064S-8065SC/1000			
8062/1500-8055S/1600			
8050D3	12.80	1	080500947
8064S-8065SC/1600-2000			
8055S/2500-3200			
8050D4	21.20	1	080500948
8064S-8065SC/3200-8055S/5400			
8050D5	24.60	1	080500949
8064S-8065SC/5000-8055S/8000			
8050D6	39.00	1	080500950
8064S/7500-8055S/11500			
8050D11	20.20	1	080500955
8062/2000			
8050D12	22.30	1	080500956
8062/3000			
8050D13	40.50	1	080500957
8062/5000			
8050D22	53.50	1	080500966
8064S/10000			
8055S/16000			
8050D23	73.50	1	080500967
8055S/22000			
8050D24	0.93	1	080500969
8051S/250			
8050D25	1.11	1	080500970
8051S/500			
8050D30	29.50	1	080500975
8061F/8000			
8050D32	41.00	1	080500977
8060/8000			
8050D 33	4.10	1	080500978
8052/800			
8050D 34	4.60	1	080500979
8052/1120			
8050D 35	5.65	1	080500980
8052/2000			
8050D 36	6.15	1	080500981
8052/3150			
8050D 37	7.25	1	080500982
8052/4000			
8050D38	2.67	1	080500983
8060R/1120			
8050D53	3.65	1	080500994
8060R/1500			
8050D39	3.65	1	080500984
8060R/2000			
8050D40	6.35	1	080500985
8060R/3150			
8050D41	9.75	1	080500986
8060R/5300			
8050D42	0.93	1	080500987
8063/800			
8050D43	1.33	1	080500988
8063/1120			
8050D44	1.73	1	080500989
8063/2000			
8050D45	2.13	1	080500990
8063/3150			
8050D46	2.77	1	080500991
8061R/1120			
8050D47	2.77	1	080500992
8061R/2000			
8050D48	3.80	1	080500993
8061R/3150			
8050D54	3.80	1	080500995
8061R/5300			



8050D49	7.65	1	080500849
8057R - 8058R - 8063SL /1120			
8050D50	8.30	1	080500850
8057R - 8058R - 8063SL /2000			
8050D51	9.05	1	080500851
8057R - 8058R - 8063SL /3150			
8050D52	20.30	1	080500852
8057R - 8058R - 8063SL /5300			

8058R/PS

Kit embouts et goupilles pour crochets
8058R-8061R



	∅ mm	CHF		
8058R/PS 1,12	6	8.85	1	080580512
8058R/PS 2,0	7-8	10.20	1	080580520
8058R/PS 3,15	10	20.30	1	080580532
8058R/PS 5,3	13	34.50	1	080580553

8060R/PS

Kit embouts et goupilles pour crochets 8060R



	∅ mm	CHF		
8060R/PS 1,12	6	8.85	1	080600511
8060R/PS 1,5	7	10.20	1	080600515
8060R/PS 2,0	8	10.20	1	080600520
8060R/PS 3,15	10	20.30	1	080600532
8060R/PS 5,3	13	34.50	1	080600553

8135/KLA1

Kit de leviers de commande
pour pinces de levage 8135



8135 t	CHF		
0,75	20.00	1	081350605
1,00	24.80	1	081350610
2,00	28.50	1	081350615
3,00	34.50	1	081350620
5,00	53.50	1	081350625

La responsabilité des réparations incombe au réparateur.

8135/KMO

Kit de ressorts
pour pinces de levage 8135



8135 t	CHF		
0,75	8.85	1	081350655
1,00	12.90	1	081350660
2,00	16.90	1	081350665
3,00	21.70	1	081350670
5,00	32.00	1	081350675

La responsabilité des réparations incombe au réparateur.

8143/RKL

Kit de languettes crochet supérieur et inférieur
pour palans manuels à chaîne 8143



8143 WLL t	CHF		
0,5	1.80	1	081430500
1,0	2.08	1	081430501
2,0	3.15	1	081430502
3,0	3.65	1	081430503
5,0	4.30	1	081430504

8143/RPC

Kit de goupilles de blocage de chaîne sur
crochet
pour palans à chaîne 8143



8143 WLL t	CHF		
0,5	2.16	1	081430510
1,0	2.96	1	081430511
2,0	3.20	1	081430512
3,0	5.20	1	081430513
5,0	5.65	1	081430514

8143/RPF

Kit de goupilles de fin de course
pour palans à chaîne 8143



8143 WLL t	CHF		
0,5	0.98	1	081430520
1,0	1.05	1	081430521
2,0	1.47	1	081430522
3,0	1.16	1	081430523
5,0	1.80	1	081430524

8143/RKCI

Kit de corps crochets inférieurs pour palans à
chaîne 8143



8143 WLL t	CHF		
0,5	13.90	1	081430560
1,0	18.20	1	081430561
2,0	34.00	1	081430562
3,0	111.50	1	081430563
5,0	153.50	1	081430564

8146/RK

Jeu de crans de sécurité, embouts, fins de
course
pour palans manuels à LEVIER 8146C-8146



8146C WLL t	CHF		
0,25	6.95	1	081460902

8146/RKL

Kit de languettes crochet supérieur et inférieur
pour palans manuels à levier 8146



8146 WLL t	CHF		
0,75	2.08	1	081460500
1,5	2.39	1	081460501
3,0	3.65	1	081460502
6,0	4.15	1	081460503

8146/RPC

Kit de goupilles de blocage de chaîne sur
crochet
pour palans manuels à levier 8146



8146 WLL t	CHF		
0,75	2.16	1	081460510
1,5	3.20	1	081460511
3,0	3.35	1	081460512
6,0	3.35	1	081460513

8146/RKFC

Kit de goupilles de fin de course
pour palans manuels à levier 8146



8146 WLL t	CHF		
0,75	5.70	1	081460520
1,5	7.30	1	081460521
3,0	7.80	1	081460522
6,0	9.20	1	081460523

 Robur

 Robur

8146/RKCI

Kit de corps crochets inférieurs pour palans manuels à levier 8146



8146 WLL t	CHF		
0,75	15.90	1	081460560
1,5	34.00	1	081460561
3,0	111.50	1	081460562
6,0	211.00	1	081460563

8148/RA

Croix pour treuils manuels 8148



8148 t	CHF		
0,8	25.50	1	081480900
1,6	34.00	1	081480901
3,2	44.00	1	081480902

8148/RKS

Jeu de 3 épingles de sécurité de la surcharge pour treuils manuels 8148



8148 t	CHF		
0,8	4.65	1	081480903
1,6 - 3,2	5.85	1	081480904

8148/RKCM

Jeu de 2 capuchons de branche pour treuils manuels 8148



8148/RKCM	CHF		
	2.13	1	081480905

8148/RKCL

Jeu de 2 capuchons levier pour treuils manuels 8148



8148/RKCL	CHF		
	2.26	1	081480906

8148/RP

Embout de fixation pour treuils manuels 8148



8148 t	CHF		
0,8	19.40	1	081480907
1,6	26.00	1	081480908
3,2	33.00	1	081480909

8148/RKG

Jeu de 2 gaines de protection treuils manuels 8148



8148 t	CHF		
0,8	20.00	1	081480910
1,6	22.80	1	081480911
3,2	24.10	1	081480912

8149

chaînes pour palans

CE

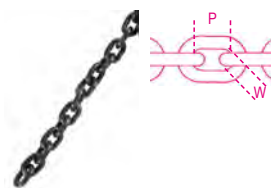

EN 818-7

CARACTÉRISTIQUES TECHNIQUES

- coefficient de sécurité : 4
 - traitement thermique : bonification
 - code lot de fabrication
- #### ANALYSES DE LABORATOIRE
- analyse chimique
 - analyse métallographique
 - essai de traction
- #### CERTIFICATS DISPONIBLES
- Spécification produit
 - Rapport d'essai type 2.2 UNI EN10204
 - Déclaration de Conformité CE

Ø mm	WLL Kg	P mm	W min	CHF/m		
4	500	12	4,8	19.10	1	081490012
5	800	15	6,0	23.60	1	081490015
6	1100	18	7,2	26.50	1	081490018
6,3	1200	19	7,6	29.00	1	081490019
8	2000	24	9,6	39.50	1	081490024
10	3200	30	12	61.50	1	081490030

8149CM

chaînes manuelles pour palans 8143



Ø mm	B mm	t mm	CHF/m		
4,8	8,2	22,2	6.10	1	081490901

* ATTENTION: Le produit est livré dans une longueur de chaîne, sauf indication contraire dans l'ordre!

8149CM/RA

Anneau soudé pour palans manuels à chaîne 8143



L m	Ø mm	B mm	CHF		
3	4,8	8,2	77.50	1	081490903
6	4,8	8,2	117.00	1	081490906

* Anneau fermé soudé. Lire attentivement le manuel de remplacement de la chaîne.



Contrairement à l'acier à usage général (AISI 304), l'acier AISI 316 sélectionné par Beta offre une haute résistance aux intempéries ainsi qu'à la corrosion saline et acide organique. L'acier inoxydable AISI 316 a une teneur élevée en :

- **Chrome** (il forme un film superficiel qui protège le matériau sous-jacent de l'oxydation)
- **Molybdène** (il augmente la résistance à la corrosion des chlorures, par exemple de l'eau de mer et des produits de dégivrage)
- **Nickel** (il permet de maintenir la structure en acier stable dans le temps)

De plus, la faible teneur en carbone rend cet acier plus résistant à la corrosion intergranulaire (un type particulier de corrosion difficilement détectable à la surface de l'accessoire et qui peut déclencher des ruptures brutales dans des environnements corrosifs).

L'acier AISI 316 présente quelques caractéristiques supplémentaires : il est facile à nettoyer, possède un excellent coefficient hygiénique, des propriétés amagnétiques et de bonnes performances mécaniques à basse température.

Il ne fait aucun doute qu'une qualité uniforme et constante est le principal facteur de fiabilité des produits en acier inoxydable de Robur, car elle garantit que les mêmes niveaux de performance sont atteints pour tous les lots de production.

8205

Tendeur à deux œilletons
AISI 316

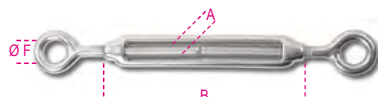

ANALYSES DE LABORATOIRE

- analyse chimique
 - essai de traction
- CERTIFICATS DISPONIBLES**
- Spécification produit
 - Rapport d'essai type 2.2 UNI EN10204

A mm	B mm	ØF mm	WFL kg	CHF	📦	🚚
M4	62	8	75	7.65	10	082050204
M5	72	11	115	9.10	10	082050205
M6	92	12	160	12.10	8	082050206
M8	122	14	300	18.60	8	082050208
M10	150	16	470	28.00	4	082050210
M12	201	18	690	47.50	1	082050212
M14	225	22	940	119.00	1	082050214
M16	244	26	1290	121.50	1	082050216
M20	295	29	2130	175.50	1	082050220
M24	350	33	3000	402.00	1	082050224

Packs spéciaux



A mm	B mm	📦	CHF	🚚	🚚
M4	62	5	42.50	1	082050704
M5	72	5	51.50	1	082050705
M6	92	4	54.50	1	082050706
M8	122	4	83.50	1	082050708
M10	150	2	63.00	1	082050710

8206

Tendeur œilletons et crochet
AISI 316

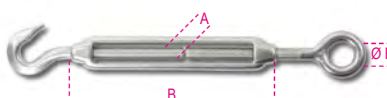

ANALYSES DE LABORATOIRE

- analyse chimique
 - essai de traction
- CERTIFICATS DISPONIBLES**
- Spécification produit
 - Rapport d'essai type 2.2 UNI EN10204

A mm	B mm	ØF mm	WFL kg	CHF	📦	🚚
M5	72	11	25	9.25	10	082060205
M6	92	12	45	12.80	5	082060206
M8	122	14	95	19.50	5	082060208
M10	150	16	140	29.50	1	082060210
M12	201	18	300	49.50	1	082060212
M14	225	22	420	119.50	1	082060214
M16	244	26	570	122.00	1	082060216
M20	295	29	875	178.50	1	082060220

8207

Tendeur à deux crochets
AISI 316

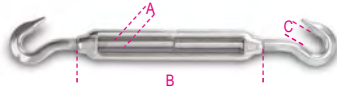

ANALYSES DE LABORATOIRE

- analyse chimique
 - essai de traction
- CERTIFICATS DISPONIBLES**
- Spécification produit
 - Rapport d'essai type 2.2 UNI EN10204

A mm	B mm	C mm	WFL kg	CHF	📦	🚚
M5	72	9	25	9.80	10	082070205
M6	92	9	45	12.90	5	082070206
M8	122	10	95	19.80	5	082070208
M10	150	12	140	30.00	1	082070210
M12	201	14	300	50.00	1	082070212
M14	225	15	420	121.50	1	082070214
M16	244	16	570	126.00	1	082070216
M20	295	19	875	184.50	1	082070220

8209

Tendeur à deux chapes
AISI 316

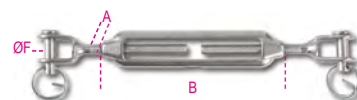

ANALYSES DE LABORATOIRE

- analyse chimique
 - essai de traction
- CERTIFICATS DISPONIBLES**
- Spécification produit
 - Rapport d'essai type 2.2 UNI EN10204

A mm	B mm	ØF mm	WFL kg	CHF	📦	🚚
M5	72	5	115	16.40	5	082090205
M6	92	6	160	19.20	5	082090206
M8	122	8	300	27.50	5	082090208
M10	150	10	470	45.00	1	082090210
M12	201	12	690	73.00	1	082090212
M14	225	14	940	98.50	1	082090214
M16	244	16	1290	149.00	1	082090216
M20	295	20	2130	262.00	1	082090220
M24	350	24	3060	635.00	1	082090224

8210

Ridoir à deux chapes
AISI 316



ANALYSES DE LABORATOIRE

- analyse chimique
 - essai de traction
- CERTIFICATS DISPONIBLES**
- Spécification produit
 - Rapport d'essai type 2.2 UNI EN10204

A mm	B mm	ØF mm	WFL kg	CHF	📦	🚚
M5	81	5	115	20.60	3	082100205
M6	92	6	160	24.80	3	082100206
M8	112	8	300	36.00	1	082100208
M10	121	10	470	56.50	1	082100210
M12	150	12	690	93.50	1	082100212
M14	169	14	940	121.50	1	082100214
M16	190	16	1290	180.00	1	082100216
M20	220	20	2130	312.00	1	082100220

8210FTP

Tendeur à fourche et cosses à sertir cage en tube
acier inoxydable AISI 316

Acier au Nickel, Chrome et Molybdène pour une plus grande résistance à la corrosion.

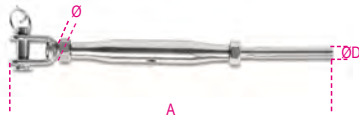

ANALYSES DE LABORATOIRE

- Analyse chimique
 - Essai de traction
- CERTIFICATS DISPONIBLES**
- Spécifications techniques du produit
 - Rapport d'essai type 2.2 UNI EN10204

ø mm	A mm	øD mm	WFL kg	CHF		
M5	159	2,70	150	22.90	2	082100605
M6	179	3,30	250	27.00	2	082100606
M8	216	4,30	350	37.00	1	082100608
M10	241	5,30	550	57.00	1	082100610
M12	300	6,30	1000	83.00	1	082100612
M14	345	7,30	1350	126.00	1	082100614
M16	383	8,30	1625	183.00	1	082100616
M20	484	10,50	2125	311.00	1	082100620

8201T

Cage en tube
AISI 316



ANALYSES DE LABORATOIRE

- analyse chimique
 - essai de traction
- CERTIFICATS DISPONIBLES**
- Spécification produit
 - Rapport d'essai type 2.2 UNI EN10204

ø mm	ø"	WFL kg	L mm	CHF		
M6	1/4	160	95	4.60	5	082010406
M8	5/16	300	105	6.75	5	082010408
M10	3/8	470	125	11.40	3	082010410
M12	1/2	690	150	19.80	3	082010412
M14	9/16	940	165	21.10	1	082010414
M16	5/8	1290	190	36.00	1	082010416
M20	3/4	2130	210	54.00	1	082010420

8210F

mâchoires à tendeurs,
acier inoxydable AISI 316

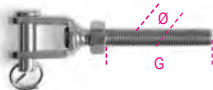

DE LABORATOIRE

- analyse chimique
 - essai de traction
- CERTIFICATS DISPONIBLES**
- Spécifications techniques du produit
 - Rapport d'essai UNI EN10204 type 2.2

ø mm	ø"	G mm	WFL kg	CHF		
M5	3/16	38,5	115	6.80	4	082100305
M6	1/4	49	160	7.65	4	082100306
M8	5/16	56	300	11.10	4	082100308
M10	3/8	61	470	19.00	2	082100310
M12	1/2	81	690	30.00	2	082100312
M14	9/16	93	940	47.00	2	082100314

chape pour tendeur à droite - zinguée

ø mm	ø"	G mm	WFL kg	CHF		
M5	3/16	38,5	115	6.80	4	082100405
M6	1/4	49	160	7.65	4	082100406
M8	5/16	56	300	11.10	4	082100408
M10	3/8	61	470	19.00	2	082100410
M12	1/2	81	690	30.00	2	082100412
M14	9/16	93	940	48.50	2	082100414

8248

Chape mâle
acier inoxydable 316L
filetage à droite



UNI 6058

CERTIFICATS DISPONIBLES

- Spécification produit
- Rapport d'essai type 2.2 UNI EN10204

øxL mm	F mm	CHF		
8X120	6	8.85	1	082480008
10x80	8	12.00	1	082480010
10x130	8	16.00	1	082480012
12x95	10	18.10	1	082480016
12x125	10	21.60	1	082480018

8249

Vis à œil pour chevilles
AISI 316

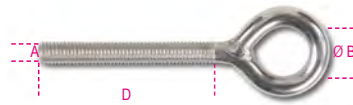

ANALYSES DE LABORATOIRE

- analyse chimique
 - essai de traction
- CERTIFICATS DISPONIBLES**
- Spécification produit
 - Rapport d'essai type 2.2 UNI EN10204

A mm	WFL kg	D mm	CHF		
M5	100	50	3.30	10	082490205
M6	160	55	4.15	10	082490206
M8	300	60	6.70	5	082490208
M10	470	80	12.00	5	082490210
M12	690	120	20.80	2	082490212

8249G

Crochet pour chevilles
AISI 316



ANALYSES DE LABORATOIRE

- analyse chimique
 - essai de traction
- CERTIFICATS DISPONIBLES**
- Spécification produit
 - Rapport d'essai type 2.2 UNI EN10204

A mm	E mm	øF mm	WFL kg	CHF		
M5	39	9	25	1.59	5	082490305
M6	43	10,5	45	1.90	5	082490306
M8	57	14,5	95	3.30	3	082490308

8216

Serre-câble
AISI 316

CE

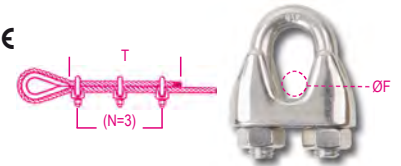

ANALYSES DE LABORATOIRE

- analyse chimique
 - essai de couple de serrage
- CERTIFICATS DISPONIBLES**
- Spécification produit
 - Rapport d'essai type 2.2 UNI EN10204
 - Certificat de Conformité CE

ø F mm	"	T	N	CHF		
2	5/64	80	3	3.85	20	082160202
3	1/8	80	3	3.90	20	082160203
4	5/32	80	3	4.40	20	082160204
5	3/16	110	3	4.95	20	082160205
6	1/4	120	5	5.60	10	082160206
8	5/16	210	5	7.40	10	082160208
10	3/8	240	5	10.30	8	082160210
12-13	1/2	300	5	14.30	5	082160213
16	5/8	335	5	21.10	5	082160216
20	3/4	540	5	26.50	5	082160220
22	7/8	595	7	42.50	3	082160222

Packs spéciaux



ø F mm	"	CHF		
2	5/64	43.50	1	082160702
3	1/8	44.00	1	082160703
4	5/32	49.50	1	082160704
5	3/16	56.00	1	082160705
6	1/4	31.50	1	082160706
8	5/16	41.50	1	082160708
10	3/8	46.50	1	082160710

formats de vente spéciaux pour libre service



ø F mm		CHF		
2	4	16.30	1	082169402
3	4	16.40	1	082169403
4	4	18.40	1	082169404
5	2	11.10	1	082169405
6	2	12.50	1	082169406
8	2	16.30	1	082169408
10	2	22.00	1	082169410



8220

Cosse-cœur
AISI 316

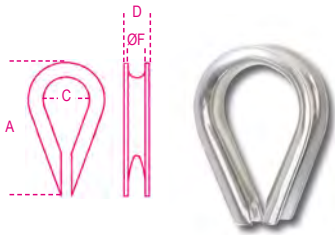

ANALYSES DE LABORATOIRE

- analyse chimique
- CERTIFICATS DISPONIBLES
- Spécification produit
- Rapport d'essai type 2.2 UNI EN10204

ø F mm	D mm	A mm	C mm	CHF		
2	4,5	21	7,5	1.26	15	082200202
3	6	24	10	1.38	15	082200203
4	6,6	28	11	1.59	10	082200204
5	8,5	30	13	1.90	10	082200205
6	10	37	15	2.16	10	082200206
8	12,5	51	23	3.40	5	082200208
10	14,6	56	27	4.15	5	082200210
12	18	68	32	5.70	5	082200212
14	19	69	34	7.40	5	082200214
16	22	83	37	8.30	5	082200216
18	23	81	38	9.80	1	082200218
20	27,8	105	45	11.50	1	082200220
22	29,6	112	45	15.00	1	082200222

8225

Manille droite
AISI 316



ANALYSES DE LABORATOIRE

- analyse chimique
- essai de traction
- CERTIFICATS DISPONIBLES
- Spécification produit
- Rapport d'essai type 2.2 UNI EN10204

ø D mm	A mm	WFL kg	CHF			
4	5/32	8	50	4.05	20	082250204
5	3/16	11	70	4.45	20	082250205
6	1/4	13	100	4.85	10	082250206
8	5/16	17	250	7.90	10	082250208
10	3/8	21	400	11.40	8	082250210
12	1/2	25	600	18.60	3	082250212
16	5/8	32	1000	41.00	1	082250216
19	3/4	38	1600	68.00	1	082250219
22	7/8	43	2000	106.00	1	082250222
25	1	46	2800	155.00	1	082250225

Packs spéciaux



ø D mm	A mm	WFL kg	CHF		
4	5/32	10	45.00	1	082250704
5	3/16	10	50.00	1	082250705
6	1/4	5	27.00	1	082250706
8	5/16	5	44.00	1	082250708
10	3/8	4	51.00	1	082250710

8227

Manille droite longue
AISI 316



ANALYSES DE LABORATOIRE

- analyse chimique
- essai de traction
- CERTIFICATS DISPONIBLES
- Spécification produit
- Rapport d'essai type 2.2 UNI EN10204

ø D mm	A mm	WFL kg	CHF			
4	5/32	8	50	3.40	10	082270204
5	3/16	10	70	3.90	10	082270205
6	1/4	13,5	100	4.95	5	082270206
8	5/16	17	250	8.15	5	082270208
10	3/8	21	400	13.40	2	082270210
12	1/2	25	600	21.20	1	082270212

8228

Manille lyre
AISI 316

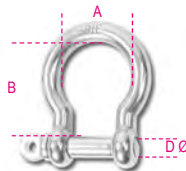

ANALYSES DE LABORATOIRE

- analyse chimique
- essai de traction
- CERTIFICATS DISPONIBLES
- Spécification produit
- Rapport d'essai type 2.2 UNI EN10204

ø D mm	A mm	B mm	WFL kg	CHF		
4	13	20	60	3.10	10	082280204
5	17	23	80	3.55	10	082280205
6	20	27	100	4.05	10	082280206
8	28	36	200	6.45	5	082280208
10	36	44	300	10.30	5	082280210
12	41	53	500	16.50	5	082280212
16	54	74	800	36.00	1	082280216
19	66	86	1100	65.50	1	082280219

8240F

Anneau de levage mâle,
FORGÉ à chaud,
acier inoxydable A4

CE



CARACTÉRISTIQUES TECHNIQUES

- coefficient de sécurité : 6
- code lot de fabrication
- ANALYSES DE LABORATOIRE
- analyse chimique
- analyse métallographique
- essai de traction
- CERTIFICATS DISPONIBLES
- Spécification produit
- Rapport d'essai type 2.2 UNI EN10204
- Certificat de contrôle type 3.1 UNI EN10204
- Déclaration de Conformité CE

ø mm	WLL mm	WLL kg	CHF		
M6	1,0	120	9.25	4	082400406
* M8	1,25	200	10.30	4	082400408
* M10	1,5	400	17.40	4	082400410
* M12	1,75	600	28.00	4	082400412
* M14	2	1000	45.00	2	082400414
* M16	2	1200	45.00	2	082400416
* M20	2,5	2000	73.00	2	082400420
* M24	3	2700	138.00	2	082400424
* M30	3,5	4000	306.00	1	082400430

(*) WLLincrémenté par rapport à la norme DIN sur labase du Fascicule Technique R/FT/8240F (garantipour couplages inox-inox)

8240

Anneau mâle
AISI 316



ANALYSES DE LABORATOIRE

- analyse chimique
- essai de traction
- CERTIFICATS DISPONIBLES
- Spécification produit
- Rapport d'essai type 2.2 UNI EN10204

A mm	B mm	ø C mm	WFL kg	CHF		
M6	41	15	90	2.66	10	082400206
M8	50	20	140	3.95	10	082400208
M10	62	25	230	7.95	5	082400210
M12	74	30	340	13.40	5	082400212

8242F

Anneau de levage femelle
FORGÉ à chaud,
acier inoxydable A4

CE



CARACTÉRISTIQUES TECHNIQUES

- coefficient de sécurité : 6
- code lot de fabrication

ANALYSES DE LABORATOIRE

- analyse chimique
- analyse métallographique
- essai de traction

CERTIFICATS DISPONIBLES

- Spécification produit
- Rapport d'essai type 2.2 UNI EN10204
- Certificat de contrôle type 3.1 UNI EN10204
- Déclaration de Conformité CE

ø mm	WLL mm	WLL kg	CHF		
M6	1,0	120	9.25	4	082420406
* M8	1,25	200	10.30	4	082420408
* M10	1,5	400	17.40	4	082420410
* M12	1,75	600	28.00	4	082420412
* M14	2	1000	45.00	2	082420414
* M16	2	1200	45.00	2	082420416
* M20	2,5	2000	73.00	2	082420420
* M24	3	2700	138.00	2	082420424
* M30	3,5	4000	306.00	1	082420430

8242

Anneau femelle
AISI 316



A mm	B mm	øC mm	WFL kg	CHF		
M6	27	15	90	2.66	10	082420206
M8	36	20	140	3.95	10	082420208
M10	45	25	230	7.95	5	082420210
M12	55	30	340	13.40	5	082420212

8274

Mousqueton
AISI 316

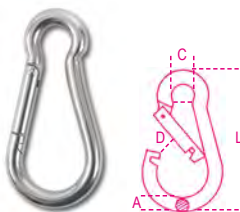

ANALYSES DE LABORATOIRE

- analyse chimique
- essai de traction

CERTIFICATS DISPONIBLES

- Spécification produit
- Rapport d'essai type 2.2 UNI EN10204

ø A x L mm	ø C mm	D mm	WFL kg	CHF		
4,5x40	6,5	6	20	3.65	20	082740204
5x50	7	6,5	30	3.65	20	082740205
6x60	8,5	7,5	40	3.85	10	082740206
7x70	10	9	60	4.60	10	082740207
8x80	12	10	75	6.15	10	082740208
9x90	12,5	10,5	100	8.45	10	082740209
10x100	15	13	120	10.50	8	082740210
11x120	19	18	140	15.00	1	082740211
12x140	22	21	140	20.50	1	082740212
13x160	22	26	200	25.50	1	082740213

Packs spéciaux



ø A x L mm	ø C mm	CHF			
4,5x40	6,5	10	41.00	1	082740704
5x50	7	10	41.00	1	082740705
6x60	8,5	5	21.60	1	082740706
7x70	10	5	26.00	1	082740707
8x80	12	5	34.50	1	082740708
9x90	12,5	5	47.00	1	082740709
10x100	15	4	47.00	1	082740710

8274A

Mousqueton avec anneau AISI 316

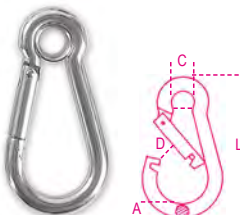

ANALYSES DE LABORATOIRE

- analyse chimique
- essai de traction

CERTIFICATS DISPONIBLES

- Spécification produit
- Rapport d'essai type 2.2 UNI EN10204

ø A x L mm	ø C mm	D mm	WFL kg	CHF		
5x50	6,5	7	30	3.55	10	082740405
6x60	7,5	7,5	40	4.30	5	082740406
8x80	9,5	10	75	7.05	5	082740408

8274G

Mousqueton à vis AISI 316

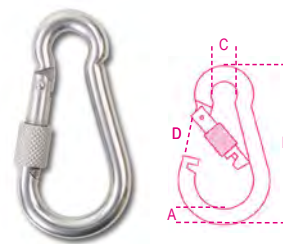

ANALYSES DE LABORATOIRE

- analyse chimique
- essai de traction

CERTIFICATS DISPONIBLES

- Spécification produit
- Rapport d'essai type 2.2 UNI EN10204

ø A x L mm	ø C mm	D mm	WFL kg	CHF		
6x60	8,5	6,5	40	4.70	5	082740306
8x80	12	8,5	75	8.50	5	082740308
10x100	15	12	120	16.30	3	082740310

8276

Mousqueton asymétrique
AISI 316

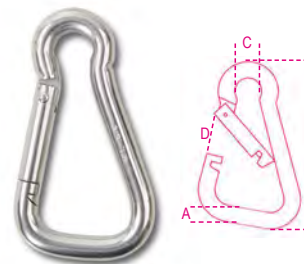

ANALYSES DE LABORATOIRE

- analyse chimique
- essai de traction

CERTIFICATS DISPONIBLES

- Spécification produit
- Rapport d'essai type 2.2 UNI EN10204

ø A x L mm	ø C mm	D mm	WFL kg	CHF		
6x60	8,5	10	40	4.30	5	082760206
8x80	12	14	75	7.40	5	082760208
10x100	15	18	120	13.00	3	082760210

 Robur

 Robur

8276G

Mousqueton asymétrique à vis
AISI 316

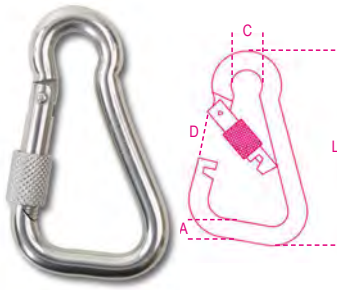

ANALYSES DE LABORATOIRE

- analyse chimique
 - essai de traction
- CERTIFICATS DISPONIBLES**
- Spécification produit
 - Rapport d'essai type 2.2 UNI EN10204

∅ A x L	∅ C	D	WFL	CHF		
mm	mm	mm	kg			
6x60	8,5	9	40	5.45	3	082760306
8x80	12	12,5	75	9.80	3	082760308
10x100	15	16	120	17.90	3	082760310

8278

Mousqueton trapézoïdal
AISI 316

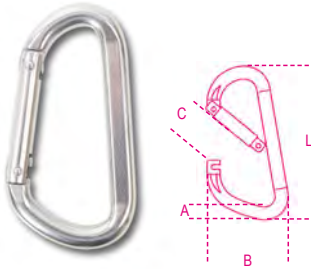

ANALYSES DE LABORATOIRE

- analyse chimique
 - essai de traction
- CERTIFICATS DISPONIBLES**
- Spécification produit
 - Rapport d'essai type 2.2 UNI EN10204

∅ A x L	B	C	WFL	CHF		
mm	mm	mm	kg			
8x80	45	14	75	16.50	3	082780208
10x100	55	16	120	25.50	3	082780210



8280

Maillon rapide de jonction
AISI 316

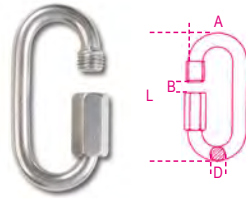

ANALYSES DE LABORATOIRE

- analyse chimique
 - essai de traction
- CERTIFICATS DISPONIBLES**
- Spécification produit
 - Rapport d'essai type 2.2 UNI EN10204

∅ D x L	A	B	WFL	CHF		
mm	mm	mm	kg			
3,5x35	17	5	20	4.20	10	082800203
4x40	19	6	30	4.45	10	082800204
5x50	23	7	50	5.45	5	082800205
6x60	26	8	60	6.45	5	082800206
7x70	30	9	100	7.40	5	082800207
8x80	33	10	140	10.40	2	082800208
10x90	40	12	220	17.00	2	082800210
12x100	47	14	300	25.50	1	082800212

8250

Mousqueton crochet avec linguet
AISI 316



ANALYSES DE LABORATOIRE

- analyse chimique
 - essai de traction
- CERTIFICATS DISPONIBLES**
- Spécification produit
 - Rapport d'essai type 2.2 UNI EN10204

L	A	∅ B	WFL	CHF		
mm	mm	mm	kg			
50	25	8	40	5.25	5	082500205
70	31	12,5	90	8.05	5	082500207
100	47	20	190	13.00	2	082500210

8264

Mousqueton à émerillon
AISI 316

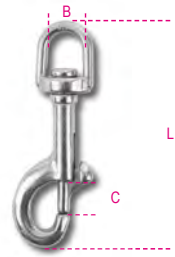

ANALYSES DE LABORATOIRE

- analyse chimique
 - essai de traction
- CERTIFICATS DISPONIBLES**
- Spécification produit
 - Rapport d'essai type 2.2 UNI EN10204

B	L	C	WFL	CHF		
mm	mm	mm	kg			
12	88	12	60	14.10	5	082640212
16	90	12	60	14.60	5	082640216
19	93	12	60	14.80	2	082640219

8267

Mousqueton à émerillon et œillet
AISI 316



ANALYSES DE LABORATOIRE

- analyse chimique
 - essai de traction
- CERTIFICATS DISPONIBLES**
- Spécification produit
 - Rapport d'essai type 2.2 UNI EN10204

A	L	B	WFL	CHF		
mm	mm	mm	kg			
10	87	21	30	12.50	5	082670210
12	118	22	70	21.00	2	082670213

Robur

Robur

8272

Emerillon à deux œillets
AISI 316

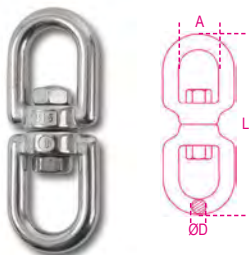

ANALYSES DE LABORATOIRE

- analyse chimique
 - essai de traction
- CERTIFICATS DISPONIBLES**
- Spécification produit
 - Rapport d'essai type 2.2 UNI EN10204

ø D mm	A mm	L mm	WFL kg	CHF		
4	11	50	90	7.05	5	082720204
5	13	60	115	9.25	5	082720205
6	15	66	140	11.40	5	082720206
8	19	90	250	18.40	3	082720208
10	23	112	300	28.00	1	082720210
13	33	148	650	57.00	1	082720213
16	38	184	1000	106.50	1	082720216
19	40	223	1600	190.50	1	082720219

8273

Mousqueton à décrochage rapide
avec œillet pivotant
acier inox AISI 316



ANALYSES DE LABORATOIRE

- analyse chimique • essai de traction
- CERTIFICATS DISPONIBLES**
- Spécification produit
 - Rapport d'essai type 2.2 UNI EN10204

ø C x L mm	B mm	WFL kg	BF kg	CHF		
12x70	12	230	1100	21.60	1	082730012
16x85	14,50	440	2000	30.00	1	082730016
22x120	20	700	3500	47.00	1	082730022

8282S

Crochet en "S" symétrique,
acier inoxydable AISI 316

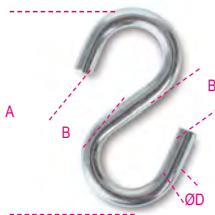

ANALYSES DE LABORATOIRE

- analyse chimique
 - essai de traction
- CERTIFICATS DISPONIBLES**
- Spécification produit
 - Rapport d'essai type 2.2 UNI EN10204

ø D mm	B mm	A mm	WFL kg	CHF		
3	5,5	34	4	0.39	40	082820303
4	7,0	40	5	0.77	30	082820304
5	9,0	46	12	1.26	20	082820305
6	10	54	18	2.09	15	082820306

8284

Mousqueton crochet pélican
acier inox AISI 316



ANALYSES DE LABORATOIRE

- analyse chimique
 - essai de traction
- CERTIFICATS DISPONIBLES**
- Spécification produit
 - Rapport d'essai type 2.2 UNI EN10204

ø C mm	B mm	L mm	WFL kg	CHF		
6	11	73	200	20.80	3	082840006
8	14	98	300	28.00	3	082840008
10	23	143	450	58.00	1	082840010

8285

Embout à sertir à chape
AISI 316

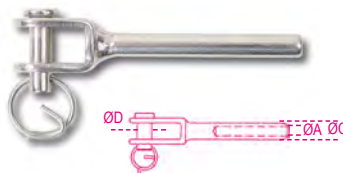

ANALYSES DE LABORATOIRE

- analyse chimique
 - essai de traction
- CERTIFICATS DISPONIBLES**
- Spécification produit
 - Rapport d'essai type 2.2 UNI EN10204

ø A M	ø C mm	ø D mm	WFL kg	CHF		
3	6,3	6	180	4.15	5	082850203
4	7,5	8	200	6.70	3	082850204
5	9	10	330	9.10	2	082850205
6	12,5	12	720	19.00	2	082850206
7	12,5	12	850	20.30	2	082850207
8	15,5	16	1120	27.00	2	082850208
10	18	16	1300	38.50	2	082850210
12	20	19	2400	46.00	2	082850212

8286

Embout à sertir à œil
AISI 316



ANALYSES DE LABORATOIRE

- analyse chimique
 - essai de traction
- CERTIFICATS DISPONIBLES**
- Spécification produit
 - Rapport d'essai type 2.2 UNI EN10204

ø D M	ø A mm	ø C mm	WFL kg	CHF		
3	6,5	6,3	180	4.30	5	082860203
4	8,5	7,5	200	4.95	3	082860204
5	10	9	330	6.70	2	082860205
6	12,5	12,6	720	11.00	2	082860206
7	12,5	14,2	850	11.90	2	082860207
8	14,5	16	1120	19.80	2	082860208
10	16,4	18	1300	34.50	2	082860210
12	19,3	20	2400	49.50	2	082860212

8287

Embout à sertir fileté
AISI 316

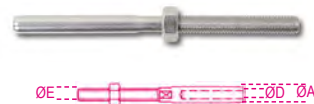

ANALYSES DE LABORATOIRE

- analyse chimique
 - essai de traction
- CERTIFICATS DISPONIBLES**
- Spécification produit
 - Rapport d'essai type 2.2 UNI EN10204

ø D M	ø A mm	E mm	WFL kg	CHF		
3	6,2	M6	180	3.70	5	082870203
4	7,5	M8	200	5.25	3	082870204
5	8,7	M10	330	7.40	2	082870205
6	12,6	M12	720	13.50	2	082870206
7	12,6	M14	850	18.90	2	082870207
8	16	M16	1120	27.00	2	082870208
10	18	M16	1300	30.00	2	082870210
12	20	M20	2400	41.50	2	082870212

8290

Pontet
AISI 316



ANALYSES DE LABORATOIRE

- analyse chimique
 - essai de traction
- CERTIFICATS DISPONIBLES**
- Spécification produit
 - Rapport d'essai type 2.2 UNI EN10204

ø A mm	B mm	ø C mm	L mm	CHF		
5	18	4,3	40	1.34	5	082900205
6	22	5,2	44	1.90	5	082900206
8	23	5,2	51	2.99	5	082900208



8381SX

étrier avec 2 écrous et 2 rondelles, acier inoxydable

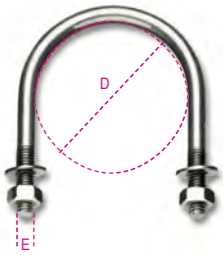

AISI 304

ANALYSES DE LABORATOIRE

- analyse chimique
- CERTIFICATS DISPONIBLES
- Rapport d'essai type 2.2 UNIEN10204

D mm	D gas	E mm	CHF		
11	1/8"	M6	3.30	20	083810401
14	1/4"	M6	3.40	20	083810402
18	3/8"	M6	3.50	20	083810403
22	1/2"	M6	3.55	20	083810404
27	3/4"	M6	3.65	20	083810405
34	1"	M6	3.85	20	083810406
43	1 1/4"	M6	4.40	20	083810407
49	1 1/2"	M8	7.90	10	083810408
61	2"	M8	8.70	10	083810409
77	2 1/2"	M8	10.00	10	083810410
89	3"	M8	11.10	10	083810412
115	4"	M8	14.30	10	083810413
168	6"	M10	27.00	1	083810416
220	8"	M10	33.00	1	083810418

8279

Chaîne type "Genovese" pour connexions statiques, acier inoxydable AISI 304



CARACTÉRISTIQUES TECHNIQUES

- Coefficient de sécurité : 4
- CERTIFICATS DISPONIBLES
- Spécification produit
- Rapport d'essai type 2.2 UNI EN10204

Ø mm	nr	WFL kg	m	CHF		
2	13	20	50	322.00	1	082790020
3	17	55	50	588.00	1	082790030
4	19	100	50	828.00	1	082790040
5	21	250	40	910.00	1	082790050
6	23	310	30	926.00	1	082790060
8	27	400	15	910.00	1	082790080
10	30	1000	10	1,425.00	1	082790400

Attention : produit NON destiné au levage

Robur

8293

Arrimage extérieur, 300 kg, AISI 304
boucle à rochet en polyester haute ténacité

dans sac pouvant être suspendu

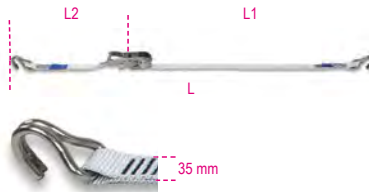

L m	L2 mm	L1 mm	STF daN	CHF		
6	5700	300	100	92.50	1	082930106

LC = 300 kg

8297C

Arrimage extérieur sans-fin, 700 kg, mini boucle à rochet AISI 304 en polyester haute ténacité

dans sac pouvant être suspendu

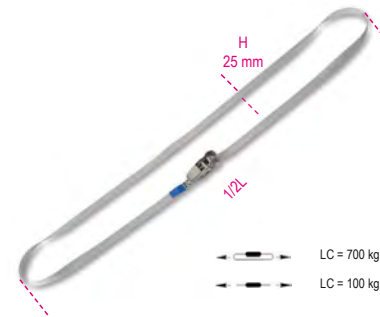

LC = 700 kg

LC = 100 kg

L m	H mm	CHF		
5	25	35.50	1	082970350

8297F

Arrimage extérieur sans-fin, 250 kg, boucle à came AISI 304 en polyester haute ténacité

dans sac pouvant être suspendu

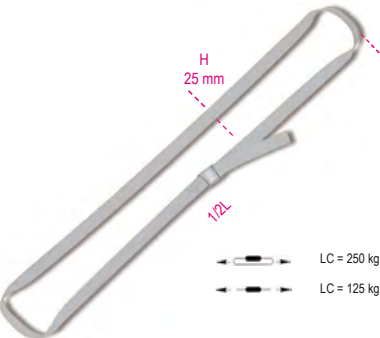

LC = 250 kg

LC = 125 kg

L m	H mm	CHF		
3	25	35.50	1	082970230

LC = 250 kg

ÉLINGUE PLATE

coefficient 7:1

Certificat du Fabricant selon la norme UNI EN 1492

CARACTÉRISTIQUES TECHNIQUES

- coefficient de sécurité : 7
- code lot de fabrication
- ANALYSES DE LABORATOIRE
- essai de traction
- CERTIFICATS DISPONIBLES
- Spécification produit
- Rapport d'essai type 2.2 UNI EN10204
- Certificat du Fabricant UNI EN1492
- Déclaration de Conformité CE

	β=0°+45°	β=45°+60°
1t	0,8t	2t
2t	1,6t	4t
3t	2,4t	6t
4t	3,2t	8t
5t	4t	10t
6t	4,8t	12t
8t	6,4t	16t
10t	8t	20t
12t	9,6t	24t
15t	12t	30t
20t	16t	40t
25t	20t	50t
30t	24t	60t
40t	32t	80t
50t	40t	100t

8150

Élingue plate, 1t, violet, double couche, boutons renforcés, en polyester haute ténacité (PES)

CE



EN 1492-1

L m	H mm	WLL ton	CHF		
0,5	30	1	5.90	1	081500005
1	30	1	7.45	1	081500010
1,5	30	1	9.55	1	081500015
2	30	1	10.50	1	081500020
2,5	30	1	12.10	1	081500025
3	30	1	13.40	1	081500030
3,5	30	1	14.90	1	081500035
4	30	1	17.20	1	081500040
5	30	1	20.30	1	081500050
6	30	1	23.30	1	081500060
8	30	1	30.50	1	081500080

8153

Élingue plate, 2t, vert,
double couche, boutons renforcées,
en polyester haute ténacité (PES)

CE



EN 1492-1

L m	H mm	WLL ton	CHF		
1	60	2	11.70	1	081530010
1,5	60	2	15.80	1	081530015
2	60	2	18.10	1	081530020
2,5	60	2	21.30	1	081530025
3	60	2	24.70	1	081530030
3,5	60	2	28.50	1	081530035
4	60	2	30.50	1	081530040
5	60	2	37.00	1	081530050
6	60	2	44.00	1	081530060
8	60	2	56.00	1	081530080
10	60	2	67.50	1	081530100

8156

Élingue plate, 3t, jaune,
double couche, boutons renforcées,
en polyester haute ténacité (PES)

CE



EN 1492-1

L m	H mm	WLL ton	CHF		
1	90	3	16.60	1	081560010
1,5	90	3	22.00	1	081560015
2	90	3	27.00	1	081560020
2,5	90	3	32.00	1	081560025
3	90	3	38.00	1	081560030
3,5	90	3	42.00	1	081560035
4	90	3	46.50	1	081560040
5	90	3	56.50	1	081560050
6	90	3	65.50	1	081560060
8	90	3	86.00	1	081560080
10	90	3	105.50	1	081560100
12	90	3	132.00	1	081560120

8157

Élingue plate, 4t, gris,
double couche, boutons renforcées,
en polyester haute ténacité (PES)

CE



EN 1492-1

L m	H mm	WLL ton	CHF		
2	120	4	37.00	1	081570020
3	120	4	49.50	1	081570030
4	120	4	64.00	1	081570040
5	120	4	77.50	1	081570050
6	120	4	90.00	1	081570060
8	120	4	116.50	1	081570080
10	120	4	143.00	1	081570100
12	120	4	180.50	1	081570120

8158

Élingue plate, 5t, rouge,
double couche, boutons renforcées,
en polyester haute ténacité (PES)

CE



EN 1492-1

L m	H mm	WLL ton	CHF		
2	150	5	51.50	1	081580020
3	150	5	67.50	1	081580030
4	150	5	86.00	1	081580040
5	150	5	103.50	1	081580050
6	150	5	122.50	1	081580060
8	150	5	158.00	1	081580080
10	150	5	194.00	1	081580100
12	150	5	244.00	1	081580120

8159

Élingue plate, 6t, marron,
double couche, boutons renforcées,
en polyester haute ténacité (PES)

CE



EN 1492-1

L m	H mm	WLL ton	CHF		
2	180	6	64.00	1	081590020
3	180	6	94.00	1	081590030
4	180	6	121.00	1	081590040
5	180	6	145.50	1	081590050
6	180	6	170.50	1	081590060
8	180	6	222.50	1	081590080
10	180	6	275.00	1	081590100

8160

Élingue plate, 8t, bleu,
double couche, boutons renforcées,
en polyester haute ténacité (PES)

CE



EN 1492-1

L m	H mm	WLL ton	CHF		
3	240	8	129.50	1	081600030
4	240	8	165.00	1	081600040
5	240	8	196.00	1	081600050
6	240	8	232.50	1	081600060
8	240	8	299.00	1	081600080
10	240	8	372.00	1	081600100

8161

Élingues de levage orange,
Élingue plate 10t double couches,
Élingue plate 20t quadri couches,
Boucles renforcés

CE



EN 1492-1

L m	H mm	WLL ton	CHF		
3	300	10	178.00	1	081610030
4	300	10	262.00	1	081610040
5	300	10	315.00	1	081610050
6	300	10	366.00	1	081610060
8	300	10	484.00	1	081610080
10	300	10	589.00	1	081610100
12	300	10	708.00	1	081610120
3	300	20	583.00	1	081612030
4	300	20	732.00	1	081612040
5	300	20	882.00	1	081612050
6	300	20	1,030.00	1	081612060
8	300	20	1,330.00	1	081612080
10	300	20	1,625.00	1	081612100
12	300	20	1,930.00	1	081612120

8170

Élingue ronde, 1t, violet,
en polyester haute ténacité (PES)

CE



EN 1492-2

L m	WLL ton	H mm	CHF		
0,5	1	45	6.70	1	081700010
1	1	45	8.75	1	081700020
1,5	1	45	12.30	1	081700030
2	1	45	16.10	1	081700040
2,5	1	45	19.80	1	081700050
3	1	45	23.30	1	081700060
4	1	45	31.00	1	081700080
5	1	45	38.50	1	081700100

8173

Élingue ronde, 2t, vert,
en polyester haute ténacité (PES)

CE



EN 1492-2

L m	H mm	WLL ton	CHF		
0,5	50	2	8.75	1	081730010
1	50	2	13.40	1	081730020
1,5	50	2	19.50	1	081730030
2	50	2	25.50	1	081730040
2,5	50	2	31.50	1	081730050
3	50	2	37.00	1	081730060
4	50	2	50.00	1	081730080
5	50	2	62.50	1	081730100
6	50	2	75.00	1	081730120
8	50	2	98.00	1	081730160

8176

Élingue ronde, 3t, jaune,
en polyester haute ténacité (PES)

CE



EN 1492-2

L m	H mm	WLL ton	CHF		
0,5	60	3	9.70	1	081760010
1	60	3	17.60	1	081760020
1,5	60	3	25.50	1	081760030
2	60	3	33.00	1	081760040
2,5	60	3	41.00	1	081760050
3	60	3	49.50	1	081760060
4	60	3	65.50	1	081760080
5	60	3	82.50	1	081760100
6	60	3	99.00	1	081760120
8	60	3	131.00	1	081760160

8177

Élingue ronde, 4t, gris,
en polyester haute ténacité (PES)

CE



EN 1492-2

L m	H mm	WLL ton	CHF		
0,5	65	4	19.40	1	081770010
1	65	4	20.80	1	081770020
1,5	65	4	31.00	1	081770030
2	65	4	40.50	1	081770040
2,5	65	4	51.00	1	081770050
3	65	4	60.50	1	081770060
4	65	4	79.50	1	081770080
5	65	4	99.00	1	081770100
6	65	4	118.50	1	081770120
8	65	4	158.00	1	081770160

8178

Élingue ronde, 5t, rouge,
en polyester haute ténacité (PES)

CE

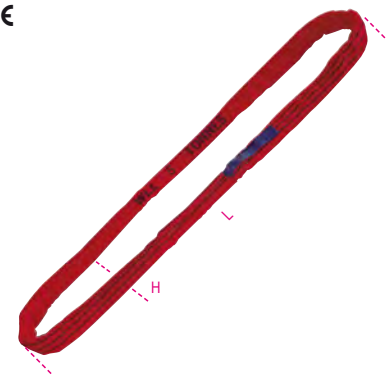

EN 1492-2

L m	H mm	WLL ton	CHF		
0,5	70	5	26.00	1	081780010
1	70	5	30.50	1	081780020
1,5	70	5	38.50	1	081780030
2	70	5	51.00	1	081780040
2,5	70	5	62.00	1	081780050
3	70	5	73.50	1	081780060
4	70	5	98.00	1	081780080
5	70	5	122.50	1	081780100
6	70	5	146.50	1	081780120
8	70	5	196.00	1	081780160

8179M

Élingue ronde, 6t, marron,
en polyester haute ténacité (PES)

CE



EN 1492-2

L m	H mm	WLL ton	CHF		
1	80	6	33.00	1	081790020
1,5	80	6	47.50	1	081790030
2	80	6	62.50	1	081790040
2,5	80	6	77.50	1	081790050
3	80	6	90.50	1	081790060
4	80	6	121.50	1	081790080
5	80	6	152.50	1	081790100
6	80	6	181.00	1	081790120
8	80	6	241.00	1	081790160

8179B

Élingue ronde, 8 t, bleu,
en polyester haute ténacité (PES)

CE

EN 1492-2

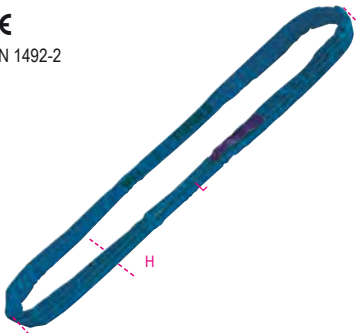

L m	H mm	WLL ton	CHF		
1	85	8	41.50	1	081790220
1,5	85	8	62.50	1	081790230
2	85	8	83.50	1	081790240
2,5	85	8	103.50	1	081790250
3	85	8	120.00	1	081790260
4	85	8	160.00	1	081790280
5	85	8	206.00	1	081790300
6	85	8	240.50	1	081790320
8	85	8	320.00	1	081790360

8179A

Élingue ronde, 10t+50t, orange,
en polyester haute ténacité (PES)

CE

EN 1492-2

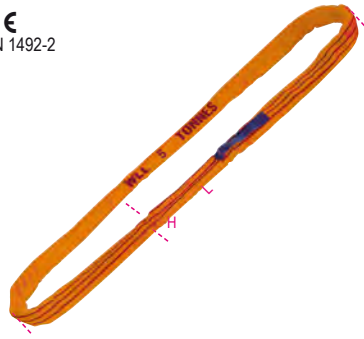

L m	H mm	WLL ton	CHF		
1	95	10	62.50	1	081790502
1,5	95	10	86.00	1	081790503
2	95	10	122.00	1	081790504
2,5	95	10	142.50	1	081790505
3	95	10	188.50	1	081790506
4	95	10	245.50	1	081790508
5	95	10	275.00	1	081790510
6	95	10	365.00	1	081790512
8	95	10	446.00	1	081790516
10	95	10	613.00	1	081790520
12	95	10	651.00	1	081790524
2	100	12	189.50	1	081791204
2,5	100	12	224.50	1	081791205
3	100	12	259.00	1	081791206
3,5	100	12	292.00	1	081791207
4	100	12	327.00	1	081791208
4,5	100	12	331.00	1	081791209
5	100	12	397.00	1	081791210
5,5	100	12	432.00	1	081791211
6	100	12	465.00	1	081791212
6,5	100	12	500.00	1	081791213
7	100	12	534.00	1	081791214
7,5	100	12	568.00	1	081791215
8	100	12	601.00	1	081791216
8,5	100	12	637.00	1	081791217
9	100	12	672.00	1	081791218
9,5	100	12	707.00	1	081791219
10	100	12	740.00	1	081791220
2	110	15	235.00	1	081791504
2,5	110	15	275.00	1	081791505
3	110	15	314.00	1	081791506
3,5	110	15	355.00	1	081791507
4	110	15	394.00	1	081791508
4,5	110	15	433.00	1	081791509
5	110	15	471.00	1	081791510
5,5	110	15	513.00	1	081791511
6	110	15	552.00	1	081791512
6,5	110	15	591.00	1	081791513
7	110	15	631.00	1	081791514
7,5	110	15	670.00	1	081791515
8	110	15	711.00	1	081791516
8,5	110	15	750.00	1	081791517
9	110	15	790.00	1	081791518
9,5	110	15	838.00	1	081791519
10	110	15	868.00	1	081791520
2	130	20	277.00	1	081792004
2,5	130	20	325.00	1	081792005
3	130	20	373.00	1	081792006
3,5	130	20	420.00	1	081792007
4	130	20	470.00	1	081792008
4,5	130	20	517.00	1	081792009
5	130	20	565.00	1	081792010
5,5	130	20	613.00	1	081792011
6	130	20	661.00	1	081792012
6,5	130	20	708.00	1	081792013
7	130	20	755.00	1	081792014
7,5	130	20	804.00	1	081792015
8	130	20	852.00	1	081792016
8,5	130	20	901.00	1	081792017
9	130	20	949.00	1	081792018
9,5	130	20	997.00	1	081792019
10	130	20	1,045.00	1	081792020

2	135	25	306.00	1	081792504
2,5	135	25	366.00	1	081792505
3	135	25	427.00	1	081792506
3,5	135	25	485.00	1	081792507
4	135	25	547.00	1	081792508
4,5	135	25	606.00	1	081792509
5	135	25	667.00	1	081792510
5,5	135	25	727.00	1	081792511
6	135	25	787.00	1	081792512
6,5	135	25	848.00	1	081792513
7	135	25	909.00	1	081792514
7,5	135	25	967.00	1	081792515
8	135	25	1,028.00	1	081792516
8,5	135	25	1,089.00	1	081792517
9	135	25	1,148.00	1	081792518
9,5	135	25	1,205.00	1	081792519
10	135	25	1,265.00	1	081792520
2	160	30	360.00	1	081793004
2,5	160	30	433.00	1	081793005
3	160	30	506.00	1	081793006
3,5	160	30	579.00	1	081793007
4	160	30	653.00	1	081793008
4,5	160	30	727.00	1	081793009
5	160	30	800.00	1	081793010
5,5	160	30	873.00	1	081793011
6	160	30	946.00	1	081793012
6,5	160	30	1,019.00	1	081793013
7	160	30	1,091.00	1	081793014
7,5	160	30	1,166.00	1	081793015
8	160	30	1,240.00	1	081793016
8,5	160	30	1,310.00	1	081793017
9	160	30	1,380.00	1	081793018
9,5	160	30	1,460.00	1	081793019
10	160	30	1,530.00	1	081793020
2	165	40	500.00	1	081794004
2,5	165	40	558.00	1	081794005
3	165	40	649.00	1	081794006
3,5	165	40	742.00	1	081794007
4	165	40	833.00	1	081794008
4,5	165	40	924.00	1	081794009
5	165	40	1,017.00	1	081794010
5,5	165	40	1,109.00	1	081794011
6	165	40	1,199.00	1	081794012
6,5	165	40	1,290.00	1	081794013
7	165	40	1,380.00	1	081794014
7,5	165	40	1,475.00	1	081794015
8	165	40	1,560.00	1	081794016
8,5	165	40	1,660.00	1	081794017
9	165	40	1,755.00	1	081794018
9,5	165	40	1,840.00	1	081794019
10	165	40	1,935.00	1	081794020
3	180	50	753.00	1	081795006
3,5	180	50	859.00	1	081795007
4	180	50	965.00	1	081795008
4,5	180	50	1,068.00	1	081795009
5	180	50	1,172.00	1	081795010
5,5	180	50	1,275.00	1	081795011
6	180	50	1,380.00	1	081795012
6,5	180	50	1,490.00	1	081795013
7	180	50	1,585.00	1	081795014
7,5	180	50	1,690.00	1	081795015
8	180	50	1,800.00	1	081795016
8,5	180	50	1,895.00	1	081795017
9	180	50	1,995.00	1	081795018
9,5	180	50	2,115.00	1	081795019
10	180	50	2,215.00	1	081795020

 Robur

 Robur

8166

Gaine anti-abrasion pour élingues de levage, en polyester haute ténacité (PES) avec substrat élastomère



H mm	ø mm	L m	CHF		
70	45	3	27.00	1	081660073
80	52	3	31.50	1	081660083
110	70	3	38.50	1	081660103
155	100	3	80.50	1	081660153
170	110	3	88.50	1	081660170
235	150	4	242.00	1	081660235

H mm			
70	8150	8170-8173	081660073
80	8153	8176	081660083
110	8153-8156	8177-8178	081660103
155	8157	8178-8179A 8179B-8179M	081660153
170	8158	-	081660170
235	8159	-	081660235

8090F

Maillon d'assemblage pour élingues polyester, acier allié haute résistance, traitement thermique d'amélioration

CE

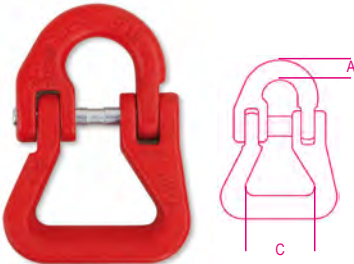

EN 1677-1

CARACTÉRISTIQUES TECHNIQUES

- coefficient de sécurité : 4
- traitement thermique : bonification
- code lot de fabrication
- ANALYSES DE LABORATOIRE
- analyse chimique, analyse métallographique
- test charge d'essai (WLL x 2,5)
- essai de traction
- essai de fatigue (min. 20000 cycles)

CERTIFICATS DISPONIBLES

- Spécification produit
- Rapport d'essai type 2.2 UNI EN10204
- Certificat de contrôle type 3.1 UNI EN10204
- Déclaration de Conformité CE

WLL kg	Ø mm	A mm	C mm	CHF		
2000	7-8	10,5	40	33.00	1	080900220
3150	10	12	50	41.50	1	080900232
5300	13	17	60	63.00	1	080900253
8000	16	21	75	97.50	1	080900280

TENDEUR À CLIQUET coefficient 2:1

selon norme UNI EN 12195
CARACTÉRISTIQUES TECHNIQUES

- coefficient de sécurité : 2
- code d'identification

ANALYSES DE LABORATOIRE

- essai pré-tension cliquet
- essai de déformation parties métalliques
- essai de traction système complet

CERTIFICATS DISPONIBLES

- Spécification produit
- Rapport d'essai type 2.2 UNI EN10204

8180

Arrimage extérieur, 750kg
boucle à rochet
en polyester haute ténacité (PES)

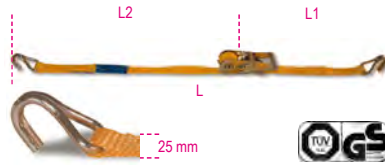

EN 12195-2

L m	L2 mm	L1 mm	STF daN	CHF		
4	3750	250	200	15.80	1	081800004
6	5750	250	200	18.20	1	081800006
8	7750	250	200	20.50	1	081800008

LC = 750 kg

8181

Arrimage extérieur, 1000kg
boucle à rochet
en polyester haute ténacité (PES)

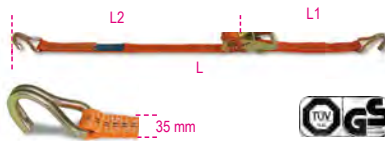

EN 12195-2

L m	L2 mm	L1 mm	STF daN	CHF		
4	3600	400	180	19.40	1	081810004
6	5600	400	180	22.10	1	081810006
8	7600	400	180	24.20	1	081810008

LC = 1000 kg

81816/S4

Kit 4 sangles d'arrimage extérieur, 1000 kg,
avec sac à dos en polyester imperméable

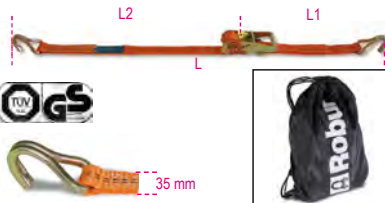

EN 12195-2

L m	L1 mm	L2 mm	STF daN	CHF		
6	400	5600	180	97.50	1	081810906

8181S

Arrimage extérieur, 1000kg,
à deux crochets, boucle à rochete
en polyester haute ténacité (PES)



EN 12195-2

L m	L2 mm	L1 mm	STF daN	CHF		
6	5600	400	180	21.50	1	081810206

LC = 1000 kg

8182E

Arrimage pour intérieurs fourgons et camions,
1000 kg,
boucle à rochet en polyester haute ténacité
(PES)



EN 12195-2

L m	L2 mm	L1 mm	STF daN	CHF		
4	3500	500	220	22.10	1	081820440

LC = 1000 kg

	L2 mm	L1 mm	CHF		
8182EL 2500	2500		6.80	1	081820942
8182EC 1500	1500		14.60	1	081820945

8182T

Arrimage extérieur, 1500kg,
à deux crochets, boucle à rochet
en polyester haute ténacité (PES)

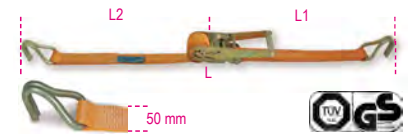

EN 12195-2

L m	L2 mm	L1 mm	STF daN	CHF		
8,5	8100	400	300	34.00	1	081821085
10,5	10100	400	300	37.00	1	081821105

LC = 1500 kg

8182TS

Arrimage extérieur, 1500kg,
boucle à rochet
en polyester haute ténacité (PES)

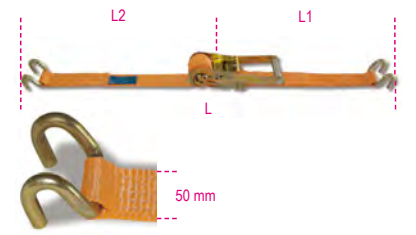

EN 12195-2

L m	L2 mm	L1 mm	STF daN	CHF		
8,5	8100	400	300	35.50	1	081821285
10,5	10100	400	300	39.50	1	081821305

LC = 1500 kg

8182

Arrimage extérieur, 2000kg
boucle à rochet
en polyester haute ténacité (PES)

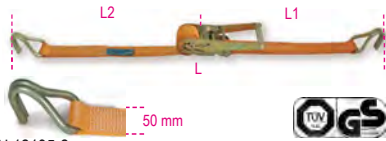

EN 12195-2

L m	L2 mm	L1 mm	STF daN	CHF		
4,5	4100	400	300	30.50	1	081820045
6,5	6100	400	300	36.00	1	081820065
8,5	8100	400	300	39.00	1	081820085
10,5	10100	400	300	44.50	1	081820105
14,5	14100	400	300	50.00	1	081820145
16,5	16100	400	300	57.50	1	081820165

LC = 2000 kg

	L2 mm	L1 mm	CHF		
8182LP 8100	8100		21.50	1	081820902
8182SP 400		400	22.10	1	081820905

8182 8,5/S2

Kit 2 sangles d'arrimage extérieur, 2000 kg,
avec sac à dos en polyester imperméable



EN 12195-2

L m	L1 mm	L2 mm	STF daN	CHF		
8,5	400	8100	300	87.50	1	081821985

8182S

Arrimage extérieur, 2000kg
à deux crochets, boucle à rochet
en polyester haute ténacité (PES)

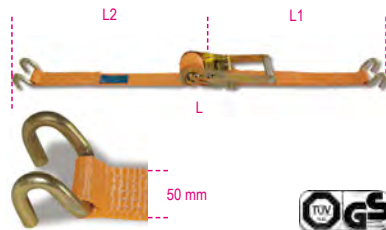

EN 12195-2

L m	L1 mm	L2 mm	STF daN	CHF		
6,5	400	6100	300	35.50	1	081820265
8,5	400	8100	300	40.50	1	081820285
10,5	400	10100	300	44.50	1	081820305

LC = 2000 kg

	L2 mm	L1 mm	CHF		
8182SLP 8100	8100	-	21.00	1	081820912
8182SSP 400		400	21.50	1	081820915

8182GD

Arrimage extérieur, 2000 kg,
à crochets delta, boucle à rochet en polyester
haute ténacité (PES)



EN 12195-2

L m	L2 mm	L1 mm	STF daN	CHF		
8,5	8100	400	300	46.50	1	081820485

LC = 2000 kg

8182A

Arrimage extérieur, 2 boutonnières, 2000 kg,
ruban en polyester haute ténacité (PES)

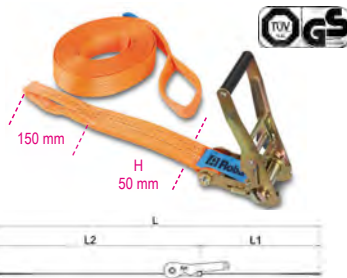

EN 12195-2

L m	L2 mm	L1 mm	STF daN	CHF		
8,5	8100	400	300	40.50	1	081820585

LC = 2000 kg

8182H

Arrimage extérieur, 2500kg,
boucle à rochet
en polyester haute ténacité (PES)

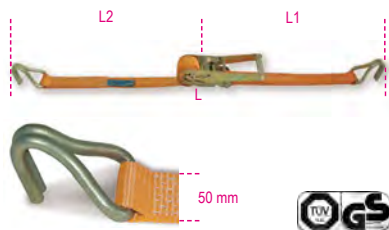

EN 12195-2

L m	L2 mm	L1 mm	STF daN	CHF		
6,5	6100	400	300	39.50	1	081820406
8,5	8100	400	300	42.50	1	081820408
10,5	10100	400	300	47.00	1	081820410
14,5	14100	400	300	59.50	1	081820414

LC = 2500 kg

8182H/2

Arrimage extérieur, 2500 kg,
à deux crochets, boucle à rochet en polyester
haute ténacité (PES)

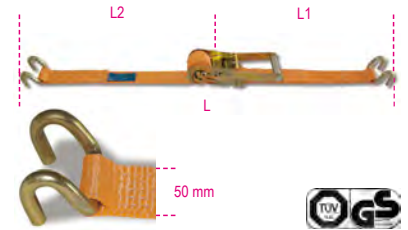

EN 12195-2

L m	L1 mm	L2 mm	STF daN	CHF		
8,5	8100	400	300	45.00	1	081820385

LC = 2500 kg

8184

Arrimage extérieur à cliquet inversé à levier
long, 2500 kg,
boucle à rochet en polyester haute ténacité
(PES)



EN12195-2

L m	L2 mm	L1 mm	STF daN	CHF		
6,5	6100	400	500	44.00	1	081840065
8,5	8100	400	500	46.00	1	081840085
10,5	10100	400	500	49.50	1	081840105

LC = 2500 kg

8183

Arrimage extérieur, 5000 kg,
boucle à rochet
en polyester haute ténacité (PES)



EN 12195-2

L m	L2 mm	L1 mm	STF daN	CHF		
8,5	8000	500	500	124.50	1	081830085
12,5	12000	500	500	148.00	1	081830125

LC = 5000 kg

 **Robur**

8190

Tendeur de chaîne d'arrimage à cliquet
avec deux crochets
Grade 8



EN12195/3

Ø mm	LC daN	Ø mm	LC daN	CHF		
10	6300	8	4000	91.00	1	081900010
13	10000	-	-	142.50	1	081900013

* ATTENTION : le produit peut être utilisé avec chaîne 8mm et opportune réduction de la charge (LC 4000daN).

8190B

Chaîne d'arrimage



EN12195/3

Ø mm	LC daN	L m	L1 m	CHF		
8	4000	3,5	3,30	225.00	1	081901308
10	6300	3,5	3,28	342.00	1	081901310
13	10000	3,5	3,23	500.00	1	081901313

Robur

8185

Arrimage extérieur sans-fin, 1500kg
boucle à rochet
en polyester haute ténacité (PES)



EN 12195-2

L m	STF daN	CHF		
5	200	13.00	1	081850005
8	200	15.80	1	081850008

8186

Arrimage extérieur sans-fin, 2000kg
boucle à rochet
en polyester haute ténacité (PES)



EN 12195-2

L m	STF daN	CHF		
5	180	15.80	1	081860005
8	180	20.10	1	081860008

8187

Arrimage extérieur sans-fin, 4000kg
boucle à rochet
en polyester haute ténacité (PES)



EN 12195-2

L m	STF daN	CHF		
5	350	29.00	1	081870005
8	350	34.00	1	081870008

8188C

Arrimage extérieur sans-fin, 750kg
boucle à rochet
en polyester haute ténacité (PES)



EN 12195-2

L m	STF daN	CHF		
1,5	72	5.20	3	081880315
2,5	72	6.20	3	081880325
5	72	7.70	3	081880350

8188CG/25

Arrimage extérieur, 2 crochets et boutonnières,
400 kg, boucle à rochet
ruban en polyester haute ténacité (PES)



EN 12195-2

L m	L1 mm	L2 mm	STF daN	CHF		
3	480	170	120	11.60	1	081880430
5	480	170	120	12.50	1	081880450

Robur

8188CU/25

Arrimage extérieur avec crochets, 400 kg, boucle à rochet en polypropylène haute ténacité (PES)



EN 12195-2

L m	L1 mm	L2 mm	CHF	1	081880750
5	300	4700	11.90		

8188F

Arrimage extérieur sans-fin, 200kg boucle à came en polypropylène haute ténacité (PP)

- 1,5 m
- 2,0 m
- 2,5 m
- 3,0 m
- 5,0 m

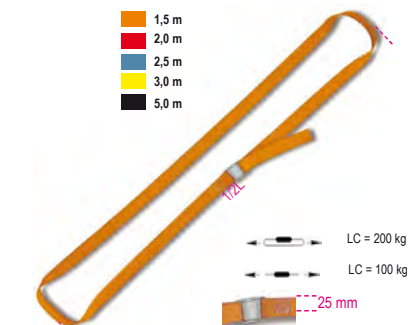

EN 12195-2

L m	CHF	10	081880215
1,5	2.98		
2,0	3.20		
2,5	3.55		
3,0	3.80		
5,0	4.85	6	081880250

8188F35

Arrimage extérieur sans-fin, 500 kg, boucle à came en polypropylène haute ténacité (PP)



EN 12195-2

L m	CHF	1	081880295
5	10.80		

8188FG2

Arrimage extérieur, 2 crochets et boutonnières, 250 kg, boucle à came ruban en polypropylène haute ténacité (PP)



EN 12195-2

L m	L1 mm	L2 mm	CHF	1	081881530
3	450	110	15.40		

8188/K8

Kit sangles d'arrimage extérieur sans fin avec 8 accessoires



8188/K8	CHF	1	081880801
	45.00		

8488K	0,65m - 7kg
8488K	0,80m - 7kg
8188CL	4m - 500kg
8188FP	2,5m - 250kg

8189

Boucle à rochet en polyester (PES) pour arrimages extérieures



H mm	L m	LC kg	CHF	1	081890902
25	100	750	104.50		
35	100	1000	132.50		
50	100	2000	212.50		

8189A

Tapis antiglisse pour fixer la charge



L m	H mm	S mm	μ	CHF	1	081890525
5	250	8	0,6	73.00		

8189PA

2 protections angulaires pour boucles en polyester

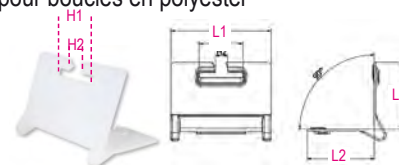

L1xL2 mm	H1 mm	H2 mm	CHF	1	081890090
135x90	60	18	4.60		

Robur

Article	Rapport d'Essai 2.2 (UNI EN 10204)	Certificat de Contrôle 3.1 (UNI EN 10204)	Certificat du Fabricant	Déclaration CE de Conformité
8001Z	✓	✓		✓
8001TZ	✓	✓		✓
8002ZD	✓			
8003ZD	✓			
8004ND	✓			
8005Z	✓			✓
8005TZ	✓			✓
8006Z	✓			✓
8007Z	✓			✓
8008N	✓			✓
8008TZN	✓			✓
8009FD	✓			
8009Z	✓			✓
8009TZ	✓			✓
8010Z	✓			✓
8010TZ	✓			✓
8011Z	✓			✓
8011TZ	✓			✓
8015	✓		✓	✓
8016	✓			✓
8016DA	✓			✓
8016FR	✓			
8016U2	✓		✓	✓
8016UGK	✓		✓	✓
8018E	✓			
8018T	✓			
8020A	✓			
8021A	✓			
8025	✓	✓		✓
8026A	✓	✓		✓
8026R	✓	✓		✓
8028	✓	✓		✓
8029R	✓	✓		✓
8031R	✓	✓		✓
8032	✓	✓		✓
8040EN	✓	✓		✓
8040EZ	✓	✓		✓
8042EN	✓	✓		✓
8042EZ	✓	✓		✓
8041	✓	✓		✓
8043	✓	✓		✓
8044	✓	✓		✓
8048	✓			
8049	✓	✓		✓
8049A	✓	✓		✓
8049V	✓	✓		✓
8051S	✓	✓		✓
8052	✓	✓		✓
8057R	✓	✓		✓
8058R	✓	✓		✓
8060R	✓	✓		✓
8061R	✓	✓		✓
8062	✓	✓		✓
8063	✓	✓		✓
8063SL	✓	✓		✓
8064S	✓	✓		✓
8065SC	✓	✓		✓
8068S	✓	✓		✓
8074	✓			
8074A	✓			
8074G	✓			
8080	✓			
8080FM	✓			
8085R	✓	✓		✓
8086	✓	✓		✓

Article	Rapport d'Essai 2.2 (UNI EN 10204)	Certificat de Contrôle 3.1 (UNI EN 10204)	Certificat du Fabricant	Déclaration CE de Conformité
8090	✓	✓		✓
8090F	✓	✓		✓
8090R	✓	✓		✓
8091			✓	✓
8091SL			✓	✓
8092			✓	✓
8092SL			✓	✓
8094			✓	✓
8094SL			✓	✓
8096			✓	✓
8096SL			✓	✓
8097			✓	✓
8097SL			✓	✓
8098			✓	✓
8098SL			✓	✓
8100	✓	✓		✓
8105	✓	✓		✓
8109	✓	✓		✓
8110	✓			
8114	✓			
8116	✓			
8120 - 8120D	✓			
8120B	✓			
8121MZC	✓			
8134	✓		✓	✓
8135	✓		✓	✓
8143	✓		✓	✓
8146	✓		✓	✓
8146C	✓		✓	✓
8147C-S-P	✓		✓	✓
8148	✓		✓	✓
8149	✓		✓	✓
8150	✓		✓	✓
8153	✓		✓	✓
8156	✓		✓	✓
8157	✓		✓	✓
8158	✓		✓	✓
8159	✓		✓	✓
8160	✓		✓	✓
8161	✓		✓	✓
8166	✓			
8170	✓		✓	✓
8173	✓		✓	✓
8176	✓		✓	✓
8177	✓		✓	✓
8178	✓		✓	✓
8179M-B-A	✓		✓	✓
8180	✓			
8181	✓			
8181S	✓			
8182	✓			
8182A-GD	✓			
8182E	✓			
8182H-H2	✓			
8182M	✓			
8182S	✓			
8182T	✓			
8182T-TS	✓			
8182TS	✓			
8185	✓			
8186	✓			
8187	✓			
8188C	✓			
8188CG/25	✓			
8188CU	✓			

Article	Rapport d'Essai 2.2 (UNI EN 10204)	Certificat de Contrôle 3.1 (UNI EN 10204)	Certificat du Fabricant	Déclaration CE de Conformité
8188F	✓			
8188VF/35	✓			
8188FG2	✓			
8190	✓	✓		
8190B	✓		✓	
8302Z	✓			
8303Z	✓			
8317DZ	✓			
8317SZ	✓			
8381SL	✓			
8381SP	✓			
8383C	✓			
8383P	✓			
8515V	✓			
8515Z	✓			
8531	✓			
8532	✓			
8535	✓			
8201T	✓			
8205	✓			
8206	✓			
8207	✓			
8209	✓			
8210	✓			
8210F	✓			
8210FTP	✓			
8216	✓			✓
8220	✓			
8225	✓			
8227	✓			
8228	✓			
8240	✓			
8240F	✓	✓		✓
8242	✓			
8242F	✓	✓		✓
8248	✓			
8249	✓			
8249G	✓			
8250	✓			
8264	✓			
8267	✓			
8272	✓			
8273	✓			
8274	✓			
8274A	✓			
8274G	✓			
8276	✓			
8276G	✓			
8278	✓			
8280	✓			
8282	✓			
8282S	✓			
8284	✓			
8285	✓			
8286	✓			
8287	✓			
8290	✓			
8293	✓			
8297C	✓			
8297F	✓			
8381SX	✓			
8702...	✓	✓		
8709...	✓	✓		



Beta
Collection



Une ligne de produits exclusifs conçue et réalisée afin d'exprimer l'esprit Beta qui compte aujourd'hui plus de 200 créations originales de très haute qualité: équipements sportifs, habillement technique et une multitude d'objets personnalisés. Idéal pour lancer des initiatives promotionnelles et indispensable dans les moments de loisirs.

9500TL

Softshell en tissu polyester 100 %, 320 g, composé de trois couches, coque externe en microfibre, membrane intermédiaire imperméable et respirante, interne en polaire



	CHF		
S	239.50	1	095000051
M	239.50	1	095000052
L	239.50	1	095000053
XL	239.50	1	095000054
XXL	239.50	1	095000055

9501TL

Pull polaire femme, 80 % coton, 20 % polyester, 320 g/m²



	CHF		
S	116.50	1	095010061
M	116.50	1	095010062
L	116.50	1	095010063
XL	116.50	1	095010064

9501TL

Sweat-shirt homme en coton 80 %, polyester 20 %, 320 g/m²



	CHF		
S	136.50	1	095010051
M	136.50	1	095010052
L	136.50	1	095010053
XL	136.50	1	095010054
XXL	136.50	1	095010055

9502TL

Polo 100 % coton piqué, 210 g/m²



	CHF		
S	80.50	1	095020051
M	80.50	1	095020052
L	80.50	1	095020053
XL	80.50	1	095020054
XXL	80.50	1	095020055

9505TL

Gilet en tissu externe 100 % polyester avec traitement hydrofuge, rembourré 100 g/m² et poche intérieure



	CHF		
S	199.50	1	095050051
M	199.50	1	095050052
L	199.50	1	095050053
XL	199.50	1	095050054
XXL	199.50	1	095050055

9534W0

polo à deux boutons, en jersey de coton, 200 g/m², blanc avec inserts orange



	CHF		
S	83.00	1	095340031
M	83.00	1	095340032
L	83.00	1	095340033
XL	83.00	1	095340034
XXL	83.00	1	095340035

9503TL

T-shirt 100 % coton jersey, 160 g/m²



	CHF		
S	52.50	1	095030051
M	52.50	1	095030052
L	52.50	1	095030053
XL	52.50	1	095030054
XXL	52.50	1	095030055

9572LB

Beta-March, 100% coton, 200 g/m² orange, avec inserts noirs



	CHF		
S	63.00	1	095720801
M	63.00	1	095720802
L	63.00	1	095720803
XL	63.00	1	095720804
XXL	63.00	1	095720805

9534B0

polo à deux boutons, en jersey de coton, 200 g/m², bleu avec inserts gris



	CHF		
S	83.00	1	095340071
M	83.00	1	095340072
L	83.00	1	095340073
XL	83.00	1	095340074
XXL	83.00	1	095340075

9504TL

Veste en tissu externe 100 % polyester avec traitement hydrofuge



	CHF		
S	162.00	1	095040051
M	162.00	1	095040052
L	162.00	1	095040053
XL	162.00	1	095040054
XXL	162.00	1	095040055

9510W

chemise stretch homme, manches longues, 120 g/m², 97% coton, 3% élasthanne. Blanc, avec logo noir. Joug arrière avec deux plis latéraux, col semi-Français. Boutons blancs, deux boutons de brassard. Coupe slim



	CHF		
XS	146.50	1	095100100
S	146.50	1	095100101
M	146.50	1	095100102
L	146.50	1	095100103
XL	146.50	1	095100104
XXL	146.50	1	095100105

9537TL

Pull polaire, 100 % polyester



	CHF		
S	79.50	1	095370051
M	79.50	1	095370052
L	79.50	1	095370053
XL	79.50	1	095370054
XXL	79.50	1	095370055



9580S

Lunettes de soleil

CE



EN ISO 12312-1:2013+A1:2015
UV400
FILTER CAT. III

9580S CHF 44.00 1 095800100

9593S

Smartwatch, touchscreen, fitness tracker, bracelet en silicone



9593 S CHF 189.50 1 095930200

9593SB

montre multifonction, écran tactile, tracker de fitness, moniteur de fréquence cardiaque, podomètre, surveillance du sommeil, avec bracelet en silicone, noir

Compatibilité: IOS 8.2 ou supérieur / Android 4.4 ou supérieur
Bluetooth 4.2 Ip67

CE



IP67

9593SB CHF 139.50 1 095930205

9593M

Montre à mouvement automatique, boîtier en acier, résistant à l'eau 5 ATM, bracelet-montre en acier



9593M CHF 461.00 1 095930120

9593A

Chronographe, boîtier en acier, étanche à l'eau 5 ATM, bracelet en silicone



9593A CHF 366.00 1 095930050

9593W

Montre analogique, boîtier en plastique soft touch avec couronne en métal, étanche à l'eau 3 ATM, bracelet en silicone



9593W CHF 80.50 1 095930150



9544C

Trolley dimensions format cabine avec 4 roulettes doubles, cadenas TSA, port USB + jack 3,5 mm



9544C L cm 40 S cm 20 H cm 55 CHF 190.50 1 095440101

9557J 2.0

Sac en polyester enduit/polyester Oxford 600d, dimensions 47x28x25 cm



9557J 2.0 L cm 47 S cm 25 H cm 28 CHF 113.50 1 095570020

9541F

Sac à dos en polyester enduit/polyester Oxford 600d, dimensions 50x33x16 cm



9541F	L cm	S cm	H cm	CHF		
	33	16	50	106.50	1	095410011

9541PC

Sac à dos de travail multipoches, avec poche interne pour ordinateur, 100 % polyester

- Sac à dos avec 3 compartiments, tous avec zip externe étanche
- Premier compartiment avec poche PC
- Poignée supérieure rembourrée
- Prise USB
- Poche latérale en filet pour bouteille d'eau/parapluie
- Insert porte-lunettes sur la bandoulière
- Sangle de poitrine réglable



9541PC	L cm	S cm	H cm	CHF		
	34	18	52	92.50	1	095410041

9541S

Sac à dos en polyester 210D imperméable 33x45 cm



9541S	L cm	H cm	CHF		
	33	45	14.40	1	095410031

9541BIKE

Sac à dos en polyester Oxford, dimensions 41x24x16 cm



9541BIKE	L cm	S cm	H cm	CHF		
	24	16	41	25.50	1	095410021

95740

Gants de travail, avec poignet élastiqué, pouce et index renforcés, en cuir synthétique permettant l'utilisation de dispositifs à écran tactile

CE



	CHF		
M	49.00	1	095740202
L	49.00	1	095740203
XL	49.00	1	095740204
XXL	49.00	1	095740205

9574B

Gants de travail, avec poignet élastiqué, pouce et index renforcés, en cuir synthétique permettant l'utilisation de dispositifs à écran tactile

CE



	CHF		
M	49.00	1	095740102
L	49.00	1	095740103
XL	49.00	1	095740104
XXL	49.00	1	095740105

9525CM

Casquette "Racing" style snapback camouflage, 100% polyester, avec arrière en maille.



9525CM	CHF		
	31.00	1	095250098

9525TR

Casquette noir type camionneur avec visière incurvée, 50 % coton, 50 % polyester avec arrière en maille.



9525TR	CHF		
	31.00	1	095250011

9525WB

Casquette de baseball blanche avec visière incurvée, 100% polyester avec aération sous la calotte et ajustable.



9525WB	CHF		
	22.00	1	095251032

9520P

Porte-parapluie noir métallique et galvanisé avec logo BETA découpé au laser et bac collecteur



9520P	CHF		
	87.50	1	095200100

9521

Parapluie en nylon T210 avec tige en aluminium 3 sections, noir, automatique



9521	CHF		
	40.50	1	095210000

95210B

Parapluie en nylon 210T, diamètre 100 cm



95210B	100 cm	CHF 44.50	1	095210021
--------	--------	-----------	---	-----------

9599CB-N2

vélo de ville, cadre Hi-Ten Tig TTK 700c, dérailleur Shimano® Tourney RD-TZ50, 6 vitesses, V-Brakes®, jantes en aluminium 28 », avec porte-bagages, support et cloche, noir mat



9599CB-N2	CHF 843.00	1	095990031
-----------	------------	---	-----------

Beta

9599CB-WN

Vélo de ville gris Atala® avec cadre aluminium, levier de vitesses Shimano® 6 vitesses, freins V-Brake®, jantes aluminium 28"

- Cadre en aluminium
- Fourche Hi-Ten Tig TTK 700c
- Manette de vitesse Shimano Tourney RD-TZ50 à 6 vitesses
- Freins V-brake en aluminium
- Jantes en aluminium de 28 pouces
- Couleur : gris



9599CB-WN	CHF 843.00	1	095990024
-----------	------------	---	-----------

9598W-N

Whistle® VTT, cadre en aluminium, fourche Suntour XCT30, 29 » 100 mm, dérailleur Shimano RD-TX500, freins hydrauliques Shimano BR-M200 à 7 vitesses et jantes en aluminium 29 », orange fluorescent / gris anthracite mat



9598W M-N	CHF 1,440.00	1	095980130
9598W L-N	CHF 1,440.00	1	095980132

9598WHP-N

Whistle® VTT, cadre en aluminium, fourche Suntour XCM PL, 29 » 100 mm, avec verrouillage à distance, dérailleur Shimano XT RD-M8100 Shadow Plus, freins hydrauliques Shimano BL-MT201/BR-MT200 à 12 vitesses et jantes en aluminium 29 », blanc / rouge mat



9598WHP M-N	CHF 2,700.00	1	095980140
9598WHP L-N	CHF 2,700.00	1	095980142

9597TRIOWAY

Système de propulsion électrique auxiliaire TRIOWAY par ATALA®, pouvant être fixé au fauteuil roulant REHA COMFORT (inclus), batterie au lithium intégrée au châssis, console avec commandes de direction et de vitesse, avec système d'accrochage intégré au fauteuil roulant

CE



CADRE

- Système de levier pour le verrouillage/déverrouillage rapide du fauteuil roulant
- Cadre pliable à double charnière
- Console de commande réglable en hauteur
- Frein à disque Ø 180 mm
- Éclairage avant LED
- Roue avant équipée de pneus en caoutchouc

PERFORMANCE

- Vitesse réglable, jusqu'à 15 km/h
- Bouton de commande avant et arrière
- Autonomie : 20 km
- Levier d'accélérateur sur la commande

BATTERIE

- Batterie au lithium rechargeable de 7 Ah
- Batterie amovible intégrée au cadre
- Câble de chargement 230 V 50 Hz (inclus)

ACCESSOIRES

- Écran multifonctionnel, avec capacité résiduelle de la batterie et indicateur du niveau de charge
- Cloche
- Indicateurs de direction
- Support pour téléphone portable (inclus)
- Bouton On/Off
- SYSTÈME DE CROCHET RAPIDE préinstallé SOUS LE FAUTEUIL ROULANT

FAUTEUIL ROULANT CONFORT REHA (inclus)

- Cadre pliable à double charnière
- Roues de 24 pouces avec pneus dense en PU
- Accoudoirs amovibles
- Pieds de lit réglables et amovibles
- Siège en nylon avec poche arrière

DISPONIBLE SUR DEMANDE



9597TRIOWAY

1 095970200

Beta

9539CB

Casque de protection pour cyclisme sur route et VTT avec visière amovible - tailles réglable



	CHF		
S-M	222.50	1	095390010
L-XL	222.50	1	095390011

9542M

Tricot manches courtes en microfibre respirante, fermeture éclair longue couverte, trois poches arrière dont 1 avec fermeture éclair, élastique en silicone au bas de maillot



	CHF		
S	158.50	1	095420051
M	158.50	1	095420052
L	158.50	1	095420053
XL	158.50	1	095420054
XXL	158.50	1	095420055
XXXL	158.50	1	095420056

9542C

Salopette en Lycra, élastique en silicone en bas de jambe, fibre antibactérienne et respirante



	CHF		
S	151.00	1	095420061
M	151.00	1	095420062
L	151.00	1	095420063
XL	151.00	1	095420064
XXL	151.00	1	095420065
XXXL	151.00	1	095420066

9542GW

Blouson d'hiver réalisé en tissu coupe-vent à respirabilité élevée et lainé ; fermeture éclair longue, bande élastique à la taille sans silicone ; poignet adhérent en Lycra ; empiècements réfléchissants arrière ; 3 poches externes arrière, dont 1 avec fermeture éclair



	CHF		
S	275.00	1	095420101
M	275.00	1	095420102
L	275.00	1	095420103
XL	275.00	1	095420104
XXL	275.00	1	095420105
XXXL	275.00	1	095420106

9542G

Tricot d'hiver en tissu respirant, lainé à l'intérieur, fermeture éclair longue, trois poches à l'arrière, élastique en silicone au bas du tricot



	CHF		
S	158.00	1	095420012
M	158.00	1	095420013
L	158.00	1	095420014
XL	158.00	1	095420015
XXL	158.00	1	095420016
XXXL	158.00	1	095420017

Beta

9542S

Collant d'hiver en lycra lainé avec fibre antibactérienne et respirante



	CHF		
S	212.50	1	095420022
M	212.50	1	095420023
L	212.50	1	095420024
XL	212.50	1	095420025
XXL	212.50	1	095420026
XXXL	212.50	1	095420027

9542AT

Gilet coupe-vent en tissu respirant, fermeture éclair longue



	CHF		
S	127.50	1	095420072
M	127.50	1	095420073
L	127.50	1	095420074
XL	127.50	1	095420075
XXL	127.50	1	095420076
XXXL	127.50	1	095420077

9542AL

Coupe-vent imperméable à manches longues respirant



	CHF	🛒	📦
S	203.50	1	095420042
M	203.50	1	095420043
L	203.50	1	095420044
XL	203.50	1	095420045
XXL	203.50	1	095420046
XXXL	203.50	1	095420047

9543C

Cache-cou tubulaire, multifonctions, 100 % microfibre de polyester, sans coutures



	L cm	H cm	CHF	🛒	📦
9543C	25	50	11.20	1	095430100

9523T

gourde isolante, en acier inoxydable, 500 ml, technologie double couche, pas d'air entre les parois, bouchon étanche, orange

- garde les boissons froides pendant 24 heures
- garde les boissons chaudes pendant 12 heures



EC1935/EC2023

	ml	L mm	CHF	🛒	📦
9523T	500	255	28.00	1	095230050

9528B

Gourde en polyéthylène, 500 ml



	ml	CHF	🛒	📦
9528B	500	8.80	1	095280005

9597P

Pompe à pied pour vélo avec manomètre



	CHF	🛒	📦
9597P	82.00	1	095970100

9524SC

Garage Beta en miniature pour collectionneurs



	1:18	CHF	🛒	📦
		116.50	1	095240018

9548KB

Vélo "enfant" cadre en acier et Roue 12" avec chambre à air, âge conseillé : + de 3 ans, poids maximum < 30 kg



	CHF	🛒	📦
9548KB	211.50	1	095480110

9548KB 20

VTT pour enfants Atala® 20 », cadre en acier Hi-Ten Tig 20 », fourche à suspension de 30 mm, dérailleur RD-TY21SS 6V, freins en V en aluminium et jantes en aluminium 36 trous, jaune fluorescent / bleu mat



	CHF	🛒	📦
9548KB 20	682.00	1	095480120

9548KB 24

VTT pour enfants Atala® 24 », cadre en acier Hi-Ten Tig 24 », fourche à suspension, dérailleur Shimano Tourney RD-TY50 6V, freins en V en aluminium et jantes en aluminium 36 trous, orange fluorescent mat



	CHF	🛒	📦
9548KB 24	725.00	1	095480122

9547WSK

"Kinder Work Station", établi avec outils pour enfants âgés de 3 ans ou plus



	H cm	CHF	🛒	📦
9547WSK	74	158.00	1	095473801

9547T

"Kinder trolley", chariot porte-outils avec outils pour enfants à partir de 3 ans



	CHF	🛒	📦
9547T	86.00	1	095470100



9548G

"Kinder Garage" à 6 niveaux, avec autolavage, ascenseur et rampes



9548 G H cm 69 CHF 86.00 1 095480100

9561V 2,5

Drapeau en voile 2,5x0,50 m avec tige en aluminium socle cruciforme avec lest circulaire



9561V 2,5 L mt 0,50 H mt 2,5 CHF 310.00 1 095610200

9561VV 2,5

Drapeau en voile 2x0,50 m avec tige



9561VV 2,5 L mt 0,50 H mt 2,5 CHF 278.00 1 095610201

9561VV

Drapeau en voile 3,50x0,75 m avec tige



9561VV 4,0 L mt 0,75 H mt 3,50 CHF 459.00 1 095610101

9561V

Drapeau en voile 4x0,75 m avec tige en métal chromé socle en particules de ciment 50 cm



9561V L mt 0,75 H mt 4 CHF 801.00 1 095610001

9559

Banderole une face en TNT, module de 3x0,8 m



9559 L m 3 H m 0,8 CHF 37.00 1 095591001

9559/30MT

Rouleau 10 logos Beta en TNT



9559/30MT CHF 351.00 1 095591031

9590B

Bannière en nylon sérigraphié 40 x 215 cm



9590B L cm 215 H cm 140 CHF 158.00 1 095900000



9577R

Combinaison de travail, style racing, en tissu extensible 4-way-stretch, 260 g/m², noir et orange, avec inserts blancs et réfléchissants

CE



		CHF		
S	48	188.50	1	095770151
M	50	188.50	1	095770152
L	52	188.50	1	095770153
XL	54	188.50	1	095770154
XXL	56	188.50	1	095770155
XXXL	58	188.50	1	095770156

9579C

Blouse en polyester/coton



		CHF		
M		83.00	1	095791002
L		83.00	1	095791003
XL		83.00	1	095791004

9565T

Fût table en tôle d'acier avec plan en bois multicouche de bouleau verni.

Fourni avec double KIT de tubes distanciers (7 ou 20 cm) pour le réglage de la hauteur.



9565T	H cm	ø cm	CHF		
95	→108	70	620.00	1	095650200

9565S

Fût en tôle d'acier avec chaise en similicuir déhoussable.



9565S	H cm	ø cm	CHF		
60		38	272.00	1	095650300

9565K

Table fût avec deux assises



9565K	CHF				
	1,163.00	1	095650500		

Beta

9563G

Fauteuil de bureau pour visiteurs



9563G	CHF				
	230.50	1	095630050		

9563U

Fauteuil de bureau, ergonomique, avec accoudoirs



9563U	CHF				
	455.00	1	095630020		

9549ABW

BT V5.0 sans fil, avec microphone intégré, charge magnétique, base de charge USB-C, noir

CE



9549ABW	L mm	H mm	S mm	CHF		
	61	34,5	41	41.50	1	095490091

9549SBW

Speaker BT sans fil, 6 fonctions

Version BT 5.0

FUNCTIONS :

- BT play
- TF card play
- USB play
- audio jack 3,5 mm
- radio FM
- fonction appel

CE



9549SBW	L mm	S mm	H mm	CHF		
	73	73	124	57.50	1	095490072

9549BP

Batterie portable, 10000mAh



9549BP	CHF				
	29.50	1	095490052		

9549CR

Multi-câble de charge 4 en 1, en nylon tressé, à charge rapide

• USB de type A pour la connexion de l'alimentateur

- Connexion Lightning pour les modèles Apple
- Connecteur de charge micro USB
- Connecteur USB-C pour le chargement uniquement
- Connecteur USB-C pour le chargement et la transmission de données



9549CR	L mm	CHF			
	120	22.20	1	095490042	

9549MPC

Base de recharge multiprise, 6 ports USB pour une charge multiple jusqu'à une puissance maximale absorbée de 65 W

- 4 ports USB, 5 V 2,4 A
 - 1 port USB, QC 3.0
 - 1 port USB-C, PD 20 W
- avec interrupteur ON/OFF séparé, écran LED pour contrôler le potentiel total, le numéro de port et l'intensité du courant

CE



9549MPC	L mm	S mm	H mm	CHF		
	110	72	35	70.50	1	095490082

Beta

9549BRW

Socle de recharge sans fil, avec fonction chargeur rapide et indicateur de charge

- Câble USB-USB Type C inclus, pour la connexion au transformateur, longueur 1 m
- Compatible avec tous les appareils compatibles avec le chargement sans fil
- Input : DC 5 V/2 A, 9 V/2 A, 12 V/1.5 A
- Output : 5 W/ 7,5 W/ 10 W/ 15 W

CE



9549BRW	Ø mm	H mm	CHF		
	58	6	40.50	1	095490100

9549C

Clé USB, 32GB



9549C	CHF		
	26.00	1	095490062

9547

Calculatrice de bureau

CE



9547	CHF		
	26.00	1	095470000

9594

Horloge murale avec thermomètre et hygromètre, diamètre 26 cm



9594	Ø cm	CHF	
	26	39.00	1 095940051

9526F

Mini-réfrigérateur noir, d'une capacité de 63 litres et de classe énergétique F.

CE



9526F	CHF		
	683.00	1	095260005

9526P

Machine à café espresso à capsules

Compatible avec capsules Lavazza™, Espresso Point™ utilisation professionnelle



9526P	CHF		
	446.00	1	095260010

9527 6T

Set 6 tasses à café



9527 6T	CHF		
	127.50	1	095270001

9522A

Ouvre-bouteilles avec branche ergonomique



9522A	CHF		
	22.30	1	095220010

9523A

Gourde en aluminium, 500 ml



9523A	ml	CHF	
	500	15.40	1 095230005

9586K

Couteau multifonctions en acier, 10 fonctions



9586K	CHF		
	21.50	1	095860100

9526RMN

Kit de 2 jeux de 55 cartes rami Modiano®



9526RMN	CHF		
	37.00	1	095260010

9592B/C50

Lot de 50 stylos



9592B/C50	CHF		
	64.00	1	095920050

9592B/P

Stylos personnalisés



9592B/P	CHF		
	1.91	500	095920051

9592MB

Stylo à bille Parker®



9592MB	CHF		
	103.50	1	095920060

Beta

Quality Tools

9592M/50

Jeu de 50 crayons



9592M/50 CHF 64.00 1 095920100

9588M

Plateau thermoformé souple avec 1 stylo et 2 bloque-notes



9588M CHF 27.00 1 095880011

9596

Porte-badge en polyester avec mousqueton en métal et fil porte-téléphone



9596 CHF 6.45 10 095961001

9595C

Porte-clés en peau



9595C CHF 11.70 1 095950011



9595T

Porte-clés en métal chromé, dans étui de velours



9595T CHF 9.80 1 095950021

9569P

Sacs en polyéthylène, avec soufflets latéraux



9569P L cm 34 H cm 44 CHF 1.05 50 095691001

9569S

Sac shopper en TNT avec soufflet, 38x42 cm



9569S L cm 38 H cm 42 CHF 3.20 50 095690051

9569MS-2

Shopper en polypropylène à haute résistance



9569MS-2 L cm 45 H cm 40 CHF 8.45 5 095690055

9569MS

Sac shopper en polypropylène à haute résistance, avec double poignées



9569MS L cm 60 H cm 40 CHF 8.45 5 095690052

9587 9x14

Carnet, 9x14 cm



9587 9X14 L cm 9 H cm 14 CHF 17.40 5 095870009

9587 13x21

Carnet, 13x21 cm



9587 13X21 L cm 13 H cm 21 CHF 22.20 5 095870013



9588S/10...

Jeu de 10 blocs-notes



	CHF		
9588S/10A 21x29 cm	37.00	1	095881001
9588S/10B 15x21 cm	35.50	1	095881002
9588S/10C 10x15 cm	23.10	1	095881003
9588S/10D 7,5x10,5 cm	16.60	1	095880054

9588/10PI

Jeu de 10 blocs-notes à feuilles repositionnables



	CHF		
9588S/10PI 7,5x7,5 cm	34.50	1	095880055

9589A/36

Paquet de 36 rouleaux de ruban adhésif pour emballage, logo Beta, havane



	CHF		
9589A/36	178.50	1	095890035

9589B/36

Paquet de 36 rouleaux de ruban adhésif pour emballage, logo Beta, blanc



	CHF		
9589B/36	178.50	1	095890036

9562TB

Tapis pour essuyage chaussures, avec partie arrière en caoutchouc antiglisse



	L mm	H mm	CHF		
9562TB	800	600	61.50	1	095620500

9562T2

Tapis pour établi de travail 200x160 cm

- Protège le sol contre les fuites d'huile et d'essence et respecte l'environnement
- Facile à nettoyer, en caoutchouc et antidérapant



	L cm	H cm	CHF		
9562T2	200	160	307.00	1	095620200

9562T1

garage mat, 100X80 cm

adapté à une utilisation sous les leviers de pneus moto BETA 3071 et 3071B

- fond recouvert de caoutchouc antidérapant facile à nettoyer



	L cm	H cm	CHF		
9562T1	100	80	113.00	1	095620150

9562T3

Tapis d'atelier
Dimensions : 300x160 cm

- Particulièrement indiqué pour l'utilisation sous les ponts élévateurs moto

- Protège le sol contre les fuites d'huile et d'essence et respecte l'environnement
- Facile à nettoyer, en caoutchouc et antidérapant



	L cm	H cm	CHF		
9562T3	300	160	446.00	1	095620300

9562P2

Tapis multilogo 200x80 cm

- Particulièrement indiqué pour les utilisations en atelier C55 ou comme tapis à placer sous les motos



	L cm	H cm	CHF		
9562P2	200	80	215.00	1	095620400

9562P12

Rouleau tapis multilogo de 12 m x 80 cm

- Permet de personnaliser la longueur du tapis en fonction des exigences de l'utilisateur



	L m	H cm	CHF		
9562P12	12	80	1,086.00	1	095620425



ARTICLES SUPPRIMÉS = ARTICLES DE REMPLACEMENT/RECOMMANDÉS

	ARTICLE SUPPRIMÉ
	ARTICLE DE REMPLACEMENT
	ARTICLE RECOMMANDÉ

96AS 5/8	000960736		
96AS 3/4	000960738		
97BTX 50	000970150		
97BTX 55	000970155		
98XZN 14	000980014		
98XZN 16	000980016		
310/1	003100001		
310/C4	003100104		
353N	003530201		
353NM 10	003530210		
353NM 12	003530212		
353NM 14	003530214		
353NM 16	003530216		
353NM 18	003530218		
353NM 22	003530222		
353N/C6	003530300		
386A/3	003860003	386A/1	003860001
386A/4	003860004	386A/2	003860002
386A3/RC	003860013	386A1/RC	003860011
386A4/RC	003860014	386A2/RC	003860012
412 C3,00	004120288		
412 C3,25	004120289		
412 C3,50	004120290		
412 C4,00	004120292		
412 C4,50	004120294		
412 C5,00	004120296		
412 C5,50	004120298		
412 C6,00	004120300		
412 C6,50	004120301		
412 C7,00	004120302		
412 C7,50	004120303		
412 C8,00	004120304		
415 C3,00	004150288		
415 C3,25	004150289		
415 C3,50	004150290		
415 C4,00	004150292		
415 C4,50	004150294		
415 C5,00	004150296		
415 C5,50	004150298		
415 C6,00	004150300		
415 C6,50	004150301		
415 C7,00	004150302		
415 C7,50	004150303		
415 C8,00	004150304		
420A M3	004200003		
420A M4	004200004		
420A M5	004200005		
420A M6	004200006		
420A M8	004200008		
420A M10	004200010		
420B M3	004200053		
420B M4	004200054		
420B M5	004200055		
420B M6	004200056		
420B M8	004200058		
420B M10	004200060		
437K/10	004370030		
666N/2	006660002	666/2	006660702
666N/2X	006660003	666/2X	006660703
666N/5	006660005	666/5	006660705
666N/10	006660010	666/10	006660710
666N/10X	006660011	666/10X	006660711
666N/20	006660020	666/20	006660720
666N/30	006660030	666/30	006660730
666N-LBF.IN/5	006660055		
666N-LBF.IN/10	006660070		

666N-LBF.IN/10X	006660071		
666N-LBF.IN/20	006660072		
666N-LBF.IN/30	006660073		
666HS/5	006664005	666ZR-HS/5	006664705
666HS/10	006664010	666ZR-HS/10	006664710
666HS/20LC	006664021	666ZR-HS/20LC	006664721
666HS/30LC	006664031	666ZR-HS/30LC	006664731
667N/20	006670020	667/20	006670720
667N/30	006670030	667/30	006670730
667N/40	006670040	667/40	006670740
956L 20,8	009560221		
960S 22	009600022		
960T/D	009600035		
960T/E	009600036		
960T/I	009600040		
960T/L	009600041		
960T/M	009600042		
960BT/B 29	009600128		
960AVL	009600210		
960CMB	009600250		
960CMB/R2	009600252		
960CMD	009600270		
960CMD/R1	009600271		
960BC 25	009600285		
960BC 27	009600287		
960BC/P 28	009600288		
960BC 29	009600289		
960BC 30	009600290		
960EPC	009600790		
960SN 11	009600837		
960SN 12	009600838		
1044F 250	010440015	1044N 250	010440025
1044 250	010440250	1044N 250	010440025
1044FK 250	010449015	1044NK 250	010449025
1044K 250	010449250	1044NK 250	010449025
1134A/RL	011340145		
1150MQ 160	011500096	1150MQ 160	011500496
1150MQ 180	011500098	1150MQ 180	011500498
1150MQ 200	011500100	1150MQ 200	011500500
1150MQ 220	011500102	1150MQ 220	011500502
1229LP 1,0	012290210		
1229LP 1,2	012290212	1257LP 1,2	012570012
1229LP 1,4	012290214		
1229LP 1,8	012290218	1257LP 1,8	012570018
1229LP 2,0	012290220	1257LP 2,0	012570020
1229LP 2,4	012290224		
1229LP 3,0	012290230	1257LP 3,0	012570030
1229PH 0	012290250	1257PH 0	012570063
1229PH 1	012290251	1257PH 1	012570066
1366S	013660000	1366SH	013660400
1366S-KIT	013660001		
1438DCT	014380300		
1461C5G	014610053		
1461/C6B	014610063		
1461/C6G	014610064		
1461/C7B	014610072		
1461/C8B	014610083		
1461/C9B	014610092		
1461/C11A	014610111		
1461/C12A	014610123		
1461/C13B	014610134		
1461/C18B	014610182		
1461/C29B	014610209		
1461/C20G	014610221		
1461/C21G	014610222		
1461/C23B	014610224		
1461/C24B	014610225		
1461/C25G	014610226		
1461/C27G	014610228		
1461/C28B	014610229		
1461/C30G	014610231		

1461/C32G	014610233		
1461/C33B	014610234		
1462/KD	014620060		
1462/KMRC	014620070		
1462PIM	014620502		
1468N/1	014680011		
1468N/2	014680012		
1468N/3	014680013		
1478/3P	014780151		
1486/10	014860110		
1486/20	014860120		
1486/30	014860130		
1486/40	014860140		
1486/50	014860150		
1486/60	014860160		
1486/70	014860170		
1486/80	014860180		
1486/90	014860190		
1493 68-L14	014930206		
1493 75/77-L15	014930212		
1493 76-L8	014930214		
1493 95-L15	014930244		
1493AL 94,5-L15	014930345		
1493AL/CF 27	014930427		
1498TC	014980450		
1696A 800	016960108		
1716Q	017160010		
1739B	017390151	1739C	017390152
1740A	017400101	1740AN	017400103
1742	017420001	1742N	017420002
1742/C4	017420005	1742N/C4	017420006
1742KR M3	017420043	1742N/KR M3	017420063
1742KR M4	017420044	1742N/KR M4	017420064
1742KR M5	017420045	1742N/KR M5	017420065
1742KR M6	017420046	1742N/KR M6	017420066
1742A	017420100	1742AN	017420101
1742A/C	017420105	1742AN/C	017420106
1742A/KR M5	017420143	1742AN/KR M5	017420155
1742A/KR M6	017420144	1742AN/KR M6	017420156
1742A/KR M8	017420145	1742AN/KR M8	017420158
1742A/KR M10	017420146	1742AN/KR M10	017420160
1751NR	017510110		
1752 700	017520007		
1752R	017520020		
1753 200	017530002		
1753 300	017530003		
1753 500	017530005		
1753 700	017530007		
1753R	017530020		
1755 30	017550003		
1755 80	017550008		
1755 150	017550015		
1834RR	018340520		
1840BM	018400101		
1882	018820010	1882N	018820110
1883	018830035	1883N	018830036
1889	018890200	1889N	018890220
1915B 11X16	019150013		
1915C 11X16	019150016		
1915D 11X16	019150018		
1927PAL	019270009		
1946T	019460021	1946	019460001
1949BC/RU	019490122	1949BC/RUL	019490123
1972/12	019720012	1972/K12V-10	019720112
1984/18QM	019840018	1984/K600	019840060
2009ID	020091013	2109MT ID/1	021091026
2032TEL/A	020321314		
2051N	020510215	2051N	020510225
2258-O	022580011	2258N-O	022580021
TV250	024000408		
TV290	024000455	TV294	024000491
TV255	024000467		

ARTICLES SUPPRIMÉS = ARTICLES DE REMPLACEMENT/RECOMMANDÉS

	ARTICLE SUPPRIMÉ
	ARTICLE DE REMPLACEMENT
	ARTICLE RECOMMANDÉ

TV79	024000490		
TV121	024000767	TV122	024000768
T13	024240013		
T53	024240053		
T57	024240057		
T79	024240079		
T121	024240121	T122	024240122
T250	024240250		
T256	024240256		
T285	024240285	T279	024240279
T289	024240289	T294	024240294
T289	024240289	M294	024500294
TV57	024249907		
TV13	024249913		
M285	024500285		
M289	024500289		
MV115	024510115	MV116	024510116
MV285	024510285		
MV289	024510289	MV294	024510294
MM61	024580061		
MM140	024580141		
MMV61	024590061		
MMV142	024590142		
3008	030080100	3008N	030080110
3025	030250001	3025N 1,0	030250110
3025/PF	030250011	3025N/PF	030250111
3025/RF	030250901		
3025/RG	030250902		
3027 10	030270010	3027N 10	030270101
3027 20	030270020	3027N 20	030270102
3027 30	030270030	3027N 30	030270103
3027 50	030270050	3027N 50	030270105
3027 100	030270100	3027N 100	030270110
3027/KP10	030270510	3027N/KP10-20	030270511
3027/KP20	030270520	3027N/KP10-20	030270511
3027/KP30	030270530	3027N/KP30	030270531
3027/KP50	030270550	3027N/KP50	030270541
3027/KP100	030270551	3027N/KP100	030270552
3027/KPP50	030270555	3027N/KPP50	030270565
C45LMP	045000320	5000 RSC50PLED	050001714
C54S-G	054000302		
C54S-R	054000303		
C55C	055000400		
C58M/PA	058000350		
5910VG/3T	059101068		
5945VU/M	059451001	5945VUM	059451011
5980ID	059801085	5980ID/1	059801086
C62M/W	062000360	C62M/WW	062000362
6200M/B	062000361		
7195A	071950004		
7200BKK 35	072000235		
7200BKK 36	072000236		
7200BKK 37	072000237		
7200BKK 38	072000238		
7200BKK 39	072000239		
7200BKK 40	072000240		
7200BKK 41	072000241		
7200BKK 42	072000242		
7200BKK 43	072000243		
7200BKK 44	072000244		
7200BKK 45	072000245		
7200BKK 46	072000246		
7200BKK 47	072000247		
7200BKK 48	072000248		
7201BKK 35	072010435		
7201BKK 36	072010436		

7201BKK 37	072010437		
7201BKK 38	072010438		
7201BKK 39	072010439		
7201BKK 40	072010440		
7201BKK 41	072010441		
7201BKK 42	072010442		
7201BKK 43	072010443		
7201BKK 44	072010444		
7201BKK 45	072010445		
7201BKK 46	072010446		
7201BKK 47	072010447		
7201BKK 48	072010448		
7210BKK 35	072100335		
7210BKK 36	072100336		
7210BKK 37	072100337		
7210BKK 38	072100338		
7210BKK 39	072100339		
7210BKK 40	072100340		
7210BKK 41	072100341		
7210BKK 42	072100342		
7210BKK 43	072100343		
7210BKK 44	072100344		
7210BKK 45	072100345		
7210BKK 46	072100346		
7210BKK 47	072100347		
7210BKK 48	072100348		
7212LG 34	072120134		
7212LG 35	072120135		
7212LG 36	072120136		
7212LG 37	072120137		
7212LG 38	072120138		
7212LG 39	072120139		
7212LG 40	072120140		
7212LG 41	072120141		
7212LG 42	072120142		
7214LN 34	072140134		
7214LN 35	072140135		
7214LN 36	072140136		
7214LN 37	072140137		
7214LN 38	072140138		
7214LN 39	072140139		
7214LN 40	072140140		
7214LN 41	072140141		
7214LN 42	072140142		
7216BKK 35	072160335		
7216BKK 36	072160336		
7216BKK 37	072160337		
7216BKK 38	072160338		
7216BKK 39	072160339		
7216BKK 40	072160340		
7216BKK 41	072160341		
7216BKK 42	072160342		
7216BKK 43	072160343		
7216BKK 44	072160344		
7216BKK 45	072160345		
7216BKK 46	072160346		
7216BKK 47	072160347		
7216BKK 48	072160348		
7224PEK 35	072240235		
7224PEK 36	072240236		
7224PEK 37	072240237		
7224PEK 38	072240238		
7224PEK 39	072240239		
7224PEK 40	072240240		
7224PEK 41	072240241		
7224PEK 42	072240242		
7224PEK 43	072240243		
7224PEK 44	072240244		
7224PEK 45	072240245		
7224PEK 46	072240246		
7224PEK 47	072240247		

7224PEK 48	072240248		
7225PEK 35	072250135		
7225PEK 36	072250136		
7225PEK 37	072250137		
7225PEK 38	072250138		
7225PEK 39	072250139		
7225PEK 40	072250140		
7225PEK 41	072250141		
7225PEK 42	072250142		
7225PEK 43	072250143		
7225PEK 44	072250144		
7225PEK 45	072250145		
7225PEK 46	072250146		
7225PEK 47	072250147		
7225PEK 48	072250148		
7235BK 35	072350335		
7235BK 36	072350336		
7235BK 37	072350337		
7235BK 38	072350338		
7235BK 39	072350339		
7235BK 40	072350340		
7235BK 41	072350341		
7235BK 42	072350342		
7235BK 43	072350343		
7235BK 44	072350344		
7235BK 45	072350345		
7235BK 46	072350346		
7235BK 47	072350347		
7235BK 48	072350348		
7239B 39	072390339		
7239B 40	072390340		
7239B 41	072390341		
7239B 42	072390342		
7239B 43	072390343		
7239B 44	072390344		
7239B 45	072390345		
7239B 46	072390346		
7239B 47	072390347		
7239B 48	072390348		
7248GK 35	072480235		
7248GK 36	072480236		
7248GK 37	072480237		
7248GK 38	072480238		
7248GK 39	072480239		
7248GK 40	072480240		
7248GK 41	072480241		
7248GK 42	072480242		
7248GK 43	072480243		
7248GK 44	072480244		
7248GK 45	072480245		
7248GK 46	072480246		
7248GK 47	072480247		
7248GK 48	072480248		
7293HN 39	072930839		
7293HN 40	072930840		
7293HN 41	072930841		
7293HN 42	072930842		
7293HN 43	072930843		
7293HN 44	072930844		
7293HN 45	072930845		
7293HN 46	072930846		
7293HN 47	072930847		
7294HN 39	072940839		
7294HN 40	072940840		
7294HN 41	072940841		
7294HN 42	072940842		
7294HN 43	072940843		
7294HN 44	072940844		
7294HN 45	072940845		
7294HN 46	072940846		
7294HN 47	072940847		

ARTICLES SUPPRIMÉS = ARTICLES DE REMPLACEMENT/RECOMMANDÉS

	ARTICLE SUPPRIMÉ
	ARTICLE DE REMPLACEMENT
	ARTICLE RECOMMANDÉ

7310CRK 35	073100335		
7310CRK 36	073100336		
7310CRK 37	073100337		
7310CRK 38	073100338		
7310CRK 39	073100339		
7310CRK 40	073100340		
7310CRK 41	073100341		
7310CRK 42	073100342		
7310CRK 43	073100343		
7310CRK 44	073100344		
7310CRK 45	073100345		
7310CRK 46	073100346		
7310CRK 47	073100347		
7310CRK 48	073100348		
7340B 36	073400236		
7340B 37	073400237		
7340B 38	073400238		
7340B 39	073400239		
7340B 40	073400240		
7340B 41	073400241		
7340B 42	073400242		
7340B 43	073400243		
7340B 44	073400244		
7340B 45	073400245		
7340B 46	073400246		
7340B 47	073400247		
7341N 36	073410236		
7341N 37	073410237		
7341N 38	073410238		
7341N 39	073410239		
7341N 40	073410240		
7341N 41	073410241		
7341N 42	073410242		
7341N 43	073410243		
7341N 44	073410244		
7341N 45	073410245		
7341N 46	073410246		
7341N 47	073410247		
7349RP 38	073490138		
7349RP 39	073490139		
7349RP 40	073490140		
7349RP 41	073490141		
7349RP 42	073490142		
7349RP 43	073490143		
7349RP 44	073490144		
7349RP 45	073490145		
7349RP 46	073490146		
7349RP 47	073490147		
7350RP 38	073500138		
7350RP 39	073500139		
7350RP 40	073500140		
7350RP 41	073500141		
7350RP 42	073500142		
7350RP 43	073500143		
7350RP 44	073500144		
7350RP 45	073500145		
7350RP 46	073500146		
7350RP 47	073500147		
7423 39/42	074230002		
7423 43/46	074230004		
7429 39/42	074290002		
7429 43/46	074290004		
7635N XS	076350500	7636N XS	076360500
7635N S	076350501	7636N S	076360501
7635N M	076350502	7636N M	076360502
7635N L	076350503	7636N L	076360503

7635N XL	076350504	7636N XL	076360504
7635N XXL	076350505	7636N XXL	076360505
7635N XXXL	076350506	7636N XXXL	076360506
7658N S	076580001		
7658N M	076580002		
7658N L	076580003		
7658N XL	076580004		
7658N XXL	076580005		
7658N XXXL	076580006		
7904N XS	079040800	7750N XS	077500000
7904N S	079040801	7750N S	077500001
7904N M	079040802	7750N M	077500002
7904N L	079040803	7750N L	077500003
7904N XL	079040804	7750N XL	077500004
7904N XXL	079040805	7750N XXL	077500005
7904N XXXL	079040806	7750N XXXL	077500006
7904N XXXXL	079040807	7750N XXXXL	077500007
7907P XS	079070600		
7907P S	079070601		
7907P M	079070602		
7907P L	079070603		
7907P XL	079070604		
7907P XXL	079070605		
7907P XXXL	079070606		
7907P XXXXL	079070607		
7930G XS	079300300	7930MG XS	079300400
7930G S	079300301	7930MG S	079300401
7930G M	079300302	7930MG M	079300402
7930G L	079300303	7930MG L	079300403
7930G XL	079300304	7930MG XL	079300404
7930G XXL	079300305	7930MG XXL	079300405
7930G XXXL	079300306	7930MG XXXL	079300406
7931G XS	079310300	7931MG XS	079310400
7931G S	079310301	7931MG S	079310401
7931G M	079310302	7931MG M	079310402
7931G L	079310303	7931MG L	079310403
7931G XL	079310304	7931MG XL	079310404
7931G XXL	079310305	7931MG XXL	079310405
7931G XXXL	079310306	7931MG XXXL	079310406
7933G XS	079330300	7935MG XS	079350400
7933G S	079330301	7935MG S	079350401
7933G M	079330302	7935MG M	079350402
7933G L	079330303	7935MG L	079350403
7933G XL	079330304	7935MG XL	079350404
7933G XXL	079330305	7935MG XXL	079350405
7933G XXXL	079330306	7935MG XXXL	079350406
7935G XS	079350300		
7935G S	079350301		
7935G M	079350302		
7935G L	079350303		
7935G XL	079350304		
7935G XXL	079350305		
7935G XXXL	079350306		
7939G XS	079390300		
7939G S	079390301		
7939G M	079390302		
7939G L	079390303		
7939G XL	079390304		
7939G XXL	079390305		
7939G XXXL	079390306		
7980N 58	079800058	7981N 58	079810158
7980N 60	079800060	7981N 60	079810160
7980R	079800111	7980RN	079800120
7985	079850111	7985N	079850000
8016FR-6K 3	080169753		
8016FR-4K 5	080169755		
8016FR-4K 6	080169756		
8016FR-4K 8	080169758		
8062 22-25	080620025		
8130A 10X900	081300209		
8131Z-8 6X800	081310060		
8131DL 10X900	081310209		

8135/KCA 0,75	081350630		
8135/KCA 1,0	081350635		
8135/KCA 2,0	081350640		
8135/KCA 3,0	081350645		
8135/KCA 5,0	081350650		
8135/KGF 0,75	081350705		
8135/KGF 1,0	081350710		
8135/KGF 2,0	081350720		
8135/KGF 3,0	081350730		
8135/KGF 5,0	081350750		
8135/KGM 0,75	081350805		
8135/KGM 1,0	081350810		
8135/KGM 2,0	081350820		
8135/KGM 3,0	081350830		
8135/KGM 5,0	081350850		
8139Z 8	081390008		
8139DL 14	081390214		
8139ZCH	081390909		
8149S/A	081490510		
8149S/B	081490512		
8149S/C	081490515		
9508TL S	095080051		
9508TL M	095080052		
9508TL L	095080053		
9508TL XL	095080054		
9508TL XXL	095080055		
9515M S	095150051		
9515M M	095150052		
9515M L	095150053		
9515M XL	095150054		
9515M XXL	095150055		
9515M XXXL	095150056		
9516B S	095160051		
9516B M	095160052		
9516B L	095160053		
9516B XL	095160054		
9516B XXL	095160055		
9516B XXXL	095160056		
9525TL	095250010	9525TR	095250011
9525F	095250099	9525CM	095250098
9525B	095251031	9525WB	095251032
9527MUG	095270020	9599CB-WN	095990024
9557N	095570001		
9565BBQ	095650100		
9565ICE	095650400		
9595 C25	095950031		
9599CB-W	095990023		
9599 GARAGE-S	095999011		
9599 GARAGE-M	095999012		
9599 GARAGE-L	095999013		
9599 GARAGE-XL	095999014		
9599 GARAGE-XXL	095999015		
C99T	099000492		
C99M	099000494		
C99T-V3	099000497		
C99P-V3	099000498		
11204C 40	112040204		
11204C 60	112040206		
11210C 40	112100204		
11210C 60	112100206		
11216C 40	112160204		
11216C 60	112160206		
11220C 40	112200204		
11220C 60	112200206		
11234B 40	112340104		
11234B 60	112340106		
11435 M-80	114350008		
11435 M-120	114350012		
11435 F-150	114350015		
11435 F-180	114350018		

Accessoires de levage inox	671÷714
Accessoires de levage Robur	650÷670
Accessoires porte-outils pour armoires, tiroirs et parois	700÷706
Ameublement de l'atelier	559÷561
Anneau de levage	347
Appareil d'étalonnage pour tuyaux multicouche	694, 699
Appareils à collets	433÷435; 452; 473÷474
Appareils de mesure laser	402
Armoires d'atelier	410÷478
Armoires porte-outils	219
Aspirateur eau et poussières pour usage professionnel	312
Aspirateur pour liquides	256
Bacs de rangement magnétiques	325÷326
Bédanes	479÷532
Beta Abrasives	533÷558
Beta BM	46÷47
Beta Chemicals	118÷125, 160÷166, 170÷208, 229÷238
Beta Collection	314÷318
Bloccante	347
Boîtes à outils	401, 403÷409, 415÷420, 462÷464
Borne terminale	62, 66÷68
Brosses	361, 363
Brucelles	568÷584
Burettes	588÷594
Burins	562÷567
Burins plats de carrossier	715÷726
Caméra thermique	564
Casse-écrous	32
Chaînes et colonnes de délimitation en plastique	354÷361
Chariot pliable	9
Chariot à plate-forme électrique	9, 278, 304
Chariots porte-coffres	31
Chariots porte-outils	210÷211
Chasse-clous	398
Chasse-cônes Morse	367, 398
Chasse-goupilles	380÷382, 397÷400, 448, 469
Chaussures de sécurité	369
Cisailles	668
Ciseaux	371÷380, 386÷394, 421÷422, 443÷444, 462÷465
Ciseaux de maçon	384÷385
Ciseaux d'électricien	368÷370, 392
Clé polygonale pour échafaudage	668
Clés à béquilles à cardan et pour vis Torx®	135÷136
Clés à douilles articulées	30
Clés à douilles emmanchées	360÷363
Clés à ergots	113÷114, 288
Clés à fourches	70÷78
Clés à fourches à patte de coq avec carré femelle 3/8"	15
Clés à frapper	86÷93
Clés à molette	93÷99, 287÷288, 307
Clés à pipe	99÷109, 288, 308
Clés à tuyauter	109÷110, 308÷309
Clés à tuyauter à cliquet	110÷111
Clés de serrage angulaire	25÷27, 294
Clés de serrage antidéflagrantes pour soupapes de sûreté	13÷15, 282, 286, 293, 305
Clés dynamométriques	14÷15, 305÷306
Clés dynamométriques sans accessoire	112÷113, 294, 309
Clés en tube	23÷24, 307



Clés mâles 6 pans en T et pour vis Torx®	114, 116÷117
Clés mâles 6 pans et pour vis Torx®	115÷117, 287, 309
Clés mâles 6 pans et pour vis Torx® à poignée en T haute performance	112÷113, 118
Clés mâles coudées XZN®	96
Clés mixtes	11÷13, 25÷26, 294, 300, 305
Clés polygonales	309
Clés pour tableaux	57÷69
Clés serre-tubes	21÷23, 293, 301
Coffres	18÷23
Coffres industriels	23
Coffres porte-outils	17, 306
Coffrets de tarauds	210
Colle instantanée	17
Colliers en nylon	15÷17, 286, 293, 305÷306
Combo coffres et accessoires	24, 286, 293, 301, 307
Comparsateurs	565
Compas	239÷240, 312
Compositions d'outils	364÷367
Compositions d'outils en plateaux thermoformés	212
Compteur de litres numérique pour huile	214
Contrôleur de couple électronique avec transducteur Dynatester	227
Cordeau et poudre à tracer	218
Cosses cœur	256
Cosses préisolées	34÷35
Coupe-boulons	241
Coupe-câbles	238÷239
Coupe-câbles gros effort	567
Coupe-tube PVC à cliquet	566÷567
Coupe-tubes	570÷572, 583
Coussin élévateur	576÷580
Couteaux	253
Crayon de menuisier	313÷324
Cutters à lame sécable	198÷204, 208
Cuve de lavage à ultrasons	200÷202, 208
Débloquant spray	44
Dégivrant	208
Dénudeurs et pinces à dénuder	202÷203
Détergents	171÷172
Disques abrasifs	198÷204
Disques lamellaires	244
Disques magnétiques avec poignée pour le soudage	706÷709
Doigts magnétiques flexibles	590÷593
Doigts mécaniques flexibles à griffes	593
Douilles à chocs, accessoires et compositions	47÷51
Douilles, accessoires et compositions 1"	219
Douilles, accessoires et compositions 1/2"	215÷216
Douilles, accessoires et compositions 1/4"	136÷137, 241, 295, 312
Douilles, accessoires et compositions 3/4"	136÷137, 289, 295
Douilles, accessoires et compositions 3/8"	563
Ébavureurs tonneau	41
Élévateur pour vélos	135÷136
Elingue à chaîne de levage	595÷609
Embouts pour visseuses et porte-embouts	46, 49
Emporte-pièces	33÷34, 294, 301, 307
Enrouleur automatique pour l'air comprimé ou l'eau froide	149
Enrouleurs automatiques avec baladeuse	158÷159
Equerres	149
Équerres magnétiques pour postes à souder	145÷148



Établi mobile	152÷156
Établis	157÷159
Étau magnétique pour le soudage	155÷156
Étaux parallèles d'établi	150
Étaux pour tubes, pour plomberie	60
Extracteurs à 2 griffes	148
Extracteurs à 3 griffes	149
Extracteurs de vis et goujons endommagés	682÷685
Extracteurs hydrauliques	61
Extracteurs pour moyeux et tambours de roues	213
Extracteurs, divers	565÷566
Fers à souder	680÷682
Fers à souder et embouts	291
Fers à souder les tubes d'évacuation en PE, PP, PVC et PEHD	564
Filières et compositions	594
Forets à dépointer en acier HSS	27÷35
Forets coniques	228
Forets laminés en acier HSS	78÷85, 155, 287
Forets pour percer, fileter et aléser	150
Frein filet	567
Gaines isolantes	242÷247
Gamme blister	123, 218, 309
Gants isolants	161, 220÷224, 312
Graisse spray	216÷217
Grattoirs	144
Hache antidéflagrante	162, 166÷169, 296÷297, 302, 310÷311
Hélicoïdes	208
Inserts 4mm	254
Jauges de filetage	44÷47
Jauges d'épaisseur	215
Joint liquide	169, 311
Kit de réparation des pièces en plastique	169, 311
Lames réversibles	169÷170, 297, 311
Lampes	150÷151
Leviers	211
Limes	236
Lunettes de protection	69
Magnétiseur/démagnétiseur	215÷216
Maillets	533÷558
Manille de levage	573÷576
Marche pied	54÷56
Marteaux	253
Masque pour soudage	35
Masses	209
Massettes	590
Mastic silicone	678÷679
Mesures Météorologiques et de lumières	232÷233, 297
Mètres à ruban et pliants	594
Meules abrasives sur tige	669
Micromètres	228÷229
Micro-tournevis	312
Miroirs d'inspection	692÷693
Montures et lames de scie	405, 430, 451, 470
Multimètres	238
Multiplicateurs de couple	685÷689
Nettoyant spray	225
Niveaux	312
Outils à batterie	132

Outils anti-chute	236
Outils antidéflagrants	132
Outils Électroportatifs	127÷128, 140÷143, 289÷290, 296, 310
Outils en acier inoxydable	234
Outils filaires	130÷132, 193, 295
Outils isolés 1000V	128÷129, 173, 294÷295, 309
Outils pneumatique et accessoires	585÷587
Outils pour motocycles	142÷143
Outils pour vélos	594
Palans	253
Panneaux d'avertissement et d'interdiction	692
Parois porte-outils	129÷132, 289, 295, 310
Pelle antidéflagrante	236
Pic antidéflagrant	139÷140, 289, 296, 310
Pieds à coulisse universels	126÷127, 289
Pince à plier	256
Pince à poinçonner	325
Pince emporte-pièces 6 diamètres	227
Pince pour câbles	325
Pince pour colliers et colliers	27÷28
Pince pour soudure	163
Pince pour soulever les tôles	256
Pinceau de nettoyage	252
Pinces à becs longs	354÷355
Pinces à cintrer	377÷378
Pinces à cosses et cosses	377÷378, 477
Pinces à freiner	238, 264
Pinces à riveter et rivets	383
Pinces ampérométriques	585÷594
Pinces coupantes de précision	393
Pinces coupantes diagonales et frontales	193
Pinces de précision	566÷567
Pinces multiprises entrepassées	36÷40
Pinces pour circlips intérieurs	47
Pinces universelles	215
Pinces-étaux	41
Pistolet à huile	220
Pistolets à silicone	9, 304
Pistolets de vernissage	680, 702
Pistolets pour colle	218
Pistolets thermiques	213
Plateaux thermoformés porte-outils	173, 184, 220, 239
Plomberie, divers	214, 297
Pointeaux	85
Pointes	166
Pointes à tracer	225÷227
Pompe à graisse à levier	584
Pompe oléohydraulique	581÷583
Pompes à dessouder	250÷252
Pompes à graisse à levier	252÷253
Pompes pour barils	31
Porte-flacons	565
Porte-outils avec ceinture	10, 125, 218, 292, 300, 304, 312
Postes à souder	161
Presses d'assemblage	217
Produits électriques	624÷649
Protection pour coffres	224
Rapporteur d'angles	262÷264



Rapporteurs d'angles simples	51÷53
Réglets	224
Renvoi d'angle	209
Réparation automobile	563
Roues à lames et tissu non tissé	565
Rouleaux antigaspillage	566
Ruban isolant	229
Sac à dos porte-outils	706, 710÷713
Sacoques porte-outils	610÷623; 669÷670
Sangle en velcro	281÷282
Sangles et élingues de levage	587
Scellant à filet	219
Scie égoïne à bois	224, 312
Scies et fraises trépan et accessoires	224÷225, 312
Seringue à huile	219
Serre-joints et presses à vis	138÷139
Servantes mobiles d'atelier	219
Siège mobile d'atelier	212÷213
Silicone spray	253
Solutions pour le point de vente	333
Sonde tire-fils en nylon	235
Spatules	138, 289
Spot à LED	135
Spray imperméabilisant	28÷32, 307
Support pour clés à chocs	263, 276, 291, 409, 726
Support-rouleaux de papier	291
système d'ancrage	263
Tachymètre digital	134
Tapis de travail	672÷677
Tapis isolant	224
Tapis pour protection des genoux	589
Tenailles	236
Tendeurs pour cordes et accessoires	235
Testeur de tension	28
Thermomètres	242÷243
Tire-ressorts	218
Torches	355÷356, 359÷361, 395÷396
Tournes-à-gauche et porte-filières	134, 310
Tournevis à frapper	133÷134, 289, 295, 301
Tournevis à zone de frappe	143÷144
Tournevis BetaEVOX	10
Tournevis BetaGrip	313÷321
Tournevis BetamaX	322÷325
Tournevis coudés	292÷298
Tournevis détecteurs de tension	304÷312
Tournevis dynamométriques	299÷303
Tournevis électrique EVOX-E	285÷291
Tournevis pose-vis	280÷284
Treuil manuel et accessoires	274÷279
Valises porte-outils	327÷350
Valises porte-outils	351÷357, 364÷366
Ventouses	260÷261
Vérin hydraulique	237
Vêtements techniques	122
Vidéoscope électronique	358
Zinc spray	567

Automotive



Aléseuses pour le nettoyage des sièges des injecteurs	121
Autoscope	198
Barre télescopique	238
Boosters de démarrage	194÷195
Centreurs d'embrayage	172
Chandelles	266
Chargeurs de batterie	195÷197
Chariot de déplacement véhicules	266
Chariot de déplacement véhicules	265
Chariot pour maintenance des boîtes de vitesses et transmissions	400
Chevalets pour motos	274÷275
Clé pour démontage/montage turbines	182
Clé pour le démontage des bras du volant	207
Clés à bougies	118÷119
Clés en croix pour écrous de roues	124
Clés pour bouchon de trappe de réservoirs de carburant	185
Clés pour capteurs de température	120÷121
Clés pour filtres à huile moteur	187÷191
Clés pour filtres diesel	190
Clés pour raccords d'injecteurs	174
Clés réversibles pour bouchons de vidange	191÷192
Colliers à segments	173
Compresseurs pour ressorts d'amortisseurs	205
Compressiomètre pour moteurs à essence et Diesel	122
Couchettes d'atelier	263÷265
Cric hydropneumatique	273
Cric rouleur hydraulique à roues	271÷272
Crics bouteilles hydrauliques	266
Crochets pour traction des ressorts	171
Cuve de lavage des pièces	261÷262
Cuves de récupération des liquides	255÷256
Détecteur de signal	234
Douilles à chocs à contrôle de couple	77
Douilles à chocs pour écrous de roues	72÷73
Douilles à chocs pour écrous de roues Isuzu	76
Douilles de serrage pour écrou de moyeu	123
Douilles pour axes de ressort à lames	206
Douilles pour injecteurs Diesel	119
Douilles pour sonde Lambda	119
Élévateur hydraulique pour le montage/démontage des roues des poids-lourds	266
Emportes-pièces pour capteurs de stationnement	165÷166



Entonnoir	229÷230, 312
Extracteur pour lèche-vitres	237
Extracteurs de rotules	207
Extracteurs pour joints homocinétiques	207
Flacons de remplissage pour batterie	229
Grue hydraulique pliable	267
Injecteurs à percussion pour roulements coniques et déflecteurs d'huile	208
installateur pneumatique talon de pneus	346
Jauge de profondeur pour le contrôle d'usure des pneus	218
Jauges d'épaisseur pour carrossiers	162
Kit de débosselage	162÷164
Kit outillage pour blocage des poulies de distribution	175
Kit rive/dérive chaînes	278
Lavage de voiture intérieur/extérieur	255, 262, 346, 609
Lèves pare-brise	237
Lève-soupapes	173
Levier dépose brides d'amortisseur	207
Levier pour boîtes de vitesses DSG	172
Leviers démonte-pneus	122÷123, 283
Limes de carrossier	161
Marteaux de carrossier	162
Miroir pour la détection des bosses	163
Nettoyeur de cosses de batterie	225
Outil pour extraire les joints	203
Outil pour positionner les pistons de frein à disque	178
Outils dépose-autoradios	237
Outils pour déblocage des connecteurs électriques	193
Outils pour enlever les airbags	172
Outils pour extraction bobines de bougies	181
Outils pour extraction injecteurs Diesel Common Rail	121
Outils pour installations de climatisation	186
Outils pour le contrôle de l'étanchéité de l'installation de refroidissement	231
Outils pour le démontage des bougies de préchauffage	121
Outils pour le démontage des silentblocks	208
Outils pour remplissage filtres gasoil	184
Outils pour valves pneus	124÷125
Palettes de carrossier	161
Pèse-acides	231
Pèse-antigel	231
Pieds à coulisse pour disques et tambours de freins	210
Pince à joncs extérieurs	173
Pince à masses d'équilibrage	125
Pince à relais	192÷193
Pince pour agrafes	236
Pince pour caches-écrous de roues	124



Pince pour joints d'étanchéité de soupapes	174
Pincés à durites	184
Pincés coupe-tubes d'échappement	182
Pincés d'extraction de clips	182
Pincés pour colliers auto-serrants	179÷180
Pincés pour connecteurs de bougies	181
Pincés pour garniture de frein	178
Pincés pour raccords d'essence	185
Pistolet de gonflage	345÷346
Pivots guide pour montage roues	124÷125
Plaque modulaire en aluminium	230
Pompe à tarer les injecteurs Diesel	122
Poste de recharge de climatiseurs	257÷259
Poste de travail mobile pour instruments de diagnostic	397
Poste pour la maintenance de la boîte de vitesses automatiques	259÷260
Presse hydraulique	269÷270
Protections auto	263
Protections pour roues	124
Purgeur de freins pneumatique par dépression	177
Récupérateurs para gravité	255÷256
Rodoir de soupapes pneumatique	173
Sableuse d'établi	261
Spatules en acier inox	161
Spotter sur chariot pour carrossiers	164
Stabilisateur de tension	198
Stations de lavage des composants moteurs	262
Supports moteur	267
Tas de carrossier	160÷161
Testeur de tension	193
Testeur numérique de pression et compression	175
Testeur pour batteries et installations de recharge	197÷198
Transpalette manuel	273
Ventouse de débosselage pneumatique	164
Vérin hydraulique de fosse et sous-pont	267÷268

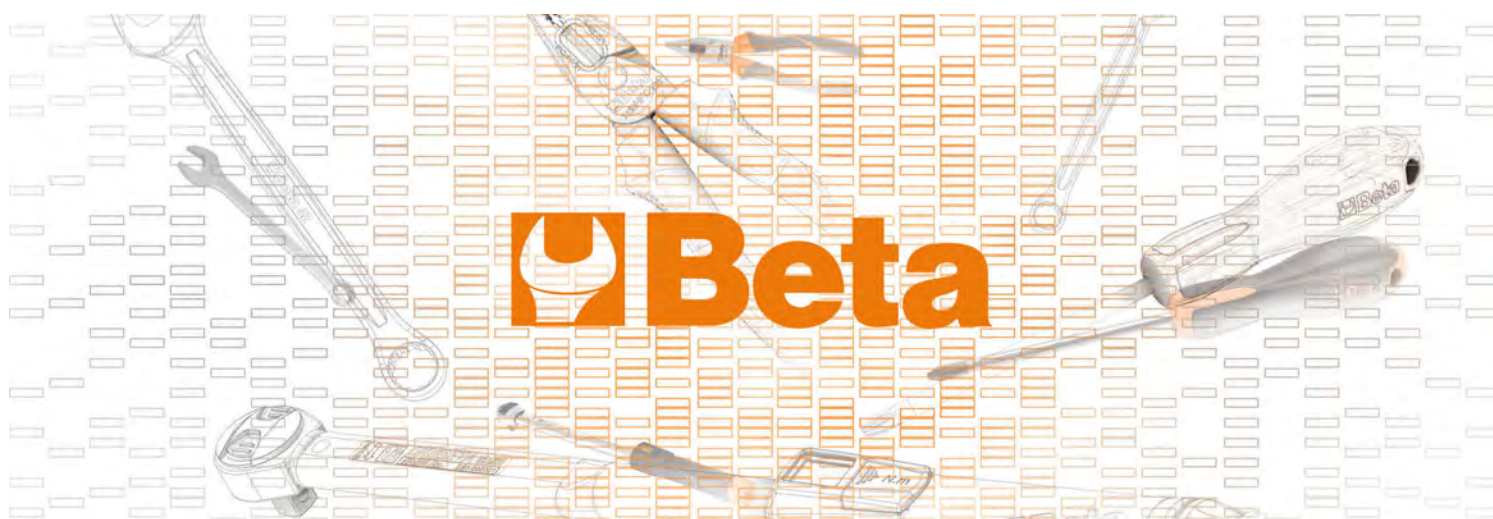

INDEX ALPHANUMÉRIQUE

1					
100	24	1010	128 1078	132 1122K	601 1150GBMK 602
100/KIT	24	1010BM	128 1080D	132 1123	136 1150GK 602
110BA	307	1010MQ	289 1081	133 1123K	601 1150HPC 140
110MQ	286	1031/S4	128 1082	133 1124	136 1150K 602
111CM	24	1032	128 1082BA	310 1124K	601 1150MQ 289
111E	24	1032BA	309 1082BM	133 1125	136 1153 140
111EN	24	1032K	600 1082BMK	600 1126	136 1162 140
111ER	24	1033	128 1082G	133 1127	136 1162BA 310
120	25	1033K	600 1082GBM	133 1128BAX	136 1162BM 141
120/B6N	25	1034	128 1082GBMK	600 1128BM	137 1162BMK 602
123/K4	25	1034K	600 1082GK	600 1128BMX	136 1162G 141
123/K4	597	1034L	129 1082K	600 1128BMX/F	136 1162GBM 141
123E1/4	25	1036	129 1082MQ	289 1128BMX	601 1162GBMK 602
123Q1/2	25	1036BA	309 1084	133 1128BSX	137 1162GK 602
123Q1/4	25	1036K	600 1084BM	133 1128BSX	601 1162K 602
123Q3/8	25	1037	129 1084BMK	601 1128FX	137 1162MQ 289
141	25	1037K	600 1084G	133 1128FXS	137 1164 141
141/B	25	1038	129 1084GBM	133 1128MQ	289 1164BM 141
141/S	25	1038K	600 1084GBMK	601 1129BM	137 1164BMK 602
142	25	1039	129 1084GK	601 1129BMK	601 1164K 602
142/B	26	1044N	129 1084K	600 1130BMX	137 1164MQ 289
142/S	26	1044NK	600 1084MQ	289 1130BMX	602 1166 141
142/SC9I-E	26	1046BA	310 1088	133 1131CK	137 1166BA 310
142AS	26	1047	129 1088BM	133 1132	138 1166BM 141
142AS/S	26	1047BM	129 1088BMK	601 1132BM	138 1166BMK 603
142C	26	1048BM	130 1088K	601 1132BMK	602 1166G 141
142C/A	26	1048MQ	289 1088MQ	289 1132K	602 1166GBM 141
142K	597	1048N	130 1092V	134 1132MQ	289 1166GBMK 603
142MC	26	1048N/D3	130 1094V	134 1133	138 1166GK 603
142MC/SC9I-E	26	1048NK	600 1095N	134 1133RL	138 1166K 602
142SN	26	1048VN	130 1096	134 1134	138 1166MQ 289
142SN/S	26	1048VNK	600 1096K	601 1134A	138 1168 141
142SN/SC9	26	1050	130 1098	134 1134RL	138 1168BM 142
186	27	1051	130 1098K	601 1137BA	310 1168BMK 603
187	27	1051GM	130 1098PL	134 1137BA/RC	310 1168G 141
187/B5	27	1051L	130 1098PLK	601 1142BM	138 1168GBM 142
188	27	1051XL	130 1100BA 600	310 1142BMK	602 1168GBMK 603
192	27	1052	130 1101	134 1142MQ	289 1168GK 603
192/S2	27	1052BA	310 1101R	134 1143	138 1168K 603
192/S2	597	1052K	600 1102	134 1143R	138 1168MQ 290
194	27	1053	131 1103	134 1144D	138 1169/D3 142
195	27	1054	131 1103R	134 1144D/RG	138 1169BM/D3 142
195/B5	27	1055	131 1104	135 1144D/RL	138 1169G/D3 142
195AS	27	1055D	131 1104R	135 1144G	138 1169GBM/D3 142
195AS/B	27	1056	131 1105	135 1144G/RL	139 1169MQ/D2 290
195K	597	1057A	131 1105/C10T	135 1144L	139 1169N/D4 142
195P	27	1058	131 1105/C16T	135 1144T	139 1171BM 142
195P/B5	27	1059	131 1105/C32T	135 1148A	139 1172BM 142
1002	127	1060	131 1105AD-50	135 1148A/R	139 1172BM/P 143
1008	127	1061	131 1105T20	135 1148B	139 1173BM 143
1008BM	127	1062	131 1105T30	135 1148B/R	139 1175BM 143
1009	127	1062AL	132 1105T50	135 1148P	139 1177BM 143
1009L/A	127	1062GM	132 1112	135 1149F	139 1177BM/Z 143
1009L/B	127	1063	132 1112K	601 1149F	602 1178BM 143
1009L/C	127	1064	132 1114	136 1150	139 1178BM/P 143
1009L/D	128	1065F	132 1118	136 1150BA	310 1182BM 143
1009L/DP	128	1065P	132 1120A	136 1150BM	140 1183BM 144
1009L/DP-S2	128	1066	132 1120ARL - ARG	136 1150BMK	602 1184BM 144
		1067	132 1122	136 1150G	139 1185BM 144
		1077	132 1122 - 1125MOL	136 1150GBM	140

INDEX ALPHANUMÉRIQUE

1186BM	144	1253A	150	1267TX/D7	155	1293BX/DA	614	1360G	162
1188BM	144	1254	150	1267TX/S13	155	1293BX/DD	614	1361/C12	162
1190BM	144	1254	604	1267TXK	604	1293BX/DE	614	1361/K9	162
1191BM	144	1256/20	150	1268RTX	155	1293BX/DF	614	1362B	163
1191BM/L	144	1256/30	150	1268RTX/S8	155	1293ES	158	1364SCP	163
1191R/5-M	144	1256/C36-2	150	1268RTXK	604	1293ES/S7	158	1364SE	163
1200MS	144	1256LP	150	1269N/PZ	155	1294	158	1364SP	163
1201E	145	1256PE	150	1269N/PZK	604	1294/S7	158	1364SR	163
1201E/DZ	146	1256PH	150	1269PZ	155	1294K	605	1364SV	163
1201E/K	603	1256PZ	150	1269PZ/S4	155	1294L	158	1365/K13	163
1201E/S6	145	1256RTX	150	1269PZK	604	1295	158	1365P10	163
1201EN	145	1256TX	150	1270BA	310	1295/C14	159	1366/K5	164
1201EN/K	603	1257BE	151	1272BA	310	1297TX	159	1366A	163
1202E	146	1257ES	151	1272MQ	290	1297TX/D6	159	1366B	164
1202E/K	603	1257ESB/S8	151	1272MQ/S	290	1297TX/L	159	1366KF	164
1202E/S4	146	1257LP	150	1272MQF	290	1297TX/L-S5	159	1366S/R1	164
1202EL	146	1257LP/S	151	1273MQ/D6	290	1297TX/S12	159	1366S/R10	165
1202EN	146	1257LPH/S8	151	1273MQ/E1	614	1298RTX	159	1366S/R11	165
1202EN/K	603	1257PH	151	1273MQ/E4	614	1298RTX/S8	159	1366S/R12	165
1203/E10P	612	1257TX	151	1273MQF/D6	290	1298RTXK	605	1366S/R13	165
1203/E1P	612	1257TX/S	151	1274MQ	290	1299N/PZ	159	1366S/R14	165
1203/E4P	612	1260	152	1274MQ/S	290	1299N/PZK	605	1366S/R2	164
1203/E5P	612	1260/S6	152	1274MQF	290	1299PZ	159	1366S/R21	165
1203E/D	146	1260E	153	1275MQ/C	290	1299PZ/S6	159	1366S/R22	165
1203E/S	146	1260EK	604	1276MQ/C	291	1299PZK	605	1366S/R24	165
1204E	146	1260K	604	1277BA	310	1302	160	1366S/R25	165
1204E/K	603	1260MC	153	1279MQ	291	1303	160	1366S/R26	165
1204E/S5	146	1260N	152	1279MQ/F	291	1304	160	1366S/R3	164
1204EL	147	1260NK	604	1279MQ/S	291	1305	160	1366S/R4	165
1205E/ES	147	1262	153	1281/B28A	156	1305Z	160	1366S/R5	165
1205E/ES-S8	147	1262/S4	153	1281BG	155	1306	160	1366S/R6	165
1206E/BP	147	1262E	153	1281BG/A9	156	1307	160	1366S/R7	165
1206E/BP-S7	147	1262EK	604	1281BG/B28NA	156	1308	160	1366S/R8	165
1207E TX/K	603	1262K	604	1281BG-TX/A8	156	1310	160	1366S/R9	165
1207E/TX	147	1262L	153	1281LP	155	1312	160	1366SH	164
1207E/TX-D	147	1262MC	153	1281LPH	156	1314	161	1366SH/C	164
1208E RTX/K	603	1262N	153	1281PB	155	1326	161	1366SL	164
1208E/RTX	147	1262NK	604	1281PE	156	1327	161	1366ST	164
1208E/RTX-D	147	1263/D...	153	1281PH	156	1328	161	1367/K10	166
1209E PZ/K	603	1263/E39	613	1281PM	155	1329	161	1367/K4	166
1209E/PZ	147	1263/E40	613	1281PZ	156	1330	161	1367/S4	165
1209E/PZ-S4	147	1263/E50	613	1281RTX	156	1331	161	1368	166
1209EN/PZ	147	1263/E62	613	1281TX	156	1335BM	161	1368G/C2U	166
1209EN-PZ/K	604	1263/E70	613	1290	157	1337/S5	161	1368G/CV	166
1210E/GE	148	1263/E74	612	1290/S	157	1338	161	1368G/K400	166
1211E/GE	148	1263/E78	612	1290K	605	1338A - 1338B	161	1368G/OD	166
1229LP/S	148	1263/E85	613	1290K/INOX	605	1338R9 - 1338R12	161	1368G/SD	166
1229LPH/A6	148	1263/S12	154	1290N	157	1342	161	1369/C11	167
1236B	149	1263MC/D8	154	1290NK	605	1342PM	161	1370	167
1238B	149	1264	154	1292	157	1342PMR	161	1370/MR...	167
1241	149	1264/S5	154	1292/S4	157	1343	161	1370BA	310
1242	149	1264K	604	1292K	605	1344	162	1370BA/MR	311
1243/D7	149	1264L	154	1292K/INOX	605	1344A/VW	162	1370BA/PL	311
1243/S11	149	1265ES	154	1292L	157	1345	162	1370F	167
1243LP/D6	149	1265ES/S8	154	1292N	157	1351	162	1370F/MR...	167
1250	149	1266BP	154	1292NK	605	1353	162	1370FT	167
1251	149	1266BP/S8	154	1293/D...	158	1357Z/45	162	1370T	167
1252/S5	149	1267MC/TX	155	1293/S...	158	1359T	162	1374F	167
1253	150	1267MC/TX-D7	155	1293BP	158	1360/K6	162	1374F/MR...	167
1253	604	1267TX	154	1293BP/S	158	1360/KP3	162	1375	168

INDEX ALPHANUMÉRIQUE

1375/MR	168	1435/1	172	1467T/C6	178	1477D/S5	182	1488/1	187
1375A	168	1435/1R	172	1467TU	178	1477K/7	182	1488R...	187
1375B	168	1435R	172	1470	178	1478	182	1489/31T	187
1375BA/PL	311	1437/C12	172	1470FT	178	1478/K3	183	1489/33	187
1376X	168	1438	172	1470PF	178	1478NSS	183	1489/33P	188
1376X/MR	168	1438DCT/S	173	1471	178	1478SP	183	1489/C14	188
1376XT	168	1438DSG	172	1471A	178	1478T	183	1489/E	188
1376XT/MR	168	1438EVO	172	1471CF	179	1479	183	1489/Y	188
1377	168	1438K/DSG-2	172	1471CM	179	1479/B27	183	1489R	188
1377/MR...	168	1438K/PWR	172	1471CM/E11	179	1479L/K4	183	1490	188
1377BA	311	1438R	172	1471D2	179	1479L/S2	183	1490/R1 - 1490/R2	188
1377BA/PL	311	1439/K7	173	1471GF	178	1479LB/C5	183	1490F	188
1377T	168	1440/...	173	1471M/50	178	1479LV/S3	183	1491	188
1378	168	1445/1 - 1445/2	173	1471M/C22	178	1479ML/B17	183	1491A	188
1378/MR...	168	1452K	173	1471M/P	178	1479ML/S3	183	1491R	188
1379BA	311	1452PN/K	173	1471M/W50	179	1479N/S5	184	1491T	188
1379F	168	1454P	173	1471PN/B1	179	1479RB/1	184	1492/1 - 1492/2	189
1379F/MR...	169	1455SVP	173	1471PN/B2	179	1479RB/2	184	1492T	189
1380	169	1455SVP/R...	173	1471PN/B3	179	1479RB/3	184	1493	189
1380/MR...	169	1457/B4	173	1471PN/B4	179	1479U/13	184	1493/C19	190
1380BA	311	1458	173	1471PN/B5	179	1479U/32	184	1493/C30	189
1380BA/MR	311	1460F	174	1471PT/C5	179	1480	184	1493/C7	190
1380BA/PL	311	1462/EI	174	1471T/C5	179	1481/C12	184	1493/PF	189
1380S	169	1462/KI	174	1472	179	1481K/S4	184	1493/S-U	191
1380S/MR...	169	1462/KU	174	1472AU	179	1481PL	184	1493AL	189
1380T	169	1462/MB	174	1472AU/P	180	1481PL/S3	184	1493AL 4S	189
1381	169	1462AD/BSC	174	1472AU/RP	180	1481T/C12	185	1493AL CF	190
1381/MR...	169	1462AD/SMN	174	1472B/RNLT	180	1482	185	1493B	189
1381BA	311	1462CF	174	1472FC	180	1482/8 - 1482/10	185	1493B/S5	189
1381BA/MR	311	1462CF/C6	174	1472FC/GE	180	1482A/1	185	1493C/ADB	191
1381BA/PL	311	1462CF-SN	174	1472FC/L	180	1482A/3	185	1493DSG	190
1381T	169	1462CF-SN/C6	174	1472FCA	180	1482A/5	185	1493FF	190
1385	169	1463/KIT	175	1472FCL/RP	180	1482B	185	1493FT	190
1385/MR	169	1464ADB	176	1472H	180	1482C	185	1493H	190
1390	169	1464AP	175	1472MT/VW	180	1482D	185	1493HK	190
1390/MR...	169	1464AP T	175	1472R/AU	180	1482SN	185	1493J	190
1390BA	311	1464AP T16X12	175	1472TM	180	1483K/12	185	1493U/ADB	191
1390BA/R	311	1464APB	176	1472VW	180	1483K/22	186	1493VW	190
1390N	170	1464CBD	175	1473	181	1483KV-PT/S7	81	1493X	191
1390NR	170	1464FAP	176	1473A	181	1484	186	1493Y	191
1390R	170	1464FG	176	1473FN	181	1484PSA	186	1494	191
1391	170	1464FG/CP4	176	1473P	181	1485/KIT	186	1494/C14A	192
1391A	170	1464IC	175	1473T	181	1485BP	186	1494BMW	191
1392	170	1464IC/RK	175	1474/C4	181	1485BPM	186	1494E	191
1392R	170	1464PB	176	1474DL	181	1485FCA/K2	186	1494FPC	191
1393	170	1464PF	177	1474E/VW	181	1485FCA/T	186	1494M	192
1410/M	171	1464PT	176	1474E/VW2	181	1485FCA/TS	186	1494MAN	191
1428	171	1464T	175	1474G	181	1485FRD/T	186	1494MRC	191
1428/SB11	171	1464T/SP80	175	1474L	181	1485MJ	187	1494Q	192
1428L	171	1464TDI	176	1475U	181	1485MRC/T	186	1494T	192
1428L/B3	171	1464VD	176	1476	182	1485PMTJ	187	1494T/C5	191
1429	171	1465	177	1476/RC	182	1485R	187	1494VW	191
1429/SB7	171	1466/C5	177	1476A	182	1485R/P10	187	1494VW/K	192
1430/...	171	1466L 11	177	1476A/RC	182	1485R/P17	187	1494VW/KT	192
1430/S	171	1466TLF	177	1476C/1	182	1485TC	186	1494XZN	192
1431/...	171	1467	177	1476GT	182	1485VAG	187	1495/C6	192
1431/C5	171	1467/RK1	177	1476PSA	182	1485VAG/K2	187	1495M	192
1433	171	1467/RK2	177	1476T	182	1485VLV/T	186	1495T	192
1433/C11	172	1467LF/2	177	1477/C10	182	1487/K2	187	1496/C	192
1435	172	1467LF/RC	177	1477D	182	1488 - 1488L	187	1497/C23	193

INDEX ALPHANUMÉRIQUE

1497/C94	193	1516/1 - 2 - 3	200	1565/1 - 2 - 3	207	1670	213	1703BA/A	312
1497/S3	193	1517	200	1566/GO1	207	1670A	213	1703BA/P	312
1497BS	193	1517C/...	201	1566N	207	1672	213	1703BA/PL	312
1497D	192	1518/...	201	1566P	207	1672A	213	1704	218
1497KB/S3	193	1518U/...	201	1566R	207	1674A	213	1704A	218
1497P	193	1519/...	201	1567	207	1674C	213	1704C	218
1497RC	193	1520/1 - 1520/2	202	1568	208	1676	213	1705	218
1497SS	193	1521/1 - 1521/2	202	1569/F	208	1678/C3	213	1705PT	218
1497TE	193	1528	202	1569/SB	208	1679	213	1706DGT	218
1498	193	1529	202	1569CP	208	1679/PR	213	1707	218
1498/12	195	1529/C7	202	1570/3	208	1680	214	1707A/1 - 2 - 3	218
1498/120A	197	1529/PG	202	1580/8I	208	1680A	214	1708/8 - 13 - 20	219
1498/12-24 R20	195	1529PI	202	1580GL	208	1680B	214	1709/10 - 1709/18	219
1498/16A	196	1530/C16	202	1585/5I - 6I - 7I	208	1680C	214	1710	219
1498/24	195	1530/C5	202	1585GI/5 - 6 - 7	208	1682	214	1712E/1 - 2 - 3	219
1498/25A	196	1531/C7	203	1589PI/50 - 100 - 150	208	1683	214	1712TF	219
1498/2A	195	1532	203	1589VI	208	1685/C7	214	1713M	219
1498/2A-8A-PR	196	1533/...	203	1590	209	1687/S4	214	1713M/K7	219
1498/40A	197	1533PR/1 - 2 - 3	203	1591	209	1687A	214	1714	219
1498/4A	195	1534/...	203	1593	209	1687AC	214	1715	219
1498/4A-8A CO	196	1535/C...	203	1594	209	1687D	214	1715B/R5L	219
1498/4A-8A CP	196	1539	203	1595	209	1687U	214	1715FL/A	219
1498/8A	196	1540	203	1599B	209	1688	215	1715FL/B	219
1498B12/R02	195	1542/1 - 1542/2	204	1599F	209	1688A	215	1715I	219
1498BC/12	194	1544/...	204	1599G	210	1688M	215	1715L	219
1498LT/12	194	1545/C5M	204	1599GI	209	1688PC	215	1715R/FL	219
1498LT/12-24	195	1547/C6	204	1599GR	209	1688PC/R	215	1716A	219
1498LT/12-R7	194	1547KP	204	1599P	209	1690F	215	1716P	220
1498LT/12-SF	194	1547P	204	1599T	209	1690L	215	1716R	220
1498MN/12-C	194	1547PC/2	204	1600Q 10	210	1691BM	215	1716U	220
1498MN/12-P	194	1547PL/2	204	1600Q 10	606	1691MG	215	1717A	220
1498MN/12-R	194	1549	204	1600Q 8	210	1692	215	1717B	220
1498MN/12-U	194	1550U	205	1600Q 8	606	1693	215	1717BA	312
1498PC	198	1550U/CGS-R	205	1602BA	312	1693	606	1717BA/1	312
1498SA/2A-4A	195	1550U/M	205	1603BK	606	1693L	215	1717C	220
1498SM	197	1550U/MRC-ABE	205	1603K	606	1693M	216	1717D	220
1498SM-A	197	1550U/MRC-C	205	1650	210	1694/L	216	1717T	220
1498SM-C	197	1550U/S...	205	1650FD	210	1694A/L	216	1717T RS	220
1498SM-CP	197	1550U/SS187	205	1650FT	210	1694B/L	216	1717T RT	220
1498ST/TB	198	1551/C20	205	1651DGTB	210	1695XS	216	1717V	220
1498ST/TB ROT	198	1552/C9	205	1651DGTB/IP	211	1696	216	1717V R	220
1498TB/12-24	198	1555/Q	206	1652	211	1696A	216	1718A...M	221
1498TB/6-12	197	1555/QS	206	1654	211	1696B	216	1718A...P	221
1499	198	1555C	206	1654DGT	211	1696D	217	1718A...Q	220
1500/...	198	1555S/BMW-RNT	206	1656	211	1696S	217	1718A...R	221
1500/SP	198	1556/1A	206	1657DGT/2	211	1697	217	1718A...S5	221
1500G/...	198	1556/2A	206	1658/...	211	1699L	217	1718A...T	221
1500N/...	198	1557	206	1658/C4	211	1699L/1	217	1718D...M	221
1500N/G...	199	1557/S3	206	1658DGTB	211	1699Q	217	1718D...P	221
1500N/SP	199	1557V	206	1658SP/1	212	1700N	217	1718D...Q	220
1501/1 - 2 - 3	199	1558/C13	206	1659	212	1700N/PM	217	1718D...R	221
1501G/1 - 2 - 3	199	1558/C4	129	1662/1 - 1662/2	212	1701_WARN	218	1718D...S5	221
1501Z/S - P - R	199	1558P	206	1662AN	212	1701BA	312	1718D...T	221
1502/...	199	1559	207	1662DGT/A	212	1701N	217	1719BA12	312
1505/C5	200	1559V/8T	207	1662SP0	212	1701N/PM	217	1719BA8	312
1505V	199	1560/2	207	1662SP2	212	1701NE/...	218	1719BM/RG	223
1506	200	1560A	207	1666	212	1701PMR	218	1719BM/RL	223
1508/1 - 1508/2	200	1561/...	207	1666A	212	1702N	218	1719BM/RP	223
1511/1 - 2 - 3	200	1562D	207	1668	212	1702N/PM	218	1719BM/RR	223
1515/1 - 2 - 3	200	1563/C4	207	1668A	213	1702PMR	218	1719BMA...B5	222

INDEX ALPHANUMÉRIQUE

1719BMA...M	222	1741U	226	1759HD/RR	231	1772M	238	1833M	243
1719BMA...P	222	1742AN	226	1759HD/TRUCK	232	1772R	239	1833MW	243
1719BMA...Q	221	1742AN/C	227	1759LR	232	1772R	607	1833RB-L/USB	242
1719BMA...R	222	1742AN/KR	227	1759TT	232	1772RL/2	239	1833S	243
1719BMA...S5	222	1742N	226	1760/IR1000	235	1773A	239	1833XL	243
1719BMA...T	221	1742N/C4	226	1760/IR1600	235	1773RL	239	1833XS/1	242
1719BMB/P	223	1742N/KR	226	1760/IR500	235	1773S	239	1833XS/2	242
1719BMC	223	1742R-A/M...	226	1760/OHM	233	1773S/RL	239	1833XSW	243
1719BMD...B5	222	1742R-AL/M...	226	1760/RMS	233	1774	239	1834RR	608
1719BMD...M	222	1749	227	1760/RSE	234	1774A	239	1836AW	243
1719BMD...P	222	1749A	227	1760/TC2	235	1774A/RL	239	1836B	243
1719BMD...Q	221	1749A/RB	227	1760B	233	1774S	239	1837C	244
1719BMD...R	222	1749A/RT	227	1760DGT	232	1776BA	312	1837F	243
1719BMD...S5	222	1749AC	227	1760DGT/2	233	1777BM	239	1837F/USB	244
1719BMD...T	221	1750	227	1760DGT-R3	234	1777BMT	239	1837M	244
1719BMR	223	1750CG	227	1760K	235	1777BMT	607	1837RB-F/USB	244
1719BMR/B3	223	1750KG10	228	1760LX	236	1777MQ/C	291	1837S	244
1719BMX...M	222	1750M	228	1760PA/80	234	1777MQ/U	291	1838/11LED	245
1719BMX...P	222	1750M3	228	1760PA/AC	234	1777RL/U	291	1838AM	245
1719BMX...Q	221	1750R/1 - 1750R/2	227	1760PA/AC-DC	234	1777T	239	1838COB	245
1719BMX...R	222	1750RC	227	1760PA/AC-DC2000	234	1777T	607	1838E	246
1719BMX...S5	222	1750RP/1 - 1750RP/2	227	1760PT	235	1778AN	239	1838E-BT	246
1719BMX...T	221	1750RT	227	1760R/TC2	235	1778AX	240	1838FLASH	244
1719R/...	223	1750TA	228	1760S	233	1778BS	240	1838P	245
1720/...	223	1750TLA	228	1760TMC	236	1778CM	240	1838POCKET	244
1720/B	223	1751CR	228	1760WMM	236	1778M7	240	1838RA/10-11LED	245
1720/S	223	1751N	228	1761	236	1778MT	241	1838RB/10LED	245
1720D/...	223	1752	228	1761RS/1	236	1778P	240	1838RB/FLASH	244
1720D/B	224	1754	228	1762	236	1778SCL	240	1838RR/11LED	245
1721/B6	224	1755C	229	1762K	607	1778SOS	240	1838RV/11LED	245
1723	224	1756	229	1763	236	1778V18	240	1838SLIM	245
1725	224	1756B	229	1763G/S500	236	1778X	240	1838SW	246
1725CR	224	1756C	229	1764/K5	236	1781	241	1838UV	246
1725MQ	291	1756C-2OR	229	1764/K5-R	236	1783	241	1839/R1	246
1726	224	1756D	229	1765/C24	237	1783	607	1839/R2	246
1726BM	224	1756D-2OR	229	1766	237	1784	241	1839/R4	246
1727	224	1756E	229	1766/8	237	1784BA	312	1839/R5	246
1727BA	312	1756G	229	1766A	237	1800/100	241	1839/R6	246
1727BM	224	1757	229	1766ER	237	1808	251	1839BRW	246
1728...	224	1757A	229	1766ER/VW	237	1812 150	251	1842	248
1728BA	312	1758	229	1766G	237	1814M	251	1842LED/ABM	247
1729CG	224	1758A	230	1766I	237	1820	251	1842LED/BM	247
1729DM 450	224	1758ADB-45°	230	1766L	237	1820 60	251	1843	248
1730	224	1758ADB-D	229	1766LI	237	1820 80	251	1844	248
1730M	224	1758B	230	1766T	237	1822	251	1844SCK	248
1730V 38	224	1758B/K5	230	1767A	238	1822 180	251	1845	248
1736A	224	1758B-1,6	230	1767B	238	1822 320	251	1846	248
1737	225	1758BA	312	1767PMC	238	1823 60	251	1846R-LED/BM	248
1737AC	225	1758B-RNT	230	1767PMR	238	1823R/60	251	1847	249
1737B	225	1758LG	230	1768	238	1824R	251	1848	249
1737BA	312	1758M	230	1770	238	1825B	251	1850D	325
1737NX	225	1758R	231	1770A	238	1827	251	1850E	325
1738	225	1758RD	230	1770BM	238	1827/K	252	1851VK	325
1739C	225	1758S	230	1770BM	607	1827F	252	1851VK-12C	325
1740AN	225	1758VT	231	1770RL	238	1827PC	251	1851VK-12V	325
1740B	225	1758VT/L	231	1771	238	1827PCL	251	1852 S-PIATTE	249
1741B	225	1759	231	1771BM	238	1827PFL	252	1852R1750	249
1741B/C5	225	1759A	231	1771HD	238	1830T	252	1852S-CC	249
1741BP	226	1759B	231	1771RL	238	1833L	243	1852S-CNT	249
1741RV...K	226	1759HD/3	231	1772H	239	1833L/USB	242	1852S-F	249

INDEX ALPHANUMÉRIQUE

1852S-FLESS	249	1885/C1-R3	258	1916G	348	1930CD	334	1945C/G...	342
1852S-KR/CNT	249	1885/C1-R4	258	1916GF	348	1930HLA	335	1945C/GP...	342
1852S-L	249	1885/C1-R5	258	1916GFE	348	1930LA	335	1945P	342
1860BH R/CM	252	1885/C1-R6	258	1916I	348	1930LH	334	1945P/S...	342
1860BH R/CS	252	1885/C1-R7	258	1916JF	348	1930PA	334	1945S	342
1860BH/120A	252	1885/C1-R8	258	1916JM	348	1930ZL	335	1945S/G...	342
1860BH/160A	252	1885/C2	258	1916P	348	1931AN10	336	1946	343
1860BH/200A	252	1885/C2-R1	258	1916S	348	1931CD10	335	1946C/T...	343
1860BHT R/CM	253	1885/C2-R2	258	1917F	348	1931CD13	336	1946C4,8	343
1860BHT R/CS	253	1885/C2-R3	258	1917JF	348	1931CD6	335	1946C7,8	343
1860BHT/160A	253	1885/C2-R4	258	1917JM	348	1932B10	336	1946KF	343
1860BHT/T	253	1885/C2-R5	258	1917M	348	1932B13	336	1946KF/M...	343
1860DM	253	1885/C2-R6	258	1917RG	348	1932RS13	336	1947	343
1860EI	253	1885/C2-R7	259	1917SP	349	1933	337	1947G	344
1860M	253	1885/C3	259	1917ST	349	1933AN90	337	1947G2	344
1860PMIG	253	1885/C3-R1	259	1918	349	1933AN90-H	337	1947H	343
1860RG	253	1885/C3-R10	259	1918N	349	1933I	337	1948	344
1860SQ	253	1885/C3-R2	259	1918R	349	1933IH	336	1948PR	344
1870	325	1885/C3-R3	259	1919F1/2	350	1933IL	337	1949BC	345
1870-20/5S	326	1885/C3-R4	259	1919F1/4	349	1933ILH	337	1949BC/RUL	345
1870-72 /FC	326	1885/C3-R5	259	1919F3/8	350	1933L	337	1949DGT/2	346
1870-72/FL	326	1885/C3-R6	259	1919FE1/4	349	1934BV	337	1949F2	345
1870I	325	1885/C3-R7	259	1919L	350	1934MAV	338	1949GPA	345
1872L	326	1885/C3-R8	259	1919ML	350	1934MAV70	338	1949GPN	346
1872L 35/5S	326	1885/C3-R9	259	1919RB-F	350	1935F	338	1949M	346
1872L 35/FC	326	1885/XC60	259	1919RB-FE1/4	349	1936/4A	338	1949P	345
1873	326	1889CF	257	1919RF-F	350	1936/5A	338	1949R	346
1873-30/5S	326	1889N	257	1919RF-FE1/4	349	1936/7A	338	1949T	345
1874	326	1893/1234YF	260	1919RM-F	350	1937	339	1949U5	344
1874-50/5S	326	1893/134A	259	1919RM-FE1/4	349	1937C...	339	1949U5/A	344
1874-50/FC	326	1893TR/1234YF	260	1919SC	350	1937K...	339	1949U5/B	344
1875LT	255	1893TR/134A	260	1921B1	330	1937KC	339	1949U5/C	344
1875SP/K3	255	1893TR/CI	260	1921M1	330	1937KL	339	1949U5/D	344
1877	255	1895 13	260	1921M2	330	1937KL-D	339	1949U5/E	345
1877A	255	1895 27	261	1921N3	330	1937M	339	1949U5/F	345
1877F	255	1895 6	260	1922P1	330	1937M-01÷11	339	1949U5/G	345
1877P	255	1895/RC	261	1922P2	330	1937N10	340	1949XS	344
1878 11	256	1895/S	260	1922P3	330	1937N10-GR	340	1950BZK	346
1878 2	255	1895G	260	1924B	331	1937N20	340	1951	346
1878 3	255	1897	261	1924CD	331	1937N20-GR	340	1951A	346
1878 30	256	1897/CRB	261	1924F	330	1937R/P	339	1952	347
1878 4	255	1897/G	261	1924XM	331	1938	340	1956 115-750W	322
1878 8	256	1897/MV	261	1927AN	333	1938R/L	340	1956 125-1400W	323
1879	256	1898/B	261	1927B	331	1938R/S5	340	1956 230-2400W	323
1879 6	256	1898/D	262	1927B/K5	331	1940	340	1966/910W	324
1879/FUEL	256	1898/K40	261	1927CD	332	1940/C6	340	1967/800W	324
1879R/K4	256	1898/M	262	1927CD/K3	332	1940/S5	341	1972/12V-10	315
1880	256	1898/S	262	1927G	333	1940E10	341	1972/20V-13BMC	316
1880ADB	256	1899A	262	1927P	332	1940E10/MT	341	1972/K12V-10	314
1881	256	1899SI	262	1927P/K3	332	1940E10/S...	341	1972/K12V-COMBO	314
1882N	256	1900M 8X15 - 1900M	347	1927SP-AM	333	1940E10/S5	341	1972/K20V-13BMC	316
1883N	256	10X15		1927XM	332	1940MT	341	1982/12V	315
1883NC	257	1900S 8x10	347	1927XM/K5	332	1940S...	341	1982/K12V	314
1884	257	1914	347	1928CD	334	1942A	341	1984 20V/1200BMC	318
1884/C12	257	1915B	347	1928DA	333	1942LR	341	1984 20V/600BMC	317
1884N/C8	257	1915C	347	1928DAL	333	1944A	341	1984/K1200	318
1885	257	1915C/L	347	1928K4	333	1944AR 2	341	1984/K600	317
1885/C1	258	1915D	347	1928P	334	1944N	341	1986/20V-125BMC	319
1885/C1-R1	258	1915E	347	1928XM	333	1944PA	342	1986/K20V-125	319
1885/C1-R2	258	1915E/XL	348	1930A	335	1945C	342	1989RCB	321

INDEX ALPHANUMÉRIQUE

1994B 20V-2AH	320	11204B	577	11491	584	2254T	263	330R/A	28
1994B 20V-4AH	320	11208A	577	11493	584	2258N-O	263	330R/I	28
1994B 20V-6AH	320	11208B	577	11495	584	2258RR	263	331C	28
1994BL 12V-2AH	315	11210A	577	11498	584	2300ST/KIT	370	332	29
1994C 20V	320	11210B	577			2400 RSC24/MP	378	334	29
1994CB 12V	315	11212A	577			2400 RSC24/PC	377	334R	29
1995MQ/G1 - G2	291	11212B	577	2001/B26	352	2400 RSC24/PD	377	334R/I	29
1995MQ/T	291	11214A	578	2001/BV	352	2400 RSC24/PF	377	336	29
1996MQ/GM	291	11214B	578	2001/BZ24 MQ	353	2400 RSC24/PF-	377	338	29
1996MQ/T	291	11214C	578	2001/BZ27 VU	353	2400 RSC24/PL	377	338R	29
1996SVG	291	11216A	578	2001/BZV	352	2400 RSC24/SPC	378	338R/I	29
11001	570	11216B	578	2002/BV12	353	2400 RSC24AXLP/CPR	376	338RP	29
11001H	570	11218A	578	2002/BV13	354	2400 RSC24AXLP/PF	376	339A	29
11003	570	11218B	578	2002/BV13	354	2400 RSC24AXLP/VL	377	339A/R	29
11011	570	11220A	578	2002/BV42	354	2400-COVER RSC24	393	340	29
11011H	570	11220B	578	2002/BV6	9	2400-COVER	393	340C	30
11018	570	11222	579	2002/BV7-ZIP	353	RSC24AXL		340C/KRL	30
11019	571	11230A	579	2002/BV8	353	2499PC	378	340RL	29
11021	571	11230B	579	2002/BV9	353	2499PF	378	341	30
11023	571	11232A	579	2002/BVL6	353	2499PF/M	378	341B	30
11024	571	11234A	579	2005MPU	354			341B/RL	30
11031÷11038	571	11240A	580	2005MPU/E	354			341B/RM	30
11032	571	11240B	580	2005PA/D	354	30	9	341RL	30
11034	571	11242A	580	2005PA/E	354	30BA	304	342	30
11035	571	11242B	580	2005PA/ET	354	31	9	342A	30
11037	571	11246A	580	2005PA/S	354	31/B6N	9	342A/MOL	30
11038	571	11248A	580	2005PA/U	355	31/B6N-LSE	9	342A/RL	30
11040	572	11248B	580	2009N/BV	354	31_serie	9	342MOL	30
11045	572	11259	580	2028/VV	355	31BA	304	342P	30
11046	572	11260	581	2028E	355	31BA/C	304	342P/RL	30
11048	572	11263	581	2029/VV	355	31BM	9	342RL	30
11049	572	11264	581	2029E	355	31BM/D6	9	345	31
11050	572	11265	581	2029EM	355	31L	9	345C	31
11069	572	11266	581	2032/TE	356	31SE	9	345SB	31
11100	573	11268	581	2032/TV	355	32	9	345SB/R	31
11101	573	11271A	581	2033L	356	32AU	9	345SB2	31
11102	573	11271B	581	2033L/VV	356	32AUR	10	345SC	31
11105	573	11271C	581	2036/TV	356	32BA	304	345SI	31
11106	573	11276A	581	2036E	356	33LT	10	345SI/R	31
11107	574	11276B	581	2037/TV	356	33NR	10	345U	31
11110	574	11276C	581	2038/TV	356	34	10	345U/A	31
11111	574	11300A	582	2041UC	357	34BA	304	349	31
11115	574	11300B	582	2051N	357	35	10	349/SMAS	31
11116	574	11300C	582	2055HB	357	35PM	10	349/SMM	31
11120	574	11300D	582	2080/D10	357	35PMR	10	350	32
11121	575	11300E	582	2080/V12	357	36	10	351C	32
11125	575	11300F	582	2080/V12-...	357	37	10	351P	32
11130	575	11300G	582	2080/V6	357	37PM	10	352C/U	32
11131	575	11320	582	2080/V6-U	357	37PMR	10	352U	32
11132	575	11411	582	2080/VG	262	38/DS1	611	355	32
11135	575	11415B	582	2109MT ID/1	360	38/DS2	611	357F3	32
11140	576	11420B	583	2115P L-MQ32	362	38_serie	10	357R/F3	32
11141	576	11431	583	2115PI/BIKE-HOME	361	39BA	305	358	32
11145	576	11440A	583	2250-O	262	310	27	358RL	32
11200A	576	11440B	583	2252	262	310/C8	28	359	32
11200B	576	11440C	583	2252KR4	262	310B	27	359CH	33
11202A	576	11450A	583	2254A	263	311	28	360	33
11202B	576	11450B	583	2254C	263	330	28	360R/...	33
11202C	576	11450C	583	2254F	263	330BA	307	361N	33
11204A	577	11488PF	584	2254K	263	330BA/2R	307	362	33
				2254SM	263				

362R/...	33	3010/T...	266	3040C/S2	274	3500/P-M	385	4		
363	33	3010H	266	3041C	274	3700/PC	388			
363BA	307	3010V	266	3041C/12	274	3700/PF	388		42	11
363R/...	33	3011/T	266	3041C/16	275	3700/PFL	388		42/B	10
365	33	3012	267	3042C	275	3700/PLA	388		42/B9N	11
365R/...	33	3012C	267	3043C	275	3700/PLL	388		42/S	12
366	33	3012I	267	3043C/ 41+47	275	3700-COVER C37	393		42/SC9I-E	12
374	33	3014	267	3047C	275	3910	281		42/SP_plastica	12
374K	597	3014 SAR	267	3048C	275	3912PP	281		42/SP25	12
374R/...	34	3014R/GR5	267	3050/600	275	3912TP	281		42AS	12
375	33	3014SAR/1	267	3050/CC	275	3912TP/A	281	42AS/B9N	12	
376	33	3014SAR/2	267	3050/KA	275	3912TP/C	281	42AS/S	12	
378	34	3014SAR/RR	267	3050/LA	276	3912TP/FOX	281	42BA	305	
378BA	307	3023	267	3050/MS	275	3912TP/QRE	281	42BA-AS	305	
383	34	3025N	267	3050/MV	276	3912TP/ROAD	281	42LMP	13	
383R	34	3025N/PF	268	3054	276	3912TP/RS	281	42LMP/S	13	
384	34	3026 0,3	268	3055M	276	3912TP/ST	281	42MP	12	
384RC	34	3026 0,5	268	3057	276	3916MMP	282	42MP/B9N	12	
386A	34	3026 1,0	268	3061/2T	272	3918MML	282	42MP/S	12	
386A/RC	34	3026/R 1,0	268	3061/2T-P100	272	3921	282	42NEWK	596	
386BA	307	3026/R0,3	268	3061/2T-P50	272	3923	282	42SLIM	13	
387	34	3026/R0,5	268	3065/20-10T	273	3927	282	42SLIM/B8NI-E	13	
387R	34	3026/S	268	3065/40-20T	273	3932U	282	42SLIM/S11	13	
388	34	3026/SA	268	3067/60-15T	273	3935	282	45	13	
388A	34	3026/SAM	268	3067/70-13T	273	3937	282	410	36	
388C/C8	35	3026/SP	268	3068	273	3948	282	410/SEL	37	
389/K4	35	3027/PR	270	3069	273	3952	282	410/SP	36	
392C	35	3027N 10	269	3070B	276	3952/S	282	410A	37	
392RG/C	35	3027N 100	269	3070B/10	276	3953	282	410AS	37	
393	35	3027N 20	269	3070BE/B	277	3955	282	410AS/SEL	37	
395	35	3027N 30	269	3070BE/F	277	3961 3,2	282	410AS/SP	37	
395T	35	3027N 50	269	3070BE/K	276	3961 3,3	283	410MIX/SEL19	37	
398	35	3027N/KP	269	3070BE/S	276	3961 3,5	283	412	37	
399	35	3027N/KPP	269	3071A	277	3961U	283	412/C150	38	
399R/...	35	3028 15	270	3071B	277	3962MV	283	412/SP	37	
3000L	263	3028 20	270	3071RS	277	3962SH	283	412/SP91	38	
3000L/RLS	263	3028 30	270	3072N	277	3963P	283	412A	38	
3000M/PLM	383	3028 50	270	3073	277	3964	283	412L	38	
3002	264	3028/KP	270	3074O	277	3965	283	412XL	38	
3002/RLS	264	3028SP/15	270	3074O/2	278	3965C	283	414	38	
3003	264	3028SP/20	270	3074O/M	278	3967	283	414/C116	39	
3003/RLS	264	3028SP/30	270	3074O/S	278	3969	283	414/SP	38	
3003C	264	3028SP/50	270	3075/CM	278	3969K3	283	415	39	
3003C/RLS	264	3029/2T	271	3075/K10	278	3971	283	415/C116	39	
3003PRO	264	3029/2T-L/R5	271	3075A	278	3972	283	415/SP	39	
3003PRO/PM	264	3029/2T-L/R6	271	3075B 55	278	3973/1	283	415/SP91	39	
3003PRO/RCR	264	3029/2T-L/RP	271	3075MV	278	3973/2	284	415CO	39	
3003PRO/RRG	265	3029L/2T	271	3079/21	278	3973/3	284	415CO/SP	39	
3003PRO/RT	265	3030/2T	271	3080/C15	278	3973/4	284	415CO-A	39	
3003PRO/SP	264	3030/2T-R5	271	3080R/CS3	278	3973PF	283	415L	40	
3004	265	3030/2T-R6	271	3081	278	3975	284	416	40	
3006	265	3030/2TRP	271	3085	278	3984/1	284	416/SP19	40	
3006 R/RG	265	3030H/2T	271	3091	279	3984/2	284	416P/SP19	40	
3006 R/RGF	265	3033/3T	271	3092	279	3984/3	284	417	40	
3007	265	3033E/3T	272	3093/E	279	3984/4	284	417/SP	40	
3007 R/RG	266	3033S 3T/R2	272	3093/U	279	3984/5	284	419	40	
3007 R/RGF	266	3035	272	3094PA	279	3984/6	284	419/SP	40	
3008N	266	3036	272	3095	279	3991	284	419T	41	
3009	266	3040C	274	3099E	279	3992	284	421	41	
3009R/GR4	266	3040C/S1	274	3099T	279					

INDEX ALPHANUMÉRIQUE

421/SP6	41	437K/12	47	53	13	5904VI/2T	482	605E	62
422	41	437K/16	47	55	13	5904VI/3T	483	606_RIC	63
423	41	437K/33	47	55/B12N	14	5904VU/1M	490	606MQ/50	287
423A	41	437K/8	46	55/B8N	14	5904VU/2M	491	610/5	62
424	41	437K/9	46	55/S	14	5904VU/2T	492	610L/5	62
424/SP	41	437P	46	55/SP	14	5904VU/3T	493	610L/5L	62
425	41	437U/09	47	55AS	14	5904VU/4T	494	611	62
425/SP	41	437U/E-M...	47	55AS/S	14	5905VG/1	525	612 ÷ 614	62
426	42	437U/PM	47	55BA	305	5905VG/2	526	614/50	63
426/SP	42	438...	47	55BA-AS	305	5908VG/2T	527	615	63
426A/SP6	42	438A	47	55K	596	5908VI/2T	484	616 - 617 - 619	63
426MD/CP	43	440	47	55MP	14	5908VU/2T	495	621	63
426MD/CT	43	440A	47	55MP/S	14	5910VI/3	485	622	63
426MD/F	43	440ASC	48	58	14	5910VI/3T	486	641	63
426MD/FA	43	440ASF	48	58BA	305	5914VU/M	496	642	63
426MD/OG	43	440ASG	48	58BA-AS	305	5915VU/0	498	643	63
426MD/OV	43	440ASW	48	560/C12	55	5915VU/1	498	644	63
426MD/S	43	440B	48	560/C2	55	5915VU/2	499	650A	64
426MD/SP10	43	441	48	560/C3	55	5915VU/3	499	650H	64
426MD/T	43	441A	48	560/C3PLUS	55	5915VU/4	500	652	64
426MD/TA	43	441B	48	560/C4+	55	5915VU/5	500	653	64
426MD-3/A9	43	442	49	560/C6	55	5915VU/AS	501	654	64
426MD-3/CP3	42	443	49	561/1	55	5927VU/M	501	659/15	64
426MD-3/CT3	42	444	49	562-1/VA - 562-2/VA	56	5935ET/1MB	511	659/16	64
426MD-3/F3	42	444G	49	562VV-A	56	5935VG/1MB	528	665	64
426MD-3/FA3	42	446/C110	50	564-3R/V - 564-4R/V	56	5935VI/2MB	487	665LB	65
426MD-3/OG3	42	446/C30	49	565-1R/VA - 565-2R/ VA - 565-3R/VA	56	5938U/2T	502	665SW	65
426MD-3/OV3	43	446/C48	49	565-4R/VB	56	5940SBK	528	666	66
426MD-3/S3	43	446ASC/C37	50	565-5R/VB	56	5941VU/M	529	666 LBF.FT	66
426MD-3/T3	43	446ASF/C29	50	565VV-B	56	5945VUM_2024	530	667	66
426MD-3/TA3	43	446ASG/C23	50	567-4R/VB	56	5954VG	531	668N	66
426SB	42	446ASW/C36	50	567-5R/VB	56	5954VI	489	668RG	67
426SB/SP	42	447/C37	51	581	60	5957U-P	503	668RGC	67
426T	42	447/C53	51	583	60	5957VG	532	669N	67
426T/SP	42	447/C70	51	583/C31	60	5957VI	488	671B/C10	67
427	44	450	51	590 - 592	60	5958U	504	671B/C5	67
428/C14	44	450/C13	52	594	60	5980/MQ	513	671N/C10	67
428FC	44	450/C15	52	596 - 598	60	5980EL/A	514	671N/C20	68
428FP	44	450/C21	52	599DGT	61	5980EL/B	515	671N/C30	68
429/C14	44	450/C9	52	599DGT-AN	61	5980ET/A	512	674/C	68
429FC	44	450AD	51	5000 RSC50/ASL	475	5980ET/B	513	677	68
429FP	44	450AL	51	5000 RSC50/CAL	453	5980ID/1	516	677/C	68
430	44	450PA/1	52	5000 RSC50/CLL	453	5980U/BIKE	506	677/CP2000	68
430/SP	44	450PA/2	52	5000 RSC50/CTR	476	5980U/BIKE-M	507	677/CV - 678/CV	69
430ASC	45	450PR	52	5000 RSC50/KFC	453	5988 VHB-MQ	514	678/C	69
430ASW	45	451	52	5000 RSC50/MP	453	5988H/7M	508	680	69
431	45	451/C	53	5000 RSC50/MPA140	453	5988L/4M	509	682	69
431/SP	45	451GA	53	5000 RSC50/PLED	475	5988U/7M	497	6200AP/S10	670
433	45	451PA	53	5000 RSC50/PLED-ST	475	5988U6/M	510	6600 M/112	618
433ASF	45	451PR	53	5700LAMP	405	5989 VEM	517	6600 M/116	618
433ASG	45	452	53	5902MT	518	5990V1	505	6600 M/120	618
434	45	452GA	53	5902MT/AS	519	5990V3	505	6600 M/125	618
435	46	460	53	5902VI	481			6600 M/126	618
435G	46	460G	53	5904VG/2M	520			6600 M/131	618
436	46	460PP	53	5904VG/2T	521	600	61	6600 M/14	616
436L	46	4900-COVER C49	397	5904VG/3	522	601C	61	6600 M/174	618
436R	46			5904VG/3T	523	601CA	61	6600 M/175	618
437C	46			5904VG/5T	524	603	62	6600 M/217	618
437C/...	46			5904VI/1T	481	604B	62	6600 M/218	618
437C/RM14	46					605DGT/2	62	6600 M/22	616

INDEX ALPHANUMÉRIQUE

6600 M/222	618	6600 M/881	622	720RNG	72	7042LCD/RV	254	7352B	642
6600 M/223	618	6800 VE	616	720S	71	7042LCD/RV-INT	254	7352G	642
6600 M/230	619	6800BA	670	720S/SB6	71	7043	254	7352LG	643
6600 M/236	619	6800RS	670	720TC	72	7061TC	669	7353Y	643
6600 M/241	619	6888	616	720TC/S5	73	7076BC	669	7354N	643
6600 M/242	619	6888B1/2	609	720TX	73	7076BD	669	7355V	643
6600 M/253	619	6888B1/4	609	720TX/C6	73	7076BP	669	7356G	644
6600 M/27	616	6888B3/8	609	720XZN	73	7076BU	669	7356LN	644
6600 M/29	616	6888GS	670	720XZN/C6	73	7093BC	669	7356V	644
6600 M/311	619	6888GW	670	727/C16	75	7093BD	669	7357G	644
6600 M/315	619	7		727/ES16	74	7104 90	668	7357V	645
6600 M/320	619	7		727/ES16TX	74	7105 6	668	7362B	645
6600 M/326	619	73	15	727/ES16XZN	74	7109A	668	7363N	645
6600 M/327	619	73/B13N	15	727/ES22	75	7109D	668	7371V	645
6600 M/33	616	73/S	15	727/ES22TX	75	7201BKK	637	7372B	646
6600 M/330	619	78	15	727/ES32	75	7210BKK	637	7376A	646
6600 M/371	619	78AS	15	727PI/16	74	7212B	634	7381N	646
6600 M/380	620	78BA	305	727PI/16 1/2	74	7212G	635	7382N	646
6600 M/40	617	78BA-AS	306	727PI/22	75	7213G	635	7398 0/G	648
6600 M/406	620	710	70	727PI/32	75	7214FN	635	7398EF	649
6600 M/417	620	710/16	70	728	75	7214G	636	7398ESD	648
6600 M/42	617	710/20	70	728/15	76	7215FN	636	7398GEL	648
6600 M/423	620	710/21	70	728/16	76	7216BKK	637	7398T	648
6600 M/424	620	710/22	70	728/21	76	7218FN	636	7398U	648
6600 M/427	620	710/25	70	728/22	76	7218G	636	7398UP	648
6600 M/430	620	710/C10	70	728/22L	76	7220PEK	633	7399 A/N...	649
6600 M/44	617	710/OR... - 710/SP...	70	728/25	77	7221PEK	633	7421	649
6600 M/440	620	720	70	728/C10	75	7222PEK	633	7422P	649
6600 M/456	620	720/15	73	728/OR - 728/SP	77	7223PEK	634	7425	649
6600 M/465	620	720/16	73	728AS	76	7236BK	638	7426P	649
6600 M/47	617	720/20	74	728B	75	7238WR	638	7427	649
6600 M/480	620	720/21	74	728B/C10	75	7241BK	630	7430T	649
6600 M/485	620	720/22	74	728FTX	76	7241CK	630	7431P	649
6600 M/51	617	720/25	74	728L	76	7241EN	629	7527	652
6600 M/510	621	720/C12	70	728L/S	76	7243BK	630	7528	652
6600 M/52	617	720/C24	71	728LQ	76	7243CK	631	7529	657
6600 M/532	621	720/C6	70	728LS	76	7243CR	631	7530	652
6600 M/534	621	720/OR... - 720/SP...	74	728ME	76	7243EN	629	7545F	664
6600 M/542	621	720/SN	73	728ME/C6	76	7243FT	631	7547AZ	664
6600 M/548	621	720AS	71	729	77	7245BK	631	7547BL	665
6600 M/561	621	720B	71	729/15	64	7246BK	632	7547G	665
6600 M/58	617	720B/C12	71	729/16	77	7246E	629	7547N	665
6600 M/583	621	720FRD	72	729/21	77	7247BK	632	7547R	665
6600 M/59	617	720FTX	73	729/21L	77	7249GK	638	7548C	665
6600 M/61	617	720FTX/SB	73	729/22	77	7293HM	647	7548M	665
6600 M/62	617	720IC	72	729/25	77	7294HM	647	7549AZ	665
6600 M/63	617	720L	71	729/OR... - 729/SP...	77	7294HMC	647	7549BL	665
6600 M/643	621	720L/S3	71	729L	77	7314AF	639	7549G	665
6600 M/650	621	720LC	72	729LS	77	7315AN	639	7549N	666
6600 M/657	621	720LC/C3	72	729T	77	7316NB	639	7549NE	666
6600 M/658	621	720LC/PM5	72	730	78	7316NG	640	7549R	666
6600 M/716	622	720LC/S5	72	730/15	78	7317NA	640	7550G	666
6600 M/73	617	720LCL	72	730/21	78	7318AN	640	7550N	666
6600 M/813	622	720LCL/C3	72	730/25	78	7320NA	640	7557BL	666
6600 M/842	622	720LS	72	730L	78	7321NA	641	7575N	661
6600 M/852	622	720MC	71	733/15	78	7322SA	641	7579QN	661
6600 M/856	622	720MC/C13	71	7041LCD/4S	254	7323SA	641	7600G	652
6600 M/857	622	720ME	73	7041LCD/4S-VE	254	7328A	632	7600N	652
6600 M/871	622	720ME/C8	73	7041LCD/4S-VI	254	7328N	632	7610G	653
6600 M/878	622	720MRC	72	7042LCD	254	7352A	642	7610N	653

INDEX ALPHANUMÉRIQUE

7611G	657	7907G	662	861PE	81	8002ZS	676	8040EN-K	684
7636N	663	7909B	660	861PH	80	8003ZD	676	8040EZ	684
7637G	663	7909G	660	861PH/C	80	8003ZS	676	8040EZ	684
7642G	663	7909P	660	861PZ	80	8004ND	676	8040EZ-K	684
7650	653	7909V	660	861PZ/C	81	8004NS	676	8041	683
7650B	653	7930MG	656	861RIBE	81	8005TZ	673	8041-K	683
7653G	660	7931MG	658	861RTX	81	8005TZ-K	673	8042EN	685
7654B	663	7935MG	659	861SP	81	8005Z	673	8042EN-K	685
7654N	664	7937MG	662	861TQS	81	8005Z	673	8042EZ	685
7657B	664	7940	656	861TRW	81	8005Z-K	673	8042EZ	685
7657N	664	7949	661	861TX	81	8006Z	673	8042EZ-K	685
7658CM	662	7970	666	861TX/C	81	8006Z	673	8043	684
7659N	662	7971L	667	861XZN	81	8006Z-K	673	8043-K	684
7660B	653	7978L	667	862F	83	8007Z	674	8044	685
7660G	653	7979	667	862F/A7	83	8007Z-K	674	8048	677
7661B	657	7980L	668	862LP	82	8008N	674	8049	682
7661G	657	7980NC	668	862PE	82	8008N-K	674	8049A	683
7664G	664	7980RN	668	862PH	82	8008TZN	674	8049V	683
7664N	664	7981N	668	862PH/L	82	8009FD	677	8050 D	697
7665G	664	7982N	668	862PH-XL	82	8009FS	677	8051S	692
7665N	664	7984EG	668	862PZ	82	8009TZ	674	8051S-K	692
7669N	662	7984G	668	862TX	82	8009TZ-K	674	8052 - 8055S	691
7670G	662	7985N	668	862TX/L	82	8009Z	674	8057R - 8057	691
7673NG	661	7996N	667	862TX-XL	82	8009Z	674	8058R - 8058	690
7674NG	663			862XP/A16	83	8009Z-K	674	8058R/PS	698
7750N	663			866LP	83	8010TZ	675	8060R - 8060	690
7780QN	663	8		866PE	83	8010Z	675	8060R/PS	698
7800G	668	80	15	866PH	83	8010Z-K	675	8061R - 8061F	691
7815CM	657	80/S	15	866PZ	83	8011TZ	675	8062	692
7818BL	654	83	15	866RTX	83	8011Z	675	8063	691
7818CM	654	83/S	15	866TX	83	8015	678	8063SL	691
7818G	654	83AS	16	867...	84	8016	678	8064S	691
7818LN	654	83AS/S	16	867/C20	84	8016	678	8065SC	692
7819G	654	88	16	867/C38	84	8016FR	679	8068S	683
7830SN	654	88/S7	16	867/C52	85	8016-K	678	8074	695
7830ST	655	89BA	306	867PE	83	8016U2	679	8074	695
7831SN	657	89MQ	286	867PE/L	83	8016UGK	679	8074A	695
7831ST	657	850MQ	287	867RIBE	84	8016U-K	679	8074G	695
7840BL	655	851	78	867RIBE/L	84	8018E	679	8080	695
7849BL	660	851SR	78	867RTX	84	8018T	679	8080FM	695
7850G	655	852	79	867RTX/L	84	8020	680	8082	695
7860B	655	855P	79	867TX	84	8020A	680	8083	696
7860G	655	855P	598	867TX/L	84	8021A	680	8085R	690
7861B	658	860/55	79	867TXN	84	8025	681	8086	690
7861G	658	860/58	79	867XZN	84	8025	681	8090F	710
7863G	658	860/58K	598	867XZN/L	84	8025	681	8090F	710
7865B	659	860/C27	79	882	85	8025-K	681	8090R - 8090	690
7865G	659	860/C38P	80	882AN	85	8026A	682	8091	686
7867B	661	860LP	79	882M	85	8026A-K	682	8091SL	686
7867G	661	860MIX/A10	80	882M1	85	8026R	680	8092	686
7869G	660	860MIX/A31	80	882MSR	85	8026R-K	680	8092SL	687
7880SC	655	860PE	79	882P	85	8028	682	8094	687
7900B	656	860PE/A10	80	892	85	8028-K	682	8094SL	687
7900G	656	860PH	79	895	85	8029R	680	8096	688
7900P	656	860PHZ/A10	79	897	85	8029R	681	8096SL	688
7900V	656	860PZ	79	897L	85	8029R-K	681	8097	688
7901G	658	860RTX	79	8001TZ	675	8031R	681	8097SL	689
7903G	659	860TX	79	8001TZ-K	675	8031R-K	681	8098	689
7903P	659	860TX/A10	80	8001Z	675	8032	681	8098SL	689
7905G	659	861/C61P	82	8001Z-K	675	8032-K	681	8100	690
		861LP	80	8002ZD	676	8040EN	684	8105	672

INDEX ALPHANUMÉRIQUE

8105-K	672	8180	710	8274	703	8889P3	559	96C/AS	19
8109	672	8181	710	8274	703	8889P4	559	96C/AS	596
8109-K	672	8181 6/S4	710	8274A	703	8889PD	560	96C-AS/SC9	19
8110	672	8181S	710	8274G	703	8889PS	560	96L	20
8114	696	8182	711	8276	703	9		96L/SC12	20
8116	696	8182 8,5/S2	711	8276G	704			96L/SP8	20
8120	694	8182A	711	8278	704	90	16	96LBP	20
8120B	694	8182E	710	8279	706	90/B8N	16	96LBP/SC9	20
8120D	694	8182GD	711	8280	704	90/S	16	96LBP/SC9	597
8120DZC	694	8182H	711	8282S	705	90/SP	16	96LC	19
8121MZC	694	8182H/2	711	8284	705	90AS	16	96LC/SC12	20
8129	695	8182S	711	8285	705	90AS/S	16	96LC/SC8	20
8130	695	8182T	710	8286	705	90BA	306	96N	18
8134	692	8182TS	710	8287	705	90K	596	96N/B	19
8135	692	8183	711	8290	705	91	17	96N/G	19
8135/KLA1	698	8184	711	8293	706	91BA	306	96N/SC12	19
8135/KMO	698	8185	712	8297C	706	92	17	96N/SC9	19
8143	692	8186	712	8297F	706	92BA	306	96N/ST	19
8143/RKCI	698	8187	712	8302Z	677	93	17	96N/ST6K	596
8143/RKL	698	8188/K8	713	8302Z	677	93BA	306	96T	21
8143/RPC	698	8188C	712	8303Z	677	93C	17	96T/AS	21
8143/RPF	698	8188CG/25	712	8303Z	677	93K	596	96T/S11	21
8146	693	8188CU/25	713	8317DZ	696	94	17	96T/S6	21
8146/RK	698	8188F	713	8317SZ	696	94/S	17	96T/SP	21
8146/RKCI	699	8188F35	713	8381SL	696	94K	596	96T/SPV	561
8146/RKFC	698	8188VFG2	713	8381SP	696	95	17	96TAS/S	21
8146/RKL	698	8189	713	8381SX	706	95/S	17	96TBP	22
8146/RPC	698	8189A	713	8383C	697	95BA	306	96TBP/S6	22
8146C	693	8189PA	713	8383P	697	95FTX	17	96TK	597
8147C	693	8190	712	8515CH	697	95FTX/S	17	97BRTL/SC8	23
8147P	693	8190B	712	8515V	697	96	18	97BTX	22
8147S	693	8201T	701	8515Z	697	96/B	18	97BTX/B	22
8148	694	8205	700	8531	697	96/BG7	18	97BTX/SC8	22
8148/RA	699	8205	700	8532	697	96/BGS7	18	97BTX-C	22
8148/RKCL	699	8206	700	8535	697	96/SC12	18	97BTX-C/SC8	22
8148/RKCM	699	8207	700	8600 R/11	622	96/SC9	18	97BTL	23
8148/RKG	699	8209	700	8600 R/113	623	96/ST	18	97BTL/SC8	23
8148/RKS	699	8210	700	8600 R/114	623	96/ST6K	596	97RTX	23
8148/RP	699	8210F	701	8600 R/12	622	96AS	19	97RTX/B	23
8148F	694	8210FTP	701	8600 R/13	623	96AS/B	19	97RTX/SC8	23
8149	699	8216	701	8600 R/225	623	96AS/BG7	19	97TTX	23
8149CM	699	8216	701	8600 R/412	623	96AS/SC9	19	97TTX/S	23
8149CM/RA	699	8216-K	701	8600 R/511	623	96AS/T	19	97TTX/SP	23
8150	706	8220	702	8600 R/601	623	96BA	306	97TX	22
8153	707	8225	702	8600 R/611	623	96BA/BP	306	97TX/B	22
8156	707	8225	702	8702N	677	96BAF-AS	307	97TX/BG8	22
8157	707	8227	702	8702Z	677	96BP	20	97TX/G	22
8158	707	8228	702	8702ZC	677	96BP/AS	21	97TX/SC8	22
8159	707	8240	702	8709N	678	96BP/ASB	21	97TX/ST	22
8160	707	8240F	702	8709Z	678	96BP/AS-SC9	21	98XZN	23
8161	708	8242	703	8709ZC	678	96BP/SC9	20	98XZN/B	23
8166	710	8242F	703	8889C1	559	96BPA	21	99	23
8170	708	8248	701	8889C2	559	96BPA/SC9	21	99 VN/...	24
8173	708	8249	701	8889C3	559	96BPA/SC9	596	99BA	307
8176	708	8249G	701	8889C6	560	96BPC	20	99SQ	24
8177	708	8250	704	8889CD	560	96BPC/SC9	20	99ST	24
8178	708	8264	704	8889CS	560	96BPC/SC9	596	900	86
8179A	709	8267	704	8889I4	559	96BP-CL	20	900/...	89
8179B	709	8272	705	8889P1	559	96BP-CL/SC9	20	900/16	88
8179M	709	8273	705	8889P2	559	96BP-CL/SC9	596	900/20LK	598

INDEX ALPHANUMÉRIQUE

900/25	89	900PE/AS	88	910BL/SB	94	920/55	104	920ES/SB	103
900/25K	599	900PH	88	910BP	96	920/55K	599	920ES/XL-SB	103
900/32	89	900PH/SB4	88	910BP/SB6L	96	920/55LC	105	920FTX	101
900/35A	89	900PT	88	910CF	96	920/55Q	104	920FTX/C	101
900/40	89	900PZ	88	910CF/SB	96	920/55X	105	920FTX/L	101
900/42	89	900T/44	89	910FTX	95	920/56A	105	920FTX/LSB	101
900/55	89	900TX	88	910FTX/L	95	920/58	105	920FTX/SB	101
900/55K	599	900TX/SB	88	910FTX/LSB	95	920/58K	599	920LH/SB7	101
900/55Z	90	900U	87	910FTX/SB	95	920/C37	107	920LP	101
900/55ZK	599	900U/C12M	92	910FTX/XL	95	920/R50	111	920M/35	104
900/58	90	900U/SB	87	910FTX-XL/C10	95	920/R55	111	920M/35L	104
900/58K	599	902A/C22	93	910LP	95	920/R55LC	112	920M/55	105
900/C11	90	902R/C6	93	910M/35	97	920/R55Q	111	920M/56	105
900/C11HR	93	910/15	96	910M/35L_WARN	104	920/R55X	112	920M/R55	111
900/C11Z	91	910/16	97	910M/55	97	920A	99	920MC	100
900/C12MR	91	910/20 - 910/21 -	97	910M/56	98	920A/AS	100	920MC/C14	106
900/C12MZ	91	910/22		910M/R55	111	920A/C11	105	920ME	102
900/C13-5	91	910/21K	599	910ME	96	920A/C12	105	920ME/C	102
900/C13-8	91	910/25	97	910ME/SB	96	920A/C12X	105	920ME/SB	102
900/C24	92	910/25K	599	910MQ/21	287	920A/C17HR	108	920MQ/21	288
900/C39N	90	910/36A	97	910MQ/22	287	920A/C17M	107	920MQ/22	288
900/C39U	90	910/40	97	910MQ/55	287	920A/C17MR	107	920MQ/55A	288
900/R55	111	910/42	97	910MQ/B	287	920A/C20	106	920MQ/A	288
900/R55-Z	111	910/46	97	910MQ/C16	287	920A/C20Q	106	920MQ/C16	288
900/SB	86	910/55	97	910MQ/PE	287	920A/C20X	106	920MQ/PE	288
900AN	89	910/55K	599	910MQ/PT	287	920A/C21	106	920MQ/T	288
900AS	87	910/55Q	97	910MQ/T	287	920A/C21X	106	920PE	102
900AS/C10	93	910/58	98	910MQ/TX	287	920A/C33	107	920PE/AS	102
900AS/C17-MBM	93	910/58K	599	910MQ/XZN	287	920A/SB13	99	920PE/C	102
900AS/L	87	910/R55	111	910PE	96	920A/SB8	99	920PE/SB	102
900AS/MB	87	910/R55Q	111	910PE/AS	96	920A-AS/SB11	100	920PE-AS/SB6	102
900AS/MB-C17	93	910/R55X	111	910PE/SB	96	920AK	599	920PH	101
900AS/MBL	87	910A	93	910PH	95	920AL	100	920PH/SB4	101
900AS/SB11	87	910A/AS	94	910PH/SB4	95	920AL/SB11	100	920RTX	103
900BG/30	89	910A/C10	98	910PT	96	920AN	103	920RTX/SB	103
900BG/30C	89	910A/C16	98	910PT/SB	96	920AS	100	920TX	102
900BG/30K	599	910A/C16HR	99	910TX	96	920AS/C10	108	920TX/C	102
900FL	89	910A/C16Q	98	910TX/SB	96	920AS/C15	108	920TX/C17	108
900FTX	87	910A/C17	98	910XZN	96	920AS/C17X	108	920TX/L-SB4	102
900FTX/SB9	87	910A/C29	99	911BA	307	920AS/L	101	920TX/SB	102
900K	598	910A/SB	93	911BA/16	307	920AS/MBM-C21	108	920U	101
900L	86	910A-AS/SB13	94	911BA/20	307	920AS/SB11	100	920U/C17M	109
900L/SB	86	910AK	599	911BA/55	307	920ASL/SB11	101	920U/SB13	101
900LP	87	910AL	94	914MQ/A	288	920B	100	920U/SB4	101
900M/35	89	910AL/SB14	94	914MQ-A/S4	288	920B/C11	105	920XZN	103
900M/55	90	910AN	97	920/15	103	920B/C12	106	920XZN/LS	103
900M/R55	111	910AS	94	920/16	103	920B/C12X	106	920XZN/SB12	103
900MB	86	910AS/C13	99	920/20÷920/23	103	920B/C20	106	920XZN/SB7	103
900MB/C19	91	910AS/L	95	920/21K	599	920B/C20X	106	921BA	308
900MB/C28	92	910AS/MBM-C18	99	920/25	104	920B/C21	106	921BA/15	308
900MB/L	87	910AS/SB13	94	920/25K	599	920B/C21X	107	921BA/16	308
900MB/SB	86	910AS/SN	95	920/35A	104	920B/C30Q	107	921BA/21 - 921BA/22	308
900MC	86	910ASL/SB12	95	920/36A	104	920B/C33	107	921BA/25	308
900MC/C24	92	910B	94	920/38	104	920B/SB13	100	921BA/42	308
900MC/C32	92	910B/C10	98	920/40	104	920B/SB8	100	921BA/50	308
900MC/LP	87	910B/C16	98	920/42	104	920BL	100	921BA/R50	308
900MC/PH	88	910B/C16Q	98	920/44	104	920BL/SB11	100	921BA-AS	308
900MC/TX	88	910B/C29	99	920/46	104	920BP	102	926BA	308
900ME	88	910B/SB	94	920/50	104	920BP/SB	102	926BA/15	308
900ME/SB8	88	910B/SN	94	920/50F	104	920ES	103	926BA/22	308
		910BL	94						

INDEX ALPHANUMÉRIQUE

926BA/42	308	944BX/S	114	960RPI	122	993G	126	9548KB	721
926BA/50	309	949	114	960SL	119	993MQ	289	9548KB 20	721
926BA/R50	309	949/S6	114	960SN	119	993PL	126	9548KB 24	721
928.../C12	110	950	114	960T/A	120	994	126	9549ABW	723
928/15	109	950/S	114	960T/B	120	994MQ	289	9549BP	723
928/16	109	951	115	960T/C	120	994PL	126	9549BRW	724
928/20 - 928/21 - 928/22	109	951/S	115	960T/C11	120	994TF	126	9549C	724
		951/SP	115	960T/F	120	996	126	9549CR	723
928/25	109	951AS	115	960T/G	120	998	126	9549MPC	723
928/36A	110	951AS/S	115	960T/H	120	999	126	9549SBW	723
928/42	110	951BA	309	960UC	121	999/B6N	127	9557J 2.0	717
928/55	110	951GP	115	960VTC	122	999A	126	9557N	717
928/R55	112	951GP/S6	115	960YP	121	999B	126	9559	722
928/R55X	112	951K	600	961BA	309	999C	126	9559/30MT	722
928A	109	951MQ	288	961P6	122	999D	127	9561V	722
928AS	109	951TX	116	961P6/S	122	999E	127	9561V 2,5	722
928AS/C12	110	951TX/S	116	962	122	999G	127	9561VV	722
928B	109	952	116	962C	122	9500TL	715	9561VV 2,5	722
928B/C12	110	952/D7	116	962M	123	9501TL	715	9562P12	726
928ME	109	952/S	116	962P	123	9501TLD	715	9562P2	726
929	110	952AS	117	963	123	9502TL	716	9562T1	276
929/15	110	952FTX	117	963BA	309	9503TL	716	9562T2	409
929/21 - 929/22	110	952FTX/S	117	964	123	9504TL	716	9562T3	276
929/42	110	952L	117	964BA	309	9505TL	716	9562TB	670
929/55	110	953	117	964BA/L	309	9510W	716	9563G	723
929/55PR	111	953/S	117	965	123	9520P	718	9563U	723
929/C8	111	953TX	117	965/S	123	9521	718	9565K	723
929/R55	112	953TX/S	117	965BA	309	9521OB	719	9565S	670
930	112	955	118	966/C3	123	9522A	724	9565T	723
930/C	112	956C	118	966BA	309	9523A	724	9569MS	725
930/S	112	956E	118	966BA/V	309	9523T	721	9569MS-2	725
932	112	956F	118	969/C5	123	9524SC	721	9569P	725
932/S	112	956L	118	969B	123	9525CM	718	9569S	725
933	112	957	118	970B	123	9525TR	718	9572LB	716
933/S	112	959	119	970IVECO	123	9525WB	718	9574B	718
935	113	959R	119	971/C8	124	9526F	719	9574O	718
935/S	113	960	119	972/C10	124	9526P	724	9577R	722
935K	599	960/22EP	120	972/C4BMW	124	9526RMN	724	9579C	722
937	113	960/C6	120	973	124	9527 6T	724	9580S	717
937/S	113	960/D	120	978 - 979	124	9528B	721	9586K	724
937BA	309	960A	119	982	124	9534BO	716	9587 13x21	725
937K	599	960AD/TP2	175	983 PM/R-DA	124	9534WO	716	9587 9x14	725
940	113	960AVE	121	983PM	124	9537TL	716	9588/10PI	725
941	113	960BC/C5	119	984	124	9539CB	720	9588M	725
941/S	113	960EPC/L	121	985/B7	124	9541BIKE	718	9588S/10...	725
942BX	113	960E-PI/P	121	985F	125	9541F	718	9589A/36	726
942BX/DG	611	960ER	119	985M	125	9541PC	718	9589B/36	726
942BX/S	113	960F	119	986 48	125	9541S	718	9590B	722
943BX	114	960G	119	986 78	125	9542AL	721	9592B/C50	724
943BX/D	114	960H/C4	119	986PT	125	9542AT	720	9592B/P	724
943BX/DG	611	960KC-M8/M9/M10	121	987	125	9542C	720	9592M/50	724
943BX/S	114	960KPC	121	987AR	125	9542G	720	9592MB	724
943BXK	600	960L	119	987P	125	9542GW	720	9593A	717
943FL	114	960M	119	988/K4	125	9542M	720	9593M	717
943FL/S	114	960P	121	989	125	9542S	720	9593S	717
943MQ	288	960PI	121	989A	125	9543C	721	9593SB	717
943MQ/BG	611	960PI/C19	122	989B	125	9544C	717	9593W	717
943MQ/S	288	960PI/K36	122	990	126	9547	724	9594	724
944BX	114	960PI/S	122	991	126	9547T	721	9595C	725
944BX/D	114	960PMC	122	992	126	9547WSK	721	9595T	725
944BX/DG	611			993	126	9548G	722		

INDEX ALPHANUMÉRIQUE

M115	537	MB58	545	RSC50 CS	447	T34	550	T177	555
M120	538	MB59	545	RSC50 D	440	T40	550	T180	555
M121	538	MB63	546	RSC50 E	440	T41	550	T183	555
M125	538	MB64	546	RSC50 F	440	T45	550	T198	555
M126	538	MB65	545	RSC50 G	439	T46	550	T199	555
M127	538	MC10	543	RSC50 H	439	T48	550	T201	555
M128	538	MC12	543	RSC50 I	438	T50	550	T202	555
M129	538	MC20	543	RSC50 KAI	451	T52	550	T204	555
M133	538	MC21	543	RSC50 KPF	449	T55	550	T205	556
M134	538	MM11	546	RSC50 L	438	T59	550	T206	556
M135	539	MM26	546	RSC50 M10	445	T63	550	T207	556
M136	539	MM30	546	RSC50 M4	444	T64	551	T208	556
M137	539	MM60	546	RSC50 M5	444	T65	551	T209	556
M145	539	MM63	546	RSC50 M7	445	T68	551	T211	556
M153	539	MM100	547	RSC50 M8	445	T73	551	T213	556
M161	539	MM105	547	RSC50 MA	447	T75	551	T216	556
M162	539	MM129	547	RSC50 MDO	448	T76	551	T221	556
M166	539	MM210	547	RSC50 ML	447	T77	551	T226	556
M170	539	MM230	548	RSC50 MS-2AVV	446	T80	551	T227	556
M172	539	MM400	548	RSC50 MS-2C	446	T81	551	T228	556
M174	540	MM401	548	RSC50 MS-AVV	446	T82	551	T231	557
M180	540	P		RSC50 MTP	450	T83	551	T233	557
M195	540			RSC50 P/1-0,7MT	442	T85	552	T234	557
M201	540	PM 1/2-Q5	72	RSC50 P/2-1,5MT	442	T91	552	T236	557
M204	540	PM/5C	477	RSC50 P/2MDX-SX	450	T92	552	T239	557
M208	540	PM/6C	477	RSC50 P/3-2,2MT	442	T99	552	T241	557
M209	540	PV	405	RSC50 PFI	449	T100	552	T259	557
M213	540	R		RSC50 PFS	449	T101	552	T264	557
M214	540			RSC50 PM	450	T102	552	T270	557
M216	540	RSC22	368	RSC50 PS	451	T103	552	T273	557
M217	540	RSC23	369	RSC50 RB	443	T105	552	T279	558
M218	541	RSC23C	369	RSC50 T3	448	T106	552	T281	557
M219	541	RSC23T	370	RSC51	399	T111	552	T284	558
M222	541	RSC24/5	372	S		T112	553	T291	558
M226	541	RSC24/6	372				T113	553	T294
M227	541	RSC24/7	371	S42/17	561	T122	553	T297	558
M230	541	RSC24/8	372	S55/12	560	T123	553	TSPP	560
M231	541	RSC24A/6	373	S55/8	560	T124	553	V	
M234	541	RSC24A/7	373	S951/6	561	T135	553		
M236	541	RSC24A/8	373	S952/10	560	T136	553	VE1	560
M237	542	RSC24AXL/7	374	S96T/8	561	T137	553	VP-3SC	559
M240	542	RSC24AXL/8	375	S1719BM	561	T138	553	VP-LD	559
M264	542	RSC24AXL/9	375	SB	560	T140	553	VP-LS	559
M284	542	RSC24AXLP/7	376	SGN	561	T144	553	VP1 - VP2	559
M292	542	RSC24L/7	379	SP5S	478	T145	553	VP3 - VP4	559
M294	542	RSC24L-CAB	379	SPC	478	T146	554	VP5	559
M295	542	RSC28	382	SPG11 - S1203/8	561	T151	554	VP6	559
M305	542	RSC50	439	SSPE	473	T153	554	VPM0	548
M310	542	RSC50 A	441	ST2P	560	T156	554	VPM3	548
M400	543	RSC50 A1	452	T		T157	554	VPM7	548
M401	543	RSC50 A1/R59	452				T160	554	VPM7-C
MB	560	RSC50 A1/RB59	452	T01	549	T161	554	VPM8	548
MB12	544	RSC50 A2	452	T05	549	T164	554	VPM9	548
MB37	544	RSC50 A2/R91	453	T06	549	T167	554		
MB38	544	RSC50 AC	451	T18	549	T168	554		
MB39	544	RSC50 B	441	T19	549	T170	554		
MB44	544	RSC50 C	441	T22	549	T171	554		
MB45	545	RSC50 C5	443	T23	549	T172	555		
MB46	545	RSC50 C7	443	T31	549	T173	555		
MB47	545	RSC50 C8	444	T33	550	T175	555		
MB56	545					T176	555		

NUMÉROS CLÉS DU GROUPE BETA



www.gruppo-beta.com



10 unités
de production
EN ITALIE



Environ **1.000**
employés

11 Filiales
dans le monde

Présent dans plus
de **100 pays** à
travers le monde
avec plus de **250**
importateurs



BETA UTENSILI S.p.A. - 20845 Sovico (MB)
Via A. Volta, 18 - Tel. 039.2077.1 - Fax 039.2010742
www.beta-tools.com

Robur Wire rope accessories:
67039 Sulmona (AQ) Zona industriale - C.da S. Nicola
Tel. 0864.2504.1 - Fax 0864.253132
www.roburitaly.com - info@roburitaly.com

L'HISTOIRE DE L'OUTILLAGE EN ITALIE

- 1923** ● Alessandro Ciceri fonde la société « Alessandro Ciceri & Figli », à Erba (dans la province de Côme), afin de fabriquer des moules en fer et en acier.
- 1939** ● La marque Beta est déposée et l'entreprise se consacre principalement à la fabrication d'outils professionnels dans sa nouvelle usine de Sovico (dans la province de Monza et Brianza). La société est depuis cette date toujours basée à Sovico.
- 1960** ● Beta Utensili emploie environ deux cents personnes et s'impose comme un prometteur fabricant d'outils manuels destinés aux professionnels et commence à exporter ses produits.
- 1969** ● Le chariot révolutionnaire métallique orange « Tank » est lancé et, à partir de cette instant, la couleur orange va donner un style unique à la marque Beta.
- 1971** ● Beta Utensili rentre dans le monde du sport automobile par la Formule 1, puis en rallye et enfin dans l'ensemble du sport automobile.
- 1973** ● L'usine de Castiglione d'Adda (dans la province de Lodi) est inaugurée, complétant ainsi l'usine historique de Sovico (dans la province de Monza et Brianza).
- 1975** ● L'entreprise remporte sa première victoire en Formule 1, avec la March-Beta Utensili orange pilotée par Vittorio Brambilla, vainqueur du Grand Prix d'Autriche à Zeltweg, sous une pluie battante.
- 1980** ● Beta Utensili pénètre les principaux marchés européens, en établissant des succursales en France, en Grande-Bretagne, aux Pays-Bas, en Espagne, en Pologne et en Hongrie.
- 1984** ● L'entreprise inaugure sa troisième usine à Sulmona (dans la province de L'Aquila). Dans ce nouvel atelier de forge, Beta commence à fabriquer ses emblématiques clés mixtes 42. La production et les tests d'accessoires de levage ont également commencé sous la marque Robur.
- 2000** ● Lancement du nouveau catalogue Beta Utensili témoignant d'une croissance continue. La gamme de produits est doublée et plus de 10 000 articles sont codés et répartis en 22 familles de produits.
- 2002** ● Elargissement de la gamme Beta Utensili grâce à la création d'une ligne "Beta Work" de chaussures de sécurité et de vêtements de travail.
- 2009** ● Beta commence son développement à l'étranger, en créant la succursale Beta Chine puis trois ans plus tard, la succursale Beta Brésil.
- 2016** ● Beta présente son nouveau système modulaire de combinaison d'ameublement d'atelier RSC55.
- 2018** ● Le Groupe Beta se renforce en rachetant 3 sociétés:
 - BM S.p.A., l'un des principaux fabricants de cosses et de systèmes de connexion électrique
 - 3D Beta S.r.l., une société spécialisée dans la conception et la production d'ameublement d'atelier sur mesure,
 - VGF S.r.l., une société spécialisée en thermolaquage de mobiliers métalliques
- 2019** ● La croissance du Groupe Beta s'accélère grâce à l'acquisition de 2 principaux fabricants d'abrasifs, Abra Beta S.p.A. et Elpa Abrasivi S.r.l.
- 2020** ● Beta Tools USA est créée et constitue une étape majeure pour l'expansion sur le marché nord-américain.
- 2023** ● Rachat de Helvi S.p.A. qui est un acteur majeur dans l'industrie du soudage des métaux. Cette dernière acquisition permet au groupe Beta de dépasser 1 000 collaborateurs dans le monde en couvrant 40 familles de produits avec plus de 30 000 articles référencés qui sont développés pour satisfaire les exigences des professionnels en offrant une qualité et des performances sur le long terme, caractérisant le « Beta Well Done », car chez Beta, nous n'avons qu'une seule manière de faire les choses, les faire bien



1923 Alessandro Ciceri & Figli



1939 Département forge



1955 Département découpage

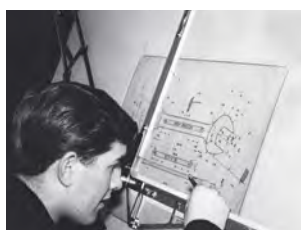

1960 Conception



1969 Chariot Tank



1974 Publicité assortiments



1975 Vittorio Brambilla



2002 "BetaWork"



2016 Mobilier d'atelier RSC55



2023 Fabio Quartararo, Beta Ambassador

QUALITÉ CERTIFIÉE

Beta a obtenu la **certification ISO 9001** dès 1995 et en 2018, la société obtenait également la certification **TÜV**, en passant des tests rigoureux selon le protocole de test EK5/TA5.

La procédure EK5/TA5 prévoit 31 caractéristiques de construction bien définies, des tests statiques rigoureux et des tests de réaction dynamique. D'autres tests définissent la résistance aux températures élevées et basses, la durée des marquages dans le temps et la résistance à la corrosion.

L'obtention de ces résultats récompense la conception experte, la réalisation minutieuse et les contrôles sévères que Beta met en place tout au long du processus de production des servantes et qui ont assuré l'appréciation des utilisateurs finaux.



CONTRÔLE ET QUALITÉ

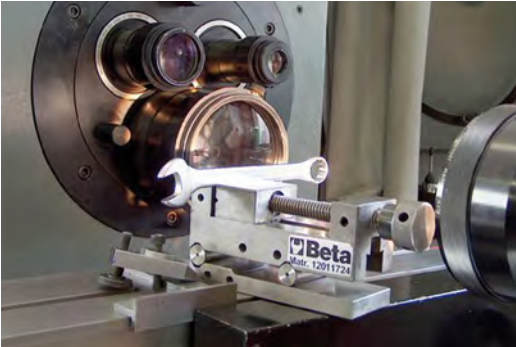

Chez Beta, la qualité a un sens simple et concret : « ce qui répond pleinement aux exigences et attentes de l'utilisateur professionnel pour qui nos produits sont un outil fondamental pour leur travail ». L'outil n'est pas seulement conçu et construit correctement pour remplir sa fonction, mais il assure également la répétition des performances d'une manière homogène dans le temps.

La qualité Beta ne s'exprime pas seulement par une politique industrielle et commerciale attentive, mais elle va plus loin avec l'implication de chaque division de l'entreprise dans la même direction pour atteindre des objectifs toujours plus ambitieux en termes de satisfaction de la clientèle. C'est sur ce concept que Beta a construit son histoire.

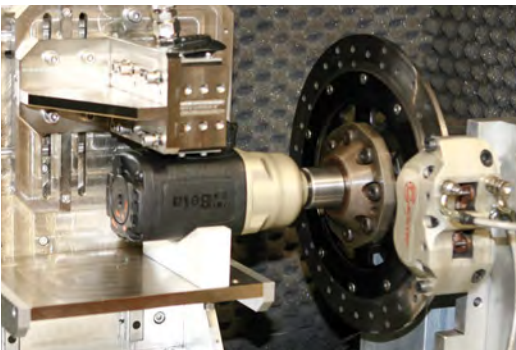

**Qualité Beta,
l'aspect le plus
concret**

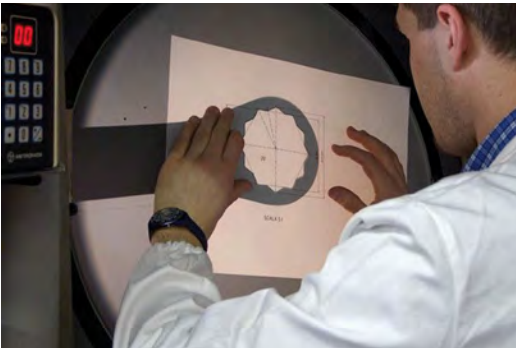

**La qualité des outils
Beta est la synthèse
de techniques anciennes
et de nouvelles
technologies.**



Depuis 1995, les processus de production sont certifiés conformes aux standards du Système Qualité ISO 9001



LOGISTIQUE



**30.000 m²
de superficie**



40.000
références gérées
et plus de **27.000**
unités de charge

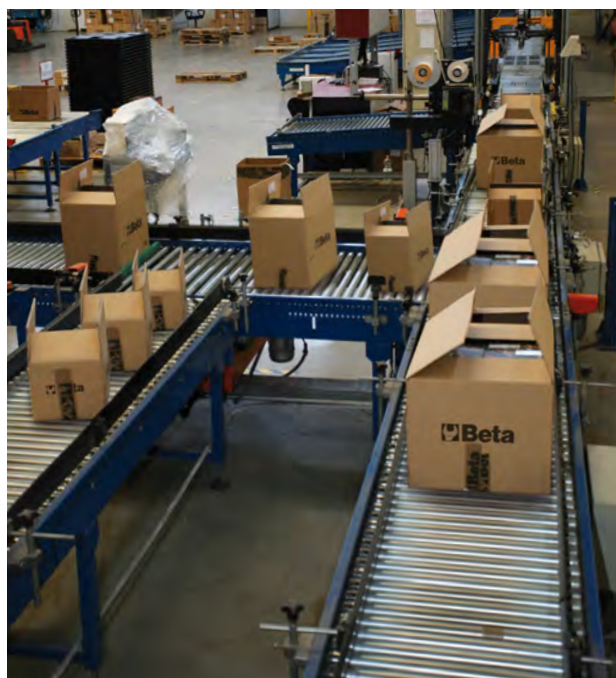

**Livraisons
rapides, précises
et complètes**



ORGANISER LE TRAVAIL

5S est une méthode d'organisation de la zone de travail d'origine japonaise.

Cette méthode prend son nom de la transcription occidentale de 5 mots japonais: seiri, seiton, seiso, seiketsu et shitsuke.

En suivant les 5 passages identifiés par ces mots, on obtient une méthode systématique et renouvelable pour l'optimisation des normes professionnelles et l'amélioration des résultats du fonctionnement.



SEIRI

SÉLECTIONNER

Éliminer tout ce qui est superflu de la zone de travail et garder uniquement les outils strictement nécessaires.



SEITON

SYSTÉMATISER

Créer le rangement : chaque chose à sa place et une place pour chaque chose.



SEISO

SYSTÈME

Nettoyer l'espace de travail et le garder en ordre dans le temps.



SEIKETSU

STANDARDISER

Définir des méthodes répétitives pour continuer à rationaliser les ressources et les espaces en définissant des règles standardisées à suivre.



SHITSUKE

SOUTENIR

Soutenir et diffuser cette façon de penser et d'agir dans toutes les activités de la société.



AVANTAGES



Gain de temps et réduction des coûts



Amélioration de la qualité et de la productivité



Réduction des accidents du travail



Augmentation de l'efficience



AVANT



APRÈS

PRÉSENCE EFFICACE

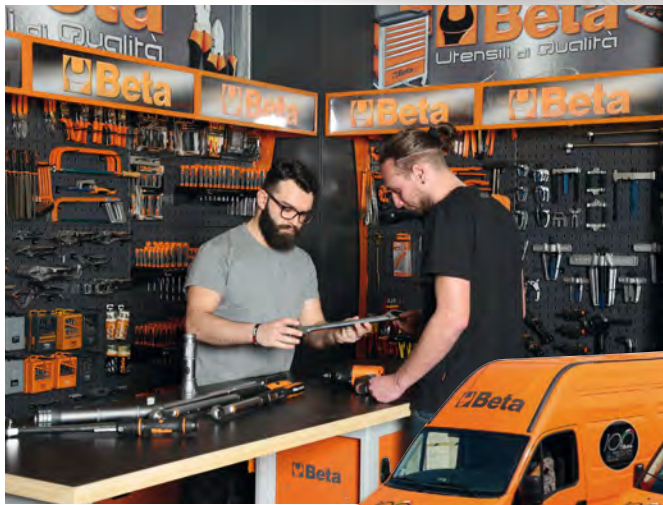

**Unité de
démonstration**

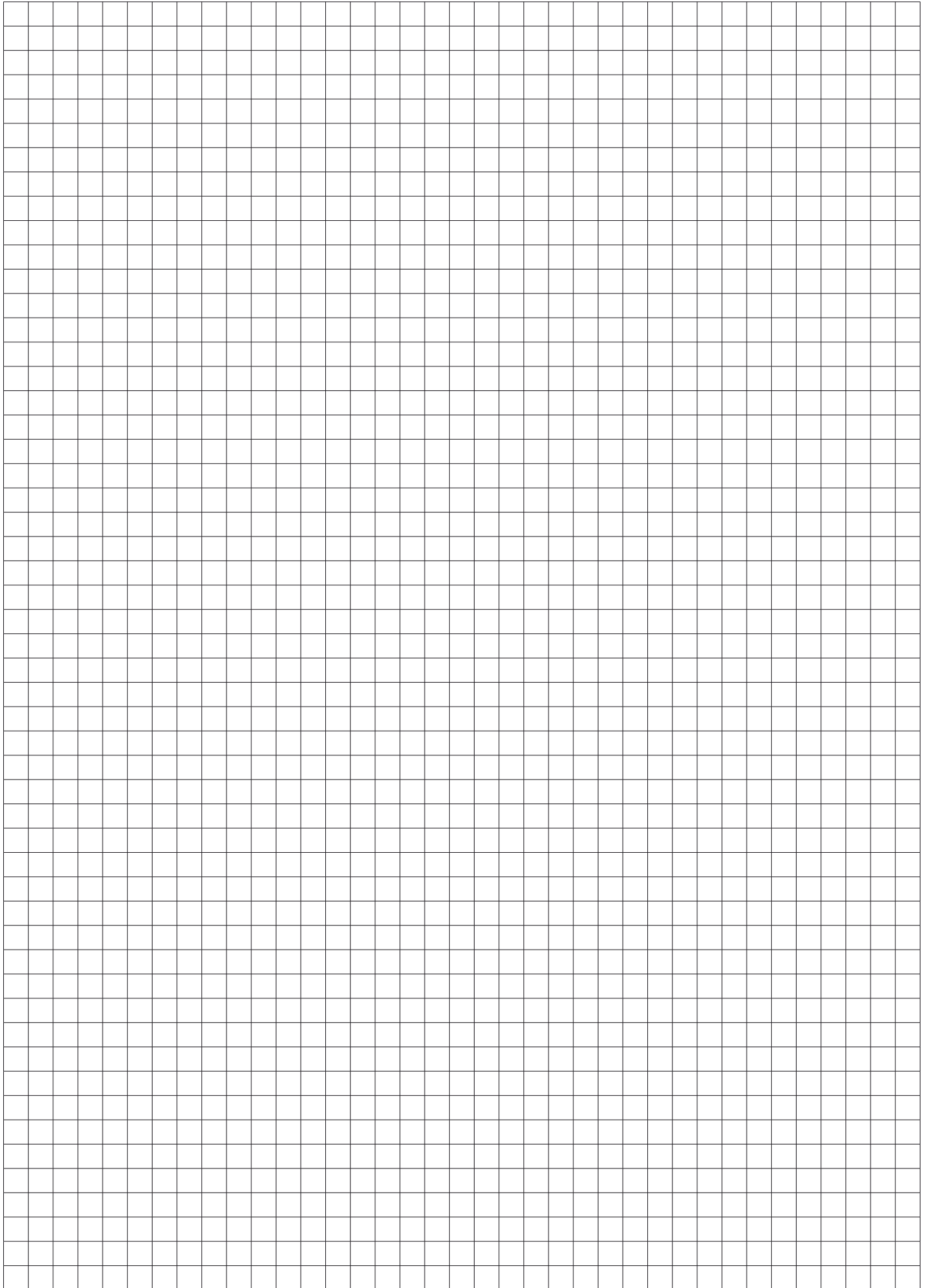

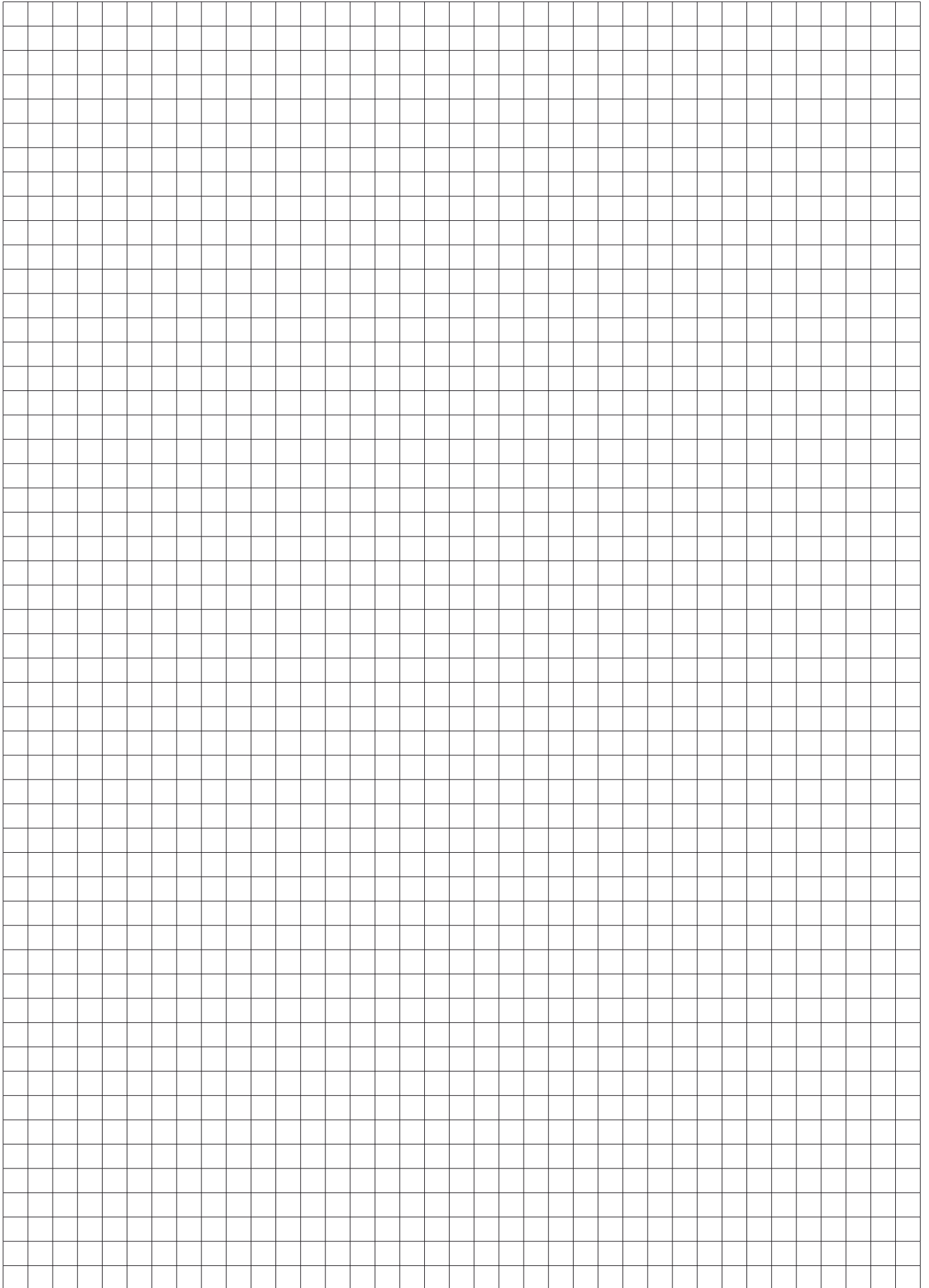

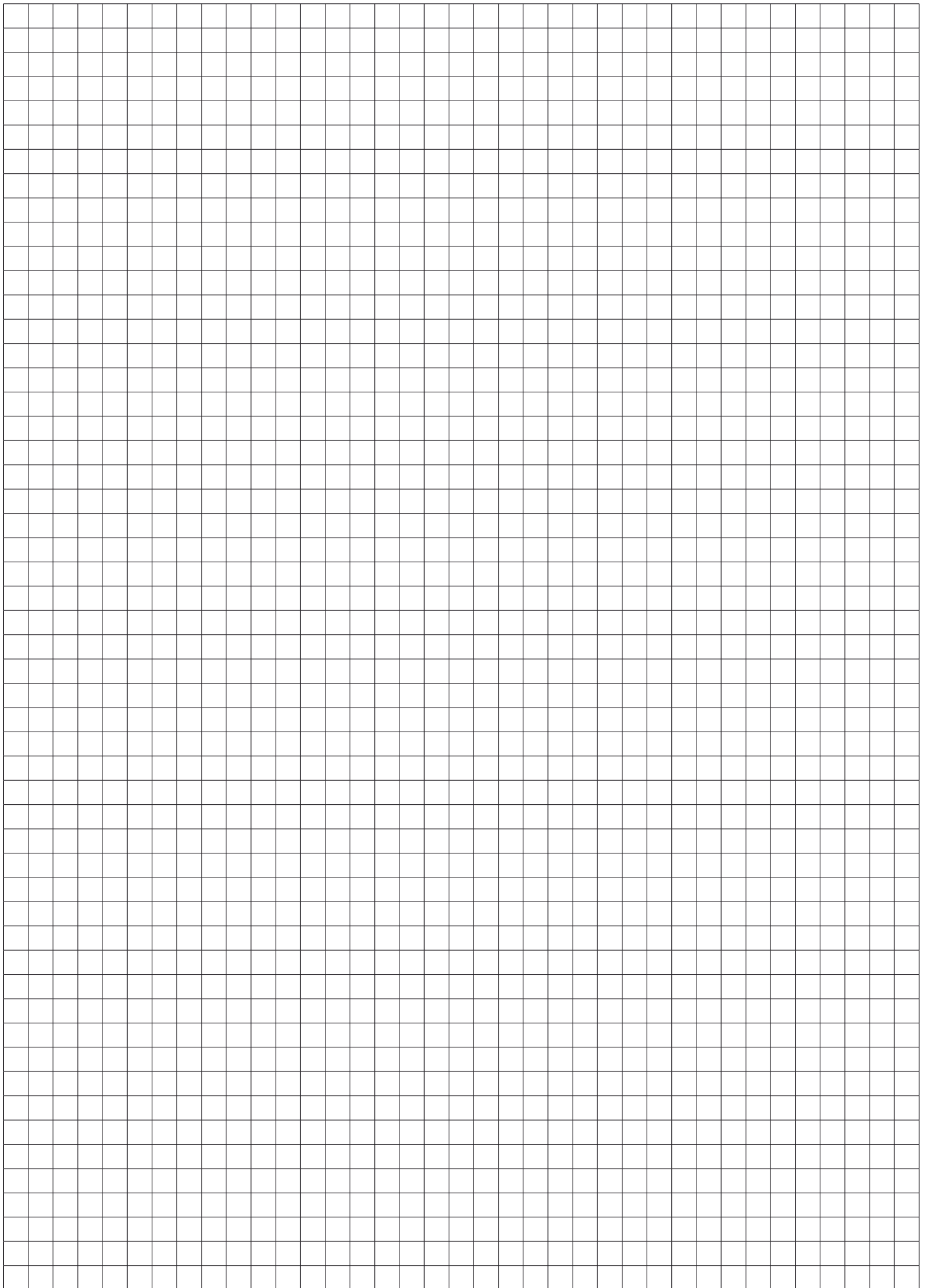

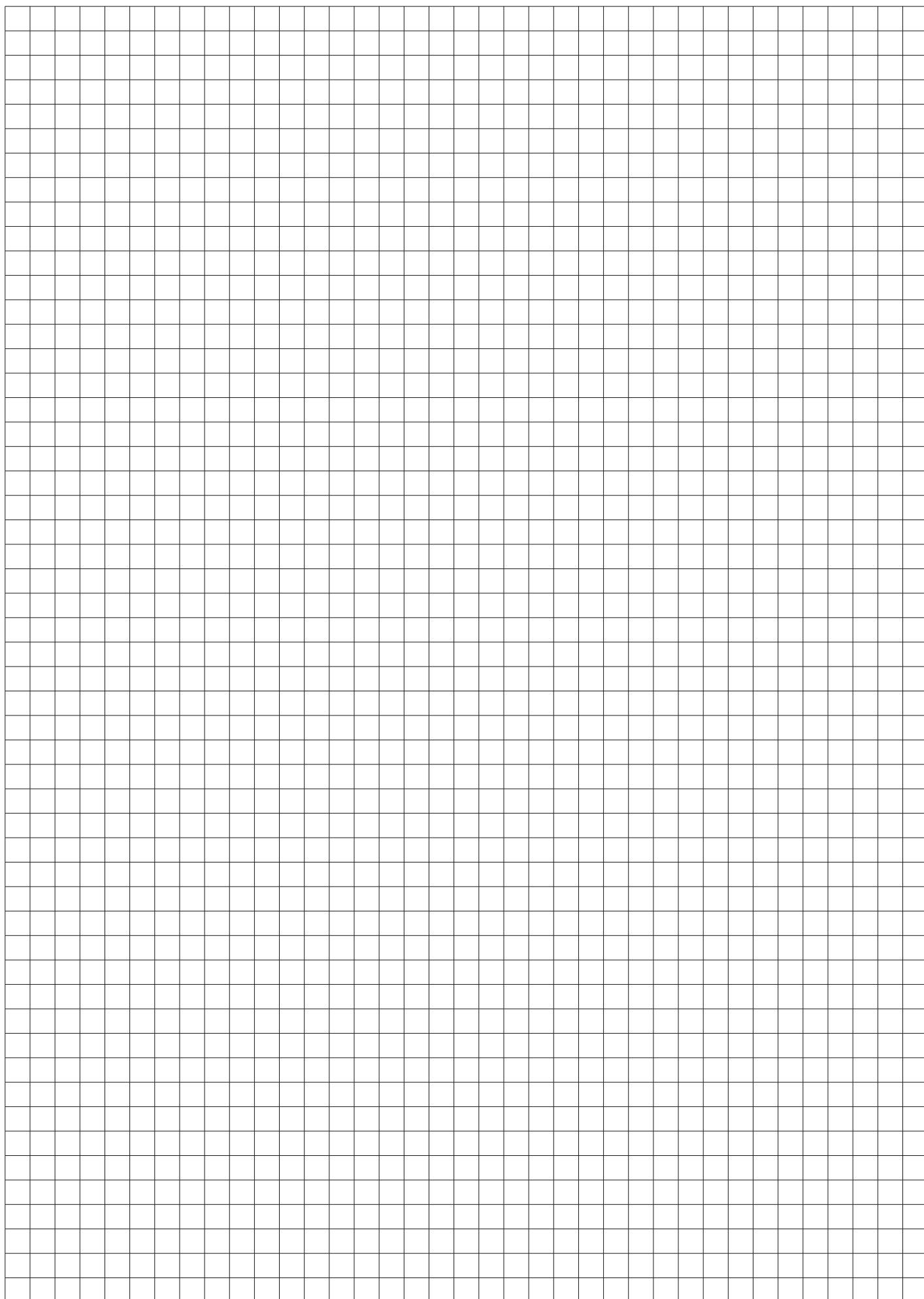

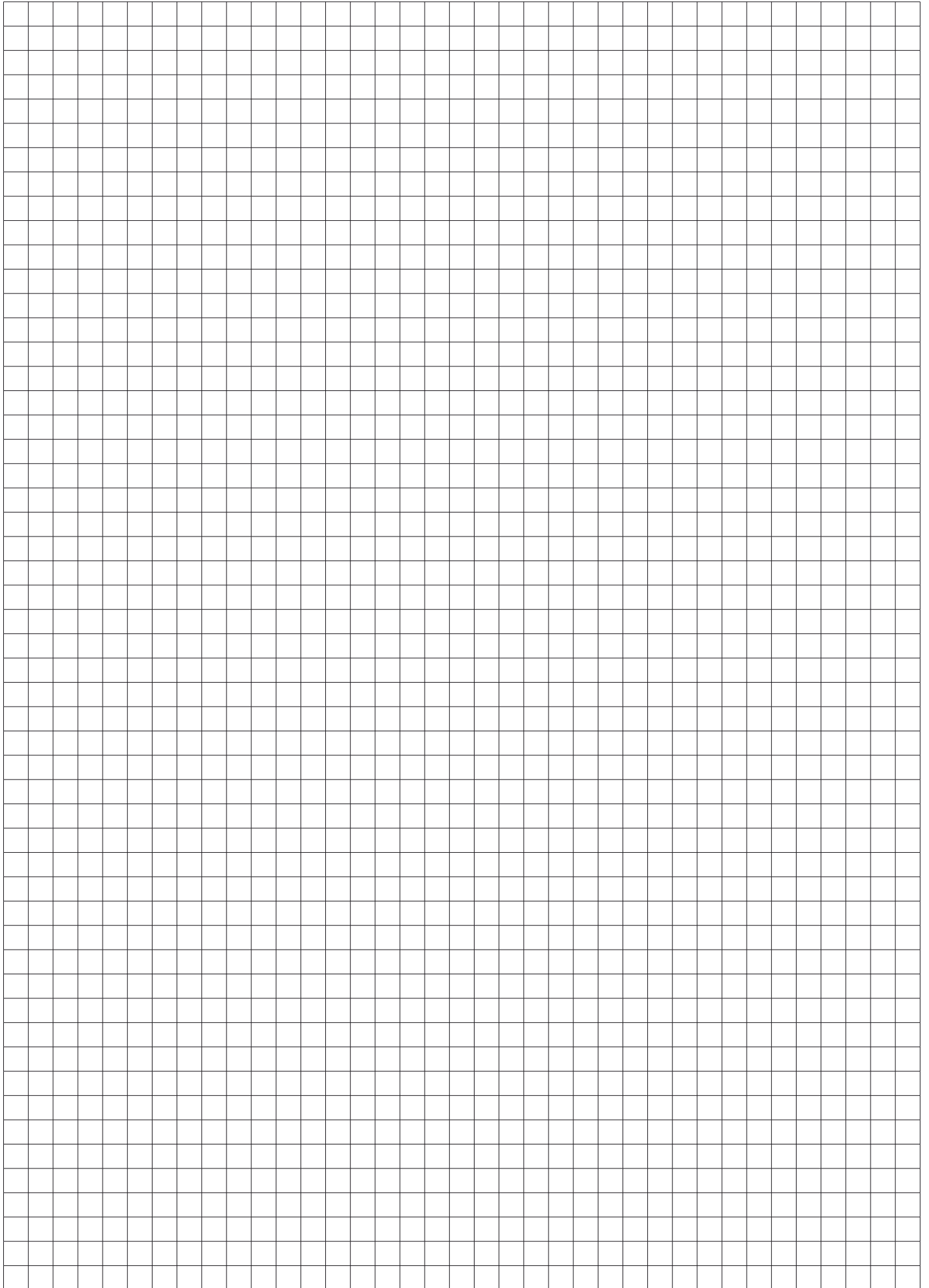

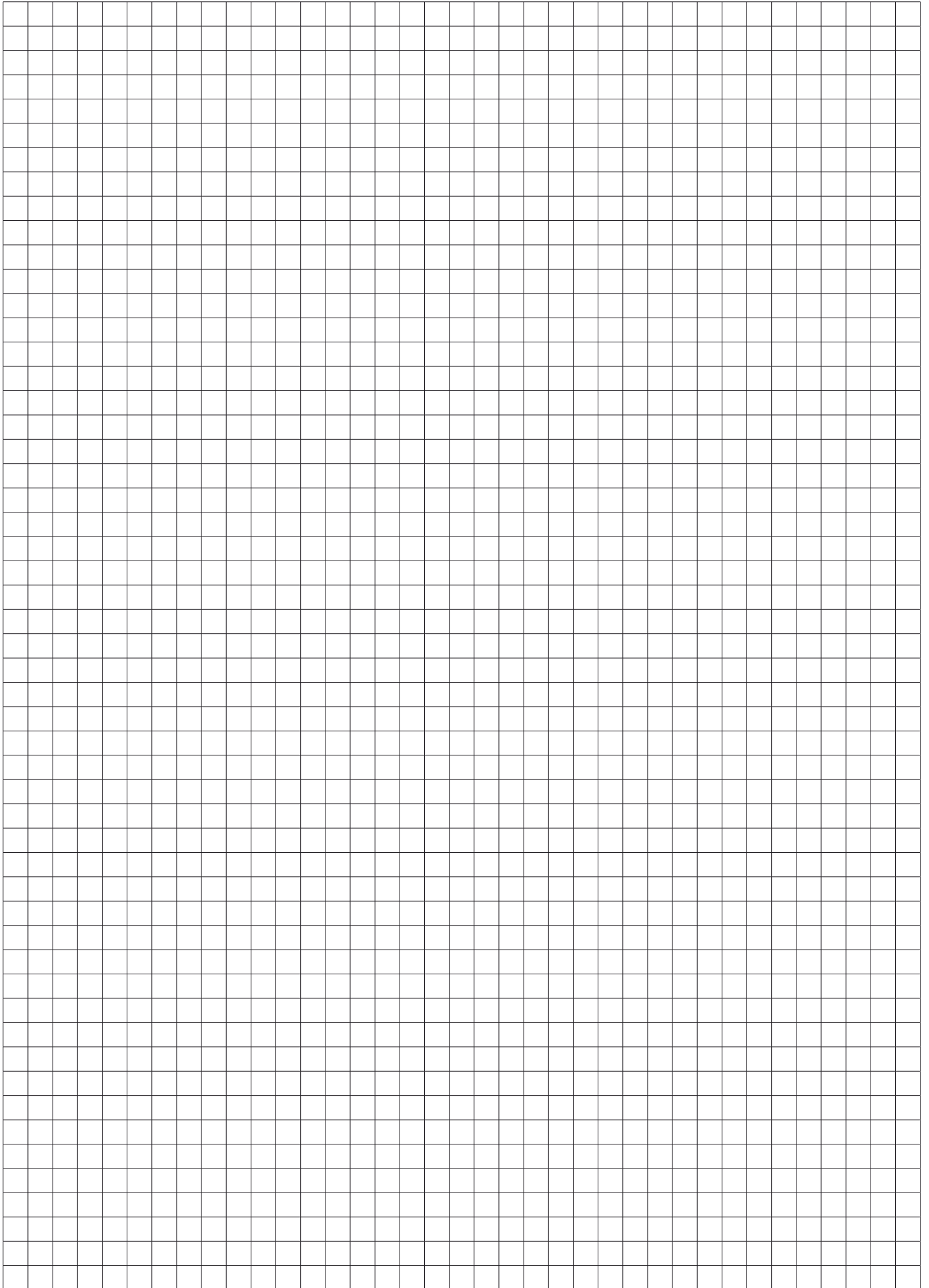

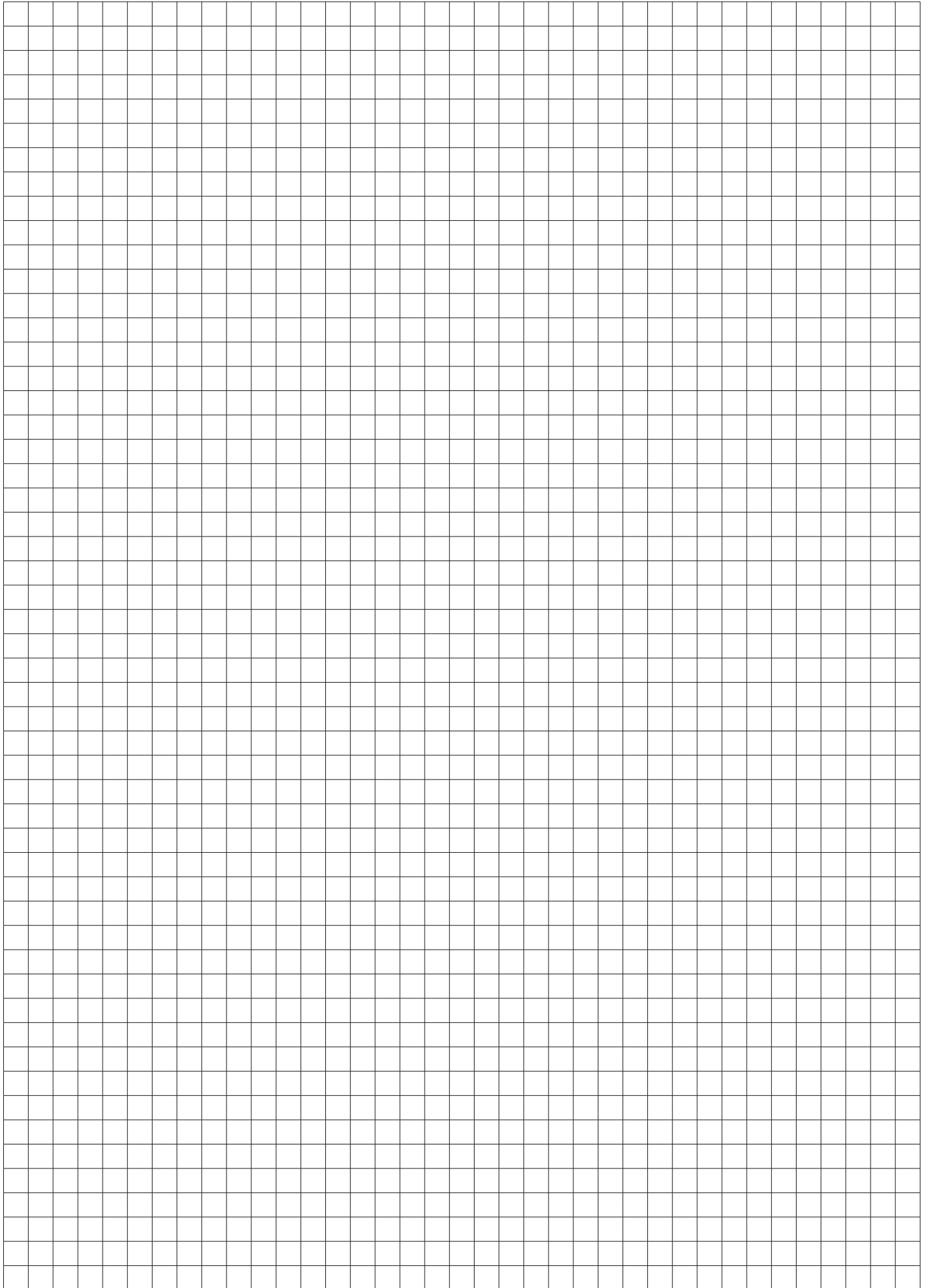

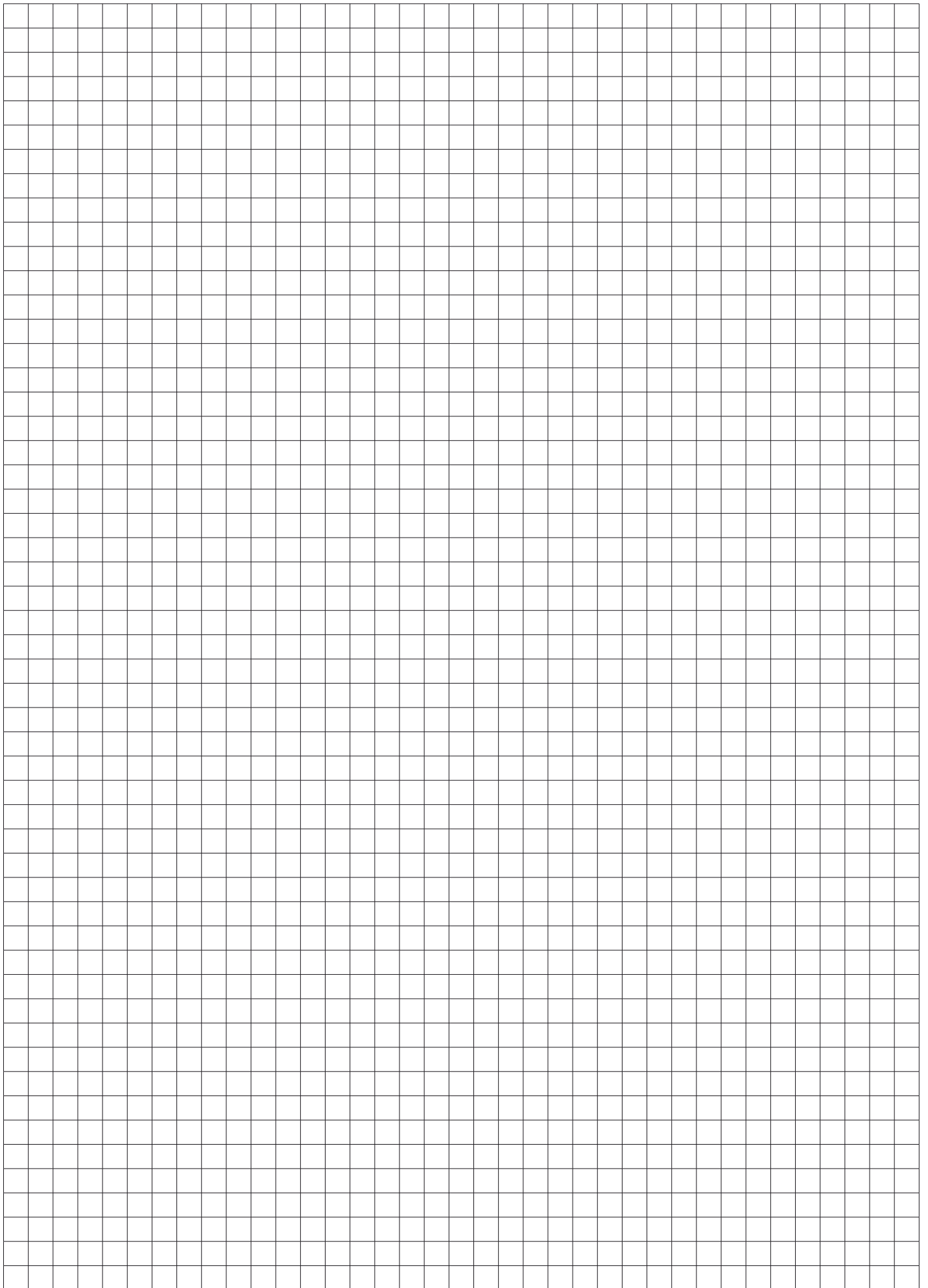

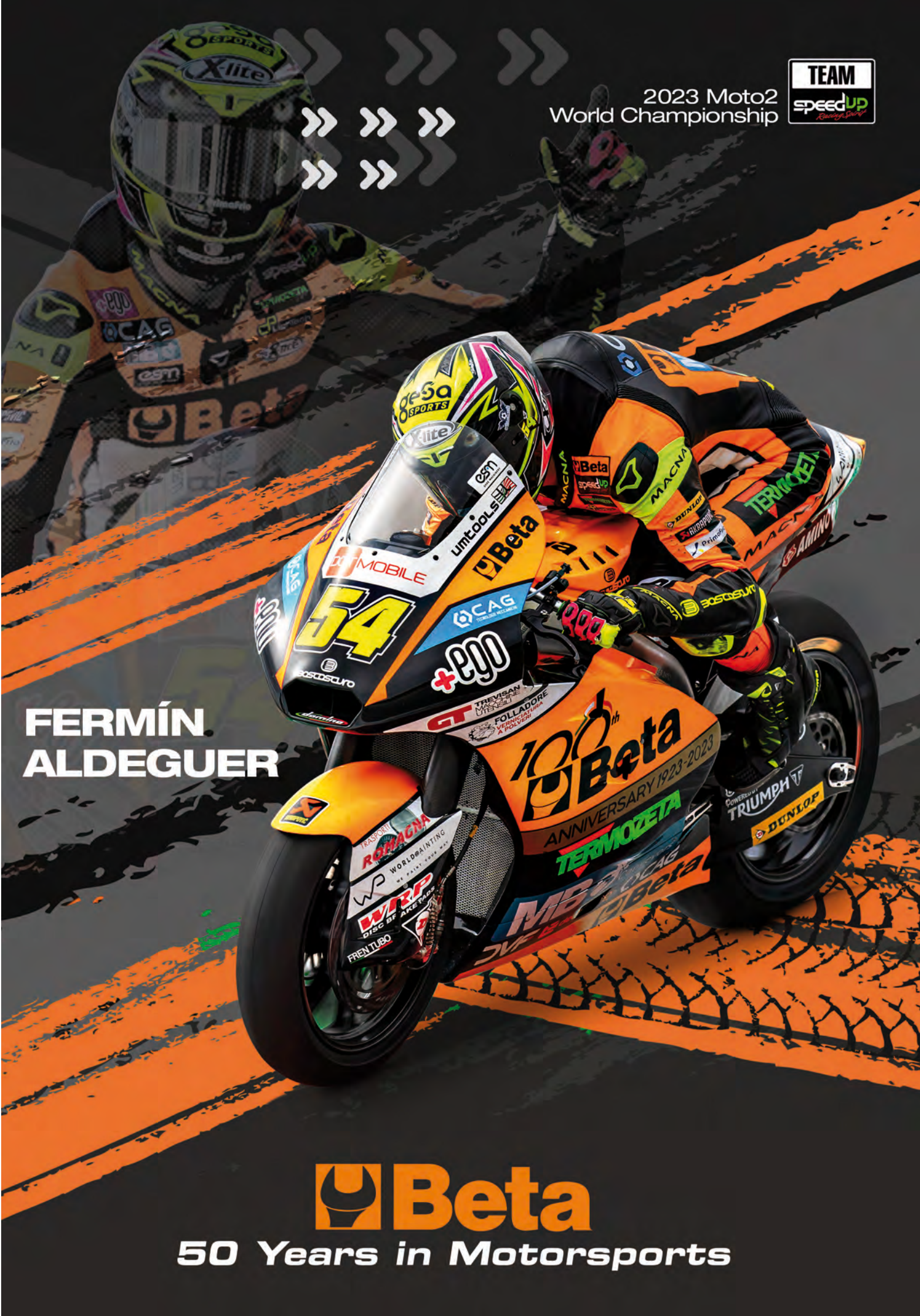

2023 Moto2
World Championship



**FERMÍN
ALDEGUER**

 **Beta**

50 Years in Motorsports

2023

PARTNERSHIP



Beta
AMBASSADOR

FABIO QUARTARARO
2023 MotoGP
World Championship



Technical Partner

