

## Système modulaire de mobilier d'atelier

Valable du 01.03.2023 - 30.04.2023



Multiplex en hêtre



Acier inoxydable 430

Art. 3964K-45S0 | 3964K-45S0IX

### KRAFTWERK MOBILIO 3 éléments Combi-Standard

- 1 Meuble bas avec 4 tiroirs
- 1 Meuble bas avec 5 tiroirs
- 1 Meuble bas avec 2 portes, 1 tablette inclusive
- 1 Plan de travail Multiplex en hêtre pour 3 éléments ou optionnelle
- 1 Plan de travail acier inoxydable pour 3 éléments

+ H 910 x L 2040 x P 458 mm



Art.	Plan de travail	Épaisseur	Prix CHF	
3964K-45S0	Multiplex en hêtre	35 mm	1669.-	2500.-
3964K-45S0IX	Acier inoxydable 430	38 mm	1774.-	2650.-

## Meubles modulaires configurés I vide



+ H 910 x L 1360 x P 458 mm

Art.	Plan de travail	Épaisseur	Prix CHF	
<b>3964K-S500</b>	Multiplex en hêtre	35 mm	<b>1028.-</b>	<del>1640.-</del>
<b>3964K-S500IX</b>	Acier inoxydable 430	38 mm	<b>1049.-</b>	<del>1790.-</del>



+ H 910 x L 1360 x P 458 mm

Art.	Plan de travail	Épaisseur	Prix CHF	
<b>3964K-940</b>	Multiplex en hêtre	35 mm	<b>1259.-</b>	<del>1980.-</del>
<b>3964K-940IX</b>	Acier inoxydable 430	38 mm	<b>1322.-</b>	<del>2050.-</del>



+ H 2000 x L 1360 x P 488 mm

Art.	Plan de travail	Épaisseur	Prix CHF	
<b>3964K-9S-W</b>	Multiplex en hêtre	35 mm	<b>1354.-</b>	<del>2080.-</del>
<b>3964K-9S-WIX</b>	Acier inoxydable 430	38 mm	<b>1417.-</b>	<del>2160.-</del>



+ H 2000 x L 1360 x P 488 mm

Art.	Plan de travail	Épaisseur	Prix CHF	
<b>3964K-S5-W</b>	Multiplex en hêtre	35 mm	<b>1289.-</b>	<del>1980.-</del>
<b>3964K-S5-WIX</b>	Acier inoxydable 430	38 mm	<b>1349.-</b>	<del>2040.-</del>



+ H 2000 x L 1360 x P 488 mm

Art.	Plan de travail	Épaisseur	Prix CHF	
<b>3964K-9S-K2</b>	Multiplex en hêtre	35 mm	<b>1627.-</b>	<del>2610.-</del>
<b>3964K-9S-K2IX</b>	Acier inoxydable 430	38 mm	<b>1679.-</b>	<del>2670.-</del>



+ H 2000 x L 1360 x P 488 mm

Art.	Plan de travail	Épaisseur	Prix CHF	
<b>3964K-95K2</b>	Multiplex en hêtre	35 mm	<b>1774.-</b>	<del>2880.-</del>
<b>3964K-95K2IX</b>	Acier inox. 430	38 mm	<b>1784.-</b>	<del>2940.-</del>



+ H 2000 x L1 894 x L2 894 x P 488 mm

Art.	Plan de travail	Épaisseur	Prix CHF	
<b>3964K-ECK</b>	Multiplex en hêtre	35 mm	<b>1291.-</b>	<del>2220.-</del>
<b>3964K-ECKIX</b>	Acier inoxydable 430	38 mm	<b>1354.-</b>	<del>2290.-</del>

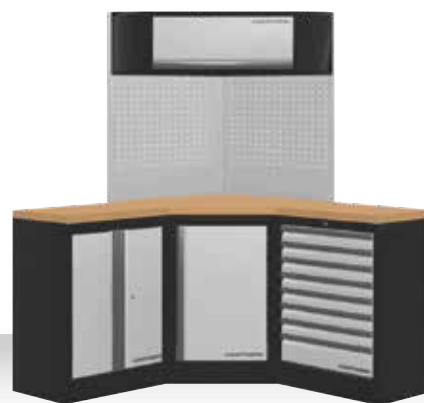

+ H 2000 x L1 1574 x L2 1574 x P 488 mm

Art.	Plan de travail	Épaisseur	Prix CHF	
<b>3964R</b>	Multiplex en hêtre	35 mm	<b>2590.-</b>	<del>3110.-</del>
<b>3964RIX</b>	Acier inoxydable 430	38 mm	<b>2700.-</b>	<del>3430.-</del>



+ H 910 x L 2040 x P 458 mm

Art.	Plan de travail	Épaisseur	Prix CHF	
<b>3964K-905</b>	Multiplex en hêtre	35 mm	<b>1364.-</b>	<del>2130.-</del>
<b>3964K-905IX</b>	Acier inoxydable 430	38 mm	<b>1469.-</b>	<del>2260.-</del>



+ H 910 x L 2040 x P 458 mm

Art.	Plan de travail	Épaisseur	Prix CHF	
<b>3964K-95M</b>	Multiplex en hêtre	35 mm	<b>1774.-</b>	<del>2810.-</del>
<b>3964K-95MIX</b>	Acier inoxydable 430	38 mm	<b>1889.-</b>	<del>2940.-</del>



+ H 910 x L 2040 x P 458 mm

Art.	Plan de travail	Épaisseur	Prix CHF	
<b>3964K-SR9</b>	Multiplex en hêtre	35 mm	<b>2047.-</b>	<del>2790.-</del>
<b>3964K-SR9IX</b>	Acier inoxydable 430	38 mm	<b>2152.-</b>	<del>2920.-</del>



+ H 910 x L 2040 x P 458 mm

Art.	Plan de travail	Épaisseur	Prix CHF	
<b>3964K-4R8</b>	Multiplex en hêtre	35 mm	<b>1994.-</b>	<del>2960.-</del>
<b>3964K-4R8IX</b>	Acier inoxydable 430	38 mm	<b>2152.-</b>	<del>3090.-</del>

## Meubles modulaires configurés I vide

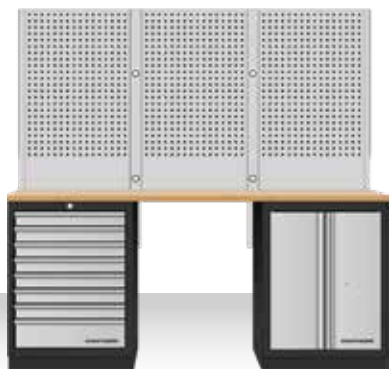

+ H 2000 x L 2040 x P 488 mm

Art.	Plan de travail	Épaisseur	Prix CHF	
<b>3964K-80S-W</b>	Multiplex en hêtre	35 mm	<b>1627.-</b>	<del>2290.-</del>
<b>3964K-80S-WIX</b>	Acier inoxydable 430	38 mm	<b>1774.-</b>	<del>2440.-</del>



+ H 2000 x L 2040 x P 488 mm

Art.	Plan de travail	Épaisseur	Prix CHF	
<b>3964K-85S-W</b>	Multiplex en hêtre	35 mm	<b>1994.-</b>	<del>3120.-</del>
<b>3964K-85S-WIX</b>	Acier inoxydable 430	38 mm	<b>2099.-</b>	<del>3260.-</del>



+ H 2000 x L 2040 x P 488 mm

Art.	Plan de travail	Épaisseur	Prix CHF	
<b>3964K-87S-W</b>	Multiplex en hêtre	35 mm	<b>2299.-</b>	<del>3230.-</del>
<b>3964K-87S-WIX</b>	Acier inoxydable 430	38 mm	<b>2414.-</b>	<del>3360.-</del>



+ H 2000 x L 2040 x P 488 mm

Art.	Plan de travail	Épaisseur	Prix CHF	
<b>3964K-85S-K3</b>	Multiplex en hêtre	35 mm	<b>2299.-</b>	<del>3900.-</del>
<b>3964K-85S-K3IX</b>	Acier inoxydable 430	38 mm	<b>2414.-</b>	<del>3980.-</del>



+ H 2000 x L 1960 x P 488 mm

Art.	Plan de travail	Épaisseur	Prix CHF	
<b>3964A</b>	Multiplex en hêtre	35 mm	<b>2299.-</b>	<del>2970.-</del>
<b>3964Aix</b>	Acier inoxydable 430	38 mm	<b>2362.-</b>	<del>3030.-</del>



+ H 2000 x L 2275 x P 458 mm

Art.	Plan de travail	Épaisseur	Prix CHF	
<b>3964K-H25S</b>	Multiplex en hêtre	35 mm	<b>1889.-</b>	<del>2890.-</del>
<b>3964K-H25SIX</b>	Acier inoxydable 430	38 mm	<b>2047.-</b>	<del>2960.-</del>



+ H 910 x L 2720 x P 458 mm

Art.	Plan de travail	Épaisseur	Prix CHF	
<b>3964K-854S</b>	Multiplex en hêtre	35 mm	<b>2204.-</b>	<del>3540.-</del>
<b>3964K-854SIX</b>	Acier inoxydable 430	38 mm	<b>2299.-</b>	<del>3680.-</del>



+ H 2000 x L 2640 x P 488 mm

Art.	Plan de travail	Épaisseur	Prix CHF	
<b>3964K-H5R4-K1W</b>	Multiplex en hêt.	35 mm	<b>2834.-</b>	<del>4610.-</del>
<b>3964K-H5R4-K1WIX</b>	Acier inox. 430	38 mm	<b>2939.-</b>	<del>4750.-</del>



+ H 2000 x L 2640 x P 458 mm

Art.	Plan de travail	Épaisseur	Prix CHF	
<b>3964K-H504</b>	Multiplex en hêtre	35 mm	<b>1889.-</b>	<del>2890.-</del>
<b>3964K-H504IX</b>	Acier inoxydable 430	38 mm	<b>2047.-</b>	<del>3030.-</del>



+ H 2000 x L 2720 x P 488 mm

Art.	Plan de travail	Épaisseur	Prix CHF	
<b>3964K-S854-K4</b>	Multiplex en h.	35 mm	<b>3359.-</b>	<del>5250.-</del>
<b>3964K-S854-K4IX</b>	Acier inox. 430	38 mm	<b>3464.-</b>	<del>5390.-</del>



+ H 2000 x L 2640 x P 488 mm

Art.	Plan de travail	Épaisseur	Prix CHF	
<b>3964B</b>	Multiplex en hêtre	35 mm	<b>2939.-</b>	<del>4150.-</del>
<b>3964Bix</b>	Acier inoxydable 430	38 mm	<b>3097.-</b>	<del>4290.-</del>

## Meubles modulaires configurés I vide



+ H 2000 x L 2955 x P 488 mm

Art.	Plan de travail	Épaisseur	Prix CHF	
3964D	Multiplex en hêtre	35 mm	<b>3254.-</b>	<del>4680.-</del>
3964Dix	Acier inoxydable 430	38 mm	<b>3359.-</b>	<del>4810.-</del>



+ H 2000 x L 2955 x P 488 mm

Art.	Plan de travail	Épaisseur	Prix CHF	
3964G	Multiplex en hêtre	35 mm	<b>2939.-</b>	<del>3730.-</del>
3964Gix	Acier inoxydable 430	38 mm	<b>3044.-</b>	<del>3870.-</del>



+ H 2000 x L 3320 x P 488 mm

Art.	Plan de travail	Épais.	Prix CHF	
3964K-H5049-K4	Multiplex en hêtre	35 mm	<b>3254.-</b>	<del>5720.-</del>
3964K-H5049-K4IX	Acier inox. 430	38 mm	<b>3359.-</b>	<del>5860.-</del>



+ H 2000 x L 3635 x P 488 mm

Art.	Plan de travail	Épais.	Prix CHF	
3964H	Multiplex en hêtre	35 mm	<b>3674.-</b>	<del>4910.-</del>
3964HIX	Acier inoxydable 430	38 mm	<b>3779.-</b>	<del>5040.-</del>



+ H 2000 x L 3920 x P 488 mm

Art.	Plan de travail	Épais.	Prix CHF	
3964K-HS745H-K4	Multiplex en hêtre	35 mm	<b>4724.-</b>	<del>6800.-</del>
3964K-HS745H-K4IX	Acier inox. 430	38 mm	<b>4829.-</b>	<del>6820.-</del>



+ H 2000 x L 3920 x P 488 mm

Art.	Plan de travail	Épais.	Prix CHF	
<b>3964F</b>	Multiplex en hêtre	35 mm	<b>4409.-</b>	<del>5940.-</del>
<b>3964Fix</b>	Acier inox. 430	38 mm	<b>4514.-</b>	<del>6070.-</del>



+ H 2000 x L 4235 x P 488 mm

Art.	Plan de travail	Épais.	Prix CHF	
<b>3964K-H284S5H-K4</b>	Multiplex en hêtre	35 mm	<b>4672.-</b>	<del>7540.-</del>
<b>3964K-H284S5H-K4IX</b>	Acier inox. 430	38 mm	<b>4829.-</b>	<del>7680.-</del>



+ H 2000 x L1 3849 x L2 2824 x P 488 mm

Art.	Plan de travail	Épaisseur	Prix CHF	
<b>3964E</b>	Multiplex en hêtre	35 mm	<b>6562.-</b>	<del>8420.-</del>
<b>3964EIX</b>	Acier inox. 430	38 mm	<b>6772.-</b>	<del>8630.-</del>



+ H 2000 x L1 2254 x L2 1574 x P 488 mm

Art.	Plan de travail	Épaisseur	Prix CHF	
<b>3964N</b>	Multiplex en hêtre	35 mm	<b>4724.-</b>	<del>6180.-</del>
<b>3964NIX</b>	Acier inox. 430	38 mm	<b>4829.-</b>	<del>6400.-</del>



+ H 2000 x L1 2254 x L2 2254 x P 488 mm

Art.	Plan de travail	Épaisseur	Prix CHF	
<b>3964O</b>	Multiplex en hêtre	35 mm	<b>5102.-</b>	<del>6850.-</del>
<b>3964OIX</b>	Acier inox. 430	38 mm	<b>5249.-</b>	<del>7090.-</del>



+ H 2000 x L1 3534 x L2 2254 x P 488 mm

Art.	Plan de travail	Épaisseur	Prix CHF	
<b>3964P</b>	Multiplex en hêtre	35 mm	<b>7244.-</b>	<del>9130.-</del>
<b>3964PIX</b>	Acier inox. 430	38 mm	<b>7349.-</b>	<del>9570.-</del>

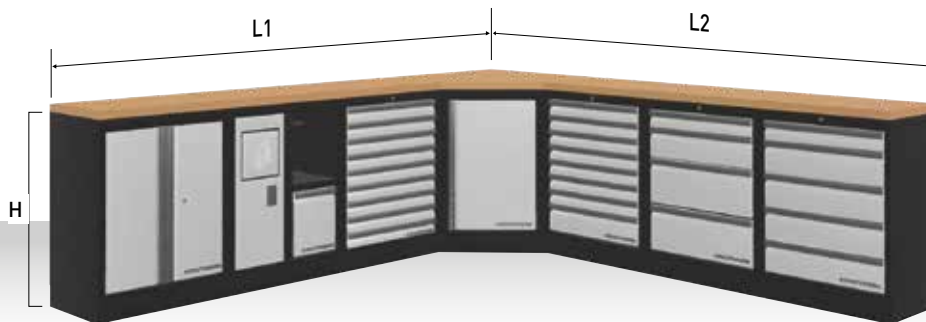

+ H 910 x L1 2934 x L2 2934 x P 488 mm

Art.	Plan de travail	Épaisseur	Prix CHF	
<b>3964M</b>	Multiplex en hêtre	35 mm	<b>5144.-</b>	<del>6790.-</del>
<b>3964MIX</b>	Acier inox. 430	38 mm	<b>5249.-</b>	<del>7050.-</del>

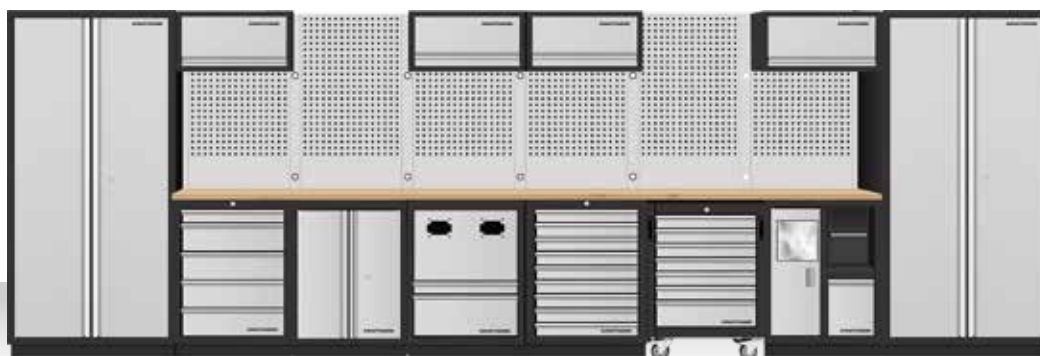

+ H 2000 x L 5910 x P 488 mm

Art.	Plan de travail	Épaisseur	Prix CHF	
<b>3964Q</b>	Multiplex en hêtre	35 mm	<b>7349.-</b>	<del>9760.-</del>
<b>3964QIX</b>	Acier inox. 430	38 mm	<b>7559.-</b>	<del>10240.-</del>



+ H 2000 x B 3635 x P 488 mm

Art.	Plan de travail	Épais.	Prix CHF	
<b>3964Dix-SANA</b>	Acier inox. 430	38 mm	<b>4610.-</b>	<del>6710.-</del>





## Plans de travail



### Plans de travail multiplex

- Constitué de plusieurs couches de placages découpés en rotation (collés)
- Les placages sont posés en travers
- Matériel : bois de hêtre
- Haute résistance et stabilité dimensionnelle
- Aspect naturel

### Acier inoxydable 430

- Densité : 7,70 g/cm<sup>3</sup>
- Acier Ferritique
- Teneur en chrome de 17 %
- Bonne résistance à la corrosion
- Bonne polissabilité
- Bonne résistance l'eau, contre la vapeur d'eau, l'humidité de l'air
- Bonne résistance à les acides et les alcalis faibles

Matériel * Matériel et prix sur demand	463 x 680 mm pour 1 élément	463 x 1361 mm pour 2 éléments	463 x 2041 mm pour 3 éléments	463 x 864 mm pour meuble d'angle 3964-16	Épaisseur mm
Plans de travail multiplex	Art. 3964-08 <b>153.-</b>	Art. 3964-09 <b>277.-</b>	Art. 3964-18 <b>373.-</b> <del>380.-</del>	Art. 3964-16-99 <b>277.-</b>	35
Acier inoxydable 430	Art. 3964-20 <b>199.-</b>	Art. 3964-21 <b>355.-</b> <del>360.-</del>	Art. 3964-22 <b>466.-</b> <del>470.-</del>	Art. 3964-23 <b>371.-</b> <del>380.-</del>	38

## Éléments individuels de meubles modulaires | vide

À assembler selon vos propres besoins. Construction indépendante, aucune fixation n'est nécessaire et donc très souple à mettre en place. Chaque module peut être commandé individuellement. Tiroirs avec roulements à billes de différentes hauteurs, adaptés à tous les outils de la société KRAFTWERK (plateaux durs COMPLETEO, EVA, EVA3) avec fermeture centrale et verrouillable individuellement.

Grâce à notre solution „One-Key“, il est possible d'équiper toutes les serrures d'un même numéro de serrure, de sorte qu'une seule clé est nécessaire.

Large gamme d'accessoires assortis aux panneaux arrière à trous carrés pour le stockage d'outils professionnels. Différents modèles peuvent être sélectionnés comme plans de travail, selon le domaine d'application: Hêtre multiplex/bois | Acier inoxydable 430 (sur demande).

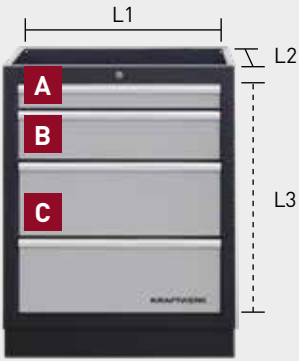

**Dimensions des tiroirs de :**

- 3964-04 (2C+1B+1A)
- 3964-05 (4B+1A)
- 3964-13 (9A)
- 3964-14 (7A+1B)
- 3964-15 (6A+1B)
- 3964-28 (1A+1C)

	L1 (mm)	L2 (mm)	L3 (mm)
<b>A</b>	560	404	58
<b>B</b>	560	404	138
<b>C</b>	560	404	207



Meuble bas, 2 portes avec 1 étagère

Art.	Dimension   Poids	Prix CHF
<b>3964-03</b>	H 910 x L 680 x P 458 mm   ⚖ 29.4 kg	<b>555.-</b> <del>560.-</del>



Meuble bas  
4 tiroirs roulement à billes extraction complète





Art.	Dimension   Poids	Prix CHF
<b>3964-04</b>	H 910 x L 680 x P 458 mm   ⚖ 46.7 kg	<b>770.-</b> <del>780.-</del>





Meuble bas  
5 tiroirs roulement à billes extraction complète



Art.	Dimension   Poids	Prix CHF
<b>3964-05</b>	H 910 x L 680 x P 458 mm   ⚖ 49.3 kg	<b>826.-</b> <del>840.-</del>

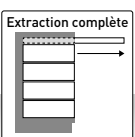

Meuble bas avec poubelle intégrée et support pour rouleaux essuie-tout

Art.	Dimension   Poids	Prix CHF
<b>3964-11</b>	H 910 x L 680 x P 458 mm   ⚖ 37 kg	<b>682.-</b> <del>690.-</del>



Meuble bas  
9 tiroirs roulement à billes extraction complète



Art.	Dimension   Poids	Prix CHF
<b>3964-13</b>	H 910 x L 680 x P 458 mm   ⚖ 55 kg	<b>936.-</b> <del>950.-</del>



Meuble bas  
8 tiroirs roulement à billes extraction complète



Art.	Dimension   Poids	Prix CHF
<b>3964-14</b>	H 910 x L 680 x P 458 mm   ⚖ 52.5 kg	<b>880.-</b> <del>890.-</del>

Meuble bas roulant  
7 tiroirs roulement à billes  
extraction complète

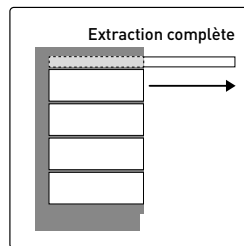
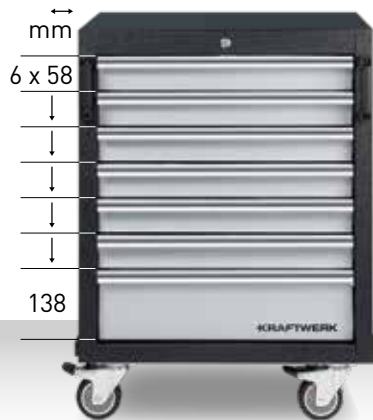

Meuble bas pour enrouleur de câble  
et tuyau air comprimé avec 2 tiroirs  
roulement à billes avec extraction  
complète

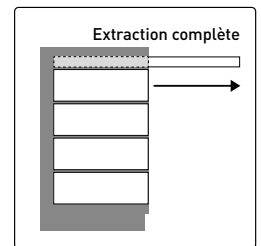
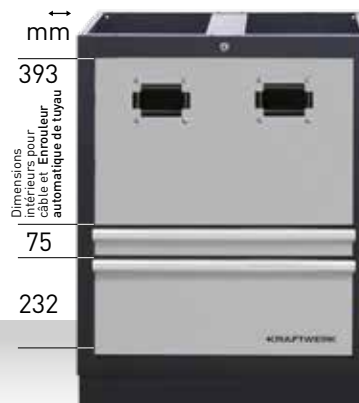

Art.	Dimension   Poids	Prix CHF
3964-15	H 646 x L 862 x P 458 mm   ⚖ 51 kg	936.- / 950.-

Art.	Dimension   Poids	Prix CHF
3964-28	H 910 x L 680 x P 458 mm   ⚖ 40 kg	734.- / 750.-

Meuble d'angle bas  
1 porte  
1 étagère incluse



Art.	Dimension   Poids	Prix CHF
3964-16	H 910 x L 864 x P 458 mm   ⚖ 42 kg	1035.- / 1050.-

Meuble haut  
d'angle avec vérins

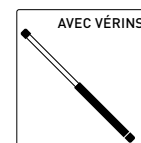

Art.	Dimension   Poids	Prix CHF
3964-25	H 350 x L 865 x P 281 mm   ⚖ 21 kg	585.- / 590.-

Meuble haut  
avec vérins



Art.	Dimension   Poids	Prix CHF
3964-01	H 350 x L 680 x P 281 mm   ⚖ 10 kg	265.-



Art.	Dimension   Poids	Prix CHF
3964-19	H 350 x L 680 x P 281 mm   ⚖ 8.4 kg	<b>189.-</b> <del>221.-</del>



Art.	Dimension   Poids	Prix CHF
3964-27	H 680 x L 680 x P 300 mm   ⚖ 16 kg	<b>286.-</b> <del>360.-</del>



3964-02-07

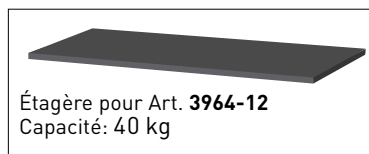

3964-02-01



Casier,  
4 étagère inclusif



Art.	Dimension   Poids	Prix CHF
3964-02	H 2000 x L 600 x P 458 mm   ⚖ 53 kg	<b>936.-</b> <del>950.-</del>
3964-02-07	H 20 x L 590 x P 430 mm   ⚖ 0.30 kg	<b>49.-</b>



Armoire  
à portes  
battantes avec  
4 étagères



Art.	Dimension   Poids	Prix CHF
3964-12	H 2000 x L 915 x P 458 mm   ⚖ 74 kg	<b>1228.-</b> <del>1230.-</del>
3964-02-01	H 20 x L 905 x P 430 mm   ⚖ 0.60 kg	<b>74.-</b>

## Éléments individuels de meubles modulaires I vide

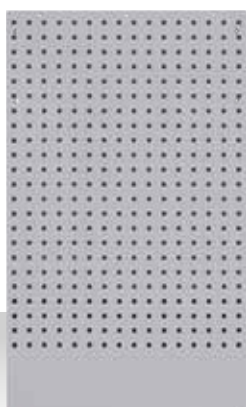

Plateau perforé mural

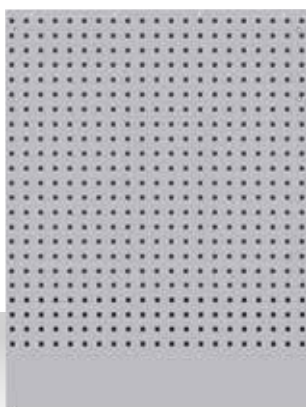

Plateau perforé mural pour Art. 3964-16

Art.	Dimension   Poids	Prix CHF
3964-29	H 1052 x L 615 x P 24 mm   ⚖ 5.3 kg	110.-
3964-30	H 1052 x L 800 x P 24 mm   ⚖ 6.7 kg	127.-

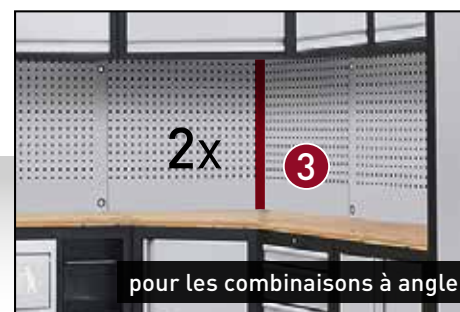

Art.	Description	Prix CHF
3964-03-07	Solution One-Key (verrou 90°) pour Art. 3964-02   3964-03   3964-12   3964-16   3964-27	6.90
3964-04-10	Solution One-Key (verrou 180°) pour Art. 3964-04   3964-05   3964-13   3964-14   3964-15   3964-28	6.90

Art.	Description   Dimension	Prix CHF
3964-24 ①	Barre de connexion à travers 2 éléments H 1420 x L 65 x P 30 mm	60.-
3964-07 ②	Barre de connexion à travers 2 éléments avec ouverture du cables H 1420 x L 65 x P 30 mm	60.-
3964-10 ③	Bielle pour le cadre extérieur H 1420 x L 32,5 x P 30 mm	23.40

## Accessoires pour mur perforé

Art.	Description   Dimension	Prix CHF	
3964-29-01	Compartment pour boîtes et bouteilles, 100 x B 330 x T 100 mm	26.50	31.-



Art.	Description   Dimension	Prix CHF	
145.111.035	Crochet étroit coudé à angle droit 35 mm	3.90	7.20
145.111.070	Crochet étroit coudé à angle droit 70 mm	3.90	7.20
145.111.135	Crochet étroit coudé à angle droit 135 mm	4.90	8.30





Art.	Description   Dimension	Prix CHF	
3964-29-11	Support pour bacs à bec H 54 x B 440 x T 15.5 mm	5.90	6.80

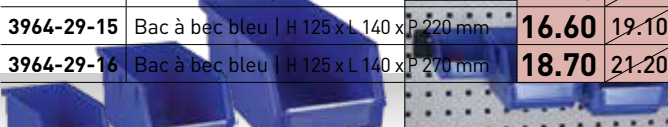

Art.	Description   Dimension	Prix CHF	
145.112.035	Crochet double coudé à angle droit 35 mm	6.90	12.40
145.112.075	Crochet double coudé à angle droit 75 mm	6.90	12.40
145.112.150	Crochet double coudé à angle droit 150 mm	9.50	15.60

Art.	Description   Dimension	Prix CHF	
3964-29-14	Bac à bec bleu   H 75 x L 105 x P 140 mm	7.40	8.70
3964-29-15	Bac à bec bleu   H 125 x L 140 x P 220 mm	16.60	19.10
3964-29-16	Bac à bec bleu   H 125 x L 140 x P 270 mm	18.70	21.20

Art.	Description   Dimension   Poids	Prix CHF	
145.125.035	Support de pinces L 35 x P 20 mm   ⚖ 62 g	6.90	12.80
145.125.075	Support de pinces L 75 x P 20 mm   ⚖ 62 g	8.90	14.90

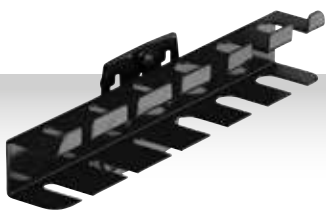

Art.	Description   Dimension	Prix CHF	
145.129.200	Support pour tournevis, pour 6 pièces L 200 x P 30 mm   Ø 200 g	22.90	39.-
145.129.390	Support pour tournevis, pour 12 pièces 12 pièces L 390 x P 30 mm   Ø 400 g	32.-	49.-

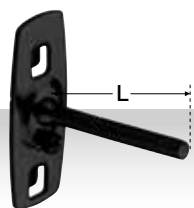

Art.	Description   Dimension   Poids	Prix CHF	
145.100.050	Crochet à tige droite L 50 mm   Ø 6 mm   Ø 34 g	4.20	7.60
145.100.102	Crochet à tige droite L 102 mm   Ø 6 mm   Ø 46 g	4.80	7.60
145.100.150	Crochet à tige droite L 150 mm   Ø 6 mm   Ø 56 g	4.80	7.60

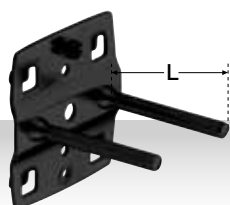

Art.	Description   Dimension   Poids	Prix CHF	
145.110.050	Crochet double à tiges droites L 50 mm   Ø 6 mm   Ø 74 g	6.30	10.90
145.110.102	Crochet double à tiges droites L 102 mm   Ø 6 mm   Ø 98 g	7.40	14.10
145.110.150	Crochet double à tiges droites L 150 mm   Ø 6 mm   Ø 118 g	6.90	13.90

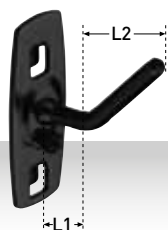

Art.	Description   Dimension   Poids	Prix CHF	
145.121.040	Crochet incliné pour inserts L1 15 x L2 35 mm   Ø 6 mm   Ø 34 g	4.90	8.60



Art.	Description   Dimension	Prix CHF	
145.126.060	Support circulaire Ø 60 mm   Ø 72 g	17.90	29.-
145.126.080	Support circulaire Ø 80 mm   Ø 80 g	17.90	32.-



Art.	Description   Dimension   Poids	Prix CHF	
145.129.227	Support pour clés plates, pour 10 clés H 75-145 x P 220 mm   Ø 480 g	32.-	49.-



Art.	Description   Dimension   Poids	Prix CHF	
145.130.200	Support pour forets Avec 14 trous: 2x Ø chacun 3.0-4.2-6.5-7.5-8.5-16.5 mm, chacun 1x Ø 10.5-12.5 mm L 200 x P 28 mm   Ø 200 g	22.-	38.-
145.130.390	Support pour forets Avec 28 trous: 4x Ø chacun 3.2-4.2-6.5-7.5-8.5-16.5 mm, chacun 2x Ø 10.5-12.5 mm L 390 x P 28 mm   Ø 400 g	39.-	62.-

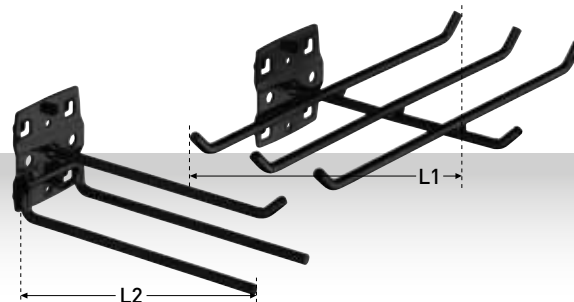

Art.	Description   Dimension   Poids	Prix CHF	
145.113.045	Support à 3 branches L1 45 x L2 150 mm Ø 6 mm   Ø 170 g	16.90	29.-
145.113.140	Support à 6 branches L1 240 x L2 140 mm Ø 6 mm   Ø 256 g	32.-	55.-

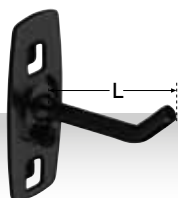

Art.	Description   Dimension   Poids	Prix CHF	
145.120.050	Crochet à tige inclinée L 50 mm   Ø 6 mm   ⚖ 34 g	3.90	7.40
145.120.100	Crochet à tige inclinée L 100 mm   Ø 6 mm   ⚖ 46 g	4.90	8.60
145.120.150	Crochet à tige inclinée L 150 mm   Ø 6 mm   ⚖ 56 g	4.90	8.60
145.120.200	Crochet à tige inclinée L 200 mm   Ø 6 mm   ⚖ 68 g	5.90	9.60

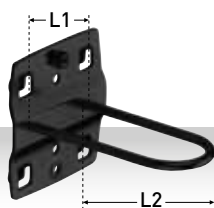

Art.	Description   Dimension   Poids	Prix CHF	
145.124.027	Support fermé long L1 27 x L2 65 mm   ⚖ 68 g	9.90	16.10



► Veuillez commander par deux

Art.	Description   Dimension   Poids	Prix CHF	
145.127.060	Support pour tubes W 35 mm   Ø 60 mm   ⚖ 114 g	17.90	30.-
145.127.100	Support pour tubes W 35 mm   Ø 100 mm   ⚖ 156 g	17.90	32.-



Art.	Description   Dimension	Prix CHF	
198.005.102	Boîtes à bec à suspendre, pour panneau perforé, 5 pcs. H 90 x L 75 x P 50 mm	17.90	21.20

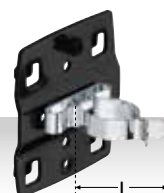

Art.	Description   Dimension   Poids	Prix CHF	
145.123.025	Pince pour outil, large plaque de base L 25 mm   Ø 25 mm   ⚖ 58 g	9.90	16.10
145.123.028	Pince pour outil, large plaque de base L 28 mm   Ø 28 mm   ⚖ 60 g	9.90	17.20
145.123.032	Pince pour outil, large plaque de base L 32 mm   Ø 23 mm   ⚖ 64 g	11.90	19.80



Art.	Description   Dimension   Poids	Prix CHF	
145.122.006	Pince pour outil, simple Ø 6 mm   ⚖ 24 g	5.90	9.60
145.122.010	Pince pour outil, simple Ø 10 mm   ⚖ 25 g	5.90	10.70
145.122.013	Pince pour outil, simple Ø 13 mm   ⚖ 26 g	5.90	9.60
145.122.016	Pince pour outil, simple Ø 16 mm   ⚖ 27 g	5.90	10.70
145.122.019	Pince pour outil, simple Ø 19 mm   ⚖ 28 g	5.90	10.70

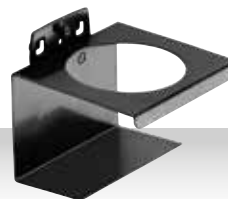

Art.	Description   Dimension	Prix CHF	
145.137.001	Support pour outil avec logements circulaires, simple W 100 mm   Ø 70 mm   ⚖ 200 g	28.-	44.-



Art.	Description   Dimension   Poids	Prix CHF	
145.138.350	Tablette L 350 x P 125 mm   ⚖ 600 g	32.-	44.-
145.138.445	Tablette L 445 x P 150 mm   ⚖ 900 g	45.-	62.-



» Veuillez commander par deux

Art.	Description   Dimension   Poids	Prix CHF	
145.128.080	Support pour scies Pour 4 scies H 52 x P 80 mm   $\varnothing$ 85 g	16.90	<del>29.-</del>



Art.	Description   Dimension   Poids	Prix CHF	
145.131.200	Support pour clés hexagonales Pour 9 tournevis à tête hexagonale L 200 x P 73 mm   $\varnothing$ 220 g	29.-	<del>44.-</del>



Art.	Description   Dimension   Poids	Prix CHF	
145.135.150	Support combiné en 2 éléments L 60 x P 150 mm   $\varnothing$ 400 g	59.-	<del>77.-</del>

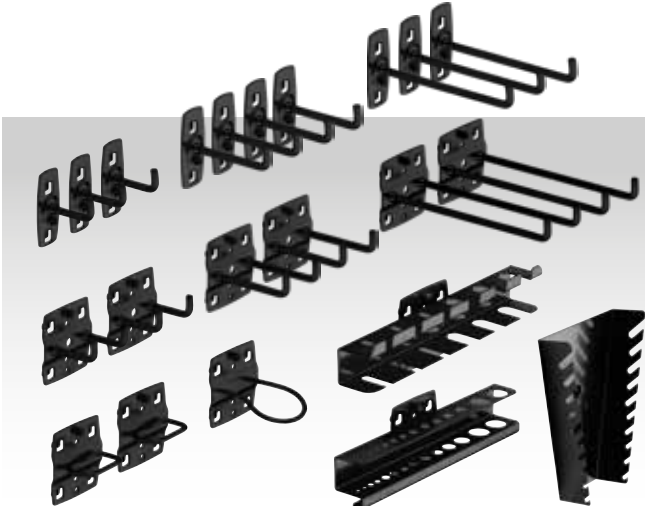

Art.	Description   Dimension	Prix CHF	
145.100.900	Jeu de crochets, 22 pièces	68.-	<del>89.-</del>



Art.	Description   Dimension	Prix CHF	
145.132.150	Support pour cônes morses Pour 7 embouts L 150 x P 35 mm   $\varnothing$ 200 g	22.-	<del>40.-</del>



Art.	Description   Dimension   Poids	Prix CHF	
145.133.390	Support pour douilles, pour 12 pcs. L 390 x P 30 mm   $\varnothing$ 500 g	39.-	<del>62.-</del>



Art.	Description   Dimension   Poids	Prix CHF	
145.134.340	Porte-outils Pour l'auto-perçage L 325 x H 55 x P 135 mm   $\varnothing$ 1100 g	55.-	<del>77.-</del>



Art.	Description	Prix CHF	
145.100.800	Pieds réglables Mobilio M10 (4 pièces dans un sac)	25.-	<del>32.-</del>



## Autres Accessoires



### Rampes d'éclairage LED

- Facilement déplaçables (avec aimants ou crochets)
- Peuvent être branchées en série
- Avec interrupteur



5m Accessoires incl. 35 cm

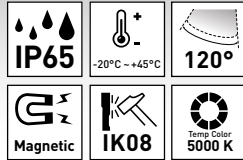

Art.	Description   Dimension   Poids	Prix CHF	
32077-60	20 W, 120 SMD, 1800 Lumen H 124 x L 590 x P 43 mm   ⚖ 1.2 kg	116.-	140.-
32077-120	40 W, 240 SMD, 3600 Lumen H 124 x L 1200 x P 43 mm   ⚖ 2.3 kg	184.-	211.-



### Étau d'établi en acier

#### Werkbänke

- Mit einem verstellbaren Stützeisen
- Mit einer einstellbaren Spindelverstellung
- Glissoisierender Längsprofil des Gehäuses
- Max. Belastbarkeit 150 kg

Art.	Dimension   Poids	Prix CHF	
7526	H min. 880 - max. 930 x L 1600 x P 600 mm ⚖ 54 kg	369.-	480.-
7527	H min. 880 - max. 930 x L 1600 x P 800 mm ⚖ 66 kg	445.-	520.-

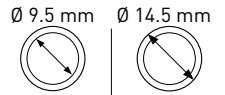

1/4" max. 18 bar -5°C to +45°C

### Enrouleur mural automatique de tuyau pneumatique, 15 + 1 m

- Le boîtier peut être pivoté jusqu'à 180°C, avec un ressort de rappel automatique et un système de verrouillage
- Matériau du boîtier: PP
- Tuyau renforcé en polymère hybride, 15 m de longueur extérieure + 1 m de longueur intérieure

Art.	Description   Dimension   Poids	Prix CHF	
31041	S'adapté dans le meuble bas 3964-28 (P. 14) H 370 x L 320 x P 180 mm   ⚖ 5.5 kg	170.-	208.-

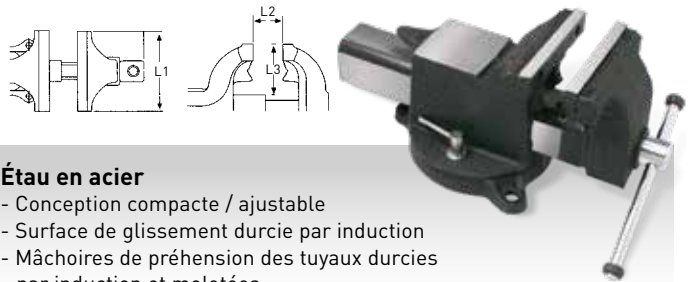

### Étau en acier

- Conception compacte / ajustable
- Surface de glissement durcie par induction
- Mâchoires de préhension des tuyaux durcies par induction et moletées
- Broche trapézoïdale protégée

Art.	Dimension   Poids	Prix CHF	
2961	L1 100 x L2 120 x L3 65 mm   ⚖ 7.5 kg	137.-	211.-
2962	L1 125 x L2 140 x L3 70 mm   ⚖ 11 kg	169.-	234.-
2963	L1 150 x L2 170 x L3 80 mm   ⚖ 14.5 kg	201.-	265.-
2964	L1 200 x L2 200 x L3 90 mm   ⚖ 20.5 kg	278.-	380.-



### Support magnétique pour douilles et outils pneumatiques

- Longueur: 400 mm



Art.	Dimension   Poids	Prix CHF	
3929	H 400 x L 130 x P 150 mm   ⚖ 2.1 kg	88.-	133.-

## Jeu de casiers d'insertion pour tiroirs

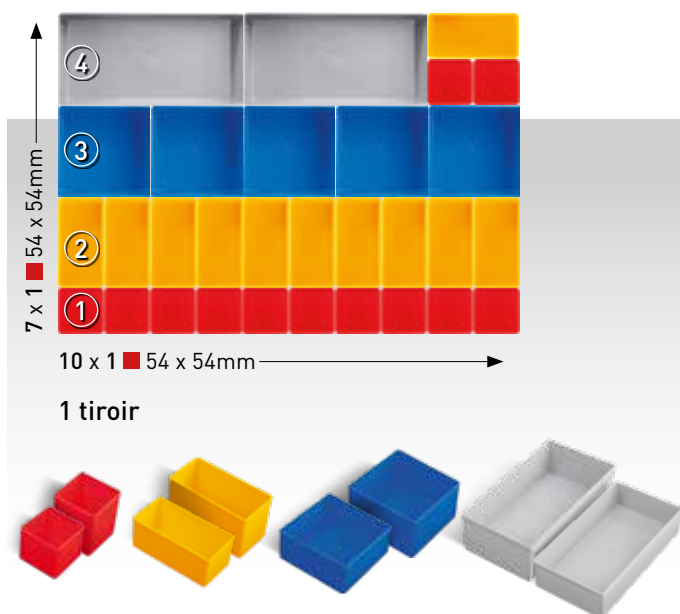

Art.	Description   Dimension	Prix CHF
198.000.018	Casier d'insertion No. 1 H 45 x L 54 x P 54 mm	0.80 / 1.10
198.000.022	Casier d'insertion No. 1 H 63 x L 54 x P 54 mm	1.- / 1.40
198.000.019	Casier d'insertion No. 2 H 45 x L 108 x P 54 mm	1.10 / 1.60
198.000.023	Casier d'insertion No. 2 H 63 x L 108 x P 54 mm	1.30 / 1.90
198.000.020	Casier d'insertion No. 3 H 45 x L 108 x P 108 mm	1.60 / 2.30
198.000.024	Casier d'insertion No. 3 H 63 x L 108 x P 108 mm	2.10 / 2.90
198.000.021	Casier d'insertion No. 4 H 45 x L 108 x P 216 mm	2.60 / 3.70
198.000.025	Casier d'insertion No. 4 H 63 x L 108 x P 216 mm	3.40 / 4.70

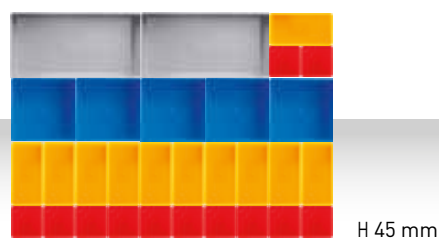

Art.	Description	Prix CHF
198.001.001	Jeu de casiers d'insertion, 30 pcs.	34.- / 48.-

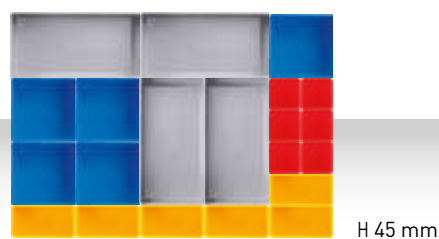

Art.	Description	Prix CHF
198.001.002	Jeu de casiers d'insertion, 21 pcs.	27.90 / 41.-

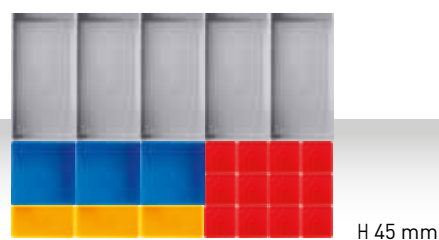

Art.	Description	Prix CHF
198.001.003	Jeu de casiers d'insertion, 23 pcs.	29.- / 42.-

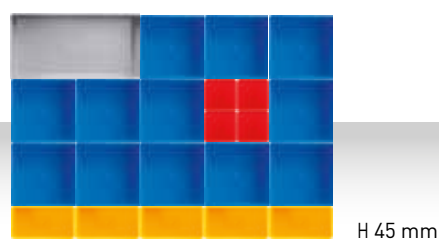

Art.	Description	Prix CHF
198.001.004	Jeu de casiers d'insertion, 22 pcs.	29.- / 42.-

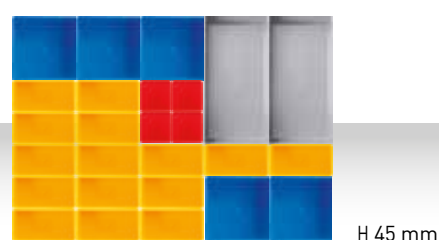

Art.	Description	Prix CHF
198.001.005	Jeu de casiers d'insertion, 26 pcs.	29.- / 42.-

## Accessories



Art.	Description   Dimension   Poids	Prix CHF	
145.143.010	Support de rouleau de papier H 150 x L 300 x P 220 mm   ⚖ 1.6 kg	59.-	97.20



Art.	Description   Dimension   Poids	Prix CHF	
145.143.010	Support de rouleau de papier H 60 x L 215 x P 85 mm   ⚖ 0.5 kg	16.90	30.90



Art.	Description   Dimension   Poids	Prix CHF	
145.143.012	Plateau de rangement avec poignées pour 8 canettes H 100 x L 300 x P 160 mm   ⚖ 2.5 kg	99.-	184.90



Art.	Description   Dimension   Poids	Prix CHF	
145.143.013	Corbeille à papier H 300 x L 300 x P 160 mm   ⚖ 3.5 kg	55.-	71.10

## Set Lavabo KRAFTWERK

Art. 150.500.002

**Évier en acier inoxydable (AIS 304) avec meuble bas et panneau arrière**

- 1 x Art. 150.000.011 Évier
- 1 x Art. 808.100.101 Distributeur de produit désinfectant
- 1 x Art. 808.100.102 Distributeur de savon
- 1 x Art. 808.100.201 Rouleau de papier
- 1 x Art. 808.100.301 Panneau en acier inoxydable L 615 x H 1052 x P 24 mm | ⚖ 5.3 kg
- 1 x Art. 3964-03 MOBILIO Armoire de base à 2 portes, 1 étagère incluse L 680 x H 910 x P 458 mm | ⚖ 29.4 kg
- 2 x Art. 3964-10 MOBILIO connecteur latéral pour panneaux L 32.5 x H 1420 x P 30 mm



Maximisez et développez votre hygiène dans l'atelier



Évier et robinet + savon distributeur + désinfectant + papier distributeur de serviettes + armoire 2 portes



Compact et facile à installer



Capteur sensible pour encore plus d'hygiène



S'adapte parfaitement à la gamme MOBILIO de Kraftwerk



Armoire pour articles de toilette



CHF **1699.-**

~~CHF 3490.-~~

## Accessoires pour évier MOBILIO

Également disponible individuellement

Art. 808.100.102

**Distributeur de savon sans contact pour montage mural en acier inoxydable**

- Distributeur de savon sans contact
- Acier inoxydable 0,8 mm
- Capacité 0,8 litre

H 300 x L 105 x P 106 mm | ⚖ 1.38 kg



CHF **199.-**

~~CHF 350.-~~

Art. 808.100.201

**Rouleau de papier**

- Pour les rouleaux de papier
- Acier inoxydable 0,8 mm
- Bord d'arrachage intégré

H 339 x L 202 x P 215 mm | ⚖ 2.74 kg



CHF **199.-**

~~CHF 320.-~~

Art. 808.100.101

**Distributeur d'assainissant sans contact pour montage mural en acier inoxydable**

- Assainissement sans contact
- Acier inoxydable 0,8 mm
- Capacité 0,8 litre

H 300 x L 112 x P 105 mm | ⚖ 1.38 kg



CHF **199.-**

~~CHF 350.-~~



Élargissez votre mobilier avec l'évier MOBILIO

Évier et robinet + armoire 2 portes + panneau mural

Compact et facile à installer

Armoire pour articles de toilette

Mur arrière avec trous pour tous les crochets KRAFTWERK et son armoire murale

## MOBILIO - KRAFTWERK Lavabo

Art. 150.500.003

**Évier en acier inoxydable (AISI 304) avec armoire inférieure et panneau arrière à perforation carrée**

- 1 x Art. 150.000.011 Évier
- 1 x Art. 3964-29 Panneau suspendu  
H 1052 x L 615 x P 24 mm | ⚖ 5.3 kg
- 1 x Art. 3964-03 MOBILIO Armoire de base à 2 portes,  
1 étagère incluse  
H 910 x L 680 x P 458 mm | ⚖ 29.4 kg
- 2 x Art. 3964-10 MOBILIO connecteur latéral pour panneaux  
H 1420 x L 32,5 x P 30 mm

CHF **1099.-**

CHF ~~1970.-~~





# KRAFTWERK MOBILIO CONFIGURATEUR WEB



**NOUVEAU**  
**CONFIGURATEUR**  
**3D**  
**INTERACTIF**

**best of**  
**swiss**  
**web**  
usability  
marketing  
digital commerce  
**bronze 2019**

Rendez-vous sur : [mobilio-configurator.kraftwerktools.com](http://mobilio-configurator.kraftwerktools.com)

## MyKRAFTWERK VOS INSERTS PERSONNALISÉS!

### Inserts d'outil MyKRAFTWERK

KRAFTWERK propose de concevoir vos inserts d'outil en mousse PE de la couleur de votre choix. Choisissez les outils Kraftwerk et définissez simplement quel outil doit être mis dans quel insert.

A l'issue, le croquis vous sera envoyé avec un bon pour exécution, accompagné de notre offre de prix.



Contactez-nous [mykraftwerk@kraftwerktools.com](mailto:mykraftwerk@kraftwerktools.com)

Sous réserve de changements/  
modifications de modèles,  
de prix et de disponibilités.  
Valable du **01.03.2023 - 30.04.2023**

**Prix TVA incluse**

Distribution: KRAFTWERK Schweiz AG  
[info.ch@kraftwerktools.com](mailto:info.ch@kraftwerktools.com)

Art. 903.054.001

**Votre revendeur:**