

HFT Fasteners AG

Bösch 37, CH-6331 Hünenberg
Telefon +41-41 780 70 01 Fax +41-41 780 73 49
Email: info@hft-fasteners.ch
Internet: www.hft-fasteners.ch



ISO 9001 Nr. 96-241-041

Befestiger und Geräte für die Industrie und den Apparatebau

2 FAR & ANZI

Fixations et outils pour l'industrie et l'appareillage

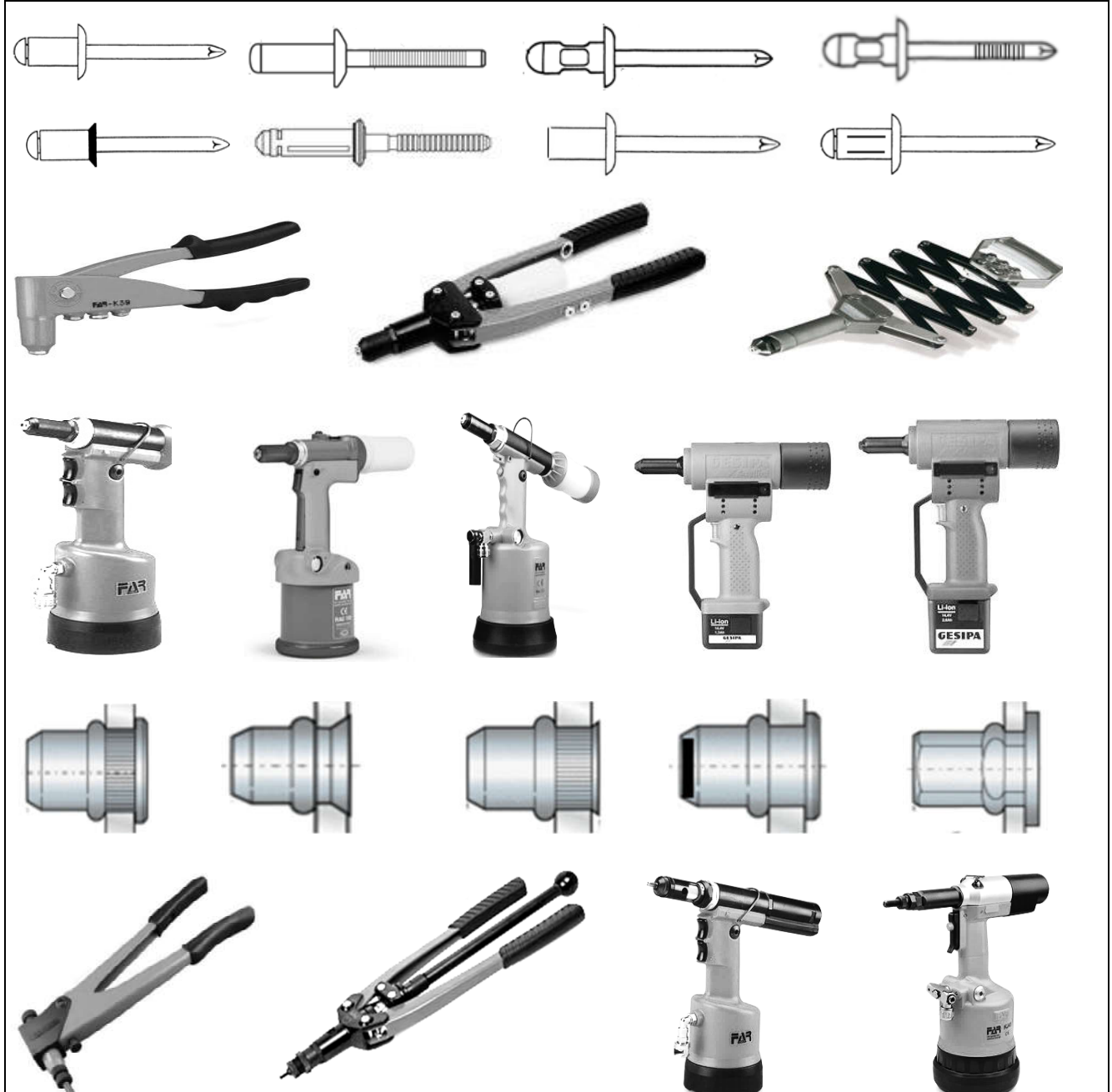

Wir beraten und unterstützen Sie während
der Projektierungsphase und vor Ort

Nous vous conseillons et aidons
lors de l'étude du projet et sur place

04/2023

HFT Fasteners AG

Bösch 37, CH-6331 Hünenberg

Telefon +41-41 780 70 01 Fax +41-41 780 73 49

Email: info@hft-fasteners.ch

Internet: www.hft-fasteners.ch

ISO 9001 Nr. 96-241-041



HFT Fasteners AG

Bösch 37, CH-6331 Hünenberg
Telefon +41-41 780 70 01 Fax +41-41 780 73 49
Email: info@hft-fasteners.ch
Internet: www.hft-fasteners.ch

ISO 9001 Nr. 96-241-041



Die HFT-Philosophie

Den HFT-Mitarbeitern macht es Spass, ihren Kunden in Sachen Befestiger für

- Metaldächer- und Metall-Fassaden**
- den Industrie- und Apparatebau**
- den Metall- und Fahrzeugbau sowie**
- Bau- und Lüftungsisolationen**

beratend zur Seite zu stehen.

Die benötigten Befestiger und Werkzeuge sollen termingerecht und preiswert beschafft werden.

*Die HFT legt Wert darauf, dass sich ihre Kunden **vor, während und nach** dem Kauf bestens betreut fühlen, und sich auf die nächste Zusammenarbeit mit der HFT freuen.*

La philosophie de HFT

Les collaborateurs de HFT ont plaisir de conseiller leurs clients en matière de fixations pour

- toitures et façades métalliques**
- l'industrie et l'appareillage**
- constructions métalliques et de voiture**
- les isolations pour bâtiments et pour climatisations**

et de les conseiller.

Il est crucial que les fixations et outils nécessaires arrivent à temps et à bon prix.

*HFT insiste que leurs clients se sentent à l'aise **avant, pendant et après** leur achat pour qu'ils se réjouissent à la prochaine collaboration avec HFT.*

HFT Fasteners AG

Bösch 37, CH-6331 Hünenberg
Telefon +41-41 780 70 01 Fax +41-41 780 73 49
Email: info@hft-fasteners.ch
Internet: www.hft-fasteners.ch



ISO 9001 Nr. 96-241-041

Inhalt

Table de matière

Blindnieten (Bruttopreise)		Seite / page	Rivets aveugles (prix bruts)			
Alu / Stahl	Blindniet Flachrundkopf	7/8	alu / acier	Rivet aveugle tête plate		
Alu / Stahl (Anzi)	Blindniet Flachrundkopf	9	alu / acier (Anzi)	Rivet aveugle tête plate		
Alu / Inox	Blindniet Flachrundkopf	10	alu / inox	Rivet aveugle tête plate		
Alu / Alu	Blindniet Flachrundkopf	11	alu / alu	Rivet aveugle tête plate		
Stahl / Stahl	Blindniet Flachrundkopf	12	acier / acier	Rivet aveugle tête plate		
Inox / Inox	Blindniet Flachrundkopf	13	inox / inox	Rivet aveugle tête plate		
Inox / Inox (Anzi)	Blindniet Flachrundkopf	14	inox / inox (Anzi)	Rivet aveugle tête plate		
Inox / Inox	Blindniete Grosskopf Ø 14mm	15	inox / inox	Rivet avec grande tête ø14mm		
Alu / Stahl	Blindniet Senkkopf	16	alu / acier	Rivet aveugle tête fraisée		
Alu / Inox	Blindniet Senkkopf	17	alu / inox	Rivet aveugle tête fraisée		
Inox / Inox	Blindniet Senkkopf	18	inox / inox	Rivet aveugle tête fraisée		
Alu/Stahl	Multi Senkkopf grosser Klemmb	19	alu/acier	Multi tête fraisée		
Alu / Stahl	Multi und Grosskopf Ø 16mm	20	alu / acier	Multi avec grande tête ø16mm		
Alu / Inox	Multi und Grosskopf Ø 16mm	21	alu / inox	Multi avec grande tête ø16mm		
Inox / Inox	Multi mit gerilltem Dorn	22	inox / inox	Rivet Multi avec mandrin reillé		
Inox / Inox	Multi PLUS Niet	23	inox / inox	Rivet Multi PLUS		
Stahl / Stahl	Multi Tamp gerillter Dorn	24	acier / acier	Rivet Multi Tamp mandrin reillé		
Alu / Stahl	Becher-Dichtniet + Senkkopf	25	alu / acier	Rivet étanche + tête fraisée		
Alu / Inox	Becher-Dichtniet	26	acier / inox	Rivet étanche		
Stahl/Stahl	Becher-Dichtniet	26	acier / acier	Rivet étanche		
Inox / Inox	Becher-Dichtniet	27	inox / inox	Rivet étanche		
CrNi/Inox – CB	Spenglerniet CB / CRNI	28	CrNi / inox – CB	Rivet ferblantier CrNi et Cb		
Alu / Stahl	Sternniet	29	alu / acier	Rivet étoile		
Inox / Inox	Sternniet	29	inox / inox	Rivet étoile		
Alu / Alu & St / St	Bulb Tite	30	alu / alu & ac. / ac.	Rivet Bulb Tite		
Alu / Inox	Fassaden-Blindniet (Alucobond)	31	alu / inox	Rivet de façade (Alucobond)		
Alu / Inox	Hammerschlagniet	31	alu / inox	Rivet à marteau		
Alu / Stahl	Gerillter Niet	32	alu / acier	Rivet cannelé		
Blindnietmuttern (Bruttopreise)			Inserts filetés (prix bruts)			
Flachkopf m.Rand	Alu	FTT	34	tête cylindrique	alu	FTT
Flachkopf m.Rand	Stahl	FTT	35	tête cylindrique	acier	FTT
Flachkopf m.Rand	Inox	FTT	36	tête cylindrique	inox	FTT
Senkkopf	Alu	FTS	37	tête fraisée	alu	FTS
Senkkopf	Stahl	FTS	38	tête fraisée	acier	FTS
Senkkopf	Inox	FTS	39	tête fraisée	inox	FTS
Kleinkopf gerändelt	Stahl	FTR	40	tête réduite cannelé	acier	FTR
Kleinkopf gerändelt	Inox	FTR	41	tête réduite cannelé	inox	FTR
Geschlossene	Alu	FTTC	42	fermé	alu	FTTC
Geschlossene	Stahl	FTTC	43	fermé	acier	FTTC
Flachkopf gerändelt	Stahl	FTT-Z	44	cannelé cylindrique	acier	FTT-Z
6-kt. Flachk.geschl.	Stahl	FTTEC	45	hexagonal fermé	acier	FTTEC
Teil-6-kt. Kleinkopf	Stahl	FTRE	45	en partie hexagonal, tête réduite	acier	FTRE
Teil-6-kt. Kleinkopf	Inox	IE-Inox	46	en partie hexagonal, tête réduite	inox	IE-Inox
Teil-6-kt. Kleinkopf	Stahl	IE-Stahl	46	en partie hexagonal, tête réduite	acier	IE-acier
Geräte und Bohrer (Nettopreise)			Outils et mèches (prix nets)			
Nasslackieren Nieten			47	Thermolaque rivets		
Hand-Nietwerkzeuge			48	Outils à rivet à main		
Pneumatische Nietpistolen			49	Riveteuses pneumatiques		
Akku-Nieter			50	Riveteuses à accu		
Nietmuttern-Geräte			51	Outils pour inserts filetés		
Nietenbohrer HSS DIN 1897			52	Mèches pour rivets HSS DIN 1897		

HFT Fasteners AG

Bösch 37, CH-6331 Hünenberg
Telefon +41-41 780 70 01 Fax +41-41 780 73 49
Email: info@hft-fasteners.ch
Internet: www.hft-fasteners.ch

ISO 9001 Nr. 96-241-041



Verkaufskonditionen

Praktisch das gesamte Lieferprogramm ist kurzfristig ab HFT lieferbar.

Aufträge, die bis 16 Uhr eintreffen, gehen noch am gleichen Tag weg.

Preise ohne MWSt
Änderungen vorbehalten
inkl. Verpackung

Rabatt Auf **Brutto-Preise** nach Vereinbarung: _____

Lieferung Frachtkostenanteile pro Lieferung:

pro Paket bis 30 kg: Fr. 10.-
pro Palett per Camion: Fr. 60.-
Postexpress: zu Selbstkosten
Rückstand-Lieferungen: franko

Zahlung nach Vereinbarung

Warenrücknahme

Bitte haben Sie Verständnis für folgende Regelung:

Wir nehmen gelieferte Waren grundsätzlich nur im gegenseitigen Einverständnis zurück, bei franko Rücksendung und mit Abzug von 20% des fakturierten Betrages auf der Gutschrift.

Bitte haben Sie ferner Verständnis für folgendes:

Bei Aufträgen unter Fr. 100.- brutto entfällt der Rabatt auf die Bruttopreise.

Diese Verkaufskonditionen gelten bis auf Widerruf.

Conditions de vente

Pratiquement le programme complet est livrable de HFT à court terme.

Les commandes qui nous parviennent jusqu'à 16 heures partent le même jour.

Prix sans TVA
sous réserve de changer emballage y compris

Rabais sur les **prix bruts**
à convenir : _____

Livraison participation aux frais de transport par livraison :

par paquet max. 30 kg : Fr. 10.-
par palette par camion : Fr. 60.-
poste express aux frais effectifs
livraisons de solde: franco

Payment à convenir

Reprise de marchandise

Ayez-compréhension pour la réglementation suivante, s.v.p.:

Nous reprenons de la marchandise livrée uniquement avec notre accord, nous livrée franco et en déduisant 20% du montant facturé sur la note de crédit.

En outre soyez informé que:

les commandes en dessous de Fr. 100.- bruts ne bénéficient pas de rabais.

Ces conditions sont valables jusqu'à nouvel ordre.

HFT Fasteners AG

Bösch 37, CH-6331 Hünenberg
Telefon +41-41 780 70 01 Fax +41-41 780 73 49
Email: info@hft-fasteners.ch
Internet: www.hft-fasteners.ch

ISO 9001 Nr. 96-241-041



*Die Preise bis Seite 47 sind **brutto minus dem vereinbarten Rabatt** + MWST.*

*Les prix jusqu'à la page 47 sont **bruts moins le rabais convenu** + TVA.*

HFT Fasteners AG

Bösch 37, CH-6331 Hünenberg
Telefon +41-41 780 70 01 Fax +41-41 780 73 49
Email: info@hft-fasteners.ch
Internet: www.hft-fasteners.ch



ISO 9001 Nr. 96-241-041

Blindniet Flachrundkopf

Alu / Stahl

alu / acier
Typ FAR N02

Rivet aveugle tête plate

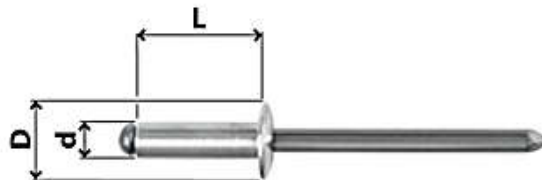

d Ø (mm)		L	D	K	mm	Art.	Fr./100	Verp. unité
3,2 ↔ 1250 × 900 max (N)	3,3	6	6,5	0,8	0,5 - 3,0	N0232060	2.70	1000
		8			3,0 - 5,0	N0232080	2.70	1000
		10			5,0 - 7,0	N0232100	3.30	1000
		12			7,0 - 9,0	N0232120	3.30	500
		14			9,0 - 11,0	N0232140	3.60	500
		16			11,0 - 13,0	N0232160	4.20	500

4,0 ↔ 2000 × 1400 max (N)	4,1	6	8	1,0	1,5 - 2,5	N0240060	2.30	1000
		8			2,5 - 4,5	N0240080	3.-	1000
		10			4,5 - 6,5	N0240100	3.-	500
		12			6,5 - 8,5	N0240120	3.60	500
		14			8,5 - 10,5	N0240140	4.20	500
		16			10,5 - 12,5	N0240160	4.20	500
		18			12,5 - 14,5	N0240180	4.70	500
		20			14,5 - 16,5	N0240200	4.70	500
		25			16,5 - 21,5	N0240250	5.90	500

Bestellbeispiel:
Blindniet Alu / Stahl
3,2 x 6 oder
Art. N0232060

Exemple de commande:
Rivet aveugle alu / acier
3,2 x 6 ou
art. N0232060

Fortsetzung nächste Seite

continuation page suivante

HFT Fasteners AG

Bösch 37, CH-6331 Hünenberg
Telefon +41-41 780 70 01 Fax +41-41 780 73 49
Email: info@hft-fasteners.ch
Internet: www.hft-fasteners.ch



ISO 9001 Nr. 96-241-041

Blindniet Flachrundkopf

Alu / Stahl

alu / acier
Typ FAR N02

Rivet aveugle tête plate

d Ø (mm)		L	D	K	mm	Art.	Fr./100	Verp. unité
4,8 ↔ 3050 ✂ 2150 max (N)	5,0	6	10	1,1	0,5 - 2	N0248060	3.-	500
		8			2 - 4	N0248080	3.60	500
		10			4 - 6	N0248100	4.20	500
		12			6 - 8	N0248120	4.20	500
		14			8 - 10	N0248140	5.40	500
		16			10 - 12	N0248160	5.90	500
		18			12 - 14	N0248180	5.90	500
		20			14 - 16	N0248200	7.-	500
		22			16 - 18	N0248220	7.-	500
		25			18 - 21	N0248250	7.70	500
		30			21 - 24	N0248300	9.40	500
		35			24 - 29	N0248350	10.70	500
		40			29 - 34	N0248400	12.90	500
		50			41 - 46	N0248500	17.90	500
		55			45 - 50	N0248550	36.50	500
6,4 ↔ 4800 ✂ 3000 max (N)	6,5	12	12	1,8	5 - 7	N0264120	9.40	500
		15			7 - 10	N0264150	10.10	500
		18			10 - 13	N0264180	10.70	500
		22			13 - 17	N0264220	12.40	500
		26			17 - 21	N0264260	12.40	500
		30			21 - 25	N0264300	14.80	500
		35			24 - 30	N0264350	18.20	500
		40			28 - 32	N0264400	30.10	500

Bestellbeispiel:
Blindniet Alu / Stahl
6,4 x 15 oder
Art. N0264150

Exemple de commande:
Rivet aveugle alu / acier
6,4 x 15 ou
art. N0264150

HFT Fasteners AG

Bösch 37, CH-6331 Hünenberg
 Telefon +41-41 780 70 01 Fax +41-41 780 73 49
 Email: info@hft-fasteners.ch
 Internet: www.hft-fasteners.ch



ISO 9001 Nr. 96-241-041

Blindniet
Flachrundkopf
preiswert

Alu / Stahl
 alu / acier
Typ ANZI N02K

Rivet aveugle
tête plate
bon prix

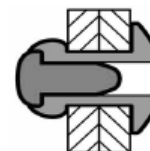
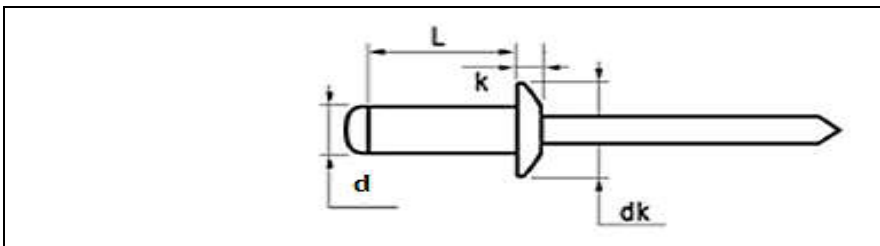

d Ø (mm)		L	dk	k	mm	Art.	Fr./100	Verp. unité
3,2	3,3	6	6,5	0,8	1,5 - 3,0	N02K32060	1.20	1000
		8			3,0 - 5,0	N02K32080	1.40	1000
		↔ 1600			5,0 - 7,0	N02K32100	1.50	1000
		⌘ 1200			7,0 - 9,0	N02K32120	1.70	1000
		max (N)			9,0 - 11,0	N02K32140	1.70	1000
					11,0 - 12,5	N02K32160	2.40	1000
4,0	4,1	12	8	1	6,0 - 8,0	N02K40120	2.40	500
		14			8,0 - 10,0	N02K40140	2.70	500
4,8	4,9	8	9,5	1,1	2,0 - 3,5	N02K48080	2.40	500
		10			3,5 - 5,5	N02K48100	2.50	500
		↔ 2230			5,5 - 7,5	N02K48120	3.-	500
		⌘ 1690			9,0 - 11,0	N02K48160	3.60	500
		max (N)			29,0 - 33,5	N02K48400	10.10	500

Bestellbeispiel:
 Blindniet Alu / Stahl
 4,8 x 10 oder
 Art. N02K48100

Exemple de commande:
 Rivet aveugle alu / acier
 4,8 x 10 ou
 art. N02K48100

HFT Fasteners AG

Bösch 37, CH-6331 Hünenberg
Telefon +41-41 780 70 01 Fax +41-41 780 73 49
Email: info@hft-fasteners.ch
Internet: www.hft-fasteners.ch



ISO 9001 Nr. 96-241-041

Blindniet Flachrundkopf

Alu / Inox

Rivet aveugle tête plate

Typ FAR N16

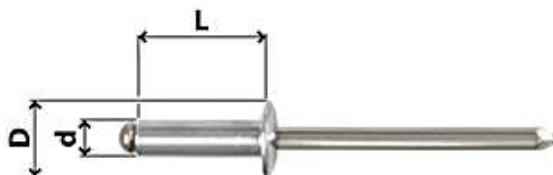

d Ø (mm)		L	D	K	mm	Art.	Fr./100	Verp. unité
4,0	4,1	12	8	1	6,5 - 8,5	N1640120	8.20	1000
↔ 1800 ⌘ 1270 max (N)								
4,8	5,0	8 10 12 14	10	1,1	3,0 - 4,0 4,0 - 6,0 6,0 - 8,0 8,0 - 10,0	N1648080 N1648100 N1648120 N1648140	11.80 12.90 13.50 14.10	500 500 500 500
↔ 2970 ⌘ 2180 max (N)								

HFT Fasteners AG

Bösch 37, CH-6331 Hünenberg
Telefon +41-41 780 70 01 Fax +41-41 780 73 49
Email: info@hft-fasteners.ch
Internet: www.hft-fasteners.ch



ISO 9001 Nr. 96-241-041

Blindniet Flachrundkopf

Alu / Alu

Rivet aveugle tête plate

Typ FAR N01

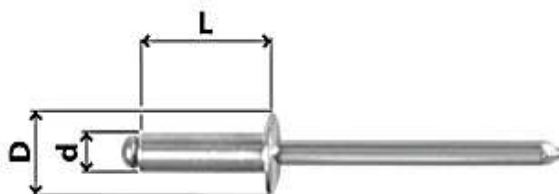

d Ø (mm)		L	D	K	mm	Art.	Fr./100	Verp. unité
3,2 ↔ 700 ✂ 400 max (N)	3,3	6	6,5	0,8	0,5 - 3,0	N0132060	2.40	1000
		8			3,0 - 5,0	N0132080	3.-	1000
		10			5,0 - 7,0	N0132100	3.-	1000
		12			7,0 - 9,0	N0132120	3.60	1000

4,0 ↔ 1200 ✂ 800 max (N)	4,1	8	8	1	2,5 - 4,5	N0140080	4.70	1000
		10			4,5 - 6,5	N0140100	4.70	500
		12			6,5 - 8,5	N0140120	5.40	500
		14			8,5 - 10,5	N0140140	5.40	500
		16			10,5 - 12,5	N0140160	5.90	500

4,8 ↔ 1500 ✂ 1000 max (N)	5,0	8	10	1,1	2,0 - 4,0	N0148080	7.-	1000
		10			4,0 - 6,0	N0148100	7.70	500
		12			6,0 - 8,0	N0148120	7.70	500
		14			8,0 - 12,0	N0148140	8.20	500
		16			10,0 - 12,0	N0148160	9.40	500
		18			12,0 - 14,0	N0148180	10.10	500

Bestellbeispiel:
Blindniet Alu / Alu
4,8 x 10 oder
Art. N0148100

Exemple de commande:
Rivet aveugle alu / alu
4,8 x 10 ou
art. N0148100

HFT Fasteners AG

Bösch 37, CH-6331 Hünenberg
 Telefon +41-41 780 70 01 Fax +41-41 780 73 49
 Email: info@hft-fasteners.ch
 Internet: www.hft-fasteners.ch





ISO 9001 Nr. 96-241-041

Blindniet
 Flachrundkopf

Stahl / Stahl
 acier / acier
Typ FAR N03

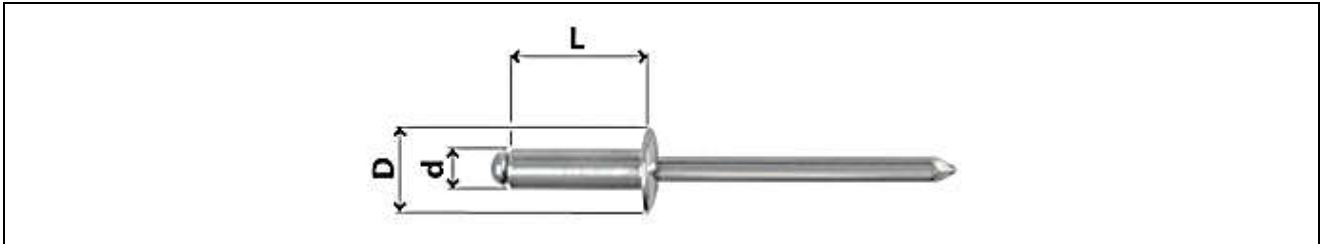
Rivet aveugle
 tête plate



d Ø (mm)		L	D	K	mm	Art.	Fr./100	Verp. unité
3,2 ↔ 1750 ✂ 1400 max (N)	3,3	6	6,5	0,8	0,5 - 3,0	N0332060	3.-	1000
		8			3,0 - 5,0	N0332080	3.60	1000
		10			5,0 - 7,0	N0332100	3.60	1000
		12			7,0 - 9,0	N0332120	4.70	500
4,0 ↔ 3200 ✂ 2350 max (N)	4,1	6	8	1,0	0,5 - 2,0	N0340060	3.-	1000
		8			2,0 - 4,0	N0340080	3.60	500
		10			4,0 - 6,0	N0340100	4.20	500
		12			6,0 - 8,0	N0340120	4.70	500
		14			8,0 - 10,0	N0340140	5.40	500
		16			10,0 - 12,0	N0340160	5.40	500
4,8 ↔ 3900 ✂ 3100 max (N)	5,0	8	9	1,1	2,0 - 4,0	N0348080	4.20	500
		10			4,0 - 6,0	N0348100	5.40	500
		12			6,0 - 8,0	N0348120	5.90	500
		14			8,0 - 10,0	N0348140	7.-	500
		16			10,0 - 12,0	N0348160	7.70	500
		18			12,0 - 14,0	N0348180	8.20	500
		20			14,0 - 16,0	N0348200	8.80	500
		25			16,0 - 21,0	N0348240	11.80	500
6,4 ↔ 6750 ✂ 5000 max (N)	6,5	12	12	1,8	4,0 - 7,0	N0364120	10.10	500
		15			7,0 - 10,0	N0364150	10.70	500
		18			10,0 - 13,0	N0364180	12.40	500
		22			13,0 - 16,5	N0364220	12.90	500
		26			16,5 - 20,5	N0364260	17.10	500
		30			20,5 - 24,5	N0364300	17.60	500

HFT Fasteners AG

Bösch 37, CH-6331 Hünenberg
 Telefon +41-41 780 70 01 Fax +41-41 780 73 49
 Email: info@hft-fasteners.ch
 Internet: www.hft-fasteners.ch



ISO 9001 Nr. 96-241-041

Blindniet Flachrundkopf

Inox / Inox

Rivet aveugle tête plate

Typ FAR N05

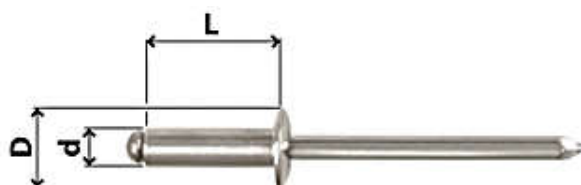

d Ø (mm)		L	D	K	mm	Art.	Fr./100	Verp. unité	
3,2	3,3	6	6,5	0,8	0,5 - 2,5	N0532060	8.20	1000	
		8			2,5 - 4,5	N0532080	10.50	1000	
		↔ 2500			4,5 - 6,5	N0532100	11.60	1000	
		✂ 2500			6,5 - 8,5	N0532120	11.80	1000	
		max (N)							
4,0	4,1	6	8,0	1,0	0,5 - 2,0	N0540060	12.40	500	
		8			2,0 - 4,0	N0540080	13.50	500	
		↔ 3500			4,0 - 6,0	N0540100	14.80	500	
		✂ 3140			6,0 - 8,0	N0540120	16.50	500	
		max (N)			14	8,0 - 10,0	N0540140	17.90	500
					16	10,0 - 12,0	N0540160	20.10	500
4,8	4,9	8	9,0	1,1	1,5 - 3,5	N0548080	19.40	500	
		10			3,5 - 5,5	N0548100	21.90	500	
		↔ 6000			5,5 - 7,5	N0548120	24.30	500	
		✂ 5200			7,5 - 9,5	N0548140	26.-	500	
		max (N)			16	9,5 - 11,5	N0548160	27.70	500
					18	11,5 - 13,5	N0548180	33.70	500
					20	13,5 - 15,5	N0548200	35.90	500
					25	15,5 - 20,5	N0548250	37.80	500
6,4	6,5	12	12		4,0 - 7,0	N0564120	56.20	500	
		15		7,0 - 10,0	N0564150	63.60	500		
		↔ 8800		10,0 - 13,0	N0564180	65.-	500		
		✂ 7000		13,0 - 17,0	N0564220	73.70	500		
max (N)									

HFT Fasteners AG

Bösch 37, CH-6331 Hünenberg
 Telefon +41-41 780 70 01 Fax +41-41 780 73 49
 Email: info@hft-fasteners.ch
 Internet: www.hft-fasteners.ch



ISO 9001 Nr. 96-241-041

Blindniet Flachrundkopf preiswert

Inox / Inox

Rivet aveugle tête plate bon prix

Typ ANZI N05K

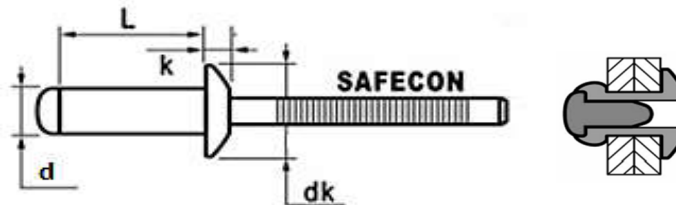

d Ø (mm)		L	dk	k	mm	Art.	Fr./ 100	Verp. unité
3,2 ↔ 2500 ✂ 1900 max (N)	3,3	6	6,5	0,8	1,5 - 3,0	N05K32060	5.90	1000
		8			3,0 - 5,0	N05K32080	5.90	1000
		10			5,0 - 7,0	N05K32100	5.90	1000
		12			7,0 - 9,0	N05K32120	7.-	1000
		14			9,0 - 11,0	N05K32140	7.70	1000
		16			11,0 - 12,5	N05K32160	7.70	1000
4,0 ↔ 3800 ✂ 3100 max (N)	4,1	6	8	1,0	1,0 - 2,0	N05K40060	7.-	500
		8			2,0 - 4,0	N05K40080	7.70	500
		10			4,0 - 6,0	N05K40100	7.70	500
		12			6,0 - 8,0	N05K40120	8.20	500
		14			8,0 - 10,0	N05K40140	9.40	500
		16			10,0 - 12,0	N05K40160	10.70	500
		18			12,0 - 14,0	N05K40180	11.20	500
20	14,0 - 15,5	N05K40200	12.40	500				
4,8 ↔ 6000 ✂ 4500 max (N)	4,9	8	9,5	1,0	2,0 - 4,0	N05K48080	10.10	500
		10			4,0 - 6,0	N05K48100	11.20	500
		12			6,0 - 8,0	N05K48120	11.80	500
		14			8,0 - 9,5	N05K48140	12.40	500
		16			9,5 - 11,0	N05K48160	12.90	500
		18			11,0 - 13,0	N05K48180	13.50	500
		20			13,0 - 15,0	N05K48200	15.30	500
		22			15,0 - 17,0	N05K48220	17.10	500
25	17,0 - 20,0	N05K48250	18.90	500				
6,4 ↔ 8850 ✂ 6500 max (N)	6,5	12	12		3,5 - 5,5	N05K64120	33.70	500
		15			5,5 - 8,5	N05K64150	37.10	500
		18			8,5 - 11,5	N05K64180	37.10	500
		22			11,5 - 15,5	N05K64220	41.90	500

HFT Fasteners AG

Bösch 37, CH-6331 Hünenberg
Telefon +41-41 780 70 01 Fax +41-41 780 73 49
Email: info@hft-fasteners.ch
Internet: www.hft-fasteners.ch



ISO 9001 Nr. 96-241-041

Blindniet
mit Grosskopf Ø 14mm

Inox / Inox

Rivet aveugle
avec grande tête Ø 14 mm

Typ FAR N58

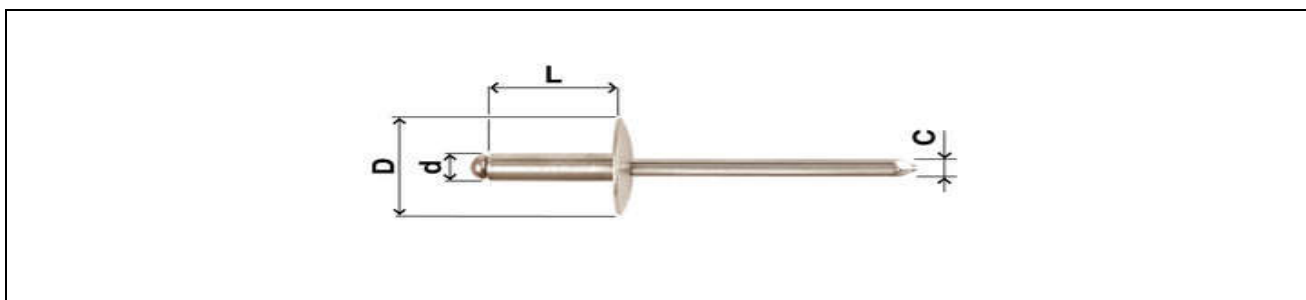

d Ø (mm)		L	D	mm	Art.	Fr./100	Verp. unité
4,8	5	10	14	3,5 - 5,5	N5848100	26.50	500
		12		5,5 - 7,5	N5848120K14	27.90	500
↔ 6000							
✂ 5200							
max (N)							

Bestellbeispiel:
Blindniet Inox / Inox Multi
4,8 x 12 oder
Art. N5848120

Exemple de commande:
Rivet aveugle inox / inox Multi
4,8 x 12 ou
art. N5848120

HFT Fasteners AG

Bösch 37, CH-6331 Hünenberg
 Telefon +41-41 780 70 01 Fax +41-41 780 73 49
 Email: info@hft-fasteners.ch
 Internet: www.hft-fasteners.ch



ISO 9001 Nr. 96-241-041

Blindniet Senkkopf

Alu / Stahl

alu / acier
Typ FAR N12

Rivet aveugle tête fraisée

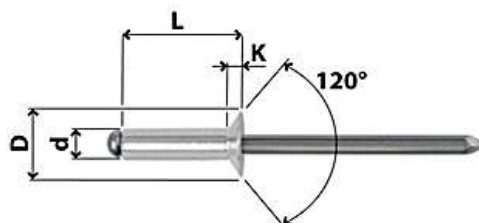

d Ø (mm)		L	D	K	mm	Art.	Fr./100	Verp. unité
3,2	3,3	8	6,5	1,0	2 - 5	N1232080	3.-	1000
		10			5 - 7	N1232100	3.60	1000
		↔ 980			7 - 9	N1232120	4.20	500
		⊗ 680			9 - 11	N1232140	4.20	500
		max (N)						
4,0	4,1	10	8	1,3	5 - 7	N1240100	3.60	500
		12			7 - 9	N1240120	3.60	500
		↔ 1800			9 - 11	N1240140	4.70	500
		⊗ 1200			11 - 13	N1240160	5.40	500
		max (N)			13 - 15	N1240180	5.40	500
		20			15 - 17	N1240200	5.40	500
4,8	5,0	10	10	1,5	4 - 6	N1248100	4.70	500
		12			6 - 8	N1248120	5.40	500
		↔ 2900			8 - 10	N1248140	5.90	500
		⊗ 2100			10 - 12	N1248160	5.90	500
		max (N)			9 - 13	N1248180	5.90	500
		18			13 - 16	N1248200	7.-	500
		21			15 - 20	N1248260	8.20	500
		25			21 - 25	N1248300	8.80	500
		30			25 - 30	N1248350	9.40	500

HFT Fasteners AG

Bösch 37, CH-6331 Hünenberg
 Telefon +41-41 780 70 01 Fax +41-41 780 73 49
 Email: info@hft-fasteners.ch
 Internet: www.hft-fasteners.ch



ISO 9001 Nr. 96-241-041

Blindniet Senkkopf

Alu / Inox

Rivet aveugle tête fraisée

Typ FAR N11

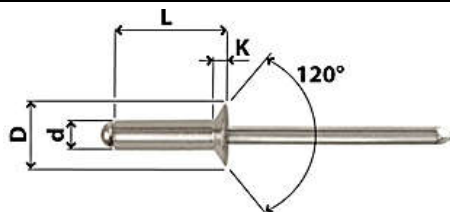

4,0 \leftrightarrow 1800 \times 1200 max (N)	4,1	8	8	1,3	3,0 - 5,0	N1140080	8.80	500
		10			5,0 - 7,0	N1140100		
		12			7,0 - 9,0	N1140120	10.10	500
4,8 \leftrightarrow 2900 \times 2100 max (N)	4,9	10	10	1,5	4,5 - 6,0	N1148110	12.40	500
		12			6,0 - 8,0	N1148120		
		16			10,0 - 12,0	N1148160	14.10	500

HFT Fasteners AG

Bösch 37, CH-6331 Hünenberg
 Telefon +41-41 780 70 01 Fax +41-41 780 73 49
 Email: info@hft-fasteners.ch
 Internet: www.hft-fasteners.ch



ISO 9001 Nr. 96-241-041

Blindniet Senkkopf

Inox / Inox

Rivet aveugle tête fraisée

Typ FAR N15

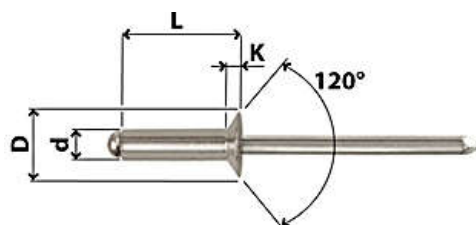

d Ø (mm)		L	D	K	mm	Art.	Fr./100.	Verp. unité
3,2		6	6,5	1,1	2,0 - 2,5	N1532060	10.10	1000
		↔ 8			2,5 - 4,5	N1532080	10.10	1000
		↔ 10			4,5 - 6,5	N1532100	11.80	1000
↔ 2700								
⌘ 2350								
max (N)								
4,0		8	8	1,3	3,0 - 4,0	N1540080	16.-	500
		10			4,0 - 6,0	N1540100	16.50	500
		↔ 12			6,0 - 8,0	N1540120	18.90	500
		↔ 14			8,0 - 10,0	N1540140	19.40	500
↔ 4200								
⌘ 3650								
max (N)								
4,8		10	10	1,5	3,5 - 5,5	N1548100	24.30	500
		12			5,5 - 7,5	N1548120	27.70	500
		↔ 14			7,5 - 9,5	N1548140	30.10	500
		↔ 18			10,0 - 13,0	N1548180	30.10	500
		↔ 6000						
⌘ 5200								
max (N)								

Bestellbeispiel:
 Blindniet Senkkopf
 Inox / Inox
 4,0 x 8 oder
 Art. N1540080

Exemple de commande:
 Rivet aveugle tête fraisée
 inox / inox
 4,0 x 8 ou
 art. N1540080

HFT Fasteners AG

Bösch 37, CH-6331 Hünenberg
 Telefon +41-41 780 70 01 Fax +41-41 780 73 49
 Email: info@hft-fasteners.ch
 Internet: www.hft-fasteners.ch



ISO 9001 Nr. 96-241-041

Blindniet

Senkkopf
 grosser Klemmbereich

Alu / Stahl Multi

alu / acier Multi
 Typ FAR N22

Rivet aveugle

tête fraisée
 grande gamme de serrage

Sauberer Schliesskopf
 Hohe Klemmkraft
 Grosse Bohrlochtoleranzen
 Prüfzeugnisse auf Anfrage

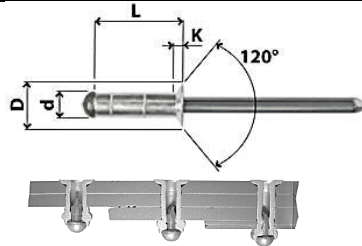

fermeture très propre
 grande force d'assemblage
 grande tolérance de forage
 bulletins d'expertise sur demande

d Ø (mm)		L	D	K	mm	Art.	Fr./100	Verp. unité
3,2	3,3 ↔ 3,4	10	6	0,8	2,4 - 6,4	N2232100	4.20	500
↔ 1000 ⊗ 880 max (N)								
4,0	4,1 ↔ 4,2	11	6,5	0,9	2,8 - 7,9	N2240110	5.90	500
↔ 1600 ⊗ 1200 max (N)								
4,8	5,0 ↔ 5,1	11 17	8,5	1,1	3,2 - 7,9 6,4 - 12,7	N2248110 N2248170	6.50 8.20	500 500
↔ 2200 ⊗ 1600 max (N)								

Bestellbeispiel:
 Alu / Stahl Multi Senkkopf
 3,2 x 10 oder
 Art. N2232100

Exemple de commande:
 alu / acier Multi tête fraisée
 3,2 x 10 ou
 art. N2232100

HFT Fasteners AG

Bösch 37, CH-6331 Hünenberg
 Telefon +41-41 780 70 01 Fax +41-41 780 73 49
 Email: info@hft-fasteners.ch
 Internet: www.hft-fasteners.ch



ISO 9001 Nr. 96-241-041

Blindniet
 Flachrundkopf
 grosser Klemmbereich

Alu / Stahl Multi

 alu / acier Multi
Typ FAR N08

Rivet aveugle
 tête plate
 grande gamme de serrage

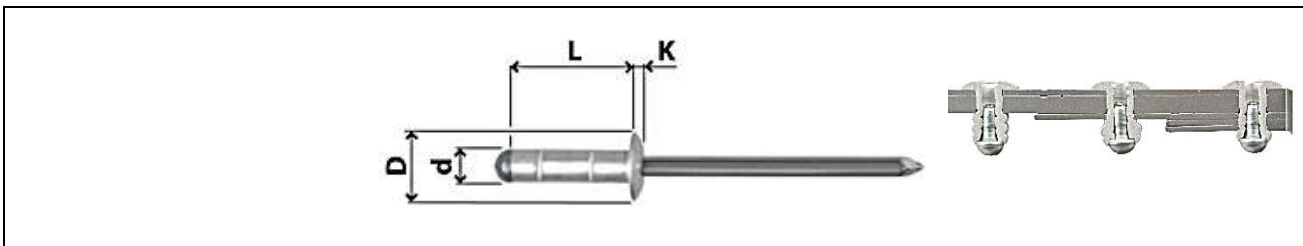

d Ø (mm)		L	D	K	mm	Art.	Fr./100	Verp. unité
3,2	3,4	8	6,5	0,8	0,8 - 4,8	N0832080	3.20	1000
		11,5			4,0 - 8,0	N0832115	3.60	1000
↔ 1000								
⊗ 800								
max (N)								

4,0	4,2	10	8	1	1,2 - 6,5	N0840100	4.20	500
		13			4,0 - 9,5	N0840130	4.70	500
		17			6,4 - 12,7	N0840170	5.90	500
↔ 1600								
⊗ 1200								
max (N)								

4,8	5,1	11	10	1,1	1,3 - 6,5	N0848110	4.70	500
		15			4,8 - 11,1	N0848150	5.90	500
		17			5,5 - 12,0	N0848170	7.-	500
		25			12,7 - 19,8	N0848250	10.10	500
↔ 2200								
⊗ 1600								
max (N)								

mit Grosskopf Ø 16 mm

Typ FAR N28

avec tête grande Ø 16 mm

4,8	4,9	10	16	1,5	1,6 - 6,4	N2848100	7.70	500
		↔ 16			6,4 - 12,7	N2848160	9.40	500
	↔ 2200	5,1			25	12,7 - 19,8	N2848250	11.80
⊗ 1600								
max (N)								

Bestellbeispiel
 Blindniet Alu / Stahl, Multi, Grosskopf 16
 4,8 x 16 oder
 Art. N2848160

Exemple de commande
 Rivet alu / acier, Multi, tête 16
 4,8 x 16 ou
 Art. N2848160

HFT Fasteners AG

Bösch 37, CH-6331 Hünenberg
 Telefon +41-41 780 70 01 Fax +41-41 780 73 49
 Email: info@hft-fasteners.ch
 Internet: www.hft-fasteners.ch



ISO 9001 Nr. 96-241-041

Blindniet

Flachrundkopf
 grosser Klemmbereich

Alu / Inox Multi

Typ FAR N18

Rivet aveugle

tête plate
 grande gamme de serrage

Der grosse Klemmbereich kann bis zu vier Nietenlängen ersetzen

La grande gamme de serrage peut remplacer jusqu'à 4 longueurs standard

d Ø (mm)		L	D	K	mm	Art.	Fr./100	Verp. unité	
3,2	3,3	8	6,5	0,8	1,0 - 4,8	N1832080	7.70	1000	
	↔	11,5				4,0 - 8,0	N1832115	8.80	1000
	↔ 1000 ⌘ 800 max (N)	3,4							

4,0	4,1	10	8	1,3	1,2 - 6,5	N1840100	10.70	500	
	↔	13				4,0 - 9,5	N1840130	11.80	500
	↔ 1600 ⌘ 1200 max (N)	4,2				17	6,4 - 12,7	N1840170	12.90

4,8	4,9	11	10	1,45	1,3 - 6,5	N1848110	15.10	500		
	↔	15				4,8 - 11,1	N1848150	17.10	500	
	↔ 2250	5,1				17	5,5 - 12,0	N1848170	18.20	500
	⌘ 1600 max (N)	25				12,0 - 18,0	N1848250	21.90	500	

mit Grosskopf Ø 16 mm

Typ FAR N19

avec grande tête Ø 16 mm

4,8	4,9	10	16	1,8	1,5 - 6,0	N1948100	13.50	500	
	↔	16				6,4 - 12,7	N1948160	17.10	500
	↔ 2250 ⌘ 1600 max (N)	5,1				25	13,0 - 20,0	N1948250	27.70

Bestellbeispiel:
 Blindniet Alu / Inox Multi
 Grosskopf 16
 4,8 x 10 oder
 Art. N1948100

Exemple de commande:
 Rivet aveugle alu / inox Multi
 grande tête 16
 4,8 x 10 ou
 art. N1948100

HFT Fasteners AG

Bösch 37, CH-6331 Hünenberg
Telefon +41-41 780 70 01 Fax +41-41 780 73 49
Email: info@hft-fasteners.ch
Internet: www.hft-fasteners.ch



ISO 9001 Nr. 96-241-041

Blindniet
mit gerilltem Dorn
grosser Klemmbereich

Inox / Inox Multi

Typ FAR N58

Rivet aveugle
avec mandrin reillé
grande gamme de serrage

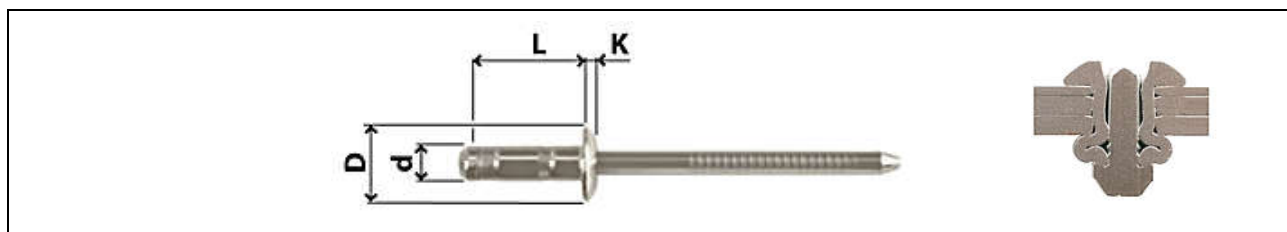

d Ø (mm)		L	D	K	mm	Art.	Fr./100	Verp. unité
3,2 ↔ 2500 ✂ 2000-3800 max (N)	3,4	7	6,5	1,0	1,0 - 3,0	N5832070	12.40	1000
		9			3,0 - 5,0	N5832090	13.50	1000
		11			5,0 - 7,0	N5832110	16.50	1000
4,0 ↔ 3700 ✂ 3500-5100 max (N)	4,2	7	8	1,3	1,2 - 3,0	N5840070	18.90	500
		9			3,0 - 5,0	N5840090	21.20	500
		12			5,0 - 7,0	N5840120	23.-	500
4,8 ↔ 5000 ✂ 5000-6900 max (N)	5,1	9	10	1,5	1,5 - 3,5	N5848090	35.30	500
		12			3,5 - 6,0	N5848120	39.10	500
		15			6,0 - 8,5	N5848150	41.90	500

Der Scher-**Höchstwert** entspricht der Prüfung mit Nietdorn im Scherbereich (min. Kl.bereich)

La valeur de cisaillement **supérieure** correspond à l'essai **avec le mandrin** lors de la rupture

Der Scher-**Mindestwert** entspricht der Prüfung ohne Nietdorn im Scherbereich

La valeur de cisaillement **inférieure** correspond à l'essai **sans le mandrin** lors de la rupture

Bestellbeispiel:
Blindniet Inox / Inox Multi
4,8 x 12 oder
Art. N5848120

Exemple de commande:
Rivet aveugle inox / inox Multi
4,8 x 12 ou
art. N5848120

HFT Fasteners AG

Bösch 37, CH-6331 Hünenberg
 Telefon +41-41 780 70 01 Fax +41-41 780 73 49
 Email: info@hft-fasteners.ch
 Internet: www.hft-fasteners.ch



ISO 9001 Nr. 96-241-041

Multi Blindniet

Inox / Inox PLUS

Multi Rivet aveugle

grosser Klemmbereich

Typ FAR N55

grande gamme de serrage

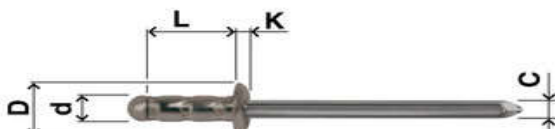

d Ø (mm)		L	D	K	mm	Art.	Fr./100	Verp. unité
3,2								
↔ 1800 ⌘ 1800 max (N)	3,4	11	6,5	1,0	1,0 - 6,0	N5532110	13.70	1000

d Ø (mm)		L	D	K	mm	Art.	Fr./100	Verp. unité
4,0								
↔ 3000 ⌘ 2700 max (N)	4,2	12	8	1,3	2,0 - 8,0	N5540120	18.90	500

d Ø (mm)		L	D	K	mm	Art.	Fr./100	Verp. unité
4,8								
↔ 4500 ⌘ 4000 max (N)	5,1	15	10	1,8	1,5 - 9,0	N5548150	31.50	500

Grosser Klemmbereich
 Eine einzige Länge überbrückt den
 Klemmbereich mehrerer Standard-Blindnieten
 Gleicht das Vorhandensein von
 unregelmässigen Bohrungen aus.
 Fixierter Nietdorn

Grande épaisseur de serrage
 Une seule longueur couvre l'épaisseur de
 serrage de plusieurs rivets standard
 Compense la présence de trous irréguliers
 Clou à retenue

HFT Fasteners AG

Bösch 37, CH-6331 Hünenberg
 Telefon +41-41 780 70 01 Fax +41-41 780 73 49
 Email: info@hft-fasteners.ch
 Internet: www.hft-fasteners.ch



ISO 9001 Nr. 96-241-041

Blindniet

grosser Klemmbereich
 mit gerilltem Dorn

Stahl / Stahl Multi-Tamp

acier / acier Multi-Tamp
 Typ FAR N23

Rivet aveugle

grande gamme de serrage
 avec mandrin reillé

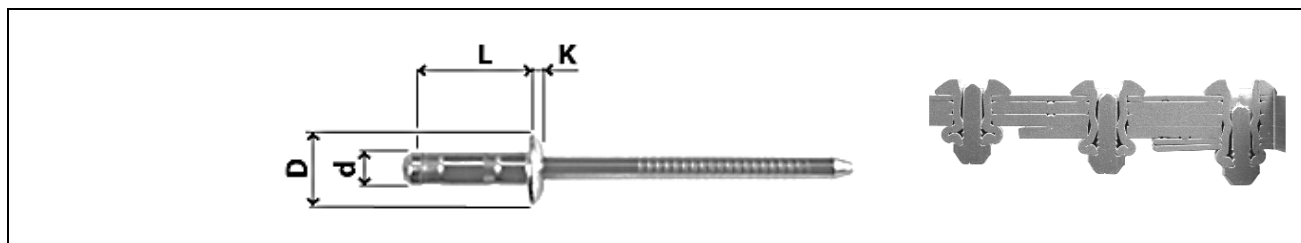

d Ø (mm)		L	D	K	mm	Art.	Fr./100	Verp. unité
3,2	3,4	7	6,5	1,0	1,0 - 3,0	N2332070	4.20	1000
		9			3,0 - 5,0	N2332090	4.70	1000
		11			5,0 - 7,0	N2332110	5.90	1000
		↔ 1482 ⌘ 1130-2600 max (N)						
4,0	4,2	7	8	1,3	1,2 - 3,0	N2340070	4.70	500
		9			3,0 - 5,0	N2340090	5.90	500
		12			5,0 - 7,0	N2340120	7.-	500
		↔ 2166 ⌘ 1947-3819 max (N)						
4,8	5,1	9	10	1,5	1,5 - 3,5	N2348090	7.70	500
		12			3,5 - 6,0	N2348120	8.80	500
		15			6,0 - 8,5	N2348150	11.20	500
		↔ 4199 ⌘ 2793-6650 max (N)						

Der Scher-**Höchstwert** entspricht der Prüfung mit Nietdorn im Scherbereich (min. Kl.bereich)

La valeur de cisaillement **supérieure** correspond l'essai **avec le mandrin** lors de la rupture

Der Scher-**Mindestwert** entspricht der Prüfung ohne Nietdorn im Scherbereich

La valeur de cisaillement **inférieure** correspond à l'essai **sans le mandrin** lors de la rupture

Bestellbeispiel: Blindniet Tamp
 Stahl / Stahl Multi 4.8 x 12 oder
 Art. N2348120

Exemple de commande:
 Rivet aveugle Tamp
 acier / acier Multi 4,8 x 12 ou art. N2348120

HFT Fasteners AG

Bösch 37, CH-6331 Hünenberg
 Telefon +41-41 780 70 01 Fax +41-41 780 73 49
 Email: info@hft-fasteners.ch
 Internet: www.hft-fasteners.ch



ISO 9001 Nr. 96-241-041

Becher-Dichtniet Flachrundkopf

Alu / Stahl

alu / acier
Typ FAR N17

Rivet étanche tête plate

Der Becher- Dicht-Blindniet hat ein geschlossenes Schaftende und der Dornkopf ist unverlierbar im Nietschaft eingebettet. Dadurch entsteht eine luft- und wasserdichte Nietverbindung.

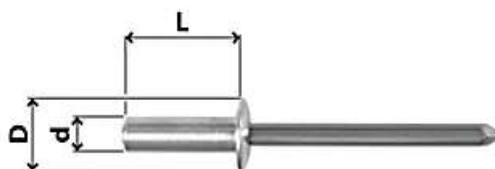

Le rivet étanche est complètement fermé et le mandrin y est renfermé de manière étanche

d Ø (mm)		L	D	K	mm	Art.	Fr./100	Verp. unité
3,2	3,3	7,5	6	1,3	1,5 - 3,5	N1732075	3.60	500
		9,0			3,5 - 4,5	N1732090	3.60	500
		↔ 1500			4,5 - 6,0	N1732105	4.20	500
		✂ 1000			6,0 - 8,0	N1732120	4.70	500
max (N)								

4,0	4,1	8,0	8	1,7	0,8 - 3,5	N1740080	4.70	500
		9,5			3,5 - 5,5	N1740095	5.40	500
		↔ 2100			6,4 - 7,5	N1740130	9.40	500
		✂ 1500			7,5 - 9,5	N1740140	9.40	500
max (N)								

4,8	5,0	10,0	9,5	2,0	3,5 - 5,0	N1748100	6.70	500	
		11,5			5,0 - 6,0	N1748115	7.-	500	
		↔ 3000			6,0 - 7,5	N1748130	7.-	500	
		✂ 2300			7,5 - 9,0	N1748145	7.-	500	
		max (N)			16,5	9,0 - 10,5	N1748165	8.20	500
					18,0	10,5 - 12,5	N1748180	8.80	500
22,0									
12,5 - 18,0									
N1748220									
9.40									
500									

mit Senkkopf

Typ FAR N27

à tête fraisée

4,8	5,0	11,5	9,5	2,0	3,5 - 6,5	N2748115	8.20	500
		14,5			6,5 - 9,0	N2748145	8.80	500
		↔ 3100			9,0 - 11,5	N2748180	10.70	500
		✂ 2650						
max (N)								

HFT Fasteners AG

Bösch 37, CH-6331 Hünenberg
 Telefon +41-41 780 70 01 Fax +41-41 780 73 49
 Email: info@hft-fasteners.ch
 Internet: www.hft-fasteners.ch



ISO 9001 Nr. 96-241-041

Becher-Dichtniet Flachrundkopf

Alu / Inox



Rivet étanche tête plate

Typ FAR N07

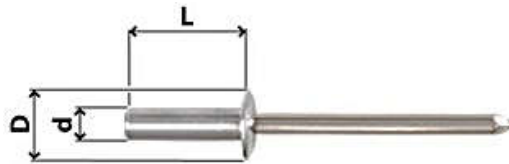
Der Becher- Dicht-Blindniet hat ein geschlossenes Schaftende und der Dornkopf ist unverlierbar im Nietschaft eingebettet. Dadurch entsteht eine luft- und wasser-dichte Nietverbindung



Le rivet étanche est complètement fermé et le mandrin y est renfermé de manière étanche

d Ø (mm)		L	D	K	mm	Art.	Fr./100	Verp. unité
3,2		7,5	6	1,3	1,5 - 3,0	N0732075	7.70	500
		9,5			3,5 - 5,0	N0732090	9.40	500
		12,5			6,5 - 8,0	N0732125	9.40	500
					-			
↔ 1300								
✂ 1000								
max (N)								

4,0		8,0	8	1,7	0,5 - 3,5	N0740080	10.10	500
		9,5			3,5 - 5,0	N0740095	10.10	500
		12,5			6,5 - 8,0	N0740120	10.70	500
↔ 2100								
✂ 1500								
max (N)								



4,8		8	9,5	2,0	1,0 - 3,5	N0748085	12.90	500
		11,0			4,5 - 6,0	N0748115	14.80	500
		14,0			7,5 - 9,0	N0748145	16.-	500
		18,0			11,0 - 13,0	N0748180	20.10	500
↔ 3000								
✂ 2000								
max (N)								

Bestellbeispiel:
 Becher- Dichtniet Alu / Inox
 4,8 x 18 oder
 Art. N0748180

Exemple de commande:
 Rivet étanche alu / inox
 4,8 x 18 ou
 art. N0748180

Becherniete Stahl /Stahl

Rivets étanches acier /acier

d Ø (mm)		L	D	K	mm	Art.	Fr./100	Verp. unité
3,2		9,5	6	1,3	3,0 - 5,0	N1332095	9.20	500
		12			5,0 - 6,5	N1332120	9.60	500

HFT Fasteners AG

Bösch 37, CH-6331 Hünenberg
Telefon +41-41 780 70 01 Fax +41-41 780 73 49
Email: info@hft-fasteners.ch
Internet: www.hft-fasteners.ch



ISO 9001 Nr. 96-241-041

Becher-Dichtniet Flachrundkopf

Inox / Inox

Rivet étanche tête plate

Typ FAR N57

Der Becher- Dicht-Blindniet hat ein geschlossenes Schaftende und der Dornkopf ist unverlierbar im Nietschaft eingebettet. Dadurch entsteht eine luft- und wasserdichte Nietverbindung.

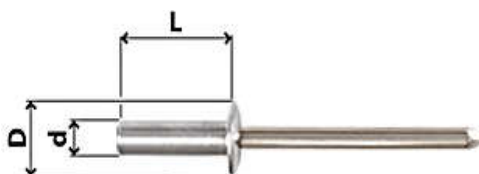

Le rivet étanche est complètement fermé et le mandrin y est renfermé de manière étanche

d Ø (mm)		L	D	K	mm	Art.	Fr./100	Verp. unité
3,2	3,3	8	6	1,3	0,5 - 2,5	N5732080	12.40	500
		10			2,5 - 4,5	N5732100	12.90	500
		12			4,5 - 7,0	N5732120	20.60	500
↔ 2350								
✕ 2200								
max (N)								

4,0	4,1	8	8	1,7	0,5 - 3,0	N5740080	19.40	500
		10			3,0 - 5,0	N5740095	20.10	500
		12			5,0 - 7,0	N5740120	21.90	500
↔ 4400								
✕ 4000								
max (N)								

4,8	5,0	8	9,5	2,0	0,5 - 2,0	N5748080	31.20	500
		10			2,0 - 4,0	N5748100	32.40	500
		12			5,0 - 6,5	N5748120	34.30	500
↔ 8000								
max (N)								

Bestellbeispiel:
Becher-Dichtniet Inox / Inox
4,8 x 16 oder
Art. N5748160

Exemple de commande:
Rivet étanche inox / inox
4,8 x 16 ou
art. N5748160

HFT Fasteners AG

Bösch 37, CH-6331 Hünenberg
 Telefon +41-41 780 70 01 Fax +41-41 780 73 49
 Email: info@hft-fasteners.ch
 Internet: www.hft-fasteners.ch



ISO 9001 Nr. 96-241-041

Spenglerniet

Cu-Ni / Inox
 zum Verlöten geeignet

CRNI - Inox / Inox

Typ N04

Rivet ferblantier

Cu-Ni / Inox
 peut être sudé (brasé)

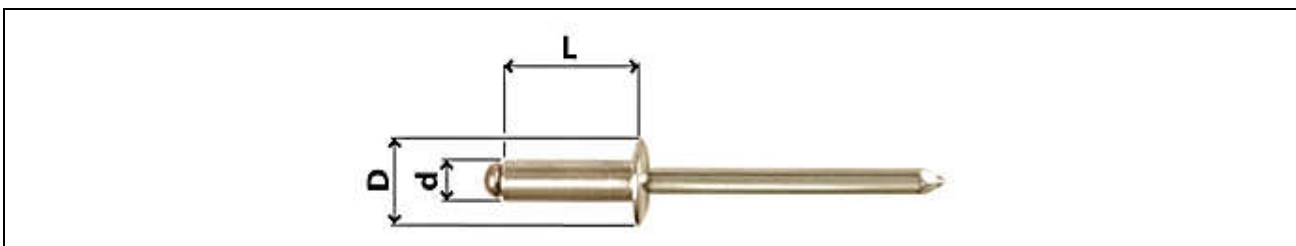

d Ø (mm)		L	D	K	mm	Art.	Fr./100	Verp. unité	
3,2 ↔ 2050 ✕ 1100 max (N)	3,3	CRNI-1	5	6,0	0,8	0,5 - 2,0	N0432050	15.10	1000
		CRNI-2	6			1,5 - 3,0	N0432060	15.60	1000
		CRNI-3	7			3,0 - 4,0	N0432070	15.60	1000
		CRNI-4	9			4,0 - 6,0	N0432090	19.70	500
		CRNI-5	12			8,0 - 9,0	N0432120	22.90	500
		CRNI-6	15			8,0 - 11,0	N0432150	26.50	500

Spenglerniet

Kupfer / Messing

CB - Kupfer / Bronze

Typ N14

Rivet ferblantier

Tige cuivre / Messing

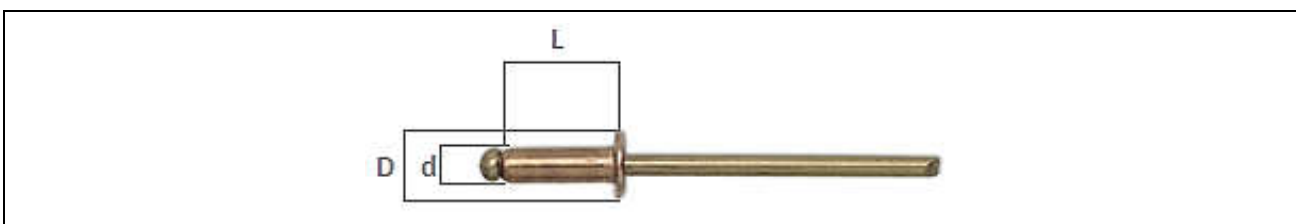

d Ø (mm)		L	D	K	mm	Art.	Fr./100.	Verp. unité
3,2 ↔ 1130 ✕ 880 max (N)	3,3	5	6	0,8	0,5 - 2,0	CB- 1 (N1433205)	10.90	1000
		6			2,0 - 3,0	CB- 2 (N1433206)	10.90	1000
		7			3,0 - 4,0	CB- 3 (N1433207)	12.50	1000
		9			4,0 - 6,0	CB- 4 (N1433209)	15.10	500
		12			6,0 - 9,0	CB- 5 (N1433212)	16.60	500
		15			9,0 - 12,0	CB- 6 (N1433215)	18.70	500

HFT Fasteners AG

Bösch 37, CH-6331 Hünenberg
 Telefon +41-41 780 70 01 Fax +41-41 780 73 49
 Email: info@hft-fasteners.ch
 Internet: www.hft-fasteners.ch



ISO 9001 Nr. 96-241-041

Sternniet

Alu / Stahl

alu / acier
Typ FAR N09

Rivet étoile

Der **Sternniet** eignet sich speziell für die Vernietung von weichen und spröden Materialien wie (Kunststoff, Holz, Schaumstoff etc). Die am Dornknopf befindlichen Schneidekanten schlitzten den Nietschaft während des Setzvorgangs so auf, dass eine grossflächige sternförmige Verformung auf der Blindseite entsteht.



Avec grande tête. Pour assembler des plaques en bois, plastique ou autres matières tendres.

d Ø (mm)		L	D	K	mm	Art.	Fr./100	Verp. Unité
4,0								
	4,3	16	8	1,3	6,0 - 10,0	N0940160	6.50	500
↔ 1250		20			10,0 - 14,0	N0940200	7.-	500
✂ 1450								
max (N)								

4,8	5,3	12	10	1,1	2,0 - 6,0	N0948120	6.50	500
		16			6,0 - 10,0	N0948160	8.20	500
↔ 2000		20			10,0 - 14,0	N0948200	10.70	500
✂ 2150		25			14,0 - 18,0	N0948250	11.80	500
max (N)		45			32,0 - 37,0	N0948450	22.40	500

6,4	7,0	18	12		3,0 - 7,0	N0964180	16.50	500
		22			7,0 - 11,0	N0964220	18.20	500
↔ 4000		26			11,0 - 15,0	N0964260	18.90	500
✂ 4000		30			15,0 - 20,0	N0964300	21.90	500
max (N)								

Inox / Inox

Typ N10

4,8								
↔ 2900	6,0	16	9,5	1,1	6,0 - 10,0	N1048160	111.40	500
✂ 4000								
max (N)								

HFT Fasteners AG

Bösch 37, CH-6331 Hünenberg
 Telefon +41-41 780 70 01 Fax +41-41 780 73 49
 Email: info@hft-fasteners.ch
 Internet: www.hft-fasteners.ch



ISO 9001 Nr. 96-241-041

Blindniet

mit grossem Schliesskopf
 + Dichtscheibe

BULB TITE

Rivet aveugle

avec grande surface
 + rondelle étanche

Beste Abdichtung dank Neopren-Scheibe.
Grosser Klemmbereich.
 Für die Verbindungen von weichen oder Druckempfindliche Materialien.

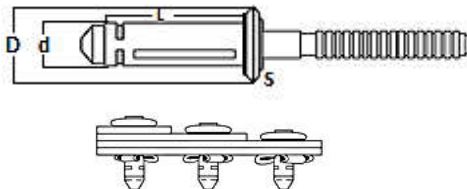

Très bonne étanchéité avec joint néoprène.
Grande gamme de serrage.
 Pour l'assemblage de matières souples ou ne supportant pas grande pression.

Alu / Alu

d Ø (mm)		L	D	S	mm	Art.	Fr./100	Verp. unité
5,2 mit Dichtung avec rondelle d'étanchéité ↔ 2000 ↗ 3300 max (N)	5,4	W3 - 17,5	11,5	2,2	0,5 - 4,8	10340003	54.60	1000
		W4 - 19,1			1,5 - 6,4	10340004	55.-	1000
		W6 - 22,2			4,8 - 9,5	10340006	56.50	1000
		W8 - 25,4			7,9 - 12,7	10330008	58.10	1000
		W10 - 28,6			11,1 - 15,9	10330010	59.80	500
		W12 - 31,8			14,3 - 19,1	10330012	61.40	500

**Wasserdicht, vibrationsfest,
 mit grossem Klemmbereich**

**Étanche, résistant aux vibrations
 grande gamme de serrage**

4,8 mit Dichtung avec rondelle d'étanchéité ↔ 1700 ↗ 2400 →← 300 max (N)	5,2	26	11,5	3	1,3 - 7,9	MTPB65S	52.20	500
	↔ 5,5							

6.1 mit Dichtung avec rondelle d'étanchéité ↔ 2600 ↗ 4200 →← 300 max (N)	6,4	28	13,5	3	3,2 - 9,5	MTPB86S	66.60	500
	↔ 6,6							

HFT Fasteners AG

Bösch 37, CH-6331 Hüenenberg
 Telefon +41-41 780 70 01 Fax +41-41 780 73 49
 Email: info@hft-fasteners.ch
 Internet: www.hft-fasteners.ch



ISO 9001 Nr. 96-241-041

Fassaden-Niet

mit Grosskopf ø 14 mm
 z.B. für ALUCOBOND

Alu / Inox

Typ FAR N16A

Rivet façades

avec grande tête ø 14 mm
 p.ex. pour ALUCOBOND

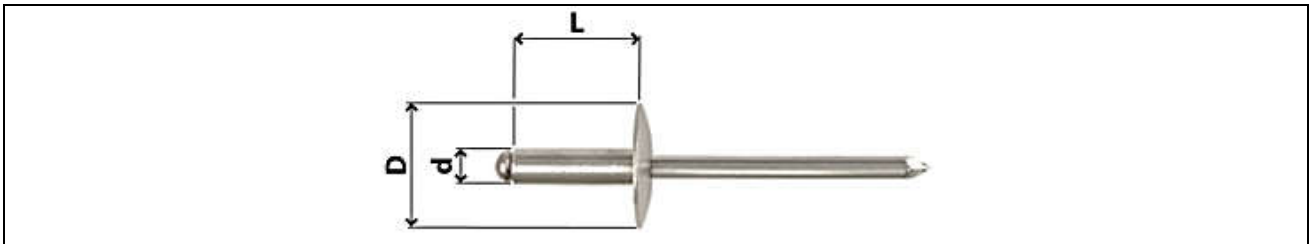

d Ø (mm)		L	D	K	mm	Art.	Fr./100	Verp. unité
5,0	5,1	12	14	1,5	6,0 - 8,0	N1650120	15.30	500
↔ 3100		14			7,5 - 10,0	N1650140	16.-	500
⊗ 2150		18			11,5 - 13,5	N1650180	21.20	250
max (N)		20			13,0 - 15,5	N1650200	23.-	250

auf Anfrage auch in den Alucobond
 Standardfarben erhältlich!

Sur demande disponible en
 Alucobond couleurs standard!

Dilatationsmundstück zu AccuBird für Alucobond 16-er Nietkopf, Tiefen- anschlag zu Stufenbohrer Pelicolor 5.1 x 8 mm und 4.9 x 8 mm		Buse dilatation pour AccuBird pour Alucobond tête rivet 16 mm, came de butée pour forets Pelicolor 5.1 x 8 mm et 4.9 x 8 mm
---	--	--

Hammerschlagriet

Alu / Inox

Rivet à marteau

d Ø (mm)		L	D1	K	mm	Art.	Fr./100.	Verp. unité
4,8	5,0	35	15,5	2	29,0 - 31,0	AVT48350	24.70	250
↔ 1900								
⊗ 3500								
max (N)								

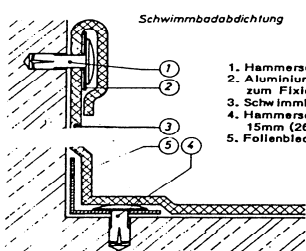

1. Hammerschlag-Niet
2. Aluminium 1 x 20 mm zum Fixieren
3. Schwimmbadfolie
4. Hammerschlag-Niet 15mm (26mm)
5. Follenblech

Bestellbeispiel:
 Avdel Hammerschlagriet Alu/Inox
 Code 5161-0697 oder
 4,8 x 25,4 mm

Exemple de commande:
 Avdel rivet à marteau alu/inox
 code 5161-0697 ou
 4,8 x 25,4 mm

Mit einem Schlag schnelle und sichere Befestigung von:

- Alu- und Blechprofilen
- Wandanschlußprofilen
- Dachrandprofilen
- Kaminabdichtungen
- Mauerabdeckungen
- Lichtkuppeln
- Dachdichtungsbahnen
- Flanschbefestigungen
- usw.

auf:

- Mauerwerk
- Holz
- Unterkonstruktionen bei DACH und WAND!

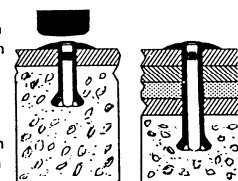

HFT Fasteners AG

Bösch 37, CH-6331 Hünenberg
 Telefon +41-41 780 70 01 Fax +41-41 780 73 49
 Email: info@hft-fasteners.ch
 Internet: www.hft-fasteners.ch



ISO 9001 Nr. 96-241-041

Gerillter Niet

(Sackloch-Niet)

Alu / Stahl

alu / acier
Typ FAR N06

Rivet cannelé

(Rivet pour cul-de-sac)

Für Nietungen in volles Material oder Holz und Kunststoff. Der gerillte Schaft krallt sich in der Bohrlochwand fest.

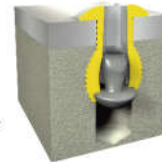
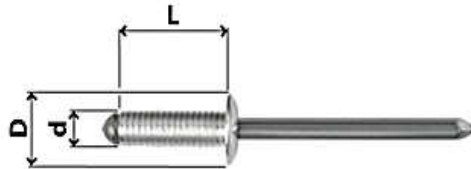

Pour rivetages dans matières pleines ou bois et plastiques. Le rivet s'accroche aux parois du trou.

d Ø (mm)		L	D	K	mm	Art.	Fr./100	Verp. unité
5,0	5,2	10	9,5	1,1	bis 6	N0650100	4.20	500
↔ 2350		18			bis 13	N0650180	7.70	250
⌘ 1960		26			bis 20	N0650260	10.10	250
max (N)								

HFT Fasteners AG

Bösch 37, CH-6331 Hünenberg
Telefon +41-41 780 70 01 Fax +41-41 780 73 49
Email: info@hft-fasteners.ch
Internet: www.hft-fasteners.ch

ISO 9001 Nr. 96-241-041



Auf den nachfolgenden Seiten
34 – 46 folgen

Blindnietmuttern

Sur les pages 34 – 46
suivantes voici les

Inserts filetés

HFT Fasteners AG

Bösch 37, CH-6331 Hünenberg
 Telefon +41-41 780 70 01 Fax +41-41 780 73 49
 Email: info@hft-fasteners.ch
 Internet: www.hft-fasteners.ch



ISO 9001 Nr. 96-241-041

FTT Aluminium

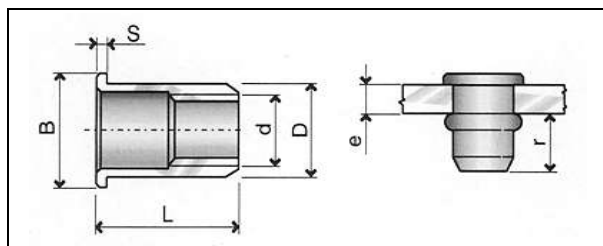

Blindnietmuttern Flachkopf

Insert fileté à tête cylindrique

Typ	M	e	r min/max	δ	D	B	S	L	Art.	Fr./100
FTT/C	3	0.3 - 1.8	4.2/4.6	5	4.9	7	0.8	9	FA620030	12.90
FTT/L	3	1.8 - 3.0	4.2/4.6	5	4.9	7	0.8	10.5	FA620032	12.90
FTT/C	4	0.3 - 2.5	5.5/6.0	6	5.9	9	1	11	FA620040	11.20
FTT/L	4	2.5 - 4.0	5.5/6.0	6	5.9	9	1	13	FA620042	14.80
FTT/C	5	0.5 - 2.3	7.2/7.7	7	6.9	10	1.2	13	FA620050	11.80
FTT/L	5	3.0 - 5.0	7.2/7.7	7	6.9	10	1.2	15.5	FA620051	15.30
FTT/C	6	0.5 - 2.3	7.6/8.2	9	8.9	12	1.5	14.5	FA620060	20.10
FTT/M	6	2.3 - 4.0	7.6/8.2	9	8.9	12	1.5	16	FA620061	20.10
FTT/L	6	4.0 - 6.0	7.6/8.2	9	8.9	12	1.5	17.5	FA620062	20.10
FTT/C	8	0.8 - 3.5	9.1/10.1	11	10.9	15	1.5	17.5	FA620080	18.90
FTT/L	8	3.5 - 6.0	9.1/10.1	11	10.9	15	1.5	20	FA620082	18.90
FTT/C	10	1.0 - 3.5	-	13	12.9	19	2.1	17	FA620010	29.40
FTT/L	10	3.1 - 6.0	-	13	12.9	17	2.1	22	FA6210220	31.20

HFT Fasteners AG

Bösch 37, CH-6331 Hünenberg
 Telefon +41-41 780 70 01 Fax +41-41 780 73 49
 Email: info@hft-fasteners.ch
 Internet: www.hft-fasteners.ch



ISO 9001 Nr. 96-241-041

FTT Stahl v. / acier z.

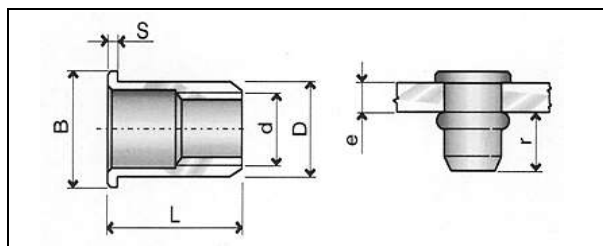

Blindnietmuttern Flachkopf

Insert fileté à tête cylindrique

Typ	M		r min/max		D	B	S	L	Art.	Fr./100
FTT/C	3	0.3 - 1.8	4.2/4.6	5	4.9	7	0.8	9	FA610030	11.80
FTT/L	3	1.8 - 3.0	4.2/4.6	5	4.9	7	0.8	10.5	FA610032	12.90
FTT/C	4	0.3 - 2.5	5.5/6.0	6	5.9	9	1	11	FA610040	13.-
FTT/L	4	2.5 - 4.0	5.5/6.0	6	5.9	9	1	13	FA610042	14.10
FTT/C	5	0.5 - 3.0	7.2/7.7	7	6.9	10	1.2	13	FA610050	13.30
FTT/L	5	3.0 - 5.0	7.2/7.7	7	6.9	10	1.2	15.5	FA610051	14.80
FTT/C	6	0.5 - 3.0	7.6/8.2	9	8.9	12	1.5	14.5	FA610060	14.10
FTT/L	6	3.0 - 5.5	7.6/8.2	9	8.9	12	1.5	17.5	FA610062	19.40
FTT/C	8	0.8 - 3.5	9.5/10.1	11	10.9	15	1.5	17.5	FA610080	17.10
FTT/L	8	3.5 - 6.0	9.5/10.1	11	10.9	15	1.5	20	FA610082	17.10
FTT/C	10	1.0 - 3.5	12.5/13.5	13	12.9	17	1.7	21	FA610100	24.70
FTT/L	10	3.5 - 6.0	12.5/13.5	13	12.9	17	1.7	24	FA610102	35.90
FTT/C	12	1.0 - 4.0	12.5/13.5	15	14.9	20	2	22	FA610120	60.60
FTT/L	12	4.0 - 7.0	12.5/13.5	15	14.9	20	2	25	FA610122	104.90

HFT Fasteners AG

Bösch 37, CH-6331 Hünenberg
 Telefon +41-41 780 70 01 Fax +41-41 780 73 49
 Email: info@hft-fasteners.ch
 Internet: www.hft-fasteners.ch



ISO 9001 Nr. 96-241-041

FTT Inox

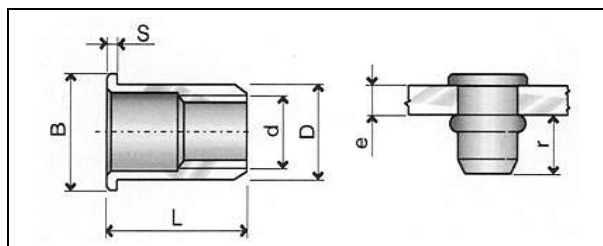

Blindnietmuttern Flachkopf

Insert fileté à tête cylindrique

Typ	M	e	r min/max	$\frac{\phi}{\phi_{\text{max}}}$	D	B	S	L	Art.	Fr./100
FTT/C	3	0.3 - 1.0	5.5/5.8	5	4.9	7	0.8	8.5	FA611030	22.40
FTT/M	3	1.0 - 2.0	5.5/5.8	5	4.9	7	0.8	9.5	FA611031	22.40
FTT/L	3	2.0 - 3.0	5.5/5.8	5	4.9	7	0.8	10.5	FA611032	22.40
FTT/C	4	0.3 - 2.5	5.5/6.0	6	5.9	9	1	11	FA611040N	34.30
FTT/L	4	2.5 - 4.0	5.5/6.0	6	5.9	9	1	13	FA611042	34.30
FTT/C	5	0.5 - 3.0	7.2/7.7	7	6.9	10	1.2	13	FA611050N	50.20
FTT/L	5	3.0 - 5.0	7.2/7.7	7	6.9	10	1.2	15.5	FA611052	50.20
FTT/C	6	0.5 - 3.0	7.6/8.2	9	8.9	12	1.5	14.5	FA611060	67.30
FTT/L	6	3.0 - 5.5	7.6/8.2	9	8.9	12	1.5	17.5	FA611062	87.40
FTT/C	8	0.8 - 3.5	9.5/10.1	11	10.9	15	1.5	17.5	FA611080N	99.-
FTT/L	8	3.5 - 6.0	9.5/10.1	11	10.9	15	1.5	20	FA611082	142.70
FTT/C	10	1.0 - 3.5	13/14	13	12.9	17	1.7	21	FA611010	163.90
FTT/L	10	3.5 - 6.0	13/14	13	12.9	17	1.7	24	FA611012	187.10
FTT/C	12	1.0 - 4.0		16	15.9	23	2.0	23	FA611120	195.90

HFT Fasteners AG

Bösch 37, CH-6331 Hünenberg
 Telefon +41-41 780 70 01 Fax +41-41 780 73 49
 Email: info@hft-fasteners.ch
 Internet: www.hft-fasteners.ch



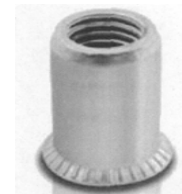
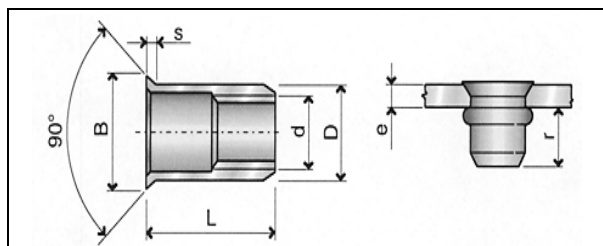

ISO 9001 Nr. 96-241-041

FTS Aluminium



Blindnietmutter Senkkopf

Insert fileté à tête fraisée

Typ	M		r min/max		D	B	S	L	Art.	Fr./100
FTS/C	3	1.5 - 2.8	4.7/5.3	5	4.9	8	1.5	9.5	FA640030	12.90
FTS/L	3	2.8 - 4.0	4.7/5.3	5	4.9	8	1.5	10.5	FA640032	12.90
FTS/C	4	1.5 - 3.5	5.3/6.1	6	5.9	9	1.5	11	FA640040	14.80
FTS/L	4	3.5 - 5.0	5.3/6.1	6	5.9	9	1.5	13	FA640042	14.80
FTS/C	5	1.5 - 3.8	6.8/7.3	7	6.9	10	1.5	13	FA640050	11.80
FTS/L	5	3.8 - 6.0	6.8/7.3	7	6.9	10	1.5	15	FA640052	15.30
FTS/C	6	1.5 - 3.8	8.5/9.2	9	8.9	12	1.5	15	FA640060	16.-
FTS/L	6	3.8 - 6.0	8.5/9.2	9	8.9	12	1.5	17	FA640062	20.10
FTS/C	8	1.5 - 3.8	9.5/10.4	11	10.9	14	1.5	16.5	FA640080	24.70
FTS/L	8	3.8 - 6.0	9.5/10.4	11	10.9	14	1.5	19	FA640081	30.10
FTS/C	10	1.5 - 4.5	11/12	13	11.9	15	1.5	18	FA640010	42.50
FTS/L	10	3.8 - 6.0	11/12	12	11.9	15	1.5	20.5	FA640102	42.50

HFT Fasteners AG

Bösch 37, CH-6331 Hünenberg
 Telefon +41-41 780 70 01 Fax +41-41 780 73 49
 Email: info@hft-fasteners.ch
 Internet: www.hft-fasteners.ch



ISO 9001 Nr. 96-241-041

FTS Stahl v. / acier z.

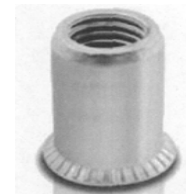
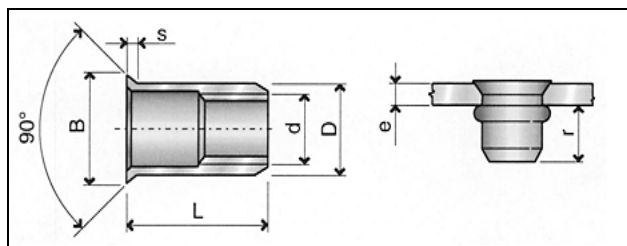

Blindnietmutter Senkkopf

Insert fileté à tête fraisée

Typ	M	e	r min/max	\emptyset	D	B	S	L	Art.	Fr./100
FTS/C	3	1.5 - 2.8	4.7/5.3	5	4.9	8	1.5	9.5	FA630030	11.20
FTS/L	3	2.8 - 4.0	4.7/5.3	5	4.9	8	1.5	10.5	FA630032	12.40
FTS/C	4	1.5 - 3.5	5.8/6.1	6	5.9	9	1.5	11	FA630040	12.90
FTS/L	4	3.5 - 5.0	5.8/6.1	6	5.9	9	1.5	13	FA630042	12.90
FTS/C	5	1.5 - 3.8	6.3/7.3	7	6.9	10	1.5	13	FA630050	11.20
FTS/L	5	3.8 - 6.0	6.3/7.3	7	6.9	10	1.5	15	FA630052	14.80
FTS/C	6	1.5 - 3.8	8.5/9.2	9	8.9	12	1.5	15	FA630060	14.10
FTS/L	6	3.8 - 6.0	8.5/9.2	9	8.9	12	1.5	17	FA630062	19.40
FTS/C	8	1.5 - 3.8	9.2/10.2	11	10.9	14	1.5	16.5	FA630080	17.10
FTS/L	8	3.8 - 6.0	9.2/10.2	11	10.9	14	1.5	19	FA630081	18.10
FTS/C	10	1.5 - 3.8	11/12	12	11.9	15	1.5	18	FA630100	21.90
FTS/L	10	3.8 - 6.0	11/12	12	11.9	15	1.5	20.5	FA630102	21.90

HFT Fasteners AG

Bösch 37, CH-6331 Hünenberg
 Telefon +41-41 780 70 01 Fax +41-41 780 73 49
 Email: info@hft-fasteners.ch
 Internet: www.hft-fasteners.ch



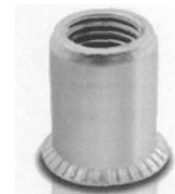
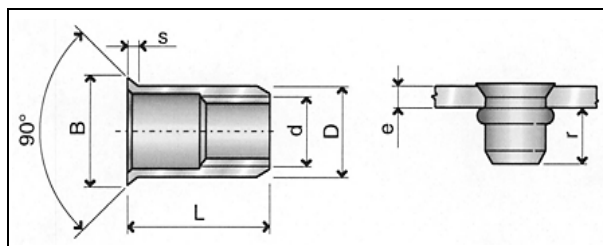

ISO 9001 Nr. 96-241-041

FTS Inox



Blindnietmutter Senkkopf

Insert fileté à tête fraisée

Typ	M		r min/max		D	B	S	L	Art.	Fr./100
FTS/C	4	1.5 - 3.5	5.8/6.3	6	5.9	9	1.5	11	FA631040N	34.30
FTS/L	4	3.5 - 5.0	5.8/6.3	6	5.9	9	1.5	13	FA631042	34.30
FTS/C	5	1.5 - 3.8	6.8/7.3	7	6.9	10	1.5	13	FA631050N	39.10
FTS/L	5	3.8 - 6.0	6.8/7.3	7	6.9	10	1.5	15	FA631052	48.80
FTS/C	6	1.5 - 3.8	8.5/9.2	9	8.9	12	1.5	15	FA631060N	67.30
FTS/L	6	3.8 - 6.0	8.5/9.2	9	8.9	12	1.5	17	FA631062	87.40
FTS/C	8	1.5 - 3.8	9.5/10.4	11	10.9	14	1.5	16.5	FA631080N	99.-
FTS/L	8	3.8 - 6.0	9.5/10.4	11	10.9	14	1.5	19	FA631082	110.30
FTS/C	10	1.5 - 3.5	11.5/12.5	13	12.9	16	1.5	18	FA631100	163.90
FTS/L	10	3.5 - 6.0	11.5/12.5	13	12.9	16	1.5	20.5	FA631102	187.10

HFT Fasteners AG

Bösch 37, CH-6331 Hünenberg
 Telefon +41-41 780 70 01 Fax +41-41 780 73 49
 Email: info@hft-fasteners.ch
 Internet: www.hft-fasteners.ch



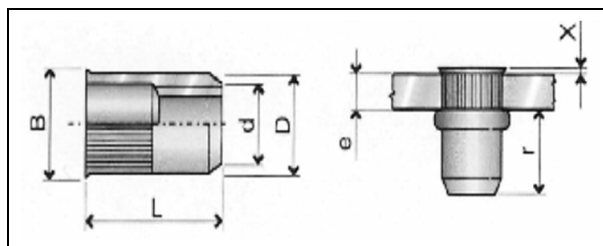

ISO 9001 Nr. 96-241-041

FTR Stahl v. / acier z.



Blindnietmutter Kleinkopf, gerändelt

Insert fileté à tête fraisée, rainurée

Typ	M		r min/max		D	B	X	L	Art.	Fr./100
FTR/C *	3	0.5 - 1.5	5.4/5.8	5	4.9	5.5	0.3	8.5	FA650031	11.80
FTR/L *	3	1.5 - 2.5	5.4/5.8	5	4.9	5.5	0.3	9.5	FA650032	11.80
FTR/C	4	0.5 - 1.5	6.5/7.0	6	5.9	6.75	0.4	10	FA62204002	12.90
FTR/L	4	1.5 - 2.5	6.5/7.0	6	5.9	6.75	0.4	11	FA650042	12.90
FTR/C	5	0.5 - 2.0	7.5/8.0	7	6.9	8	0.4	12	FA62205002	10.10
FTR/L	5	2.0 - 3.5	7.5/8.0	7	6.9	8	0.4	13.5	FA650052	14.80
FTR/C	6	0.5 - 2.0	9.0-9.7	9	8.9	10	0.4	13.5	FA62206002	14.10
FTR/L	6	2.0 - 3.5	9.0-9.7	9	8.9	10	0.4	15	FA650062	19.40
FTR/C	8	1.0 - 2.5	10.7/11.4	11	10.9	12	0.4	16.5	FA62208002	17.10
FTR/L	8	2.5 - 4.0	10.7/11.4	11	10.9	12	0.4	18	FA650082	17.10
FTR/C *	10	1.0 - 2.5	12.3/13.1	12	11.9	13.5	0.4	18	FA650100	32.40
FTR/L *	10	2.5 - 4.0	12.3/13.1	12	11.9	13.5	0.4	19.5	FA650102	32.40

HFT Fasteners AG

Bösch 37, CH-6331 Hünenberg
 Telefon +41-41 780 70 01 Fax +41-41 780 73 49
 Email: info@hft-fasteners.ch
 Internet: www.hft-fasteners.ch



ISO 9001 Nr. 96-241-041

FTR Inox

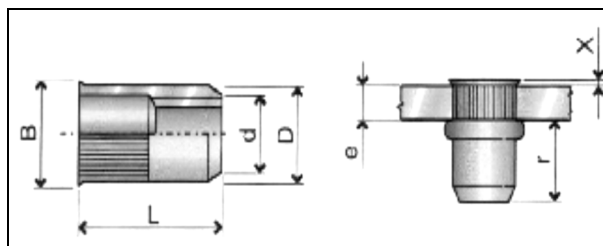

Blindnietmutter Kleinkopf, gerändelt

Insert fileté à tête fraisée, rainurée

Typ	M	e	r min/max	$\frac{\delta}{\delta_{max}}$	D	B	X	L	Art.	Fr./100
FTR	4	0.5 - 1.5	8.0	6	5.9	6.75	0.4	10	FA64504001	27.70
FTR	4	0.5 - 3.0	7.0	6	6.0	7	0.8	10	FA7550412000	24.30
FTR	5	0.5 - 3.0	8.0	7	7.0	8	0.8	11.5	FA05115FM2	27.20
FTR	6	0.5 - 3.0	10.0	9	9.0	10	0.8	14	FA06140FM2	36.50
FTR	8	0.5 - 3.0	12.0	11	11	12	0.8	15.5	FA08155FM2	50.80
FTR	10	0.8 - 3.5	14.5	13	13	14.5	0.8	19.5	FA641012000	56.20

HFT Fasteners AG

Bösch 37, CH-6331 Hünenberg
 Telefon +41-41 780 70 01 Fax +41-41 780 73 49
 Email: info@hft-fasteners.ch
 Internet: www.hft-fasteners.ch



ISO 9001 Nr. 96-241-041

FTTC Aluminium

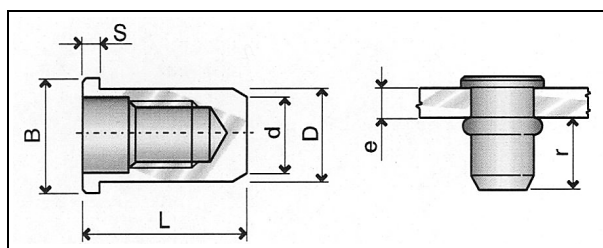

Blindnietmutter Flachkopf, Rundschafft, geschlossen

Insert fileté tête cylindrique, fermée

Typ	M	e	r min/max	\varnothing	D	B	S	L	Art.	Fr./100
FTTC/C	4	0.5 - 2.5	11.3/12	6	5.9	9	1	16.5	FA623040	25.30
FTTC/L	4	2.5 - 4.0	11.3/12	6	5.9	9	1	18	FA623042	25.30
FTTC/C	5	0.5 - 3.0	12.3/13	7	6.9	10	1.2	18	FA623050	30.10
FTTC/L	5	3.0 - 5.0	12.3/13	7	6.9	10	1.2	20.5	FA623052	30.10
FTTC/C	6	0.5 - 2.3	14/14.5	9	8.9	12	1.5	20.5	FA623060	27.70
FTTC/M	6	2.3 - 4.0	14/14.5	9	8.9	12	1.5	22	FA623061	37.80
FTTC/L	6	4.0 - 6.0	14/14.5	9	8.9	12	1.5	23.5	FA623062	34.90
FTTC/C	8	0.8 - 3.5	17.5/18.2	11	10.9	15	1.5	25.5	FA623080	46.50
FTTC/L	8	3.5 - 6.0	17.5/18.2	11	10.9	15	1.5	28	FA623082	46.50
FTTC/C	10	1.0 - 3.5	20.1/21.1	12	11.9	16	1.7	29	FA623010	59.-
FTTC/L	10	3.5 - 6.0	20.1/21.1	12	11.9	16	1.7	31.5	FA623012	63.60

HFT Fasteners AG

Bösch 37, CH-6331 Hünenberg
 Telefon +41-41 780 70 01 Fax +41-41 780 73 49
 Email: info@hft-fasteners.ch
 Internet: www.hft-fasteners.ch



ISO 9001 Nr. 96-241-041

FTTC Stahl v. / acier z.

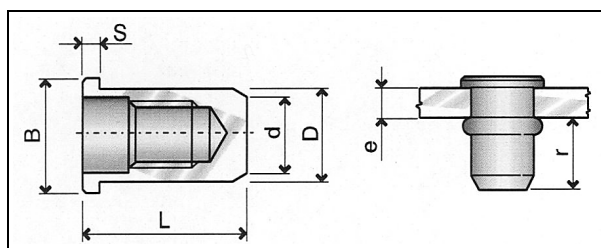

Blindnietmutter Flachkopf, Rundschafft, geschlossen

Insert fileté tête cylindrique, fermée

Typ	M	e	r min/max	$\frac{D}{d}$	D	B	S	L	Art.	Fr./100
FTTC/C	4	0.3 - 2.5	11.3/12	6	5.9	9	1	18	FA613040	21.90
FTTC/C	5	0.5 - 3.0	12.3/13	7	6.9	10	1.2	18	FA613050	30.10
FTTC/L	5	3.0 - 5.0	12.3/13	7	6.9	10	1.2	20.5	FA613052	30.10
FTTC/C	6	0.5 - 2.3	14/14.5	9	8.9	12	1.5	20.5	FA613060	32.40
(FTTC/M)	6	2.3 - 4.0	14/14.5	9	8.9	12	1.5	22	FA613061	32.40
FTTC/L	6	3.5 - 5.5	14/14.5	9	8.9	12	1.5	23.5	FA613062	36.50
FTTC/C	8	0.8 - 3.5	17.5/18.2	11	10.9	15	1.5	25.5	FA613080	43.-
FTTC/L	8	3.5 - 6.0	17.5/18.2	11	10.9	15	1.5	28	FA613082	43.-
FTTC/C	10	1.0 - 3.5	20.1/21.1	12	11.9	16	1.7	29	FA613010	51.80

HFT Fasteners AG

Bösch 37, CH-6331 Hünenberg
 Telefon +41-41 780 70 01 Fax +41-41 780 73 49
 Email: info@hft-fasteners.ch
 Internet: www.hft-fasteners.ch



ISO 9001 Nr. 96-241-041

FTT-Z Stahl v. / acier z.

Auslauftyp / fin de série
 Ersatz/remplacé par FTT
 Seite / page 35

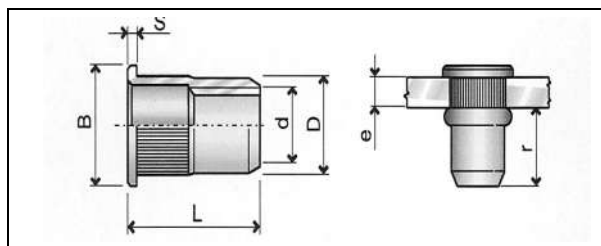

Auslauftyp /

fin de série

Blindnietmutter Flachkopf, Rundschafft, gerändelt

Insert fileté tête cylindrique, cannelée

Typ	M	e	r min/max	$\frac{\phi}{S}$	D	B	S	L	Art.	Fr./100
FTT-Z/M	4	1.5 - 2.5	7/7.5	6	5.9	9	1	12	FA62104202	14.80
FTT-Z/L	4	2.5 - 3.5	7/7.5	6	5.9	9	1	13	FA62104302	14.80
FTT-Z/C	5	0.5 - 2.0	8/8.5	7	6.9	10	1.2	13	FA62105102	17.10
FTT-Z/L	5	3.5 - 5.0	8/8.5	7	6.9	10	1.2	16	FA62105302	17.10
FTT-Z/L	6	3.5 - 5.0	8/9	9	8.9	12	1.5	17.5	FA62106302	21.20
FTT-Z/L	8	4.0 - 5.5	10.2/11.2	11	10.9	15	1.5	20.5	FA62108302	33.-

HFT Fasteners AG

Bösch 37, CH-6331 Hünenberg
 Telefon +41-41 780 70 01 Fax +41-41 780 73 49
 Email: info@hft-fasteners.ch
 Internet: www.hft-fasteners.ch



ISO 9001 Nr. 96-241-041

FTTEC Stahl v. / acier z.

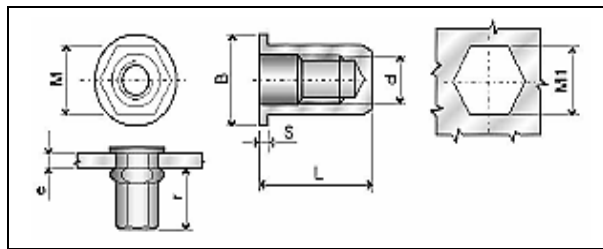

6-kant Nietmutter Flachkopf, geschlossen

Insert fileté 6-pan, cylindrique, fermé

Typ	M	e	r min/max	M1	M	B	S	L	Art.	Fr./100
FTTEC	6	0.5 - 3.0	15/16	9	8.9	13	1.5	22	FA63206001	33.-
FTTEC	8	0.5 - 3.0	18.8/19.5	11	10.9	16	1.5	26	FA631100012	34.30

FTRE Stahl v. / acier z.

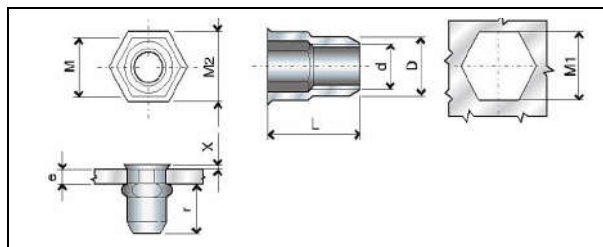

Teil 6-kant Nietmutter, Kleinkopf

Insert fileté 6-pan en partie, tête réduite

Typ	M	e	r min/max	M1	M	M2	X	D	L	Art.	Fr./100
FTRE	4	0.5 - 2.0	6.5/6.8	6.4	6.3	7	0.4	6.3	10.4	FA633040	15.30
FTRE	5	0.5 - 3.0	6.5/6.7	7.3	7.2	8	0.4	7.1	11.8	FA633050	16.50
FTRE	6	0.7 - 3.0	9.4/9.6	9.7	9.6	10.4	0.4	9.5	14.6	FA633060	20.70
FTRE	8	0.9 - 3.3	10.2/10.6	10.7	10.6	11.6	0.4	10.5	16	FA633080	24.30

HFT Fasteners AG

Bösch 37, CH-6331 Hünenberg
 Telefon +41-41 780 70 01 Fax +41-41 780 73 49
 Email: info@hft-fasteners.ch
 Internet: www.hft-fasteners.ch



ISO 9001 Nr. 96-241-041

IE Inox

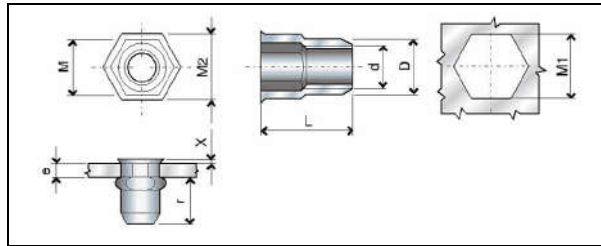

Teil 6-kant Nietmutter, Kleinkopf

Insert 6-pan en partie, tête réduite

Typ	M	e	r_{max}	M1	M	M2	X	D	L	Art.	Fr./100
IE	4	0.5 - 2.0	8	6	5.9	6.8	0.4	5.9	10.6	FA619040	31.90
IE	5	0.5 - 3.0	8	7	6.9	8	0.4	6.9	11.6	FA619050	53.10
IE	6	0.5 - 3.0	10.6	9	8.9	10	0.5	8.9	14.5	FA619060	90.30
IE	8	0.8 - 3.0	11.1	11	10.9	12	0.5	10.9	15.8	FA619080	126.-

IE Stahl

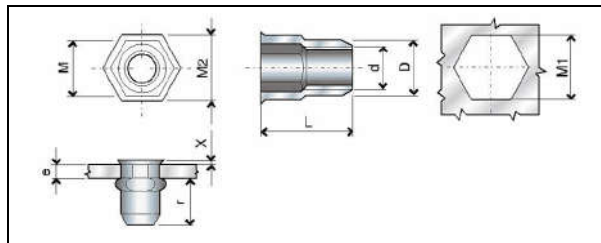

Teil 6-kant Nietmutter, Kleinkopf

Insert 6-pan en partie, tête réduite

Typ	M	e	r_{max}	M1	M	M2	X	D	L	Art.	Fr./100
IE	4	0.5 - 2.0	8	6	5.9	6.8	0.4	5.9	10.6	FA660040	15.30
IE	5	0.5 - 3.0	8	7	6.9	8	0.4	6.9	11.6	FA660050	16.50
IE	6	0.5 - 3.0	10.6	9	8.9	10	0.5	8.9	14.5	FA660060	20.70
IE	8	0.8 - 3.0	11	11	10.9	12	0.5	10.9	15.8	FA660080	24.30

IE weichen von dem Typ FTRE in der Sechskantabmessung ab
 IE Ils diffèrent du modèle FTRE par la dimension de l'hexagone

HFT Fasteners AG

Bösch 37, CH-6331 Hünenberg
Telefon +41-41 780 70 01 Fax +41-41 780 73 49
Email: info@hft-fasteners.ch
Internet: www.hft-fasteners.ch



ISO 9001 Nr. 96-241-041

*Die Preise auf den nachfolgenden Seiten sind **netto** + MWST.* *Les prix sur les pages suivantes sont **nets** + TVA*

Nasslackieren Nieten :	Thermolaque rivets
< 1'500 Stk. Fr. 250.- Fix	< 1'500 Stk. Fr. 250.- Fix
> 1'500 Stk. – 3'000 Stk. Fr. 17.- / 100 Stk.	> 1'500 Stk. – 3'000 Stk. Fr. 17.- / 100 pcs..
> 3'000 Stk. Fr. 15.- / .100 Stk.	> 3'000 Stk. Fr. 15.- / 100 pcs.
IGP oder lackieren nach Farbmuster + Fr. 95.- Farbmischzuschlag	IGP ou coloration selon échantillons de couleur + Fr. 95.- fix pour mélanger le couleur

HFT Fasteners AG

Bösch 37, CH-6331 Hünenberg
Telefon +41-41 780 70 01 Fax +41-41 780 73 49
Email: info@hft-fasteners.ch
Internet: www.hft-fasteners.ch



ISO 9001 Nr. 96-241-041

Hand-Nietwerkzeuge

Outils à river manuel

K 39

für Stahl- & Alu-Nieten
bis \varnothing 4,8 mm
Kopfhöhe 80 mm



0,5 kg

Fr. 39.50 netto
(W0700039)

K 39

pour rivets en acier et en
alu jusqu'à \varnothing 4,8 mm
hauteur nez de pose 80 mm

TT 55-D

Handnietzange für Stahl-
Nieten bis \varnothing 3,2 mm
& Alu bis \varnothing 4,0 mm
Kopfhöhe 75 mm



0,5 kg

Fr. 41.- netto
(WTT55F)

TT 55-D

Pince à river pour rivets en
acier jusqu'à \varnothing 3,2 mm
et en alu \varnothing 4,0 mm
hauteur nez de pose 75 mm

TT 55-D original POP

Handnietzange für Stahl-
Nieten bis \varnothing 3,2 mm
& Alu bis \varnothing 4,0 mm
Kopfhöhe 75 mm



0,5 kg

Fr. 52.50 netto
(WMTT550)

TT 55-D original POP

Pince à river pour rivets en
acier jusqu'à \varnothing 3,2 mm
et en alu \varnothing 4,0 mm
hauteur nez de pose 75 mm

K 25

Hebelnietgerät für
Alu-Nieten bis \varnothing 7,8 mm &
Stahl-Nieten bis \varnothing 6,4 mm



1,5 kg

Fr. 90.- netto
(W00K20)

K 25

Outil à river pour rivets alu
jusqu'à \varnothing 7,8 mm &
rivets acier jusqu'à \varnothing 6,4 mm

K 5 / 96

Expander-Nietgerät für
Alu-Nieten bis \varnothing 6,4 mm &
Stahl-Nieten \varnothing 4,8 mm



1,5 kg

Fr. 94.- netto
(W010064P)

K 5 / 96

Riveteuse à expansion
pour rivets alu \varnothing 6,4 mm &
rivets acier jusqu'à \varnothing 4,8 mm

HFT Fasteners AG

Bösch 37, CH-6331 Hünenberg
Telefon +41-41 780 70 01 Fax +41-41 780 73 49
Email: info@hft-fasteners.ch
Internet: www.hft-fasteners.ch



ISO 9001 Nr. 96-241-041

Pneumatische Nietpistolen

Riveteuses pneumatiques

RAC 210

Hydraulisch-pneumatische
Nietpistole mit Dornfänger
für

Alu-Nieten bis $\varnothing = 4,8$ mm

Stahl & Inox bis $\varnothing = 4,0$ mm



1,6 kg

Fr. 487.- netto
(WRAC210)

RAC 210

Pistolet à river oléopneumatique
avec récupération de mandrins
pour

rivets alu jusqu'à $\varnothing = 4,8$ mm

acier & inox " $\varnothing = 4,0$ mm

RAC 182

Hydraulisch-pneumatische
Nietpistole mit Dornfänger
für

Alu-Nieten bis $\varnothing = 6,4$ mm

Stahl & Inox bis $\varnothing = 4,8$ mm

Magna-Lok bis $\varnothing = 4,8$ mm



1,6 kg

Fr. 562.- netto
(WRAC18)

RAC 182

Pistolet à river oléopneumatique
avec récupération de mandrins
pour

rivets alu jusqu'à $\varnothing = 6,4$ mm

acier & inox " $\varnothing = 4,8$ mm

Magna-Lok " $\varnothing = 4,8$ mm

RAC 171

Hydraulisch-pneumatische
Nietpistole mit Dornfänger
für

Alu-Nieten bis $\varnothing = 7,8$ mm

Stahl & Inox bis $\varnothing = 6,4$ mm

Magna-Lok bis $\varnothing = 4,8$ & 6,4



2,9 kg

Fr. 778.- netto
(WRAC171)

RAC 171

Pistolet à river oléopneumatique
avec récupération de mandrins
pour

rivets alu jusqu'à $\varnothing = 7,8$ mm

acier & inox " $\varnothing = 6,4$ mm

Magna-Lok " $\varnothing = 4,8$ & 6,4

HFT Fasteners AG

Bösch 37, CH-6331 Hünenberg
Telefon +41-41 780 70 01 Fax +41-41 780 73 49
Email: info@hft-fasteners.ch
Internet: www.hft-fasteners.ch



ISO 9001 Nr. 96-241-041

Akku-Nietgeräte

Riveteuses accu

Akku Nietgerät für alle Nieten
bis $\varnothing = 5$ mm

- * **Gerätehub: 20 mm**
- * **Setzkraft: 8'000 N**
- * ausgewogene Schwerpunktlage
handgerechter Griff
- * Auffangbehälter für abgerissene
Nietdorne
- * sofort-Rückstellung in
Ausgangsposition
- * Akku: 14,4 V / 2,0 Ah Li-Ion
- * mit Schnell-Ladegerät Li-Ion

Accu Bird
2 kg



Riveteuse accu pour rivets
jusqu'à $\varnothing = 5$ mm

- * **levée de l'outil: 20 mm**
- * **force de pose: 8'000 N**
- * l'appareil est bien équilibré
en main
- * avec récupération des
Mandarins
- * retour immédiat à la
position de départ
- * accu: 14,4 V / 2,0 Ah Li-Ion
- * avec chargeur rapide Li-Ion

Nieter+Lader+Stahlkoffer+1 Akku
Komplett

Fr. **1069.-** net
(W1402500)

Riveteuse+chargeur+malette+1 accu
complet

zusätzlicher Akku 2,0 Ah

Fr. **179.-** net
(19.55088)

accu aditionel 2,0 Ah

zusätzlicher Schnell-Lader

Fr. **160.-** net
(W1402635)

chargeur rapide aditionel

Hochleistungs Akku-Nietgerät
für alle Nieten bis $\varnothing 6,4$ mm
(Alu bis $\varnothing 8$ mm)

- * der **grosse Bruder** des Accu Bird
- * **Gerätehub: 20 mm**
- * **Setzkraft: 13'000 N**
- * Akku: 14,4 V / 4,0 Ah Li-Ion
- * mit Schnell-Ladegerät Li-Ion

Power Bird



2,4 kg

Riveteuse accu à grande per-
formance, pour rivets jusqu'au
 $\varnothing 6,4$ mm (alu jusqu'à 8 mm)

- * le **grand frère** du Accu Bird
- * **levée de l'outjl: 20 mm**
- * **force de pose: 13'000 N**
- * accu: 14,4 V / 4,0 Ah Li-Ion
- * avec chargeur rapide Li-Ion

Nieter+Lader+Stahlkoffer+1 Akku
komplett

Fr. **1'286.-** net
(W1400136)

Riveteuse+chargeur+malette+1 accu
complet

zusätzlicher Akku 4,0 Ah

Fr. **256.50** net
(19.5509)

accu aditionel 4,0 Ah

HFT Fasteners AG

Bösch 37, CH-6331 Hünenberg
Telefon +41-41 780 70 01 Fax +41-41 780 73 49
Email: info@hft-fasteners.ch
Internet: www.hft-fasteners.ch



ISO 9001 Nr. 96-241-041

Nietmuttern-Geräte

Outils pour inserts filetés

KJ 21

Für Nietmuttern
**Alu & Stahl M3 - M8 und
Inox von M3 - M6**
inkl. Zugbolzen.
Im Kunststoffkoffer.



1,3 kg

Fr. 157.- netto
(WKJ021)

KJ 21

Pour écrous aveugles
**alu & acier M3 à M8 et inox
M3 à M6**
avec tirants.
Dans coffret plastique.

KJ 29 Extra

Für Nietmuttern in
**Alu, Stahl & Inox
von M3 - M10**
inkl. Zugbolzen.



2 kg

Fr. 277.- netto
(WKJ028)

KJ 29 Extra

Pour écrous aveugles
**alu, acier & inox
de M3 à M10**
avec tirants.

KJ 60

Pneumatisches Nietmuttern-
Werkzeug für
**Alu, Stahl & Inox
von M3 – M8**
inkl. Zugbolzen.
im Kunststoffkoffer.



2,2 kg

Fr. 1'324.- netto
(WKJ060)

KJ 60

Outil pneumatique
pour écrous aveugles
**alu, acier & inox
de M3 à M8**
avec tirants
Dans coffret plastique.

KJ 45/S

Pneumatisches Nietmuttern-
Werkzeug für
**Alu, Stahl & Inox
von M4 – M12**
inkl. Zugbolzen.
im Kunststoffkoffer.



2,9 kg

Fr. 1'933.- netto
(WKJ045)

KJ 45/S

Outil pneumatique
pour écrous aveugles
**alu, acier & inox
de M4 à M12**
avec tirants
Dans coffret plastique.

Q-Tool N12XL

AKKU- Nietmuttern-
Werkzeug für
**Alu, Stahl & Inox
von M3 – M12**
inkl. Zugbolzen. und 2 Akku
im Kunststoffkoffer.



2.1kg

Fr. 1'365.- netto
(W0503QN12XL)

Q-Tool N12XL

Outil **accu** pour écrous
aveugles
**alu, acier & inox
de M3 à M12**
avec tirants et 2 accu
Dans coffret plastique.

HFT Fasteners AG

Bösch 37, CH-6331 Hünenberg
 Telefon +41-41 780 70 01 Fax +41-41 780 73 49
 Email: info@hft-fasteners.ch
 Internet: www.hft-fasteners.ch



ISO 9001 Nr. 96-241-041

Nieten-Bohrer

rechts schneidend, extra kurz

HSS DIN 1897

Mèches pour rivets

coupure à droite, extra court

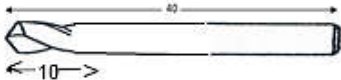
einseitig		1 côté
Ø mm	Art.	Fr.
3,3	B2334813	0.85 >50 0.75
4,1	B2411350	1.10
4,9	B2491350	1.10
5,1	B2511350	1.10

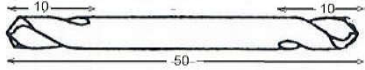
doppelseitig		2 côté
Ø mm	Art.	Fr.
3,3	B3331350	1.10 >50 0.85
4,1	B3411350	1.10
4,9	B3491350	1.70



Bohrer für in Inox

HSCO 5 UF-L 130°

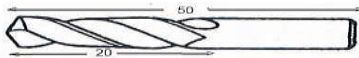
mèches pour inox

einseitig		1 côté
Ø mm	Art.	Fr.
3,3	B2334002	2.20
4,1	B218974D	3.-
4,9	B2189749	3.80

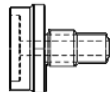
Mèches spéciales

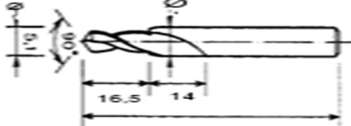
Dilatationsmundstück zu AccuBird für Alucobond Nietenkopf 16 mm Fr. 52.40 netto (1015549)		Buse dilatation pour AccuBird pour Alucobond tête rivet 16 mm Fr. 52.40 net (1015549)
Tiefenanschlag Fr. 30.- netto (18/8/18)		Butée de profondeur Fr. 30.- net (18/8/18)
Stufenbohrer-Pelicolor 5.1 x 8 mm oder 4,9 x 8 mm Fr. 50.20 netto (Z1061851)		Foret Pelicolor à étage 5.1 x 8 mm ou 4,9 x 8 mm Fr. 50.20 net (Z1061851)