

# BAHCO

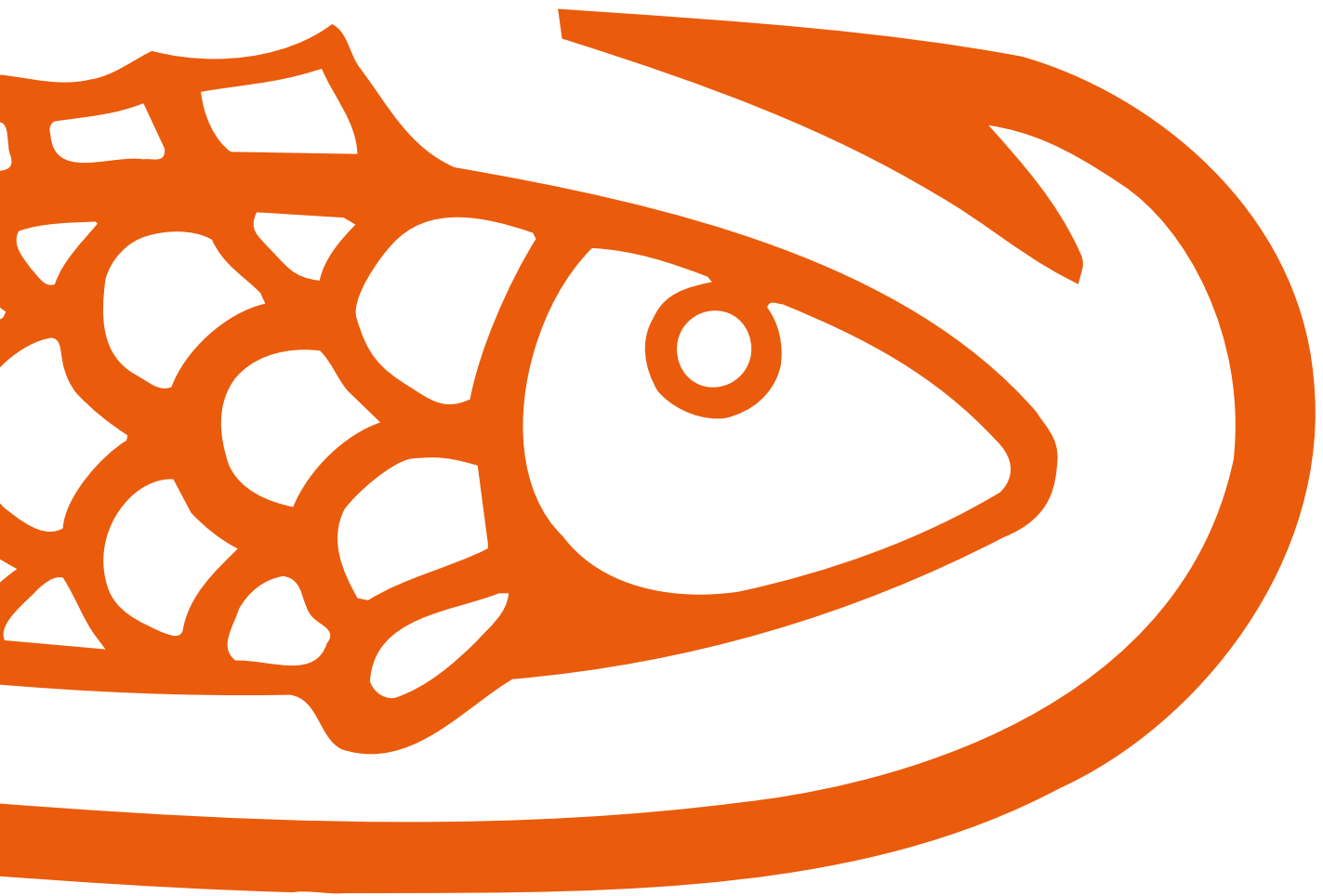

Catalogue **2021**



# Catalogue 2021

## Index

---

<b>Sommaire</b>	<b>2-9</b>
<b>Index alphanumérique</b>	<b>649-729</b>
<b>Garantie</b>	<b>735</b>

---

11-22 SCIES RUBAN ET SCIES ÉLECTRIQUES

23-38 LIMES



39-64 CLÉS



65-118 DOUILLES ET CLIQUETS



119-136 OUTILLAGE DYNAMOMÉTRIQUE



137-180 ACCESSOIRES POUR OUTILS ÉNERGISÉS

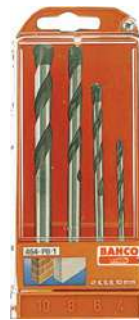

181-212 TOURNEVIS



213-222 CLÉS MÂLES



223-256 PINCES



257-264 SERRE-TUBES ET OUTILLAGE POUR TUBES



265-278 OUTILS PNEUMATIQUES



279-284 OUTILS ÉNERGISÉS SANS FILS





465-484 ÉQUIPEMENT DE SÉCURITÉ



485-500 OUTILS ISOLÉS



501-520 OUTILS ANTIDÉFLAGRANTS



521-526 OUTILS EN ACIER INOXYDABLE



527-534 BRUCELLES ET AUTRES OUTILS POUR L'ÉLECTRONIQUE 535-544 OUTILS DE MESURE

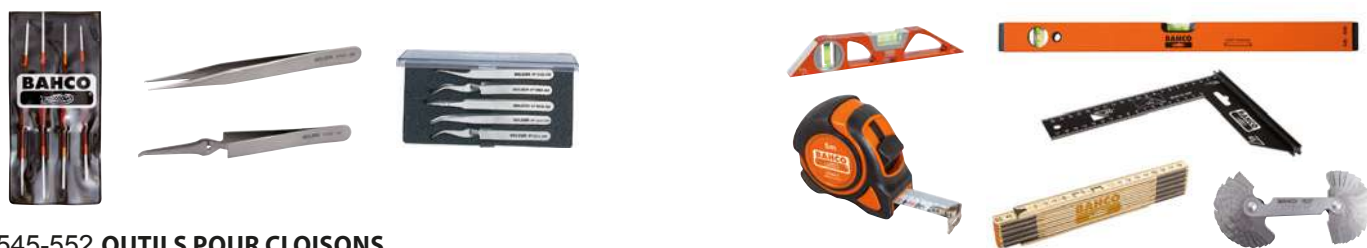

545-552 OUTILS POUR CLOISONS



553-556 SCIES À MÉTAUX MAINS

557-564 SCIES À MAIN



565-570 CISEAUX À BOIS



571-580 CISEAUX ET COUTEAUX



581-584 SERRE-JOINTS ET ÉTAUX



585-592 MARTEAUX



593-596 OUTILS POUR TRAVAUX FORESTIERS ET D'ABATTAGE D'ARBRES



597-604 BURINS ET POINÇONS



605-608 PIEDS DE BICHE



609-612 OUTILS DE PLANTATION ET DE CULTURE



613-630 OUTILS ARBORICOLES



631-634 OUTILS PNEUMATIQUES POUR L'EXTÉRIEUR



635-648 OUTILS DE PRÉCISION LINDSTRÖM





# Sommaire

<b>Scies ruban et scies électriques</b>	<b>11-22</b>	<b>Tournevis</b>	<b>181-212</b>
SCIES RUBAN BIMÉTAL POUR LA COUPE DE MÉTAUX	12	TOURNEVIS ERGO™ AVEC POIGNÉE EN CAOUTCHOUC RAINURÉE ET CODE COULEUR	182
SCIES RUBAN AU CARBURE POUR LA DÉCOUPE DE MÉTAUX	15	TOURNEVIS À LAME TRAVERSANTE	192
LAMES DE SCIES CIRCULAIRES HSS	17	TOURNEVIS BAHCOFIT AVEC POIGNÉE EN CAOUTCHOUC RAINURÉ	193
COUPE DU BOIS	18	TOURNEVIS AVEC POIGNÉE EN CAOUTCHOUC	200
ACCESSOIRES POUR SCIES RUBANS	19	TOURNEVIS À CLIQUET	203
LAMES DE SCIES MÉTAUX MACHINES	20	TOURNEVIS AVEC POIGNÉE DE PRÉCISION	205
		TOURNEVIS AVEC POIGNÉE DE MANCHE EN T	207
		CONTRÔLEURS DE TENSION	208
		TOURNEVIS AVEC PORTE-EMBOUT 1/4"	209
		TOURNEVIS AVEC POIGNÉES EN BOIS OU PLASTIQUE	210
		ACCESSOIRES	211
<b>Limes</b>	<b>23-38</b>		
LIMES DE MÉCANICIEN	24	<b>Clés mâles</b>	<b>213-222</b>
LIMES D'AFFÛTAGE	28	6 PANS	214
RÂPES	31	TORX*	218
LIMES DENTURE MEULÉE	32	DOUBLES COUDÉES	221
LIMES AIGUILLES	33	OUTILS MULTI-FONCTIONS	221
LIMES DIAMANTÉES	36		
ACCESSOIRES	36		
		<b>Pincés</b>	<b>223-256</b>
<b>Clés</b>	<b>39-64</b>	PINCES COUPANTES	224
CLÉS À MOLETTE	40	PINCES UNIVERSELLES	231
CLÉS MIXTES	42	PINCES DE PRÉHENSION	233
CLÉS À CLIQUET	47	PINCES MULTIPRISE	239
CLÉS À FOURCHE	51	PINCES À CIRCLIPS	241
CLÉS POLYGONALES	55	PINCES À DÉNUDER ET OUTILS DE DÉMONTAGE	243
CLÉS À TUYAUTER	57	PINCES À CRÉMAILLÈRE	246
CLÉS POLYGONALES	58	JEUX DE PINCES	248
CLÉS À PIPE	59	PINCES-ÉTAUX	250
CLÉS EN CROIX	62	PINCES À RIVETER	254
CLÉS À ERGOTS ARTICULÉES À CRANS	63	PINCES SPÉCIALES	255
		<b>Serre-tubes et outillage pour tubes</b>	<b>257-264</b>
<b>Douilles et cliquets</b>	<b>65-118</b>	CLÉS SERRE-TUBES	258
1/4"	66	OUTILS DE COUPE DE TUBES	260
3/8"	78	OUTILS DE CINTRAGE ET DE FORMAGE	262
1/2"	88	OUTILS D'ÉBAVURAGE	262
3/4"	101		
1"	105	<b>Outils pneumatiques</b>	<b>265-278</b>
DOUILLES À CHOC 1/4"	107	CLÉS À CHOCS	266
DOUILLES À CHOC 3/8"	107	CLIQUETS	268
DOUILLES À CHOC 1/2"	109	MEULEUSES, PONCEUSES ET POLISSEUSES	269
DOUILLES À CHOC 3/8"	113	PERCEUSES ET VISSEUSES	273
DOUILLES À CHOC 1"	115	OUTILS DE COUPE	274
DOUILLES À CHOC 1.1/2"	116	MARTEAUX, RIVETEUSES ET MARQUEURS	275
BOÎTES VIDES DE JEUX DE DOUILLES	118	PISTOLETS À PEINTURE	276
CLÉS SPÉCIAL ÉCHAFAUDAGE	118	OUTILS DE NETTOYAGE ET DE SOUFFLAGE	276
		ACCESSOIRES ET ÉQUIPEMENTS D'OUTILS PNEUMATIQUES	277
<b>Outillage dynamométrique</b>	<b>119-136</b>	<b>Outils énergisés sans fils</b>	<b>279-284</b>
CLÉS DYNAMOMÉTRIQUES ÉLECTRONIQUES	120	CLÉS À CHOCS	280
CLÉS DYNAMOMÉTRIQUES MÉCANIQUES	121	CLIQUETS	280
ADAPTATEURS COUPLE ET ANGLE	126	PERCEUSES ET VISSEUSES	281
TOURNEVIS DYNAMOMÉTRIQUES	127	MEULEUSES, PONCEUSES ET POLISSEUSES	282
TESTEURS DE COUPLE	129	OUTILS DE COUPE	282
EMBOUTS	129	GRAISSEURS	283
MULTIPLICATEURS	135	BATTERIES ET CHARGEURS	283
SOLUTIONS DE CONTRÔLE ANTI-ERREUR	136		
<b>Accessoires pour outils énergisés</b>	<b>137-180</b>		
SCIES TRÉPANS	138		
LAMES DE SCIES SABRES	147		
LAMES DE SCIES SAUTEUSES	150		
DISQUES ABRASIFS	150		
LAMES DE SCIES CIRCULAIRES	152		
LAMES DE SCIES RUBANS	153		
FRAISES LIMES	153		
MÈCHES ET FORETS	158		
EMBOUTS	165		



**Outils automobiles 285-346**

OUTILS POUR MOTEUR	286
OUTILS POUR ÉCHAPPEMENT	308
ÉQUIPEMENTS ET OUTILS POUR VIDANGE	309
OUTILS ET ÉQUIPEMENTS POUR SYSTÈME DE FREINAGE	315
OUTILS POUR ROUES ET TRANSMISSION	318
ÉQUIPEMENTS ET OUTILS POUR SUSPENSION	326
OUTILS ÉLECTRIQUES ET DE GESTION DE BATTERIE	327
PRESSES ET ACCESSOIRES	333
OUTILS ET ÉQUIPEMENTS AUTOMOBILE	333
OUTILS POUR CARROSSERIE	335
MATÉRIEL DE LEVAGE	341

**Éclairage 347-348**

ÉCLAIRAGE À MAIN	348
LAMPES FRONTALES	348
ENROULEURS	348

**Outils d'inspection 349-352**

ENDOSCOPES	350
STÉTHOSCOPIES	350
MIROIRS	350

**Extracteurs 353-362**

MÉCANIQUE	354
LEVIERS	360
780852_PICKING TOOLS	361
OUTILS DE FILETAGE	362

**Systèmes de rangement et kits d'outils 363-464**

SERVANTES	364
JEUX D'OUTILS MODULES MOUSSE FIT&GO	372
KITS D'OUTILS PAR APPLICATION	420
CAISSES RIGIDES	444
ÉTABLIS	450
ARMOIRES ET PANNEAUX	454
CAISSES À OUTILS MÉTALLIQUES	456
SACS TEXTILE ET CUIR	458
BOÎTES ET CAISSES EN PLASTIQUE	463
JEUX D'OUTILS	463

**Équipement de sécurité 465-484**

SYSTÈMES DE RANGEMENT ET LONGES	466
CLÉS	469
CLÉS SERRE-TUBES	471
DOUILLES ET CLIQUETS	471
TOURNEVIS	474
PINCES	476
OUTILS DE COUPE	478
MARTEAUX, LEVIERS ET BURINS	480
OUTILS DE MESURE	482
OUTILLAGE DYNAMOMÉTRIQUE	483
OUTILS DE SERRAGE	483
AUTRES OUTILS	483
GANTS	484

**Outils isolés 485-500**

TOURNEVIS	486
PINCES	492
CLÉS	495
DOUILLES ET CLIQUETS ISOLÉS	496

CISEAUX ET COUTEAUX	497
BRUCELLES	497
ÉQUIPEMENT DE SÉCURITÉ	497
JEUX D'OUTILS	498

**Outils antidéflagrants 501-520**

CLÉS	502
SERRE-TUBES ET OUTILLAGE POUR VALVES	506
DOUILLES ET CLIQUETS	507
TOURNEVIS	511
PINCES	512
MARTEAUX, LEVIERS ET BURINS	514
GRATTOIRS	517
GRANDS OUTILS ET OUTILS DE BALCON	518
EXTRACTEURS	519

**Outils en acier inoxydable 521-526**

SERVANTES D'ATELIER	522
CLÉS	522
DOUILLES ET CLIQUETS	523
TOURNEVIS	524
CLÉS MÂLES	524
EMBOUTS	525
PINCES	526
MARTEAUX	526
POINÇONS ET BURINS	526

**Brucelles et autres outils pour l'électronique 527-534**

BRUCELLES	528
OUTILS À SOUDER	532
MÉCANIQUE DE PRÉCISION	533

**Outils de mesure 535-544**

MÈTRES RUBAN	536
ODOMÈTRES	537
NIVEAUX À BULLE	537
MARQUAGE	539
RÈGLES	541
ÉQUERRES	541
MESURE DE PRÉCISION	542

**Outils pour cloisons 545-552**

GRATTOIRS	546
OUTILS DE MAÇON	548
OUTILS DE PLÂTRIER	549
OUTILS POUR PLAQUES DE PLÂTRE	550

**Scies à métaux mains 553-556**

MONTURES DE SCIES À MÉTAUX MAINS	554
LAMES DE SCIES MÉTAUX MAIN	555

**Scies à main 557-564**

SCIES À MAIN POUR MATÉRIEAUX DE CONSTRUCTION	558
SCIES À MAIN POUR BOIS	559
SCIES À MAIN DE PRÉCISION	562
MANCHES ET AFFÛTEURS	562
SCIES À CHANTOURNER ET LAMES DE SCIE	563
SCIES À CHANTOURNER ET LAMES DE SCIE	563
SCIES MUSICALES	563

<b>Ciseaux à bois</b>	<b>565-570</b>	<b>Outils pneumatiques pour l'extérieur</b>	<b>631-634</b>
BURINS POUR LE TRAVAIL DU BOIS	566	SÉCATEURS	632
GOUGES	568		
CISEAUX À BOIS POUR DÉMOLITION	568		
ACCESSOIRES POUR CISEAUX À BOIS	569		
<b>Ciseaux et couteaux</b>	<b>571-580</b>	<b>Outils de précision Lindström</b>	<b>635-648</b>
CISAILLES À TÔLE	572	PINCES POUR L'ÉLECTRONIQUE ET LA	636
CISEAUX	574	MÉCANIQUE DE PRÉCISION	
COUTEAUX	575	BRUCELLES POUR L'ÉLECTRONIQUE ET LA	639
		MÉCANIQUE DE PRÉCISION	
		TOURNEVIS DYNAMOMÉTRIQUES	647
<b>Serre-joints et étaux</b>	<b>581-584</b>		
SERRE-JOINTS	582		
ÉTAUX	583		
ACCESSOIRES POUR ÉTAUX	584		
<b>Marteaux</b>	<b>585-592</b>		
MARTEAUX DE COFFREUR	586		
ARRACHE-CLOUS	587		
MARTEAUX DE MÉCANICIEN	587		
MARTEAUX DE CONSTRUCTION	588		
MARTEAUX SPÉCIAUX	590		
MASSES	590		
MARTEAUX ET MAILLETS SOUPLES	591		
<b>Outils pour travaux forestiers et d'abattage d'arbres</b>	<b>593-596</b>		
HACHES, HACHETTES ET MASSES	594		
COINS	596		
<b>Burins et poinçons</b>	<b>597-604</b>		
BURINS	598		
BURINS GAINÉS	599		
BURINS À MANCHE BI-MATIÈRE	599		
BURINS, RÉAFFÛTABLES	599		
POINÇONS	600		
POINÇONS AVEC MANCHE BI-MATIÈRE	604		
<b>Pieds de biche</b>	<b>605-608</b>		
PINCES À DÉCOFFRER	606		
<b>Outils de plantation et de culture</b>	<b>609-612</b>		
PELLES	610		
BÊCHES	610		
FOURCHES	610		
RÂTEAUX	610		
PETITS OUTILS DE JARDIN	611		
<b>Outils arboricoles</b>	<b>613-630</b>		
SÉCATEURS	614		
OUTILS POUR LA CUEILLETTE DE FRUITS	618		
ÉBRANCHEURS	618		
SCIES SUR PERCHES ET ÉCHENILLOIRS	621		
CISAILLES À HAIES	624		
CISAILLES À GAZON	625		
COUTEAUX DE JARDIN	625		
CISEAUX	626		
SCIES À BÛCHES	626		
SCIES ARBORICOLES	627		
PIÈCES DÉTACHÉES ET ACCESSOIRES	629		
ACCESSOIRES ET MAINTENANCE	629		





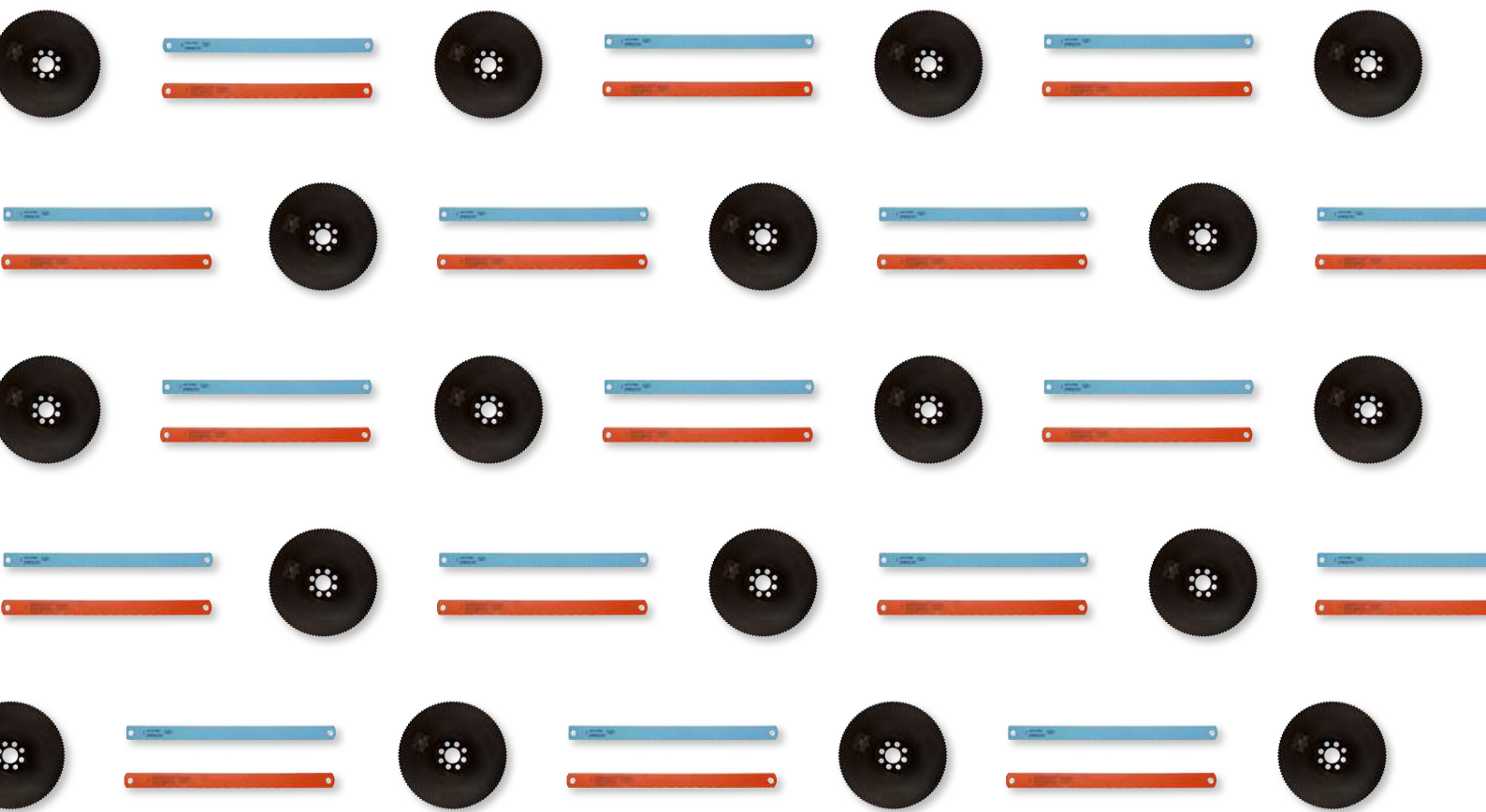

## Scies ruban et scies électriques



## SCIES RUBAN BIMÉTAL POUR LA COUPE DE METAUX

easy cut  
3857-Easy-cut







### 3857 Easy-Cut

			
13	EZ	1	3857-13-0.5-EZ-S
13	EZ	1	3857-13-0.6-EZ-S
13	EZ	1	3857-13-0.6-EZ-M
13	EZ	1	3857-13-0.6-EZ-L
20	EZ	1	3857-20-0.9-EZ-S
20	EZ	1	3857-20-0.9-EZ-M
20	EZ	1	3857-20-0.9-EZ-L
27	EZ	1	3857-27-0.9-EZ-S
27	EZ	1	3857-27-0.9-EZ-M
27	EZ	1	3857-27-0.9-EZ-L
34	EZ	1	3857-34-1.1-EZ-S
34	EZ	1	3857-34-1.1-EZ-M
34	EZ	1	3857-34-1.1-EZ-L





### Sandflex® Cobra™



### 3851 Contour and small machine

			
6	Hook	1	3851-6-0.6-H-6
13	Hook	1	3851-13-0.5-H-4
6	PRX	1	3851-6-0.6-10/14
6	Hook	1	3851-6-0.9-H-6
6	PRX	1	3851-6-0.9-10/14
10	Hook	1	3851-10-0.6-H-4

**BAHCO**



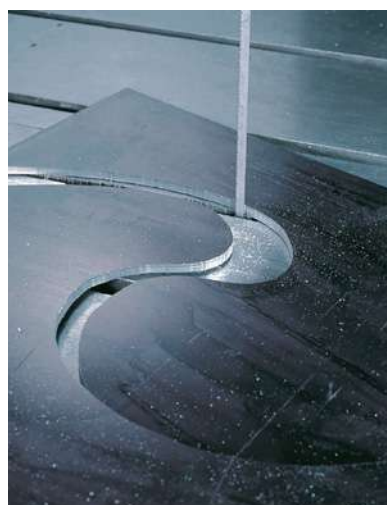

			
10	Hook	1	3851-10-0.6-H-6
10	PRX	1	3851-10-0.6-10/14
10	Hook	1	3851-10-0.9-H-4
10	Hook	1	3851-10-0.9-H-6
10	Regular	1	3851-10-0.9-R-14
10	PRX	1	3851-10-0.9-10/14
13	Regular	1	3851-13-0.5-R-10
13	PRX	1	3851-13-0.5-10/14
13	Regular	1	3851-13-0.5-R-14
13	PRX	1	3851-13-0.5-14/18
13	Regular	1	3851-13-0.5-R-18
13	Regular	1	3851-13-0.5-R-24
13	PRX	1	3851-13-0.6-5/8
13	PRX	1	3851-13-0.6-6/10
13	PRX	1	3851-13-0.6-8/12
13	PRX	1	3851-13-0.6-10/14
13	Hook	1	3851-13-0.6-H-3
13	Hook	1	3851-13-0.6-H-4
13	Hook	1	3851-13-0.6-H-6
13	Regular	1	3851-13-0.6-R-10
13	Regular	1	3851-13-0.6-R-14
13	Regular	1	3851-13-0.6-R-18
13	PRX	1	3851-13-0.6-10/14
13	PRX	1	3851-13-0.9-6/10
13	PRX	1	3851-13-0.9-10/14
13	Hook	1	3851-13-0.9-H-3
13	Hook	1	3851-13-0.9-H-4
13	Regular	1	3851-13-0.9-R-6
13	Hook	1	3851-13-0.9-H-6
13	Regular	1	3851-13-0.9-R-14
16	Hook	1	3851-16-0.5-H-3
20	H	1	3851-20-0.9-H-3
20	H	1	3851-20-0.9-H-4
20	R	1	3851-20-0.9-R-18
20	PRX	1	3851-20-0.9-4/6
20	PRX	1	3851-20-0.9-5/8
20	PRX	1	3851-20-0.9-6/10
20	PRX	1	3851-20-0.9-8/12
20	PRX	1	3851-20-0.9-10/14
27	PS	1	3851-27-0.9-P-3
27	PS	1	3851-27-0.9-P-4
27	Regular	1	3851-27-0.9-R-6





### Sandflex Cobra Foundry



### 3851 Sandflex® Cobra™ Foundry

			
10	Hook	1	3851-10-0.6-HA-4
13	HA	1	3851-13-0.6-HA-4

			
13	HA	1	3851-13-0.6-HA-6
13	HA	1	3851-13-0.9-HA-4
20	HA	1	3851-20-0.9-HA-3
20	Hook	1	3851-20-0.9-HA-4
27	HA	1	3851-27-0.9-HA-4
27	HA	1	3851-27-0.9-HA-3

			
67	PRX	1	3851-67-1.6-4/6
80	PRX	1	3851-80-1.6-7/1
80	PRX	1	3851-80-1.6-1/1.4
80	PRX	1	3851-80-1.6-1.4/2
80	PRX	1	3851-80-1.6-4/6
27	PRX	1	3851-27-0.9-10/14





**Sandflex® Cobra™**  
3851-Sandflex® Cobra™ PRX







**Scie à ruban King Cobra™**



**3851 Sandflex® Cobra™**

			
27	PRX	1	3851-27-0.9-2/3
27	PRX	1	3851-27-0.9-3/4
27	PRX	1	3851-27-0.9-4/6
27	PRX	1	3851-27-0.9-5/8
27	PRX	1	3851-27-0.9-6/10
27	PRX	1	3851-27-0.9-8/12
34	PRX	1	3851-34-1.1-2/3
34	PRX	1	3851-34-1.1-3/4
34	PRX	1	3851-34-1.1-4/6
34	PRX	1	3851-34-1.1-5/8
34	PRX	1	3851-34-1.1-6/10
41	PRX	1	3851-41-1.3-1.4/2
41	PRX	1	3851-41-1.3-2/3
41	PRX	1	3851-41-1.3-3/4
41	PRX	1	3851-41-1.3-4/6
41	PRX	1	3851-41-1.3-5/8
54	PRX	1	3851-54-1.3-1.4/2
54	PRX	1	3851-54-1.3-2/3
54	PRX	1	3851-54-1.3-4/6
54	PRX	1	3851-54-1.3-8/12
54	PRX	1	3851-54-1.6-1/1.4
54	PRX	1	3851-54-1.6-1.4/2
54	PRX	1	3851-54-1.6-2/3
54	PRX	1	3851-54-1.6-3/4
54	PRX	1	3851-54-1.6-4/6
67	PRX	1	3851-67-1.6-7/1
67	PRX	1	3851-67-1.6-1/1.4
67	PRX	1	3851-67-1.6-1.4/2
67	PRX	1	3851-67-1.6-2/3
67	PRX	1	3851-67-1.6-3/4

**3854-Sandflex® King Cobra™ PHX**





			
27	PHX	1	3854-27-0.9-PHX-2/3
27	PHX	1	3854-27-0.9-PHX-3/4
27	PHX	1	3854-27-0.9-PHX-4/6
34	PHX	1	3854-34-1.1-PHX-1.4/2
34	PHX	1	3854-34-1.1-PHX-2/3
34	PHX	1	3854-34-1.1-PHX-3/4
34	PHX	1	3854-34-1.1-PHX-4/6
41	PHX	1	3854-41-1.3-PHX-1.4/2
41	PHX	1	3854-41-1.3-PHX-2/3
41	PHX	1	3854-41-1.3-PHX-3/4
41	PHX	1	3854-41-1.3-PHX-4/6
54	PHX	1	3854-54-1.3-PHX-1.4/2
54	PHX	1	3854-54-1.3-PHX-2/3
54	PHX	1	3854-54-1.3-PHX-3/4
54	PHX	1	3854-54-1.6-PHX-7/1
54	PHX	1	3854-54-1.6-PHX-1/1.4
54	PHX	1	3854-54-1.6-PHX-1.4/2
54	PHX	1	3854-54-1.6-PHX-2/3
54	PHX	1	3854-54-1.6-PHX-3/4
67	PHX	1	3854-67-1.6-PHX-7/1
67	PHX	1	3854-67-1.6-PHX-1/1.4
67	PHX	1	3854-67-1.6-PHX-1.4/2
67	PHX	1	3854-67-1.6-PHX-2/3
80	PHX	1	3854-80-1.6-PHX-7/1
80	PHX	1	3854-80-1.6-PHX-1/1.4
80	PHX	1	3854-80-1.6-PHX-1.4/2



Sandflex® King Cobra™ PQ  
3854-Sandflex® King Cobra™ PQ



**3854-Sandflex® King Cobra™ PQ**





			
27	PQ	1	3854-27-0.9-PQ-3/4
27	PQ	1	3854-27-0.9-PQ-4/6
34	PQ	1	3854-34-1.1-PQ-2/3
34	PQ	1	3854-34-1.1-PQ-3/4
34	PQ	1	3854-34-1.1-PQ-4/6
41	PQ	1	3854-41-1.3-PQ-1.4/2
41	PQ	1	3854-41-1.3-PQ-2/3
41	PQ	1	3854-41-1.3-PQ-3/4
41	PQ	1	3854-41-1.3-PQ-4/6
54	PQ	1	3854-54-1.6-PQ-9/1.2
54	PQ	1	3854-54-1.6-PQ-1.4/2
54	PQ	1	3854-54-1.6-PQ-2/3
54	PQ	1	3854-54-1.6-PQ-3/4
54	PQ	1	3854-54-1.6-PQ-4/6
67	PQ	1	3854-67-1.6-PQ-9/1.2
67	PQ	1	3854-67-1.6-PQ-1.4/2
67	PQ	1	3854-67-1.6-PQ-2/3
67	PQ	1	3854-67-1.6-PQ-3/4
80	PQ	1	3854-80-1.6-PQ-9/1.2
80	PQ	1	3854-80-1.6-PQ-1.4/2
80	PQ	1	3854-80-1.6-PQ-2/3
80	PQ	1	3854-80-1.6-PQ-3/4
41	PQ	1	3858-41-1.3-PQ-1.4/2
41	PQ	1	3858-41-1.3-PQ-2/3
41	PQ	1	3858-41-1.3-PQ-3/4
54	PQ	1	3858-54-1.6-PQ-9/1.2
54	PQ	1	3858-54-1.6-PQ-1.4/2
54	PQ	1	3858-54-1.6-PQ-2/3
67	PQ	1	3858-67-1.6-PQ-9/1.2
67	PQ	1	3858-67-1.6-PQ-1.4/2
80	PQ	1	3858-80-1.6-PQ-9/1.2

Scie à ruban denture PHX



**3858 PHX P9000**





			
34	PHX	1	3858-34-1.1-PHX-1.4/2
34	PHX	1	3858-34-1.1-PHX-2/3

			
34	PHX	1	3858-34-1.1-PHX-3/4
41	PHX	1	3858-41-1.3-PHX-1.4/2
41	PHX	1	3858-41-1.3-PHX-2/3
41	PHX	1	3858-41-1.3-PHX-3/4
54	PHX	1	3858-54-1.3-PHX-1.4/2
54	PHX	1	3858-54-1.3-PHX-2/3
54	PHX	1	3858-54-1.3-PHX-3/4
54	PHX	1	3858-54-1.6-PHX-7/1
54	PHX	1	3858-54-1.6-PHX-1/1.4
54	PHX	1	3858-54-1.6-PHX-1.4/2
54	PHX	1	3858-54-1.6-PHX-2/3
54	PHX	1	3858-54-1.6-PHX-3/4
67	PHX	1	3858-67-1.6-PHX-7/1
67	PHX	1	3858-67-1.6-PHX-1/1.4
67	PHX	1	3858-67-1.6-PHX-1.4/2
67	PHX	1	3858-67-1.6-PHX-2/3
80	PHX	1	3858-80-1.6-PHX-7/1
80	PHX	1	3858-80-1.6-PHX-1/1.4
80	PHX	1	3858-80-1.6-PHX-1.4/2





Sandflex® Top Fabricator™ PF  
3853- Sandflex® Top Fabricator™ PF



**3853 Sandflex® Top Fabricator**

			
20	PF	1	3853-20-0.9-5/7-VS
20	PF	1	3853-20-0.9-8/11-VS
27	PF	1	3853-27-0.9-3/4
27	PF	1	3853-27-0.9-4/6
27	PF	1	3853-27-0.9-5/8
27	PF	1	3853-27-0.9-5/7-VS
27	PF	1	3853-27-0.9-8/11-VS
34	PF	1	3853-34-1.1-2/3
34	PF	1	3853-34-1.1-3/4
34	PF	1	3853-34-1.1-4/6
34	PF	1	3853-34-1.1-5/8
34	PF	1	3853-34-1.1-5/7-VS
34	PF	1	3853-34-1.1-8/11-VS
41	PF	1	3853-41-1.3-2/3
41	PF-W	1	3853-41-1.3-2/3-W
41	PF	1	3853-41-1.3-3/4
41	PF-W	1	3853-41-1.3-3/4-W
41	PF	1	3853-41-1.3-4/6
41	PF	1	3853-41-1.3-5/8
41	PF	1	3853-41-1.3-5/7-VS
54	PF	1	3853-54-1.3-3/4
54	PF	1	3853-54-1.3-3/4-W
54	PF	1	3853-54-1.3-5/8
54	PF	1	3853-54-1.6-2/3
54	PF-W	1	3853-54-1.6-2/3-W
54	PF	1	3853-54-1.6-3/4
54	PF	1	3853-54-1.6-3/4-W
54	PF	1	3853-54-1.6-4/6
67	PF	1	3853-67-1.6-2/3
67	PF-W	1	3853-67-1.6-2/3-W







			
67	PF	1	3853-67-1.6-3/4
67	PF-W	1	3853-67-1.6-3/4-W
67	PF-W	1	3853-67-1.6-5/8-W

### Scie à ruban Sandflex® Top Fabricator™



### 3853 Sandflex® Top Fabricator Superior





			
41	PF	1	3853-41-1.3-2/3-WS
41	PF	1	3853-41-1.3-3/4-WS
54	PF	1	3853-54-1.6-2/3-WS
54	PF	1	3853-54-1.6-3/4-WS
67	PF	1	3853-67-1.6-2/3-WS
67	PF	1	3853-67-1.6-3/4-WS





### SCIES RUBAN AU CARBURE POUR LA DECOUPE DE METAUX

### 3860- Ruban carbure non avoyé TMC



### 3860 Unset Carbide TMC





			
41	TMC	1	3860-41-1.3-TMC-1.4/2
41	TMC	1	3860-41-1.3-TMC-2/3
54	TMC	1	3860-54-1.3-TMC-1.4/2
54	TMC	1	3860-54-1.3-TMC-2/3
54	TMC	1	3860-54-1.6-TMC-.7/1
54	TMC	1	3860-54-1.6-TMC-1/1.25
54	TMC	1	3860-54-1.6-TMC-1.4/2
54	TMC	1	3860-54-1.6-TMC-2/3
67	TMC	1	3860-67-1.6-TMC-1/1.25
67	TMC	1	3860-67-1.6-TMC-1.4/2
67	TMC	1	3860-67-1.6-TMC-2/3
80	TMC	1	3860-80-1.1-TMC-1.4/2
80	TMC	1	3860-80-1.6-TMC-.7/1
80	TMC	1	3860-80-1.6-TMC-1/1.25

			
80	TMC	1	3860-80-1.6-TMC-1.4/2
80	TMC	1	3860-80-1.6-TMC-2/3
100	TMC	1	3860-100-1.1-TMC-1.4/2

### 3860-Ruban carbure non avoyé TCD







### 3860 Unset Carbide TCD

			
27	TCD	1	3860-27-0.9-TCD-3
27	TCD	1	3860-27-0.9-TCD-3/4
34	TCD	1	3860-34-1.1-TCD-2/3
34	TCD	1	3860-34-1.1-TCD-3/4
34	TCD	1	3860-34-1.1-TCD-3/4-W
41	TCD	1	3860-41-1.3-TCD-1.4/2
41	TCD	1	3860-41-1.3-TCD-1.9/2.1
41	TCD	1	3860-41-1.3-TCD-2/3
41	TCD	1	3860-41-1.3-TCD-3/4
54	TCD	1	3860-54-1.6-TCD-1.4/2
54	TCD	1	3860-54-1.6-TCD-1.9/2.1
54	TCD	1	3860-54-1.6-TCD-2/3
54	TCD	1	3860-54-1.6-TCD-3/4
67	TCD	1	3860-67-1.6-TCD-1.4/2
67	TCD	1	3860-67-1.6-TCD-1/1.25
80	TCD	1	3860-80-1.6-TCD-5/0.8

### 3860- Ruban carbure non avoyé TCZ



### 3860 Unset Carbide TCZ

			
27	TCZ	1	3860-27-0.9-TCZ-3/4
34	TCZ	1	3860-34-1.1-TCZ-2/3
34	TCZ	1	3860-34-1.1-TCZ-3/4
41	TCZ	1	3860-41-1.3-TCZ-2/3
41	TCZ	1	3860-41-1.3-TCZ-3/4



## 3860-Ruban carbure non avoyé TCA



### 3860 Unset Carbide TCA

Diagram	Symbol	Icon	Icon
27	TCA	1	3860-27-0.9-TCA-3
34	TCA	1	3860-34-1.1-TCA-0.8/1.0
34	TCA	1	3860-34-1.1-TCA-2
34	TCA	1	3860-34-1.1-TCA-2/3
34	TCA	1	3860-34-1.1-TCA-3
41	TCA	1	3860-41-1.3-TCA-1.4/2
41	TCA	1	3860-41-1.3-TCA-2/3
54	TCA	1	3860-54-1.6-TCA-1/1.25
54	TCA	1	3860-54-1.6-TCA-1.4/2

## Carbone Triple Set® "Xtra"™ 3868-Carbone Triple Set® TSX

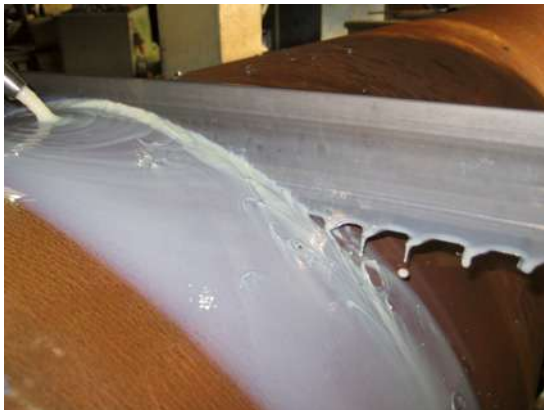

### 3868 Carbide Triple Set® TSX

Diagram	Symbol	Icon	Icon
27	TSX	1	3868-27-0.9-TSX-3/4
34	TSX	1	3868-34-1.1-TSX-2
34	TSX	1	3868-34-1.1-TSX-2/3
34	TSX	1	3868-34-1.1-TSX-3/4
41	TSX	1	3868-41-1.3-TSX-1.4/2
41	TSX	1	3868-41-1.3-TSX-1.6
41	TSX	1	3868-41-1.3-TSX-2
41	TSX	1	3868-41-1.3-TSX-2/3
41	TSX	1	3868-41-1.3-TSX-3/4
54	TSX	1	3868-54-1.3-TSX-1.4/2
54	TSX	1	3868-54-1.3-TSX-2/3
54	TSX	1	3868-54-1.6-TSX-1/1.25
54	TSX	1	3868-54-1.6-TSX-1.4/2
54	TSX	1	3868-54-1.6-TSX-1.6
54	TSX	1	3868-54-1.6-TSX-2/3
54	TSX	1	3868-54-1.6-TSX-3/4
67	TSX	1	3868-67-1.6-TSX-7/1

Diagram	Symbol	Icon	Icon
67	TSX	1	3868-67-1.6-TSX-1/1.25
67	TSX	1	3868-67-1.6-TSX-1.4/2
67	TSx	1	3868-67-1.6-TSX-2/3
80	TSX	1	3868-80-1.1-TSX-3/4
80	TSx	1	3868-80-1.6-TSX-7/1
80	TSX	1	3868-80-1.6-TSX-1/1.25
80	TSx	1	3868-80-1.6-TSX-2/3

## Carbone Triple Set® TSS 3868-Carbone Triple Set® TSS

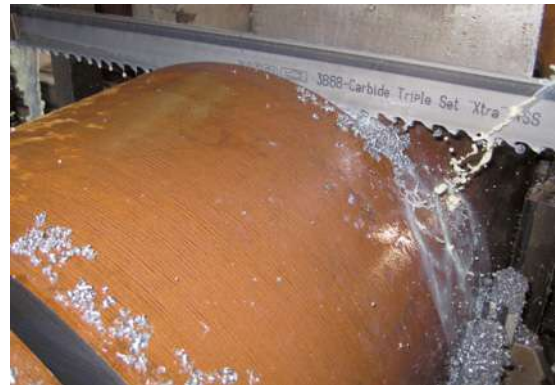

### 3868 Carbide Triple Set® TSS





Diagram	Symbol	Icon	Icon
34	TSS	1	3868-34-1.1-TSS-2/3
41	TSS	1	3868-41-1.3-TSS-1.4/2
41	TSS	1	3868-41-1.3-TSS-2/3
54	TSS	1	3868-54-1.6-TSS-1/1.25
54	TSS	1	3868-54-1.6-TSS-1.4/2
54	TSS	1	3868-54-1.6-TSS-2/3
67	TSS	1	3868-67-1.6-TSS-7/1
67	TSS	1	3868-67-1.6-TSS-1/1.25
67	TSS	1	3868-67-1.6-TSS-1.4/2
67	TSS	1	3868-67-1.6-TSS-2/3
80	TSS	1	3868-80-1.6-TSS-7/1
80	TSS	1	3868-80-1.6-TSS-1.4/2
80	TSS	1	3868-80-1.6-TSS-2/3

## 3881 THQ sciage de production de sections larges 3881-Carbone Multi Set® THQ



### 3881 Carbide Multi Set THQ



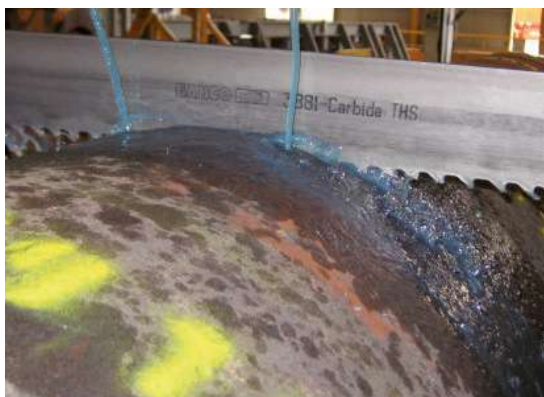

Diagram	Symbol	Icon	Icon
34	THQ	1	3881-34-1.1-THQ-2/3
41	THQ	1	3881-41-1.3-THQ-1.4/2
41	THQ	1	3881-41-1.3-THQ-2/3

			
54	THQ	1	3881-54-1.6-THQ-1.4/2
54	THQ	1	3881-54-1.6-THQ-2/3
67	THQ	1	3881-67-1.6-THQ-1/1.25
67	THQ	1	3881-67-1.6-THQ-1.4/2
67	THQ	1	3881-67-1.6-THQ-2/3
80	THQ	1	3881-80-1.6-THQ-.7/1
80	THQ	1	3881-80-1.6-THQ-1/1.25
80	THQ	1	3881-80-1.6-THQ-1.4/2
80	THQ	1	3881-80-1.6-THQ-2/3

3881 Carbone Multi Set® THS  
3881-Carbone Multi Set® THS



**3881 Carbide Multi Set THS**





			
41	THS	1	3881-41-1.3-THS-1.4/2
54	THS	1	3881-54-1.6-THS-1/1.25
54	THS	1	3881-54-1.6-THS-1.4/2
67	THS	1	3881-67-1.6-THS-1/1.25
67	THS	1	3881-67-1.6-THS-1.4/2
67	THS	1	3881-67-1.6-THS-2/3
80	THS	1	3881-80-1.6-THS-.7/1
80	THS	1	3881-80-1.6-THS-1.4/2
80	THS	1	3881-80-1.6-THS-2/3
100	THS	1	3881-100-1.6-THS-.7/1

Carbure Triple Set® TS  
3869 Carbure Triple Set® TS



**3869 Carbide Triple Set®**

			
13	TS	1	3869-13-0.9-TS-3
20	TS	1	3869-20-0.9-TS-3





			
20	TS	1	3869-20-0.9-TS-4
27	TS	1	3869-27-0.9-TS-3
27	TS	1	3869-27-0.9-TS-4
34	TS	1	3869-34-1.1-TS-2
34	TS	1	3869-34-1.1-TS-3

**LAMES DE SCIES CIRCULAIRES HSS**

Lame de scie circulaire HSS



**3815-32-1**

			
200	BW3	1	3815-200-2.0-32-1-03BW
200	BW4	1	3815-200-2.0-32-1-04BW
225	BW3	1	3815-225-2.0-32-1-03BW
225	BW4	1	3815-225-2.0-32-1-04BW
225	BW5	1	3815-225-2.0-32-1-05BW
225	C6	1	3815-225-2.0-32-1-06C
250	BW3	1	3815-250-2.0-32-1-03BW
250	BWS3	1	3815-250-2.0-32-1-03BWS
250	BW4	1	3815-250-2.0-32-1-04BW
250	BWS4	1	3815-250-2.0-32-1-04BWS
250	BW5	1	3815-250-2.0-32-1-05BW
250	C6	1	3815-250-2.0-32-1-06C
275	BW4	1	3815-275-2.5-32-1-04BW
275	BWS4	1	3815-275-2.5-32-1-04BWS
275	BW5	1	3815-275-2.5-32-1-05BW
275	C6	1	3815-275-2.5-32-1-06C
275	C8	1	3815-275-2.5-32-1-08C
300	BW4	1	3815-300-2.5-32-1-04BW
300	BW5	1	3815-300-2.5-32-1-05BW
300	C5	1	3815-300-2.5-32-1-05C
300	C6	1	3815-300-2.5-32-1-06C
300	C8	1	3815-300-2.5-32-1-08C
315	BW4	1	3815-315-2.5-32-1-04BW
315	BW5	1	3815-315-2.5-32-1-05BW
315	C6	1	3815-315-2.5-32-1-06C
315	C8	1	3815-315-2.5-32-1-08C
350	BW4	1	3815-350-2.5-32-1-04BW
350	C6	1	3815-350-2.5-32-1-06C

Alésage : 32-1



## Lame de scie circulaire HSS



### 3815-40-2

Ø	T		
250	BW3	1	3815-250-2,0-40-2-03BW
250	BW4	1	3815-250-2,0-40-2-04BW
250	BW5	1	3815-250-2,0-40-2-05BW
275	BW3	1	3815-275-2.5-40-2-03BW
275	BW4	1	3815-275-2.5-40-2-04BW
275	BW5	1	3815-275-2.5-40-2-05BW
275	C6	1	3815-275-2.5-40-2-06C
275	C8	1	3815-275-2.5-40-2-08C
315	BW4	1	3815-315-2.5-40-2-04BW
315	BW5	1	3815-315-2.5-40-2-05BW
315	C6	1	3815-315-3.0-40-2-06C

Alésage 40-2

## Lame de scie circulaire HSS



### 3815-50-4

Ø	T		
370	C8	1	3815-370-3.0-50-4-08C
370	C10	1	3815-370-3.0-50-4-10C
400	C10	1	3815-400-3.5-50-4-10C

alésage 50-4

## COUPE DU BOIS

### Lame bi-métal Sandcut®



### 3861 Sandcut Bi-metal

	T		
1.33	Hook	1	3861-27-0.9-H-1.33
1.15	Hook	1	3861-34-0.9-H-1.15
1.15	Hook	1	3861-34-1.1-H-1.15
1.15	Hook	1	3861-41-1.1-H-1.15
1.15	Hook	1	3861-54-1.1-H-1.15

### Lame Sandcut® Solid



### 3862 Sandcut Solid

	T		
1.15	Hook	1	3862-33-0.9-H-1.15
1.15	Hook	1	3862-33-1.1-H-1.15
1.15	Hook	1	3862-40-1.1-H-1.15

**ACCESSOIRES POUR SCIES RUBANS**

Brosse



**3870-BRUSH**

Ø	
60 mm	4 3870-BRUSH-60-6
80 mm	4 3870-BRUSH-80-6
80 mm	4 3870-BRUSH-80-8
80 mm	4 3870-BRUSH-80-10
100 mm	4 3870-BRUSH-100-10
100 mm	4 3870-BRUSH-100-12
100 mm	4 3870-BRUSH-100-10-HEX
100 mm	1 3870-BRUSH-100-13

Tachymètre



**3870-TACHO**

g	
400	1 3870-TACHO METER

Tensiomètre



**3870-TENSION**

g	
680	1 3870-TENSION METER

Réfractomètre



**3870-REFR**

g	
260	1 3870-REFRACTOMETER

Logiciel BandCalc™



**3870-CALC**

g	
45	1 3870-BANDCALC



Coin de calage, longueur 75mm



**3870-WEDGE**



60



1 3870-WEDGE-3

Roue de réglage de la tension pour scie à ruban



**3870-WHEEL**



0.7790 kg



1 3870-WHEEL

**LAMES DE SCIES MÉTAUX MACHINES**

Lames de scies métaux machines  
Sandflex® bimétal



**3809**



10  
14







300 mm  
300 mm



10 3809-300-25-1.25-10  
10 3809-300-25-1.25-14





6	300 mm	10	3809-300-32-1.60-6
10	300 mm	10	3809-300-32-1.60-10
6	350 mm	10	3809-350-25-1.25-6
10	350 mm	10	3809-350-25-1.25-10
14	350 mm	10	3809-350-25-1.25-14
4	350 mm	10	3809-350-32-1.60-4
6	350 mm	10	3809-350-32-1.60-6
8	350 mm	10	3809-350-32-1.60-8
10	350 mm	10	3809-350-32-1.60-10
14	350 mm	10	3809-350-32-1.60-14
4	350 mm	10	3809-350-32-2.00-4
6	350 mm	10	3809-350-32-2.00-6
10	350 mm	10	3809-350-32-2.00-10
6	350 mm	10	3809-350-38-2.00-6
10	350 mm	10	3809-350-38-2.00-10
10	400 mm	10	3809-400-25-1.25-10
4	400 mm	10	3809-400-32-1.60-4
6	400 mm	10	3809-400-32-1.60-6
8	400 mm	10	3809-400-32-1.60-8
10	400 mm	10	3809-400-32-1.60-10
14	400 mm	10	3809-400-32-1.60-14
4	400 mm	10	3809-400-32-2.00-4
6	400 mm	10	3809-400-32-2.00-6
8	400 mm	10	3809-400-32-2.00-8
10	400 mm	10	3809-400-32-2.00-10
4	400 mm	10	3809-400-38-2.00-4
6	400 mm	10	3809-400-38-2.00-6
10	400 mm	10	3809-400-38-2.00-10
6	425 mm	10	3809-425-32-1.60-6
10	425 mm	10	3809-425-32-1.60-10
4	450 mm	10	3809-450-32-1.60-4
6	450 mm	10	3809-450-32-1.60-6
10	450 mm	10	3809-450-32-1.60-10
14	450 mm	10	3809-450-32-1.60-14
4	450 mm	10	3809-450-32-2.00-4
6	450 mm	10	3809-450-32-2.00-6
10	450 mm	10	3809-450-32-2.00-10
4	450 mm	10	3809-450-38-2.00-4
6	450 mm	10	3809-450-38-2.00-6
8	450 mm	10	3809-450-38-2.00-8
10	450 mm	10	3809-450-38-2.00-10
4	450 mm	10	3809-450-45-2.25-4
6	450 mm	10	3809-450-45-2.25-6
6	475 mm	10	3809-475-45-2.25-6
4	500 mm	10	3809-500-38-2.00-4
6	500 mm	10	3809-500-38-2.00-6
10	500 mm	10	3809-500-38-2.00-10
4	500 mm	10	3809-500-45-2.25-4
6	500 mm	10	3809-500-45-2.25-6
4	500 mm	10	3809-500-50-2.50-4
6	500 mm	10	3809-500-50-2.50-6
8	500 mm	10	3809-500-50-2.50-8
6	525 mm	10	3809-525-38-2.00-6
10	525 mm	10	3809-525-38-2.00-10
4	525 mm	10	3809-525-45-2.25-4
6	525 mm	10	3809-525-45-2.25-6
4	550 mm	10	3809-550-45-2.25-4
6	550 mm	10	3809-550-45-2.25-6
4	550 mm	10	3809-550-50-2.50-4
6	550 mm	10	3809-550-50-2.50-6
4	575 mm	10	3809-575-45-2.25-4
3	575 mm	10	3809-575-50-2.50-3
4	575 mm	10	3809-575-50-2.50-4
6	575 mm	10	3809-575-50-2.50-6
6	600 mm	10	3809-600-38-2.00-6
4	600 mm	10	3809-600-45-2.25-4
6	600 mm	10	3809-600-45-2.25-6
3	600 mm	10	3809-600-50-2.50-3
4	600 mm	10	3809-600-50-2.50-4
6	600 mm	10	3809-600-50-2.50-6
4	650 mm	5	3809-650-50-2.50-4
6	650 mm	5	3809-650-50-2.50-6

			
4	700 mm	5	3809-700-50-2.50-4
6	700 mm	5	3809-700-50-2.50-6
4	750 mm	5	3809-750-50-2.50-4
6	750 mm	5	3809-750-50-2.50-6

## Sandflex® bimétal pour machines KASTO



### 3809 KA



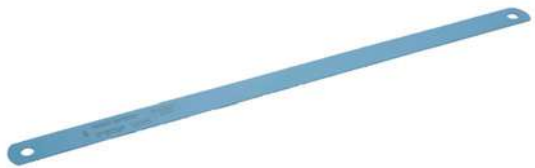

			
6	400 mm	10	3809-400-32-2.00-6-KA
4	450 mm	10	3809-450-38-2.00-4-KA
6	450 mm	10	3809-450-38-2.00-6-KA
10	450 mm	10	3809-450-38-2.00-10-KA
6	500 mm	10	3809-500-45-2.25-6-KA
4	500 mm	10	3809-500-50-2.50-4-KA
6	500 mm	10	3809-500-50-2.50-6-KA
4	550 mm	10	3809-550-50-2.50-4-KA
6	550 mm	10	3809-550-50-2.50-6-KA
3	575 mm	10	3809-575-50-2.50-3-KA
4	575 mm	10	3809-575-50-2.50-4-KA
6	575 mm	10	3809-575-50-2.50-6-KA
10	575 mm	10	3809-575-50-2.50-10-KA
4	600 mm	10	3809-600-50-2.50-4-KA
6	600 mm	10	3809-600-50-2.50-6-KA
3	650 mm	5	3809-650-50-2.50-3-KA
4	650 mm	5	3809-650-50-2.50-4-KA
6	650 mm	5	3809-650-50-2.50-6-KA
3	700 mm	5	3809-700-50-2.50-3-KA
4	700 mm	5	3809-700-50-2.50-4-KA
6	700 mm	5	3809-700-50-2.50-6-KA

## High speed Lames de scie métaux machines



### 3802

			
6	300 mm	10	3802-300-25-1.25-6
10	300 mm	10	3802-300-25-1.25-10



			
14	300 mm	10	3802-300-25-1.25-14
6	300 mm	10	3802-300-32-1.60-6
10	300 mm	10	3802-300-32-1.60-10
6	350 mm	10	3802-350-25-1.25-6
10	350 mm	10	3802-350-25-1.25-10
14	350 mm	10	3802-350-25-1.25-14
4	350 mm	10	3802-350-32-1.60-4
6	350 mm	10	3802-350-32-1.60-6
8	350 mm	10	3802-350-32-1.60-8
10	350 mm	10	3802-350-32-1.60-10
14	350 mm	10	3802-350-32-1.60-14
6	400 mm	10	3802-400-25-1.25-6
10	400 mm	10	3802-400-25-1.25-10
14	400 mm	10	3802-400-25-1.25-14
4	400 mm	10	3802-400-32-1.60-4
6	400 mm	10	3802-400-32-1.60-6
8	400 mm	10	3802-400-32-1.60-8
10	400 mm	10	3802-400-32-1.60-10
14	400 mm	10	3802-400-32-1.60-14
4	400 mm	10	3802-400-38-2.00-4
6	400 mm	10	3802-400-38-2.00-6
10	400 mm	10	3802-400-38-2.00-10
6	425 mm	10	3802-425-32-1.60-6
10	425 mm	10	3802-425-32-1.60-10
4	450 mm	10	3802-450-32-1.60-4
6	450 mm	10	3802-450-32-1.60-6
10	450 mm	10	3802-450-32-1.60-10
14	450 mm	10	3802-450-32-1.60-14
4	450 mm	10	3802-450-38-2.00-4
6	450 mm	10	3802-450-38-2.00-6
8	450 mm	10	3802-450-38-2.00-8
10	450 mm	10	3802-450-38-2.00-10
8	475 mm	10	3802-475-38-2.00-8
4	500 mm	10	3802-500-38-2.00-4
6	500 mm	10	3802-500-38-2.00-6
8	500 mm	10	3802-500-38-2.00-8
10	500 mm	10	3802-500-38-2.00-10
10	500 mm	10	3802-500-45-2.25-10
4	500 mm	10	3802-500-50-2.50-4
6	500 mm	10	3802-500-50-2.50-6
6	525 mm	10	3802-525-38-2.00-6
8	525 mm	10	3802-525-38-2.00-8
10	525 mm	10	3802-525-38-2.00-10
6	550 mm	10	3802-550-38-2.00-6
4	550 mm	10	3802-550-50-2.50-4
6	550 mm	10	3802-550-50-2.50-6
8	550 mm	5	3802-550-50-2.50-8
10	550 mm	10	3802-550-50-2.50-10
4	575 mm	10	3802-575-50-2.50-4
6	575 mm	10	3802-575-50-2.50-6
4	600 mm	10	3802-600-50-2.50-4
6	600 mm	10	3802-600-50-2.50-6
8	600 mm	10	3802-600-50-2.50-8
4	650 mm	5	3802-650-50-2.50-4
6	650 mm	5	3802-650-50-2.50-6
3	700 mm	5	3802-700-50-2.50-3
4	700 mm	5	3802-700-50-2.50-4
6	700 mm	5	3802-700-50-2.50-6
4	750 mm	5	3802-750-50-2.50-4
6	750 mm	5	3802-750-50-2.50-6



## High Speed pour machines KASTO HSS



### 3802 KA

			
4	450 mm	10	3802-450-38-2.00-4-KA
6	450 mm	10	3802-450-38-2.00-6-KA
8	450 mm	10	3802-450-38-2.00-8-KA
10	450 mm	10	3802-450-38-2.00-10-KA
4	500 mm	10	3802-500-50-2.50-4-KA
6	500 mm	10	3802-500-50-2.50-6-KA
4	550 mm	10	3802-550-50-2.50-4-KA
8	550 mm	10	3802-550-50-2.50-8-KA
3	575 mm	10	3802-575-50-2.50-3-KA
4	575 mm	10	3802-575-50-2.50-4-KA
6	575 mm	10	3802-575-50-2.50-6-KA
4	650 mm	5	3802-650-50-2.50-4-KA
6	650 mm	5	3802-650-50-2.50-6-KA
2	700 mm	5	3802-700-50-2.50-2-KA
4	700 mm	5	3802-700-50-2.50-4-KA
6	700 mm	5	3802-700-50-2.50-6-KA





# Limes



## LIMES DE MÉCANICIEN

Lime plate boîte industrielle, sans manche



### 1-100...-0

Longueur	Largeur	Nombre	Code
100	1	10	1-100-04-1-0
100	2	10	1-100-04-2-0
100	3	10	1-100-04-3-0
150	1	10	1-100-06-1-0
150	2	10	1-100-06-2-0
150	3	10	1-100-06-3-0
200	1	10	1-100-08-1-0
200	2	10	1-100-08-2-0
200	3	10	1-100-08-3-0
250	1	10	1-100-10-1-0
250	2	10	1-100-10-2-0
250	3	10	1-100-10-3-0
300	1	5	1-100-12-1-0
300	2	5	1-100-12-2-0
300	3	5	1-100-12-3-0
350	1	5	1-100-14-1-0
350	2	5	1-100-14-2-0

Lime plate manche Ergo™

ergo



### 1-100...-2

Longueur	Largeur	Nombre	Code
100	1	5	1-100-04-1-2
100	2	5	1-100-04-2-2
150	1	5	1-100-06-1-2
150	2	5	1-100-06-2-2
150	3	5	1-100-06-3-2
200	1	5	1-100-08-1-2
200	2	5	1-100-08-2-2
200	3	5	1-100-08-3-2
250	1	5	1-100-10-1-2
250	2	5	1-100-10-2-2
250	3	5	1-100-10-3-2
300	1	5	1-100-12-1-2
300	2	5	1-100-12-2-2
300	3	5	1-100-12-3-2

Lime pilier, boîte industrielle sans manche



### 1-102

Longueur	Largeur	Nombre	Code
150	2	10	1-102-06-2-0
150	3	10	1-102-06-3-0
200	1	10	1-102-08-1-0
200	2	10	1-102-08-2-0
200	3	10	1-102-08-3-0

Lime plate pour le tour, boîte industrielle sans manche



### 1-104

Longueur	Largeur	Nombre	Code
250	2	10	1-104-10-2-0
250	3	10	1-104-10-3-0
300	2	5	1-104-12-2-0
300	3	5	1-104-12-3-0
350	3	5	1-104-14-3-0

Lime plate "Oberg Cut", boîte industrielle sans manche



### 1-106...-0

Longueur	Largeur	Nombre	Code
200	1	10	1-106-08-1-0
250	1	10	1-106-10-1-0
300	1	5	1-106-12-1-0

Lime plate "Oberg Cut" manche Ergo™

ergo



### 1-106...-2

Longueur	Largeur	Nombre	Code
200	1	5	1-106-08-1-2
250	1	5	1-106-10-1-2
300	1	5	1-106-12-1-2

Lime plate pointue, boîte industrielle, sans manche



### 1-110...-0

Longueur	Largeur	Nombre	Code
100	1	10	1-110-04-1-0
100	2	10	1-110-04-2-0
100	2	10	1-110-04-3-0
150	1	10	1-110-06-1-0
150	2	10	1-110-06-2-0
150	3	10	1-110-06-3-0
200	1	10	1-110-08-1-0
200	2	10	1-110-08-2-0
200	2	10	1-110-08-3-0
250	1	10	1-110-10-1-0
250	2	10	1-110-10-2-0
250	3	10	1-110-10-3-0
300	1	5	1-110-12-1-0
300	2	5	1-110-12-2-0
300	3	5	1-110-12-3-0
350	1	5	1-110-14-1-0





Lime plate pointue manche Ergo™

ergo



### 1-110...-2

Longueur	Largeur	Nombre	Code
150	1	5	1-110-06-1-2
150	2	5	1-110-06-2-2
150	3	5	1-110-06-3-2
200	1	5	1-110-08-1-2
200	2	5	1-110-08-2-2

			
200	3	5	1-110-08-3-2
250	1	5	1-110-10-1-2
250	2	5	1-110-10-2-2
250	3	5	1-110-10-3-2
300	1	5	1-110-12-1-2
300	2	5	1-110-12-2-2
300	3	5	1-110-12-3-2

Lime plate pointue d'entrée mince, boîte industrielle, sans manche



### 1-111...-0

			
100	1	10	1-111-04-1-0
100	2	10	1-111-04-2-0
100	3	10	1-111-04-3-0
150	1	10	1-111-06-1-0
150	2	10	1-111-06-2-0
150	3	10	1-111-06-3-0
200	1	10	1-111-08-1-0
200	2	10	1-111-08-2-0

Lime plate pointue d'entrée mince manche Ergo™



### 1-111...-2

			
150	2	5	1-111-06-2-2

Lime contact, étui de 2







### 1-115

			
110	3	10	1-115-11-3-1

Lime plate pointue (modèle américain) boîte industrielle, sans manche







### 1-143...-0

			
100	1	10	1-143-04-1-0
150	1	10	1-143-06-1-0
200	1	10	1-143-08-1-0
250	1	10	1-143-10-1-0
300	1	5	1-143-12-1-0

Lime plate pointue (modèle américain) manche Ergo™







### 1-143...-2

			
150	1	5	1-143-06-1-2
200	1	5	1-143-08-1-2
250	1	5	1-143-10-1-2
300	1	5	1-143-12-1-2

Lime diagonale, avec manche Ergo™







### 1-320...-2

			
200	2	5	1-320-08-2-2
250	2	5	1-320-10-2-2
300	2	5	1-320-12-2-2

Lime diagonale, boîte industrielle, sans manche







### 1-320...-0

			
200	2	10	1-320-08-2-0
250	2	10	1-320-10-2-0
300	2	5	1-320-12-2-0

Lime mi-ronde, boîte industrielle, sans manche







### 1-210...-0

			
100	1	10	1-210-04-1-0
100	2	10	1-210-04-2-0
100	3	10	1-210-04-3-0
150	1	10	1-210-06-1-0
150	2	10	1-210-06-2-0
150	3	10	1-210-06-3-0
200	1	10	1-210-08-1-0
200	2	10	1-210-08-2-0
200	3	10	1-210-08-3-0
250	1	10	1-210-10-1-0
250	2	10	1-210-10-2-0
250	3	10	1-210-10-3-0
300	1	5	1-210-12-1-0
300	2	5	1-210-12-2-0
300	3	5	1-210-12-3-0
350	1	5	1-210-14-1-0

Lime mi-ronde, avec manche Ergo™  
Carte individuelle



### 1-210...-2

			
100	1	5	1-210-04-1-2
100	2	5	1-210-04-2-2
150	1	5	1-210-06-1-2
150	2	5	1-210-06-2-2
150	3	5	1-210-06-3-2
200	1	5	1-210-08-1-2
200	2	5	1-210-08-2-2
200	3	5	1-210-08-3-2



250	1	5	1-210-10-1-2	
250	2	5	1-210-10-2-2	
250	3	5	1-210-10-3-2	
300	1	5	1-210-12-1-2	
300	2	5	1-210-12-2-2	
300	3	5	1-210-12-3-2	

### Lime ronde, boîte industrielle, sans manche



### 1-230...-0

100	1	10	1-230-04-1-0	
100	2	10	1-230-04-2-0	
100	3	10	1-230-04-3-0	
150	1	10	1-230-06-1-0	
150	2	10	1-230-06-2-0	
150	3	10	1-230-06-3-0	
200	1	10	1-230-08-1-0	
200	2	10	1-230-08-2-0	
200	3	10	1-230-08-3-0	
250	1	10	1-230-10-1-0	
250	2	10	1-230-10-2-0	
250	3	10	1-230-10-3-0	
300	1	5	1-230-12-1-0	
300	2	5	1-230-12-2-0	
300	3	5	1-230-12-3-0	

### Lime ronde sur carte, avec manche Ergo™



### 1-230...-2

100	1	5	1-230-04-1-2	
100	2	5	1-230-04-2-2	
150	1	5	1-230-06-1-2	
150	2	5	1-230-06-2-2	
150	3	5	1-230-06-3-2	
200	1	5	1-230-08-1-2	
200	2	5	1-230-08-2-2	
200	3	5	1-230-08-3-2	
250	1	5	1-230-10-1-2	
250	2	5	1-230-10-2-2	
250	3	5	1-230-10-3-2	

300	1	5	1-230-12-1-2	
300	2	5	1-230-12-2-2	
300	3	5	1-230-12-3-2	

### Lime triangulaire, boîte industrielle, sans manche



### 1-170...-0

100	1	10	1-170-04-1-0	
100	2	10	1-170-04-2-0	
100	3	10	1-170-04-3-0	
150	1	10	1-170-06-1-0	
150	2	10	1-170-06-2-0	
150	3	10	1-170-06-3-0	
200	1	10	1-170-08-1-0	
200	2	10	1-170-08-2-0	
200	3	10	1-170-08-3-0	
250	1	10	1-170-10-1-0	
250	2	10	1-170-10-2-0	
250	3	10	1-170-10-3-0	
300	1	5	1-170-12-1-0	
300	2	5	1-170-12-2-0	

### Lime triangulaire, avec manche Ergo™



### 1-170...-2

100	2	5	1-170-04-2-2	
150	1	5	1-170-06-1-2	
150	2	5	1-170-06-2-2	
150	3	5	1-170-06-3-2	
200	1	5	1-170-08-1-2	
200	2	5	1-170-08-2-2	
200	3	5	1-170-08-3-2	
250	1	5	1-170-10-1-2	
250	2	5	1-170-10-2-2	
250	3	5	1-170-10-3-2	

### Lime carrée, boîte industrielle, sans manche



### 1-160...-0

100	1	10	1-160-04-1-0	
100	2	10	1-160-04-2-0	
100	3	10	1-160-04-3-0	
150	1	10	1-160-06-1-0	
150	2	10	1-160-06-2-0	
150	3	10	1-160-06-3-0	
200	1	10	1-160-08-1-0	
200	2	10	1-160-08-2-0	
200	3	10	1-160-08-3-0	
250	1	10	1-160-10-1-0	
250	2	10	1-160-10-2-0	
250	3	10	1-160-10-3-0	
300	1	5	1-160-12-1-0	
300	2	5	1-160-12-2-0	
300	3	5	1-160-12-3-0	

### Lime carrée manche Ergo™



### 1-160...-2

100	1	5	1-160-04-1-2	
100	2	5	1-160-04-2-2	
150	1	5	1-160-06-1-2	
150	2	5	1-160-06-2-2	
150	3	5	1-160-06-3-2	
200	1	5	1-160-08-1-2	
200	2	5	1-160-08-2-2	
200	3	5	1-160-08-3-2	
250	1	5	1-160-10-1-2	
250	2	5	1-160-10-2-2	
250	3	5	1-160-10-3-2	
300	1	5	1-160-12-1-2	
300	2	5	1-160-12-2-2	
300	3	5	1-160-12-3-2	

Jeu de 6 limes douces, manche Ergo™ 100mm

ergo®



**1-476-04-3-2**



100 3 1 1-476-04-3-2

Jeu de 3 limes mi-douces, manche Ergo™ 150mm

ergo®



**1-473-06-2-2**



150 2 5 1-473-06-2-2

1-230-06-2-2



1-210-06-2-2



1-100-06-2-2



Jeu de 3 limes mi-douces, manche Ergo™ 200mm  
Poignée ERGO™

ergo®



**1-473-08-2-2**



200 2 5 1-473-08-2-2

1-230-08-2-2



1-210-08-2-2



1-100-08-2-2



Jeu de 3 limes mi-douces, manche Ergo™ 250mm

ergo®



**1-473-10-2-2**

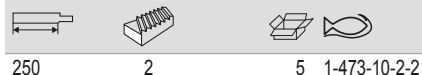

250 2 5 1-473-10-2-2

1-230-10-2-2



1-210-10-2-2



1-100-10-2-2



Jeu de 5 limes mi-douces, manche Ergo™ 200mm

ergo®



**1-477-08-2-2**

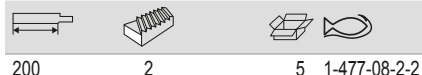

200 2 5 1-477-08-2-2

1-100-08-2-2



1-210-08-2-2



6-343-08-2-2



1-230-08-2-2



1-170-08-2-2



Jeu de 5 limes mi-douces, manche Ergo™ 250mm

ergo®



**1-477-10-2-2**



250 2 5 1-477-10-2-2

1-100-10-2-2



1-210-10-2-2



6-343-10-2-2

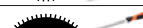

1-230-10-2-2

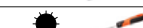

1-170-10-2-2



Jeu de 5 limes batardes et mi-douces, manche Ergo™ 200mm

ergo®



**1-478-08-1-2**



200 1&2 5 1-478-08-1-2

1-210-08-1-2



1-230-08-1-2



1-100-08-1-2, 1-100-08-2-2



1-160-08-1-2

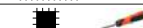

Jeu de 5 limes batardes et mi-douces, manche Ergo™ 250mm

ergo®



**1-478-10-1-2**

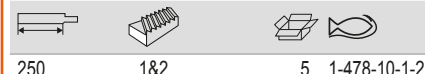

250 1&2 5 1-478-10-1-2

1-210-10-1-2



1-230-10-1-2

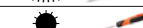

1-100-10-1-2, 1-100-10-2-2



1-160-10-1-2

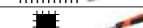

Jeu de 5 limes batardes, manche Ergo™ 200mm

ergo®



**1-479-08-1-2**

200	1	5	1-479-08-1-2

4-138-08-1-2				
1-210-08-1-2				
6-343-08-2-2				
1-230-08-1-2				
1-100-08-1-2				

Jeu de 5 limes mi-douces, manche Ergo™ 200mm

ergo®



**1-479-08-2-2**

200	2	5	1-479-08-2-2

4-138-08-1-2				
1-210-08-2-2				
6-343-08-2-2				
1-230-08-2-2				
1-100-08-2-2				

**LIMES D'AFFÛTAGE**

Lime plate pour chaîne de tronçonneuse  
Carte individuelle, avec manche Ergo™

ergo®



**166-2**

150	3	5	166-6-16-2.5-2

Lime plate pour chaîne de tronçonneuse, boîte industrielle sans manche



**166/167-12**

150	3	12	166-6-16-2.5-12
200	1	12	167-8-21-3.2-12

Lime pour chaîne de tronçonneuse, Emballage individuel



**168-1P**

150	3.2	12	168-6-3.2-1P
150	3.5	12	168-6-3.5-1P
200	4.0	12	168-8-4.0-1P
200	4.5	12	168-8-4.5-1P
200	4.8	12	168-8-4.8-1P
200	5.2	12	168-8-5.2-1P
200	5.5	12	168-8-5.5-1P
200	6.3	12	168-8-6.3-1P

Lime pour chaîne de tronçonneuse, Etui de 3 limes



**168-3P**

150	3.2	12	168-6-3.2-3P
150	3.5	12	168-6-3.5-3P
200	4.0	12	168-8-4.0-3P
200	4.5	12	168-8-4.5-3P
200	4.8	12	168-8-4.8-3P
200	5.2	12	168-8-5.2-3P
200	5.5	12	168-8-5.5-3P
200	6.3	12	168-8-6.3-3P

Lime pour chaîne de tronçonneuse, Boîte de 6 limes



**168-8**

200	4.0	6	168-8-4.0-6
200	4.5	6	168-8-4.5-6
200	4.8	6	168-8-4.8-6
200	5.2	6	168-8-5.2-6
200	5.5	6	168-8-5.5-6

Jeu de limes pour chaîne de tronçonneuse avec guide d'affûtage

ergo®



**168-C-G**

200	4.0	10	168-COMBI-4.0-6922
200	4.8	10	168-COMBI-4.8-6920
200	5.5	10	168-COMBI-5.5-6924

Jeu de limes pour chaîne de tronçonneuse

ergo®



**168-C**

200	4.0	10	168-COMBI-4.0
200	4.5	10	168-COMBI-4.5
200	4.8	10	168-COMBI-4.8
200	5.5	10	168-COMBI-5.5

Lime de scie plate batarde, boîte industrielle, sans manche



**4-138...-0**

150	1	10 4-138-06-1-0
200	1	10 4-138-08-1-0
250	1	10 4-138-10-1-0
300	1	5 4-138-12-1-0

Lime de scie plate batarde, manche Ergo™



**4-140...-2**

200	1	5 4-140-08-1-2
250	1	5 4-140-10-1-2

Lime de scie plate mi-douce, manche Ergo™



**4-144...-2**

200	2	5 4-144-08-2-2

Lime de scie plate batarde, manche Ergo™



**4-138...-2**

150	1	5 4-138-06-1-2
200	1	5 4-138-08-1-2
250	1	5 4-138-10-1-2
300	1	5 4-138-12-1-2

Lime de scie plate parallèle batarde, boîte industrielle, sans manche



**4-142**

150	1	10 4-142-06-1-0
200	1	10 4-142-08-1-0
250	1	10 4-142-10-1-0

Lime pour le bricolage, pour le bois, sur carte, manche Ergo™



**4-152**

200	2 & 2	5 4-152-08-2-2

Lime de scie plate batarde, boîte industrielle, sans manche



**4-140...-0**

150	1	10 4-140-06-1-0
200	1	10 4-140-08-1-0
250	1	10 4-140-10-1-0

Lime de scie plate parallèle mi-douce, boîte industrielle, sans manche



**4-144...-0**

200	2	10 4-144-08-2-0

Lime pour le bricolage, pour le métal, sur carte, manche Ergo™



**4-153**

200	1 & 1	5 4-153-08-1-2



Assortiment bricolage 4-152 + 4-153, sur carte  
Manche Ergo™

ergo®



**4-154**

Length	Teeth	Box	Card
200	1 & 2	10	4-154-08-2-2

Lime de jardin/polyvalente, boîte industrielle, sans manche



**4-155**

Length	Teeth	Box	Card
200	2	10	4-155-08-2-0
250	2	5	4-155-10-2-0

Lime d'affûtage, angles vifs, boîte industrielle, sans manche



**4-183...-0**

Length	Teeth	Box	Card
100	2	10	4-183-04-2-0
112	2	10	4-183-45-2-0
125	2	10	4-183-05-2-0
150	2	10	4-183-06-2-0
175	2	10	4-183-07-2-0
200	2	10	4-183-08-2-0
250	2	10	4-183-10-2-0

Lime d'affûtage, angles vifs, sur carte, avec manche Ergo™

ergo®



**4-183...-2**

Length	Teeth	Box	Card
100	2	5	4-183-04-2-2
125	2	5	4-183-05-2-2
150	2	5	4-183-06-2-2
175	2	5	4-183-07-2-2
200	2	5	4-183-08-2-2

Lime d'affûtage, angle vif mince, boîte industrielle sans manche



**4-186...-0**

Length	Teeth	Box	Card
100	2	10	4-186-04-2-0
112	2	10	4-186-45-2-0
125	2	10	4-186-05-2-0
150	2	10	4-186-06-2-0
175	2	10	4-186-07-2-0
200	2	10	4-186-08-2-0

Lime d'affûtage, angle vif, sur carte, mince avec manche Ergo™

ergo®



**4-186...-2**

Length	Teeth	Box	Card
100	2	5	4-186-04-2-2
125	2	5	4-186-05-2-2
150	2	5	4-186-06-2-2

Lime d'affûtage, angle vif très mince, boîte industrielle sans manche



**4-187...-0**

Length	Teeth	Box	Card
100	2	10	4-187-04-2-0
112	2	10	4-187-45-2-0
125	2	10	4-187-05-2-0
150	2	10	4-187-06-2-0
175	2	10	4-187-07-2-0

Lime d'affûtage, angle vif, très mince sur carte, avec manche Ergo™

ergo®



**4-187...-2**

Length	Teeth	Box	Card
125	2	5	4-187-05-2-2
150	2	5	4-187-06-2-2

Lime d'affûtage, angle vif extra mince, boîte industrielle sans manche



**4-188...-0**

Length	Teeth	Box	Card
125	2	10	4-188-05-2-0
150	2	10	4-188-06-2-0



Lime d'affûtage, angle vif, extra mince sur carte, avec manche

ergo®



**4-188...-2**

125	2	5	4-188-05-2-2

Tiers point, effilée régulière, boîte industrielle sans manche



**4-192...-0**

150	2	10	4-192-06-2-0
175	2	10	4-192-07-2-0
200	2	10	4-192-08-2-0

Lime à scie, pignon Wasa™, boîte industrielle sans manche



**4-272...-0**

150	3	10	4-272-06-3-0

Tiers point, extrémité effilée, boîte industrielle manche en bois



**4-190...-0**

150	2	10	4-190-06-2-0
175	2	10	4-190-07-2-0
200	2	10	4-190-08-2-0

Lime à ruban, effilée, régulière, sur carte, avec manche Ergo™

ergo®



**4-192...-2**

150	2	5	4-192-06-2-2
200	2	5	4-192-08-2-2

Lime à scie, pignon Wasa™, sur carte, manche Ergo™

ergo®



**4-272...-2**

125	3	5	4-272-05-3-2
150	3	5	4-272-06-3-2

Tiers point, doubles sur carte, avec manche Ergo™

ergo®



**4-190...-2**

150	2	5	4-190-06-2-2
175	2	5	4-190-07-2-2
200	2	5	4-190-08-2-2

Lime d'affûtage/Lime pour scie à ruban



**4-202-4-204**

216	2	10	4-202-85-2-0
216	2	10	4-203-85-2-0
216	2	10	4-204-85-2-0

**RÂPES**

Râpe plate, Carte individuelle, sans manche



**6-344...-0**

200	2	10	6-344-08-2-0
250	2	10	6-344-10-2-0



Râpe plate, carte individuelle, manche Ergo™

ergo®



**6-344...-2**

Length	Quantity	Quantity	Code
200	2	5	6-344-08-2-2
250	2	5	6-344-10-2-2

Râpe mi-ronde, boîte industrielle, sans manche



**6-342...-0**

Length	Quantity	Quantity	Code
150	2	10	6-342-06-2-0
200	1	10	6-342-08-1-0
200	2	10	6-342-08-2-0
250	1	10	6-342-10-1-0
250	2	10	6-342-10-2-0

Râpe mi-ronde, Carte individuelle, avec manche Ergo™

ergo®



**6-342...-2**

Length	Quantity	Quantity	Code
150	2	5	6-342-06-2-2
200	1	5	6-342-08-1-2
200	2	5	6-342-08-2-2
250	1	5	6-342-10-1-2
250	2	5	6-342-10-2-2

Râpe cabinette, boîte industrielle, sans manche



**6-343...-0**

Length	Quantity	Quantity	Code
200	2	10	6-343-08-2-0
200	3	10	6-343-08-3-0
250	2	10	6-343-10-2-0
250	3	10	6-343-10-3-0

Râpe cabinette, Carte individuelle, avec manche Ergo™

ergo®



**6-343...-2**

Length	Quantity	Quantity	Code
200	2	5	6-343-08-2-2
250	2	5	6-343-10-2-2

Râpe ronde, boîte industrielle, sans manche



**6-345...-0**

Length	Quantity	Quantity	Code
200	2	10	6-345-08-2-0
250	2	10	6-345-10-2-0

Râpe ronde, Carte individuelle, avec manche Ergo™

ergo®



**6-345...-2**

Length	Quantity	Quantity	Code
200	1	5	6-345-08-1-2
200	2	5	6-345-08-2-2
250	1	5	6-345-10-1-2

Jeu de 3 râpes pour menuiserie mi-douces, manche Ergo™ 200mm

ergo®



**6-470-08-2-2**

Length	Quantity	Quantity	Code
200	2	5	6-470-08-2-2

6-345-08-2-2

6-342-08-2-2

4-152-08-2-2

**LIMES DENTURE MEULÉE**

Lame plate Pansar®, boîte industrielle, sans manche



**3-330**

Length	Quantity	Quantity	Code
300	1	5	3-330-12-1-0
300	2	5	3-330-12-2-0
350	1	5	3-330-14-1-0
350	2	5	3-330-14-2-0

Lame mi-ronde Pansar®, boîte industrielle, sans manche



**3-331**

350	1	5	3-331-14-1-0

Lime plate "Master", manche Ergo™



**FM10**

300	4 & 5	5	FM12
250	4 & 5	5	FM10

Lime mi-ronde "Master", manche Ergo™



**HRFM10**

250	5	5	HRFM10

**LIMES AIGUILLES**

Lime plate, boîte industrielle, sans manche



**2-300**

140	0	10	2-300-14-0-0
140	2	10	2-300-14-2-0
140	4	10	2-300-14-4-0
160	0	10	2-300-16-0-0
160	1	10	2-300-16-1-0
160	2	10	2-300-16-2-0
160	4	10	2-300-16-4-0
180	0	10	2-300-18-0-0
180	2	10	2-300-18-2-0

Lime plate pointue, boîte industrielle, sans manche



**2-301**

140	0	10	2-301-14-0-0
140	2	10	2-301-14-2-0
160	0	10	2-301-16-0-0
160	1	10	2-301-16-1-0
160	2	10	2-301-16-2-0

Lime mi-ronde, boîte industrielle, sans manche



**2-304**

140	0	10	2-304-14-0-0
140	2	10	2-304-14-2-0
140	4	10	2-304-14-4-0
160	0	10	2-304-16-0-0
160	1	10	2-304-16-1-0
160	2	10	2-304-16-2-0
160	4	10	2-304-16-4-0
180	0	10	2-304-18-0-0
180	2	10	2-304-18-2-0

Lime mi-ronde, dos seul taillé, boîte industrielle, sans manche



**2-313**

160	0	10	2-313-16-0-0

Lime ronde, boîte industrielle, sans manche



**2-307**

140	0	10	2-307-14-0-0
140	2	10	2-307-14-2-0
140	4	10	2-307-14-4-0
160	0	10	2-307-16-0-0
160	1	10	2-307-16-1-0
160	2	10	2-307-16-2-0
160	4	10	2-307-16-4-0
180	0	10	2-307-18-0-0
180	2	10	2-307-18-2-0

Lime ovale, boîte industrielle, sans manche



**2-305**

160	1	10	2-305-16-1-0
160	2	10	2-305-16-2-0



Lime feuille de sauge, boîte industrielle, sans manche



**2-306**

Length	Teeth	Quantity	Part Number
160	1	10	2-306-16-1-0
160	2	10	2-306-16-2-0

Lime triangulaire, boîte industrielle, sans manche



**2-302**

Length	Teeth	Quantity	Part Number
140	0	10	2-302-14-0-0
140	2	10	2-302-14-2-0
140	4	10	2-302-14-4-0
160	0	10	2-302-16-0-0
160	1	10	2-302-16-1-0
160	2	10	2-302-16-2-0
160	4	10	2-302-16-4-0
180	0	10	2-302-18-0-0
180	2	10	2-302-18-2-0

Lime barrette, boîte industrielle, sans manche



**2-309**

Length	Teeth	Quantity	Part Number
160	2	10	2-309-16-2-0
160	4	10	2-309-16-4-0

Lime couteau, boîte industrielle, sans manche



**2-308**

Length	Teeth	Quantity	Part Number
140	2	10	2-308-14-2-0
160	0	10	2-308-16-0-0
160	1	10	2-308-16-1-0
160	2	10	2-308-16-2-0

Lime carrée, boîte industrielle, sans manche



**2-303**

Length	Teeth	Quantity	Part Number
140	2	10	2-303-14-2-0
160	0	10	2-303-16-0-0
160	1	10	2-303-16-1-0
160	2	10	2-303-16-2-0
160	4	10	2-303-16-4-0
180	0	10	2-303-18-0-0
180	2	10	2-303-18-2-0

Jeu de 6 limes aiguilles batardes



**2-470-14-0-0**

Length	Teeth	Quantity	Part Number
140	0	10	2-470-14-0-0

**9-488-02-10**

2-304-14-0-0	
2-300-14-0-0	
2-303-14-0-0	
2-302-14-0-0	
2-301-14-0-0	
2-307-14-0-0	

Jeu de 6 limes aiguilles douces



**2-470-14-2-0**

Length	Teeth	Quantity	Part Number
140	2	10	2-470-14-2-0

**9-488-02-10**

2-304-14-2-0	
2-300-14-2-0	
2-303-14-2-0	
2-302-14-2-0	
2-301-14-2-0	
2-307-14-2-0	

Jeu de 6 limes aiguilles très douces



**2-470-14-4-0**

Length	Teeth	Quantity	Part Number
140	4	10	2-470-14-4-0

**9-488-02-10**

2-304-14-4-0	
2-300-14-4-0	
2-303-14-4-0	
2-302-14-4-0	
2-301-14-4-0	
2-307-14-4-0	

Jeu de 6 limes aiguilles mi-douces



**2-470-16-1-0**



9-488-02-10	
2-304-16-1-0	
2-300-16-1-0	
2-303-16-1-0	
2-302-16-1-0	
2-301-16-1-0	
2-307-16-1-0	

Jeu de 6 limes aiguilles douces



**2-470-16-2-0**



9-488-02-10	
2-304-16-2-0	
2-300-16-2-0	
2-303-16-2-0	
2-302-16-2-0	
2-301-16-2-0	
2-307-16-2-0	

Jeu de 9 limes aiguilles mi-douces



**2-471-16-1-0**

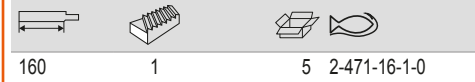

9-488-02-10	
2-303-16-1-0	
2-304-16-1-0	
2-302-16-1-0	
2-300-16-1-0	
2-308-16-1-0	
2-301-16-1-0	
2-306-16-1-0	
2-305-16-1-0	
2-307-16-1-0	

Jeu de 12 limes aiguilles batardes



**2-472-14-0-0**

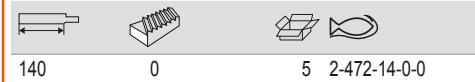

2-303-14-0-0	
2-300-14-0-0	
2-301-14-0-0	
2-304-14-0-0	
2-302-14-0-0	
2-313-14-0-0	
2-307-14-0-0	
2-309-14-0-0, 2-306-14-0-0	
9-488-02-10	

Jeu de 12 limes aiguilles douces



**2-472-14-2-0**



2-303-14-2-0	
2-300-14-2-0	
2-301-14-2-0	
2-304-14-2-0	
2-302-14-2-0	
2-313-14-2-0	
2-307-14-2-0	
2-306-14-2-0	
2-308-14-2-0	
9-488-02-10	

Jeu de 12 limes aiguilles batardes



**2-472-16-0-0**



2-303-16-0-0	
2-300-16-0-0	
2-301-16-0-0	
2-304-16-0-0	
2-302-16-0-0	
2-313-16-0-0	
2-307-16-0-0	
2-306-16-0-0	
2-308-16-0-0	
9-488-02-10	



Jeu de 12 limes aiguilles mi-douces



**2-472-16-1-0**

160	1	5	2-472-16-1-0

2-300-16-1-0	
2-301-16-1-0	
2-302-16-1-0	
2-303-16-1-0	
2-304-16-1-0	
2-306-16-1-0	
2-307-16-1-0	
2-308-16-1-0	
2-309-16-2-0	
2-313-16-2-0	
9-488-02-10	

Jeu de 12 limes aiguilles douces



**2-472-16-2-0**

160	2	5	2-472-16-2-0

2-303-16-2-0	
2-300-16-2-0	
2-301-16-2-0	
2-304-16-2-0	
2-302-16-2-0	
2-313-16-2-0	
2-307-16-2-0	
2-309-16-2-0	
2-306-16-2-0	
2-308-16-2-0	
9-488-02-10	

**LIMES DIAMANTÉES**

Lime aiguille diamantée



**2-300-D-2-304-D**

140	10	2-300-14-D-1P
160	10	2-300-16-D-1P
140	1	2-301-14-D-1P
140	10	2-302-14-D-1P
160	10	2-302-16-D-1P
140	10	2-303-14-D-1P
160	1	2-303-16-D-1P
140	10	2-304-14-D-1P
160	10	2-304-16-D-1P

Lime aiguille diamantée



**2-306-D-2-308-D**

140	1	2-306-14-D-1P
140	10	2-307-14-D-1P
160	10	2-307-16-D-1P
140	1	2-308-14-D-1P

Lime de précision diamantée



**5-600-D-5-670-D**

215	10	5-600-21-D-1P
215	1	5-610-21-D-1P
215	1	5-630-21-D-1P
215	1	5-670-21-D-1P

**ACCESSOIRES**

Support pour lame Pansar®



**9-462**

350	5 9-462-14-0-0

Support pour lame plate PANSAR®



**9-463**

300 & 350	1 9-463-14-0-0

Manche universel pour limes aiguilles



**9-488-02**

5	10 9-488-02-10

Manche de limes rondes pour chaîne de tronçonneuse



**PH-6604**

55	15	PH-6604-1P
50	25	PH-6604-25

Manche Ergo™ en plastique pour lime



**9-484...10**

3.2	3.2	10	9-484-3.2-10
5.2	5.2	10	9-484-5.2-10

Manche Ergo™ pour lime plate



**9-485...1P**

4	4 mm	10	9-485-04-1P
5	5 mm	10	9-485-05-1P
6	6	20	9-485-06-1P
9	9	20	9-485-09-1P
13	13	1	9-485-13-1P

Brosse pour lime, fil d'acier + cardé



**9-467**

130 mm	260	1	9-467-00-0-0

Manche Ergo™ en plastique pour lime



**9-484...1P**

3.2	3.2	10	9-484-3.2-1P
5.2	5.2	10	9-484-5.2-1P

Manche Ergo™ de limes rondes pour chaîne de tronçonneuse



**9-486-C-10**

3.2	3.2 mm	10	9-486-C-10

Cardé pour lime, fil d'acier



**9-469**

110 mm	240	1	9-469-00-0-0

Manche Ergo™ pour lime plate



**9-485...10**

4	4 mm	10	9-485-04-10
5	5 mm	10	9-485-05-10
6	6	10	9-485-06-10
9	9	10	9-485-09-10
13	13	10	9-485-13-10

Manche Ergo™ de limes rondes pour chaîne de tronçonneuse



**9-486-C-1P**

3.2	3.2 mm	10	9-486-C-1P





Manche Ergo™ pour autres limes

ergo®



**9-486...10**



			
4	4	10	9-486-04-10
5	5	10	9-486-05-10
7	7	10	9-486-07-10
8	8	10	9-486-08-10

Manche Ergo™ pour autres limes

ergo®



**9-486...1P**

			
4	4	10	9-486-04-1P
5	5	20	9-486-05-1P
7	7	20	9-486-07-1P





## Clés



## CLÉS À MOLETTE

Clé à molette phosphatée Ergo™  
Série P : mâchoire réversible

ergo®



### 90

L	Icon	Icon	Icon
158mm/6"	20	5	9070
208mm/8"	27	5	9071
257mm/10"	31	5	9072
308mm/12"	34	5	9073

Clé à molette poignée ERGO™, mâchoire réversible

ergo®



### 90P

L	Icon	Icon	Icon
158mm/6"	21	5	9070 P
208mm/8"	28	5	9071 P
257mm/10"	33	5	9072 P
308mm/12"	35	5	9073 P

Clé à molette chromée, Série P  
Mâchoire réversible

ergo®



### 90C

L	Icon	Icon	Icon
158mm/6"	20	5	9070C
208mm/8"	27	5	9071C
257mm/10"	31	5	9072 C
308mm/12"	34	3	9073 C

Clé à molette chromée poignée ERGO™, mâchoire réversible

ergo®



### 90PC

L	Icon	Icon	Icon
158mm/6"	21	5	9070 PC
208mm/8"	28	5	9071 PC
257mm/10"	33	5	9072 PC
308mm/12"	35	3	9073 PC

Clé à molette phosphatée, grande ouverture

ergo®



### 9029-9035

L	Icon	Icon	Icon
170mm/6"	32	5	9029
218mm/8"	38	5	9031
270mm/10"	46	5	9033
324mm/12"	55	5	9035

Clé à molette spéciale à grande ouverture

ergo®



### 9029C/9031C

L	Icon	Icon	Icon
170mm/6"	32	5	9029 C
218mm/8"	38	5	9031 C

Clé à molette, grande ouverture, mâchoires extra-fines

ergo®



### 9029-T/9031-T

L	Icon	Icon	Icon
170mm/6"	32	5	9029-T
218mm/8"	38	5	9031-T

Clé à molette, ouverture plus large et mâchoire réversible

ergo®



### 9031P

L	Icon	Icon	Icon
218mm/8"	39	5	9031P

Pack 9031 & 9029

ergo®



### ADJUST9031/29

g	Icon	Icon
550	3	ADJUST 9031/29

9029, 9031



Clé à molette phosphatée  
Série P : mâchoire réversible



**80**

L	Icon	Icon	Icon
110mm/4"	13	5	8069
155mm/6"	20	5	8070
205mm/8"	27	5	8071
255mm/10"	31	5	8072
305mm/12"	34	5	8073
380mm/15"	44	3	8074
455mm/18"	53	3	8075
110mm/4"	13	50	8069 IP
155mm/6"	20	40	8070 IP
205mm/8"	27	50	8071 IP
255mm/10"	31	30	8072 IP
305mm/12"	34	20	8073 IP
380mm/15"	44	20	8074 IP
455mm/18"	53	10	8075 IP

Clé à molette chromée, Série P  
mâchoire réversible



**80C**

L	Icon	Icon	Icon
110mm/4"	13	5	8069 C
155mm/6"	20	5	8070 C
205mm/8"	27	5	8071 C
255mm/10"	31	5	8072 C
305mm/12"	34	5	8073 C
380mm/15"	44	3	8074 C
455mm/18"	53	3	8075 C
110mm/4"	13	5	8069 C IP
155mm/6"	20	5	8070 C IP
205mm/8"	27	5	8071 C IP
255mm/10"	31	5	8072 C IP
305mm/12"	34	5	8073 C IP
380mm/15"	44	3	8074 C IP
455mm/18"	53	3	8075 C IP

Clé à molette grande taille phosphatée



**86/87**

L	Icon	Icon	Icon
614mm/24"	63	1	86
770mm/30"	85	3	87

Pièce de rechange pour clé à molette  
- 1 : mâchoire ; - 2 : molette, axe et ressort



**RPS**

Icon	Icon	Icon
8069, 8069 C	1	8069-1
8070, 8070 C, 9070, 9070 C	1	8070-1
8071, 8071 C, 9071, 9071 C	1	8071-1
8072, 8072 C, 9072, 9072 C	1	8072-1
8073, 8073 C, 9073, 9073 C	1	8073-1
8074, 8074 C	1	8074-1
8075, 8075 C	1	8075-1
9029, 9029 C, 31	1	9029-1
9029-T	1	9029T-1
9031, 9031 C	1	9031-1
9031-T	1	9031T-1
9033, 33H	1	9033-1
9035	1	9035-1
86	1	86-1
87	1	87-1
8069, 8069 C	1	8069-2
8070, 8070 C, 9070, 9070 C, 9070 P, 9070 PC	1	8070-2
8071, 8071 C, 9071, 9071 C, 9071 P, 9071 PC	1	8071-2
8072, 8072 C, 9072, 9072 C, 9072 P, 9072 PC	1	8072-2
8073, 8073 C, 9073, 9073 C, 9073 P, 9073 PC, 9033	1	8073-2
8074, 8074 C, 9035	1	8074-2
8075, 8075 C	1	8075-2
9029, 9029 C, 9029-T, 9031-T, 31, 9031, 9031 C, 9031P	1	9029-2
86	1	86-2
87	1	87-2
9031 P	1	9031 P-1
9070 P, 9070 PC	1	9070 P-1
9071 P, 9071 PC	1	9071 P-1
9072 P, 9072 PC	1	9072 P-1
9073 P, 9073 PC	1	9073 P-1

Clé à molette grandes tailles - Podger



**84**

L	Icon	Icon	Icon
405mm/16"	41	1	84-PODGER

Clé à molette idéale pour les tuyauteries



**31**

L	Icon	Icon	Icon
205mm/8"	32	5	31
205mm/8"	32	50	31 IP

Clé à molette avec crochet



**33H**

L	Icon	Icon	Icon
254mm/10"	46	5	33H



Clé à molette noire  
à usage industriel



**95**

L	mm	mm	mm	mm
257mm/10"	35	5	9572	
308mm/12"	39.5	5	9573	

Clé à molette chromée, usage industriel



**95C**

L	mm	mm	mm	mm
158mm/6"	20	5	9570C	

Clé à molette avec écrou latéral à usage industriel



**91C/97C**

L	mm	mm	mm	mm
155mm/6"	21	5	91C	
205mm/8"	29	5	92C	
255mm/10"	34	5	93C	
305mm/12"	39	5	94C	
405mm/16"	48	1	95C	
500mm/20"	60	1	96C	
750mm/30"	77	1	97C	

## CLÉS MIXTES

Clé mixte métrique



**111M**

mm	mm	mm	mm
5.5	10	111M-5.5	
6	10	111M-6	
7	10	111M-7	
8	10	111M-8	
9	10	111M-9	
10	10	111M-10	
11	10	111M-11	
12	10	111M-12	
13	10	111M-13	
14	10	111M-14	
15	10	111M-15	
16	10	111M-16	
17	10	111M-17	
18	10	111M-18	
19	10	111M-19	
20	10	111M-20	
21	10	111M-21	
22	5	111M-22	
23	5	111M-23	
24	5	111M-24	
25	5	111M-25	
26	5	111M-26	
27	5	111M-27	
28	5	111M-28	
29	5	111M-29	
30	5	111M-30	
32	5	111M-32	
33	5	111M-33	
34	5	111M-34	
36	1	111M-36	
38	1	111M-38	
41	1	111M-41	
46	1	111M-46	
50	1	111M-50	
55	1	111M-55	
60	1	111M-60	
65	1	111M-65	
70	1	111M-70	
75	1	111M-75	
80	1	111M-80	
85 mm	1	111M-85	
90 mm	1	111M-90	
95 mm	1	111M-95	
100 mm	1	111M-100	
5.5	1	SB111M-5,5	
6	1	SB111M-6	
7	1	SB111M-7	
8	1	SB111M-8	
9	1	SB111M-9	
10	1	SB111M-10	
11	1	SB111M-11	
12	1	SB111M-12	
13	1	SB111M-13	
14	1	SB111M-14	



15	1	SB111M-15
16	1	SB111M-16
17	1	SB111M-17
18	1	SB111M-18
19	1	SB111M-19
20	1	SB111M-20
21	1	SB111M-21
22	1	SB111M-22
23	1	SB111M-23
24	1	SB111M-24
25	1	SB111M-25
26	1	SB111M-26
27	1	SB111M-27
28	1	SB111M-28
29	1	SB111M-29
30	1	SB111M-30
32	1	SB111M-32

Clé mixte, en pouce





**111Z**

mm	mm	mm	mm
1/4	5	111Z-1/4	
5/16	5	111Z-5/16	
3/8	5	111Z-3/8	
7/16	5	111Z-7/16	
1/2	5	111Z-1/2	
9/16	5	111Z-9/16	
5/8	5	111Z-5/8	
11/16	5	111Z-11/16	
3/4	5	111Z-3/4	
13/16	5	111Z-13/16	
7/8	5	111Z-7/8	
15/16	3	111Z-15/16	
1	3	111Z-1	
1 1/16	5	111Z-1.1/16	
1 1/8	5	111Z-1.1/8	
1 1/4	5	111Z-1.1/4	
15/16	5	111Z-1.5/16	
13/8	1	111Z-1.3/8	
17/16	1	111Z-1.7/16	
1 1/2	1	111Z-1.1/2	
15/8	1	111Z-1.5/8	
1 11/16	1	111Z-1.11/16	
13/4	1	111Z-1.3/4	
1 13/16	1	111Z-1.13/16	
17/8	1	111Z-1.7/8	
2	1	111Z-2	
2 1/8	1	111Z-2.1/8	
2 1/4	1	111Z-2.1/4	
23/8	1	111Z-2.3/8	
2 1/2	1	111Z-2.1/2	
25/8	1	111Z-2.5/8	
23/4	1	111Z-2.3/4	
27/8	1	111Z-2.7/8	
3	1	111Z-3	

Clé mixte courte, pouce





**1Z**

  	
3/16 in	20 1Z-3/16
7/32 in	20 1Z-7/32
1/4 in	20 1Z-1/4
9/32 in	20 1Z-9/32
5/16 in	10 1Z-5/16
11/32 in	10 1Z-11/32
3/8 in	10 1Z-3/8
7/16 in	10 1Z-7/16
1/2 in	10 1Z-1/2
9/16 in	10 1Z-9/16
5/8 in	10 1Z-5/8
11/16 in	10 1Z-11/16
3/4 in	10 1Z-3/4
13/16 in	10 1Z-13/16
7/8 in	10 1Z-7/8
15/16 in	5 1Z-15/16
1 in	10 1Z-1

Clé mixte



**S20**

  	
6	1 SBS20-6
7	1 SBS20-7
8	1 SBS20-8
9	1 SBS20-9
10	1 SBS20-10
11	1 SBS20-11
12	1 SBS20-12
13	1 SBS20-13
14	1 SBS20-14
15	1 SBS20-15
16	1 SBS20-16
17	1 SBS20-17
18	1 SBS20-18
19	1 SBS20-19
20	1 SBS20-20
21	1 SBS20-21
22	1 SBS20-22
24	1 SBS20-24
27	1 SBS20-27
30	1 SBS20-30
32	1 SBS20-32

Jeu de 5 clés métriques mixtes



**111M/SH5**

  	
5	1 111M/SH5

111M-8, 111M-10, 111M-13, 111M-17, 111M-19

Jeu de 8 clés mixtes, métriques



**111M/SH8**

  	
8	1 111M/SH8

111M-8, 111M-10, 111M-12, 111M-13, 111M-14, 111M-17, 111M-19, 111M-22

Jeu de 12 clés mixtes, métriques



**111M/SH12**

  	
12	1 111M/SH12

111M-8, 111M-9, 111M-10, 111M-11, 111M-12, 111M-13, 111M-14, 111M-15, 111M-16, 111M-17, 111M-18, 111M-19

Jeu de clé mixte, métrique



**111M/S10**

  	
10	1 111M/S10

111M-8, 111M-9, 111M-10, 111M-11, 111M-12, 111M-13, 111M-14, 111M-17, 111M-19, 111M-22

Jeu de 11 clés mixtes, métriques



**111M/11T**

  	
11	1 111M/11T

111M-8, 111M-9, 111M-10, 111M-11, 111M-12, 111M-13, 111M-14, 111M-15, 111M-17, 111M-19, 111M-22



Jeu de 14 clés mixtes, métriques



**111M/14T**



14 1 111M/14T

111M-6, 111M-8, 111M-9, 111M-10, 111M-13, 111M-14, 111M-15, 111M-17, 111M-19, 111M-22, 111M-24, 111M-27, 111M-30, 111M-32

Jeu de 17 clés mixtes, métriques



**111M/17T**



17 1 111M/17T

111M-6, 111M-7, 111M-8, 111M-9, 111M-10, 111M-11, 111M-12, 111M-13, 111M-14, 111M-15, 111M-16, 111M-17, 111M-18, 111M-19, 111M-20, 111M-21, 111M-22

Jeu de 17 clés mixtes, métriques



**111M/17TL**

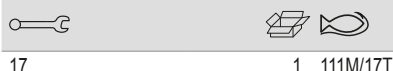

17 1 111M/17TL

111M-8, 111M-9, 111M-10, 111M-11, 111M-12, 111M-13, 111M-14, 111M-15, 111M-16, 111M-18, 111M-19, 111M-22, 111M-24, 111M-26, 111M-27, 111M-30, 111M-32

Jeu de 24 clés mixtes, métriques



**111M/24T**



24 1 111M/24T

111M-6, 111M-7, 111M-8, 111M-9, 111M-10, 111M-11, 111M-12, 111M-13, 111M-14, 111M-15, 111M-16, 111M-17, 111M-18, 111M-19, 111M-20, 111M-21, 111M-22, 111M-24, 111M-26, 111M-27, 111M-28, 111M-30, 111M-32, 111M-36

Jeu de 26 clés mixtes, métriques



**111M/26T**



26 1 111M/26T

111M-6, 111M-7, 111M-8, 111M-9, 111M-10, 111M-11, 111M-12, 111M-13, 111M-14, 111M-15, 111M-16, 111M-17, 111M-18, 111M-19, 111M-20, 111M-21, 111M-22, 111M-23, 111M-24, 111M-25, 111M-26, 111M-27, 111M-28, 111M-29, 111M-30, 111M-32

Jeu de clés mixtes, en pouce



**111Z/8T**



8 1 111Z/8T

111Z-3/8, 111Z-7/16, 111Z-1/2, 111Z-9/16, 111Z-5/8, 111Z-11/16, 111Z-3/4, 111Z-7/8

Jeu de 11 clés mixtes, en pouces



**111Z/11T**



11 1 111Z/11T

111Z-3/8, 111Z-7/16, 111Z-1/2, 111Z-9/16, 111Z-5/8, 111Z-11/16, 111Z-3/4, 111Z-13/16, 111Z-7/8, 111Z-15/16, 111Z-1

Jeu de 6 clés mixtes



**S20/SH6**



6 1 S20/SH6

SBS20-8, SBS20-10, SBS20-12, SBS20-13, SBS20-14, SBS20-17

Jeu de 12 clés mixtes



**S20/SH12**



12

1 S20/SH12

SBS20-8, SBS20-9, SBS20-10, SBS20-11, SBS20-12, SBS20-13, SBS20-14, SBS20-15, SBS20-16, SBS20-17, SBS20-18, SBS20-19



Jeu de 10 clés mixtes coudées, dimensions métriques



**BS20/S10**



10

1 BS20/S10

SBS20-8, SBS20-10, SBS20-11, SBS20-13, SBS20-14, SBS20-16, SBS20-17, SBS20-18, SBS20-19, SBS20-22



Clé mixte, série longue, métrique



**11M**



8	5	11M-8
9	5	11M-9
10	5	11M-10
11	5	11M-11
12	5	11M-12
13	5	11M-13
14	5	11M-14
15	5	11M-15
16	5	11M-16
17	5	11M-17
18	5	11M-18
19	5	11M-19
21	5	11M-21
22	5	11M-22
24	5	11M-24
27	1	11M-27
30	1	11M-30
32	1	11M-32
36	1	11M-36
38	1	11M-38



Jeu de clés mixtes, série longue, métrique



**11M/S8**



8

1 11M/S8

11M-8, 11M-9, 11M-10, 11M-11, 11M-13, 11M-14, 11M-17, 11M-19



Clé mixte, Liliput, métrique

Clé mixte longue  
Pouces



**11Z**



3/8 in	5	11Z-3/8
7/16 in	5	11Z-7/16
1/2 in	5	11Z-1/2
9/16 in	5	11Z-9/16
5/8 in	5	11Z-5/8
11/16 in	5	11Z-11/16
3/4 in	5	11Z-3/4
13/16 in	5	11Z-13/16
15/16 in	5	11Z-15/16
1 in	5	11Z-1



**4020L-M**



3	5	4020L-M-3
3.2	5	4020L-M-3.2
3.5	5	4020L-M-3.5
4	5	4020L-M-4
4.5	5	4020L-M-4.5
5	5	4020L-M-5
5.5	5	4020L-M-5.5



Clé mixte contre-coudée



**1952M**

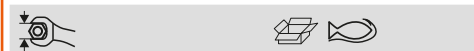

6	10	1952M-6
7	10	1952M-7
8	10	1952M-8
9	10	1952M-9
10	10	1952M-10
11	10	1952M-11
12	10	1952M-12
13	10	1952M-13
14	10	1952M-14
15	10	1952M-15
16	10	1952M-16
17	10	1952M-17
18	10	1952M-18
19	10	1952M-19
20	10	1952M-20
21	10	1952M-21
22	5	1952M-22
23	5	1952M-23
24	5	1952M-24
25	5	1952M-25
26	5	1952M-26
27	5	1952M-27
28	1	1952M-28
29	1	1952M-29
30	1	1952M-30
32	1	1952M-32
34	1	1952M-34
36	1	1952M-36
41	1	1952M-41
46	1	1952M-46
50	1	1952M-50
55	1	1952M-55
60	1	1952M-60
65	1	1952M-65
70	1	1952M-70
75	1	1952M-75
80	1	1952M-80
7	1	SB1952M-7
8	1	SB1952M-8
10	1	SB1952M-10
12	1	SB1952M-12
13	1	SB1952M-13
14	1	SB1952M-14
17	1	SB1952M-17
19	1	SB1952M-19
24	1	SB1952M-24

Clé mixte contre-coudée, en pouce



**1952Z**



1/4	5	1952Z-1/4
5/16	5	1952Z-5/16
11/32	5	1952Z-11/32
3/8	5	1952Z-3/8
7/16	5	1952Z-7/16
1/2	5	1952Z-1/2
9/16	5	1952Z-9/16
5/8	5	1952Z-5/8
11/16	5	1952Z-11/16
3/4	5	1952Z-3/4
13/16	5	1952Z-13/16
7/8	5	1952Z-7/8
15/16	5	1952Z-15/16
1	1	1952Z-1
1 1/16	1	1952Z-1.1/16
1 1/8	1	1952Z-1.1/8
1 1/4	1	1952Z-1.1/4
1 5/16	1	1952Z-1.5/16
1 3/8	1	1952Z-1.3/8
1 7/16	1	1952Z-1.7/16
1 1/2	1	1952Z-1.1/2
1 5/8	1	1952Z-1.5/8

Clé mixte, contre coudées, métrique



**PU**



6	5	PU-6
7	5	PU-7
8	5	PU-8
9	5	PU-9
10	5	PU-10
11	5	PU-11
12	5	PU-12
13	5	PU-13
14	5	PU-14
15	5	PU-15
16	5	PU-16
17	5	PU-17

18	5	PU-18
19	5	PU-19
20	3	PU-20
21	3	PU-21
22	3	PU-22
23	3	PU-23
24	3	PU-24
25	1	PU-25
26	1	PU-26
27	1	PU-27
28	1	PU-28
29	1	PU-29
30	1	PU-30
32	1	PU-32
36	1	PU-36
42	1	PU-42

Jeu de clé mixte, dimension métrique



**1952M/SH6**

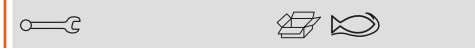

6	1	1952M/SH6
---	---	-----------

1952M-8, 1952M-10, 1952M-12, 1952M-13, 1952M-14, 1952M-17

Jeu de 12 clés mixtes, coudées, dimensions métriques



**1952M/SH12**

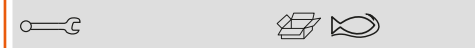

12	1	1952M/SH12
----	---	------------

1952M-8, 1952M-9, 1952M-10, 1952M-11, 1952M-12, 1952M-13, 1952M-14, 1952M-15, 1952M-16, 1952M-17, 1952M-18, 1952M-19



Jeu de clé mixte, métrique



**1952M/10**



10

1 1952M/10

1952M-8, 1952M-9, 1952M-10, 1952M-11, 1952M-12, 1952M-13, 1952M-14, 1952M-16, 1952M-17, 1952M-19



Jeu de 7 clés mixtes, coudées, dimensions métriques



**1952M/7T**



7

1 1952M/7T

1952M-8, 1952M-10, 1952M-13, 1952M-14, 1952M-17, 1952M-19, 1952M-22



Jeu de 14 clés mixtes, coudées, dimensions métriques



**1952M/14T**



14

1 1952M/14T

1952M-6, 1952M-8, 1952M-9, 1952M-10, 1952M-13, 1952M-14, 1952M-15, 1952M-17, 1952M-19, 1952M-22, 1952M-24, 1952M-27, 1952M-30, 1952M-32



Jeu de 17 clés mixtes, coudées



**1952M/17T**



17

1 1952M/17T

1952M-6, 1952M-7, 1952M-8, 1952M-9, 1952M-10, 1952M-11, 1952M-12, 1952M-13, 1952M-14, 1952M-15, 1952M-16, 1952M-17, 1952M-18, 1952M-19, 1952M-20, 1952M-21, 1952M-22



Jeu de 26 clés mixtes, coudées, dimensions métriques



**1952M/26T**



26

1 1952M/26T

1952M-6, 1952M-7, 1952M-8, 1952M-9, 1952M-10, 1952M-11, 1952M-12, 1952M-13, 1952M-14, 1952M-15, 1952M-16, 1952M-17, 1952M-18, 1952M-19, 1952M-20, 1952M-21, 1952M-22, 1952M-23, 1952M-24, 1952M-25, 1952M-26, 1952M-27, 1952M-28, 1952M-29, 1952M-30, 1952M-32



Jeu de clés mixtes contre-coudées



**1952Z/T**



11

1 1952Z/11T

1952Z-1/4, 1952Z-5/16, 1952Z-3/8, 1952Z-7/16, 1952Z-1/2, 1952Z-9/16, 1952Z-5/8, 1952Z-11/16, 1952Z-3/4, 1952Z-13/16, 1952Z-7/8



**CLÉS À CLIQUET**

Clé mixte à cliquet réversible



**1RM**



6

1 1RM-6

7

1 1RM-7

8

1 1RM-8

9

1 1RM-9

10

1 1RM-10

11

1 1RM-11

12

1 1RM-12

13

1 1RM-13

14

1 1RM-14

15

1 1RM-15

16

1 1RM-16

17

1 1RM-17

18

1 1RM-18

19

1 1RM-19

21

1 1RM-21

22

1 1RM-22

24

1 1RM-24

27

1 1RM-27

30

1 1RM-30

32

1 1RM-32



Clé mixte à cliquet réversible, pouce



**1RZ**

Dimensions	Quantité	Code
1/4 in	1	1RZ-1/4
5/16 in	1	1RZ-5/16
11/32 in	1	1RZ-11/32
3/8 in	1	1RZ-3/8
7/16 in	1	1RZ-7/16
1/2 in	1	1RZ-1/2
9/16 in	1	1RZ-9/16
5/8 in	1	1RZ-5/8
11/16 in	1	1RZ-11/16
3/4 in	1	1RZ-3/4
7/8 in	1	1RZ-7/8
15/16 in	1	1RZ-15/16

Clé mixte à cliquet métrique, version mini



**10RM**

Dimensions	Quantité	Code
8	1	10RM-8
10	1	10RM-10
13	1	10RM-13
14	1	10RM-14
17	1	10RM-17
19	1	10RM-19

Clé mixte à cliquet, version mini en pouces



**10RZ**

Dimensions	Quantité	Code
5/16 in	1	10RZ-5/16
3/8 in	1	10RZ-3/8
7/16 in	1	10RZ-7/16

Dimensions	Quantité	Code
1/2 in	1	10RZ-1/2
9/16 in	1	10RZ-9/16
5/8 in	1	10RZ-5/8
11/16 in	1	10RZ-11/16
3/4 in	1	10RZ-3/4

Clé mixte à cliquet réversible à tête articulée  
Dimensions métrique



**41RM**

Dimensions	Quantité	Code
8	1	41RM-8
10	1	41RM-10
11	1	41RM-11
12	1	41RM-12
13	1	41RM-13
14	1	41RM-14
17	1	41RM-17
19	1	41RM-19
21	1	41RM-21

Clé mixte à cliquet tête flexible blocable  
Pouces



**41RZ**

Dimensions	Quantité	Code
5/16 in	1	41RZ-5/16
3/8 in	1	41RZ-3/8
7/16 in	1	41RZ-7/16
1/2 in	1	41RZ-1/2
9/16 in	1	41RZ-9/16
5/8 in	1	41RZ-5/8
11/16 in	1	41RZ-11/16
3/4 in	1	41RZ-3/4
13/16 in	1	41RZ-13/16
7/8 in	1	41RZ-7/8

Jeu de 6 clés mixtes à cliquet réversible



**1RM/SH6**

Dimensions	Quantité	Code
6	1	1RM/SH6

1RM-8, 1RM-10, 1RM-12, 1RM-13, 1RM-14, 1RM-17

Jeu de 8 clés mixtes à cliquet réversible



**1RM/SH8**

Dimensions	Quantité	Code
8	1	1RM/SH8

1RM-8, 1RM-10, 1RM-11, 1RM-12, 1RM-13, 1RM-14, 1RM-17, 1RM-19

Jeu de 12 clés mixtes à cliquet réversible



**1RM/SH12**

Dimensions	Quantité	Code
12	10	1RM/SH12

1RM-8, 1RM-9, 1RM-10, 1RM-11, 1RM-12, 1RM-13, 1RM-14, 1RM-15, 1RM-16, 1RM-17, 1RM-18, 1RM-19

Jeu de 5 clés mixtes à cliquet réversible métriques



**1RM/S5**



5 10 1RM/S5

1RM-8, 1RM-10, 1RM-13, 1RM-17, 1RM-19



Jeu de clé mixte à cliquet réversible en pouces



**1RZ/SH8**



8 1 1RZ/SH8

1RZ-5/16, 1RZ-3/8, 1RZ-7/16, 1RZ-1/2, 1RZ-9/16, 1RZ-5/8, 1RZ-11/16, 1RZ-3/4



Jeu de clés mixtes à cliquet avec adaptateur 8 pièces



**1RMA/S8**



160 x 283 x 75 mm 1 1RMA/S8

1RMA-13-3/8-SQ, 1RMA-10-1/4-SQ, 1RMA-19-1/2-SQ  
1RMA-13-5/16-BIT, 1RMA-10-1/4-BIT  
1RM-13, 1RM-10, 1RM-19



Jeu de 6 clés mixtes à cliquet métrique, version 'mini'



**10RM/SH6**



6 1 10RM/SH6

10RM-8, 10RM-10, 10RM-13, 10RM-14, 10RM-17, 10RM-19



Jeu de 8 clés à cliquet réversible Dimensions métriques



**41RM/SH8**



8 10 41RM/SH8

41RM-8, 41RM-10, 41RM-11, 41RM-12, 41RM-13, 41RM-14, 41RM-17, 41RM-19



Coffret de clés à cliquets ajustables



**42RM/S12**



229 x 70 x 280 mm 1562 1 42RM/S12

Clé polygonale double à cliquet métrique



**1320RM**



6-7	1	1320RM-6-7
8-9	1	1320RM-8-9
10-11	1	1320RM-10-11
12-13	1	1320RM-12-13
14-15	1	1320RM-14-15
16-17	1	1320RM-16-17
17-19 mm	1	1320RM-17-19
18-19	1	1320RM-18-19
22-24	1	1320RM-22-24

Clé polygonale double à cliquet Pouces



**1320RZ**



1/4-5/16" in	1	1320RZ-1/4-5/16
3/8-7/16" in	1	1320RZ-3/8-7/16
1/2-9/16" in	1	1320RZ-1/2-9/16
5/8-11/16" in	1	1320RZ-5/8-11/16
3/4-13/16" in	1	1320RZ-3/4-13/16
3/4-7/8" in	1	1320RZ-3/4-7/8
7/8-15/16" in	1	1320RZ-7/8-15/16



Clé polygonale double à cliquet tête coudée  
Pouces



**1321RZ**

3/8-7/16 in	1	1321RZ-3/8-7/16
1/2-9/16 in	1	1321RZ-1/2-9/16
5/8-11/16 in	1	1321RZ-5/8-11/16
3/4x7/8 in	1	1321RZ-3/4-7/8

Clé double à cliquet type S



**1320SRM**

14-19	1	1320SRM-14-19

Jeu de 8 clés polygonales doubles à cliquet



**1320RM/SH8**

8	1	1320RM/SH8

1320RM-6-7, 1320RM-8-9, 1320RM-10-11, 1320RM-12-13, 1320RM-14-15, 1320RM-16-17, 1320RM-18-19, 1320RM-22-24

Jeu de 29 clés doubles à cliquet type S



**1320SRM/S29**

29	1	1320SRM/S29

1320SRM-14-19

1RMA-19-1/4-SQ

Clé polygonale à cliquet, 4 en 1



**S4RM**

4x5 6x7 mm	1	S4RM-4-7
8x9 10x11 mm	1	S4RM-8-11
12x13 14x15 mm	1	S4RM-12-15
16x17 18x19 mm	1	S4RM-16-19
20x21 24x27 mm	1	S4RM-21-27
30x32 34x36 mm	1	S4RM-30-36

Jeu de 3 clés polygonales à cliquet, 4 en 1



**S4RM/3T**

3	20	S4RM/3T

S4RM-8-11, S4RM-12-15, S4RM-16-19

Jeu de 4 clés polygonales à cliquet, 4 en 1



**S4RM/4T**

4	1	S4RM/4T

S4RM-8-11, S4RM-12-15, S4RM-16-19, S4RM-21-27

Jeu de 5 clés polygonales à cliquet, 4 en 1



**S4RM/5T**

5	1	S4RM/5T

S4RM-8-11, S4RM-12-15, S4RM-16-19, S4RM-21-27, S4RM-30-36

Adaptateur douille et embouts pour clés à cliquet



**1RMA-SQ**

1/4	10	1	1RMA-10-1/4-SQ	
3/8	13	1	1RMA-13-3/8-SQ	
1/2	19	1	1RMA-19-1/2-SQ	
1/4	19	1	1RMA-19-1/4-SQ	

Adaptateur embout pour clé à cliquet



**1RMA-BIT**

1/4	10	1	1RMA-10-1/4-BIT	
5/16	13	1	1RMA-13-5/16-BIT	
10	13	1	1RMA-13-10-BIT	

Jeu d'adaptateurs pour clé mixte à cliquet  
4 pièces



**1RMA/S4**

84 x 100 x 35 mm	1	1RMA/S4

1RMA-10-1/4-SQ, 1RMA-19-1/2-SQ	
1RMA-10-1/4-BIT	
1RMA-13-3/8-SQ	

**CLÉS À FOURCHE**

Clé à fourche double, métrique



**6M**

4x5	10	6M-4-5
4.5x5.5	10	6M-4.5-5.5
5x5.5	10	6M-5-5.5
5.5x7	10	6M-5.5-7
6x7	10	6M-6-7
7x8	10	6M-7-8
8x9	10	6M-8-9
8x10	10	6M-8-10
10x11	10	6M-10-11
10x13	10	6M-10-13
12x13	10	6M-12-13
12x14	10	6M-12-14
13x14	10	6M-13-14
13x15	10	6M-13-15
13x16	10	6M-13-16
13x17	10	6M-13-17
14x15	10	6M-14-15
14x17	10	6M-14-17
16x17	10	6M-16-17
16x18	10	6M-16-18
17x19	10	6M-17-19
18x19	10	6M-18-19
19x22	10	6M-19-22
19x24	10	6M-19-24
20x22	10	6M-20-22
21x23	10	6M-21-23
21x24	10	6M-21-24
22x24	10	6M-22-24
24x26	10	6M-24-26
24x27	10	6M-24-27
24x30	5	6M-24-30
25x28	5	6M-25-28
27x29	5	6M-27-29
27x30	5	6M-27-30
27x32	5	6M-27-32
30x32	5	6M-30-32
30x36	5	6M-30-36
32x36	5	6M-32-36
34x36	1	6M-34-36
36x41	1	6M-36-41
38x42	1	6M-38-42
41x46	1	6M-41-46
46x50	1	6M-46-50
4x5	1	SB6M-4-5
6x7	1	SB6M-6-7
8x9	1	SB6M-8-9
10x11	1	SB6M-10-11
12x13	1	SB6M-12-13
14x15	1	SB6M-14-15
16x17	1	SB6M-16-17
17x19	1	SB6M-17-19
18x19	1	SB6M-18-19
20x22	1	SB6M-20-22
21x23	1	SB6M-21-23
22x24	1	SB6M-22-24
24x26	1	SB6M-24-26
24x27	1	SB6M-24-27
25x28	1	SB6M-25-28

27x29	1	SB6M-27-29
30x32	1	SB6M-30-32

Clé à fourche double, en pouce



**6Z**

1/4x5/16	5	6Z-1/4-5/16
5/16x11/32	5	6Z-5/16-11/32
3/8x7/16	5	6Z-3/8-7/16
7/16x1/2	5	6Z-7/16-1/2
1/2x9/16	5	6Z-1/2-9/16
9/16x5/8	5	6Z-9/16-5/8
19/32x11/16	5	6Z-19/32-11/16
5/8x3/4	5	6Z-5/8-3/4
11/16x3/4	5	6Z-11/16-3/4
3/4x7/8	5	6Z-3/4-7/8
25/32x13/16	5	6Z-25/32-13/16
13/16x7/8	5	6Z-13/16-7/8
7/8x15/16	5	6Z-7/8-15/16
15/16x1	5	6Z-15/16-1
1x1 1/8	1	6Z-1-1.1/8
1 1/16x1 1/4	1	6Z-1.1/16-1.1/4
1 1/4x1 3/8	1	6Z-1.1/4-1.3/8

Clé à fourche double, Liliput



**1931M**

4	5	1931M-4
4.5	5	1931M-4.5
5	5	1931M-5
5.5	5	1931M-5.5
6	5	1931M-6
7	5	1931M-7
8	5	1931M-8
9	5	1931M-9
10	5	1931M-10
11	5	1931M-11
12	5	1931M-12
13	5	1931M-13
14	5	1931M-14
17	5	1931M-17



Clé à fourche double, Liliput



**1931Z**

Size	Length (mm)	Quantity	Part Number
1/8 in	74	5	1931Z-1/8
5/32	80	5	1931Z-5/32
3/16	80	5	1931Z-3/16
13/64	80	5	1931Z-13/64
7/32	80	5	1931Z-7/32
15/64x1/4 in	84	5	1931Z-15/64-1/4
1/4	80	5	1931Z-1/4
9/32	90	5	1931Z-9/32
9/32x5/16 in	94	5	1931Z-9/32-5/16
5/16	90	5	1931Z-5/16
11/32	105	5	1931Z-11/32
11/32x3/8 in	94	5	1931Z-11/32-3/8
3/8	105	5	1931Z-3/8
7/16	120	5	1931Z-7/16
1/2	120	5	1931Z-1/2
9/16	130	5	1931Z-9/16
5/8	130	5	1931Z-5/8

Clé à fourche double



**895M**

Size	Length (mm)	Quantity	Part Number
6x7	96	10	895M-6-7
8x9	109	10	895M-8-9
8x10	115	10	895M-8-10
10x11	124	10	895M-10-11
10x13	110	10	895M-10-13
13x17	155	10	895M-13-17
17x19	172	10	895M-17-19
19x22	195	10	895M-19-22
19x24	206	5	895M-19-24
22x24	220	5	895M-22-24
24x27	244	5	895M-24-27
24x30	265	5	895M-24-30
27x32	270	5	895M-27-32
30x32	275	5	895M-30-32
30x36	305	1	895M-30-36
32x36	307	1	895M-32-36
36x41	345	1	895M-36-41
41x46	381	1	895M-41-46
46x50	420	1	895M-46-50
50x55	460	1	895M-50-55
55x60	500	1	895M-55-60
65x70	580	1	895M-65-70

Jeu de clés à fourche doubles, métriques  
Support plastique



**6M/SH8**

Quantity	Part Number
8	6M/SH8

6M-6-7, 6M-8-9, 6M-10-11, 6M-12-13, 6M-14-15, 6M-16-17, 6M-18-19, 6M-20-22

Jeu de 12 clés à fourche doubles, métriques  
Support plastique



**6M/SH12**

Quantity	Part Number
12	6M/SH12

6M-6-7, 6M-8-9, 6M-10-11, 6M-12-13, 6M-14-15, 6M-16-17, 6M-18-19, 6M-20-22, 6M-21-23, 6M-24-26, 6M-25-28, 6M-30-32

Jeu de clé à fourche double, métrique  
Boîte en carton



**6M/S8**

Quantity	Part Number
8	6M/S8

6M-6-7, 6M-8-9, 6M-10-11, 6M-12-13, 6M-14-15, 6M-16-17, 6M-18-19, 6M-20-22

Jeu de clés à fourche doubles, métrique



**6M/6C**

Quantity	Part Number
6	6M/6C

6M-6-7, 6M-8-9, 6M-10-11, 6M-12-13, 6M-14-15, 6M-16-17

Jeu de 8 clés à fourche doubles



**6M/8C**

Quantity	Part Number
8	6M/8C

6M-6-7, 6M-8-9, 6M-10-11, 6M-12-13, 6M-14-15, 6M-16-17, 6M-18-19, 6M-20-22

Jeu de 10 clés à fourche doubles



**6M/10C**

Quantity	Part Number
10	6M/10C

6M-6-7, 6M-8-9, 6M-10-11, 6M-12-13, 6M-14-15, 6M-16-17, 6M-18-19, 6M-20-22, 6M-24-27, 6M-30-32

Jeu de 12 clés à fourche doubles



**6M/12C**



12

1 6M/12C

6M-6-7, 6M-8-9, 6M-10-11, 6M-12-13, 6M-14-15, 6M-16-17, 6M-18-19, 6M-20-22, 6M-21-23, 6M-24-27, 6M-25-28, 6M-30-32

Jeu de clés à fourche doubles, en pouce



**6Z/8C**



8

1 6Z/8C

6Z-1/4-5/16, 6Z-3/8-7/16, 6Z-5/16-11/32, 6Z-1/2-9/16, 6Z-19/32-11/16, 6Z-5/8-3/4, 6Z-13/16-7/8, 6Z-15/16-1

Jeu de 6 clés à fourche doubles



**S10/SH6**



6

1 S10/SH6

Jeu de 11 clés à fourche doubles, métriques



**S10/SH11**



11

1 S10/SH11

Jeu de clés à fourche doubles, Liliput



**1931M/10T**



10

1 1931M/10T

1931M-4, 1931M-4.5, 1931M-5, 1931M-5.5, 1931M-6, 1931M-7, 1931M-8, 1931M-9, 1931M-10, 1931M-11

Jeu de 12 clés à fourche doubles, Liliput



**1931Z/12T**



12

1 1931Z/12T

1931Z-5/32, 1931Z-9/32, 1931Z-5/16, 1931Z-11/32, 1931Z-3/8, 1931Z-3/16, 1931Z-7/32, 1931Z-1/4, 1931Z-7/16, 1931Z-1/2, 1931Z-5/8, 1931Z-9/16

Clé à fourche double, Electronique



**1933M/**



6

1 1933M/6T

Jeu de clés magnéto sur anneau



**3280M**



8

1 3280M

Clé à fourche crowfoot 1/4"



**-677**



7 mm	1/4 in	1 677-7
8 mm	1/4 in	1 677-8
9 mm	1/4 in	1 677-9
10 mm	1/4 in	1 677-10
13 mm	1/4 in	1 677-13
3/8 in	1/4 in	1 677-3/8



### Clé à fourche crowfoot 3/8"



#### -747

mm	in	1	747-10
10 mm	3/8 in	1	747-10
11 mm	3/8 in	1	747-11
12 mm	3/8 in	1	747-12
13 mm	3/8 in	1	747-13
14 mm	3/8 in	1	747-14
15 mm	3/8 in	1	747-15
16 mm	3/8 in	1	747-16
17 mm	3/8 in	1	747-17
18 mm	3/8 in	1	747-18
19 mm	3/8 in	1	747-19
20 mm	3/8 in	1	747-20
21 mm	3/8 in	1	747-21
22 mm	3/8 in	1	747-22
23 mm	3/8 in	1	747-23
24 mm	3/8 in	1	747-24
25 mm	3/8 in	1	747-25
26 mm	3/8 in	1	747-26
27 mm	3/8 in	1	747-27
28 mm	3/8 in	1	747-28
30 mm	3/8 in	1	747-30
32 mm	3/8 in	1	747-32
34 mm	3/8 in	1	747-34
36 mm	3/8 in	1	747-36
40 mm	3/8 in	1	747-40
41 mm	3/8 in	1	747-41
42 mm	3/8 in	1	747-42
46 mm	3/8 in	1	747-46
50 mm	3/8 in	1	747-50
3/8 in	3/8 in	1	747-3/8
7/16 in	3/8 in	1	747-7/16
1/2 in	3/8 in	1	747-1/2
9/16 in	3/8 in	1	747-9/16
5/8 in	3/8 in	1	747-5/8
11/16 in	3/8 in	1	747-11/16
3/4 in	3/8 in	1	747-3/4
13/16 in	3/8 in	1	747-13/16
7/8 in	3/8 in	1	747-7/8
15/16 in	3/8 in	1	747-15/16
1 in	3/8 in	1	747-1
1.1/16 in	3/8 in	1	747-1.1/16
1.1/8 in	3/8 in	1	747-1.1/8
1.3/16 in	3/8 in	1	747-1.3/16
1.1/4 in	3/8 in	1	747-1.1/4
1.5/16 in	3/8 in	1	747-1.5/16
1.3/8 in	3/8 in	1	747-1.3/8
1.7/16 in	3/8 in	1	747-1.7/16
1.1/2 in	3/8 in	1	747-1.1/2
1.9/16 in	3/8 in	1	747-1.9/16
1.5/8 in	3/8 in	1	747-1.5/8
1.11/16 in	3/8 in	1	747-1.11/16
1.3/4 in	3/8 in	1	747-1.3/4
1.13/16 in	3/8 in	1	747-1.13/16
1.7/8 in	3/8 in	1	747-1.7/8
1.15/16 in	3/8 in	1	747-1.15/16
2 in	3/8 in	1	747-2
2.1/16 in	3/8 in	1	747-2.1/16
2.1/8 in	3/8 in	1	747-2.1/8
2.3/16 in	3/8 in	1	747-2.3/16

mm	in	1	747-10
2.1/4 in	3/8 in	1	747-2.1/4
2.5/16 in	3/8 in	1	747-2.5/16
2.3/8 in	3/8 in	1	747-2.3/8
2.7/16 in	3/8 in	1	747-2.7/16
2.1/2 in	3/8 in	1	747-2.1/2
2.9/16 in	3/8 in	1	747-2.9/16
2.5/8 in	3/8 in	1	747-2.5/8
2.3/4 in	3/8 in	1	747-2.3/4
2.7/8 in	3/8 in	1	747-2.7/8

### Clé à fourche crowfoot 1/2"



#### -787

mm	in	1	787-10
1.1/16 in	1/2 in	1	787-1.1/16
1.1/8 in	1/2 in	1	787-1.1/8
1.3/16 in	1/2 in	1	787-1.3/16
1.1/4 in	1/2 in	1	787-1.1/4
1.5/16 in	1/2 in	1	787-1.5/16
1.3/8 in	1/2 in	1	787-1.3/8
1.7/16 in	1/2 in	1	787-1.7/16
1.1/2 in	1/2 in	1	787-1.1/2
1.5/8 in	1/2 in	1	787-1.5/8
1.11/16 in	1/2 in	1	787-1.11/16
1.3/4 in	1/2 in	1	787-1.3/4
1.13/16 in	1/2 in	1	787-1.13/16
1.7/8 in	1/2 in	1	787-1.7/8
2 in	1/2 in	1	787-2
2.1/8 in	1/2 in	1	787-2.1/8
2.3/16 in	1/2 in	1	787-2.3/16
2.1/4 in	1/2 in	1	787-2.1/4
2.3/8 in	1/2 in	1	787-2.3/8

### Clé à fourche simple



#### 894M

mm	in	10	894M-7
7	78	10	894M-7
8	94	10	894M-8
9	100	10	894M-9
10	106	10	894M-10

mm	in	10	894M-11
11	112	10	894M-11
12	125	10	894M-12
13	125	10	894M-13
14	140	10	894M-14
15	140	10	894M-15
16	140	10	894M-16
17	158	10	894M-17
19	171	10	894M-19
21	195	5	894M-21
22	195	5	894M-22
24	216	5	894M-24
27	240	5	894M-27
30	262	5	894M-30
32	274	5	894M-32
34	274	1	894M-34
36	303	5	894M-36
38	305	1	894M-38
41	343	1	894M-41
46	378	1	894M-46
50	413	1	894M-50
55	457	1	894M-55
60	492	1	894M-60
65	528	1	894M-65
70	573	1	894M-70
75	608	1	894M-75
80	644	1	894M-80
85	690	1	894M-85
90	690	1	894M-90
95	850	1	894M-95
100	1000	1	894M-100
105	1000	1	894M-105
110	1000	1	894M-110
115	1000	1	894M-115
120	1000	1	894M-120
125	1000	1	894M-125
130	1000	1	894M-130
135	1000	1	894M-135

### Clé Podger robuste ouverte, contre-coudée, profonde, métrique



#### SC335M

mm	1	SC335M-17
17 mm	1	SC335M-17
19 mm	1	SC335M-19
22 mm	1	SC335M-22
24 mm	1	SC335M-24
27 mm	1	SC335M-27
30 mm	1	SC335M-30
32 mm	1	SC335M-32
36 mm	1	SC335M-36
41 mm	1	SC335M-41
46 mm	1	SC335M-46



## CLÉS POLYGONALES

Clé polygonale double, contrecoudée, profonde en métrique



### 2M

Size	Length (mm)	Quantity	Part Number
6x7	165	5	2M-6-7
8x9	180	5	2M-8-9
8x10	180	5	2M-8-10
10x11	190	5	2M-10-11
10x13	190	5	2M-10-13
12x13	210	5	2M-12-13
13x17	243	5	2M-13-17
14x15	226	5	2M-14-15
16x17	246	5	2M-16-17
16x18	246	5	2M-16-18
17x19	266	5	2M-17-19
18x19	266	5	2M-18-19
19x22	291	5	2M-19-22
20x22	291	5	2M-20-22
21x23	306	5	2M-21-23
22x24	306	5	2M-22-24
24x26	326	5	2M-24-26
24x27	326	5	2M-24-27
25x28	336	5	2M-25-28
27x29	351	1	2M-27-29
27x30	351	5	2M-27-30
27x32	353	5	2M-27-32
30x32	362	5	2M-30-32
32x36	416	1	2M-32-36
36x41	444	1	2M-36-41
41x46	483	1	2M-41-46
46x50	541	1	2M-46-50

Clé polygonale double, contre coudée, profonde en pouce



### 2Z

Size	Length (mm)	Quantity	Part Number
1/4x5/16	165	1	2Z-1/4-5/16
5/16x3/8	180	1	2Z-5/16-3/8
3/8x7/16	190	1	2Z-3/8-7/16

Size	Length (mm)	Quantity	Part Number
1/2x9/16	210	1	2Z-1/2-9/16
9/16x5/8	225.8	1	2Z-9/16-5/8
5/8x11/16	245.5	1	2Z-5/8-11/16
3/4x7/8	290.5	1	2Z-3/4-7/8
13/16x7/8	290.5	1	2Z-13/16-7/8
15/16x1	325.8	1	2Z-15/16-1
1x1 1/8	335.9	1	2Z-1-1.1/8
1 1/16x1 1/4	353	1	2Z-1.1/16-1.1/4

Clé polygonale double, en pouce



### 1300Z

Size	Length (mm)	Quantity	Part Number
1/4x5/16	156	1	1300Z-1/4-5/16
3/8x7/16	193	1	1300Z-3/8-7/16
1/2x9/16	220	1	1300Z-1/2-9/16
19/32x11/16	258	1	1300Z-19/32-11/16
5/8x3/4	278	1	1300Z-5/8-3/4
25/32x13/16	300	1	1300Z-25/32-13/16
7/8x15/16	334	1	1300Z-7/8-15/16
15/16x1	352	1	1300Z-15/16-1
1x1.1/8	380	1	1300Z-1-1.1/8

Clé polygonale double, contrecoudées, profonde en métrique



### 2M/S8

Quantity	Part Number
8	2M/S8

2M-6-7, 2M-8-9, 2M-10-11, 2M-12-13, 2M-14-15, 2M-16-17, 2M-18-19, 2M-20-22

Jeu de 8 clés polygonales doubles contre-coudées profondes, métriques



### 2M/8T

Quantity	Part Number
8	2M/8T

2M-6-7, 2M-8-9, 2M-10-11, 2M-12-13, 2M-14-15, 2M-16-17, 2M-18-19, 2M-20-22

Jeu de 10 clés polygonales doubles contre-coudées profondes, métriques



### 2M/10T

Quantity	Part Number
10	2M/10T

2M-6-7, 2M-8-9, 2M-10-11, 2M-12-13, 2M-14-15, 2M-16-17, 2M-18-19, 2M-20-22, 2M-21-23, 2M-24-27

Jeu de 12 clés polygonales doubles contre-coudées extra longues, métriques



### 2M/12T

Quantity	Part Number
12	2M/12T

2M-6-7, 2M-8-9, 2M-10-11, 2M-12-13, 2M-14-15, 2M-16-17, 2M-18-19, 2M-20-22, 2M-21-23, 2M-24-27, 2M-25-28, 2M-30-32



Jeu de clés polygonales double contre-coudées profondes, dimensions métriques



**2M/**

13	1	2M/13

2M-6-7, 2M-8-9, 2M-10-11, 2M-12-13, 2M-14-15, 2M-16-17, 2M-18-19, 2M-20-22, 2M-21-23, 2M-24-27, 2M-25-28, 2M-30-32, 2M-36-41

Jeu de clés polygonales doubles contre-coudées, pouce



**2Z/7T**

7	1	2Z/7T

2Z-1/4-5/16, 2Z-5/16-3/8, 2Z-3/8-7/16, 2Z-1/2-9/16, 2Z-9/16-5/8, 2Z-5/8-11/16, 2Z-3/4-7/8

Clé polygonale double, droite



**4M**

6x7	95	10 4M-6-7
8x9	110	10 4M-8-9
10x11	125	10 4M-10-11
12x13	140	10 4M-12-13
14x15	155	10 4M-14-15

16x17	170	10	4M-16-17
17x19	170	10	4M-17-19
18x19	185	10	4M-18-19
20x22	205	10	4M-20-22
21x23	225	5	4M-21-23
24x26	250	1	4M-24-26
24x27	255	1	4M-24-27
25x28	275	1	4M-25-28
27x29	275	1	4M-27-29
30x32	300	1	4M-30-32

Clé polygonale double longue, pouces



**44Z**

1/4x5/16 in	197	10	44Z-1/4-5/16
5/16x3/8 in	238	10	44Z-5/16-3/8
3/8x7/16 in	284	10	44Z-3/8-7/16
7/16x1/2 in	326	10	44Z-7/16-1/2
1/2x9/16 in	358	10	44Z-1/2-9/16
5/8x3/4 in	401	5	44Z-5/8-3/4
11/16x3/4 in	401	5	44Z-11/16-3/4
11/16x13/16 in	410	5	44Z-11/16-13/16

Clé polygonale double, demi-lune



**1943M**

11x13	150	1	1943M-11-13
13x15	185	1	1943M-13-15
13x17	185	1	1943M-13-17
14x16	185	1	1943M-14-16
14x17	185	1	1943M-14-17
15x17	185	1	1943M-15-17
19x22	235	1	1943M-19-22

Clé polygonale double demi lune Pouces



**1943Z**

5/16x3/8 in	153	1	1943Z-5/16-3/8
7/16x1/2 in	153	1	1943Z-7/16-1/2
9/16x5/8 in	186	1	1943Z-9/16-5/8
5/8x3/4 in	233	1	1943Z-5/8-3/4
11/16x13/16 in	233	1	1943Z-11/16-13/16

Jeu de 10 clés polygonales doubles, droites



**4M/10T**

10	1	4M/10T

4M-6-7, 4M-8-9, 4M-10-11, 4M-12-13, 4M-14-15, 4M-16-17, 4M-18-19, 4M-20-22, 4M-24-27, 4M-30-32

Jeu de 10 clés polygonales doubles droites, métriques



**4M/10C**

10	1	4M/10C

4M-6-7, 4M-8-9, 4M-10-11, 4M-12-13,  
4M-14-15, 4M-16-17, 4M-18-19, 4M-20-  
22, 4M-21-23, 4M-24-27

Jeu de 12 clés polygonales doubles droites, métriques



### 4M/12C

12 1 4M/12C

4M-6-7, 4M-8-9, 4M-10-11, 4M-12-13,  
4M-14-15, 4M-16-17, 4M-18-19, 4M-  
20-22, 4M-21-23, 4M-24-27, 4M-25-28,  
4M-30-32

Jeu de clé polygonales doubles droites, métriques



### 4M/8

8 1 4M/8

4M-6-7, 4M-8-9, 4M-10-11, 4M-12-  
13, 4M-14-15, 4M-16-17, 4M-18-19,  
4M-20-22

## CLÉS À TUYAUTER

Clé polygononale à tuyauter, métrique



### 1949M

Size	L	Qty	Part No.
8x 9	140	1	1949M-8-9
10x11	150	1	1949M-10-11

Size	L	Qty	Part No.
10x12	150	1	1949M-10-12
12x13	170	1	1949M-12-13
12x14	170	1	1949M-12-14
14x15	170	1	1949M-14-15
14x17	200	1	1949M-14-17
17x19	210	1	1949M-17-19
19x22	220	1	1949M-19-22
22x24	235	1	1949M-22-24
24x27	255	1	1949M-24-27
30x32	280	1	1949M-30-32

Clé polygononale à tuyauter, pouce



### 1949Z

Size	L	Qty	Part No.
3/8x7/16	150	1	1949Z-3/8-7/16
1/2x9/16	170	1	1949Z-1/2-9/16
5/8x3/4	210	1	1949Z-5/8-3/4
3/4x7/8	220	1	1949Z-3/4-7/8
1x1 1/8	255	1	1949Z-1-1.1/8

Clé crowfoot 1/4", écrou évasé



### -679

Size	Qty	Part No.
7 mm	1/4 in	1 679-7
8 mm	1/4 in	1 679-8
9 mm	1/4 in	1 679-9
10 mm	1/4 in	1 679-10
11 mm	1/4 in	1 679-11
12 mm	1/4 in	1 679-12
13 mm	1/4 in	1 679-13
14 mm	1/4 in	1 679-14
3/8 in	1/4 in	1 679-3/8
7/16 in	1/4 in	1 679-7/16
1/2 in	1/4 in	1 679-1/2
9/16 in	1/4 in	1 679-9/16

Clé crowfoot 3/8", écrou évasé



### -749

Size	Qty	Part No.
15 mm	3/8 in	1 749-15
16 mm	3/8 in	1 749-16
17 mm	3/8 in	1 749-17
18 mm	3/8 in	1 749-18
19 mm	3/8 in	1 749-19
20 mm	3/8 in	1 749-20
21 mm	3/8 in	1 749-21
22 mm	3/8 in	1 749-22
23 mm	3/8 in	1 749-23
24 mm	3/8 in	1 749-24
25 mm	3/8 in	1 749-25
26 mm	3/8 in	1 749-26
27 mm	3/8 in	1 749-27
3/8 in	3/8 in	1 749-3/8
7/16 in	3/8 in	1 749-7/16
1/2 in	3/8 in	1 749-1/2
9/16 in	3/8 in	1 749-9/16
5/8 in	3/8 in	1 749-5/8
11/16 in	3/8 in	1 749-11/16
3/4 in	3/8 in	1 749-3/4
13/16 in	3/8 in	1 749-13/16
7/8 in	3/8 in	1 749-7/8
15/16 in	3/8 in	1 749-15/16
1 in	3/8 in	1 749-1
1.1/16 in	3/8 in	1 749-1.1/16
1.1/8 in	3/8 in	1 749-1.1/8
1.3/16 in	3/8 in	1 749-1.3/16
1.1/4 in	3/8 in	1 749-1.1/4
1.5/16 in	3/8 in	1 749-1.5/16
1.3/8 in	3/8 in	1 749-1.3/8
1.7/16 in	3/8 in	1 749-1.7/16
1.1/2 in	3/8 in	1 749-1.1/2
1.9/16 in	3/8 in	1 749-1.9/16
1.5/8 in	3/8 in	1 749-1.5/8
1.11/16 in	3/8 in	1 749-1.11/16
1.3/4 in	3/8 in	1 749-1.3/4
1.13/16 in	3/8 in	1 749-1.13/16
1.7/8 in	3/8 in	1 749-1.7/8
1.15/16 in	3/8 in	1 749-1.15/16
2 in	3/8 in	1 749-2
2.1/8 in	3/8 in	1 749-2.1/8
2.3/16 in	3/8 in	1 749-2.3/16
2.1/4 in	3/8 in	1 749-2.1/4
2.3/8 in	3/8 in	1 749-2.3/8
2.5/8 in	3/8 in	1 749-2.5/8
2.3/4 in	3/8 in	1 749-2.3/4
3.1/8 in	3/8 in	1 749-3.1/8



Clé crowfoot 1/2", écrou évasé



**-789**

mm	in	1	789-XX
28 mm	1/2 in	1	789-28
30 mm	1/2 in	1	789-30
32 mm	1/2 in	1	789-32
34 mm	1/2 in	1	789-34
36 mm	1/2 in	1	789-36
38 mm	1/2 in	1	789-38
40 mm	1/2 in	1	789-40
41 mm	1/2 in	1	789-41
42 mm	1/2 in	1	789-42
46 mm	1/2 in	1	789-46
50 mm	1/2 in	1	789-50
1.1/8 in	1/2 in	1	789-1.1/8
1.1/4 in	1/2 in	1	789-1.1/4
1.5/16 in	1/2 in	1	789-1.5/16
1.3/8 in	1/2 in	1	789-1.3/8
1.7/16 in	1/2 in	1	789-1.7/16
1.1/2 in	1/2 in	1	789-1.1/2
1.9/16 in	1/2 in	1	789-1.9/16
1.5/8 in	1/2 in	1	789-1.5/8
1.3/4 in	1/2 in	1	789-1.3/4
1.13/16 in	1/2 in	1	789-1.13/16
2 in	1/2 in	1	789-2
2.1/4 in	1/2 in	1	789-2.1/4
2.5/16 in	1/2 in	1	789-2.5/16
2.3/8 in	1/2 in	1	789-2.3/8

Clé à molette 3/8", crowfoot



**1950MZ**

mm	in	1	1950MZ-XX
0-29	0-1.1/8"	1	1950MZ-3/8

## CLÉS POLYGONALES

Clé polygonale à frapper



**7444SG-M**

mm	1	7444SG-M-XX
24	1	7444SG-M-24
27	1	7444SG-M-27
30	1	7444SG-M-30
32	1	7444SG-M-32
34	1	7444SG-M-34
36	1	7444SG-M-36
38	1	7444SG-M-38
41	1	7444SG-M-41
42	1	7444SG-M-42
46	1	7444SG-M-46
50	1	7444SG-M-50
55	1	7444SG-M-55
60	1	7444SG-M-60
65	1	7444SG-M-65
70	1	7444SG-M-70
75	1	7444SG-M-75
80	1	7444SG-M-80
85	1	7444SG-M-85
90	1	7444SG-M-90
95	1	7444SG-M-95
100	1	7444SG-M-100
105	1	7444SG-M-105
110	1	7444SG-M-110
115	1	7444SG-M-115
120	1	7444SG-M-120
125	1	7444SG-M-125
130	1	7444SG-M-130
135	1	7444SG-M-135
140	1	7444SG-M-140
145	1	7444SG-M-145
150	1	7444SG-M-150
155	1	7444SG-M-155
160	1	7444SG-M-160
165	1	7444SG-M-165
170	1	7444SG-M-170
175	1	7444SG-M-175

Clé à frapper, Métrique/7444SG-Z



**7444SG-Z**

mm	1	7444SG-Z-XX
1 1/16	1	7444SG-Z-1.1/16
1 1/8	1	7444SG-Z-1.1/8



mm	1	7444SG-Z-XX
1 3/16	1	7444SG-Z-1.3/16
1 1/4	1	7444SG-Z-1.1/4
1 5/16	1	7444SG-Z-1.5/16
1 3/8	1	7444SG-Z-1.3/8
1 7/16	1	7444SG-Z-1.7/16
1 1/2	1	7444SG-Z-1.1/2
1 5/8	1	7444SG-Z-1.5/8
1 11/16	1	7444SG-Z-1.11/16
1 3/4	1	7444SG-Z-1.3/4
1 13/16	1	7444SG-Z-1.13/16
1 7/8	1	7444SG-Z-1.7/8
2	1	7444SG-Z-2
2 1/16	1	7444SG-Z-2.1/16
2 1/8	1	7444SG-Z-2.1/8
2 3/16	1	7444SG-Z-2.3/16
2 1/4	1	7444SG-Z-2.1/4
2 3/8	1	7444SG-Z-2.3/8
2 9/16	1	7444SG-Z-2.9/16
2 5/8	1	7444SG-Z-2.5/8
2 3/4	1	7444SG-Z-2.3/4
3	1	7444SG-Z-3
3 1/8	1	7444SG-Z-3.1/8
3 3/8	1	7444SG-Z-3.3/8
3 1/2	1	7444SG-Z-3.1/2
3 3/4	1	7444SG-Z-3.3/4
3 7/8	1	7444SG-Z-3.7/8
4	1	7444SG-Z-4
4 1/8	1	7444SG-Z-4.1/8
4 1/2	1	7444SG-Z-4.1/2

Clé à fourche à frapper



**133SGM**



mm	1	133SGM-XX
27	1	133SGM-27
30	1	133SGM-30
32	1	133SGM-32
36	1	133SGM-36
41	1	133SGM-41
46	1	133SGM-46
50	1	133SGM-50
55	1	133SGM-55
60	1	133SGM-60
65	1	133SGM-65
70	1	133SGM-70
75	1	133SGM-75
80	1	133SGM-80
85	1	133SGM-85
90	1	133SGM-90
95	1	133SGM-95
100	1	133SGM-100
105	1	133SGM-105

		
110	1	133SGM-110
115	1	133SGM-115
120	1	133SGM-120

Clé polygonale solide, contrecoudées, profonde, métrique





### 315M



		
27	1	315M-27
30	1	315M-30
32	1	315M-32
36	1	315M-36
41	1	315M-41
46	1	315M-46
50	1	315M-50
55	1	315M-55
60	1	315M-60
65	1	315M-65
70	1	315M-70
75	1	315M-75
80	1	315M-80

Clé polygonale solide, contrecoudées, profonde, en pouce



### 315Z



		
1.1/16	1	315Z-1.1/16
1.1/8	1	315Z-1.1/8
1.3/16	1	315Z-1.3/16
1.1/4	1	315Z-1.1/4
1.5/16	1	315Z-1.5/16

		
1.3/8	1	315Z-1.3/8
1.7/16	1	315Z-1.7/16
1.1/2	1	315Z-1.1/2
1.5/8	1	315Z-1.5/8
1.11/16	1	315Z-1.11/16
1.3/4	1	315Z-1.3/4
1.13/16	1	315Z-1.13/16
1.7/8	1	315Z-1.7/8
1.15/16	1	315Z-1.15/16
2	1	315Z-2
2.1/16	1	315Z-2.1/16
2.1/8	1	315Z-2.1/8
2.3/16	1	315Z-2.3/16
2.1/4	1	315Z-2.1/4
2.5/16	1	315Z-2.5/16
2.3/8	1	315Z-2.3/8
2.1/2	1	315Z-2.1/2
2.9/16	1	315Z-2.9/16
2.5/8	1	315Z-2.5/8
2.3/4	1	315Z-2.3/4
2.7/8	1	315Z-2.7/8
2.15/16	1	315Z-2.15/16
3	1	315Z-3
3.1/8	1	315Z-3.1/8

Clé polygonale contre-coudée, gros efforts métrique







### 310M

		
24	1	310M-24
27	1	310M-27
30	1	310M-30
32	1	310M-32
36	1	310M-36
38	1	310M-38
41	1	310M-41
46	1	310M-46
50	1	310M-50
55	1	310M-55
60	1	310M-60
65	1	310M-65
70	1	310M-70
75	1	310M-75
80	1	310M-80
85	1	310M-85
90	1	310M-90
95	1	310M-95

## Rallonge tubulaire



### R310





			
24-30	19	1	R310-0
32-41	22	1	R310-1
46-55	25	1	R310-2
60-95	30	1	R310-3

## CLÉS À PIPE

Clé à pipe double débouchée coudée



### 28M

			
6	6 mm	5	28M-6
7	7 mm	5	28M-7
8	8 mm	5	28M-8
9	9 mm	5	28M-9
10	10 mm	5	28M-10
11	11 mm	5	28M-11
12	12 mm	5	28M-12
13	13 mm	5	28M-13
14	14 mm	5	28M-14
15	15 mm	5	28M-15
16	16 mm	5	28M-16
17	17 mm	5	28M-17
18	18 mm	3	28M-18
19	19 mm	3	28M-19
20	20 mm	3	28M-20
21	21 mm	3	28M-21
22	22 mm	3	28M-22
23	23 mm	3	28M-23
24	24 mm	3	28M-24
25	25 mm	3	28M-25
26	26 mm	3	28M-26
27	27 mm	3	28M-27
28	28 mm	1	28M-28
29	29 mm	1	28M-29
30	30 mm	1	28M-30
32	32 mm	1	28M-32



Clé à pipe double débouchée coudée, métrique  
6 pans x 6 pans



**29M**



6	5	29M-6
7	5	29M-7
8	5	29M-8
9	5	29M-9
10	5	29M-10
11	5	29M-11
12	5	29M-12
13	5	29M-13
14	5	29M-14
15	5	29M-15
16	5	29M-16
17	5	29M-17
18	3	29M-18
19	3	29M-19
20	3	29M-20
21	3	29M-21
22	3	29M-22
23	3	29M-23
24	3	29M-24
25	3	29M-25
26	3	29M-26
27	3	29M-27
28	1	29M-28
29	1	29M-29
30	1	29M-30
32	1	29M-32

Jeu de 11 clés à pipe doubles débouchées



**28M/11**



11 1 28M/11

28M-8, 28M-9, 28M-10, 28M-11, 28M-13, 28M-12, 28M-14, 28M-15, 28M-17, 28M-19, 28M-22



Jeu de 8 clés à pipe doubles débouchées



**29M/8**



8 1 29M/8

29M-8, 29M-10, 29M-12, 29M-13, 29M-14, 29M-17, 29M-19, 29M-22



Jeu de 12 clés à pipe doubles débouchées



**28M/12**



12 1 28M/12

28M-8, 28M-9, 28M-10, 28M-11, 28M-12, 28M-13, 28M-14, 28M-15, 28M-16, 28M-17, 28M-18, 28M-19



Jeu de 10 clés à pipe doubles débouchées



**29M/10**



10 1 29M/10

29M-8, 29M-10, 29M-11, 29M-12, 29M-13, 29M-14, 29M-16, 29M-17, 29M-18, 29M-19



Jeu de 8 clés à pipe doubles débouchées



**28M/8**



8 1 28M/8

28M-8, 28M-10, 28M-11, 28M-13, 28M-16, 28M-17, 28M-18, 28M-19



Jeu de 15 clés à pipe doubles débouchées



**28M/15**



15 1 28M/15

28M-8, 28M-9, 28M-10, 28M-11, 28M-12, 28M-13, 28M-14, 28M-15, 28M-16, 28M-17, 28M-18, 28M-19, 28M-21, 28M-22, 28M-24



Jeu de 14 clés à pipe doubles débouchées



**29M/14**



14 1 29M/14

29M-11, 29M-12, 29M-13, 29M-14, 29M-8, 29M-9, 29M-10, 29M-16, 29M-17, 29M-21, 29M-22, 29M-19, 29M-24, 29M-23



### Clé en tube droite



#### 1936M

6x7	50	1936M-6-7	
8x9	5	1936M-8-9	
8x10	30	1936M-8-10	
10x11	25	1936M-10-11	
10x13	25	1936M-10-13	
12x13	25	1936M-12-13	
13x17	20	1936M-13-17	
14x15	5	1936M-14-15	
14x17	15	1936M-14-17	
16x17	15	1936M-16-17	
17x19	10	1936M-17-19	
18x19	10	1936M-18-19	
19x22	8	1936M-19-22	
20x22	8	1936M-20-22	
21x23	8	1936M-21-23	
22x24	5	1936M-22-24	
24x26	5	1936M-24-26	
24x27	5	1936M-24-27	
25x28	5	1936M-25-28	
30x32	1	1936M-30-32	
30x34	4	1936M-30-34	
36x41	4	1936M-36-41	
46x50	2	1936M-46-50	

27x29*	5	27M-27-29	
30x32*	5	27M-30-32	
6x7	10	SB27M-6-7	
8x9	10	SB27M-8-9	
10x11	10	SB27M-10-11	
12x13	10	SB27M-12-13	
14x15	10	SB27M-14-15	
16x17*	10	SB27M-16-17	
18x19*	10	SB27M-18-19	
20x22*	10	SB27M-20-22	
21x23*	5	SB27M-21-23	
24x26*	5	SB27M-24-26	

### Jeu de 7 clés en tube, forme droite, métriques



#### 1936M/7

7	1	1936M/7		

1936M-8-9, 1936M-10-11, 1936M-12-13, 1936M-14-15, 1936M-16-17, 1936M-18-19, 1936M-20-22			
26S-610			

### Clé à pipe double, métriques



#### 27M

6x7	10	27M-6-7	
8x9	10	27M-8-9	
10x11	10	27M-10-11	
12x13	10	27M-12-13	
13x17*	10	27M-13-17	
14x15	10	27M-14-15	
16x17*	10	27M-16-17	
16x18*	10	27M-16-18	
18x19*	10	27M-18-19	
20x22*	10	27M-20-22	
21x23*	5	27M-21-23	
21x24*	5	27M-21-24	
24x26*	5	27M-24-26	
24x27*	5	27M-24-27	
25x28*	5	27M-25-28	

### Jeu de 12 clés en tube, forme droite, métriques



#### 1936M/12

12	1	1936M/12		

1936M-6-7, 1936M-8-9, 1936M-10-11, 1936M-12-13, 1936M-14-15, 1936M-16-17, 1936M-18-19, 1936M-20-22, 1936M-21-23, 1936M-24-27, 1936M-25-28, 1936M-30-32			
26S-610, 26S-1216, 26S-16			

### Jeu de 8 clés en tube, forme droite, métriques



#### 27M/8T

8	1	27M/8T		

27M-6-7, 27M-8-9, 27M-10-11, 27M-12-13, 27M-14-15, 27M-16-17, 27M-18-19, 27M-20-22		
--	--	--

### Jeu de 12 clés en tube, forme droite, métriques



#### 27M/12T

12	1	27M/12T		

27M-6-7, 27M-8-9, 27M-10-11, 27M-12-13, 27M-14-15, 27M-16-17, 27M-18-19, 27M-20-22, 27M-21-23, 27M-24-26, 27M-25-28, 27M-30-32		
--	--	--

### Jeu de 6 clés en tube doubles, dimensions métriques



#### 27M/6

6	1	27M/6		

27M-6-7, 27M-8-9, 27M-10-11, 27M-12-13, 27M-14-15, 27M-16-17		
--	--	--



Jeu de 8 clés en tube doubles, dimensions métriques



**27M/8**

8	1	27M/8

27M-6-7, 27M-8-9, 27M-10-11, 27M-12-13, 27M-14-15, 27M-16-17, 27M-18-19, 27M-20-22

Jeu de 10 clés en tube doubles, dimensions métriques



**27M/10**

10	1	27M/10

27M-6-7, 27M-8-9, 27M-10-11, 27M-12-13, 27M-14-15, 27M-16-17, 27M-18-19, 27M-20-22, 27M-21-23, 27M-24-26

Jeu de 12 clés en tube doubles, dimensions métriques



**27M/12**

12	1	27M/12

27M-6-7, 27M-8-9, 27M-10-11, 27M-12-13, 27M-14-15, 27M-16-17, 27M-18-19, 27M-20-22, 27M-21-23, 27M-24-26, 27M-25-28, 27M-30-32

Broche épaulée



**26S**

6 8 10	10	26S-610
12 14	8	26S-1216
16 mm	5	26S-16

Clé à douille articulée, double, métrique



**4040M**

6x7 mm	1	4040M-6-7
8x9 mm	1	4040M-8-9
10x11 mm	1	4040M-10-11
10x13 mm	1	4040M-10-13
12x13 mm	1	4040M-12-13
13x17 mm	1	4040M-13-17
14x15 mm	1	4040M-14-15
16x17 mm	1	4040M-16-17
16x18 mm	1	4040M-16-18
17x19 mm	1	4040M-17-19
18x19 mm	1	4040M-18-19
20x22 mm	1	4040M-20-22
21x23 mm	1	4040M-21-23
24x27 mm	1	4040M-24-27

Clé à douille articulée, double, pouce



**4040Z**

3/8x7/16 in	1	4040Z-3/8-7/16
1/2x9/16 in	1	4040Z-1/2-9/16
5/8x11/16 in	1	4040Z-5/8-11/16
5/8x3/4 in	1	4040Z-5/8-3/4
13/16x7/8 in	1	4040Z-13/16-7/8

Clé à douilles articulées, métrique



**4040M/S6**

6	1	4040M/S6

4040M-8-9, 4040M-10-11, 4040M-12-13, 4040M-14-15, 4040M-16-17, 4040M-18-19

Jeu de 6 clés à douille articulées, métriques



**4040M/6T**

6	1	4040M/6T

4040M-8-9, 4040M-10-11, 4040M-12-13, 4040M-14-15, 4040M-16-17, 4040M-18-19

**CLÉS EN CROIX**

Clé en croix multi-empreintes 5 en 1



**MK5**

97x25	1	MK5

Profils : carré 5,6,7-8mm Triangulaire : 9mm  
Clé 2 voies : 3-5mm



## Clé en croix multi-empreintes 9 en 1



### MK9



95x95 1 MK9

Carré : 5,6,7-8,9-10mm Triangulaire : 7,8-9,10-11mm

Clé 2 voies : 3-5mm Demie-June : 6mm

## CLÉS À ERGOTS ARTICULÉES À CRANS

### Clé à ergots articulée à crans



### 4106



19-50 mm	10	4106-19-50
20-35 mm	1	4106-20-35
32-75 mm	10	4106-32-75
35-60 mm	1	4106-35-60
60-90 mm	1	4106-60-90
90-155 mm	5	4106-90-155
155-230 mm	1	4106-155-230

### Clé à ergots articulée



### 40B



19-50 mm	10	40B-19-50
22-35 mm	1	40B-22-35
32-75 mm	10	40B-32-75
35-60 mm	1	40B-35-60
50-120 mm	10	40B-50-120



60-90 mm	1	40B-60-90
95-155 mm	1	40B-95-155
115-165 mm	10	40B-115-165
165-230 mm	1	40B-165-230

### Clé réglable à ergots, pour écrou sans pan



### 4307/4310



10-50 mm	1	4307
22-100 mm	1	4310





**BAHCO**



## Douilles et cliquets



1/4"

Douille 1/4" 6 pans, métrique



**6700SM**

6700SM	
4	5 6700SM-4
4.5	5 6700SM-4.5
5	5 6700SM-5
5.5	5 6700SM-5.5
6	5 6700SM-6
7	5 6700SM-7
8	5 6700SM-8
9	5 6700SM-9
10	5 6700SM-10
11	5 6700SM-11
12	5 6700SM-12
13	5 6700SM-13
14	5 6700SM-14
4	1 SB6700SM-4
4.5	1 SB6700SM-4.5
5	1 SB6700SM-5
5.5	1 SB6700SM-5.5
6	1 SB6700SM-6
7	1 SB6700SM-7
8	1 SB6700SM-8
9	1 SB6700SM-9
10	1 SB6700SM-10
11	1 SB6700SM-11
12	1 SB6700SM-12
13	1 SB6700SM-13
14	1 SB6700SM-14

SB : Conditionnement détail sur carte plastique

Douille 1/4", 6 pans, pouce



**6700SZ**

6700SZ	
1/8 in	5 6700SZ-1/8
5/32	5 6700SZ-5/32
3/16	5 6700SZ-3/16
7/32	5 6700SZ-7/32
1/4	5 6700SZ-1/4
9/32	5 6700SZ-9/32
5/16	5 6700SZ-5/16
11/32	5 6700SZ-11/32

6700SZ	
3/8	5 6700SZ-3/8
7/16	5 6700SZ-7/16
1/2	5 6700SZ-1/2
9/16	5 6700SZ-9/16
1/8 in	5 SB6700SZ-1/8
5/32	1 SB6700SZ-5/32
3/16	1 SB6700SZ-3/16
7/32	1 SB6700SZ-7/32
1/4	1 SB6700SZ-1/4
9/32	1 SB6700SZ-9/32
5/16	1 SB6700SZ-5/16
11/32	1 SB6700SZ-11/32
3/8	1 SB6700SZ-3/8
7/16	1 SB6700SZ-7/16
1/2	1 SB6700SZ-1/2
9/16	1 SB6700SZ-9/16

SB : Conditionnement détail sur carte plastique

Douille 1/4", 6 pans, pour vis Torx®



**6700TORX-E**

6700TORX-E	
E4	5 6700TORX-E4
E5	5 6700TORX-E5
E6	5 6700TORX-E6
E7	5 6700TORX-E7
E8	5 6700TORX-E8
E10	5 6700TORX-E10
E4	1 SB6700TORX-E4
E5	1 SB6700TORX-E5
E6	1 SB6700TORX-E6
E7	1 SB6700TORX-E7
E8	1 SB6700TORX-E8
E10	1 SB6700TORX-E10

SB : Conditionnement détail sur carte plastique

Douille pour réfrigération



**R6810M**

R6810M	
3,4	5 R6810M-3,4
4	5 R6810M-4
4,5	5 R6810M-4,5
5	5 R6810M-5

R6810M	
6	5 R6810M-6
7	1 R6810M-7
8	5 R6810M-8
9	5 R6810M-9
10	5 R6810M-10

Douilles pour réfrigération en pouces



**R6810Z**

R6810Z	
3/16	1 R6810Z-3/16
7/32	1 R6810Z-7/32
1/4	1 R6810Z-1/4
5/16	1 R6810Z-5/16
3/8	1 R6810Z-3/8

Adaptateur 1/4" femelle/femelle



**R6967**

R6967	
5	R6967

Adaptateur 1/4" mâle/mâle



**R6964A**

R6964A	
18	5 R6964A

Douille 1/4" 12 pans, métrique  
A minces parois



**A6700DM**

A6700DM	
5	5 A6700DM-5
5.5	5 A6700DM-5.5
6	5 A6700DM-6
7	5 A6700DM-7
8	5 A6700DM-8
9	5 A6700DM-9
10	5 A6700DM-10
11	5 A6700DM-11
12	5 A6700DM-12
13	5 A6700DM-13
14	5 A6700DM-14
5	1 SBA6700DM-5
5.5	1 SBA6700DM-5.5
6	1 SBA6700DM-6
7	1 SBA6700DM-7
8	1 SBA6700DM-8
9	1 SBA6700DM-9
10	1 SBA6700DM-10
11	1 SBA6700DM-11
12	1 SBA6700DM-12
13	1 SBA6700DM-13
14	1 SBA6700DM-14

SB : Conditionnement détail sur carte plastique

Douille 1/4" 12 pans, pouces  
12 pans, Pouches, A minces parois



**A6700DZ**

A6700DZ	
3/16	5 A6700DZ-3/16
7/32	5 A6700DZ-7/32
1/4	5 A6700DZ-1/4
9/32	5 A6700DZ-9/32
5/16	5 A6700DZ-5/16
11/32	5 A6700DZ-11/32
3/8	5 A6700DZ-3/8
7/16	5 A6700DZ-7/16
1/2	5 A6700DZ-1/2
9/16	5 A6700DZ-9/16
3/16	1 SBA6700DZ-3/16
7/32	1 SBA6700DZ-7/32
1/4	1 SBA6700DZ-1/4
9/32	1 SBA6700DZ-9/32
5/16	1 SBA6700DZ-5/16
11/32	1 SBA6700DZ-11/32

A6800DM	
3/8	1 SBA6700DZ-3/8
7/16	1 SBA6700DZ-7/16
1/2	1 SBA6700DZ-1/2
9/16	1 SBA6700DZ-9/16

SB : Conditionnement détail sur carte plastique

Douille longue 1/4", 12 pans, métrique  
A minces parois



**A6800DM**

A6800DM	
4	1 A6800DM-4
5	1 A6800DM-5
5.5	1 A6800DM-5.5
6	1 A6800DM-6
7	1 A6800DM-7
8	1 A6800DM-8
9	1 A6800DM-9
10	1 A6800DM-10
11	1 A6800DM-11
12	1 A6800DM-12
13	1 A6800DM-13
14	1 A6800DM-14
4	1 SBA6800DM-4
5	1 SBA6800DM-5
5.5	1 SBA6800DM-5.5
6	1 SBA6800DM-6
7	1 SBA6800DM-7
8	1 SBA6800DM-8
9	1 SBA6800DM-9
10	1 SBA6800DM-10
11	1 SBA6800DM-11
12	1 SBA6800DM-12
13	1 SBA6800DM-13
14	1 SBA6800DM-14

SB : Conditionnement détail sur carte plastique

Douille 1/4", 6 pans, métrique  
parois minces



**A6800SM**

A6800SM	
4	1 A6800SM-4
4.5	1 A6800SM-4.5
5	1 A6800SM-5
6	1 A6800SM-6

A6800SM	
7	1 A6800SM-7
8	1 A6800SM-8
9	1 A6800SM-9
10	1 A6800SM-10
11	1 A6800SM-11
12	1 A6800SM-12
13	1 A6800SM-13
14	1 A6800SM-14
15	1 A6800SM-15

SB : Conditionnement détail sur carte plastique

Douille 1/4", 6 pans, pouce  
paroi mince



**A6800SZ**

A6800SZ	
1/8 in	1 A6800SZ-1/8
5/32" in	1 A6800SZ-5/32

Douille longue 1/4" 12 pans, pouces  
A minces parois



**A6800DZ**

A6800DZ	
3/16	1 A6800DZ-3/16
7/32	1 A6800DZ-7/32
1/4	1 A6800DZ-1/4
9/32	1 A6800DZ-9/32
5/16	1 A6800DZ-5/16
11/32	1 A6800DZ-11/32
3/8	1 A6800DZ-3/8
7/16	1 A6800DZ-7/16
1/2	1 A6800DZ-1/2
9/16	1 A6800DZ-9/16
3/16	1 SBA6800DZ-3/16
7/32	1 SBA6800DZ-7/32
1/4	1 SBA6800DZ-1/4
9/32	1 SBA6800DZ-9/32
5/16	1 SBA6800DZ-5/16
11/32	1 SBA6800DZ-11/32
3/8	1 SBA6800DZ-3/8
7/16	1 SBA6800DZ-7/16
1/2	1 SBA6800DZ-1/2
9/16	1 SBA6800DZ-9/16

SB : Conditionnement détail sur carte plastique



Douille articulée 1/4" 12 pans, métrique  
A minces parois



**A6710DM**

5.5	1	A6710DM-5.5
6	1	A6710DM-6
7	1	A6710DM-7
8	1	A6710DM-8
9	1	A6710DM-9
10	1	A6710DM-10
11	1	A6710DM-11
12	1	A6710DM-12
13	1	A6710DM-13
14	1	A6710DM-14

Douille articulée 1/4" 12 pans, pouces  
A minces parois



**A6710DZ**

3/16	1	A6710DZ-3/16
7/32	1	A6710DZ-7/32
1/4	1	A6710DZ-1/4
9/32	1	A6710DZ-9/32
5/16	1	A6710DZ-5/16
11/32	1	A6710DZ-11/32
3/8	1	A6710DZ-3/8
7/16	1	A6710DZ-7/16
1/2	1	A6710DZ-1/2
9/16	1	A6710DZ-9/16

Vilebrequin 1/4" avec poignée rotative en acier



**6952N**

414 mm	1	6952N

Poignée articulée 1/4"



**6958**

153	1	6958
153	1	SB6958

SB : Conditionnement détail sur carte plastique

Poignée coulissante en T 1/4"



**6954**

125	1	6954
125	10	SB6954

SB : Conditionnement détail sur carte plastique

Rallonge avec manche 1/4", métrique  
Carré femelle 1/4" à la base du manche



**6956**

150	1	6956
150	1	SB6956

SB : Conditionnement détail sur carte plastique

Rallonge 1/4", métrique  
Conditionnement sur carte plastique



**6960 - 6962L**

50	1	6960
101	1	6961

152	1	6962
355	1	6962L
53	1	SB6960
101	1	SB6961
152	1	SB6962
355	1	SB6962L

Rallonge angulaire 1/4"



**6960-W - 6962-W**

50	1	6960-W
150	1	6962-W

Barre d'extension moletée 1/4"



**696EX**

26 mm	1	696EX-01
51 mm	1	696EX-02
102 mm	1	696EX-04
152 mm	1	696EX-06
200 mm	1	696EX-08
276 mm	1	696EX-11

Rallonge flexible 1/4", métrique



**6963**

148	1	6963
148	1	SB6963

Cardan universel 1/4"



**6966**

35	1 6966
35	1 SB6966

SB : Conditionnement détail sur carte plastique

Joint de cardan universel 1/4", fonctionnement optimal



**6968**

35	1 6968

Adaptateur pour carré conducteur 1/4" et douille 3/8"



**7765**

1/4	3/8	1 7765
1/4	3/8	1 SB7765

Adaptateur 1/4" pour embouts 1/4"



**6709HL**

1/4" in	1 6709HL

Douille porte-embouts carré 1/4", 6 pans



**6972H**

1/4"	1/4"	5 6972H

Adaptateur 1/4" pour embouts 1/4"



**6973M**

1/4"	1/4" in	1 6973M

Adaptateur 1/4 pour embout 1/4



**6973A**

1/4 in	1 6973A

Adaptateur magnétique carré 1/4" et douille 3/8"  
Avec aimant dans le disque conducteur



**7767**

1/4	1 7767
1/4	1 SB7767

SB : Conditionnement détail sur carte plastique

Jeu d'adaptateurs



**8967/S3**

110 x 194 x 30 mm	1 8967/S3

7767	
8167	
8967	

Support de douilles



**RAIL-187/264/340**

187	3 RAIL-187
264	3 RAIL-264
340	3 RAIL-340

Clips pour support 1/4"



**C1/4**

17	25 CLIPS-1/4



Douille tournevis 1/4" pour vis à fente



**6709F**

0.6	4.5	5	6709F-4.5
0.8	5.5	5	6709F-5.5
0.9	6.5	5	6709F-6.5
1.2	8	5	6709F-8
0.6	4.5	1	SB6709F-4.5
0.8	5.5	1	SB6709F-5.5
0.9	6.5	1	SB6709F-6.5
1.2	8	1	SB6709F-8

SB : Conditionnement détail sur carte plastique

Douille tournevis 1/4" pour vis PHILLIPS®



**6709PH**

1	5	6709PH-1
2	5	6709PH-2
3	5	6709PH-3
1	1	SB6709PH-1
2	1	SB6709PH-2
3	1	SB6709PH-3

SB : Conditionnement détail sur carte plastique

Douille tournevis 1/4" pour vis POZIDRIV®



**6709PZ**

1	5	6709PZ-1
2	5	6709PZ-2
3	5	6709PZ-3
1	1	SB6709PZ-1
2	1	SB6709PZ-2
3	1	SB6709PZ-3

SB : Conditionnement détail sur carte plastique

Douille tournevis 1/4" pour vis TORX TAMPER™



**6709TORX**

T6	5	6709TORX-T6
T7	5	6709TORX-T7
T8	5	6709TORX-T8
T9	5	6709TORX-T9
T10	5	6709TORX-T10
T15	5	6709TORX-T15
T20	5	6709TORX-T20
T25	5	6709TORX-T25
T27	5	6709TORX-T27
T30	5	6709TORX-T30
T40	5	6709TORX-T40
T8	1	SB6709TORX-T8
T9	1	SB6709TORX-T9
T10	1	SB6709TORX-T10
T15	1	SB6709TORX-T15
T20	1	SB6709TORX-T20
T25	1	SB6709TORX-T25
T27	1	SB6709TORX-T27
T30	1	SB6709TORX-T30
T40	1	SB6709TORX-T40

SB : Conditionnement détail sur carte plastique

Douille tournevis 1/4" pour vis TORX™  
Tamper Resistant



**6709TORX-R**

TR 8	1	6709TORX-R-T8
TR 10	1	6709TORX-R-T10
TR 15	1	6709TORX-R-T15
TR 20	1	6709TORX-R-T20
TR 25	1	6709TORX-R-T25
TR 8	1	SB6709TORX-R-T8
TR 10	1	SB6709TORX-R-T10
TR 15	1	SB6709TORX-R-T15
TR 20	1	SB6709TORX-R-T20
TR 25	1	SB6709TORX-R-T25

SB : Conditionnement détail sur carte plastique

Douille tournevis 1/4", TORX PLUS®



**6709-IP**

IP6		1	6709-IP6
IP7		1	6709-IP7
IP8		1	6709-IP8
IP9		1	6709-IP9
IP10	M3	1	6709-IP10
IP15	-	1	6709-IP15
IP20	M4	1	6709-IP20
IP25	M5	1	6709-IP25
IP27	-	1	6709-IP27
IP30	M6	1	6709-IP30
IP40	M8	1	6709-IP40
IP45	-	1	6709-IP45

Douille tournevis 1/4" 6 pans, métrique  
Série courte, métrique



**6709M**

3	5	6709M-3
4	5	6709M-4
5	5	6709M-5
6	5	6709M-6
8	5	6709M-8
10 mm	5	6709M-10
3	1	SB6709M-3
4	1	SB6709M-4
5	1	SB6709M-5
6	1	SB6709M-6
8	1	SB6709M-8

SB : Conditionnement détail sur carte plastique



Douille tournevis 1/4" 6 pans  
Série longue, métrique



**A6709M**

2.5	1	A6709M-2.5
3	1	A6709M-3
4	1	A6709M-4
5	1	A6709M-5
6	1	A6709M-6
2.5	1	SBA6709M-2.5
3	1	SBA6709M-3
4	1	SBA6709M-4
5	1	SBA6709M-5
6	1	SBA6709M-6

SB : Conditionnement détail sur carte plastique

Douille tournevis 1/4" 6 pans,  
Série longue, Pouces



**A6709Z**

1/8	1	A6709Z-1/8
9/64	1	A6709Z-9/64
5/32	1	A6709Z-5/32
3/16	1	A6709Z-3/16
1/8	1	SBA6709Z-1/8
9/64	1	SBA6709Z-9/64
5/32	1	SBA6709Z-5/32
3/16	1	SBA6709Z-3/16

SB : Conditionnement détail sur carte plastique

Cliquet réversible 1/4", 72 dents,  
angle de débattement 5°  
Tête extra fine pour les espaces restreints



**6950SL**

119	72	1	6950SL

Cliquet réversible 1/4", 72 dents  
Angle de débattement 5°, Etanche, Conditionnement  
sur carte



**6950**

121	72	1	6950
121	72	1	SB6950

Cliquet réversible 1/4", 72 dents, angle de débattement 5°  
Flèche de changement de direction, Conditionnement sur  
carte



**6950RN**

121	72	1	6950RN
121	72	1	SB6950RN

Cliquet réversible de frigorigère



**R6950**

160	32	1	R6950

Cliquet réversible 1/4"  
Conditionnement individuel



**SBS61**

145	60	1	SBS61

Cliquet réversible court 1/4"  
60 dents, angle de débattement 6°



**SBS61S**

120 mm	60	1	SBS61S

Cliquet à tête pivotante



**8120-1/4**

149 mm	72	20	8120-1/4

Cliquet réversible 1/4"  
52 dents



**6951**

40	1	6951

Jeu de pièces détachées pour cliquet 1/4" référence  
6950



**6950-SPARE**

12	6950	1	6950-SPARE



Jeu de pièces détachées pour cliquet 1/4" 6950RN



**6950RN-SPARE**

6	6950RN	1	6950RN-SPARE

Jeu de pièces détachées pour cliquet 1/4" 6950SL



**6950SL-SPARE**

10	6950SL	1	6950SL-SPARE

Jeu de douilles 1/4" 6 pans - 12 pièces  
Coffret métallique



**6712R**

31 x 110 x 178 mm	1	6712R

6700SM-4, 6700SM-5, 6700SM-5.5, 6700SM-6, 6700SM-7, 6700SM-8, 6700SM-10, 6700SM-11, 6700SM-13		
6950		
6960, 6962		

Jeu de douilles 1/4" 6 pans - 12 pièces  
Coffret métallique



**6712RN**

31 x 108 x 178 mm	1	6712RN

6700SM-4, 6700SM-5, 6700SM-5.5, 6700SM-6, 6700SM-7, 6700SM-8, 6700SM-10, 6700SM-11, 6700SM-13		
6960, 6962		
6950RN		

Jeu de douilles 1/4" 12 pans - 15 pièces  
Coffret métallique



**A6716DM**

35 x 111 x 223 mm	1	A6716DM

A6700DM-5.5, A6700DM-6, A6700DM-7, A6700DM-8, A6700DM-9, A6700DM-10, A6700DM-11, A6700DM-12, A6700DM-13, A6700DM-14		
6956		
6962		
6966		
6954		
6950		

Jeu de douilles 1/4" 6 pans - 16 pièces  
Coffret métallique



**6715MGS**

34 x 113 x 223 mm	1	6715MGS

SB6700SM-4, 6700SM-4.5, 6700SM-5, 6700SM-5.5, 6700SM-6, 6700SM-7, 6700SM-8, 6700SM-9, 6700SM-10, 6700SM-11, 6700SM-13		
6954		
6950RN		
6956		
6966		
6962		

Jeu de douilles 1/4", 32 pièces



**6719MHR**

50 x 110 x 220 mm	1	6719MHR

6700SM-4, 6700SM-4.5, 6700SM-5.5, 6700SM-5, 6700SM-6, 6700SM-7, 6700SM-8, 6700SM-9, 6700SM-10, 6700SM-11, 6700SM-12, 6700SM-13, 6700SM-14		
6950RN		
6960, 6962		
6954		
6956		
6966		

Jeu de douilles 1/4", 15 pièces



**6729MHR**



50 x 110 x 220 mm

1 6729MHR

6700SM-4, 6700SM-5, 6700SM-6, 6700SM-7, 6700SM-8, 6700SM-9, 6700SM-10, 6700SM-11, 6700SM-13, 6700SM-14		
6950RN		
6960, 6962		
6966		
6956		
6973A		
59S/PH1, 59S/PH2, 59S/PH3		
59S/PZ1, 59S/PZ2, 59S/PZ3		
59S/0.6-4.5, 59S/0.8-5.5, 59S/1.2-6.5		
59S/H3, 59S/H4, 59S/H5, 59S/H6		

Jeu de douilles 1/4", 16 pièces



**6729MHP**



50 x 110 x 220 mm

1 6729MHP

6700SM-4, 6700SM-5, 6700SM-6, 6700SM-7, 6700SM-8, 6700SM-9, 6700SM-10, 6700SM-11, 6700SM-13, 6700SM-14		
6950		
6960, 6962		
6966		
6956		
6973A		
59S/0.6-4.5, 59S/0.8-5.5, 59S/1.2-6.5		
59S/PZ1, 59S/PZ2, 59S/PZ3		
59S/PH1, 59S/PH2, 59S/PH3		
59S/H3, 59S/H4, 59S/H5, 59S/H6		

Jeu de douilles 1/4", 17 pièces



**6717MBP**



50 x 110 x 220 mm

1 6717MBP

A6700DM-5, A6700DM-5.5, A6700DM-6, A6700DM-7, A6700DM-8, A6700DM-9, A6700DM-10, A6700DM-11, A6700DM-12, A6700DM-13, A6700DM-14		
6950		
6960, 6962		
6954		
6966		
6956		

Jeu de douilles 1/4", 26 pièces



**6730MBP**



50 x 110 x 220 mm

1 6730MBP

A6700DM-5, A6700DM-5.5, A6700DM-6, A6700DM-7, A6700DM-8, A6700DM-9, A6700DM-10, A6700DM-11, A6700DM-12, A6700DM-13, A6700DM-14		
6950		
6960, 6962		
6954		
6966		
6956		
6973A		
59S/0.6-4.5, 59S/1.2-6.5, 59S/0.8-5.5		
59S/PH1, 59S/PH2, 59S/PH3		
59S/PZ1, 59S/PZ2, 59S/PZ3		
59S/H3, 59S/H4, 59S/H5, 59S/H6		

Jeu de douilles 1/4", 17 pièces  
Coffret métallique



**6719SM**



41 x 113 x 223 mm

1 6719SM

6700SM-4, 6700SM-4.5, 6700SM-5, 6700SM-5.5, 6700SM-6, 6700SM-7, 6700SM-8, 6700SM-9, 6700SM-10, 6700SM-11, 6700SM-12, 6700SM-13		
6954		
6950		
6956		
6966		
6962		

Jeu de douilles 1/4", 20 pièces  
Coffret métallique



**6715MG**



35 x 111 x 223 mm

1 6715MG

6700SM-4, 6700SM-4.5, 6700SM-5, 6700SM-5.5, 6700SM-6, 6700SM-7, 6700SM-8, 6700SM-9, 6700SM-10, 6700SM-11, 6700SM-13, 6700SM-14, 6700SM-12		
6954		
6958		
6956		
6962, 6960		
6966		
6950RN		



Jeu de douilles et embouts 1/4", 65 pcs



**SL65**

70 x 160 x 280 mm	6	SL65

Jeu de douilles 1/4", 21 pièces  
Coffret métallique



**6721NM**

41 x 113 x 223 mm	1	6721NM

6700SM-4, 6700SM-4.5, 6700SM-7, 6700SM-6, 6700SM-5.5, 6700SM-5, 6700SM-8, 6700SM-9, 6700SM-10, 6700SM-11, 6700SM-14, 6700SM-13, 6700SM-12		
6954		
6951		
6956		
6950		
6962		
6966		
6960		
6958		

Jeu de douilles et embouts 1/4", 65 pcs



**SW65**

70 x 160 x 280 mm	6	SW65

Jeu de douilles 1/4", 27 pièces  
Coffret métallique



**6722M**

41 x 113 x 223 mm	1	6722M

6700SM-4, 6700SM-7, 6700SM-6, 6700SM-5, 6700SM-8, 6700SM-9, 6700SM-10, 6700SM-11, 6700SM-13, 6700SM-14		
6954		
6956		
6950		
6966		
6960, 6962		
6972H		
59S/H3, 59S/H4, 59S/H5, 59S/H6		
59S/PH1, 59S/PH2, 59S/PH3		

Jeu de douilles 1/4", 27 pièces  
Coffret métallique



**6715GE**

31 x 113 x 223 mm	1	6715GE

6700SM-4, 6700SM-7, 6700SM-6, 6700SM-5, 6700SM-11, 6700SM-10, 6700SM-9, 6700SM-8, 6700SM-14, 6700SM-13		
6956		
6950RN		
6954		
6966		
6960, 6962		
6972H		
59S/H3, 59S/H4, 59S/H5, 59S/H6		
59S/PH1, 59S/PH2, 59S/PH3		

Jeu de douilles 1/4", 29 pièces  
Coffret métallique



**6715PZ**



41 x 113 x 223 mm	1	6715PZ















6700SM-4, 6700SM-4.5, 6700SM-7, 6700SM-6, 6700SM-5.5, 6700SM-5, 6700SM-11, 6700SM-10, 6700SM-9, 6700SM-8, 6700SM-12, 6700SM-13		
6956		
6950		
6954		
6962, 6960		
6966		
6709F-4.5, 6709F-5.5, 6709F-8		
6709M-3, 6709M-4, 6709M-5, 6709M-6, 6709M-8		
6709PZ-1, 6709PZ-3, 6709PZ-2		

Jeu de douilles 1/4", 29 pièces  
Coffret métallique



**6715GJ**

 50 x 113 x 223 mm   1 6715GJ















6700SM-4, 6700SM-4.5, 6700SM-5.5, 6700SM-5, 6700SM-8, 6700SM-7, 6700SM-6, 6700SM-9, 6700SM-10, 6700SM-11, 6700SM-12, 6700SM-13		
6956		
6962		
6709F-4.5, 6709F-5.5, 6709F-8		
6709M-5, 6709M-6, 6709M-8, 6709M-4, 6709M-3		
6954		
6950		
6966		
6960		
6709PH-1, 6709PH-2, 6709PH-3		

Jeu de douilles 1/4", 33 pièces  
Coffret métallique



**6720NM**

 43 x 114 x 351 mm   1 6720NM







6700SM-4.5, 6700SM-7, 6700SM-6, 6700SM-5, 6700SM-5.5, 6700SM-11, 6700SM-10, 6700SM-9, 6700SM-8, 6700SM-13, 6700SM-14, 6700SM-12		
1931M-4, 1931M-4.5, 1931M-9, 1931M-10, 1931M-11, 1931M-14, 1931M-13, 1931M-12, 1931M-7, 1931M-8, 1931M-6, 1931M-5.5, 1931M-5		
6954		
6950		
6956		
221 D		
7372I-3-80		
6966		
6962		
6700SM-4		

Jeu de 15 douilles 1/4"  
Coffret métallique



**A6716DZ**





 41 x 113 x 223 mm   1 A6716DZ

A6700DZ-3/16, A6700DZ-7/32, A6700DZ-1/4, A6700DZ-9/32, A6700DZ-5/16, A6700DZ-11/32, A6700DZ-3/8, A6700DZ-7/16, A6700DZ-1/2, A6700DZ-9/16		
6956		
6962		
6966		
6954		
6950		









Coffret de 18 douilles, 1/4", pouce  
Coffret métallique



**A6718DZ**

 41 x 113 x 223 mm  1185   1 A6718DZ

Coffret métallique









6950		
6951		
6956		
6954		
6958		
6960, 6962		
6966		
A6700DZ-3/16, A6700DZ-7/32, A6700DZ-1/4, A6700DZ-9/32, A6700DZ-5/16, A6700DZ-11/32, A6700DZ-3/8, A6700DZ-7/16, A6700DZ-1/2, A6700DZ-9/16		

Jeu de douilles 1/4", 19 pièces  
Coffret métallique



**6821NZ**

 50 x 113 x 223 mm   1 6821NZ











6700SZ-1/4, 6700SZ-11/32, 6700SZ-1/2, 6700SZ-3/16, 6700SZ-5/32, 6700SZ-7/32, 6700SZ-9/32, 6700SZ-5/16, 6700SZ-3/8, 6700SZ-7/16, 6700SZ-9/16		
6954		
6958		
6950		
6956		
6960, 6962		
6966		
6951		

Jeu de 25 douilles 1/4"  
Coffret métallique



**6715MZ**

 40 x 126 x 230 mm   1 6715MZ

6700SM-4.5, 6700SM-5.5, 6700SM-5, 6700SM-6, 6700SM-10, 6700SM-11, 6700SM-9, 6700SM-8, 6700SM-13		
6700SZ-7/32, 6700SZ-3/16, 6700SZ-1/4, 6700SZ-9/32, 6700SZ-5/16, 6700SZ-11/32, 6700SZ-3/8, 6700SZ-7/16, 6700SZ-1/2		
6954		
6950		
6956		
6966		
6962		
6700SM-4		



Jeu de douilles 1/4", 13 pièces  
 Douille 6700SM, 6 pans, Sur règlette



### 6729SM

 25 x 55 x 190 mm   1 6729SM

6700SM-4.5, 6700SM-7, 6700SM-6,  
 6700SM-5.5, 6700SM-5, 6700SM-11,  
 6700SM-10, 6700SM-9, 6700SM-8,  
 6700SM-14, 6700SM-13, 6700SM-12,  
 6700SM-4  
 6956

Jeu de 7 douilles 1/4"  
 Douille 6700SM, 6 pans, Sur règlette



### 6729SZ

 25 x 55 x 190 mm   1 6729SZ











6700SZ-1/4, 6700SZ-11/32, 6700SZ-  
 1/2, 6700SZ-3/16, 6700SZ-7/32,  
 6700SZ-3/8, 6700SZ-7/16  
 6956

Jeu d'outils dans une boîte métallique, métrique 18  
 pièces  
 Pour frigoriste



### R6725MK

 26 x 105 x 175 mm   1 R6725MK













6700SM-7, 6700SM-8, 6700SM-10    
 6954   
 R6967   
 R6810M-3,4, R6810M-4, R6810M-4,5,  
 R6810M-5, R6810M-6, R6810M-7,  
 R6810M-8, R6810M-9, R6810M-10   
 6966   
 R6950    
 6962   
 R6964A 

Jeu d'outils dans une boîte métallique, Pouces 13  
 pièces  
 Pour frigoriste



### R6725ZK

 48 x 115 x 225 mm   1 R6725ZK

6700SZ-1/4, 6700SZ-5/16, 6700SZ-  
 11/32, 6700SZ-3/8, 6700SZ-7/16,  
 6700SZ-1/2    
 6954   
 R6967   
 R6950    
 6962   
 R6810M-6   
 R6964A   
 6966   
 R6810Z-3/16, R6810Z-7/32,  
 R6810Z-1/4, R6810Z-5/16, R6810Z-3/8   
 R6822Z 

Coffret de douilles longues 1/4", 10 pièces



### S0810L

 35 x 85 x 160 mm   20 S0810L

Jeu de douilles 1/4  
 24 pièces



### SL24

 35 x 85 x 160 mm   1 SL24

Jeu de douilles 1/4  
 25 pièces



### SL25

 35 x 85 x 160 mm  20 SL25  
 55 x 80 x 165 mm  5 SBSL25

Coffret de douilles 1/4"  
 25 pièces



### SL25AF

 35 x 85 x 165 mm   1 SL25AF

Jeu de douilles standard et longues 1/4, 37 pièces



**SL25L**



46 x 130 x 195 mm



10 SL25L

Jeu de douilles 1/4  
29 pièces



**S290**



70 x 160 x 280 mm



6 S290

Jeu combiné de douilles 1/4 et 1/2 et clés mixtes  
92 pièces



**S910AF**



110 x 320 x 370 mm



2 S910AF

SBS81



SBS61



Jeu de douilles 1/4  
16 pièces



**S160**



70 x 160 x 280 mm



6 S160

Jeu de douilles 1/4  
46 pièces



**S460**



100 x 215 x 375 mm



6 S460

Jeu combiné de douilles 1/4 et 1/2 et clés mixtes  
94 pièces



**S87+7**



110 x 430 x 375 mm



2 S87+7

Jeu de douilles 1/4  
16 pièces, Pouces



**S160AF**



70 x 160 x 280 mm



6 S160AF

Jeu de douilles 1/4" et 1/2" et clés mixtes  
92 pièces



**S910**



110 x 320 x 375 mm



2 S910

Jeu combiné de douilles 1/4 et 1/2 et clés mixtes  
106 pièces



**S106**



110 x 430 x 375 mm



2 S106



Coffret de douilles 1/4" et 1/2"  
41 pièces



**S410**



110 x 320 x 375 mm

2 S410

Coffret de douilles 1/4" - 1/2", 77 pièces



**S800**



110 x 375 x 430 mm

2 S800

Coffret de douilles 1/4", 3/8", 1/2" et clés mixtes, 138 pièces



**S138**



110 x 375 x 430 mm

2 S138

Jeu de douilles 1/4", 3/8", 1/2", 137 pcs



**S137**



105 x 370 x 430 mm

2 S137

Jeu de douilles 1/4" 6 pans métrique, sur réglette - 13 pièces



**6713MH**



13

1 6713MH

6700SM-4.5, 6700SM-4, 6700SM-7, 6700SM-6, 6700SM-5.5, 6700SM-5, 6700SM-11, 6700SM-10, 6700SM-9, 6700SM-8, 6700SM-12, 6700SM-14, 6700SM-13

Jeu de douilles 1/4", 11 pièces  
Sur réglette



**6711MB**



11

1 6711MB

A6700DM-11, A6700DM-10, A6700DM-9, A6700DM-8, A6700DM-12, A6700DM-7, A6700DM-6, A6700DM-5.5, A6700DM-5, A6700DM-14, A6700DM-13

Jeu de douilles 1/4", sur réglette - 6 pièces



**6706TE**



6

1 6706TE

6700TORX-E4, 6700TORX-E7, 6700TORX-E6, 6700TORX-E10, 6700TORX-E8, 6700TORX-E5

**3/8"**

Douille 3/8", 6 pans, métrique



**7400SM**



6

5 7400SM-6

7

5 7400SM-7

8

5 7400SM-8

9

5 7400SM-9

Jeu de 8 douilles 1/4" 12 pans métrique, sur réglette



**6708DMB**



8

1 6708DMB

A6800DM-6, A6800DM-8, A6800DM-7, A6800DM-9, A6800DM-10, A6800DM-11, A6800DM-12, A6800DM-13



10	5	7400SM-10
11	5	7400SM-11
12	5	7400SM-12
13	5	7400SM-13
14	5	7400SM-14
15	5	7400SM-15
16	5	7400SM-16
17	5	7400SM-17
18	5	7400SM-18
19	5	7400SM-19
20	5	7400SM-20
21	5	7400SM-21
22	5	7400SM-22
6	1	SB7400SM-6
7	1	SB7400SM-7
8	1	SB7400SM-8
9	1	SB7400SM-9
10	1	SB7400SM-10
11	1	SB7400SM-11
12	1	SB7400SM-12
13	1	SB7400SM-13
14	1	SB7400SM-14
15	1	SB7400SM-15
16	1	SB7400SM-16
17	1	SB7400SM-17
18	1	SB7400SM-18
19	1	SB7400SM-19
20	1	SB7400SM-20
21	1	SB7400SM-21
22	1	SB7400SM-22

SB : Conditionnement détail sur carte plastique

Douille 3/8", carré  
12 pans, métrique, A parois minces



**A7400DM**

6	5	A7400DM-6
7	5	A7400DM-7
8	5	A7400DM-8
9	5	A7400DM-9
10	5	A7400DM-10
11	5	A7400DM-11
12	5	A7400DM-12
13	5	A7400DM-13
14	5	A7400DM-14
15	5	A7400DM-15
16	5	A7400DM-16
17	5	A7400DM-17
18	5	A7400DM-18
19	5	A7400DM-19
20	5	A7400DM-20
21	5	A7400DM-21
22	5	A7400DM-22
24	5	A7400DM-24
6	1	SBA7400DM-6
7	1	SBA7400DM-7

8	1	SBA7400DM-8
9	1	SBA7400DM-9
10	1	SBA7400DM-10
11	1	SBA7400DM-11
12	1	SBA7400DM-12
13	1	SBA7400DM-13
14	1	SBA7400DM-14
15	1	SBA7400DM-15
16	1	SBA7400DM-16
17	1	SBA7400DM-17
18	1	SBA7400DM-18
19	1	SBA7400DM-19
20	1	SBA7400DM-20
21	1	SBA7400DM-21
22	1	SBA7400DM-22

SB : Conditionnement détail sur carte plastique

Douille 3/8", 6 pans, pouce  
6 pans, pouces



**7400SZ**

1/4" in	1	7400SZ-1/4
5/16" in	1	7400SZ-5/16
11/32" in	1	7400SZ-11/32
3/8" in	1	7400SZ-3/8
7/16" in	1	7400SZ-7/16
1/2" in	1	7400SZ-1/2
9/16" in	1	7400SZ-9/16
5/8" in	1	7400SZ-5/8
11/16" in	1	7400SZ-11/16
3/4" in	1	7400SZ-3/4
13/16" in	1	7400SZ-13/16
7/8" in	1	7400SZ-7/8

Douille 3/8", carré  
12 pans, Pouce, A parois minces



**A7400DZ**

1/4	5	A7400DZ-1/4
5/16	5	A7400DZ-5/16

3/8	5	A7400DZ-3/8
7/16	5	A7400DZ-7/16
1/2	5	A7400DZ-1/2
17/32	5	A7400DZ-17/32
9/16	5	A7400DZ-9/16
19/32	5	A7400DZ-19/32
5/8	5	A7400DZ-5/8
11/16	5	A7400DZ-11/16
3/4	5	A7400DZ-3/4
13/16	5	A7400DZ-13/16
7/8	5	A7400DZ-7/8
1/4	1	SBA7400DZ-1/4
5/16	1	SBA7400DZ-5/16
3/8	1	SBA7400DZ-3/8
7/16	1	SBA7400DZ-7/16
1/2	1	SBA7400DZ-1/2
17/32	1	SBA7400DZ-17/32
9/16	1	SBA7400DZ-9/16
19/32	1	SBA7400DZ-19/32
5/8	1	SBA7400DZ-5/8
11/16	1	SBA7400DZ-11/16
3/4	1	SBA7400DZ-3/4
13/16	1	SBA7400DZ-13/16
7/8	1	SBA7400DZ-7/8

SB : Conditionnement détail sur carte plastique

Douille articulée 3/8", carré  
12 pans, Pouce, A parois minces



**A7410DZ**

5/16	1	A7410DZ-5/16
3/8	1	A7410DZ-3/8
7/16	1	A7410DZ-7/16
1/2	1	A7410DZ-1/2
9/16	1	A7410DZ-9/16
5/8	1	A7410DZ-5/8
11/16	1	A7410DZ-11/16
3/4	1	A7410DZ-3/4



Douille longue 3/8", carré  
12 pans, métrique



### A7402DM

A7402DM	
7	1 A7402DM-7
8	1 A7402DM-8
9	1 A7402DM-9
10	1 A7402DM-10
11	1 A7402DM-11
12	1 A7402DM-12
13	1 A7402DM-13
14	1 A7402DM-14
15	1 A7402DM-15
16	1 A7402DM-16
17	1 A7402DM-17
18	1 A7402DM-18
19	1 A7402DM-19
21	1 A7402DM-21
7	1 SBA7402DM-7
8	1 SBA7402DM-8
9	1 SBA7402DM-9
10	1 SBA7402DM-10
11	1 SBA7402DM-11
12	1 SBA7402DM-12
13	1 SBA7402DM-13
14	1 SBA7402DM-14
15	1 SBA7402DM-15
16	1 SBA7402DM-16
17	1 SBA7402DM-17
18	1 SBA7402DM-18
19	1 SBA7402DM-19

SB : Conditionnement détail sur carte plastique

Douille longue 3/8", carré  
12 pans, Pouces



### A7402DZ

A7402DZ	
1/4	1 A7402DZ-1/4
5/16	1 A7402DZ-5/16
3/8	1 A7402DZ-3/8
7/16	1 A7402DZ-7/16
1/2	1 A7402DZ-1/2
9/16	1 A7402DZ-9/16
19/32	1 A7402DZ-19/32
5/8	1 A7402DZ-5/8
11/16	1 A7402DZ-11/16
3/4	1 A7402DZ-3/4

13/16	1 A7402DZ-13/16
7/8	1 A7402DZ-7/8
1/4	1 SBA7402DZ-1/4
5/16	1 SBA7402DZ-5/16
3/8	1 SBA7402DZ-3/8
7/16	1 SBA7402DZ-7/16
1/2	1 SBA7402DZ-1/2
9/16	1 SBA7402DZ-9/16
19/32	1 SBA7402DZ-19/32
5/8	1 SBA7402DZ-5/8
11/16	1 SBA7402DZ-11/16
3/4	1 SBA7402DZ-3/4
13/16	1 SBA7402DZ-13/16
7/8	1 SBA7402DZ-7/8

SB : Conditionnement détail sur carte plastique

Douille tournevis 3/8", 6 pans  
pour vis TORX™



### 7400TORX-E

7400TORX-E	
E8	5 7400TORX-E8
E10	5 7400TORX-E10
E11	5 7400TORX-E11
E12	5 7400TORX-E12
E14	5 7400TORX-E14
E16	5 7400TORX-E16
E18	5 7400TORX-E18
E8	1 SB7400TORX-E8
E10	1 SB7400TORX-E10
E11	1 SB7400TORX-E11
E12	1 SB7400TORX-E12
E14	1 SB7400TORX-E14
E16	1 SB7400TORX-E16
E18	1 SB7400TORX-E18

SB : Conditionnement détail sur carte plastique

Vilebrequin 3/8", poignée rotative en acier



### 7752

7752	
435	1 7752

Poignée articulée 3/8"



### 7758

7758	
250	1 7758
235	1 SB7758

SB : Conditionnement détail sur carte plastique

Poignée articulée 3/8"  
Conditionnement sur carte



### S705

S705	
246	1 SBS705

Poignée coulissante en T 3/8"



### 7754

7754	
160	1 7754
160	1 SB7754

SB : Conditionnement détail sur carte plastique

Rallonge avec manche carré femelle 3/8"



**7757**

L	Icon
150	1 7757
150	1 SB7757

Barre d'extension moletée 3/8"



**776EX**

L	Icon
26	1 776EX-01
76	1 776EX-03
101	1 776EX-04
150	1 776EX-06
200	1 776EX-08
275	1 776EX-11

Joint de cardan universel 3/8", fonctionnement optimal



**7768**

L	Icon
45	1 7768

Rallonge 3/8"



**7760-7761-7762**

L	Icon
75	1 7760
127	1 7761
250	1 7762
75	1 SB7760
127	1 SB7761
252	1 SB7762

Rallonge extensible 3/8"



**7759**

L	Icon
200	1 7759
200	1 SB7759

Adaptateur pour carré conducteur 3/8" douille 1/4"



**7764**

Icon	mm	Icon
3/8	1/4	1 7764
3/8	1/4	1 SB7764

Rallonge angulaire 3/8"



**7760-W - 7761-W**

L	Icon
75	1 7760-W
150	1 7761-W

Cardan universel 3/8"



**7766**

L	Icon
51.5	1 7766
51.5	1 SB7766

SB : Conditionnement détail sur carte plastique

Adaptateur pour carré conducteur 3/8" douille 1/2"



**8164-1/2**





Icon	mm	Icon
3/8"	1/2"	1 8164-1/2



Adaptateur magnétique pour carré conducteur 3/8"  
douille 1/2"





**8167**

			
3/8	1/2	1	8167

Clip pour support de douilles ou douilles tournevis 3/8"



**C3/8**

		
19	25	CLIPS-3/8

Cliquet réversible 3/8"  
80 dents/ angle de prise 4.5"





**7750**

			
207	80	1	7750
207 mm	80	1	SB7750

Adaptateur 3/8" pour embouts 1/4"



**SBS780**



		
1/4	1	SBS780

Cliquet réversible Ergo™ 3/8", 72 dents

**ergo**



**7755-3/8**

			
215	72	1	7755-3/8
215	72	1	SB7755-3/8

Cliquet réversible 3/8"



**7750RN**

			
206	72	1	7750RN
206	72	1	SB7750RN

Adaptateur 3/8" pour embouts 5/16"



**7106J**

		
5/16 in	1	7106J

Cliquet réversible 3/8", 72 dents,  
angle de débattement 5°



**7750SL**

			
204	72	1	7750SL

Tête fine pour endroits restreints

Cliquet réversible 3/8"  
Conditionnement sur carte



**SBS750**

			
200	60	10	SBS750

Cliquet à tête pivotante



**8120-3/8**

223 mm	72	10	8120-3/8

Cliquet réversible articulé 3/8"



**7710**

278	60	1	7710

Douille tournevis 3/8" pour vis à fente



**7409F**

6.4	5	7409F-6.5
7.9	5	7409F-8
9.5	5	7409F-10
6.4	1	SB7409F-6.5
7.9	1	SB7409F-8
9.5	1	SB7409F-10

SB : Conditionnement détail sur carte plastique

Douille tournevis 3/8" pour vis PHILLIPS®



**7409PH**

1	5	7409PH-1
2	5	7409PH-2
3	5	7409PH-3
1	1	SB7409PH-1
2	1	SB7409PH-2
3	1	SB7409PH-3

SB : Conditionnement détail sur carte plastique

Douille tournevis 3/8" pour vis TORX™ Série longue



**7409TORX**

T20	5	7409TORX-T20
T25	5	7409TORX-T25
T27	5	7409TORX-T27
T30	5	7409TORX-T30
T40	5	7409TORX-T40
T45	5	7409TORX-T45
T50	5	7409TORX-T50
T20	1	SB7409TORX-T20
T25	1	SB7409TORX-T25
T27	1	SB7409TORX-T27
T30	1	SB7409TORX-T30
T40	1	SB7409TORX-T40
T45	1	SB7409TORX-T45
T50	1	SB7409TORX-T50

SB : Conditionnement détail sur carte plastique

Douille tournevis 3/8" pour vis TORX™ Tamper Resistant



**7409TORX-R**

TR 27	5	7409TORX-R-T27
TR 30	5	7409TORX-R-T30

TR 40	5	7409TORX-R-T40
TR 45	5	7409TORX-R-T45
TR 50	5	7409TORX-R-T50
TR 27	1	SB7409TORX-R-T27
TR 30	1	SB7409TORX-R-T30
TR 40	1	SB7409TORX-R-T40
TR 45	1	SB7409TORX-R-T45
TR 50	1	SB7409TORX-R-T50

SB : Conditionnement détail sur carte plastique

Jeu de 5 douilles vis 3/8 TORX™ Tamper Resistant, Sur réglette rail-187



**7409TORX-TRR/**

5	25 x 55 x 190 mm	1	7409TORX-TRR/S5

7409TORX-R-T40, 7409TORX-R-T30, 7409TORX-R-T27, 7409TORX-R-T50, 7409TORX-R-T45		

Douille tournevis 3/8" pour vis TORX™ Série longue



**7409TORX-L**

T25	5	7409TORX-T25-L
T30	5	7409TORX-T30-L
T40	5	7409TORX-T40-L
T45	5	7409TORX-T45-L
T50	5	7409TORX-T50-L
T25	1	SB7409TORX-T25-L
T30	1	SB7409TORX-T30-L
T40	1	SB7409TORX-T40-L
T45	1	SB7409TORX-T45-L
T50	1	SB7409TORX-T50-L

SB : Conditionnement détail sur carte plastique



Douille tournevis 3/8" pour vis 6 pans creux  
Série courte, métrique



### 7409M

3	5	7409M-3		
4	5	7409M-4		
5	5	7409M-5		
6	5	7409M-6		
7	5	7409M-7		
8	5	7409M-8		
10	5	7409M-10		
3	1	SB7409M-3		
4	1	SB7409M-4		
5	1	SB7409M-5		
6	1	SB7409M-6		
7	1	SB7409M-7		
8	1	SB7409M-8		
10	1	SB7409M-10		

SB : Conditionnement détail sur carte plastique

Douille tournevis 3/8" pour vis 6 pans creux,  
tête sphérique



### 7409BH

4	5	7409BH-4		
5	1	7409BH-5		
6	5	7409BH-6		
8	5	7409BH-8		
10	5	7409BH-10		
4	1	SB7409BH-4		
5	1	SB7409BH-5		
6	1	SB7409BH-6		
8	1	SB7409BH-8		
10	1	SB7409BH-10		

SB : Conditionnement détail sur carte plastique

Douille tournevis 3/8", 6 pans, pouce  
en pouces



### 7409Z

1/8 in	47 mm	1	7409Z-1/8
5/32 in	47 mm	1	7409Z-5/32
3/16 in	47 mm	1	7409Z-3/16
7/32 in	47 mm	1	7409Z-7/32
1/4 in	47 mm	1	7409Z-1/4
3/8 in	50.5 mm	1	7409Z-3/8

Jeu de 7 douilles 3/8", ref. 7409M  
Sur réglette rail-187



### 7409MR/

7	25 x 55 x 190 mm	1	7409MR/S7

7409M-3, 7409M-4, 7409M-10, 7409M-8,  
7409M-7, 7409M-6, 7409M-5

Adaptateur à cliquet réversible 3/8



### 7751

55 mm	175	10	7751

Jeu de pièces de rechange pour cliquet 3/8" 7755



### 7755-SO/1

6	7755-3/8	1	7755-SO/1

Jeu de pièces de rechange pour cliquet 3/8" 7750



### 7750-SPARE

11	7750	1	7750-SPARE

Jeu de pièces de rechange pour cliquet 3/8" 7750RN



### 7750RN-SPARE

6	7750RN	1	7750RN-SPARE

Jeu de pièces de rechange pour cliquet 3/8"



**7710-SO/1**

8	7710	1 7710-SO/1

Kit pièces détachées pour cliquet 3/8" 7750 SL



**7750SL-SPARE**

12	7750SL	1 7750SL-SPARE

Jeu de 13 douilles 3/8"



**7420RE**

50 x 115 x 312 mm	1 7420RE

7755-3/8	
7400SM-11, 7400SM-10, 7400SM-8, 7400SM-17, 7400SM-18, 7400SM-19, 7400SM-15, 7400SM-14, 7400SM-13, 7400SM-12, 7400SM-16	
7761	

Coffret de douilles 1/4"-1/2" et embouts, 79 pcs



**SL79**

100 x 215 x 370 mm	4 SL79

Coffret de douilles 1/4"-1/2" et embouts, 79 pcs



**SW79**

100 x 215 x 370 mm	4 SW79

Jeu de 15 douilles 3/8"



**7440ME**

57 x 205 x 278 mm	1 7440ME

7400SM-11, 7400SM-10, 7400SM-15, 7400SM-14, 7400SM-13, 7400SM-12, 7400SM-7, 7400SM-6, 7400SM-9, 7400SM-8, 7400SM-17, 7400SM-19	
---	--

7758	
7755-3/8	
7761	

Coffret de douilles 1/4"-3/8" et embouts, 91 pcs



**SL91**

100 x 215 x 370 mm	4 SL91

Coffret de douilles 1/4"-3/8" et embouts, 91 pcs



**SW91**

100 x 215 x 370 mm	4 SW91









Jeu de 16 douilles 3/8"



**7430GE**

 50 x 115 x 312 mm   1 7430GE









7754	
7762	
7400SM-7, 7400SM-6, 7400SM-11, 7400SM-10, 7400SM-15, 7400SM-14, 7400SM-13, 7400SM-12, 7400SM-9, 7400SM-8, 7400SM-17, 7400SM-19	 
7761	
7766	
7755-3/8	

Jeu de 22 douilles 3/8"  
12 pans, métrique



**A7435DME**

 40 x 150 x 500 mm   1 A7435DME





A7400DM-12, A7400DM-13, A7400DM-10, A7400DM-11, A7400DM-9, A7400DM-16, A7400DM-17, A7400DM-14, A7400DM-15, A7400DM-22, A7400DM-20, A7400DM-21, A7400DM-18, A7400DM-19	 
7755-3/8	
7754	
7760, 7762	
7758	
7752	
7761	
7766	

Jeu de 14 douilles 3/8"  
12 pans, Pouches



**A7440DZE**

 50 x 115 x 312 mm   1 A7440DZE





A7400DZ-1/4, A7400DZ-5/16, A7400DZ-3/8, A7400DZ-7/16, A7400DZ-1/2, A7400DZ-9/16, A7400DZ-3/4, A7400DZ-13/16, A7400DZ-7/8, A7400DZ-5/8, A7400DZ-11/16	 
7755-3/8	
7758	
7761	

Jeu de 17 douilles 3/8"  
Douilles 12 pans, métrique



**A7440DME**

 50 x 115 x 312 mm   1 A7440DME







7755-3/8	
7758	
7761	
A7400DM-9, A7400DM-12, A7400DM-13, A7400DM-14, A7400DM-15, A7400DM-16, A7400DM-17, A7400DM-10, A7400DM-11, A7400DM-22, A7400DM-20, A7400DM-21, A7400DM-18, A7400DM-19	 

Jeu de 22 douilles 3/8"  
Douilles 12 pans, métrique



**7422MBR**

 60 x 220 x 280 mm   1 7422MBR







A7400DM-6, A7400DM-7, A7400DM-8, A7400DM-9, A7400DM-10, A7400DM-11, A7400DM-12, A7400DM-13, A7400DM-14, A7400DM-15, A7400DM-16, A7400DM-17, A7400DM-18, A7400DM-19, A7400DM-20, A7400DM-21, A7400DM-22	 
7750RN	
7760, 7762	
7754	
7766	

Jeu de 22 douilles 3/8"  
Douilles 6 pans, métrique



**7422MHR**

 50 x 160 x 350 mm   1 7422MHR

7400SM-6, 7400SM-7, 7400SM-8, 7400SM-9, 7400SM-10, 7400SM-11, 7400SM-12, 7400SM-13, 7400SM-14, 7400SM-15, 7400SM-16, 7400SM-17, 7400SM-18, 7400SM-19, 7400SM-20, 7400SM-21, 7400SM-22	 
7750RN	
7760, 7762	
7754	
7766	



















Jeu de 13 douilles 3/8  
Douilles 12 pans, Pouces



**A7535DZE**

 165 x 500 x 45 mm
  1 A7535DZE





















A7400DZ-1/2, A7400DZ-17/32, A7400DZ-1/4, A7400DZ-3/4, A7400DZ-13/16, A7400DZ-19/32, A7400DZ-11/16, A7400DZ-3/8, A7400DZ-7/16, A7400DZ-5/16, A7400DZ-7/8, A7400DZ-9/16, A7400DZ-5/8		
7755-3/8		
7754		
7760		
7766		
7758		
7752		
7762		

Jeu de douilles 3/8, 34 pièces



**7429JDE**

 38 x 150 x 490 mm
  1 7429JDE

A7400DM-6, A7400DM-7, A7400DM-8, A7400DM-9, A7400DM-10, A7400DM-11, A7400DM-12, A7400DM-13, A7400DM-14, A7400DM-15, A7400DM-16, A7400DM-17, A7400DM-18, A7400DM-19, A7400DM-20, A7400DM-21, A7400DM-22		
7755-3/8		
7754		
7760		
7757		
7407H		
7766		
7409PH-1, 7409PH-2, 7409PH-3		
7409F-6.5, 7409F-8		
7409M-3, 7409M-4, 7409M-5, 7409M-6, 7409M-8		

Jeu de douilles longues 3/8", 14 pièces



**S1214L**

 49 x 152 x 280 mm
  10 S1214L

Jeu de douilles 1/4 et 3/8  
34 pièces



**S330**

 70 x 160 x 280 mm
  6 S330

Jeu de douilles 1/4 et 3/8  
34 pièces, Pouces



**S330AF**

 70 x 160 x 280 mm
  6 S330AF

Jeu de douilles 1/4 et 3/8, 53 pièces



**S330L**

 100 x 215 x 375 mm
  4 S330L

Jeu de douilles 3/8  
38 pièces



**S380**

 100 x 215 x 375 mm
  4 S380



Jeu de douilles à lame traversante, 14 pièces



**S140T**



65 x 160 x 280 mm

1 S140T

Kit avec cliquet traversant, 3 pièces



**S140T-R**



121 x 280 x 220 mm

10 S140T-R

1RMA-19-1/2-SQ

Jeu de douilles à lames traversantes, 53 pièces



**S530T**



90 x 205 x 370 mm

4 S530T

Coffret de douilles 3/8" avec cliquet fin



**SL34**



280 mm

160 mm

6 SL34

Jeu de 12 douilles 3/8"  
Sur réglette rail-264



**7400SR/**



12

35 x 220 x 25 mm

1 7400SR/S12

7400SM-11, 7400SM-10, 7400SM-15,  
7400SM-14, 7400SM-13, 7400SM-12,  
7400SM-16, 7400SM-9, 7400SM-8,  
7400SM-17, 7400SM-19, 7400SM-18

Jeu de 9 douilles 3/8", Sur réglette



**7409MB**



9

1 7409MB

A7400DM-7, A7400DM-10,  
A7400DM-11, A7400DM-19,  
A7400DM-17, A7400DM-15,  
A7400DM-8, A7400DM-13,  
A7400DM-22

Jeu de 8 douilles 3/8" Sur réglette



**7408MD**



8

1 7408MD

A7402DM-10, A7402DM-8,  
A7402DM-11, A7402DM-12,  
A7402DM-13, A7402DM-14,  
A7402DM-17, A7402DM-19

Jeu de douilles 3/8, 7 pièces  
Sur réglette rail-264



**7400TORX-ER/**



7

25 x 55 x 190 mm

1 7400TORX-ER/S7

7400TORX-E14, 7400TORX-E12,  
7400TORX-E11, 7400TORX-E10,  
7400TORX-E18, 7400TORX-E16,  
7400TORX-E8

1/2"

Douille 1/2  
6 pans, mm



**7800SM**

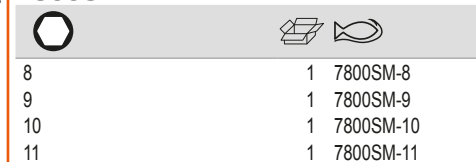

8

1 7800SM-8

9

1 7800SM-9

10

1 7800SM-10

11

1 7800SM-11

12	10	7800SM-12	
13	1	7800SM-13	
14	1	7800SM-14	
15	1	7800SM-15	
16	1	7800SM-16	
17	1	7800SM-17	
18	1	7800SM-18	
19	1	7800SM-19	
20	1	7800SM-20	
21	1	7800SM-21	
22	1	7800SM-22	
23	1	7800SM-23	
24	1	7800SM-24	
25	1	7800SM-25	
26	1	7800SM-26	
27	1	7800SM-27	
28	1	7800SM-28	
29	1	7800SM-29	
30	1	7800SM-30	
32	1	7800SM-32	
33	1	7800SM-33	
34	1	7800SM-34	
36	1	7800SM-36	
8	1	SB7800SM-8	
9	1	SB7800SM-9	
10	1	SB7800SM-10	
11	1	SB7800SM-11	
12	1	SB7800SM-12	
13	1	SB7800SM-13	
14	1	SB7800SM-14	
15	1	SB7800SM-15	
16	1	SB7800SM-16	
17	1	SB7800SM-17	
18	1	SB7800SM-18	
19	1	SB7800SM-19	
21	1	SB7800SM-20	
21	1	SB7800SM-21	
22	1	SB7800SM-22	
23	1	SB7800SM-23	
24	1	SB7800SM-24	
25	1	SB7800SM-25	
26	1	SB7800SM-26	
27	1	SB7800SM-27	
28	1	SB7800SM-28	
29	1	SB7800SM-29	
30	1	SB7800SM-30	
32	1	SB7800SM-32	
33	1	SB7800SM-33	
34	1	SB7800SM-34	
36	1	SB7800SM-36	

SB : Conditionnement détail sur carte plastique

Douille longue 1/2  
6 pans, mm



**7805SM**

10	1	7805SM-10	
12	1	7805SM-12	

13	1	7805SM-13	
14	1	7805SM-14	
15	1	7805SM-15	
16	1	7805SM-16	
17	1	7805SM-17	
18	1	7805SM-18	
19	1	7805SM-19	
20	1	7805SM-20	
21	1	7805SM-21	
22	1	7805SM-22	
23	1	7805SM-23	
24	1	7805SM-24	
25	1	7805SM-25	
26	1	7805SM-26	
27	1	7805SM-27	
28	1	7805SM-28	
29	1	7805SM-29	
30	1	7805SM-30	
32	1	7805SM-32	
10	1	SB7805SM-10	
12	1	SB7805SM-12	
13	1	SB7805SM-13	
14	1	SB7805SM-14	
15	1	SB7805SM-15	
16	1	SB7805SM-16	
17	1	SB7805SM-17	
18	1	SB7805SM-18	
19	1	SB7805SM-19	
21	1	SB7805SM-21	
22	1	SB7805SM-22	
23	1	SB7805SM-23	
24	1	SB7805SM-24	
26	1	SB7805SM-26	
27	1	SB7805SM-27	
30	1	SB7805SM-30	
32	1	SB7805SM-32	

SB : Conditionnement détail sur carte plastique

Douille longue 1/2"  
6 pans



**7805SZ**

1.3/16 in	1	7805SZ-1.3/16	
1.1/4 in	1	7805SZ-1.1/4	
1.5/16 in	1	7805SZ-1.5/16	
1.3/8 in	1	7805SZ-1.3/8	
1.7/16 in	1	7805SZ-1.7/16	
1.1/2 in	1	7805SZ-1.1/2	

Douille 1/2  
12 pans, mm



**7800DM**

8	1	7800DM-8	
9	1	7800DM-9	
10	1	7800DM-10	
11	1	7800DM-11	
12	1	7800DM-12	
13	1	7800DM-13	
14	1	7800DM-14	
15	1	7800DM-15	
16	1	7800DM-16	
17	1	7800DM-17	
18	1	7800DM-18	
19	1	7800DM-19	
20	1	7800DM-20	
21	1	7800DM-21	
22	1	7800DM-22	
23	1	7800DM-23	
24	1	7800DM-24	
25	1	7800DM-25	
26	1	7800DM-26	
27	1	7800DM-27	
28	1	7800DM-28	
29	1	7800DM-29	
30	1	7800DM-30	
31	1	7800DM-31	
32	1	7800DM-32	
31	1	7800DM-33	
31	1	7800DM-34	
36	1	7800DM-36	
8	1	SB7800DM-8	
9	1	SB7800DM-9	
10	1	SB7800DM-10	
11	1	SB7800DM-11	
12	1	SB7800DM-12	
13	1	SB7800DM-13	
14	1	SB7800DM-14	
15	1	SB7800DM-15	
16	1	SB7800DM-16	
17	1	SB7800DM-17	
18	1	SB7800DM-18	
19	1	SB7800DM-19	
21	1	SB7800DM-20	
21	1	SB7800DM-21	
22	1	SB7800DM-22	
23	1	SB7800DM-23	
24	1	SB7800DM-24	
25	1	SB7800DM-25	
26	1	SB7800DM-26	
27	1	SB7800DM-27	
28	1	SB7800DM-28	
29	1	SB7800DM-29	
30	1	SB7800DM-30	
31	1	SB7800DM-31	
32	1	SB7800DM-32	
36	1	SB7800DM-36	



SB : Conditionnement détail sur carte plastique



Douille 1/2  
12 pans, Pouces



### 7800DZ



 	
5/16 in	1 7800DZ-5/16
11/32 in	1 7800DZ-11/32
3/8	1 7800DZ-3/8
13/32 in	1 7800DZ-13/32
7/16	1 7800DZ-7/16
1/2	1 7800DZ-1/2
9/16	1 7800DZ-9/16
19/32	1 7800DZ-19/32
5/8	1 7800DZ-5/8
11/16	1 7800DZ-11/16
3/4	1 7800DZ-3/4
25/32	1 7800DZ-25/32
13/16	1 7800DZ-13/16
7/8	1 7800DZ-7/8
15/16	1 7800DZ-15/16
1	1 7800DZ-1
1 1/16	1 7800DZ-1.1/16
1 1/8	1 7800DZ-1.1/8
1 3/16	1 7800DZ-1.3/16
1 1/4	1 7800DZ-1.1/4
1.5/16 in	1 7800DZ-1.5/16
1.3/8 in	1 7800DZ-1.3/8
1.7/16 in	1 7800DZ-1.7/16
1.1/2 in	1 7800DZ-1.1/2
3/8	1 SB7800DZ-3/8
7/16	1 SB7800DZ-7/16
1/2	1 SB7800DZ-1/2
9/16	1 SB7800DZ-9/16
19/32	1 SB7800DZ-19/32
5/8	1 SB7800DZ-5/8
11/16	1 SB7800DZ-11/16
3/4	1 SB7800DZ-3/4
25/32	1 SB7800DZ-25/32
13/16	1 SB7800DZ-13/16
7/8	1 SB7800DZ-7/8
15/16	1 SB7800DZ-15/16
1	1 SB7800DZ-1
1.1/16	1 SB7800DZ-1.1/16
1.1/8	1 SB7800DZ-1.1/8
1.3/16	1 SB7800DZ-1.3/16
1.1/4	1 SB7800DZ-1.1/4
1 5/16 in	1 SB7800DZ-1.5/16

SB : Conditionnement détail sur carte plastique

Douille longue 1/2  
12 pans, mm



### 7805DM



 	
10	1 7805DM-10
12	1 7805DM-12
13	1 7805DM-13
14	1 7805DM-14
15	1 7805DM-15
16	1 7805DM-16
17	1 7805DM-17
18	1 7805DM-18
19	1 7805DM-19
21	1 7805DM-21
22	1 7805DM-22
23	1 7805DM-23
24	1 7805DM-24
26	1 7805DM-26
27	1 7805DM-27
30	1 7805DM-30
32	1 7805DM-32
10	1 SB7805DM-10
12	1 SB7805DM-12
13	1 SB7805DM-13
14	1 SB7805DM-14
15	1 SB7805DM-15
16	1 SB7805DM-16
17	1 SB7805DM-17
18	1 SB7805DM-18
19	1 SB7805DM-19
21	1 SB7805DM-21
22	1 SB7805DM-22
23	1 SB7805DM-23
24	1 SB7805DM-24
26	1 SB7805DM-26
27	1 SB7805DM-27
30	1 SB7805DM-30
32	1 SB7805DM-32



SB : Conditionnement détail sur carte plastique

Douille longue 1/2"  
12 pans



### 7805DZ



 	
5/8 in	1 7805DZ-5/8
11/16 in	1 7805DZ-11/16
3/4 in	1 7805DZ-3/4
13/16 in	1 7805DZ-13/16
7/8 in	1 7805DZ-7/8

 	
15/16 in	1 7805DZ-15/16
1 in	1 7805DZ-1
1.1/16 in	1 7805DZ-1.1/16
1.1/8 in	1 7805DZ-1.1/8
1.13/16 in	1 7805DZ-1.13/16
1.1/4 in	1 7805DZ-1.1/4
1.5/16 in	1 7805DZ-1.5/16
1.3/8 in	1 7805DZ-1.3/8
1.7/16 in	1 7805DZ-1.7/16
1.1/2 in	1 7805DZ-1.1/2

Douille 1/2 TORX-E  
Pour tournevis TORX-E



### 7800TORX-E

 	
E8	1 7800TORX-E8
E10	1 7800TORX-E10
E11	1 7800TORX-E11
E12	1 7800TORX-E12
E14	1 7800TORX-E14
E16	1 7800TORX-E16
E18	1 7800TORX-E18
E20	1 7800TORX-E20
E24	1 7800TORX-E24
E8	1 SB7800TORX-E8
E10	1 SB7800TORX-E10
E11	1 SB7800TORX-E11
E12	1 SB7800TORX-E12
E14	1 SB7800TORX-E14
E16	1 SB7800TORX-E16
E18	1 SB7800TORX-E18
E20	1 SB7800TORX-E20
E24	1 SB7800TORX-E24

SB : Conditionnement détail sur carte plastique

Vilebrequin 1/2 avec poignée rotative en acier



### 8152-1/2

 	
425	1 8152-1/2

Poignée articulée 1/2



**8157**

L	Q	Ref
257 mm	20	8157-10
390 mm	1	8157-15
600 mm	1	8157-24
900 mm	10	8157-36
257 mm	1	SB8157-10
390 mm	1	SB8157-15
600 mm	1	SB8157-24
900 mm	1	SB8157-36

Poignée articulée 1/2



**8158**

L	Q	Ref
270	1	SBS87S
390	1	SBS87

Rallonge coudée 1/2



**8167-1/2**

L	Q	Ref
210	1	8167-1/2

Poignée coulissante en T 1/2



**8154**

L	Q	Ref
280 mm	1	8154-11
280 mm	1	SB8154-11

Rallonge 1/2"



**8160**

L	Q	Ref
88 mm	1	8160-3
125 mm	10	8160-5
250 mm	10	8160-10
88 mm	1	SB8160-3
125 mm	1	SB8160-5
250 mm	1	SB8160-10

Rallonge angulaire 1/2



**8159-W - 8162-W**

L	Q	Ref
75	1	8159-W
125	1	8160-W
250	10	8162-W

Rallonge 1/2" avec système de blocage



**8160-B**

L	Q	Ref
125	1	8160-B

Cardan universel 1/2



**8166**

L	Q	Ref
72 mm	10	8166
72 mm	1	SB8166

Joint de cardan universel 1/2, fonctionnement optimal



**8168**

L	Q	Ref
62	1	8168

Réducteur pour carré conducteur 1/2 et douille 3/8



**8171**

1/2"	3/8"	Q	Ref
1/2"	3/8"	10	8171
1/2"	3/8"	1	SB8171

Clé de montage étagée  
5 mesures différentes: 3/8"-7/16"-1/2"-3/4"-1"



**8195-key**

g	Q	Ref
140	50	8195-KEY

A utiliser avec 8195-R



Augmentateur pour carré conducteur 1/2 et douille 3/4



**8172**

			10 8172
1/2"	3/4"		1 SB8172

Adaptateur magnétique pour carré conducteur 1/2 et douille 3/4



**8967**

			1 8967
1/2"	3/4"		

Adaptateur 1/2" pour embouts 5/16"



**7106S**

		1 7106S
5/16 in		

Adaptateur 1/2" pour embouts 5/16"



**7809HL**

		1 7809HL
5/16 in		

Jeu de pièces détachées pour poignées articulées 1/2" codes 8169-1/2, 8156-1/2, 8158-1/2 depuis 2016. Fileté



**SP120**

		1 SP120
75		

Jeu de pièces détachées pour poignée articulée 1/2" code 8170-1/2



**SP120XL**

		1 SP120XL
55		

Support de douilles et douilles tournevis 1/2



**C1/2**

		25 CLIPS-1/2
19		

Douille tournevis 1/2 pour vis à fente



**7809F**

			5 7809F-8
1	10		5 7809F-10

Douille tournevis 1/2 pour vis PHILLIPS®



**7809PH**

		1 7809PH-2
		1 7809PH-3
		1 7809PH-4

Douille tournevis 1/2 pour vis POZIDRIV®



**7809PZ**

		1 7809PZ-2
		1 7809PZ-3

### Douille tournevis 1/2 pour vis TORX®



#### 7809TORX

T20	1	7809TORX-T20	
T25	1	7809TORX-T25	
T27	1	7809TORX-T27	
T30	1	7809TORX-T30	
T40	1	7809TORX-T40	
T45	1	7809TORX-T45	
T50	1	7809TORX-T50	
T55	1	7809TORX-T55	
T60	1	7809TORX-T60	
T20	1	SB7809TORX-T20	
T25	1	SB7809TORX-T25	
T27	1	SB7809TORX-T27	
T30	1	SB7809TORX-T30	
T40	1	SB7809TORX-T40	
T45	1	SB7809TORX-T45	
T50	1	SB7809TORX-T50	
T55	1	SB7809TORX-T55	
T60	1	SB7809TORX-T60	

SB : Conditionnement détail sur carte plastique

### Douille tournevis 1/2" longue pour vis TORX®



#### 7809TORX

T40	82	5	7809TORX-T40-120
T45	80	1	7809TORX-T45-120
T50	62	5	7809TORX-T50-100
T55	102	5	7809TORX-T55-140
T70	102	5	7809TORX-T70-140

### Jeu de douilles tournevis 1/2 pour vis TORX Sur réglette, 9 pièces



#### 7809TO

9		1	7809TO

7809TORX-T27, 7809TORX-T20,  
7809TORX-T25, 7809TORX-T30,  
7809TORX-T50, 7809TORX-T40,  
7809TORX-T45, 7809TORX-T60,  
7809TORX-T55



### Douille tournevis 1/2" pour vis 6 pans creux mm



#### 7809M

4		1	7809M-4
5		1	7809M-5
6		1	7809M-6
7		1	7809M-7
8		1	7809M-8
9		1	7809M-9
10		1	7809M-10
12		1	7809M-12
14		1	7809M-14
17		1	7809M-17
19		1	7809M-19
4 mm		1	SB7809M-4
5		1	SB7809M-5
6		1	SB7809M-6
7		1	SB7809M-7
8		1	SB7809M-8
9		1	SB7809M-9
10		1	SB7809M-10
12		1	SB7809M-12
14		1	SB7809M-14
17		1	SB7809M-17
19		1	SB7809M-19

SB : Conditionnement détail sur carte plastique

### Douille tournevis 1/2" longue pour vis 6 pans Métrique



#### 7809M

5 mm	61	1	7809M-5-100
5	143	1	7809M-5-180

6 mm	59	1	7809M-6-100
6	103	1	7809M-6-140
7	63	1	7809M-7-100
8	83	1	7809M-8-120
10	103	1	7809M-10-140
5 mm	63	1	SB7809M-5-100
5	140	1	SB7809M-5-180
6 mm	62	1	SB7809M-6-100
6	103	1	SB7809M-6-140
7	63	1	SB7809M-7-100
8	81	1	SB7809M-8-120
10	101	1	SB7809M-10-140

### Pour vis 6 pans creux



#### 7808HM

8		1	7808HM

7809M-4, 7809M-6, 7809M-8, 7809M-7,  
7809M-5, 7809M-10, 7809M-12,  
7809M-14

### Douille tournevis 1/2 pour vis 6 pans creux en pouces



#### 7809Z

3/16		1	7809Z-3/16
1/4		1	7809Z-1/4
5/16		1	7809Z-5/16
3/8		1	7809Z-3/8
7/16		1	7809Z-7/16
1/2		1	7809Z-1/2
17/32		1	7809Z-17/32
9/16		1	7809Z-9/16
19/32		1	7809Z-19/32
5/8		1	7809Z-5/8



Douille tournevis 1/2 pour vis à denture multiple XZN



**7809XZN**

6	1	7809XZN-6	
8	1	7809XZN-8	
8	1	7809XZN-8-100	
10	1	7809XZN-10	
10	1	7809XZN-10-100	
12	1	7809XZN-12	
12	1	7809XZN-12-100	
14	1	7809XZN-14	
14	1	7809XZN-14-100	
16	1	7809XZN-16	
18	1	7809XZN-18	

Cliquet réversible 1/2  
80 dents, étanche, angle de débattement 4.5°



**8150-1/2**

269	80	1	8150-1/2
269	80	1	SB8150-1/2

Cliquet à tête pivotante



**8120-1/2**

266 mm	72	12	8120-1/2

Cliquet réversible 1/2  
Flèche de changement de sens, Breveté



**8150RN-1/2**

267	72	1	8150RN-1/2
267	72	1	SB8150RN-1/2

Cliquet réversible 1/2



**8193-1/2**

253	48	1	8193-1/2

Cliquet réversible Ergo™



**8155-1/2**

262	60	1	8155-1/2
262	60	1	SB8155-1/2

Cliquet réversible 1/2  
60 dents, angle de débattement 6°



**SBS81**

250	60	5	SBS81

Cliquet réversible 1/2"



**8195-R**

260 mm	60	1	8195-R

Cliquet réversible 1/2, 72 dents, /angle de débattement 5°  
Tête fine pour espaces étroits



**8150SL**

264	72	1	8150SL

Cliquet réversible 1/2

Cliquet réversible 1/2  
60 dents, angle de débattement 6°



**SBS82**

252	60	1	SBS82



Jeu de cliquet pour vanne de radiateur



**8195-SET**





350 x 20 x 80 mm		5	8195-SET



8195-R	
8195-SQ	
8195-KEY	





Cliquet réversible articulé 1/2



<b>8110-1/2</b>				
424	60	1	8110-1/2	
424	60	1	SB8110-1/2	



Cliquet articulé 1/2



<b>8110H-1/2</b>				
440	32	1	8110H-1/2	





Carré conducteur pour cliquet 8193-1/2



<b>8194-1/2</b>			
32		1	8194-1/2



Carré mâle pour cliquet 8195-R



<b>8195-SQ</b>				
37.5 mm	40	25	8195-SQ	





Adaptateur cliquet 1/2



<b>8151-1/2</b>			
71		1	8151-1/2





Jeu de pièces détachées pour cliquet 1/2 8155-1/2  
6 pièces



<b>8155-SO/1</b>				
6		8155-1/2	1	8155-SO/1





Jeu de pièces détachées pour cliquet 1/2" 8150



<b>8150-1/2-SPARE</b>				
11		8150-1/2	1	8150-1/2-SPARE

Jeu de pièces détachées pour cliquet 1/2" 8150RN-1/2



<b>8150RN-1/2-SPARE</b>				
6		8150RN-1/2	1	8150RN-1/2-SPARE





Jeu de pièces détachées pour cliquet 1/2 8150SL



<b>8150SL-SPARE</b>				
12		8150SL	1	8150SL-SPARE



Jeu de pièces de rechange pour cliquet 1/2 8110



<b>8110-SO/1</b>				
8		8110-1/2	1	8110-SO/1

Jeu de pièces détachées pour poignée articulée 1/2  
SBS87  
Et 8156-1/2, 8158-1/2 jusqu'à 2016



<b>8158-SO/1</b>			
70		1	8158-SO/1



Jeu de douilles tournevis 1/2" 6 pans, 10 pièces  
Boîte en plastique



### 7809M/10

45 x 110 x 255 mm 1 7809M/10

7809M-5, 7809M-6, 7809M-7, 7809M-8,  
7809M-9, 7809M-10, 7809M-12, 7809M-  
14, 7809M-17, 7809M-19

Jeu de douilles tournevis pour vis TORX® et  
PHILLIPS®, 10 pièces  
Coffret métallique



### 7809TORX/10

45 x 110 x 255 mm 1 7809TORX/10

7809TORX-T20, 7809TORX-T27,  
7809TORX-T25, 7809TORX-T40,  
7809TORX-T30, 7809TORX-T45,  
7809TORX-T50, 7809TORX-T55

7809M-6, 7809M-8

Jeu de douilles tournevis pour vis 6 pans creux, 10  
pièces



### 7809Z/10

45 x 110 x 255 mm 1 7809Z/10

7809Z-3/8, 7809Z-5/16, 7809Z-7/16,  
7809Z-1/4, 7809Z-19/32, 7809Z-5/8,  
7809Z-17/32, 7809Z-9/16, 7809Z-1/2,  
7809Z-3/16

Jeu de douilles 1/2, 10 pièces  
Coffret métallique



### 7819SRE

60 x 115 x 280 mm 1 7819SRE

7800SM-17, 7800SM-22, 7800SM-19,  
7800SM-24, 7800SM-10, 7800SM-11,  
7800SM-12, 7800SM-13

8160-1/2

8155-1/2

Coffret de douilles 1/2", 14 pièces  
Coffret métallique



### 7814DS

60 x 185 x 445 mm 1 7814DS

7800DM-10, 7800DM-11, 7800DM-12,  
7800DM-13, 7800DM-14, 7800DM-15,  
7800DM-16, 7800DM-17, 7800DM-18,  
7800DM-19

8150SL

8160-1/2, 8162-1/2

8166-1/2

Jeu de douilles 1/2", 18 pcs  
Coffret métallique



### 7818DS

60 x 185 x 445 mm 1 7818DS

7800DM-8, 7800DM-10, 7800DM-11,  
7800DM-12, 7800DM-13, 7800DM-14,  
7800DM-15, 7800DM-16, 7800DM-17,  
7800DM-18, 7800DM-19, 7800DM-21,  
7800DM-22

8150SL

8160-1/2, 8162-1/2

8166-1/2







8154-1/2

Jeu de douilles 1/2", 18 pièces  
6 pans, mm



**7818MHR**

 50 x 185 x 445 mm   1 7818MHR







- 7800SM-10, 7800SM-11, 7800SM-12, 7800SM-13, 7800SM-14, 7800SM-15, 7800SM-17, 7800SM-19, 7800SM-22, 7800SM-24, 7800SM-27, 7800SM-30, 7800SM-32  
- 8150RN-1/2 
- 8160-1/2, 8162-1/2 
- 8154-1/2 
- 8166-1/2 

Jeu de douilles 1/2", 25 pièces  
6 pans, mm



**7825MHP**

 60 x 185 x 445 mm   1 7825MHP







- 7800SM-10, 7800SM-11, 7800SM-12, 7800SM-13, 7800SM-14, 7800SM-15, 7800SM-16, 7800SM-17, 7800SM-18, 7800SM-19, 7800SM-20, 7800SM-21, 7800SM-22, 7800SM-23, 7800SM-24, 7800SM-26, 7800SM-27, 7800SM-28, 7800SM-30, 7800SM-32  
- 8160-1/2, 8162-1/2 
- 8154-1/2 
- 8166-1/2 
- 8150-1/2 

Jeu de douilles 1/2", 25 pièces  
12 pans, mm



**7825MBP**

 60 x 185 x 445 mm   1 7825MBP









- 7800DM-10, 7800DM-11, 7800DM-12, 7800DM-13, 7800DM-14, 7800DM-15, 7800DM-16, 7800DM-17, 7800DM-18, 7800DM-19, 7800DM-20, 7800DM-21, 7800DM-22, 7800DM-23, 7800DM-24, 7800DM-26, 7800DM-27, 7800DM-28, 7800DM-30, 7800DM-32  
- 8150-1/2 
- 8160-1/2, 8162-1/2 
- 8154-1/2 
- 8166-1/2 

Jeu de douilles 1/2", 25 pièces  
Coffret métallique



**7819DRN**

 51 x 225 x 445 mm   1 7819DRN







- 7800DM-19, 7800DM-18, 7800DM-17, 7800DM-16, 7800DM-23, 7800DM-22, 7800DM-21, 7800DM-11, 7800DM-10, 7800DM-15, 7800DM-13, 7800DM-14, 7800DM-12, 7800DM-24, 7800DM-26, 7800DM-27, 7800DM-28, 7800DM-30, 7800DM-32  
- 8150RN-1/2 
- 8152-1/2 
- 8162-1/2 
- 8154-1/2 
- 8160-1/2 
- 8166-1/2 

Jeu de douilles 1/2", 25 pièces  
Coffret métallique



**7888DM**

 73 x 340 x 445 mm   1 7888DM







- 7800DM-10, 7800DM-11, 7800DM-12, 7800DM-13, 7800DM-14, 7800DM-15, 7800DM-16, 7800DM-17, 7800DM-18, 7800DM-19, 7800DM-20, 7800DM-21, 7800DM-22, 7800DM-23, 7800DM-24, 7800DM-26, 7800DM-27, 7800DM-28, 7800DM-30, 7800DM-32  
- 8150-1/2 
- 8154-1/2 
- 8159-1/2, 8160-1/2, 8162-1/2 
- 8166-1/2 
- 8158-1/2 

Coffret de douilles 1/2", 23 pièces  
Coffret métallique



**7823SE**

 60 x 185 x 445 mm   1 7823SE

- 7800SM-10, 7800SM-11, 7800SM-12, 7800SM-13, 7800SM-14, 7800SM-15, 7800SM-17, 7800SM-19, 7800SM-22, 7800SM-24, 7800SM-27, 7800SM-30  
- 7809M-5, 7809M-6, 7809M-7, 7809M-8, 7809M-10, 7809M-12, 7809M-14 
- 8155-1/2 
- 8162-1/2 
- 8154-1/2 
- 8166-1/2 



Jeu de douilles 1/4" et 1/2", 47 pcs  
Coffret métallique



### 7847SS

60 x 225 x 445 mm 1 7847SS

6700SM-5, 6700SM-6, 6700SM-7, 6700SM-8, 6700SM-9, 6700SM-10, 6700SM-11, 6700SM-12, 6700SM-13		
6950SL		
6960, 6962		
6954		
6966		
6956		
59S/PH1, 59S/PH2, 59S/PH3		
59S/PZ1, 59S/PZ2, 59S/PZ3		
59S/0.6-4.5, 59S/0.8-5.5, 59S/1.2-8.0		
59S/H3, 59S/H4, 59S/H5, 59S/H6		
7800SM-10, 7800SM-11, 7800SM-12, 7800SM-13, 7800SM-14, 7800SM-15, 7800SM-17, 7800SM-19, 7800SM-22, 7800SM-24, 7800SM-27, 7800SM-30, 7800SM-32		
8150SL		
8160-1/2, 8162-1/2		
8154-1/2		
8166-1/2		
6973A		

Jeu de douilles 1/2", AF, 17 pcs  
Coffret métallique



### 7817DZS

60 x 185 x 445 mm 1 7817DZS

7800DZ-3/8, 7800DZ-7/16, 7800DZ-1/2,  
7800DZ-9/16, 7800DZ-5/8, 7800DZ-  
11/16, 7800DZ-3/4, 7800DZ-13/16,  
7800DZ-7/8, 7800DZ-15/16, 7800DZ-1,  
7800DZ-1.1/8, 7800DZ-1.1/4

8150SL  
8160-1/2, 8162-1/2  
8166-1/2

Jeu de douilles 1/2", AF, 23 pcs  
Coffret métallique



### 7823DZS

60 x 185 x 445 mm 1 7823DZS

7800DZ-3/8, 7800DZ-7/16, 7800DZ-1/2,  
7800DZ-9/16, 7800DZ-19/32, 7800DZ-  
5/8, 7800DZ-11/16, 7800DZ-3/4,  
7800DZ-25/32, 7800DZ-13/16, 7800DZ-  
7/8, 7800DZ-15/16, 7800DZ-1, 7800DZ-  
1.1/16, 7800DZ-1.1/8, 7800DZ-1.3/16,  
7800DZ-1.1/4, 7800DZ-1.5/16

8150SL  
8160-1/2, 8162-1/2  
8166-1/2  
8154-1/2

Jeu de douilles 1/2", 14 pcs  
Coffret textile



### 7814DST

60 x 220 x 480 mm 1 7814DST

7800DM-10, 7800DM-11, 7800DM-12,  
7800DM-13, 7800DM-14, 7800DM-15,  
7800DM-16, 7800DM-17, 7800DM-18,  
7800DM-19

8150SL  
8160-1/2, 8162-1/2  
8166-1/2

Coffret de douilles 1/2", 18 pièces  
Pochette textile



### 7818DST

60 x 220 x 480 mm 1 7818DST

7800DM-8, 7800DM-10, 7800DM-11,  
7800DM-12, 7800DM-13, 7800DM-14,  
7800DM-15, 7800DM-16, 7800DM-17,  
7800DM-18, 7800DM-19, 7800DM-21,  
7800DM-22

8150SL  
8160-1/2, 8162-1/2  
8166-1/2  
8154-1/2

Jeu de douilles 1/2", 18 pcs  
Coffret textile



### 7818SST

60 x 220 x 480 mm 1 7818SST

7800SM-10, 7800SM-11, 7800SM-12,  
7800SM-13, 7800SM-14, 7800SM-15,  
7800SM-17, 7800SM-19, 7800SM-22,  
7800SM-24, 7800SM-27, 7800SM-30,  
7800SM-32

8150SL  
8160-1/2, 8162-1/2  
8166-1/2  
8154-1/2

Jeu de douilles 1/2", 25 pcs  
Coffret textile



**7825SST**

65 x 250 x 480 mm	1	7825SST

7800SM-10, 7800SM-11, 7800SM-12, 7800SM-13, 7800SM-14, 7800SM-15, 7800SM-16, 7800SM-17, 7800SM-18, 7800SM-19, 7800SM-20, 7800SM-21, 7800SM-22, 7800SM-23, 7800SM-24, 7800SM-26, 7800SM-27, 7800SM-28, 7800SM-30, 7800SM-32		
8150SL		
8160-1/2, 8162-1/2		
8166-1/2		
8154-1/2		

Jeu de douilles 1/2", 25 pcs  
Coffret textile



**7825DST**

65 x 250 x 480 mm	1	7825DST

7800DM-10, 7800DM-11, 7800DM-12, 7800DM-13, 7800DM-14, 7800DM-15, 7800DM-16, 7800DM-17, 7800DM-18, 7800DM-19, 7800DM-20, 7800DM-21, 7800DM-22, 7800DM-23, 7800DM-24, 7800DM-26, 7800DM-27, 7800DM-28		
8150SL		
8160-1/2, 8162-1/2		
8166-1/2		
8154-1/2		

Jeu de douilles 1/2", 27 pcs  
Coffret textile



**7827DST**

65 x 250 x 480 mm	1	7827DST

7800DM-10, 7800DM-11, 7800DM-12, 7800DM-13, 7800DM-14, 7800DM-15, 7800DM-16, 7800DM-17, 7800DM-18, 7800DM-19, 7800DM-20, 7800DM-21, 7800DM-22, 7800DM-23, 7800DM-24, 7800DM-26, 7800DM-27, 7800DM-28, 7800DM-30, 7800DM-32		
8150SL		
8159-1/2, 8160-1/2, 8162-1/2		
8154-1/2		
8166-1/2		
8158-1/2		

Jeu de douilles 1/2" et porte-embout, 23 pièces  
Coffret textile



**7823DET**

60 x 220 x 480 mm	1	7823DET

7800DM-10, 7800DM-11, 7800DM-12, 7800DM-13, 7800DM-14, 7800DM-15, 7800DM-17, 7800DM-19, 7800DM-22, 7800DM-24, 7800DM-27, 7800DM-30		
7809M-5, 7809M-6, 7809M-7, 7809M-8, 7809M-10, 7809M-12, 7809M-14		
8155-1/2		
8162-1/2		
8154-1/2		
8166-1/2		

Jeu de douilles longues 1/2, 12 pièces



**S1612L**

49 x 152 x 280 mm	4	S1612L

Jeu de douilles 1/2 avec embouts, 9 pièces  
Embouts hexagonaux de 4 à 17 mm



**S9HEX**

46 x 130 x 195 mm	10	S9HEX

Coffret de douilles 1/2" avec embouts TORX, 9 pièces  
Embouts TORX T20 à T60



**S9TORX**

46 x 130 x 195 mm	10	S9TORX



Jeu de douilles 1/2  
24 pièces



**S240**



100 x 215 x 375 mm

4 S240

SBS81



Jeu de douilles 1/2  
23 pièces, Pouces



**S240AF**



100 x 215 x 375 mm

4 S240AF

Jeu combiné de douilles 1/2 et clés mixtes  
40 pièces



**S400**



110 x 320 x 375 mm

2 S400

Jeu combiné de douilles 1/4 et 1/2 et clés mixtes, 103  
pièces



**S103**



110 x 375 x 430 mm

2 S103

Jeu combiné de douilles 1/2 et 1/4 et clés mixtes, 108  
pièces



**S108**



110 x 430 x 375 mm

2 S108

Coffret douilles 81 pcs 1/2 + 1/4" avec outils



**S81MIX**



110 x 430 x 375 mm

2 S81MIX

Jeu de douilles 1/2 avec embouts,  
18 pièces  
Embouts hexagonaux de 4 à 17 mm



**S18HEX**



100 x 210 x 370 mm

4 S18HEX

Jeu de douilles 1/2 et 1/4, 56 pièces  
12 pans



**S560**



100 x 215 x 375 mm

4 S560

Coffret de douilles 1/2" avec embouts TORX,  
18 pièces  
Embouts TORX longs et courts T20 à T60



**S18TORX**



370 mm

210 mm

4 S18TORX

**BAHCO**

Coffret de douilles 1/4" - 1/2", 95 pièces  
Clés mixtes, clés mâles et jeu d'embouts



**S95**

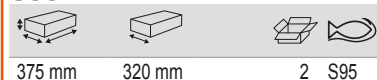

375 mm 320 mm 2 S95

Jeu de 10 douilles 1/2



**7810MH**



10 1 7810MH

7800SM-10, 7800SM-13, 7800SM-11,  
7800SM-14, 7800SM-15, 7800SM-16,  
7800SM-19, 7800SM-17, 7800SM-21,  
7800SM-22

Jeu de 10 douilles 1/2



**7810MB**



10 1 7810MB

7800DM-11, 7800DM-10, 7800DM-14,  
7800DM-13, 7800DM-16, 7800DM-17,  
7800DM-19, 7800DM-22, 7800DM-21,  
7800DM-15

Jeu de 6 douilles 1/2, Sur règlette



**7806MD**



6 1 7806MD

7805DM-10, 7805DM-14, 7805DM-13,  
7805DM-17, 7805DM-19, 7805DM-22

Jeu de 7 douilles 1/2 TORX-E, Sur règlette



**7807TE**



7 1 7807TE

7800TORX-E10, 7800TORX-E12,  
7800TORX-E14, 7800TORX-E16,  
7800TORX-E18, 7800TORX-E20,  
7800TORX-E24

3/4"

Douille 6 pans pour carré conducteur 3/4, mm  
6 pans, mm



**8900SM**

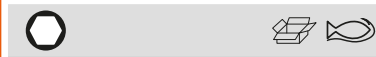

19 1 8900SM-19  
22 1 8900SM-22

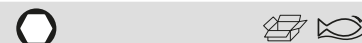

23	1	8900SM-23
24	1	8900SM-24
26	1	8900SM-26
27	1	8900SM-27
28	1	8900SM-28
29	1	8900SM-29
30	1	8900SM-30
32	1	8900SM-32
33	1	8900SM-33
34	1	8900SM-34
35	1	8900SM-35
36	1	8900SM-36
38	1	8900SM-38
41	1	8900SM-41
42	1	8900SM-42
46	1	8900SM-46
50	1	8900SM-50
55	1	8900SM-55
60	1	8900SM-60

Douille 3/4", 6 pans, pouce



**8900SZ**



3/4" in	1	8900SZ-3/4
13/16" in	1	8900SZ-13/16
7/8" in	1	8900SZ-7/8
15/16" in	1	8900SZ-15/16
1" in	1	8900SZ-1
1.1/16" in	1	8900SZ-1.1/16
1.1/8" in	1	8900SZ-1.1/8
1.1/4" in	1	8900SZ-1.1/4
1.5/16" in	1	8900SZ-1.5/16
1.3/8" in	1	8900SZ-1.3/8
1.7/16" in	1	8900SZ-1.7/16
1.1/2" in	1	8900SZ-1.1/2
1.9/16" in	1	8900SZ-1.9/16
1.5/8" in	1	8900SZ-1.5/8
1.3/4" in	1	8900SZ-1.3/4
1.13/16" in	1	8900SZ-1.13/16
1.7/8" in	1	8900SZ-1.7/8



Douille 12 pans pour carré conducteur 3/4", mm



**8900DM**

19	1	8900DM-19
21	5	8900DM-21
22	1	8900DM-22
23	1	8900DM-23
24	1	8900DM-24
25	1	8900DM-25
26	1	8900DM-26
27	1	8900DM-27
28	1	8900DM-28
29	1	8900DM-29
30	1	8900DM-30
32	1	8900DM-32
33	1	8900DM-33
34	1	8900DM-34
35	1	8900DM-35
36	1	8900DM-36
37	1	8900DM-37
38	1	8900DM-38
40	1	8900DM-40
41	1	8900DM-41
42	1	8900DM-42
46	1	8900DM-46
47	1	8900DM-47
50	1	8900DM-50
52	1	8900DM-52
40	3	8900DM-54
55	1	8900DM-55
56	1	8900DM-56
60	1	8900DM-60

Douille 12 pans pour carré conducteur 3/4, Pouces  
12 pans, Pouces



**8900DZ**

3/4	1	8900DZ-3/4
13/16	1	8900DZ-13/16
7/8	1	8900DZ-7/8
15/16	1	8900DZ-15/16
31/32 in	1	8900DZ-31/32
1	1	8900DZ-1
1 1/16	1	8900DZ-1.1/16
1 1/8	1	8900DZ-1.1/8
1 3/16	1	8900DZ-1.3/16
1 1/4	1	8900DZ-1.1/4

1 5/16	1	8900DZ-1.5/16
1 3/8	1	8900DZ-1.3/8
1 7/16	1	8900DZ-1.7/16
1 1/2	1	8900DZ-1.1/2
1.9/16	1	8900DZ-1.9/16
1 5/8	1	8900DZ-1.5/8
1.11/16	1	8900DZ-1.11/16
1 3/4	1	8900DZ-1.3/4
1 13/16	1	8900DZ-1.13/16
1 7/8	1	8900DZ-1.7/8
2	1	8900DZ-2
2.1/16	1	8900DZ-2.1/16
2.1/8	1	8900DZ-2.1/8
2.3/16 in	1	8900DZ-2.3/16
2.1/4	1	8900DZ-2.1/4
2.3/8	1	8900DZ-2.3/8

Poignée universelle 3/4  
Pour la tête de cliquet N° 8950N/A, la poignée articulée N° 8958A et la poignée coulissante N° 8954A



**8953**

505	1	8953
-----	---	------

Rallonge télescopique 3/4"



**S93**

510	1	S93
-----	---	-----

Poignée universelle pour 8952N/A



**8952N/B**

450	1	8952N/B
-----	---	---------

Poignée coulissante en T 3/4  
Comprenant la poignée universelle N° 8953 et le carré d'entraînement coulissant



**8954**

505	1	8954
-----	---	------

Carré d'entraînement coulissant en T 3/4  
Avec la poignée universelle 8953 cela devient la poignée coulissante en T 8954



**8954A**

62	1	8954A
----	---	-------

Poignée articulée 3/4  
Comprenant la tête articulée 8958A et la poignée universelle 8953



**8958**

570	1	8958
-----	---	------

Tête de poignée articulée 3/4  
Avec la poignée universelle 8953 il devient la poignée articulée 8958



**8958A**

125	1	8958A
-----	---	-------



Rallonge coudée 3/4



**8963**

415	1 8963

Rallonge 3/4



**8961/8962**

200	1 8961
400	1 8962

Cardan universel 3/4



**8966**

120	1 8966

Adaptateur pour carré conducteur 3/4 et douille 1/2



**8965**

3/4	1/2	1 8965

Adaptateur pour carré conducteur 3/4 et douille 1 Pouce



**9564**

3/4"	1"	1 9564

Cliquet réversible 3/4



**8950N**

612	72	1 8950N

Cliquet réversible 3/4"



**8952N**

525	24	1 8952N

Cliquet 3/4"  
0



**8955N**

525 mm	24	1 8955N

Tête de cliquet réversible 3/4  
Avec la poignée universelle n°8953, il devient le cliquet complet n°8950N



**8950N/A**

170	72	1 8950N/A

Tête de cliquet réversible 3/4  
Avec la poignée universelle 8952N/B, il devient le cliquet complet N°8952N



**8952N/A**

145	24	1 8952N/A

Accessoires pour cliquet 3/4"  
0



**8955N/A**

24	1 8955N/A

Poignée universelle 3/4"  
0



**8955N/B**

1160	390 mm	5 8955N/B



Adaptateur cliquet réversible 3/4  
Diamètre maximum: 63mm



**8951**

95.5	1	8951

Jeu de pièces de rechange pour cliquets 3/4 8950N et 8950N/A  
8 pièces



**8950NA-SO/2**

8	8950N, 8950N/A	1	8950NA-SO/2

Pièce détachée pour cliquet 3/4"  
0



**8955N-SPARE**

11	8955N, 8955N/A	1	8955N-SPARE

Jeu de douilles 3/4, 15 pièces  
6 pans, mm



**8845NM**

94 x 206 x 591 mm	1	8845NM

8900SM-24, 8900SM-22, 8900SM-27, 8900SM-30, 8900SM-32, 8900SM-36, 8900SM-38, 8900SM-41, 8900SM-46, 8900SM-50		
8953		
8954A		
8962		
8950N/A		
8961		

Jeu de douilles 3/4, 15 pièces  
12 pans, mm



**8845DM**

94 x 206 x 591 mm	1	8845DM

8900DM-19, 8900DM-22, 8900DM-24, 8900DM-27, 8900DM-30, 8900DM-32, 8900DM-36, 8900DM-41, 8900DM-46, 8900DM-50		
8950N/A		
8953		
8954A		
8961, 8962		

Jeu de douilles 3/4, 23 pièces  
12 pans, mm



**8821MB**

95 x 220 x 600 mm	1	8821MB

8950N/A	
8954	
8965	
8966	
8961, 8962	
8900DM-26, 8900DM-23, 8900DM-22, 8900DM-24, 8900DM-27, 8900DM-29, 8900DM-28, 8900DM-32, 8900DM-30, 8900DM-34, 8900DM-38, 8900DM-35, 8900DM-36, 8900DM-46, 8900DM-41, 8900DM-42, 8900DM-50	

Jeu de douilles 3/4, 24 pièces  
12 pans, mm



**8840M**

100 x 210 x 595 mm	1	8840M

8900DM-27, 8900DM-28, 8900DM-19, 8900DM-22, 8900DM-25, 8900DM-24, 8900DM-32, 8900DM-30, 8900DM-55, 8900DM-60, 8900DM-46, 8900DM-50, 8900DM-41, 8900DM-36		
8953		
8954A		
8962		
8966		
8965		
8950N/A		
8961		
8951		
8964		
8958A		

Jeu de douilles 3/4, 17 pièces  
mm



**SLX 17**

   
375 x 430 x 110 mm 1 SLX 17

Jeu de douilles 3/4, 17 pièces  
Pouces



**SLX17AF**

   
70 x 375 x 430 mm 1 SLX 17AF

**1"**

Douille carré conducteur 1  
6 pans, mm



**9500SM**

mm	1	9500SM-41
41	1	9500SM-41
46	1	9500SM-46
50	1	9500SM-50
54	1	9500SM-54
55	1	9500SM-55
58	1	9500SM-58
60	1	9500SM-60
63	1	9500SM-63
65	1	9500SM-65
67	1	9500SM-67
70	1	9500SM-70
71	1	9500SM-71
75	1	9500SM-75
77	1	9500SM-77
80	1	9500SM-80
82	1	9500SM-82

Cardan universel articulé 1"



**9566A**

   
167 1 9566A

Poignée coulissante en T  
Comprenant la carré d'entraînement coulissant en T  
9555AB et la poignée universelle 9552AB



**9555**

   
508 1 9555

Carré d'entraînement coulissant 1  
Avec la poignée universelle 9550AB cela devient la  
poignée coulissante en T 9555



**9555AB**

   
78x78x78 1 9555AB

Douille 1", 12 pans, pouce  
12 pans, Pouces



**9500DZ**

in	1	9500DZ-1.5/8
1.5/8	1	9500DZ-1.5/8
1.13/16	1	9500DZ-1.13/16
1.7/8	1	9500DZ-1.7/8
2	1	9500DZ-2
2.1/8	1	9500DZ-2.1/8
2.3/16	1	9500DZ-2.3/16
2.1/4	1	9500DZ-2.1/4
2.3/8	1	9500DZ-2.3/8
2.1/2	1	9500DZ-2.1/2
2.9/16	1	9500DZ-2.9/16
2.5/8	1	9500DZ-2.5/8
2.3/4	1	9500DZ-2.3/4
2.15/16	1	9500DZ-2.15/16
3	1	9500DZ-3
3.1/8	1	9500DZ-3.1/8

Rallonge 1



**9560AB/9563AB**

   
200 1 9560AB  
440 1 9563AB



Adaptateur pour carré conducteur 1 et douille 1



**9565AB**



1" 1" 1 9565AB

Cliquet 1"



**9550N**



640 72 1 9550N

Poignée universelle 1"



**9550N/B**



510 1960 1 9550N/B

Accessoires pour cliquet 1"

0



**9550N/A**



195 72 1 9550N/A

Pièce détachée pour cliquet 1"

0



**9550N-SPARE**



2 9550N, 9550N/A 1 9550N-SPARE

Jeu de douilles 1", 11 pièces  
Coffret métallique



**9540MB**



210 x 560 x 120 mm 1 9540MB

9500SM-80, 9500SM-75, 9500SM-70,  
9500SM-65, 9500SM-60, 9500SM-55,  
9500SM-50, 9500SM-46

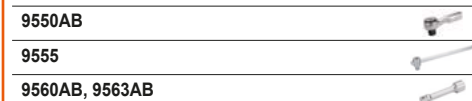

9550AB  
9555  
9560AB, 9563AB

Jeu de douilles 1", 18 pièces  
Coffret métallique



**9540MBL**



225 x 605 x 120 mm 1 9540MBL

9500SM-80, 9500SM-77, 9500SM-71,  
9500SM-70, 9500SM-67, 9500SM-65,  
9500SM-63, 9500SM-60, 9500SM-75,  
9500SM-46, 9500SM-50, 9500SM-54,  
9500SM-55, 9500SM-58



9555

Jeu de douilles 1" 12 pans, pouces  
Dans boîtier métallique



**9540DZ**



150 x 260 x 663 mm 1 9540DZ

**9550AB**

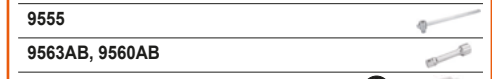

9555  
9563AB, 9560AB  
9500DZ-2.3/4, 9500DZ-2.3/8, 9500DZ-  
2.3/16, 9500DZ-3, 9500DZ-1.13/16,  
9500DZ-3.1/8, 9500DZ-2.5/8, 9500DZ-2

Coffret de douilles 12 pans 1" en pouces  
Dans un coffret en métal



**9540DZL**



140 x 285 x 630 mm 1 9540DZL

9500DZ-2.1/4, 9500DZ-2.3/4, 9500DZ-2.3/8, 9500DZ-2.1/2, 9500DZ-2.15/16, 9500DZ-2.1/8, 9500DZ-1.7/8, 9500DZ-2.3/16, 9500DZ-3, 9500DZ-1.13/16, 9500DZ-3.1/8, 9500DZ-2.5/8, 9500DZ-2, 9500DZ-2.9/16	
9550AB	
9555	
9563AB, 9560AB	
9565AB	

## DOUILLES À CHOC 1/4"

Douille à choc 1/4", 6 pans



### K6701M

Size	Quantity	Part Number
6	1	K6701M-6
7	1	K6701M-7
8	1	K6701M-8
9	1	K6701M-9
10	1	K6701M-10
11	1	K6701M-11
12	1	K6701M-12
13	1	K6701M-13
14	1	K6701M-14

Douilles à choc 1/4" 6 pans dimensions métriques, brochables



### SBK6701M

Size	Quantity	Part Number
6	1	SBK6701M-6
7	1	SBK6701M-7
8	1	SBK6701M-8
9	1	SBK6701M-9
10	1	SBK6701M-10
11	1	SBK6701M-11
12	1	SBK6701M-12
13	1	SBK6701M-13
14	1	SBK6701M-14

Douille magnétique, mm



### KM6701M

Size	Quantity	Part Number
7	1	KM6701M-7
8	1	KM6701M-8
10	1	KM6701M-10

Jonc de retenue



### K560F-1

Size	Quantity	Part Number
1/4"	5	K560F-1

## DOUILLES À CHOC 3/8"

Douille à choc 3/8", 6 pans



### K7401M

Size	Quantity	Part Number
7	1	K7401M-7
8	1	K7401M-8
9	1	K7401M-9
10	1	K7401M-10
11	1	K7401M-11
12	1	K7401M-12
13	1	K7401M-13
14	1	K7401M-14
15	1	K7401M-15
16	1	K7401M-16
17	1	K7401M-17
18	1	K7401M-18
19	1	K7401M-19
20	1	K7401M-20

Size	Quantity	Part Number
21	1	K7401M-21
22	1	K7401M-22
24	1	K7401M-24

Douilles à choc 3/8" 6 pans dimensions métriques, brochables



### SBK7401M

Size	Quantity	Part Number
7	1	SBK7401M-7
8	1	SBK7401M-8
9	1	SBK7401M-9
10	1	SBK7401M-10
11	1	SBK7401M-11
12	1	SBK7401M-12
13	1	SBK7401M-13
14	1	SBK7401M-14
15	1	SBK7401M-15
16	1	SBK7401M-16
17	1	SBK7401M-17
18	1	SBK7401M-18
19	1	SBK7401M-19
20	1	SBK7401M-20
21	1	SBK7401M-21
22	1	SBK7401M-22
24	1	SBK7401M-24

Douille 6 pans 3/8", pouces



### K7401Z

Size	Quantity	Part Number
3/8 in	1	K7401Z-3/8
7/16 in	1	K7401Z-7/16
1/2 in	1	K7401Z-1/2
9/16 in	1	K7401Z-9/16
5/8 in	1	K7401Z-5/8
11/16 in	1	K7401Z-11/16
3/4 in	1	K7401Z-3/4
13/16 in	1	K7401Z-13/16
7/8 in	1	K7401Z-7/8



Douille à choc longue 3/8



**K7406M**



10	1	K7406M-10
13	1	K7406M-13
17	1	K7406M-17

Douille 6 pans pivotante 3/8", métrique



**KS7401M**



3/8 in	1	KS7401M-9
3/8 in	1	KS7401M-10
3/8 in	1	KS7401M-11
3/8 in	1	KS7401M-12
3/8 in	1	KS7401M-13
3/8 in	1	KS7401M-14
3/8 in	1	KS7401M-15
3/8 in	1	KS7401M-16
3/8 in	1	KS7401M-17
3/8 in	1	KS7401M-18
3/8 in	1	KS7401M-19
3/8 in	1	KS7401M-22

Douille 3/8", TORX®



**K7401TORX-E**



E5	M4	1	K7401TORX-E5
E6	M5	1	K7401TORX-E6



E7	M6	1	K7401TORX-E7
E8	M6, M7	1	K7401TORX-E8
E10	M6, M8	1	K7401TORX-E10
E12	M8, M10	1	K7401TORX-E12
E14	M10, M12	1	K7401TORX-E14

Rallonge 3/8



**K7760C**



75	1	K7760C-1
150	1	K7760C-2

Cardan 3/8



**K7767S**



3/8"	3/8"	1	K7767S
------	------	---	--------

Adaptateur de 3/8 à 1/2



**K6964C/K8164C**



1/4"	3/8"	1	K6964C
1/2"	3/8"	1	K8164C

Porte-embout 3/8, 6 pans



**7407H-7409H**



1/4"	3/8"	1	7407H
5/16"	3/8"	1	7408H
11	3/8"	1	7409H

Porte embouts 1/4" pour adaptateurs électriques 3/8"



**K172**



1/4"	1	K172
------	---	------

Jonc de retenue



**K560F-2/3**



3/8"	7-12	5	K560F-2
3/8"	13-24	5	K560F-3

Coffret de douilles à choc, dimensions métriques, 10 pcs



### K7401M/10

		
10	1	K7401M/10

Jeu de douilles à choc 3/8", E TORX®, 7pcs



### K7401TORX-E-S7

			
7	1	K7401TORX-E-S7	

K7401TORX-E5, K7401TORX-E6,  
K7401TORX-E7, K7401TORX-E8,  
K7401TORX-E10, K7401TORX-E12,  
K7401TORX-E14



## DOUILLES À CHOC 1/2"

Douille à chocs extra courte



### K7800M



		
10	1	K7800M-10
11	1	K7800M-11

		
12	1	K7800M-12
13	1	K7800M-13
14	1	K7800M-14
15	1	K7800M-15
16	1	K7800M-16
17	1	K7800M-17
18	1	K7800M-18
19	1	K7800M-19
21	1	K7800M-21
22	1	K7800M-22
24	1	K7800M-24

Douille à choc 1/2", 6 pans





### K7801M

		
8	1	K7801M-8
9	1	K7801M-9
10	1	K7801M-10
11	1	K7801M-11
12	1	K7801M-12
13	1	K7801M-13
14	1	K7801M-14
15	1	K7801M-15
16	1	K7801M-16
17	1	K7801M-17
18	1	K7801M-18
19	1	K7801M-19
20	1	K7801M-20
21	1	K7801M-21
22	1	K7801M-22
23	1	K7801M-23
24	1	K7801M-24
25	1	K7801M-25
26	1	K7801M-26
27	1	K7801M-27
28	1	K7801M-28
29	1	K7801M-29
30	1	K7801M-30
32	15	K7801M-32
34	1	K7801M-34
36	1	K7801M-36

Douilles à choc 1/2" 6 pans dimensions métriques, brochantes





### SBK7801M

		
8	1	SBK7801M-8
9	1	SBK7801M-9
10	1	SBK7801M-10
11	1	SBK7801M-11
12	1	SBK7801M-12
13	1	SBK7801M-13
14	1	SBK7801M-14
15	1	SBK7801M-15
16	1	SBK7801M-16
17	1	SBK7801M-17
18	1	SBK7801M-18
19	1	SBK7801M-19
20	1	SBK7801M-20
21	1	SBK7801M-21
22	1	SBK7801M-22
23	1	SBK7801M-23
24	1	SBK7801M-24
25	1	SBK7801M-25
26	1	SBK7801M-26
27	1	SBK7801M-27
28	1	SBK7801M-28
29	1	SBK7801M-29
30	1	SBK7801M-30
32	1	SBK7801M-32
34	1	SBK7801M-34
36	1	SBK7801M-36

Douille à choc renforcée pour écrou de jante, mm



### K7801VM

		
17	1	K7801VM-17
19	1	K7801VM-19
22	1	K7801VM-22
24	1	K7801VM-24



### Douille à choc longue 1/2", 6 pans



#### K7806M

Size	Quantity	Part Number
10	1	K7806M-10
11	1	K7806M-11
12	1	K7806M-12
13	1	K7806M-13
14	1	K7806M-14
15	1	K7806M-15
16	1	K7806M-16
17	1	K7806M-17
18	1	K7806M-18
19	1	K7806M-19
21	1	K7806M-21
22	1	K7806M-22
23	1	K7806M-23
24	1	K7806M-24
27	1	K7806M-27
30	1	K7806M-30
32	1	K7806M-32
36	1	K7806M-36

SB : Conditionnement détail sur carte plastique

### Douille à choc 1/2, 6 pans, Pouces



#### K7801Z

Size	Quantity	Part Number
3/8	1	K7801Z-3/8
7/16	1	K7801Z-7/16
1/2	1	K7801Z-1/2
9/16	1	K7801Z-9/16
5/8	1	K7801Z-5/8
11/16	1	K7801Z-11/16
3/4	1	K7801Z-3/4
13/16	1	K7801Z-13/16
7/8	1	K7801Z-7/8
15/16	1	K7801Z-15/16
1	1	K7801Z-1
1 1/16	1	K7801Z-1.1/16
1 1/8	1	K7801Z-1.1/8
1 1/4	1	K7801Z-1.1/4
1 5/16	5	K7801Z-1.5/16
1 3/8	5	K7801Z-1.3/8
1 7/16	5	K7801Z-1.7/16
1 1/2	5	K7801Z-1.1/2

### Douille à choc longue 1/2, Pouces



#### K7806Z

Size	Quantity	Part Number
3/8	10	K7806Z-3/8
7/16	10	K7806Z-7/16
1/2	10	K7806Z-1/2
9/16	10	K7806Z-9/16
5/8	5	K7806Z-5/8
11/16	5	K7806Z-11/16
3/4	5	K7806Z-3/4
13/16	5	K7806Z-13/16
7/8	5	K7806Z-7/8
15/16	5	K7806Z-15/16
1	5	K7806Z-1
1 1/16	5	K7806Z-1.1/16
1 1/8	5	K7806Z-1.1/8
1 1/4	5	K7806Z-1.1/4
1 5/16	5	K7806Z-1.5/16
1 3/8	5	K7806Z-1.3/8
1 7/16	5	K7806Z-1.7/16
1 1/2	5	K7806Z-1.1/2

SB : Conditionnement détail sur carte plastique

### Douille à choc 1/2 TORX®



#### K7801TORX-E

Size	Quantity	Part Number
E10	1	K7801TORX-E10
E12	1	K7801TORX-E12
E14	1	K7801TORX-E14
E16	1	K7801TORX-E16
E18	1	K7801TORX-E18
E20	1	K7801TORX-E20
E24	1	K7801TORX-E24

### Rallonge 1/2



#### K8160D

Length	Quantity	Part Number
75	1	K8160D-1
125	1	K8160D-2
250	1	K8160D-3

### Cardan 1/2



#### K8167S

Size	Quantity	Part Number
1/2"	1	K8167S

### Adaptateur 1/2 à 3/4



#### K7764D/K8964D

Size	Quantity	Part Number
M 3/8"	1	K7764D
3/4"	1	K8964D



Porte-embout conducteur 6 pans mâle 11mm



**7807H-7809H**

1/2"	1/4"	1	7807H
1/2"	5/16"	1	7808H
1/2"	11.2	1	7809H

Jonc de retenue



**K560F-4/5**

1/2"	10-14	5	K560F-4
1/2"	15-32	5	K560F-5

Douille à choc tournevis 1/2, 6 pans



**7993S**

5	1	7993S0050
6	1	7993S0060
8	1	7993S0080
10	1	7993S0100
12	1	7993S0120
14	1	7993S0140
17	1	7993S0170
19	1	7993S0190

Douille à choc tournevis 1/2" pour vis TORX®



**7994S**

T-30	1	7994S0300
T-40	1	7994S0400
T-45	1	7994S0450
T-50	1	7994S0500
T-55	1	7994S0550
T-60	1	7994S0600

Jeu de douilles à choc 1/2  
4 pièces



**K7801VM/S4**

4	1	K7801VM/S4
---	---	------------

K7801VM-22, K7801VM-19,  
K7801VM-17, K7801VM-24

Coffret de douilles à choc mini 1/2"



**K7800M/13**

43 x 128 x 195 mm	1	K7800M/13
-------------------	---	-----------

K7800M-10, K7800M-11, K7800M-12,  
K7800M-13, K7800M-14, K7800M-15,  
K7800M-16, K7800M-17, K7800M-18,  
K7800M-19, K7800M-21, K7800M-22,  
K7800M-24

Jeu de douilles à chocs 1/2", métrique  
14 pièces



**D/S14**

14	6	D/S14
----	---	-------

K7801M-10, K7801M-11, K7801M-12,  
K7801M-13, K7801M-14, K7801M-15,  
K7801M-16, K7801M-17, K7801M-18,  
K7801M-19, K7801M-21, K7801M-22,  
K7801M-24, K7801M-27

Jeu de douilles à choc longues 1/2



**K7806M/S4**

4	1	K7806M/S4
---	---	-----------

K7806M-19, K7806M-22, K7806M-17,  
K7806M-24



Jeu de 14 douilles à choc longues 1/2", métrique  
DD/S14: 10-27mm



### DD/S14



		
14	4	DD/S14

K7806M-10, K7806M-11, K7806M-12,  
K7806M-13, K7806M-14, K7806M-15,  
K7806M-16, K7806M-17, K7806M-18,  
K7806M-19, K7806M-21, K7806M-22,  
K7806M-24, K7806M-27

Jeu de douilles à choc mixtes 1/2  
20 pièces : 10, 11, 12, 13, 14, 15, 16, 17, 18, 19mm



### D-DD/S20

		
20	4	D-DD/S20

K7801M-14, K7801M-15, K7801M-16,  
K7801M-11, K7801M-10, K7801M-13,  
K7801M-12, K7801M-18, K7801M-19,  
K7801M-17

K7806M-19, K7806M-17, K7806M-18,  
K7806M-14, K7806M-16, K7806M-12,  
K7806M-13, K7806M-10, K7806M-11

Jeu de 10 douilles à choc 1/2, Pouces



### K7801Z/10

		
10	60x220x280mm	1 K7801Z/10

K7801Z-7/16, K7801Z-1/2,  
K7801Z-11/16, K7801Z-5/8,  
K7801Z-13/16, K7801Z-3/4,  
K7801Z-15/16, K7801Z-7/8, K7801Z-1,  
K7801Z-9/16

Coffret de 10 douilles à choc longues 1/2", pouces



### K7806Z/10

		
10	60x220x280mm	1 K7806Z/10

K7806Z-7/16, K7806Z-1/2,  
K7806Z-9/16, K7806Z-3/4,  
K7806Z-13/16, K7806Z-11/16,  
K7806Z-1, K7806Z-7/8, K7806Z-15/16,  
K7806Z-5/8

Jeu de 10 douilles à chocs 1/2", métriques  
D/S10: 10-19mm



### D/S10

		
10	6	D/S10

K7801M-10, K7801M-11, K7801M-12,  
K7801M-13, K7801M-14, K7801M-15,  
K7801M-16, K7801M-17, K7801M-18,  
K7801M-19

Jeu de 10 douilles à choc longues 1/2", métriques  
DD/S10: 10-19mm



### DD/S10

		
10	6	DD/S10

K7806M-10, K7806M-11, K7806M-12,  
K7806M-13, K7806M-14, K7806M-15,  
K7806M-16, K7806M-17, K7806M-18,  
K7806M-19

## DOUILLES À CHOC 3/8"

Douille à choc 3/4, mm, 6 pans



### K8901M

Part Number	Quantity	Part Number
17	1	K8901M-17
18	1	K8901M-18
19	1	K8901M-19
21	1	K8901M-21
22	1	K8901M-22
23	1	K8901M-23
24	1	K8901M-24
27	1	K8901M-27
28	1	K8901M-28
29	1	K8901M-29
30	1	K8901M-30
32	1	K8901M-32
33	1	K8901M-33
34	1	K8901M-34
36	1	K8901M-36
38	1	K8901M-38
41	1	K8901M-41
46	1	K8901M-46
50	1	K8901M-50
55	1	K8901M-55
60	1	K8901M-60

SB : Conditionnement détail sur carte plastique

Douille à choc 3/4, Pouces, 6 pans



### K8901Z

Part Number	Quantity	Part Number
11/16	1	K8901Z-11/16
3/4	1	K8901Z-3/4
13/16	1	K8901Z-13/16
7/8	1	K8901Z-7/8
15/16	1	K8901Z-15/16
1	1	K8901Z-1
1 1/16	1	K8901Z-1.1/16
1 1/8	1	K8901Z-1.1/8
1 3/16	1	K8901Z-1.3/16
1 1/4	1	K8901Z-1.1/4
1 5/16	1	K8901Z-1.5/16
1 3/8	1	K8901Z-1.3/8
1 7/16	1	K8901Z-1.7/16

Part Number	Quantity	Part Number
1 1/2	1	K8901Z-1.1/2
1 9/16	1	K8901Z-1.9/16
1 5/8	1	K8901Z-1.5/8
1 11/16	1	K8901Z-1.11/16
1 3/4	1	K8901Z-1.3/4
1 13/16	1	K8901Z-1.13/16
1 7/8	1	K8901Z-1.7/8
1 15/16	1	K8901Z-1.15/16
2	1	K8901Z-2
2 1/16	1	K8901Z-2.1/16
2 3/16	1	K8901Z-2.3/16
2 1/4	1	K8901Z-2.1/4
2 3/8	1	K8901Z-2.3/8

SB : Conditionnement détail sur carte plastique

Douille à choc longue 3/4, mm



### K8906M

Part Number	Quantity	Part Number
17	1	K8906M-17
19	1	K8906M-19
21	1	K8906M-21
22	1	K8906M-22
24	1	K8906M-24
27	1	K8906M-27
30	1	K8906M-30
32	1	K8906M-32
33	1	K8906M-33
34	1	K8906M-34
36	1	K8906M-36
41	1	K8906M-41
46	1	K8906M-46

SB : Conditionnement détail sur carte plastique

Douille à choc 3/4 longue, Pouces, 6 pans



### K8906Z

Part Number	Quantity	Part Number
3/4	1	K8906Z-3/4
13/16	1	K8906Z-13/16
7/8	1	K8906Z-7/8
15/16	1	K8906Z-15/16
1	1	K8906Z-1
1 1/16	1	K8906Z-1.1/16
1.1/8	1	K8906Z-1.1/8
1.1/4	1	K8906Z-1.1/4
1.5/16	1	K8906Z-1.5/16
1.3/8	1	K8906Z-1.3/8

Part Number	Quantity	Part Number
1.7/16	1	K8906Z-1.7/16
1.1/2	1	K8906Z-1.1/2
1.5/8	1	K8906Z-1.5/8
1.3/4	1	K8906Z-1.3/4
2	1	K8906Z-2

SB : Conditionnement détail sur carte plastique

Rallonge 3/4



### K8960F

Part Number	Quantity	Part Number
175	1	K8960F-2
250	1	K8960F-3
325	10	K8960F-4

Cardan 3/4



### K8967S

Part Number	Quantity	Part Number
3/4"	1	K8967S

Adaptateur de 3/4 à 1



### K8164F/K9564F

Part Number	Quantity	Part Number
1/2"	1	K8164F
1"	1	K9564F



Porte-embout 3/4 pour embout de 22 mm



**K8909H**

22	3/4"	1	K8909H-5

Jonc de retenue



**K560F-6**

3/4"	17-46	5	K560F-6

Douille à choc tournevis 3/4 à embout 6 pans



**7993T**

12	1	7993T0120	
14	1	7993T0140	
17	1	7993T0170	
19	1	7993T0190	
22	1	7993T0220	
24	1	7993T0240	

Jeu de 8 douilles à choc 3/4



**K8901M/8**

8	65x240x350mm	1	K8901M/8

K8901M-27, K8901M-24, K8901M-21, K8901M-22, K8901M-30, K8901M-32, K8901M-36, K8901M-41

Jeu de 8 douilles à choc 3/4"



**K8901Z/8**

8	80x250x310mm	1	K8901Z/8

K8901Z-1.1/16, K8901Z-1, K8901Z-1.3/8, K8901Z-1.5/16, K8901Z-1.1/4, K8901Z-1.1/2, K8901Z-1.7/16, K8901Z-1.1/8

Douilles à choc 3/4" 6 pans dimensions en pouces



**K8901Z/18**

100 x 210 x 595 mm	1	K8901Z/18	

K8901Z-11/16, K8901Z-3/4, K8901Z-13/16, K8901Z-7/8, K8901Z-15/16, K8901Z-1, K8901Z-1.1/16, K8901Z-1.1/8, K8901Z-1.3/16, K8901Z-1.1/4, K8901Z-1.5/16, K8901Z-1.3/8, K8901Z-1.7/16, K8901Z-1.1/2, K8901Z-1.9/16, K8901Z-1.5/8, K8901Z-1.11/16, K8901Z-1.3/4

Jeu de 8 douilles à choc longues 3/4", métrique



**K8906M/8**

8	80x250x315mm	1	K8906M/8

K8906M-24, K8906M-27, K8906M-30, K8906M-41, K8906M-36, K8906M-21, K8906M-22, K8906M-32

Jeu de 8 douilles à choc longues 3/4", pouces



**K8906Z/8**

8	125x250x110mm	1 K8906Z/8

K8906Z-1, K8906Z-1.1/16,  
K8906Z-1.1/8, K8906Z-1.1/4,  
K8906Z-1.5/16, K8906Z-1.3/8,  
K8906Z-1.7/16, K8906Z-1.1/2

**DOUILLES À CHOC 1"**

Douille à choc 1 Pouce, mm, 6 pans



**K9501M**

22	1 K9501M-22
24	1 K9501M-24
27	1 K9501M-27
30	1 K9501M-30
32	1 K9501M-32
33	1 K9501M-33
34	1 K9501M-34
36	1 K9501M-36
38	1 K9501M-38
41	1 K9501M-41
42	1 K9501M-42
46	1 K9501M-46
50	1 K9501M-50
55	1 K9501M-55
60	1 K9501M-60
65	1 K9501M-65
70	1 K9501M-70
75	1 K9501M-75
80	1 K9501M-80
85	1 K9501M-85

Douille à choc 1 Pouce, 6 pans



**K9501Z**

1	1 K9501Z-1
1 1/16	1 K9501Z-1.1/16
1 1/8	1 K9501Z-1.1/8
1 3/16	1 K9501Z-1.3/16
1 1/4	1 K9501Z-1.1/4
1 5/16	1 K9501Z-1.5/16
1 3/8	1 K9501Z-1.3/8
1 7/16	1 K9501Z-1.7/16
1 1/2	1 K9501Z-1.1/2
1 9/16	1 K9501Z-1.9/16
1 5/8	1 K9501Z-1.5/8
1 11/16	1 K9501Z-1.11/16
1 3/4	1 K9501Z-1.3/4
1 13/16	1 K9501Z-1.13/16
1 7/8	1 K9501Z-1.7/8
15/16	1 K9501Z-1.15/16
2	1 K9501Z-2
2 1/8	1 K9501Z-2.1/8
2 3/16	1 K9501Z-2.3/16
2 1/4	1 K9501Z-2.1/4
2 5/16	1 K9501Z-2.5/16
2 9/16	1 K9501Z-2.9/16
2 3/4	1 K9501Z-2.3/4

Douille à choc longue 1 Pouce, mm, 6 pans



**K9506M**

22	1 K9506M-22
24	1 K9506M-24
27	1 K9506M-27
30	1 K9506M-30
32	1 K9506M-32
33	1 K9506M-33
34	1 K9506M-34
36	1 K9506M-36
38	1 K9506M-38
41	1 K9506M-41
46	1 K9506M-46
50	1 K9506M-50
55	1 K9506M-55
60	1 K9506M-60

Douille à choc 1 Pouce, Pouce



**K9506Z**

1	1 K9506Z-1
1 1/16	1 K9506Z-1.1/16
1 3/16	1 K9506Z-1.3/16
1 1/4	1 K9506Z-1.1/4
1 7/16	1 K9506Z-1.7/16
1 1/2	1 K9506Z-1.1/2
1 5/8	1 K9506Z-1.5/8
1 13/16	1 K9506Z-1.13/16
1 7/8	1 K9506Z-1.7/8

Rallonge 1 Pouce



**K9560G**

100	1 K9560G-0
125	1 K9560G-1
175	1 K9560G-2
325	1 K9560G-3
300	1 K9560G-4
400	1 K9560G-5

Cardan 1 Pouce



**K9567S**

1"	1 K9567S



Adaptateur de 1 Pouce à 3/4 et 1 Pouce à 1/2



**K8964G/K9895G**

3/4"	1"	1	K8964G
1 1/2"	1"	1	K9895G

Porte-embout 1", 6 pans mâle de 22 mm



**K9509H5**

22	1"	1	K9509H5

Douille à choc tournevis 1 Pouce à embout 6 pans



**7993M**

17	1	7993M0170
19	1	7993M0190
22	1	7993M0220
27	1	7993M0270

Embout conducteur pour vis à 6 pans creux 1", métrique



**K8909ML/K9509ML**

12	1	K8909ML-12
14	1	K8909ML-14
17	1	K8909ML-17
19	1	K9509ML-19
22	1	K9509ML-22
24	1	K9509ML-24

Jonc de retenue



**K560F-7/8**

1"	19-70	5	K560F-7
1 & 1 1/2"	75-80 & 46-90	5	K560F-8

**DOUILLES À CHOC 1.1/2"**

Douille à choc 1.1/2, mm, 6 pans



**K9801M**

46	1	K9801M-46
50	1	K9801M-50
55	1	K9801M-55
60	1	K9801M-60
65	1	K9801M-65
70	1	K9801M-70
75	1	K9801M-75
80	1	K9801M-80

85	1	K9801M-85
90	1	K9801M-90
95	1	K9801M-95
100	1	K9801M-100
105	1	K9801M-105
110	1	K9801M-110
115	1	K9801M-115
120	1	K9801M-120
125	1	K9801M-125
130	1	K9801M-130
135	1	K9801M-135
140	1	K9801M-140
145	1	K9801M-145
150	1	K9801M-150
155	1	K9801M-155

Douille à choc 1.1/2, Pouces  
Fabriqué sur demande



**K9801Z**

1 3/8	1	K9801Z-1.3/8
1 7/16	1	K9801Z-1.7/16
1 1/2	1	K9801Z-1.1/2
1 9/16	1	K9801Z-1.9/16
1 5/8	1	K9801Z-1.5/8
1 11/16	1	K9801Z-1.11/16
1 3/4	1	K9801Z-1.3/4
1 13/16	1	K9801Z-1.13/16
1 7/8	1	K9801Z-1.7/8
1 15/16	1	K9801Z-1.15/16
2	1	K9801Z-2
2 1/16	1	K9801Z-2.1/16
2 1/8	1	K9801Z-2.1/8
2 3/16	1	K9801Z-2.3/16
2 1/4	1	K9801Z-2.1/4
2 5/16	1	K9801Z-2.5/16
2 3/8	1	K9801Z-2.3/8
2 7/16	1	K9801Z-2.7/16
2 1/2	1	K9801Z-2.1/2
2 9/16	1	K9801Z-2.9/16
2 5/8	1	K9801Z-2.5/8
2 11/16	1	K9801Z-2.11/16
2 3/4	1	K9801Z-2.3/4
2 13/16	1	K9801Z-2.13/16
2 7/8	1	K9801Z-2.7/8
2 15/16	1	K9801Z-2.15/16
3	1	K9801Z-3
3 1/16	1	K9801Z-3.1/16
3 1/8	1	K9801Z-3.1/8
3 1/4	1	K9801Z-3.1/4
3 5/16	1	K9801Z-3.5/16
3 3/8	1	K9801Z-3.3/8
3 7/16	1	K9801Z-3.7/16
3 1/2	1	K9801Z-3.1/2
3 9/16	1	K9801Z-3.9/16
3 5/8	1	K9801Z-3.5/8
3 11/16	1	K9801Z-3.11/16
3 3/4	1	K9801Z-3.3/4

Ø			
3 13/16	1	K9801Z-3.13/16	
3 7/8	1	K9801Z-3.7/8	
3 15/16	1	K9801Z-3.15/16	
4	1	K9801Z-4	
4 1/16	1	K9801Z-4.1/16	
4 1/8	1	K9801Z-4.1/8	
4 1/4	1	K9801Z-4.1/4	
4 5/16	1	K9801Z-4.5/16	
4 3/8	1	K9801Z-4.3/8	
4 7/16	1	K9801Z-4.7/16	
4 1/2	1	K9801Z-4.1/2	
4 5/8	1	K9801Z-4.5/8	
4 3/4	1	K9801Z-4.3/4	

Douille à choc longue 1.1/2  
Fabriqué sur demande



### K9806M

Ø			
41	1	K9806M-41	
46	1	K9806M-46	
50	1	K9806M-50	
55	1	K9806M-55	
60	1	K9806M-60	
65	1	K9806M-65	
70	1	K9806M-70	
75	1	K9806M-75	
80	1	K9806M-80	
85	1	K9806M-85	
90	1	K9806M-90	
95	1	K9806M-95	
100	1	K9806M-100	
105	1	K9806M-105	
110	1	K9806M-110	
115	1	K9806M-115	
120	1	K9806M-120	

Douille à choc longue 1.1/2, Pouces  
Fabriqué sur demande



### K9806Z

Ø			
1 3/8	1	K9806Z-1.3/8	
1 7/16	1	K9806Z-1.7/16	

Ø			
1 1/2	1	K9806Z-1.1/2	
1 5/8	1	K9806Z-1.5/8	
1 11/16	1	K9806Z-1.11/16	
2	1	K9806Z-2	
2 1/16	1	K9806Z-2.1/16	
2 3/16	1	K9806Z-2.3/16	
2 1/4	1	K9806Z-2.1/4	
2 5/16	1	K9806Z-2.5/16	
2 3/8	1	K9806Z-2.3/8	
2 7/16	1	K9806Z-2.7/16	
2 1/2	1	K9806Z-2.1/2	
2 9/16	1	K9806Z-2.9/16	
2 5/8	1	K9806Z-2.5/8	
2 11/16	1	K9806Z-2.11/16	
2 3/4	1	K9806Z-2.3/4	
2 13/16	1	K9806Z-2.13/16	
2 7/8	1	K9806Z-2.7/8	
2 15/16	1	K9806Z-2.15/16	
3	1	K9806Z-3	
3 1/16	1	K9806Z-3.1/16	
3 1/8	1	K9806Z-3.1/8	
3 3/16	1	K9806Z-3.3/16	
3 1/4	1	K9806Z-3.1/4	
3 5/16	1	K9806Z-3.5/16	
3 3/8	1	K9806Z-3.3/8	
3 7/16	1	K9806Z-3.7/16	
3 1/2	1	K9806Z-3.1/2	
3 9/16	1	K9806Z-3.9/16	
3 5/8	1	K9806Z-3.5/8	
3 11/16	1	K9806Z-3.11/16	
3 3/4	1	K9806Z-3.3/4	
3 13/16	1	K9806Z-3.13/16	
3 7/8	1	K9806Z-3.7/8	
3 15/16	1	K9806Z-3.15/16	
4	1	K9806Z-4	
4 1/16	1	K9806Z-4.1/16	
4 1/8	1	K9806Z-4.1/8	
4 1/4	1	K9806Z-4.1/4	
4 5/16	1	K9806Z-4.5/16	
4 3/8	1	K9806Z-4.3/8	
4 1/2	1	K9806Z-4.1/2	
4 5/8	1	K9806Z-4.5/8	
4 3/4	1	K9806Z-4.3/4	

Rallonge 1.1/2



### K9860H

Ø			
200	1	K9860H-1	
380	1	K9860H-2	
505	1	K9860H-3	

Douille à choc articulée 1/12



### K9867S

Ø			
1 1/2	1	K9867S	

Adaptateur de 1.1/2 à 1 Pouce et 2.1/2



### K9598H/K9998H

Ø			
1	1	K9598H	
2 1/2	1	K9998H	
1 1/2	2	K9899H	

Jonc de retenue



### K560F-9

Ø			
1 1/2"	5	K560F-9	







## BOÎTES VIDES DE JEUX DE DOUILLES

Coffret vide pour douilles





### -CASE

 mm	 g	 
110 x 375 x 430 mm	2200	1 S103-CASE
110 x 375 x 430 mm	2200	1 S106-CASE
70 x 160 x 280 mm	520	1 S160-CASE
70 x 160 x 280 mm	520	1 S290-CASE
70 x 160 x 280 mm	500	1 S330-CASE
110 x 320 x 375 mm	1620	1 S400-CASE
110 x 320 x 375 mm	1620	1 S410-CASE
100 x 215 x 375 mm	1120	1 S460-CASE
100 x 215 x 375 mm	1120	1 S560-CASE
110 x 375 x 430 mm	2200	1 S800-CASE
110 x 375 x 430 mm	2200	1 S81MIX-CASE
110 x 375 x 430 mm	2200	1 S87+7-CASE
110 x 320 x 375 mm	1620	1 S910-CASE
110 x 375 x 430 mm	2200	1 S108-CASE
110 x 375 x 430 mm	2200	1 SLX17-CASE
110 x 370 x 430 mm	2160	1 S138-CASE
100 x 215 x 375 mm	1120	1 S330L-CASE

Coffret vide



### 4750IB

 mm	 
49 x 152 x 280 mm	1 4750IB-A4
46 x 130 x 195 mm	1 4750IB-A5
35 x 85 x 160 mm	1 4750IB-A6
35 x 80 x 100 mm	1 4750IB-A7



## CLÉS SPÉCIAL ÉCHAFAUDAGE

Clé d'échafaudage



Caisse de rechange vide



### SPARE-CASE

 mm	 
35 x 80 x 100 mm	1 SPAR-CASE-A7
35 x 85 x 160 mm	1 SPAR-CASE-A6
46 x 130 x 195 mm	1 SPAR-CASE-A5
49 x 152 x 280 mm	1 SPAR-CASE-A4

### SC2RM

 mm	 
13-17	10 SC2RM-13-17
15-17	10 SC2RM-15-17
19-22	5 SC2RM-19-22
27-30	1 SC2RM-27-30





## Outillage dynamométrique



## CLÉS DYNAMOMÉTRIQUES ÉLECTRONIQUES

Clé dynamométrique électronique à tête rectangulaire pour embouts pour têtes interchangeables



### IZO-D

Nm	in-lb	ft-lb	
3-30 Nm	26.6-265.5 lb-in	2.21-22.13 lb-ft	1 IZO-D-30
13.5-135 Nm	62-1195 lb-in	10-99.57 lb-ft	1 IZO-D-135
20-200 Nm	177-1770 lb-in	14.75-147.50 lb-ft	1 IZO-D-200
34-340 Nm	301-3009 lb-in	25.07-250.80 lb-ft	1 IZO-D-340

Clé dynamométrique électronique à tête de cliquet fixe  
Clé dynamométrique débrayable



### IZO-DR

Nm	in-lb	ft-lb	
81-810	716.9-7169	59.74-5974.2	1 IZO-DR-810

Clé électronique couple et angle, tête rectangulaire pour embouts



### TAW9

Nm	in-lb	ft-lb	
7-135 Nm	62-1194 lb-in	5.2-99.5 lb-ft	1 TAW9135
17-340 Nm	150.5-3009 lb-in	12.5-250 lb-ft	1 TAW14340
40-800 Nm	354-7080 lb-in	29.5-590 lb-ft	1 TAW24800

Clé électronique couple et angle, tête de cliquet fixe



### TAW

Nm	in-lb	ft-lb	
7-135	62-1194	5.2-99.5	1 TAW38135
17-340	150.5-3009	12.5-250	1 TAW12340
40-800	354-7080	29.5-590	1 TAW34800

Clé électronique couple et angle fine, tête rectangulaire pour embouts



### TAW930M/TAW912M

Nm	in-lb	ft-lb	
0.6-12 Nm	4.4-88 lb-ft	0.37-7.38 lb-in	1 TAW912M
1.5-30 Nm	1.1-22.1 lb-ft	13.2-265 lb-in	1 TAW930M

Clé électronique couple et angle fine, tête de cliquet fixe



### TAW1430M/TAW1412M

Nm	in-lb	ft-lb	
0.6-12 Nm	4.4-88 lb-in	0.37-7.38 lb-ft	1 TAW1412M
1.5-30 Nm	13.2-265 lb-in	1.1-22.1 lb-ft	1 TAW1430M

Clé électronique couple et angle fine avec mémoire/USB et tête rectangulaire pour embouts  
Avec téléchargement de données mémoire et USB



**TAWM9**

Nm		lb-in		lb-ft		Icons	
7-135	Nm	62-1194	lb-in	5.2-99.5	lb-ft	1	TAWM9135
17-340	Nm	150.5-3009	lb-in	12.5-250	lb-ft	1	TAWM14340
40-800	Nm	354-7080	lb-in	29.5-590	lb-ft	1	TAWM24800

Clé électronique couple et angle avec mémoire/USB, tête de cliquet fixe avec téléchargement de mémoire et USB



**TAWM**

Nm		lb-in		lb-ft		Icons	
7-135	Nm	62-1194	lb-in	5.2-99.5	lb-ft	1	TAWM38135
17-340	Nm	150.5-3009	lb-in	12.5-250	lb-ft	1	TAWM12340
40-800	Nm	354-7080	lb-in	29.5-590	lb-ft	1	TAWM34800

Clé électronique fine couple et angle avec mémoire/USB et tête rectangulaire pour embouts



**TAWM930M/TAWM912M**

Nm		lb-in		lb-ft		Icons	
0.6-12	Nm	5.3-106	lb-in	0.44-8.85	lb-ft	1	TAWM912M
1.5-30	Nm	13.2-265	lb-in	1.1-22.1	lb-ft	1	TAWM930M

Clé électronique fine couple et angle avec mémoire/USB, tête de cliquet fixe



**TAWM1430M/TAWM1412M**

Nm		lb-ft		lb-in		Icons	
0.6-12	Nm	0.44-8.85	lb-ft	5.3-106	lb-in	1	TAWM1412M
1.5-30	Nm	13.2-265	lb-ft	1.1-22.1	lb-in	1	TAWM1430M

**CLÉS DYNAMOMÉTRIQUES MÉCANIQUES**

Clé dynamométrique mécanique à déclenchement, prise en main positionnement libre avec tête de cliquet fixe



**75R3/75R1**

Nm		lb-ft		in		Icons	
130-650	Nm	100-480	lb-ft	3/4"	in	1	75R3-650
200-800	Nm	150-600	lb-ft	3/4"	in	1	75R3-800
300-1000	Nm	220-750	lb-ft	3/4"	in	1	75R3-1000
500-1500	Nm	370-1100	lb-ft	1"	in	1	75R1-1500

Clé dynamométrique mécanique à déclenchement, prise en main positionnement libre avec tête mâle ronde pour embouts



**75S-650**

Nm		lb-ft		mm		Icons	
130-650	Nm	100-480	lb-ft	22	mm	1	75S-650



Clé dynamométrique mécanique à déclenchement avec échelle graduée et tête de cliquet fixe



**7455**

Nm	lbf-in	lbf-ft	
1-5	11-42		1 7455-5
3-15	31-128		1 7455-15
4-20	40-173		1 7455-20
5-25	49-217		1 7455-25
10-60		9.2-42.4	1 7455-60
20-100		16.6-71.9	1 7455-100
20-100 Nm		16.6-71.9 lb-ft	1 7455-100A
40-200		37-140	1 7455-200
60-300		52-314	1 7455-300
60-340		52-243	1 7455-340
100-500		83-359.6	1 7455-500
150-800		129-572	1 7455-800
200-1000 Nm		184-701 lb-ft	1 7455-1000

Clé dynamométrique mécanique à déclenchement avec échelle graduée, tête de cliquet fixe et poignée 2 sections



**7455-1500**

Nm	lbf-in	in	
300-1500	258-1069	1 in	1 7455-1500

Clé dynamométrique mécanique à déclenchement avec échelle graduée, tête carré conducteur 1" fixe



**7455-2500**

Nm	lbf-in	in	
500-2500	406-1807	1 in	1 7455-2500

Clé dynamométrique mécanique à déclenchement avec échelle graduée et tête rectangulaire pour embouts



**7465**

Nm	lbf-in	lbf-ft	
1-5	11-42		1 7465-5
3-15	31-128		1 7465-15
6-30	53-265		1 7465-30
10-60		9.2-42.4 lb-ft	1 7465-60
20-100		16.6-71.9 lb-ft	1 7465-100
40-200		37-140 lb-ft	1 7465-200
60-340		52-243 lb-ft	1 7465-340
150-800		129-572 lb-ft	1 7465-800

Clé dynamométrique mécanique à déclenchement avec échelle graduée, tête rectangulaire pour embouts et poignée 2 sections



**7465-1500**

Nm	lbf-in	mm	
300-1500	258-1069 lb-ft	27x36 mm	1 7465-1500

Clé dynamométrique mécanique à déclenchement avec échelle graduée et tête de cliquet flexible



**7456**

lbf-in	in	lbf-ft	
10-80	3/8 in	0.5	1 7456-80LB

Clé dynamométrique mécanique à cassure avec fenêtre de visualisation et tête de cliquet fixe



**76R3**

Nm	lbf-ft	in	
120-600 Nm	100-450 lb-ft	3/4 in	1 76R3-600
200-800 Nm	150-600 lb-ft	3/4 in	1 76R3-800
300-1000 Nm	200-750 lb-ft	3/4 in	1 76R3-1000

Clé dynamométrique mécanique à cassure avec fenêtre de visualisation et tête mâle ronde pour embouts



**76S-600**

Nm	lbf-ft	mm	
120-600 Nm	100-450 lb-ft	22	1 76S-600

Clé dynamométrique mécanique réglable à déclenchement avec fenêtre de visualisation et tête de cliquet fixe



**74WR-15/74WR-25**

Nm	in-lb	in	
3-15 Nm	27-132 lb-in	1/4 in	1 74WR-15
5-25 Nm	44-220 lb-in	1/4 in	1 74WR-25

Clé dynamométrique mécanique réglable à déclenchement avec fenêtre de visualisation et tête de cliquet fixe à carré traversant



**74WR-50/74WR-400**

Nm	lbf-ft	mm	
10-50 Nm	7.5-37.5 lb-ft	3/8"	1 74WR-50
20-100 Nm	15-75 lb-ft	1/2"	1 74WR-100
40-200 Nm	30-150 lb-ft	1/2"	1 74WR-200
60-300 Nm	45-220 lb-ft	1/2"	1 74WR-300
60-340 Nm	45-250 lb-ft	1/2"	1 74WR-340
80-400 Nm	60-300 lb-ft	3/4"	1 74WR-400

Clé dynamométrique mécanique ajustable à déclenchement avec fenêtre de visualisation et tête mâle ronde pour embouts



**74WS-15/74WS-300**

Nm	lbf-in	
3-15 Nm	27-132 lb-in	1 74WS-15
5-25 Nm	44-220 lb-in	1 74WS-25
10-50 Nm	7.5-37.5 lb-ft	1 74WS-50
20-100 Nm	15-75 lb-ft	1 74WS-100
40-200 Nm	30-150 lb-ft	1 74WS-200
60-300 Nm	45-220 lb-ft	1 74WS-300

Clé dynamométrique mécanique ajustable à déclenchement avec fenêtre de visualisation et tête rectangulaire pour embouts



**74W9/74W14**

Nm	in-lb	
3-15 Nm	27-132 lb-in	1 74W9-15
5-25 Nm	44-220 lb-in	1 74W9-25
10-50 Nm	7.5-37.5 lb-ft	1 74W9-50
20-100 Nm	15-75 lb-ft	1 74W9-100
40-200 Nm	30-150 lb-ft	1 74W9-200
40-200 Nm	30-150 lb-ft	1 74W14-200
60-300 Nm	45-220 lb-ft	1 74W14-300
80-400 Nm	60-300 lb-ft	1 74W14-400



Clé dynamométrique mécanique à cadran, carré conducteur fixe et poignée caoutchouc



**7454**

Nm	lbf·ft	lbf·in		
0.7-3.5	6-30		1	7454-3
1.8-9	14-75		1	7454-9
3.5-18	30-150		1	7454-18
7-35	60-300		1	7454-35
14-70		10-50	1	7454-70
28-140		20-100	1	7454-140
48-240		35-175	1	7454-240

Clé dynamométrique mécanique à cadran, carré conducteur fixe et poignée métallique



**7454-480/7454-800**

Nm	lbf·ft	in		
100-480	70-350	3/4 in	1	7454-480
160-800	120-600	3/4 in	1	7454-800

Clé dynamométrique mécanique à cadran, carré conducteur fixe et poignée 2 sections



**7454-1400**

Nm	lbf·ft	in		
275-1400	200-1000	1 in	1	7454-1400

Clé dynamométrique mécanique à cadran et LED, carré conducteur fixe

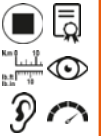

**7454-800E**

Nm	lbf·ft	in		
160-800	0-600	3/4 in	1	7454-800E

Clé dynamométrique mécanique à cadran et LED, carré conducteur fixe et poignée 2 sections

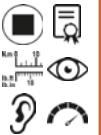

**7454-1400E**

Nm	lbf·ft	in		
275-1400	200-1000	1 in	1	7454-1400E

Clé dynamométrique mécanique pré-réglée avec tête de cliquet fixe



**74PR-20**

Nm	in	L		
4-20 Nm	1/4 in	219	1	74PR-20

Clé dynamométrique mécanique pré-réglée à déclenchement avec tête de cliquet à carré traversant



**74PR-60/74PR-400**

Nm	in	L	
12-60 Nm	3/8 in	295	1 74PR-60
12-60 Nm	1/2 in	301	1 74PR-60A
20-100 Nm	3/8 in	335	1 74PR-100
20-100 Nm	1/2 in	342	1 74PR-100A
40-200 Nm	1/2 in	425	1 74PR-200
60-300 Nm	1/2 in	668	1 74PR-300
80-400 Nm	3/4 in	675	1 74PR-400

Clé dynamométrique mécanique pré-réglée à déclenchement, avec tête mâle ronde pour embouts et poignée en plastique

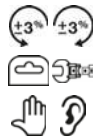

**74PS-20**

Nm	mm	L	
4-20 Nm	16	206	1 74PS-20

Clé dynamométrique mécanique pré-réglée à déclenchement, avec tête mâle ronde pour embouts et poignée en caoutchouc

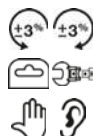

**74PS-60/74PS-300**

Nm	mm	L	
12-60 Nm	16	283	1 74PS-60
20-100 Nm	16	324	1 74PS-100
40-200 Nm	16	405	1 74PS-200
60-300 Nm	16	643	1 74PS-300

Clé dynamométrique mécanique pré-réglée à déclenchement, avec tête rectangulaire pour embouts et poignée en plastique



**74P9-20**

Nm	mm	L	
4-20 Nm	9x12 mm	205	1 74P9-20

Clé dynamométrique mécanique pré-réglée à déclenchement, avec tête rectangulaire pour embouts et poignée en caoutchouc

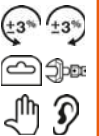

**74P9-60/74P14-400**

Nm	mm	L	
12-60 Nm	9x12 mm	286	1 74P9-60
20-100 Nm	9x12 mm	326	1 74P9-100
40-200 Nm	14x18 mm	403	1 74P14-200
60-300 Nm	14x18 mm	534	1 74P14-300
80-400 Nm	14x18 mm	652	1 74P14-400

Clé dynamométrique mécanique à déclenchement pré-réglée, prise en main positionnement libre avec tête de cliquet fixe



**75P3/75P1**

Nm	in	L	
130-650 Nm	3/4 in		1 75P3-650
200-800 Nm	3/4" in	1030	1 75P3-800
300-1000 Nm	3/4" in	1238	1 75P3-1000
500-1500 Nm	1" in	1563	1 75P1-1500



Clé dynamométrique mécanique à déclenchement pré-réglée, prise en main positionnement libre avec tête mâle ronde pour embouts



**75PS-650**

130-650 Nm	22 mm	800	1	75PS-650

Rallonge pour clé dynamométrique à déclenchement, série 75



**75EXT**

700	60 mm	1.600 kg	1	75EXT

**ADAPTATEURS COUPLE ET ANGLE**

Clés angulaire de serrage magnétique 1/2"



**7851-M/8951-M**

1/2 in 3/4 in	490	1	7851-M 8951-M

Clé angulaire de serrage avec pince 1/2"



**7851-G**

1/2 in	555	1	7851-G

Clé angulaire de serrage électronique



**MAM**

0-360°	1	MAM50M

Adaptateurs électroniques couple et angle



**TAM**

Nm	in-lb	ft-lb		
1,5-30	13-266	1-22	1	TAM1430
6,8-135	60-1194	5-100	1	TAM38135
6,8-135	60-1194	5-100	1	TAM12135
10-200	88,5-1770	7,4-147,5	1	TAM12200
17-340	150,5-3009	12,5-251	1	TAM12340



# TOURNEVIS DYNAMOMÉTRIQUES

Tournevis électronique couple et angle



## TAS14

Nm	cNm	lbf-in	Icons
0.45-9 Nm	45-900 cNm	4-80 lbf-in	1 TAS14H09
0.45-9 Nm	45-900 cNm	4-80 lbf-in	1 TAS14S09
0.04-0.7 Nm	3.5-70 cNm	3.1-61.9 lbf-in	1 TAS14H007
0.04-0.7 Nm	3.5-70 cNm	3.1-61.9 lbf-in	1 TAS14S007

Tournevis dynamométrique réglable avec échelle et fenêtre de visualisation



## 6973N-6978N

cNm	in	in	Icons
10-80 cNm	1/4 in	1/4 in	1 6973N
40-200 cNm	1/4 in	1/4 in	1 6976N
50-450 cNm	1/4 in	1/4 in	1 6978N

Tournevis dynamométrique réglable avec échelle graduée en cNm



## TSS120

cNm	in	cNm	Icons
10-120 cNm	1/4 in	1	1 TSS120

Tournevis dynamométrique réglable avec échelle graduée en Nm



## TSS600

Nm	in	Nm	Icons
1-6 Nm	1/4 in	0.1	1 TSS600

Mini clé dynamométrique réglable avec carré conducteur 1/4"



## 6852-5

Nm	in	Nm	Icons
1-5	1/4 in	0.1	1 6852-5

Coffret de mini clé dynamométrique réglable avec carré conducteur 1/4" et embouts



## 6852-5/S17

mm	kg	Icons
200x70x32	0.29 kg	1 6852-5/S17

### KM653-QR

6852-5		
6700SM-4		
59S/PH0, 59S/PH1		
59S/PZ0, 59S/PZ1		
59S/H1.5		
59S/0.8-5.5, 59S/0.6-4.5		
59S/T6, 59S/T7, 59S/T8		



Tournevis dynamométrique pré-réglé avec échelle et fenêtre de visualisation



**6873N-6880N**

Scale	Hex	Square	Icons
7-70 cNM	1/4 in	1/4 in	1 6876N
15-170 cNM	1/4 in	1/4 in	1 6878N
45-450 cNM	1/4 in	1/4 in	1 6880N

Mini clé dynamométrique pré-réglée avec carré conducteur 1/4"



**6852P-5**

Scale	Hex	Length	Icons
1-5 Nm	1/4" in	157	1 6852P-5

Tournevis dynamométrique pré-réglé fixe ERGO™  
Avec lames TORX® et TORX Plus®

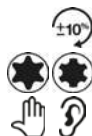

**BE-6990**

Scale	TORX	TORX Plus	Icons
0.6	T6	IP6	1 BE-6990-IP6
0.9	T7	IP7	1 BE-6990-IP7
1.2	T8	IP8	1 BE-6990-IP8
1.4	T9	IP9	1 BE-6990-IP9
2	T10	IP10	1 BE-6990-IP10
3	T15	IP15	1 BE-6990-IP15

Jeu de tournevis dynamométriques pré-réglés fixes ERGO™



**BE-6990-IPSET**

Weight	Icons	Quantity
0.755 kg		1 BE-6990-IPSET

BE-6990-IP7, BE-6990-IP8, BE-6990-IP9, BE-6990-IP15

Lames de tournevis dynamométrique avec embout TORX®



**BE-6990TX-KL**

Bit	Weight	Length	Quantity	Part No.
T6	1.70	160	10	BE-6990TX-T6-KL
T7	1.99	160	10	BE-6990TX-T7-KL
T8	2.31	160	10	BE-6990TX-T8-KL
T9	2.50	170	10	BE-6990TX-T9-KL
T10	2.74	170	10	BE-6990TX-T10KL
T15	3.27	170	10	BE-6990TX-T15KL

Lames de tournevis dynamométrique avec embout TORX PLUS®



**BE-6990-IP-KL**

Bit	Weight	Length	Quantity	Part No.
IP6	1.50	170	10	BE-6990-IP6-KL
IP7	1.99	170	10	BE-6990-IP7-KL
IP8	2.31	170	10	BE-6990-IP8-KL

IP9	2.50	170	10	BE-6990-IP9-KL
IP10	2.74	170	10	BE-6990-IP10-KL
IP15	3.27	170	10	BE-6990-IP15-KL

## TESTEURS DE COUPLE

Testeurs multifonctions pour clés et tournevis dynamométriques



### TEA003-TEA030

0.1-3.0 Nm	0.074-2.212 lb-ft	0.89-26.5 lb-in	1	TEA003
0.5-10 Nm	0.37-7.37 lb-ft	4.43-88.5 lb-in	1	TEA010
1.5-30 Nm	1.11-22.1 lb-ft	13.3-265 lb-in	1	TEA030



Testeurs multifonctions pour clés dynamométriques



### TEA065-TEA2100

3-65 Nm	2.21-47.9 lb-ft	26.6-575 lb-in	1	TEA065
10-350 Nm	7.4-258.1 lb-ft	89-3098 lb-in	1	TEA350
50-1100 Nm	36.9-811.3 lb-ft	443-9736 lb-in	1	TEA1100
200-2100 Nm	148-1548 lb-ft	1771-18586 lb-in	1	TEA2100



## EMBOUTS

Augmentateur/Réducteur, attachement rectangulaire



### 9/14/24/27A

mm	mm			
9x12 mm	14x18 mm	42	1	9A-14
14x18 mm	9x12 mm	27	1	14A-9
14x18 mm	24x32 mm	65	1	14A-32
24x32 mm	14x18 mm	42	1	24A-14
24x32 mm	27x36 mm	65	1	24A-27
27x36 mm	24x32 mm	65	1	27A-24

Embout à souder, attachement rectangulaire



### 9/14/24W

mm			
9x12 mm	23	1	9W
14x18 mm	39	1	14W
24x32 mm	65	1	24W



Tête de cliquet réversible rond, attachement rectangulaire



**9/14/24/27R**

in	mm	max		
1/4 in	9x12 mm	30	1	9R-1/4
3/8 in	9x12 mm	135	1	9R-3/8
1/2 in	9x12 mm	160	1	9R-1/2
1/2 in	14x18 mm	340	1	14R-1/2
3/4 in	14x18 mm	420	1	14R-3/4
3/4 in	24x32 mm	1000	1	24R-3/4
1 in	24x32 mm	1200	1	24R-1
1 in	27x36 mm	2500	1	27R-1

Tête de cliquet à carré traversant, attachement rectangulaire



**9/14/24/27T**

in	mm			
1/4 in	9x12 mm	1	9T-1/4	
3/8 in	9x12 mm	1	9T-3/8	
1/2 in	9x12 mm	1	9T-1/2	
1/2 in	14x18 mm	1	14T-1/2	
3/4 in	14x18 mm	1	14T-3/4	
3/4 in	24x32 mm	1	24T-3/4	
1 in	24x32 mm	1	24T-1	
1 in	27x36 mm	1	27T-1	

Tête de cliquet réversible, attachement rectangulaire



**9/14P**

in	mm			
1/4 in	9x12 mm	1	9P-1/4	
3/8 in	9x12 mm	1	9P-3/8	

in	mm			
1/2 in	9x12 mm	1	9P-1/2	
1/2 in	14x18 mm	1	14P-1/2	

Tête de cliquet réversible à déverrouillage rapide, attachement rectangulaire



**9/14Q**

in	mm			
1/4 in	9x12 mm	1	9Q-1/4	
3/8 in	9x12 mm	1	9Q-3/8	
1/2 in	9x12 mm	1	9Q-1/2	
1/2 in	14x18 mm	1	14Q-1/2	

Tête de cliquet pour embouts, attachement rectangulaire



**9B**

in	mm			
1/4 in	9x12 mm	1	9B-1/4	
5/16 in	9x12 mm	1	9B-5/16	

Tête carrée fixe, attachement rectangulaire



**9/14/24/27F**

in	mm			
1/4 in	9x12 mm	1	9F-1/4	
3/8 in	9x12 mm	1	9F-3/8	

in	mm		
1/2 in	9x12 mm	1	9F-1/2
1/2 in	14x18 mm	1	14F-1/2
3/4 in	14x18 mm	1	14F-3/4
3/4 in	24x32 mm	1	24F-3/4
1 in	24x32 mm	1	24F-1
1 in	27x36 mm	1	27F-1

### Embout à fourche dimensions métriques, attachement rectangulaire



#### 9/14/24/277

mm	mm	mm	
7 mm	9x12 mm	9	1 97-7
8 mm	9x12 mm	13	1 97-8
9 mm	9x12 mm	18	1 97-9
10 mm	9x12 mm	24	1 97-10
11 mm	9x12 mm	32	1 97-11
12 mm	9x12 mm	41	1 97-12
13 mm	9x12 mm	51	1 97-13
14 mm	9x12 mm	63	1 97-14
15 mm	9x12 mm	77	1 97-15
16 mm	9x12 mm	92	1 97-16
17 mm	9x12 mm	109	1 97-17
18 mm	9x12 mm	125	1 97-18
19 mm	9x12 mm	145	1 97-19
21 mm	9x12 mm	160	1 97-21
22 mm	9x12 mm	160	1 97-22
24 mm	9x12 mm	160	1 97-24
27 mm	9x12 mm	160	1 97-27
30 mm	9x12 mm	160	1 97-30
32 mm	9x12 mm	160	1 97-32
13 mm	14x18 mm	51	1 147-13
14 mm	14x18 mm	63	1 147-14
15 mm	14x18 mm	77	1 147-15
16 mm	14x18 mm	92	1 147-16
17 mm	14x18 mm	109	1 147-17
18 mm	14x18 mm	125	1 147-18
19 mm	14x18 mm	145	1 147-19
21 mm	14x18 mm	190	1 147-21
22 mm	14x18 mm	220	1 147-22
24 mm	14x18 mm	280	1 147-24
25 mm	14x18 mm	320	1 147-25
27 mm	14x18 mm	360	1 147-27
30 mm	14x18 mm	360	1 147-30
32 mm	14x18 mm	360	1 147-32
33 mm	14x18 mm	360	1 147-33
34 mm	14x18 mm	360	1 147-34
35 mm	14x18 mm	360	1 147-35
36 mm	14x18 mm	360	1 147-36
37 mm	14x18 mm	360	1 147-37
38 mm	14x18 mm	360	1 147-38
39 mm	14x18 mm	360	1 147-39
41 mm	14x18 mm	360	1 147-41
45 mm	14x18 mm	360	1 147-45
46 mm	14x18 mm	360	1 147-46
50 mm	14x18 mm	360	1 147-50
55 mm	14x18 mm	360	1 147-55
60 mm	14x18 mm	360	1 147-60
68 mm	14x18 mm	360	1 147-68

mm	mm	mm	
70 mm	14x18 mm	360	1 147-70
75 mm	14x18 mm	360	1 147-75
90 mm	14x18 mm	360	1 147-90
24 mm	24x32 mm	1200	1 247-24
27 mm	24x32 mm	1200	1 247-27
30 mm	24x32 mm	1200	1 247-30
32 mm	24x32 mm	1200	1 247-32
34 mm	24x32 mm	1200	1 247-34
36 mm	24x32 mm	1200	1 247-36
41 mm	24x32 mm	1200	1 247-41
46 mm	24x32 mm	1200	1 247-46
50 mm	24x32 mm	1200	1 247-50
55 mm	24x32 mm	1200	1 247-55
60 mm	24x32 mm	1200	1 247-60
30 mm	27x36 mm	3000	1 277-30
32 mm	27x36 mm	3000	1 277-32
34 mm	27x36 mm	3000	1 277-34
36 mm	27x36 mm	3000	1 277-36
41 mm	27x36 mm	3000	1 277-41
46 mm	27x36 mm	3000	1 277-46
50 mm	27x36 mm	3000	1 277-50
55 mm	27x36 mm	3000	1 277-55
60 mm	27x36 mm	3000	1 277-60

Inserts à fourche. Dimensions métriques et pouces. 9x12, 14x18, 24x32, 27x36. Acier allié haute performance  
S'adapte sur les clés dynamométriques 7435, 7465, 7452P, 7852P, TAWM9, TAWM14, TAWM24, TAW9, TAW14, TAW24 et IZO-D

### Embout à fourche en pouces, attachement rectangulaire



#### 9/14/24/277"





in	mm	mm	
1/4 in	9x12 mm	6	1 97-1/4
5/16 in	9x12 mm	13	1 97-5/16
3/8 in	9x12 mm	24	1 97-3/8
7/16 in	9x12 mm	32	1 97-7/16
1/2 in	9x12 mm	51	1 97-1/2
17/32 in	9x12 mm	63	1 97-17/32
9/16 in	9x12 mm	77	1 97-9/16
5/8 in	9x12 mm	92	1 97-5/8
11/16 in	9x12 mm	125	1 97-11/16
3/4 in	9x12 mm	145	1 97-3/4
13/16 in	9x12 mm	160	1 97-13/16
7/8 in	9x12 mm	160	1 97-7/8
15/16 in	9x12 mm	160	1 97-15/16
1 in	9x12 mm	160	1 97-1
7/16 in	14x18 mm	32	1 147-7/16
1/2 in	14x18 mm	51	1 147-1/2
9/16 in	14x18 mm	77	1 147-9/16
5/8 in	14x18 mm	92	1 147-5/8
11/16 in	14x18 mm	109	1 147-11/16
3/4 in	14x18 mm	145	1 147-3/4
13/16 in	14x18 mm	190	1 147-13/16
7/8 in	14x18 mm	220	1 147-7/8
15/16 in	14x18 mm	280	1 147-15/16
1 in	14x18 mm	360	1 147-1
1 1/8 in	14x18 mm	360	1 147-1.1/8
1 1/4 in	14x18 mm	360	1 147-1.1/4



Embout polygonal dimensions métriques, attachement rectangulaire







**9/14/24/278**

				
7 mm	9x12 mm	25	1	98-7
8 mm	9x12 mm	34	1	98-8
9 mm	9x12 mm	45	1	98-9
10 mm	9x12 mm	58	1	98-10
11 mm	9x12 mm	47	1	98-11
12 mm	9x12 mm	89	1	98-12
13 mm	9x12 mm	105	1	98-13
14 mm	9x12 mm	125	1	98-14
15 mm	9x12 mm	145	1	98-15
16 mm	9x12 mm	160	1	98-16
17 mm	9x12 mm	160	1	98-17
18 mm	9x12 mm	160	1	98-18
19 mm	9x12 mm	160	1	98-19
21 mm	9x12 mm	160	1	98-21
22 mm	9x12 mm	160	1	98-22
13 mm	14x18 mm	105	1	148-13
14 mm	14x18 mm	125	1	148-14
15 mm	14x18 mm	150	1	148-15
16 mm	14x18 mm	175	1	148-16
17 mm	14x18 mm	200	1	148-17
18 mm	14x18 mm	230	1	148-18
19 mm	14x18 mm	260	1	148-19
21 mm	14x18 mm	330	1	148-21
22 mm	14x18 mm	360	1	148-22
24 mm	14x18 mm	360	1	148-24
27 mm	14x18 mm	360	1	148-27
28 mm	14x18 mm	360	1	148-28
30 mm	14x18 mm	360	1	148-30
32 mm	14x18 mm	360	1	148-32
34 mm	14x18 mm	360	1	148-34
36 mm	14x18 mm	360	1	148-36
41 mm	14x18 mm	360	1	148-41
24 mm	24x32 mm	1200	1	248-24
27 mm	24x32 mm	1200	1	248-27
30 mm	24x32 mm	1200	1	248-30
32 mm	24x32 mm	1200	1	248-32
34 mm	24x32 mm	1200	1	248-34
36 mm	24x32 mm	1200	1	248-36
41 mm	24x32 mm	1200	1	248-41
46 mm	24x32 mm	1200	1	248-46
50 mm	24x32 mm	1200	1	248-50
55 mm	24x32 mm	1200	1	248-55
60 mm	24x32 mm	1200	1	248-60
30 mm	27x36 mm	3000	1	278-30
32 mm	27x36 mm	1240	1	278-32
34 mm	27x36 mm	3000	1	278-34
36 mm	27x36 mm	3000	1	278-36
41 mm	27x36 mm	3000	1	278-41
46 mm	27x36 mm	3000	1	278-46
50 mm	27x36 mm	3000	1	278-50
55 mm	27x36 mm	3000	1	278-55
60 mm	27x36 mm	3000	1	278-60

Embout polygonal en pouces, attachement rectangulaire







**9/14/24/278"**





				
1/4 in	9x12 mm	25	1	98-1/4
5/16 in	9x12 mm	34	1	98-5/16
3/8 in	9x12 mm	58	1	98-3/8
7/16 in	9x12 mm	72	1	98-7/16
1/2 in	9x12 mm	105	1	98-1/2
9/16 in	9x12 mm	125	1	98-9/16
5/8 in	9x12 mm	160	1	98-5/8
11/16 in	9x12 mm	160	1	98-11/16
3/4 in	9x12 mm	57	1	98-3/4
13/16 in	14x18 mm	330	1	148-13/16
13/16 in	9x12 mm	160	1	98-13/16
7/8 in	9x12 mm	160	1	98-7/8
1/2 in	14x18 mm	105	1	148-1/2
9/16 in	14x18 mm	150	1	148-9/16
5/8 in	14x18 mm	175	1	148-5/8
11/16 in	14x18 mm	230	1	148-11/16
3/4 in	14x18 mm	260	1	148-3/4
15/16 in	14x18 mm	360	1	148-15/16
7/8 in	14x18 mm	360	1	148-7/8
1 in	14x18 mm	360	1	148-1

Embout crowfoot, attachement rectangulaire



**99**





				
10 mm		9x12 mm	1	99-10
11 mm		9x12 mm	1	99-11
12 mm		9x12 mm	1	99-12
13 mm		9x12 mm	1	99-13
14 mm		9x12 mm	1	99-14
16 mm		9x12 mm	1	99-16

				
17 mm		9x12 mm	1	99-17
18 mm		9x12 mm	1	99-18
19 mm		9x12 mm	1	99-19
21 mm		9x12 mm	1	99-21
22 mm		9x12 mm	1	99-22
24 mm		9x12 mm	1	99-24
	3/8 in	9x12 mm	1	99-3/8
	7/16 in	9x12 mm	1	99-7/16
	1/2 in	9x12 mm	1	99-1/2
	9/16 in	9x12 mm	1	99-9/16
	5/8 in	9x12 mm	1	99-5/8
	11/16 in	9x12 mm	1	99-11/16
	3/4 in	9x12 mm	1	99-3/4

### Tête de cliquet rond, pour clé à tête mâle ronde







#### 16R/22R

				
1/4" in	16	20	1	16R-1/4
3/8" in	16	160	1	16R-3/8
1/2" in	16	420	1	16R-1/2
3/4" in	22	1200	1	22R-3/4

### Tête carré conducteur fixe, pour clé à tête mâle ronde







#### 16F/22F

				
1/4" in	16	20	1	16F-1/4
3/8" in	16	160	1	16F-3/8
1/2" in	16	420	1	16F-1/2
3/4" in	22	1200	1	22F-3/4

### Embout à fourche dimensions métriques, pour clé à tête mâle ronde



#### 167/227

				
16	7 mm	9	1	167-7
16	8 mm	13	1	167-8
16	9 mm	18	1	167-9
16	10 mm	24	1	167-10
16	11 mm	32	1	167-11
16	12 mm	41	1	167-12
16	13 mm	51	1	167-13
16	14 mm	63	1	167-14
16	15 mm	77	1	167-15
16	16 mm	92	1	167-16
16	17 mm	109	1	167-17
16	18 mm	125	1	167-18
16	19 mm	145	1	167-19
16	20 mm	160	1	167-20
16	21 mm	190	1	167-21
16	22 mm	220	1	167-22
16	23 mm	250	1	167-23
16	24 mm	280	1	167-24
16	25 mm	320	1	167-25
16	26 mm	360	1	167-26
16	27 mm	360	1	167-27
16	28 mm	360	1	167-28
16	30 mm	360	1	167-30
16	32 mm	360	1	167-32
16	36 mm	360	1	167-36
22	22 mm	1200	1	227-22
22	24 mm	1200	1	227-24
22	27 mm	1200	1	227-27
22	30 mm	1200	1	227-30
22	32 mm	1200	1	227-32
22	34 mm	1200	1	227-34
22	36 mm	1200	1	227-36
22	41 mm	1200	1	227-41
22	46 mm	1200	1	227-46



Embout à fourche en pouces, pour clé à tête mâle ronde



167

Ø mm		máx 		
16	5/16 in	34	1	167-5/16
16	3/8 in	45	1	167-3/8
16	7/16 in	72	1	167-7/16
16	1/2 in	51	1	167-1/2
16	9/16 in	77	1	167-9/16
16	5/8 in	92	1	167-5/8
16	11/16 in	109	1	167-11/16
16	3/4 in	145	1	167-3/4
16	13/16 in	190	1	167-13/16
16	7/8 in	220	1	167-7/8
16	15/16 in	280	1	167-15/16
16	1 in	360	1	167-1
16	1.1/16 in	360	1	167-1.1/16
16	1.1/8 in	360	1	167-1.1/8
16	1.3/16 in	360	1	167-1.3/16
16	1.1/4 in	360	1	167-1.1/4

Embout polygonal dimensions métriques, pour clé à tête mâle ronde



168/228

Ø mm		máx 		
16	7 mm	25	1	168-7
16	8 mm	34	1	168-8
16	9 mm	45	1	168-9
16	10 mm	58	1	168-10
16	11 mm	72	1	168-11
16	12 mm	89	1	168-12
16	13 mm	105	1	168-13
16	14 mm	125	1	168-14
16	15 mm	150	1	168-15
16	16 mm	175	1	168-16
16	17 mm	200	1	168-17
16	18 mm	230	1	168-18
16	19 mm	260	1	168-19
16	20 mm	290	1	168-20
16	21 mm	330	1	168-21
16	22 mm	360	1	168-22
16	23 mm	360	1	168-23

Ø mm		máx 		
16	24 mm	360	1	168-24
16	26 mm	360	1	168-26
16	27 mm	360	1	168-27
22	22 mm	1200	1	228-22
22	24 mm	1200	1	228-24
22	27 mm	1200	1	228-27
22	30 mm	1200	1	228-30
22	32 mm	1200	1	228-32
22	34 mm	1200	1	228-34
22	36 mm	1200	1	228-36
22	41 mm	1200	1	228-41
22	46 mm	1200	1	228-46

Embout polygonal en pouces, pour clé à tête mâle ronde



168

Ø mm		máx 		
16	5/16 in	34	1	168-5/16
16	3/8 in	58	1	168-3/8
16	7/16 in	89	1	168-7/16
16	1/2 in	105	1	168-1/2
16	9/16 in	125	1	168-9/16
16	5/8 in	125	1	168-5/8
16	11/16 in	125	1	168-11/16
16	3/4 in	260	1	168-3/4
16	13/16 in	290	1	168-13/16
16	7/8 in	360	1	168-7/8
16	15/16 in	360	1	168-15/16
16	1 in	360	1	168-1
16	1.1/16 in	360	1	168-1.1/16
16	1.3/16 in	360	1	168-1.3/16

Embout crowfoot dimensions métriques, pour clé à tête mâle ronde



169

Ø mm		máx 		
16	7 mm	6	1	169-7
16	8 mm	8	1	169-8
16	9 mm	10	1	169-9



mm	mm	mm		
16	10 mm	12	1	169-10
16	11 mm	16	1	169-11
16	12 mm	16	1	169-12
16	13 mm	28	1	169-13
16	14 mm	31	1	169-14
16	15 mm	38	1	169-15
16	16 mm	46	1	169-16
16	17 mm	53	1	169-17
16	18 mm	65	1	169-18
16	19 mm	74	1	169-19
16	20 mm	86	1	169-20
16	21 mm	100	1	169-21
16	22 mm	115	1	169-22
16	23 mm	125	1	169-23
16	24 mm	145	1	169-24
16	27 mm	160	1	169-27

## Multiplicateur de couple manuel avec plaque de réaction



### 9505/9605/9525/9625

MAX Nm	in			
3400	3/4 in	5:1	1	9505-3400
3400	1/2 in	25:1	1	9525-3400
9500	3/4 in	25:1	1	9625-9500

## MULTIPLICATEURS

Multiplicateur de couple manuel, avec bras de réaction coudé et droit



### 89049TM-1000

MAX Nm	in			
1000 Nm	1/2 in	4.8:1/4.9:1*	1	89049TM-1000

Multiplicateur de couple manuel, avec bras de réaction coudé et droit



### 8905-TM/9505-TM

MAX Nm	in			
1300	3/4 in	5:1	1	8905-TM
2700	1 in	5:1	1	9505-TM

Multiplicateur de couple manuel avec bras de réaction droit



### 95155B/9526B

MAX Nm	in			
3000	1/2 in	15.5:1	1	95155B-3000
4500	1/2 in	26:1	1	9526B-4500

Multiplicateur de couple manuel compact avec bras de réaction coudé



### 89222CR/96255CR

MAX Nm	in			
1000	1/2 in	22.2:1	1	89222CR-1000
2000	1/2 in	27:1	1	9527CR-2000
4000	1/2 in	25:1	1	9525CR-4000
7000	1/2 in	25.5:1	1	96255CR-7000



## SOLUTIONS DE CONTRÔLE ANTI-ERREUR

Unité de contrôle de clé dynamométrique pré-réglée sans fil



### WPCU2S

E	1.150 kg	1	WPCU2S

Clé dynamométrique pré-réglée sans fil à tête rectangulaire pour embouts



### WPTC

1-5 Nm	9x12 mm	176	1	WPTC-5
3-15 Nm	9x12 mm	176	1	WPTC-15
5-25 Nm	9x12 mm	227	1	WPTC-25
10-60 Nm	9x12 mm	324	1	WPTC-60
20-100 Nm	9x12 mm	324	1	WPTC-100
40-200 Nm	14x18 mm	411	1	WPTC-200
60-300 Nm	14x18 mm	528	1	WPTC-300

Outil de réglage de clé dynamométrique pré-réglée sans fil



### WPTC-AT

130	1	WPTC-AT



## Accessoires pour outils énergisés



## SCIES TRÉPANS

Scies trépan Sandflex bimétal



### 3830

14	1	3830-14-C
16	1	3830-16-C
17	1	3830-17-C
19	1	3830-19-C
20	1	3830-20-C
21	1	3830-21-C
22	1	3830-22-C
24	1	3830-24-C
25	1	3830-25-C
27	1	3830-27-C
29	1	3830-29-C
30	1	3830-30-C
32	1	3830-32-C
33	1	3830-33-C
35	1	3830-35-C
37	1	3830-37-C
38	1	3830-38-C
40	1	3830-40-C
41	1	3830-41-C
43	1	3830-43-C
44	1	3830-44-C
46	1	3830-46-C
48	1	3830-48-C
50	1	3830-50-C
51	1	3830-51-C
52	1	3830-52-C
54	1	3830-54-C
55	1	3830-55-C
56	1	3830-56-C
57	1	3830-57-C
59	1	3830-59-C
60	1	3830-60-C
64	1	3830-64-C
65	1	3830-65-C
67	1	3830-67-C
68	1	3830-68-C
70	1	3830-70-C
73	1	3830-73-C
76	1	3830-76-C
79	1	3830-79-C
83	1	3830-83-C
86	1	3830-86-C
89	1	3830-89-C
92	1	3830-92-C
95	1	3830-95-C
98	1	3830-98-C
102	1	3830-102-C
105	1	3830-105-C
108	1	3830-108-C

111	1	3830-111-C
114	1	3830-114-C
121	1	3830-121-C
127	1	3830-127-C
133	1	3830-133-C
140	1	3830-140-C
146	1	3830-146-C
152	1	3830-152-C
14	6	3830-14-VIP
16	6	3830-16-VIP
17	6	3830-17-VIP
19	6	3830-19-VIP
20	6	3830-20-VIP
21	6	3830-21-VIP
22	6	3830-22-VIP
24	6	3830-24-VIP
25	6	3830-25-VIP
27	6	3830-27-VIP
29	6	3830-29-VIP
30	6	3830-30-VIP
32	6	3830-32-VIP
33	6	3830-33-VIP
35	6	3830-35-VIP
37	6	3830-37-VIP
38	6	3830-38-VIP
40	6	3830-40-VIP
41	6	3830-41-VIP
43	6	3830-43-VIP
44	6	3830-44-VIP
46	6	3830-46-VIP
48	6	3830-48-VIP
50	6	3830-50-VIP
51	6	3830-51-VIP
52	4	3830-52-VIP
54	4	3830-54-VIP
55	4	3830-55-VIP
56	4	3830-56-VIP
57	4	3830-57-VIP
59	4	3830-59-VIP
60	4	3830-60-VIP
62	4	3830-62-VIP
64	4	3830-64-VIP
65	4	3830-65-VIP
67	4	3830-67-VIP
68	4	3830-68-VIP
70	4	3830-70-VIP
73	4	3830-73-VIP
76	4	3830-76-VIP
79	4	3830-79-VIP
83	4	3830-83-VIP
86	4	3830-86-VIP
89	4	3830-89-VIP
92	4	3830-92-VIP
95	4	3830-95-VIP
98	4	3830-98-VIP
102	4	3830-102-VIP
105	4	3830-105-VIP
108	4	3830-108-VIP
111	4	3830-111-VIP
114	4	3830-114-VIP
121	1	3830-121-VIP
127	1	3830-127-VIP
133	1	3830-133-VIP
140	1	3830-140-VIP
146	1	3830-146-VIP
152	1	3830-152-VIP
168	1	3830-168
177	1	3830-177-HIGH
210	1	3830-210

Coffret de scies trépan Sandflex® bimétal, pack de 4



### 3830-4P

4	19	1	3830-19-4P
	20	1	3830-20-4P
	22	1	3830-22-4P
	25	1	3830-25-4P
	27	1	3830-27-4P
	29	1	3830-29-4P
	30	1	3830-30-4P
	32	1	3830-32-4P
	35	1	3830-35-4P

Coffret de scies trépan Sandflex® bimétal 20 mm-76 mm - 10 Pcs



### 3834-PROMO-82

1188	1	3834-PROMO-82

3830-20-C, 3830-25-C, 3830-30-C, 3830-35-C, 3830-44-C, 3830-51-C, 3830-64-C, 3830-76-C

3834-ARBR-930

3834-ARBR-11152QC

Coffret de scies trépan Sandflex® bimétal 16 mm-44 mm - 14 Pcs



### 3834-PROMO-122

1100	1	3834-PROMO-122

3830-16-C, 2x 3830-20-C, 3830-22-C, 2x 3830-25-C, 3830-29-C, 3830-32-C, 2x 3830-35-C, 3830-38-C, 3830-44-C

3834-ARBR-930

3834-ARBR-11152QC

Coffret de scies trépan Sandflex® bimétal 19 mm-76 mm - 14 Pcs



**3834-PROMO-122-76**

g 1441 1 3834-PROMO-122-76

3830-19-C, 3830-20-C, 3830-22-C, 3830-25-C, 3830-27-C, 3830-32-C, 3830-35-C, 3830-38-C, 3830-40-C, 3830-51-C, 3830-64-C, 3830-76-C

3834-ARBR-930

3834-ARBR-9100

Coffret de scies trépan Sandflex® bimétal 35 mm-83 mm - 9 Pcs



**3834-SET-72-35/83**

g 1613 1 3834-SET-72-35/83

3830-35-C, 3830-40-C, 3830-44-C, 3830-51-C, 3830-57-C, 3830-68-C, 3830-83-C

3834-ARBR-9100

3834-DRL

Coffrets de scies trépan Sandflex bimétal



**3834-42**

g 2025 1 3834-SET-42

3830-51-VIP, 3830-76-VIP, 3830-86-VIP, 3830-111-VIP

3834-ARBR-9100

3834-ES

Coffrets de scies trépan Sandflex bimétal



**3834-53**

g 2370 1 3834-SET-53

3830-19-VIP, 3830-22-VIP, 3830-25-VIP, 3830-29-VIP, 3830-30-VIP, 3830-35-VIP, 3830-37-VIP, 3830-41-VIP, 3830-52-VIP, 3830-60-VIP, 3830-79-VIP

3834-ARBR-930

3834-ARBR-9100

Coffrets de scies trépan Sandflex bimétal



**3834-61**

g 3145 1 3834-SET-61

3830-44-VIP, 3830-51-VIP, 3830-57-VIP, 3830-73-VIP, 3830-86-VIP, 3830-114-VIP

3834-ARBR-9100

Coffrets de scies trépan Sandflex bimétal



**3834-62**

g 1050 1 3834-SET-62

3830-19-VIP, 3830-21-VIP, 3830-22-VIP, 3830-29-VIP, 3830-38-VIP, 3830-48-VIP

3834-ARBR-930

3834-ARBR-9100



Coffrets de scies trépan Sandflex bimétal



**3834-62-16/50**

1065	1	3834-SET-62-16/50

3830-16-VIP, 3830-20-VIP, 3830-25-VIP, 3830-32-VIP, 3830-40-VIP, 3830-50-VIP	
3834-ARBR-9100	
3834-ARBR-930	

Coffrets de scies trépan Sandflex bimétal



**3834-65-22/64**

1625	1	3834-SET-65-22/64

3830-22-VIP, 3830-29-VIP, 3830-35-VIP, 3830-44-VIP, 3830-51-VIP, 3830-64-VIP	
3834-ARBR-1130	
3834-ARBR-11152	
3834-DRL	

Coffrets de scies trépan Sandflex bimétal



**3834-73**

2080	1	3834-SET-73

3830-16-VIP, 3830-22-VIP, 3830-51-VIP, 3830-57-VIP, 3830-73-VIP, 3830-76-VIP, 3830-92-VIP	
3834-ARBR-930	
3834-ARBR-9100	

Coffrets de scies trépan Sandflex bimétal



**3834-65-16/51**

1465	1	3834-SET-65-16/51

3830-16-VIP, 3830-20-VIP, 3830-25-VIP, 3830-32-VIP, 3830-40-VIP, 3830-51-VIP	
3834-ARBR-1130	
3834-ARBR-11152	
3834-DRL	

Coffrets de scies trépan Sandflex bimétal



**3834-72**

1080	1	3834-SET-72

3830-19-VIP, 3830-22-VIP, 3830-29-VIP, 3830-35-VIP, 3830-44-VIP, 3830-51-VIP, 3830-64-VIP	
3834-ARBR-930	
3834-ARBR-9100	

Coffrets de scies trépan Sandflex bimétal



**3834-73-22/68**

2170	1	3834-SET-73-22/68

3830-22-VIP, 3830-29-VIP, 3830-35-VIP, 3830-44-VIP, 3830-51-VIP, 3830-64-VIP, 3830-68-VIP	
3834-ARBR-1130	
3834-ARBR-11152	
3834-DRL	





Coffrets de scies trépan Sandflex bimétal



**3834-SET-77**

**g**  1 3834-SET-77

3325

- 3830-16-VIP, 3830-20-VIP, 3830-25-VIP, 3830-32-VIP, 3830-41-VIP, 3830-51-VIP, 3830-73-VIP, 3830-76-VIP, 3830-83-VIP, 3830-86-VIP 
- 3834-ARBR-930 
- 3834-ARBR-9100 
- 3834-DRL 





Coffret de scies trépan Sandflex® bimétal 25 mm-114 mm - 12 Pcs



**3834-SET-84-ES**

**g**  1 3834-SET-84-ES

3600

- 3830-25-C, 3830-30-C, 3830-35-C, 3830-51-C, 3830-54-C, 3830-76-C, 3830-92-C, 3830-114-C 
- 3834-ARBR-930ESM, 3834-ARBR-9100ESM 
- 3834-DRL-HSS-ES 
- 3834-UPSIZE 





Coffrets de scies trépan Sandflex bimétal



**3834-86**

**g**  1 3834-SET-86

2540

- 3830-25-VIP, 3830-32-VIP, 3830-35-VIP, 3830-51-VIP, 3830-54-VIP, 3830-76-VIP, 3830-92-VIP, 3830-114-VIP 
- 3834-ARBR-1130 
- 3834-ARBR-11152 
- 2x 3834-DRL 
- 3834-ADP 





Coffrets de scies trépan Sandflex bimétal



**3834-87**

**g**  1 3834-SET-87

1925

- 3830-19-VIP, 3830-22-VIP, 3830-29-VIP, 3830-38-VIP, 3830-43-VIP, 3830-48-VIP, 3830-52-VIP, 3830-65-VIP 
- 3834-ARBR-930 
- 3834-ARBR-9100 
- 3834-DRL 
- 3834-ES 



Coffrets de scies trépan Sandflex bimétal



**3834-92**

**g**  1 3834-SET-92

1440

- 3830-16-VIP, 3830-22-VIP, 3830-25-VIP, 3830-29-VIP, 3830-32-VIP, 3830-41-VIP, 3830-51-VIP, 3830-73-VIP, 3830-83-VIP 
- 3834-ARBR-930 
- 3834-ARBR-9100 





Coffret de scies trépan Sandflex® bimétal 16 mm-83 mm - 12 Pcs



**3834-93**

**g**  1 3834-SET-93

2360

- 3830-16-VIP, 3830-20-VIP, 3830-25-VIP, 3830-32-VIP, 3830-40-VIP, 3830-51-VIP, 3830-67-VIP, 3830-76-VIP, 3830-83-VIP 
- 3834-ARBR-930 
- 3834-ARBR-9100QC 
- 3834-DRL 



Coffrets de scies trépan Sandflex bimétal



**3834-94**

1815	1 3834-SET-94

3830-16-VIP, 3830-19-VIP, 3830-22-VIP, 3830-25-VIP, 3830-30-VIP, 3830-35-VIP, 3830-41-VIP, 3830-51-VIP, 3830-67-VIP	
3834-ARBR-1130	
3834-ARBR-11152	

Coffrets de scies trépan Sandflex bimétal



**3834-95**

1350	1 3834-SET-95

3830-16-VIP, 3830-19-VIP, 3830-22-VIP, 3830-29-VIP, 3830-35-VIP, 3830-44-VIP, 3830-52-VIP, 3830-57-VIP, 3830-64-VIP	
3834-ARBR-1130	
3834-ARBR-11152	
3834-DRL	

Coffrets de scies trépan Sandflex bimétal



**3834-103**

2015	1 3834-SET-103

3830-16-VIP, 3830-19-VIP, 3830-24-VIP, 3830-29-VIP, 3830-38-VIP, 3830-44-VIP, 3830-57-VIP, 3830-67-VIP	
3834-ARBR-1130	
3834-ARBR-11152	
3834-DRL	

Coffrets de scies trépan Sandflex bimétal



**3834-SET-152**

3770	1 3834-SET-152

3830-16-VIP, 3830-19-VIP, 3830-22-VIP, 3830-25-VIP, 3830-32-VIP, 3830-35-VIP, 3830-44-VIP, 3830-51-VIP, 3830-57-VIP, 3830-60-VIP, 3830-65-VIP, 3830-68-VIP, 3830-73-VIP, 3830-76-VIP, 3830-83-VIP	
3834-ARBR-930	
3834-ARBR-9100	
2x 3834-DRL	

Scies trépan supérieures multi-construction



**3833**

--	--

19	1 3833-19-C
20	1 3833-20-C
22	1 3833-22-C
25	1 3833-25-C
27	1 3833-27-C
29	1 3833-29-C
30	1 3833-30-C
32	1 3833-32-C
35	1 3833-35-C
38	1 3833-38-C
40	1 3833-40-C
41	1 3833-41-C
44	1 3833-44-C
48	1 3833-48-C
51	1 3833-51-C
54	1 3833-54-C
56	1 3833-56-C
57	1 3833-57-C
60	1 3833-60-C
62	1 3833-62-C
64	1 3833-64-C
65	1 3833-65-C
67	1 3833-67-C
68	1 3833-68-C
70	1 3833-70-C
71	1 3833-71-C
73	1 3833-73-C
74	1 3833-74-C
76	1 3833-76-C
77	1 3833-77-C
78	1 3833-78-C
79	1 3833-79-C
83	1 3833-83-C
86	1 3833-86-C
89	1 3833-89-C
92	1 3833-92-C
95	1 3833-95-C
98	1 3833-98-C
102	1 3833-102-C
105	1 3833-105-C
108	1 3833-108-C
109	1 3833-109-C
111	1 3833-111-C
114	1 3833-114-C
121	1 3833-121-C
127	1 3833-127-C
133	1 3833-133-C
140	1 3833-140-C
152	1 3833-152-C
159	1 3833-159-C
168	1 3833-168
177	1 3833-177
210	1 3833-210
225	1 3833-225



Coffret de scies trépan Superior™ multi construction 32 mm-83 mm - 6 Pcs



**3833-PROMO-42**

<b>g</b>	
1489	1 3833-PROMO-42

3833-32-C, 3833-51-C, 3833-76-C, 3833-83-C	
3834-ARBR-9100EL	
3834-UPSIZ	

Coffrets de scies trépan supérieures multi-construction



**3833-SET-101**

<b>kg</b>	
2,75 kg	1 3833-SET-101

3833-19-C, 3833-22-C, 3833-29-C, 3833-35-C, 3833-44-C, 3833-51-C, 3833-64-C	
3834-ARBR-930EL, 3834-ARBR-9100EL	
3834-DRL-EL	

Coffrets de scies trépan supérieures multi-construction



**3833-SET-201**

<b>kg</b>	
4,35 kg	1 3833-SET-201

3833-19-C, 3833-20-C, 3833-25-C, 3833-32-C, 3833-41-C, 3833-51-C, 3833-73-C, 3833-76-C, 3833-83-C, 3833-86-C	
3834-ARBR-930EL, 3834-ARBR-9100EL	
3834-DRL-EL	
3834-UPSIZ	

Coffrets de scies trépan supérieures multi-construction



**3833-SET-202**

<b>kg</b>	
4,1 kg	1 3833-SET-202

3833-19-C, 3833-20-C, 3833-25-C, 3833-32-C, 3833-41-C, 3833-51-C, 3833-57-C, 3833-60-C, 3833-73-C, 3833-83-C	
3834-ARBR-930EL, 3834-ARBR-9100EL	
3834-DRL-EL	
3834-UPSIZ	

Coffrets de scies trépan supérieures multi-construction



**3833-SET-203**

<b>kg</b>	
4,65 kg	1 3833-SET-203

3833-19-C, 3833-22-C, 3833-54-C, 3833-56-C, 3833-57-C, 3833-62-C, 3833-68-C, 3833-71-C, 3833-74-C, 3833-78-C	
3834-ARBR-930EL, 3834-ARBR-9100EL	
3834-DRL-EL	
3834-UPSIZ	

Coffrets de scies trépan supérieures multi-construction



**3833-SET-204**

<b>kg</b>	
3,88 kg	1 3833-SET-204

3833-32-C, 3833-41-C, 3833-51-C, 3833-73-C, 3833-76-C, 3833-83-C, 3833-86-C	
3834-ARBR-9100EL	
3834-DRL-EL	
3834-UPSIZ	



Coffrets de scies trépan supérieures multi-construction



**3833-SET-205**

kg 2.81 kg 1 3833-SET-205

- 3833-22-C, 3833-35-C, 3833-44-C, 3833-51-C, 3833-67-C
- 3834-ARBR-930EL, 3834-ARBR-9100EL
- 3834-DRL-EL
- 3834-UPSIZE

Coffrets de scies trépan supérieures multi-construction



**3833-SET-208**

kg 3.72 kg 1 3833-SET-208

- 3833-19-C, 3833-22-C, 3833-25-C, 3833-32-C, 3833-35-C, 3833-38-C, 3833-44-C, 3833-51-C, 3833-57-C, 3833-68-C, 3833-76-C
- 3834-ARBR-930EL, 3834-ARBR-9100EL
- 3834-DRL-EL
- 3834-UPSIZE

Coffrets de scies trépan supérieures multi-construction



**3833-SET-302**

kg 3.51 kg 1 3833-SET-302

- 3833-51-C, 3833-76-C, 3833-86-C, 3833-111-C
- 3834-ARBR-9100EL
- 3834-DRL-EL
- 3834-UPSIZE

Coffrets de scies trépan supérieures multi-construction



**3833-SET-207**

kg 3.90 kg 1 3833-SET-207

- 3833-19-C, 3833-22-C, 3833-25-C, 3833-35-C, 3833-44-C, 3833-51-C, 3833-64-C, 3833-67-C, 3833-76-C, 3833-83-C
- 3834-ARBR-930EL, 3834-ARBR-9100EL
- 3834-DRL-EL
- 3834-UPSIZE

Coffrets de scies trépan supérieures multi-construction



**3833-SET-301**

kg 4.38 kg 1 3833-SET-301

- 3833-25-C, 3833-32-C, 3833-35-C, 3833-51-C, 3833-54-C, 3833-76-C, 3833-92-C, 3833-114-C
- 3834-ARBR-930EL, 3834-ARBR-9100EL
- 3834-DRL-EL
- 3834-UPSIZE

Coffrets de scies trépan supérieures multi-construction



**3833-SET-303**

kg 4.17 kg 1 3833-SET-303

- 3833-35-C, 3833-40-C, 3833-51-C, 3833-57-C, 3833-60-C, 3833-74-C, 3833-83-C, 3833-105-C
- 3834-ARBR-9100EL
- 3834-DRL-EL
- 3834-UPSIZE

Coffrets de scies trépan supérieures multi-construction



**3833-SET-304**

kg		
4,20 kg	1	3833-SET-304

3833-19-C, 3833-25-C, 3833-32-C, 3833-35-C, 3833-51-C, 3833-54-C, 3833-76-C, 3833-92-C, 3833-114-C	
3834-ARBR-930EL, 3834-ARBR-9100EL	
3834-DRL-EL	
3834-UPSIZE	

SCIES TRÉPANS CARBURE



**3832**

14	6 3832-14
16	6 3832-16
17	6 3832-17
19	6 3832-19
20	6 3832-20
21	6 3832-21
22	6 3832-22
24	6 3832-24
25	6 3832-25
27	6 3832-27
29	6 3832-29
30	6 3832-30
32	6 3832-32
33	6 3832-33
35	6 3832-35
37	6 3832-37
38	6 3832-38
40	6 3832-40
41	6 3832-41
43	6 3832-43

44	6 3832-44
46	6 3832-46
48	6 3832-48
51	6 3832-51
52	4 3832-52
54	4 3832-54
56	4 3832-56
57	4 3832-57
59	4 3832-59
60	4 3832-60
64	4 3832-64
65	4 3832-65
67	4 3832-67
68	4 3832-68
70	4 3832-70
73	4 3832-73
76	4 3832-76
79	4 3832-79
83	4 3832-83
86	4 3832-86
89	4 3832-89
92	4 3832-92
95	4 3832-95
98	4 3832-98
102	4 3832-102
105	4 3832-105
108	4 3832-108
111	4 3832-111
114	4 3832-114
121	1 3832-121
127	1 3832-127
133	1 3832-133
140	1 3832-140
146	1 3832-146
152	1 3832-152

Coffret de scies trépan 35 mm-114 mm - 10 Pcs



**3835-SET-64**

10	3870	1	3835-SET-64

3830-35-C, 3830-73-C	
3833-35-C, 3833-73-C, 3833-76-C, 3833-114-C	
3834-ARBR-9100QC-C	
3834-ARBR-9100EL	
3834-DRL-EL	
3834-DRL	

Coffret de scies trépan 12 mm-86 mm



**3835-SET-711**

18	3680	1	3835-SET-711

3830-35-C, 3830-41-C, 3830-51-C, 3830-73-C, 3830-76-C, 3830-83-C, 3830-86-C	
9629-12, 9629-14, 9629-16, 9629-18, 9629-20, 9629-22, 9629-25, 9629-28, 9629-32	
3834-ARBR-9100ESM	
3834-DRL-HSS-ES	

Arbre support à éjection rapide



**3834-ARBR-EL/ES**

19-30	8.5	1	3834-ARBR-930EL
32-159	8.5	1	3834-ARBR-9100EL
16-30 mm	8.5 mm	1	3834-ARBR-930ESM
32-152 mm	8.5 mm	1	3834-ARBR-9100ESM



Foret pilote carbure pour arbres supports à éjection rapide



### 3834-DRL-EL

				3834-DRL-EL
6.35 mm	202		1	

Forets pilotes pour arbres supports à éjection rapide



### 3834-DRL-HSS-ES

				3834-DRL-ES
6.35 mm	138		1	
6.35 mm	138		1	3834-DRL-HSS-ES

Adaptateur/élargisseur



### 3834-upsize

			3834-UPSIZE
20.5		1	

Arbres supports pour scies trépan 14-30 mm



### 3834-ARBR

				3834-ARBR-630
14-30	6.4		1	
14-30	6.4		1	3834-ARBR-630-C
14-30	6.4 TRI		1	3834-ARBR-730
14-30	6.4 TRI		1	3834-ARBR-730-C
14-30	8.5		1	3834-ARBR-930
14-30	8.5		1	3834-ARBR-930-C
14-30	11.1		4	3834-ARBR-1130
14-30	11.1		1	3834-ARBR-1130-C

Arbres supports à changement rapide et à entraînement électrique pour scies trépan de 32-210 mm



### 3834-ARBR-QC

				3834-ARBR-9100
32-152	8.5		1	
32-152	8.5		1	3834-ARBR-9100-C
32-152	8.5		1	3834-ARBR-9100QC
32-152	8.5		1	3834-ARBR-9100QC-C
32-210	11.1		1	3834-ARBR-11152
32-210	11.1		1	3834-ARBR-11152-C
32-210	11.1		1	3834-ARBR-11152QC
32-210	11.1		1	3834-ARBR-11152QC-C
32-210	11.1		1	3834-ARBR-16152
32-210	15.4		1	3834-ARBR-16152
32-210	15.4		1	3834-ARBR-16152QC

Arbres supports avec entraînement SDS+



### 3834-ARBR-SD

				3834-ARBR-SD30
14-30	SDS+ mm		1	
32-210	SDS+ mm		1	3834-ARBR-SD152QC

Foret pilote HSS pour arbres supports



### 3834-DRL

				3834-DRL
6.35 mm	81		1	

Forets pilotes carbure pour arbres supports



### 3834-DRL-CT/L

				3834-DRL-CT
6.35 mm	81		1	
6.35 mm	114		1	3834-DRL-L

Extension pour arbre support



### 3834-EXT

				3834-EXT-1
11.1	330		1	
8.5	330		1	3834-EXT-2

Ressort éjecteur central



**3834-ES**

10	1	3834-ES

Adaptateur pour arbre support



**3834-ADP**

20	1	3834-ADP

Vis de rechange pour arbres supports



**3834-SCREWS**

9	1	3834-M6X29-SET
9	1	3834-M8X5-SET
9	1	3834-M8X6-SET
9	1	3834-M8X10-SET

**LAMES DE SCIES SABRES**

Jeu de lames de scie sabre bimétal pour le métal



**3940-METAL-SET-5P**

5	125	1	3940-METAL-SET-5P

Jeu de lames de scie sabre bimétal pour métaux lourds et démolition



**3940-HDD-SET-5P**

5	222	5	3940-HDD-SET-5P

Jeu de lames de scie sabre pour le bois et le métal



**3940-MIX-SET-5P**

5	150	5	3940-MIX-SET-5P

Jeu de lames de scie sabre pour plâtre, bois et métal



**3940-MIX-SET-10P**

10	245	4	3940-MIX-SET-10P

Jeu de lames de scie sabre pour le bois



**3942-WOOD-SET-5P**

5	191	5	3942-WOOD-SET-5P

Lame de scie sabre  
Pour carrosserie



**3845**

91.5	18	1	3845-18-10P
91.5	24	1	3845-24-10P
90	32	1	3845-32-10P



Lames de scie sabre bimétal pour le métal



**3940-M**

Length	Teeth	Material	Model
100	14	5	3940-100-14-ST-2P
100	14	5	3940-100-14-ST-5P
100	14	1	3940-100-14-ST-10P
100	18	5	3940-100-18-ST-2P
100	18	5	3940-100-18-ST-5P
100	18	1	3940-100-18-ST-10P
150	14	5	3940-150-14-ST-2P
150	14	5	3940-150-14-ST-5P
150	14	1	3940-150-14-ST-10P
150	14	1	3940-150-14-ST-100P
150	18	5	3940-150-18-ST-2P
150	18	5	3940-150-18-ST-5P
150	18	1	3940-150-18-ST-10P
150	18	1	3940-150-18-ST-100P
228	14	5	3940-228-14-ST-2P
228	14	5	3940-228-14-ST-5P
228	14	1	3940-228-14-ST-10P
228	14	1	3940-228-14-ST-100P
228	18	5	3940-228-18-ST-2P
228	18	5	3940-228-18-ST-5P
228	18	1	3940-228-18-ST-10P
228	18	1	3940-228-18-ST-100P
300	14	5	3940-300-14-ST-2P
300	14	5	3940-300-14-ST-5P
300	14	1	3940-300-14-ST-10P
300	14	1	3940-300-14-ST-100P
300	18	5	3940-300-18-ST-2P
300	18	5	3940-300-18-ST-5P
300	18	1	3940-300-18-ST-10P
300	18	1	3940-300-18-ST-100P

Lames de scie sabre bimétal pour métaux lourds



**3940-HM**

Length	Teeth	Material	Model
150	10	5	3940-150-10-HST-2P
150	10	5	3940-150-10-HST-5P

Length	Teeth	Material	Model
150	10	1	3940-150-10-HST-10P
150	10	1	3940-150-10-ST-100P
150	10	5	3940-150-10-ST-2P
150	10	5	3940-150-10-ST-5P
150	10	1	3940-150-10-ST-10P
150	14	5	3940-150-14-HST-2P
150	14	5	3940-150-14-HST-5P
150	14	1	3940-150-14-HST-10P
150	18	5	3940-150-18-HST-2P
150	18	5	3940-150-18-HST-5P
150	18	1	3940-150-18-HST-10P
150	8/12	5	3940-150-8/12-ST-2P
150	8/12	5	3940-150-8/12-ST-5P
150	8/12	1	3940-150-8/12-ST-10P
150	8/12	1	3940-150-8/12-ST-100P
228	10	5	3940-228-10-HST-2P
228	10	5	3940-228-10-HST-5P
228	10	1	3940-228-10-HST-10P
228	10	5	3940-228-10-ST-2P
228	10	5	3940-228-10-ST-5P
228	10	1	3940-228-10-ST-10P
228	14	5	3940-228-14-HST-2P
228	14	5	3940-228-14-HST-5P
228	14	1	3940-228-14-HST-10P
228	18	5	3940-228-18-HST-2P
228	18	5	3940-228-18-HST-5P
228	18	1	3940-228-18-HST-10P
228	8/12	5	3940-228-8/12-ST-2P
228	8/12	5	3940-228-8/12-ST-5P
228	8/12	1	3940-228-8/12-ST-10P
228	8/12	1	3940-228-8/12-ST-100P
300	10	5	3940-300-10-HST-2P
300	10	5	3940-300-10-HST-5P
300	10	1	3940-300-10-HST-10P
300	14	5	3940-300-14-HST-2P
300	14	5	3940-300-14-HST-5P
300	14	1	3940-300-14-HST-10P
300	18	5	3940-300-18-HST-2P
300	18	5	3940-300-18-HST-5P
300	18	1	3940-300-18-HST-10P

Lames de scie sabre bimétal pour métaux fins



**3940-FM**

Length	Teeth	Material	Model
100	24	5	3940-100-24-ST-2P
100	24	5	3940-100-24-ST-5P
100	24	1	3940-100-24-ST-10P
150	24	5	3940-150-24-ST-2P
150	24	5	3940-150-24-ST-5P
150	24	1	3940-150-24-ST-10P
150	24	1	3940-150-24-ST-100P

Lames de scie sabre bimétal pour la précision des métaux



**3940-PM**

Length	Teeth	Material	Model
100	14	5	3940-100-14-SC-2P
100	14	5	3940-100-14-SC-5P
100	18	5	3940-100-18-SC-2P
100	18	5	3940-100-18-SC-5P
100	24	5	3940-100-24-SC-2P
100	24	5	3940-100-24-SC-5P

Lames de scie sabre bimétal pour le bois et le métal



**3940-WM**

Length	Teeth	Material	Model
150	4/6	5	3940-150-4/6-SC-2P
150	4/6	5	3940-150-4/6-SC-5P
150	4/6	1	3940-150-4/6-SC-10P
150	5/8	2	3940-150-5/8-SL-2P
150	5/8	5	3940-150-5/8-SL-5P
150	5/8	1	3940-150-5/8-SL-10P
150	5/8	1	3940-150-5/8-SL-100P
150	6	5	3940-150-6-ST-2P
150	6	5	3940-150-6-ST-5P
150	6	1	3940-150-6-ST-10P
228	6	5	3940-228-6-SL-2P
228	6	5	3940-228-6-SL-5P
228	6	1	3940-228-6-SL-10P
300	6	5	3940-300-6-SL-2P
300	6	5	3940-300-6-SL-5P
300	6	1	3940-300-6-SL-10P
300	8/12	5	3940-300-8/12-SL-2P
300	8/12	5	3940-300-8/12-SL-5P
300	8/12	1	3940-300-8/12-SL-10P
300	8/12	1	3940-300-8/12-SL-100P

Lames de scie sabre bimétal pour les pompiers et les secouristes



**3940-FR**

Length	Teeth	Material	Model
228	10	5	3940-228-10-DSL-2P
228	10	5	3940-228-10-DSL-5P
228	10	1	3940-228-10-DSL-10P

Lames de scie sabre bimétal pour démolition



**3940-D**

Length	Teeth	Quantity	Model
150	5/8	5	3940-150-5/8-DSL-2P
150	5/8	5	3940-150-5/8-DSL-5P
150	5/8	1	3940-150-5/8-DSL-10P
228	5/8	5	3940-228-5/8-DSL-2P
228	5/8	5	3940-228-5/8-DSL-5P
228	5/8	1	3940-228-5/8-DSL-10P
300	5/8	5	3940-300-5/8-DSL-2P
300	5/8	5	3940-300-5/8-DSL-5P
300	5/8	1	3940-300-5/8-DSL-10P

Lames de scie sabre bimétal pour la réparation des palettes



**3940-PR**

Length	Teeth	Quantity	Model
228	10/14	1	3940-228-10/14-PR13-10P
228	10/14	1	3940-228-10/14-PR09-10P
228	10/14	1	3940-228-10/14-PR09-100P
228	10/14	1	3940-228-10/14-PR13-100P
228	8/12	1	3940-228-8/12-PR13-100P

Lames de scie sabre HCS pour le bois



**3942-W**

Length	Teeth	Quantity	Model
228	7	5	3942-228-7-HSL-2P
228	7	5	3942-228-7-HSL-5P
228	7	1	3942-228-7-HSL-10P
300	7	5	3942-300-7-HSL-2P
300	7	5	3942-300-7-HSL-5P
300	7	1	3942-300-7-HSL-10P

Lames de scie sabre HCS pour bois grossier



**3942-CW**

Length	Teeth	Quantity	Model
228	5	5	3942-228-5-HSL-2P
228	5	5	3942-228-5-HSL-5P
228	5	1	3942-228-5-HSL-10P
300	5	5	3942-300-5-HSL-2P
300	5	5	3942-300-5-HSL-5P
300	5	1	3942-300-5-HSL-10P

Lames de scie sabre HCS pour le bois et le plastique



**3942-WP**

Length	Teeth	Quantity	Model
228	11	5	3942-228-11-HSL-2P
228	11	5	3942-228-11-HSL-5P
228	11	1	3942-228-11-HSL-10P

Lames de scie sabre bimétal pour plâtre et panneaux



**3942-PB**

Length	Teeth	Quantity	Model
150	7	5	3942-150-7-SL-2P
150	7	5	3942-150-7-SL-5P
150	7	1	3942-150-7-SL-10P
228	7	5	3942-228-7-SL-2P
228	7	5	3942-228-7-SL-5P
228	7	1	3942-228-7-SL-10P
300	7	5	3942-300-7-SL-2P
300	7	5	3942-300-7-SL-5P
300	7	1	3942-300-7-SL-10P

Lames de scie sabre au carbure pour matériaux en pierre



**3946-CT**

Length	Teeth	Quantity	Model
150	6	5	3946-150-6-SL-1P
228	3	5	3946-228-3-ST-1P
300	3	5	3946-300-3-ST-1P
300	6	5	3946-300-6-ST-1P

Lames de scie sabre grain de carbure pour carrelage et verre



**3946-CG**

Length	Teeth	Quantity	Model
100	Grit	5	3946-100-G-ST-2P
150	Grit	5	3946-150-G-ST-2P

Lames de scie sabre en acier inoxydable pour viande et glace



**3944**

Length	Teeth	Quantity	Model
300	3	5	3944-300-3-MEAT-1P



## LAMES DE SCIES SAUTEUSES

Lames de scie sauteuse pour le métal pour le métal



### 91-M

L	Profil	Quantité	Modèle
100	Prog	1	91-3PM-5P
100	8	1	91-433-5P
77	36	1	91-502-5P
77	24	1	91-517-5P
77	14	1	91-522-5P
132	24	1	91-611-5P
77	24	1	91-612-5P
77	14	1	91-622-5P
132	10/14	1	91-7V1-5P

Lames de scie sauteuse pour le bois et le métal pour le bois et le métal



### 91-WM

L	Profil	Quantité	Modèle
116	Prog	1	91-2PW-5P
132	Prog	1	91-4PWM-5P
116	10	1	91-623-5P

Lames de scie sauteuse pour le bois pour le bois



### 91-W

L	Profil	Quantité	Modèle
116	8	1	91-434-5P
152	6	1	91-444-5P
100	8	1	91-023-5P
77	12	1	91-027-5P
100	6	1	91-143-5P
100	6	1	91-148-5P
100	10	1	91-223-5P
100	10	1	91-226-5P
116	8	1	91-233-5P
100	6	1	91-243-5P
76	20	1	91-412-5P
100	6	1	91-443-5P

Jeu de lames de scie sabre pour le métal - 10 pcs



### 91-METAL-10P

Quantité	Modèle
10	91-METAL-10P

Jeu de lames de scie sabre pour le bois et le plastique - 10 pcs



### 91-WOOD-10P

Quantité	Modèle
10	91-WOOD-10P

Jeu de lames de scie sabre pour le bois et le métal - 10 pcs



### 91-MIXED-10P

Quantité	Modèle
10	91-MIXED-10P

## DISQUES ABRASIFS

Disques à tronçonner haute performance pour l'acier inoxydable



### 391-T41-I

Diamètre	Quantité	Modèle
115 mm	50	3911-115-T41-I
125 mm	50	3911-125-T41-I
150 mm	50	3911-150-T41-I
180 mm	50	3911-180-T41-I
230 mm	50	3911-230-T41-I

Disques à tronçonner haute performance pour l'acier inoxydable et le métal



### 391-T41-IM

Diamètre	Quantité	Modèle
115 mm	50	3911-115-T41-IM
115 mm	50	3911-115T41-IM
125 mm	50	3911-125-T41-IM
180 mm	50	3911-180-T41-IM
230 mm	50	3911-230-T41-IM
115 mm	50	3912-115-T41-IM
125 mm	50	3912-125-T41-IM

Disques à tronçonner haute performance pour le métal



### 391-T42 M

Diamètre	Quantité	Modèle
115 mm	25	3911-115-T42-M
125 mm	25	3911-125-T42-M



Ø			
150 mm	25	3911-150-T42-M	
180 mm	25	3911-180-T42-M	
230 mm	50	3911-230-T42-M	

Disques à tronçonner haute performance pour minéraux



### 391-T42\_ST

Ø			
115 mm	25	3912-115-T42-ST	
125 mm	25	3912-125-T42-ST	
180 mm	25	3912-180-T42-ST	
230 mm	50	3912-230-T42-ST	

Disques à ébarber haute performance pour l'acier inoxydable et le métal



### 392-T27\_IM

Ø			
115 mm	25	3921-115-T27-IM	
125 mm	25	3921-125-T27-IM	
150 mm	25	3921-150-T27-IM	
180 mm	25	3921-180-T27-IM	
230 mm	25	3921-230-T27-IM	

Disques à lamelles pour l'acier inoxydable et le métal



### 392-FLAP\_C

Ø			
115 mm	20	3926-115IM-C40	
115 mm	20	3926-115IM-C60	
115 mm	20	3926-115IM-C80	
115 mm	20	3926-115IM-C120	
125 mm	20	3926-125IM-C40	
125 mm	20	3926-125IM-C60	
125 mm	20	3926-125IM-C80	
125 mm	20	3926-125IM-C120	

Disques à lamelles pour l'acier inoxydable et le métal



### 392-FLAP\_P

Ø			
115 mm	20	3927-115IM-P40	
115 mm	20	3927-115IM-P60	
115 mm	20	3927-115IM-P80	
115 mm	20	3927-115IM-P120	
125 mm	20	3927-125IM-P40	
125 mm	20	3927-125IM-P60	
125 mm	20	3927-125IM-P80	
125 mm	20	3927-125IM-P120	

Disques diamant pour carrelage et céramique



### 391-DIAM\_C

Ø			
115 mm	100	3916-115-10P-CE	
125 mm	100	3916-125-10P-CE	

Ø			
115 mm	100	3917-115-7S-C	
125 mm	100	3917-125-7S-C	

Disques diamant utilisation universelle



### 391-DIAM\_U

Ø			
115 mm	100	3916-115-10S-UE	
125 mm	100	3916-125-10S-UE	
150 mm	50	3916-150-10S-UE	
180 mm	50	3916-180-10S-UE	
230 mm	25	3916-230-10S-UE	
115 mm	100	3917-115-7S-U	
125 mm	100	3917-125-7S-U	
230 mm	25	3917-230-7S-U	

Disques diamant pour béton armé



### 391-DIAM\_RC

Ø			
230 mm	25	3916-230-10L-RC	



## LAMES DE SCIES CIRCULAIRES

Lames de scie circulaire pour le bois pour scies sans fil



### 8501-C

Ø	Te	Icon	Icon	Code
136 mm	24			1 8501-136-10-24C
136 mm	24			1 8501-136-20-24C
150 mm	24			1 8501-150-10-24C
160 mm	24			1 8501-160-20-24C
165 mm	24			1 8501-165-20-24C
184 mm	24			1 8501-184-20-24C
190 mm	24			1 8501-190-30-24C

Lames de scie circulaire pour le bois pour scies portatives et sur table



### 8501-P/T

Ø	Te	Icon	Icon	Code
125 mm	16			1 8501-2
130 mm	16			1 8501-3
140 mm	16			1 8501-4
140 mm	24			1 8501-4F
140 mm	30			1 8501-4XF
150 mm	18			1 8501-5
150 mm	30			1 8501-5F
160 mm	18			1 8501-7
160 mm	30			1 8501-7F
170 mm	18			1 8501-10
170 mm	30			1 8501-10F
180 mm	20			1 8501-12
180 mm	40			1 8501-12F
184 mm	24			1 8501-13
184 mm	40			1 8501-13F
184 mm	24			1 8501-184-16-24
184 mm	40			1 8501-184-16-40
190 mm	20			1 8501-15
190 mm	40			1 8501-15F
190 mm	60			1 8501-190-30-60XF
200 mm	20			1 8501-16
200 mm	40			1 8501-16F
210 mm	20			1 8501-17

Ø	Te	Icon	Icon	Code
210 mm	40			1 8501-17F
210 mm	60			1 8501-210-30-60XF
230 mm	20			1 8501-22
230 mm	40			1 8501-22F
230 mm	60			1 8501-230-30-60XF
235 mm	30			1 8501-23
235 mm	40			1 8501-23F
235 mm	60			1 8501-235-30-60XF
250 mm	24			1 8501-28
250 mm	40			1 8501-28F
250 mm	60			1 8501-28XF

Lames de scie circulaire pour le bois pour scies plongeantes



### 8501-P

Ø	Te	Icon	Icon	Code
160 mm	48			1 8501-160-20-48XF
165 mm	48			1 8501-165-20-48XF

Lames de scie circulaire pour le bois pour scies à onglet



### 8501-M

Ø	Te	Icon	Icon	Code
210 mm	48			1 8501-210-30-48SW
216 mm	24			1 8501-16SW
216 mm	48			1 8501-18SW
216 mm	60			1 8501-216-60SW
250 mm	60			1 8501-28SW
260 mm	24			1 8501-260-24SW
260 mm	40			1 8501-260-40SW
260 mm	60			1 8501-260-60SW
300 mm	60			1 8501-30SW
305 mm	40			1 8501-305-30-40SW
305 mm	60			1 8501-305-30-60SW

Lames de scie circulaire pour le bois pour scies de chantier



### 8501-S

Ø	Te	Icon	Icon	Code
300 mm	30			1 8501-30
300 mm	40			1 8501-30F
300 mm	60			1 8501-30XF
315 mm	30			1 8501-31
315 mm	40			1 8501-31F
400 mm	40			1 8501-40

Lames de scie circulaire pour l'aluminium et le plastique pour scies à onglet



### 8501-AP

Ø	Te	Icon	Icon	Code
125 mm	48			1 8501-17S
216 mm	48			1 8501-18S
250 mm	80			1 8501-28S
260 mm	80			1 8501-260-30-80S
300 mm	96			1 8501-30S
305 mm	96			1 8501-305-30-96S

## LAMES DE SCIES RUBANS

### EASY-CUT Portaband



### 3857 Easy-Cut Portaband

Code	Grain	Quantité	Modèle
M	EZ	1	3857-13-0.6-EZ-M-3P690
M	EZ	1	3857-13-0.6-EZ-M-3P730
M	EZ	1	3857-13-0.6-EZ-M-3P835
M	EZ	1	3857-13-0.6-EZ-M-3P900
M	EZ	1	3857-13-0.6-EZ-M-3P1140

## FRAISES LIMES

Fraises limes au carbure avec tête cylindrique  
F= Fine, M = moyenne, C= grosse



Code	Grain	Quantité	Modèle
3 mm	C	1	A0313C03
3 mm	F	1	A0313F03
3 mm	F*	1	A0313F03E
3 mm	M	1	A0313M03
3 mm	M*	1	A0313M03E
3 mm	M	1	A0313M03X
3 mm	M XE	1	A0313M03XE
3 mm	M*	1	A0313M03XE-60
3 mm	M	1	A0313M03XE-80
6 mm	M X	1	A0613M03X
6 mm	C	1	A0616C06
6 mm	F	1	A0616F06
6 mm	M	1	A0616M06
6 mm	M*	1	A0616M06DE
6 mm	M	1	A0616M06E
6 mm	M	1	A0616M06X
6 mm	M	1	A0616M06XE
8 mm	F	1	A0820F06
8 mm	F*	1	A0820F06E
8 mm	M	1	A0820M06
8 mm	M*	1	A0820M06E
8 mm	M	1	A0820M06X
8 mm	M	1	A0820M06XE
8 mm	C*	1	A0820C06
10 mm	F*	1	A1020F06

Fraises limes au carbure avec tête cylindrique à bout rond  
F=Fine, M=Moyenne,C=Grosse



Code	Grain	Quantité	Modèle
3 mm	C	1	C0313C03
3 mm	F	1	C0313F03
3 mm	M	1	C0313M03
3 mm	M	1	C0313M03X
6 mm	M	1	C0613M03X
6 mm	M	1	C0616C06
6 mm	F	1	C0616F06
6 mm	M	1	C0616M03X
6 mm	M	1	C0616M06
6 mm	M*	1	C0616M06D
6 mm	M	1	C0616M06X
8 mm	F	1	C0820F06
8 mm	M	1	C0820M06
8 mm	M	1	C0820M06X
8 mm	C*	1	C0820C06
10 mm	F*	1	C1020F06
10 mm	M	1	C1020M06
10 mm	M	1	C1020M06X

Code	Grain	Quantité	Modèle
10 mm	C	1	C1020C06
12 mm	F	1	C1225F06
12 mm	M	1	C1225M06
12 mm	M	1	C1225M06X
12 mm	C	1	C1225C06
12 mm	F*	1	C1225F08
12 mm	M	1	C1225M08
12 mm	M	1	C1225M08X
12 mm	C*	1	C1225C08
16 mm	F*	1	C1625F06
16 mm	M	1	C1625M06
16 mm	M	1	C1625M06X
16 mm	C*	1	C1625C06
16 mm	F*	1	C1625F08
16 mm	M	1	C1625M08
16 mm	M	1	C1625M08X
16 mm	C*	1	C1625C08

Fraises limes au carbure avec tête sphérique  
sphérique



Code	Grain	Quantité	Modèle
3 mm	F	1	D0303F03
3 mm	M	1	D0303M03
3 mm	M	1	D0303M03X
3 mm	C*	1	D0303C03
6 mm	M	1	D0605M03X
6 mm	F*	1	D0606F06
6 mm	M	1	D0606M06
6 mm	M	1	D0606M06X
6 mm	C	1	D0606C06
8 mm	F*	1	D0807F06
8 mm	M	1	D0807M06
8 mm	M	1	D0807M06X
8 mm	C*	1	D0807C06
10 mm	F*	1	D1009F06
10 mm	M	1	D1009M06
10 mm	M	1	D1009M06X
10 mm	C	1	D1009C06
12 mm	F	1	D1211F06
12 mm	D*	1	D1211F06D
12 mm	M	1	D1211M06
12 mm	M	1	D1211M06X
12 mm	C	1	D1211C06
16 mm	F*	1	D1614F06
16 mm	M	1	D1614M06
16 mm	M	1	D1614M06X
16 mm	C*	1	D1614C06
16 mm	F*	1	D1614F08
16 mm	M*	1	D1614M08
16 mm	M*	1	D1614M08X
16 mm	C*	1	D1614C08



Fraises limes au carbure avec tête ovale  
Taille : F = Fine, M = Moyenne, C = Grosse



**E**

3 mm	F*		1	E0308F03
3 mm	M		1	E0308M03
3 mm	M*		1	E0308M03X
3 mm	C*		1	E0308C03
6 mm	F*		1	E0614F06
6 mm	M		1	E0614M06
6 mm	C*		1	E0614C06
8 mm	F*		1	E0816F06
8 mm	M		1	E0816M06
8 mm	M		1	E0816M06X
8 mm	C*		1	E0816C06
10 mm	F*		1	E1018F06
10 mm	M		1	E1018M06
10 mm	M		1	E1018M06X
10 mm	C*		1	E1018C06
12 mm	F*		1	E1222F06
12 mm	M		1	E1222M06
12 mm	M		1	E1222M06X
12 mm	C*		1	E1222C06
12 mm	F*		1	E1222F08
12 mm	M*		1	E1222M08
12 mm	M*		1	E1222M08X
12 mm	C*		1	E1222C08
16 mm	F*		1	E1625F06
16 mm	M		1	E1625M06
16 mm	M		1	E1625M06X
16 mm	C*		1	E1625C06
16 mm	F*		1	E1625F08
16 mm	M*		1	E1625M08
16 mm	M		1	E1625M08X
16 mm	C*		1	E1625C08

Fraises limes au carbure avec tête à bout rond



**F**

3 mm	F		1	F0313F03
3 mm	M		1	F0313M03
3 mm	M		1	F0313M03X
3 mm	C*		1	F0313C03
6 mm	F*		1	F0612F04
6 mm	M*		1	F0612M04
6 mm	M*		1	F0612M04X

6 mm		C*	1	F0612C04
6 mm		M	1	F0613M03X
6 mm		F*	1	F0618F06
6 mm		M	1	F0618M06
6 mm		M	1	F0618M06X
6 mm		C	1	F0618C06
8 mm		F*	1	F0820F06
8 mm		M	1	F0820M06
8 mm		M	1	F0820M06X
8 mm		C*	1	F0820C06
10 mm		F*	1	F1020F06
10 mm		M	1	F1020M06
10 mm		M	1	F1020M06X
10 mm		C*	1	F1020C06
12 mm		F	1	F1225F06
12 mm		M	1	F1225M06
12 mm		M	1	F1225M06X
12 mm		C	1	F1225C06
12 mm		F*	1	F1225F08
12 mm		M	1	F1225M08
12 mm		M	1	F1225M08X
12 mm		C*	1	F1225C08
16 mm		F*	1	F1625F06
16 mm		M	1	F1625M06
16 mm		M	1	F1625M06X
16 mm		C*	1	F1625C06
16 mm		F*	1	F1625F08
16 mm		M*	1	F1625M08
16 mm		M*	1	F1625M08X
16 mm		C*	1	F1625C08

Fraises limes au carbure avec tête pointue



**G**

3 mm		F	1	G0313F03
3 mm		M	1	G0313M03
3 mm		M	1	G0313M03X
3 mm		C	1	G0313C03
6 mm		M	1	G0613M03X
6 mm		F	1	G0618F06
6 mm		M	1	G0618M06
6 mm		M	1	G0618M06X
6 mm		C	1	G0618C06
8 mm		F*	1	G0820F06
8 mm		M	1	G0820M06
8 mm		M	1	G0820M06X
8 mm		C*	1	G0820C06
10 mm		F*	1	G1020F06
10 mm		M	1	G1020M06
10 mm		M	1	G1020M06X
10 mm		C*	1	G1020C06
12 mm		F	1	G1225F06
12 mm		M	1	G1225M06
12 mm		M	1	G1225M06X
12 mm		C	1	G1225C06
12 mm		F*	1	G1225F08

12 mm		M	1	G1225M08
12 mm		M	1	G1225M08X
12 mm		C*	1	G1225C08
16 mm		F*	1	G1625F06
16 mm		M	1	G1625M06
16 mm		M	1	G1625M06X
16 mm		C*	1	G1625C06
16 mm		F*	1	G1625F08
16 mm		M*	1	G1625M08
16 mm		M	1	G1625M08X
16 mm		C*	1	G1625C08

Fraises limes au carbure avec tête flamme



**H**

6 mm		M	1	H0613M03X
10 mm		F*	1	H1025F06
10 mm		M	1	H1025M06
10 mm		M*	1	H1025M08
10 mm		M	1	H1025M06X
10 mm		C*	1	H1025C06
12 mm		M	1	H1232M06
12 mm		M	1	H1232M06X
16 mm		F*	1	H1635F06
16 mm		M	1	H1635M06X
16 mm		M*	1	H1635M06
16 mm		C*	1	H1635C06
16 mm		F*	1	H1635F08
16 mm		M*	1	H1635M08
16 mm		M*	1	H1635M08X
16 mm		C*	1	H1635C08

Fraises limes au carbure avec tête conique 60°



**J**

6 mm		F*	1	J0604F06
6 mm		M	1	J0604M06
6 mm		C*	1	J0604C06
10 mm		F*	1	J1010F06
10 mm		M	1	J1010M06

10 mm	C*	1	J1010C06
12 mm	M	1	J1212M06
16 mm	F*	1	J1616F06
16 mm	M	1	J1616M06
16 mm	C*	1	J1616C06
16 mm	F*	1	J1616F08
16 mm	M*	1	J1616M08
16 mm	C*	1	J1616C08

### Fraises limes au carbure avec tête conique 90°



### K

6 mm	F*	1	K0602F06
6 mm	M	1	K0602M06
6 mm	C*	1	K0602C06
10 mm	F*	1	K1008F06
10 mm	M	1	K1008M06
10 mm	C*	1	K1008C06
12 mm	F*	1	K1210F06
12 mm	M	1	K1210M06
12 mm	C*	1	K1210C06
16 mm	F*	1	K1612F06
16 mm	M*	1	K1612M06
16 mm	C*	1	K1612C06
16 mm	M	1	K1612M08
16 mm	F*	1	K1612F08
16 mm	C*	1	K1612C08

### Fraises limes au carbure avec tête conique à bout rond



### L

10 mm	F*	1	L1020F06
10 mm	M	1	L1020M06
10 mm	M	1	L1020M06X

10 mm	C*	1	L1020C06
12 mm	F*	1	L1225F06
12 mm	M	1	L1225M06
12 mm	M	1	L1225M06X
12 mm	F*	1	L1230F06
12 mm	M	1	L1230M06
12 mm	M	1	L1230M06X
12 mm	C*	1	L1230C06
16 mm	F*	1	L1630F06
16 mm	M*	1	L1630M06
16 mm	M	1	L1630M06X
16 mm	C*	1	L1630C06
16 mm	M	1	L1630M08
16 mm	M	1	L1630M08X
16 mm	F*	1	L1630F08
16 mm	C*	1	L1630C08

### Fraises limes au carbure avec tête conique à bout pointu

Taille : F = Fine, M = Moyenne, C = Grosse



### M

3 mm	F	1	M0310F03
3 mm	M	1	M0310M03
3 mm	M	1	M0310M03X
3 mm	C*	1	M0310C03
6 mm	M	1	M0613M03X
6 mm	F	1	M0618F06
6 mm	M	1	M0618M06
6 mm	M	1	M0618M06X
6 mm	C	1	M0618C06
10 mm	F*	1	M1022F06
10 mm	M	1	M1022M06
10 mm	M*	1	M1022M06D
10 mm	M	1	M1022M06X
10 mm	C*	1	M1022C06
12 mm	F*	1	M1227F06
12 mm	M	1	M1227M06
12 mm	M	1	M1227M06X
12 mm	C*	1	M1227C06
12 mm	F*	1	M1227F08
12 mm	M*	1	M1227M08
12 mm	M*	1	M1227M08X
12 mm	C*	1	M1227C08
16 mm	F*	1	M1630F06
16 mm	M	1	M1630M06
16 mm	M	1	M1630M06X
16 mm	C*	1	M1630C06
16 mm	F*	1	M1630F08
16 mm	M	1	M1630M08
16 mm	M	1	M1630M08X
16 mm	C*	1	M1630C08

### Fraises limes au carbure avec tête à cône inversé



### N

3 mm	F*	1	N0306F03
3 mm	M	1	N0306M03
3 mm	M*	1	N0306M03E
3 mm	C*	1	N0306C03
6 mm	F*	1	N0607F06
6 mm	M*	1	N0607M06
6 mm	M*	1	N0607M06E
6 mm	C*	1	N0607C06
12 mm	F*	1	N1213F06
12 mm	M	1	N1213M06
12 mm	M*	1	N1213M06E
12 mm	x	1	N1213M06X
12 mm	C*	1	N1213C06
16 mm	F*	1	N1613F06
16 mm	M*	1	N1613M06
16 mm	M*	1	N1613M06E
16 mm	M*	1	N1613M06X
16 mm	C*	1	N1613C06
16 mm	F*	1	N1613F08
16 mm	M	1	N1613M08
16 mm	M*	1	N1613M08E
16 mm	C	1	N1613C08

### Fraises limes au carbure avec tête cylindrique pour aluminium

Pour l'aluminium, cylindrique



### A-AL

6 mm	AL	1	A0616AL06E
12 mm	AL	1	A1225AL06E
12 mm	AL	1	A1225AL08E



Fraises limes au carbure avec tête cylindrique à bout rond pour aluminium  
Pour l'aluminium, cylindrique à bout rond



### C-AL

6 mm		AL	1	C0616AL06
12 mm		AL	1	C1225AL06
12 mm		AL	1	C1225AL08

Fraises limes au carbure avec tête conique à bout rond pour aluminium  
Pour l'aluminium, conique à bout rond



### L-AL

12 mm		AL	1	L1230AL06
12 mm		AL*	1	L1230AL08

Fraises limes HSS avec tête cylindrique  
F=fine, M=moyenne, C=grosse



### HSSG-A

6 mm		M	1	HSSG-A0616M
10 mm		M	1	HSSG-A1020M
12 mm		EC	1	HSSG-A1225EC
12 mm		M	1	HSSG-A1225M

Fraises limes au carbure avec tête sphérique pour aluminium  
Pour l'aluminium, sphérique



### D-AL

12 mm		AL	1	D1211AL06
12 mm		AL*	1	D1211AL08

Fraises limes au carbure avec tête cylindrique - longues  
Spéciale pour meublage intérieur



### A-int

4 mm		D*	1	A0408F03D
6 mm		D*	1	A0610F06D
8 mm		D	1	A0810F06D

Fraise lime HSS, Carte individuelle cylindrique, forme-A  
F=fine, M=moyenne, C=grosse, EC= extra grosse



### HSSG-A-S

6 mm		M	1	HSSG-A0616M-S
10 mm		M	1	HSSG-A1020M-S
12 mm		M	1	HSSG-A1225M-S
12 mm		EC	1	HSSG-A1225EC-S

Fraises limes au carbure avec tête à bout rond pour aluminium  
Pour l'aluminium, ogive à bout rond



### F-AL

6 mm		AL	1	F0618AL06
12 mm		AL	1	F1225AL06
12 mm		AL	1	F1225AL08

Fraises limes au carbure avec tête d'aiguille pour la réparation des pneus



### A/G

3 mm		x	1	A0320M03X
6 mm		x	1	A0625M06X
6 mm		x*	1	G0645M4.9X
8 mm		x*	1	G0845M6.6X
10 mm		x*	1	G1050M8.3X
6 mm		x*	1	HSSG-G0645MX

Fraises limes HSS avec tête cylindrique à bout rond  
M=moyenne, C=Grosse, EC=extra-grosse



### HSSG-C

6 mm		M	1	HSSG-C0616M
10 mm		M	1	HSSG-C1020M
12 mm		EC	1	HSSG-C1225EC
12 mm		M	1	HSSG-C1225M

Fraise lime HSS, Cylindrique à bout rond, carte individuelle  
M=moyenne, C=grosse, EC= extra grosse



### HSSG-C-S

6 mm	M		1	HSSG-C0616M-S
10 mm	M		1	HSSG-C1020M-S
12 mm	M		1	HSSG-C1225M-S
12 mm	EC		1	HSSG-C1225EC-S

Fraises limes HSS avec tête ovale  
M=moyenne, C=grosse, EC=Extra grosse



### HSSG-E

6 mm	M		1	HSSG-E0614M
12 mm	EC		1	HSSG-E1222EC
12 mm	M		1	HSSG-E1222M

Fraise lime HSS, Ogive à bout rond, carte individuelle  
M=moyenne, C=grosse, EC= extra grosse



### HSSG-F-S

6 mm	M		1	HSSG-F0618M-S
12 mm	M		1	HSSG-F1225M-S

Fraises limes HSS avec tête sphérique  
M=moyenne, C=grosse, EC=Extra grosse



### HSSG-D

6 mm	M		1	HSSG-D0606M
8 mm	M		1	HSSG-D0807M
10 mm	M		1	HSSG-D1009M
12 mm	EC		1	HSSG-D1211EC
12 mm	M		1	HSSG-D1211M

Fraise lime HSS, Ovale, carte individuelle  
M=moyenne, C=grosse, EC= extra grosse



### HSSG-E-S

12 mm	M		1	HSSG-E1222M-S
12 mm	EC		1	HSSG-E1222EC-S

Fraises limes HSS avec tête pointue  
M=moyenne, EC= extra grosse



### HSSG-G

6 mm	M		1	HSSG-G0618M
12 mm	M		1	HSSG-G1220M
12 mm	EC		1	HSSG-G1225EC
12 mm	M		1	HSSG-G1225M

Fraise lime HSS, Sphérique carte individuelle  
M=moyenne, C=grosse, EC= extra grosse



### HSSG-D-S

6 mm	M		1	HSSG-D0606M-S
8 mm	M		1	HSSG-D0807M-S
10 mm	M		1	HSSG-D1009M-S
12 mm	M		1	HSSG-D1211M-S
12 mm	EC		1	HSSG-D1211EC-S

Fraises limes HSS avec tête à bout rond  
M=moyenne, C=grosse, EC=Extra grosse



### HSSG-F

6 mm	M		1	HSSG-F0618M
12 mm	M		1	HSSG-F1225M

Fraise lime HSS, Ogive à bout pointu, carte individuelle  
M=moyenne, C=grosse, EC= extra grosse



### HSSG-G-S

6 mm	M		1	HSSG-G0618M-S
12 mm	M		1	HSSG-G1220M-S
12 mm	M		1	HSSG-G1225M-S



Fraises limes HSS avec tête conique à bout pointu  
M=moyenne, C=grosse, EC= extra grosse



### HSSG-M

Ø	L	Icon	Code
6 mm	M		1 HSSG-M0618M
12 mm	M		1 HSSG-M1227M

Fraise lime HSS, Conique à bout pointu, carte individuelle  
M=moyenne, C=grosse, EC= extra grosse



### HSSG-M-S

Ø	L	Icon	Code
6 mm	M		1 HSSG-M0618M-S
12 mm	M		1 HSSG-M1227M-S

## MÈCHES ET FORETS

Forets SDS Max pour béton armé



### 4656

Ø	L	Icon	Code
12.0 mm	340		1 4656-12-340
12.0 mm	540		1 4656-12-540
12.0 mm	690		1 4656-12-690
14.0 mm	340		1 4656-14-340
14.0 mm	540		1 4656-14-540
15.0 mm	340		1 4656-15-340
15.0 mm	540		1 4656-15-540
16.0 mm	340		1 4656-16-340
16.0 mm	540		1 4656-16-540

Ø	L	Icon	Code
16.0 mm	940		1 4656-16-940
16.0 mm	1320		1 4656-16-1320
18.0 mm	340		1 4656-18-340
18.0 mm	540		1 4656-18-540
18.0 mm	940		1 4656-18-940
18.0 mm	1320		1 4656-18-1320
20.0 mm	320		1 4656-20-320
20.0 mm	520		1 4656-20-520
20.0 mm	920		1 4656-20-920
20.0 mm	1320		1 4656-20-1320
22.0 mm	320		1 4656-22-320
22.0 mm	520		1 4656-22-520
22.0 mm	920		1 4656-22-920
22.0 mm	1320		1 4656-22-1320
24.0 mm	320		1 4656-24-320
24.0 mm	520		1 4656-24-520
25.0 mm	320		1 4656-25-320
25.0 mm	520		1 4656-25-520
25.0 mm	920		1 4656-25-920
25.0 mm	1320		1 4656-25-1320
26.0 mm	520		1 4656-26-520
28.0 mm	370		1 4656-28-370
28.0 mm	570		1 4656-28-570
28.0 mm	670		1 4656-28-670
28.0 mm	920		1 4656-28-920
30.0 mm	370		1 4656-30-370
30.0 mm	570		1 4656-30-570
32.0 mm	370		1 4656-32-370
32.0 mm	570		1 4656-32-570
32.0 mm	920		1 4656-32-920
32.0 mm	1320		1 4656-32-1320
35.0 mm	370		1 4656-35-370
35.0 mm	570		1 4656-35-570
35.0 mm	670		1 4656-35-670
37.0 mm	370		1 4656-37-370
37.0 mm	570		1 4656-37-570
37.0 mm	920		1 4656-37-920
38.0 mm	370		1 4656-38-370
38.0 mm	570		1 4656-38-570
40.0 mm	370		1 4656-40-370
40.0 mm	570		1 4656-40-570
40.0 mm	920		1 4656-40-920
40.0 mm	1320		1 4656-40-1320
45.0 mm	570		1 4656-45-570
45.0 mm	920		1 4656-45-920
50.0 mm	570		1 4656-50-570
52.0 mm	570		1 4656-52-570

Forets SDS+ pour béton armé



### 4651

Ø	L	Icon	Code
5.0 mm	115		1 4651-5-110
5.0 mm	165		1 4651-5-160

Ø	L	Icon	Code
5.0 mm	215		1 4651-5-210
5.0 mm	265		1 4651-5-260
5.5 mm	115		1 4651-5.5-110
5.5 mm	165		1 4651-5.5-160
6.0 mm	115		1 4651-6-110
6.0 mm	165		1 4651-6-160
6.0 mm	215		1 4651-6-210
6.0 mm	265		1 4651-6-260
6.0 mm	315		1 4651-6-310
6.5 mm	165		1 4651-6.5-160
6.5 mm	215		1 4651-6.5-210
6.5 mm	265		1 4651-6.5-260
6.5 mm	315		1 4651-6.5-310
7.0 mm	115		1 4651-7-110
7.0 mm	165		1 4651-7-160
8.0 mm	115		1 4651-8-110
8.0 mm	165		1 4651-8-160
8.0 mm	215		1 4651-8-210
8.0 mm	265		1 4651-8-260
8.0 mm	315		1 4651-8-310
8.0 mm	465		1 4651-8-460
9.0 mm	165		1 4651-9-160
10.0 mm	115		1 4651-10-110
10.0 mm	165		1 4651-10-160
10.0 mm	215		1 4651-10-210
10.0 mm	265		1 4651-10-260
10.0 mm	315		1 4651-10-310
10.0 mm	455		1 4651-10-450
10.0 mm	600		1 4651-10-600
10.0 mm	1000		1 4651-10-1000
12.0 mm	160		1 4651-12-160
12.0 mm	210		1 4651-12-210
12.0 mm	260		1 4651-12-260
12.0 mm	310		1 4651-12-310
12.0 mm	450		1 4651-12-450
12.0 mm	600		1 4651-12-600
12.0 mm	1000		1 4651-12-1000
14.0 mm	160		1 4651-14-160
14.0 mm	210		1 4651-14-210
14.0 mm	260		1 4651-14-260
14.0 mm	310		1 4651-14-310
14.0 mm	450		1 4651-14-450
14.0 mm	600		1 4651-14-600
14.0 mm	1000		1 4651-14-1000
15.0 mm	160		1 4651-15-160
15.0 mm	260		1 4651-15-260
15.0 mm	450		1 4651-15-450
16.0 mm	160		1 4651-16-160
16.0 mm	210		1 4651-16-210
16.0 mm	260		1 4651-16-260
16.0 mm	310		1 4651-16-310
16.0 mm	450		1 4651-16-450
16.0 mm	600		1 4651-16-600
16.0 mm	1000		1 4651-16-1000
18.0 mm	250		1 4651-18-250
18.0 mm	450		1 4651-18-450
20.0 mm	250		1 4651-20-250
20.0 mm	450		1 4651-20-450
22.0 mm	250		1 4651-22-250
22.0 mm	450		1 4651-22-450
24.0 mm	250		1 4651-24-250
24.0 mm	450		1 4651-24-450
25.0 mm	250		1 4651-25-250
25.0 mm	450		1 4651-25-450
28.0 mm	250		1 4651-28-250
28.0 mm	450		1 4651-28-450
30.0 mm	250		1 4651-30-250
30.0 mm	450		1 4651-30-450
32.0 mm	450		1 4651-32-450



## Forets SDS+ pour béton



### 4652



Ø	L		
4.0 mm	110	1	4652-4-110
4.0 mm	160	1	4652-4-160
5.0 mm	110	1	4652-5-110
5.0 mm	160	1	4652-5-160
5.0 mm	210	1	4652-5-210
5.5 mm	110	1	4652-5.5-110
5.5 mm	160	1	4652-5.5-160
6.0 mm	110	1	4652-6-110
6.0 mm	160	1	4652-6-160
6.0 mm	210	1	4652-6-210
6.0 mm	260	1	4652-6-260
6.5 mm	110	1	4652-6.5-110
6.5 mm	160	1	4652-6.5-160
7.0 mm	110	1	4652-7-110
7.0 mm	160	1	4652-7-160
8.0 mm	110	1	4652-8-110
8.0 mm	160	1	4652-8-160
8.0 mm	210	1	4652-8-210
8.0 mm	260	1	4652-8-260
8.0 mm	460	1	4652-8-460
9.0 mm	160	1	4652-9-160
9.0 mm	210	1	4652-9-210
10.0 mm	110	1	4652-10-110
10.0 mm	160	1	4652-10-160
10.0 mm	210	1	4652-10-210
10.0 mm	260	1	4652-10-260
10.0 mm	310	1	4652-10-310
10.0 mm	450	1	4652-10-450
10.0 mm	600	1	4652-10-600
11.0 mm	160	1	4652-11-160
11.0 mm	210	1	4652-11-210
11.0 mm	260	1	4652-11-260
12.0 mm	160	1	4652-12-160
12.0 mm	210	1	4652-12-210
12.0 mm	260	1	4652-12-260
12.0 mm	310	1	4652-12-310
12.0 mm	450	1	4652-12-450
12.0 mm	600	1	4652-12-600
12.0 mm	1000	1	4652-12-1000
13.0 mm	160	1	4652-13-160
13.0 mm	310	1	4652-13-310
14.0 mm	160	1	4652-14-160
14.0 mm	210	1	4652-14-210
14.0 mm	260	1	4652-14-260
14.0 mm	310	1	4652-14-310
14.0 mm	450	1	4652-14-450
14.0 mm	600	1	4652-14-600
14.0 mm	1000	1	4652-14-1000
15.0 mm	160	1	4652-15-160
15.0 mm	260	1	4652-15-260
16.0 mm	160	1	4652-16-160
16.0 mm	210	1	4652-16-210
16.0 mm	260	1	4652-16-260
16.0 mm	310	1	4652-16-310
16.0 mm	450	1	4652-16-450
16.0 mm	600	1	4652-16-600
16.0 mm	800	1	4652-16-800
16.0 mm	1000	1	4652-16-1000

Ø	L		
18.0 mm	200	1	4652-18-200
18.0 mm	300	1	4652-18-300
18.0 mm	450	1	4652-18-450
18.0 mm	1000	1	4652-18-1000
20.0 mm	200	1	4652-20-200
20.0 mm	300	1	4652-20-300
20.0 mm	450	1	4652-20-450
20.0 mm	600	1	4652-20-600
20.0 mm	1000	1	4652-20-1000
22.0 mm	250	1	4652-22-250
22.0 mm	450	1	4652-22-450
22.0 mm	600	1	4652-22-600
22.0 mm	1000	1	4652-22-1000
24.0 mm	250	1	4652-24-250
24.0 mm	450	1	4652-24-450
25.0 mm	250	1	4652-25-250
25.0 mm	450	1	4652-25-450
25.0 mm	1000	1	4652-25-1000
26.0 mm	250	1	4652-26-250
26.0 mm	450	1	4652-26-450

## Forets pour maçonnerie



### 4641

Ø	L		
3.0 mm	60	1	4641-3-60
4.0 mm	75	1	4641-4-75
5.0 mm	85	1	4641-5-85
5.0 mm	150	1	4641-5-150
5.5 mm	85	1	4641-5.5-85
6.0 mm	100	1	4641-6-100
6.0 mm	150	1	4641-6-150
6.0 mm	400	1	4641-6-400
6.5 mm	100	1	4641-6.5-100
7.0 mm	100	1	4641-7-100
8.0 mm	120	1	4641-8-120
8.0 mm	200	1	4641-8-200
8.0 mm	400	1	4641-8-400
9.0 mm	120	1	4641-9-120
10.0 mm	120	1	4641-10-120
10.0 mm	200	1	4641-10-200
10.0 mm	400	1	4641-10-400
10.0 mm	600	1	4641-10-600
11.0 mm	150	1	4641-11-150
12.0 mm	150	1	4641-12-150
12.0 mm	200	1	4641-12-200
12.0 mm	400	1	4641-12-400
12.0 mm	600	1	4641-12-600
13.0 mm	150	1	4641-13-150
14.0 mm	150	1	4641-14-150
14.0 mm	400	1	4641-14-400
14.0 mm	600	1	4641-14-600
16.0 mm	150	1	4641-16-150
16.0 mm	400	1	4641-16-400
16.0 mm	600	1	4641-16-600
18.0 mm	400	1	4641-18-400
18.0 mm	600	1	4641-18-600

Ø	L		
20.0 mm	400	1	4641-20-400
20.0 mm	600	1	4641-20-600
22.0 mm	400	1	4641-22-400
24.0 mm	400	1	4641-24-400
25.0 mm	400	1	4641-25-400

## Jeu de forets pour maçonnerie



### 4641-PB

X	g		
5	185	1	4641-PB

4641-4-75, 4641-5-85, 4641-6-100, 4641-8-120, 4641-10-120

## Jeu de forets pointe carbure pour la maçonnerie - 5 pcs



### 4643-PB

X	g		
5	150	1	4643-PB



## Burins SDS Max pour béton armé



### 4659



Ø	L		
90.0 mm	400	1	4659-ASPHALT-40
- mm	280	1	4659-POINT-28
- mm	400	1	4659-POINT-40
- mm	600	1	4659-POINT-60
24.0 mm	280	1	4659-FLAT -28
24.0 mm	400	1	4659-FLAT -40
24.0 mm	600	1	4659-FLAT -60
80.0 mm	300	1	4659-WIDE-30-8
115.0 mm	350	1	4659-WIDE-35-11
50.0 mm	360	1	4659-WIDE-36-5
35.0 mm	380	1	4659-WING-C38-3
50.0 mm	300	1	4659-TILE-30-5
80.0 mm	300	1	4659-TILE-30-8
110.0 mm	400	1	4659-SPADE-40
45.0 mm	240	1	4659-BUSHING-24
26.0 mm	300	1	4659-HOLLOW-30

## Burins SDS+ pour béton armé



### 4655



Ø	L		
20.0 mm	250	1	4655-FLAT-250
22.0 mm	240	1	4655-HOLLOW-240
- mm	250	1	4655-POINT-250
32.0 mm	200	1	4655-SLOT-25032
38.0 mm	200	1	4655-TILE-20040
60.0 mm	250	1	4655-TILE-25060
38.0 mm	200	1	4655-WIDE-20040
22.0 mm	250	1	4655-WING-C-250

## Forets Cobalt HSS-E pour le métal

Dimensions de 1 à 4 mm, deux mèches dans chaque tube



### 4411

Ø	L		
1.00 mm	34	1	4411-1.00
1.50 mm	40	1	4411-1.50

Ø	L		
2.00 mm	49	1	4411-2.00
2.50 mm	57	1	4411-2.50
3.00 mm	61	1	4411-3.00
3.25 mm	65	1	4411-3.25
3.30 mm	65	1	4411-3.30
3.50 mm	70	1	4411-3.50
4.00 mm	75	1	4411-4.00
4.20 mm	75	1	4411-4.20
4.25 mm	75	1	4411-4.25
4.50 mm	80	1	4411-4.50
5.00 mm	86	1	4411-5.00
5.50 mm	93	1	4411-5.50
6.00 mm	93	1	4411-6.00
6.50 mm	101	1	4411-6.50
6.80 mm	109	1	4411-6.80
7.00 mm	109	1	4411-7.00
7.50 mm	109	1	4411-7.50
8.00 mm	117	1	4411-8.00
8.50 mm	117	1	4411-8.50
9.00 mm	125	1	4411-9.00
9.50 mm	125	1	4411-9.50
10.00 mm	125	1	4411-10.00
10.20 mm	133	1	4411-10.20
10.50 mm	133	1	4411-10.50
11.00 mm	142	1	4411-11.00
11.50 mm	142	1	4411-11.50
12.00 mm	151	1	4411-12.00
12.50 mm	151	1	4411-12.50
13.00 mm	151	1	4411-13.00

## Forets Cobalt HSS-E pour le métal, Emballage industriel



### 4511

Ø	L		
0.50 mm	22	1	4511-0.50-10P
0.75 mm	28	1	4511-0.75-10P
1.00 mm	34	1	4511-1.00-10P
1.50 mm	40	1	4511-1.50-10P
1.75 mm	46	1	4511-1.75-10P
2.00 mm	49	1	4511-2.00-10P
2.50 mm	57	1	4511-2.50-10P
2.70 mm	61	1	4511-2.70-10P
2.90 mm	61	1	4511-2.90-10P
3.00 mm	61	1	4511-3.00-10P
3.10 mm	65	1	4511-3.10-10P
3.25 mm	65	1	4511-3.25-10P
3.30 mm	65	1	4511-3.30-10P
3.50 mm	70	1	4511-3.50-10P
3.80 mm	75	1	4511-3.80-10P
4.00 mm	75	1	4511-4.00-10P
4.20 mm	75	1	4511-4.20-10P
4.50 mm	80	1	4511-4.50-10P
4.80 mm	86	1	4511-4.80-10P
5.00 mm	86	1	4511-5.00-10P
5.20 mm	86	1	4511-5.20-10P
5.50 mm	93	1	4511-5.50-10P
6.00 mm	93	1	4511-6.00-10P
6.20 mm	101	1	4511-6.20-10P
6.50 mm	101	1	4511-6.50-10P

Ø	L		
6.80 mm	109	1	4511-6.80-10P
7.00 mm	109	1	4511-7.00-10P
7.20 mm	109	1	4511-7.20-10P
7.50 mm	109	1	4511-7.50-10P
7.80 mm	117	1	4511-7.80-10P
8.00 mm	117	1	4511-8.00-10P
8.50 mm	117	1	4511-8.50-10P
8.60 mm	125	1	4511-8.60-10P
8.80 mm	125	1	4511-8.80-10P
9.00 mm	125	1	4511-9.00-10P
9.20 mm	125	1	4511-9.20-10P
9.50 mm	125	1	4511-9.50-10P
9.60 mm	133	1	4511-9.60-10P
10.00 mm	133	1	4511-10.00-5P
10.20 mm	133	1	4511-10.20-5P
10.30 mm	133	1	4511-10.30-5P
10.50 mm	133	1	4511-10.50-5P
10.80 mm	142	1	4511-10.80-5P
11.00 mm	142	1	4511-11.00-5P
11.50 mm	142	1	4511-11.50-5P
12.00 mm	151	1	4511-12.00-5P
12.50 mm	151	1	4511-12.50-5P
12.80 mm	151	1	4511-12.80-5P
13.00 mm	151	1	4511-13.00-5P
13.50 mm	160	1	4511-13.50-1P
14.00 mm	160	1	4511-14.00-1P
14.50 mm	169	1	4511-14.50-1P
15.00 mm	169	1	4511-15.00-1P
15.50 mm	169	1	4511-15.50-1P
16.00 mm	178	1	4511-16.00-1P
16.50 mm	184	1	4511-16.50-1P
17.00 mm	184	1	4511-17.00-1P
17.50 mm	191	1	4511-17.50-1P
18.00 mm	191	1	4511-18.00-1P
18.50 mm	198	1	4511-18.50-1P
19.00 mm	198	1	4511-19.00-1P
19.50 mm	205	1	4511-19.50-1P
20.00 mm	205	1	4511-20.00-1P

## Jeu de forets Cobalt HSS-E pour le métal - 6 pcs



### 4511-SET-6

X	g		
6	150	1	4511-SET-6

4411-2.00, 4411-3.00, 4411-4.00, 4411-5.00, 4411-6.00, 4411-8.00

Jeu de forets Cobalt HSS-E pour le métal - 19 pcs



**4511-SET-19**

19	600	1	4511-SET-19

4411-1.00, 4411-1.50, 4411-2.00, 4411-2.50,  
4411-3.00, 4411-3.50, 4411-4.00, 4411-4.50,  
4411-5.00, 4411-5.50, 4411-6.00, 4411-6.50,  
4411-7.00, 4411-7.50, 4411-8.00, 4411-8.50,  
4411-9.00, 4411-9.50, 4411-10.00

Jeu de forets Cobalt HSS-E pour le métal - 25 pcs



**4511-SET-25**

25	1200	1	4511-SET-25

Forets HSS-G pour le métal  
Dimensions de 1 à 4 mm, deux mèches dans chaque tube



**4413**

1.00 mm	34	1	4413-1.00
1.50 mm	40	1	4413-1.50

2.00 mm	49	1	4413-2.00
2.50 mm	57	1	4413-2.50
3.00 mm	61	1	4413-3.00
3.25 mm	65	1	4413-3.25
3.30 mm	65	1	4413-3.30
3.50 mm	70	1	4413-3.50
4.00 mm	75	1	4413-4.00
4.20 mm	75	1	4413-4.20
4.25 mm	75	1	4413-4.25
4.50 mm	80	1	4413-4.50
5.00 mm	86	1	4413-5.00
5.50 mm	93	1	4413-5.50
6.00 mm	93	1	4413-6.00
6.50 mm	101	1	4413-6.50
6.80 mm	109	1	4413-6.80
7.00 mm	109	1	4413-7.00
7.50 mm	109	1	4413-7.50
8.00 mm	117	1	4413-8.00
8.50 mm	117	1	4413-8.50
9.00 mm	125	1	4413-9.00
9.50 mm	125	1	4413-9.50
10.00 mm	133	1	4413-10.00
10.20 mm	133	1	4413-10.20
10.50 mm	133	1	4413-10.50
11.00 mm	142	1	4413-11.00
11.50 mm	142	1	4413-11.50
12.00 mm	151	1	4413-12.00
12.50 mm	151	1	4413-12.50
13.00 mm	151	1	4413-13.00

Forets HSS-G pour le métal - 1, 5 et 10 pcs  
emballages industriels



**4513**

1.00 mm	34	1	4513-1.00-10P
1.50 mm	40	1	4513-1.50-10P
1.75 mm	46	1	4513-1.75-10P
2.00 mm	49	1	4513-2.00-10P
2.50 mm	57	1	4513-2.50-10P
2.70 mm	61	1	4513-2.70-10P
2.90 mm	61	1	4513-2.90-10P
3.00 mm	61	1	4513-3.00-10P
3.10 mm	65	1	4513-3.10-10P
3.25 mm	65	1	4513-3.25-10P
3.30 mm	65	1	4513-3.30-10P
3.50 mm	70	1	4513-3.50-10P
3.80 mm	75	1	4513-3.80-10P
4.00 mm	75	1	4513-4.00-10P
4.20 mm	75	1	4513-4.20-10P
4.50 mm	80	1	4513-4.50-10P
4.80 mm	86	1	4513-4.80-10P
5.00 mm	86	1	4513-5.00-10P
5.20 mm	86	1	4513-5.20-10P
5.50 mm	93	1	4513-5.50-10P
6.00 mm	93	1	4513-6.00-10P
6.20 mm	101	1	4513-6.20-10P
6.50 mm	101	1	4513-6.50-10P

6.80 mm	109	1	4513-6.80-10P
7.00 mm	109	1	4513-7.00-10P
7.20 mm	109	1	4513-7.20-10P
7.50 mm	109	1	4513-7.50-10P
7.80 mm	117	1	4513-7.80-10P
8.00 mm	117	1	4513-8.00-10P
8.50 mm	117	1	4513-8.50-10P
8.60 mm	125	1	4513-8.60-10P
8.80 mm	125	1	4513-8.80-10P
9.00 mm	125	1	4513-9.00-10P
9.20 mm	125	1	4513-9.20-10P
9.50 mm	125	1	4513-9.50-10P
9.60 mm	133	1	4513-9.60-10P
10.00 mm	133	1	4513-10.00-5P
10.20 mm	133	1	4513-10.20-5P
10.30 mm	133	1	4513-10.30-5P
10.50 mm	133	1	4513-10.50-5P
10.80 mm	142	1	4513-10.80-5P
11.00 mm	142	1	4513-11.00-5P
11.50 mm	142	1	4513-11.50-5P
12.00 mm	151	1	4513-12.00-5P
12.50 mm	151	1	4513-12.50-5P
12.80 mm	151	1	4513-12.80-5P
13.00 mm	151	1	4513-13.00-5P
13.50 mm	160	1	4513-13.50-1P
14.00 mm	160	1	4513-14.00-1P
14.50 mm	169	1	4513-14.50-1P
15.00 mm	169	1	4513-15.00-1P
15.50 mm	178	1	4513-15.50-1P
16.00 mm	178	1	4513-16.00-1P
16.50 mm	184	1	4513-16.50-1P
17.00 mm	184	1	4513-17.00-1P
17.50 mm	191	1	4513-17.50-1P
18.00 mm	191	1	4513-18.00-1P
18.50 mm	198	1	4513-18.50-1P
19.00 mm	198	1	4513-19.00-1P
19.50 mm	205	1	4513-19.50-1P
20.00 mm	205	1	4513-20.00-1P

Jeu de forets HSS-G pour le métal - 6 pcs



**4513-SET-6**

6	150	1	4513-SET-6

4413-2.00, 4413-3.00, 4413-4.00, 4413-5.00,  
4413-6.00, 4413-8.00



Jeu de forets HSS-G pour le métal - 19 pcs



**4513-SET-19**

19	600	1	4513-SET-19

4413-1.00, 4413-1.50, 4413-2.00, 4413-2.50,  
4413-3.00, 4413-3.50, 4413-4.00, 4413-4.50,  
4413-5.00, 4413-5.50, 4413-6.00, 4413-6.50,  
4413-7.00, 4413-7.50, 4413-8.00, 4413-8.50,  
4413-9.00, 4413-9.50, 4413-10.00

Jeu de forets HSS-G pour le métal - 25 pcs



**4513-SET-25**

25	1200	1	4513-SET-25

Forets HSS-R pour le métal  
Dimensions de 1 à 4 mm, deux mèches dans chaque tube



**4415**

1.00 mm	34	1	4415-1.00
1.50 mm	40	1	4415-1.50

2.00 mm	49	1	4415-2.00
2.50 mm	57	1	4415-2.50
3.00 mm	61	1	4415-3.00
3.25 mm	65	1	4415-3.25
3.50 mm	70	1	4415-3.50
4.00 mm	75	1	4415-4.00
4.25 mm	75	1	4415-4.25
4.50 mm	80	1	4415-4.50
5.00 mm	86	1	4415-5.00
5.50 mm	93	1	4415-5.50
6.00 mm	93	1	4415-6.00
6.50 mm	101	1	4415-6.50
7.00 mm	109	1	4415-7.00
7.50 mm	109	1	4415-7.50
8.00 mm	117	1	4415-8.00
8.50 mm	117	1	4415-8.50
9.00 mm	125	1	4415-9.00
10.00 mm	125	1	4415-10.00
10.50 mm	133	1	4415-10.50
11.00 mm	142	1	4415-11.00
11.50 mm	142	1	4415-11.50
12.00 mm	151	1	4415-12.00
12.50 mm	151	1	4415-12.50
13.00 mm	151	1	4415-13.00
13.50 mm	160	1	4415-13.50
14.00 mm	160	1	4415-14.00
14.50 mm	169	1	4415-14.50
15.00 mm	169	1	4415-15.00
15.50 mm	178	1	4415-15.50
16.00 mm	178	1	4415-16.00
16.50 mm	184	1	4415-16.50
17.00 mm	184	1	4415-17.00
17.50 mm	191	1	4415-17.50
18.00 mm	191	1	4415-18.00
18.50 mm	198	1	4415-18.50
19.00 mm	198	1	4415-19.00
19.50 mm	205	1	4415-19.50
20.00 mm	205	1	4415-20.00

Forets HSS-R pour le métal, emballage industriel



**4515**

1.00 mm	34	1	4515-1.00-10P
1.50 mm	40	1	4515-1.50-10P
2.00 mm	49	1	4515-2.00-10P
2.50 mm	57	1	4515-2.50-10P
3.00 mm	61	1	4515-3.00-10P
3.25 mm	65	1	4515-3.25-10P
3.50 mm	70	1	4515-3.50-10P
4.00 mm	75	1	4515-4.00-10P
4.25 mm	75	1	4515-4.25-10P
4.50 mm	80	1	4515-4.50-10P
5.00 mm	86	1	4515-5.00-10P
5.50 mm	93	1	4515-5.50-10P
6.00 mm	93	1	4515-6.00-10P
6.50 mm	101	1	4515-6.50-10P

7.00 mm	109	1	4515-7.00-10P
7.50 mm	109	1	4515-7.50-10P
8.00 mm	117	1	4515-8.00-10P
8.50 mm	117	1	4515-8.50-10P
9.00 mm	125	1	4515-9.00-10P
9.50 mm	125	1	4515-9.50-10P
10.00 mm	133	1	4515-10.00-10P
10.50 mm	133	1	4515-10.50-5P
11.00 mm	142	1	4515-11.00-5P
11.50 mm	142	1	4515-11.50-5P
12.00 mm	151	1	4515-12.00-5P
12.50 mm	151	1	4515-12.50-5P
13.00 mm	151	1	4515-13.00-5P

Jeu de forets HSS-R pour le métal - 19 pcs



**4515-SET-19**

19	600	1	4515-SET-19

Forets HSS-R pour le métal, 25 pcs



**4515-SET-25**

25	1200	1	4515-SET-25

Jeu de forets étagés HSS - 3 pcs



**228-SD**

6.35 mm	4.5-6-7-8-9-10-11-12 mm	24	228-SD

Foret étagé - 4 à 22 mm



**229-SD**

10 mm	4-6-8-10-12-14-16-18-20-22 mm	24	229-SD

Foret étagé - 5 à 35 mm



**230-SD**

12.7 mm	5-13-15-17-19-21-23-25-27-29-31-33-35 mm	25	230-SD

Foret étagé - 6 à 37 mm



**232-SD**

10 mm	6-9-12.5-15.2-18.6-20.4-22.5-26-28.3-30.5-34-37 mm	1	232-SD

Foret étagé - 6,5 à 40,5 mm



**234-SD**

10 mm	6.5-8.5-10.5-12.5-16.5-20.5-25.5-29-32.5-36.5-40.5 mm	25	234-SD

Jeu de forets étagés HSS 4-35mm



**228-SET**

3	560	1	228-SET-SD

<b>228-SD</b>	
<b>229-SD</b>	
<b>230-SD</b>	

Forets à fraiser HSS-G pour métal



**4435**

12.4 mm	56	1	4435-12.4

Mèches à bois hélicoïdales



**9626/9627**

6.0 mm	1	9626-6
7.0 mm	1	9626-7
8.0 mm	1	9626-8
9.0 mm	1	9626-9
10.0 mm	1	9626-10
11.0 mm	1	9626-11
12.0 mm	1	9626-12
13.0 mm	1	9626-13
14.0 mm	1	9626-14
15.0 mm	1	9626-15
16.0 mm	1	9626-16
18.0 mm	1	9626-18
20.0 mm	1	9626-20
22.0 mm	1	9626-22
23.0 mm	1	9626-23
24.0 mm	1	9626-24
25.0 mm	1	9626-25
26.0 mm	1	9626-26
28.0 mm	1	9626-28
30.0 mm	1	9626-30
32.0 mm	1	9626-32
35.0 mm	1	9626-35
6.0 mm	1	9627-6-460
8.0 mm	1	9627-8-460
10.0 mm	1	9627-10-460
12.0 mm	1	9627-12-460
14.0 mm	1	9627-14-460
16.0 mm	1	9627-16-460
18.0 mm	1	9627-18-460
20.0 mm	1	9627-20-460
22.0 mm	1	9627-22-460
24.0 mm	1	9627-24-460
26.0 mm	1	9627-26-460
28.0 mm	1	9627-28-460
30.0 mm	1	9627-30-460
32.0 mm	1	9627-32-460



Jeu de mèches hélicoïdales  
10, 13, 16, 19, 22, 25 mm



**SB-9526/S6**



6 20 SB-9526/S6

Mèches à bois plates



**9629/9631**



6.0 mm	152	1	9629-6
8.0 mm	152	1	9629-8
10.0 mm	152	1	9629-10
12.0 mm	152	1	9629-12
13.0 mm	152	1	9629-13
14.0 mm	152	1	9629-14
16.0 mm	152	1	9629-16
17.0 mm	152	1	9629-17
18.0 mm	152	1	9629-18
19.0 mm	152	1	9629-19
20.0 mm	152	1	9629-20
22.0 mm	152	1	9629-22
24.0 mm	152	1	9629-24
25.0 mm	152	1	9629-25
26.0 mm	152	1	9629-26
28.0 mm	152	1	9629-28
30.0 mm	152	1	9629-30
32.0 mm	152	1	9629-32
35.0 mm	152	1	9629-35
36.0 mm	152	1	9629-36
38.0 mm	152	1	9629-38
40.0 mm	152	1	9629-40
6.0 mm	400	1	9631-6-400
8.0 mm	400	1	9631-8-400
10.0 mm	400	30	9631-10-400
12.0 mm	400	1	9631-12-400
14.0 mm	400	1	9631-14-400
16.0 mm	400	1	9631-16-400
18.0 mm	400	1	9631-18-400
20.0 mm	400	1	9631-20-400
22.0 mm	400	1	9631-22-400
24.0 mm	400	1	9631-24-400
25.0 mm	400	1	9631-25-400
28.0 mm	400	1	9631-28-400



30.0 mm	400	1	9631-30-400
32.0 mm	400	1	9631-32-400
35.0 mm	400	1	9631-35-400

Jeu de mèches à bois plates - 8 pièces



**9629-SET-8**



8 630 1 9629-SET-8

9629-12, 9629-16, 9629-18, 9629-20, 9629-22,  
9629-25, 9629-28, 9629-32

Mèches à bois 3 points



**9646**



3 mm	1	9646-3
4 mm	1	9646-4
5 mm	1	9646-5
6 mm	1	9646-6
7 mm	1	9646-7
8 mm	1	9646-8
9 mm	1	9646-9
10 mm	1	9646-10
11 mm	1	9646-11
12 mm	1	9646-12
13 mm	1	9646-13
14 mm	1	9646-14
15 mm	1	9646-15
16 mm	1	9646-16
18 mm	1	9646-18
20 mm	1	9646-20
6 mm	1	9646-6-250
8 mm	1	9646-8-250
10 mm	1	9646-10-250
12 mm	1	9646-12-250

Jeu de mèches à bois - 5 pièces



**9646-SET-5**



5 110 1 9646-SET-5

9646-4, 9646-5, 9646-6, 9646-8, 9646-10

Jeu de mèches à bois - 8 pièces



**9646-SET-8**



8 230 1 9646-SET-8

9646-3, 9646-4, 9646-5, 9646-6, 9646-7, 9646-8,  
9646-9, 9646-10

Mèches à bois extensibles



**9528**



15-45 mm	10	9528-MD-15-45
22-76 mm	10	9528-MD-22-76

### Forets pour carrelage



#### 4626

Ø	L	Icon	Code
4	58		1 4626-4.0
5	58		1 4626-5.0
6	58		1 4626-6.0
8	78		1 4626-8.0
10	98		1 4626-10.0

### Forets multi usages



#### 4629

Ø	L	Icon	Code
4.0 mm	75		1 4629-4.0
5.0 mm	85		1 4629-5.0
6.0 mm	100		1 4629-6.0
8.0 mm	120		1 4629-8.0
10.0 mm	120		1 4629-10.0

### Jeu de forets pointe carbure multi usages - 5 pcs



#### 4629-SET-5

Icon	g	Icon	Code
	165		10 4629-SET-5

4629-8.0, 4629-10.0, 4629-4.0, 4629-5.0, 4629-6.0

### Rallonge 305 mm 1/4" changement rapide



#### 9625-6.35QC

Ø	L	Icon	Code
6.35 mm	305 mm		1 9625-6.35QC

### Rallonge 330mm



#### 9525

Ø	L	Icon	Code
14-19			1 9525-7
20-32			1 9525-10

## EMBOUS

### Embouts diamant Phillips - 25 mm



#### 63D/PH

Icon	Icon	Icon	Code
			5 1 63D/PH1
			5 2 1 63D/PH2
			5 3 1 63D/PH3

### Embouts diamant Grabber Phillips - 25 mm



#### 63D/PH2G

Icon	Icon	Icon	Code
			5 PH2G 1 63D/PH2G

### Embouts diamant Pozidriv - 25 mm



#### 63D/PZ

Icon	Icon	Icon	Code
			5 1 1 63D/PZ1
			5 2 1 63D/PZ2
			5 3 1 63D/PZ3

### Embouts diamant Torx® - 25 mm



#### 63D/T

Icon	Icon	Icon	Code
			5 T10 1 63D/T10
			5 T15 1 63D/T15
			2 T15 1 63D/T15-2P
			5 T20 1 63D/T20
			2 T20 1 63D/T20-2P
			5 T25 1 63D/T25
			2 T25 1 63D/T25-2P
			5 T30 1 63D/T30
			2 T30 1 63D/T30-2P
			5 T40 1 63D/T40
			2 T40 1 63D/T40-2P



Embout diamant Phillips - 50 mm  
Boîte plastique de 5 pièces



**63D/50PH**

5	1	1	63D/50PH1
5	2	1	63D/50PH2
5	3	1	63D/50PH3

Embout à torsion en titane Phillips - 25 mm



**62TIN/PH**

10	1	1	62TIN/PH1
10	2	1	62TIN/PH2
10	3	1	62TIN/PH3

Embout à torsion en titane Phillips - 50 mm



**62TIN/50PH**

5	1	1	62TIN/50PH1
5	2	1	62TIN/50PH2
5	3	1	62TIN/50PH3

Embout diamant Pozidriv - 50 mm  
Boîte plastique de 5 pièces



**63D/50PZ**

5	1	1	63D/50PZ1
5	2	1	63D/50PZ2
5	3	1	63D/50PZ3

Embout à torsion en titane Pozidriv - 25 mm



**62TIN/PZ**

10	1	1	62TIN/PZ1
10	2	1	62TIN/PZ2
10	3	1	62TIN/PZ3

Embout à torsion en titane Pozidriv - 50 mm



**62TIN/50PZ**

5	1	1	62TIN/50PZ1
5	2	1	62TIN/50PZ2
5	3	1	62TIN/50PZ3

Jeu d'embouts diamant - 7 pcs  
PH2, PZ2, T15, T20, T25, T30, 1/4- 50mm



**63D/7**

7	20 x 50 x 80 mm	1 63D/7-1

63D/PH2		
63D/PZ2		
63D/T10, 63D/T15, 63D/T25, 63D/T30		

Embout à torsion en titane TORX® - 25 mm



**62TIN/T**

10	T10	1	62TIN/T10
10	T15	1	62TIN/T15
10	T20	1	62TIN/T20
10	T25	1	62TIN/T25
10	T30	1	62TIN/T30
10	T40	1	62TIN/T40

Jeu d'embouts à torsion en titane - 7 pcs



**62TIN/7**

7	22 x 65 x 75 mm	1 62TIN/7-1

62TIN/PH2		
62TIN/PZ2		
62TIN/T15, 62TIN/T20, 62TIN/T25, 62TIN/T30		



Embout à torsion ACR Phillips - 25 mm



**64A/PH**

QTY	PH	2P	Model
10	1	1	64A/PH1
2	1	1	64A/PH1-2P
10	2	1	64A/PH2
2	2	1	64A/PH2-2P
10	3	1	64A/PH3
2	3	1	64A/PH3-2P

Embout à torsion ACR Pozidriv - 25 mm



**64A/PZ**

QTY	PH	2P	Model
10	1	1	64A/PZ1
2	1	1	64A/PZ1-2P
10	2	1	64A/PZ2
2	2	1	64A/PZ2-2P
10	3	1	64A/PZ3
2	3	1	64A/PZ3-2P

Embout à torsion Phillips - 25 mm



**60T/PH**

QTY	PH	2P	Model
10	1	1	60T/PH1
10	2	1	60T/PH2
10	3	1	60T/PH3

Embout à torsion Pozidriv - 25 mm



**60T/PZ**

QTY	PH	2P	Model
10	1	1	60T/PZ1
10	2	1	60T/PZ2
10	3	1	60T/PZ3

Embout à torsion Torx® - 25 mm



**60T/T**

QTY	PH	2P	Model
10			T7
10			T8
10			T9
10			T10
10			T15
10			T20
10			T25
10			T27
10			T30
10			T40

Jeu d'embouts à torsion - 7 pcs



**60T/7**

QTY	PH	2P	Model
7			22 x 65 x 75 mm 1 60T/7-1

60T/PH2	+	
60T/PZ2	+	
60T/T10, 60T/T15, 60T/T20, 60T/T30	+	

Jeu d'embouts à torsion - 17 pcs



**60T/17**

QTY	PH	2P	Model
17			27 x 73 x 82 mm 1 60T/17-1

60T/PH1, 60T/PH2	+	
60T/T7, 60T/T8, 60T/T9, 60T/T10, 2x 60T/T15, 2x 60T/T20, 2x 60T/T25, 60T/T27, 2x 60T/T30, 60T/T40	+	

Jeu d'embouts à torsion - 31 pcs



**60T/31**

QTY	PH	2P	Model
31			42 x 65 x 110 mm 12 60T/31-1

59S/0.6-4.5, 59S/0.8-5.5	⊖	
60T/PH1, 3x 60T/PH2, 60T/PH3	+	
2x 59S/PH2G	+	
60T/PZ1, 3x 60T/PZ2, 60T/PZ3	+	
60T/T10, 3x 60T/T15, 3x 60T/T20, 2x 60T/T25, 60T/T27, 2x 60T/T30	+	
59S/H3, 59S/H4, 59S/H5, 59S/H6	⊖	



Embout à torsion extra durs Phillips - 25 mm



**61H/PH**

10	1	1	61H/PH1
10	2	1	61H/PH2
5	3	1	61H/PH3

Embout à torsion extra durs Phillips - 50 mm



**61H/50PH**

5	1	1	61H/50PH1
5	2	1	61H/50PH2
5	3	1	61H/50PH3

Embout à torsion extra durs Pozidriv - 25 mm



**61H/PZ**

10	1	1	61H/PZ1
10	2	1	61H/PZ2
5	3	1	61H/PZ3

Embout à torsion extra durs Pozidriv - 50 mm



**61H/50PZ**

5	1	1	61H/50PZ1
5	2	1	61H/50PZ2
5	3	1	61H/50PZ3

Embout à torsion extra durs Torx® - 50 mm



**61H/50T**

5	T10	1	61H/50T10
5	T15	1	61H/50T15
5	T20	1	61H/50T20
5	T25	1	61H/50T25
5	T30	1	61H/50T30
5	T40	1	61H/50T40

Embout à torsion extra durs Torx® - 25 mm



**61H/T**

10	T10	1	61H/T10
10	T15	1	61H/T15
10	T20	1	61H/T20
10	T25	1	61H/T25
10	T30	1	61H/T30
5	T40	1	61H/T40

Embout standard à fente - 25 mm



**59S/**

10	3.0	1	59S/0.5-3.0
3	3.0	50	59S/0.5-3.0-3P
10	4.0	1	59S/0.5-4.0
3	4.0	50	59S/0.5-4.0-3P
10	3.5	1	59S/0.6-3.5
3	3.5	50	59S/0.6-3.5-3P
10	4.5	1	59S/0.6-4.5
3	4.5	1	59S/0.6-4.5-3P
10	5.5	1	59S/0.8-5.5
3	5.5	1	59S/0.8-5.5-3P
10	5.5	1	59S/1.0-5.5
3	5.5	50	59S/1.0-5.5-3P
10	6.5	1	59S/1.2-6.5
3	6.5	50	59S/1.2-6.5-3P
10	8.0	1	59S/1.2-8.0
3	8.0	1	59S/1.2-8.0-3P
10	9.0	1	59S/1.6-9.0
10	10	1	59S/1.6-10
3	9.0	50	59S/1.6-9.0-3P
3	10.0	50	59S/1.6-10-3P

Jeu de 26 pièces : 18 embouts pour vis à fente, 6 pans, Phillips, Pozidriv, Torx, 5 douilles, un cliquet, un adaptateur et un porte-embout



**2058/S26-2**

80 x 100 x 35 mm	1	2058/S26-2

6700SM-8, 6700SM-7, 6700SM-6, 6700SM-5, 6700SM-4		
KM753-QR-1P		
K6625-1/4		
59S/0.5-3.0, 59S/0.8-5.5, 59S/0.5-4.0		
59S/T8, 59S/T7, 59S/T6, 59S/T5, 59S/T4		
59S/PZ1, 59S/PZ0, 59S/PZ2		
59S/H2, 59S/H2.5, 59S/H1.5, 59S/H3		
59S/PH1, 59S/PH0, 59S/PH2		

Embout standard Phillips - 25 mm



**59S/PH**

X	+		
10	0	1	59S/PH0
3	0	50	59S/PH0-3P
10	1	1	59S/PH1
3	1	1	59S/PH1-3P
30	1	1	59S/PH1-30P
100	*1	100	59S/PH1-IP
500	1	500	59S/PH1-IPB
10	2	1	59S/PH2
3	2	1	59S/PH2-3P
30	2	1	59S/PH2-30P
100	*2	100	59S/PH2-IP
500	*2	500	59S/PH2-IPB
10	3	1	59S/PH3
3	3	1	59S/PH3-3P
30	3	1	59S/PH3-30P
500	3	500	59S/PH3-IPB
10	4	1	59S/PH4
3	4	25	59S/PH4-3P

Embout standard Grabber Phillips - 25 mm



**59S/PH2G**

X	+		
10	PH 2G	1	59S/PH2G
3	PH 2G	50	59S/PH2G-3P
30	PH2G	1	59S/PH2G-30P

Embout standard Pozidriv - 25 mm



**59S/PZ**

X	+		
10	0	1	59S/PZ0
3	0	50	59S/PZ0-3P

X	+		
10	1	1	59S/PZ1
3	1	1	59S/PZ1-3P
30	1	1	59S/PZ1-30P
100	*1	100	59S/PZ1-IP
500	*1	500	59S/PZ1-IPB
10	2	1	59S/PZ2
3	2	1	59S/PZ2-3P
30	2	1	59S/PZ2-30P
100	*2	100	59S/PZ2-IP
500	*2	500	59S/PZ2-IPB
10	3	1	59S/PZ3
3	3	1	59S/PZ3-3P
30	3	1	59S/PZ3-30P
500	3	500	59S/PZ3-IPB
10	4	1	59S/PZ4

Embout standard Torx® - 25 mm



**59S/T**

X	T		
5	T3	1	59S/T3
3	T3	50	59S/T3-3P
5	T4	1	59S/T4
3	T4	50	59S/T4-3P
5	T5	1	59S/T5
3	T5	50	59S/T5-3P
10	T6	1	59S/T6
3	T6	50	59S/T6-3P
10	T7	1	59S/T7
3	T7	50	59S/T7-3P
10	T8	1	59S/T8
3	T8	50	59S/T8-3P
10	T9	1	59S/T9
3	T9	50	59S/T9-3P
10	T10	1	59S/T10
3	T10	1	59S/T10-3P
30	T10	1	59S/T10-30P
10	T15	1	59S/T15
3	T15	1	59S/T15-3P
30	T15	1	59S/T15-30P
10	T20	1	59S/T20
3	T20	1	59S/T20-3P
30	T20	1	59S/T20-30P
10	T25	1	59S/T25
3	T25	1	59S/T25-3P
30	T25	1	59S/T25-30P
10	T27	1	59S/T27
3	T27	1	59S/T27-3P
5	T30	1	59S/T30
3	T30	1	59S/T30-3P
30	T30	1	59S/T30-30P
5	T40	1	59S/T40
3	T40	1	59S/T40-3P
30	T40	1	59S/T40-30P

X	T		
5	T45	1	59S/T45
3	T45	50	59S/T45-3P
5	T50	1	59S/T50
3	T50	50	59S/T50-3P

Embout coniques 1/4" pour vis TORX® 25 mm, pack de 10



**59S/TCS**

X	T		
10	T10	20	59S/T10CS
10	T15	20	59S/T15CS
10	T20	20	59S/T20CS
10	T25	20	59S/T25CS
10	T27	20	59S/T27CS
10	T30	20	59S/T30CS
10	T40	20	59S/T40CS

Embout standard Torx® tamper - 25 mm



**59S/TR**

X	T		
5	TR 7	1	59S/TR7
3	TR7	50	59S/TR7-3P
5	TR 8	1	59S/TR8
3	TR8	50	59S/TR8-3P
5	TR 9	1	59S/TR9
3	TR9	50	59S/TR9-3P
5	TR 10	1	59S/TR10
3	TR 10	1	59S/TR10-3P
5	TR 15	1	59S/TR15
3	TR 15	1	59S/TR15-3P
5	TR 20	1	59S/TR20
3	TR 20	1	59S/TR20-3P
5	TR 25	1	59S/TR25
3	TR 25	1	59S/TR25-3P
5	TR 27	1	59S/TR27
3	TR 27	1	59S/TR27-3P
5	TR 30	1	59S/TR30
3	TR 30	1	59S/TR30-3P
5	TR 40	1	59S/TR40
3	TR 40	1	59S/TR40-3P



Embouts standard 6 pans métrique - 25 mm



59S/H mm

X		+	
5	1.5	1	59S/H1.5
3	1.5	50	59S/H1.5-3P
5	2	1	59S/H2
3	2	50	59S/H2-3P
5	2.5	1	59S/H2.5
3	2.5	50	59S/H2.5-3P
5	3	1	59S/H3
3	3	1	59S/H3-3P
5	4	1	59S/H4
3	4	1	59S/H4-3P
500	4	500	59S/H4-IPB
5	5	1	59S/H5
3	5	1	59S/H5-3P
5	6	1	59S/H6
3	6	1	59S/H6-3P
5	8	1	59S/H8
3	8	1	59S/H8-3P
5	10	1	59S/H10
3	10	25	59S/H10-3P

Embouts standard 6 pans impérial - 25 mm



59S/H "

X		+	
5		1	59S/H1/16
3		50	59S/H1/16-3P
5		1	59S/H5/64
3		50	59S/H5/64-3P
5		1	59S/H3/32
3		50	59S/H3/32-3P
5		1	59S/H7/64
3		50	59S/H7/64-3P
5		1	59S/H1/8
3		50	59S/H1/8-3P
5		1	59S/H9/64
3		1	59S/H9/64-3P
5		1	59S/H5/32
3		50	59S/H5/32-3P
5		1	59S/H3/16
3		1	59S/H3/16-3P

X		+	
5		1	59S/H7/32
3		50	59S/H7/32-3P
5		1	59S/H1/4
3		50	59S/H1/4-3P
5		1	59S/H5/16
3		50	59S/H5/16-3P
5		1	59S/H3/8
3		25	59S/H3/8-3P

Embouts standard Robertson® - 25 mm



59S/R

X		+	
10	# 1	1	59S/R1
3		1	59S/R1-3P
10	# 2	1	59S/R2
3		1	59S/R2-3P
10	# 3	1	59S/R3
3		1	59S/R3-3P
10	# 4	1	59S/R4

Embouts standard Torq-Set® impérial - 25 mm



59S/TS "

X		+	
5	1/4"	1	59S/TS-1/4

Embouts standard Tri-Wing - 25 mm  
Boîte plastique de 5 pièces



59S/TW

X		+	
5	TW 0	1	59S/TW0
5	TW 1	1	59S/TW1
5	TW 2	1	59S/TW2
5	TW 3	1	59S/TW3
5	TW 4	1	59S/TW4
5	TW 5	1	59S/TW5

Embouts standard Torq-Set® métrique - 25 mm  
Boîte plastique de 5 pièces



59S/TS

X		+	
5	0	1	59S/TS-0
5	1	1	59S/TS-1
5	2	1	59S/TS-2
5	3	1	59S/TS-3
5	4	1	59S/TS-4
5	5	1	59S/TS-5
5	6	1	59S/TS-6
5	8	1	59S/TS-8
5	10	1	59S/TS-10

Embouts standard XZN - 25 mm



59S/M

X		+	
10	M3	1	59S/M3
3	M3	50	59S/M3-3P
10	M4	1	59S/M4
3	M4	50	59S/M4-3P
10	M5	1	59S/M5
3	M5	50	59S/M5-3P
10	M6	1	59S/M6
3	M6	50	59S/M6-3P
10	M8	1	59S/M8
3	M8	50	59S/M8-3P

59S/50 | Embouts standard à fente - 50 mm



59S/50

QTY	Length	Pieces	Part No.
5	3.5	1	59S/50/0.6-3.5
5	4.0	1	59S/50/0.8-4.0
5	5.5	1	59S/50/0.8-5.5
5	6.0	1	59S/50/1.0-6.0
5	6.5	1	59S/50/1.2-6.5
2	3.5	50	59S/50/3.5-2P
2	4.0	50	59S/50/4.0-2P
2	5.5	50	59S/50/5.5-2P
2	6.0	1	59S/50/6.0-2P
2	6.5	50	59S/50/6.5-2P

Embouts standard Phillips - 50 mm



59S/50PH

QTY	Length	Pieces	Part No.
5	1	1	59S/50PH1
2	1	1	59S/50PH1-2P
5	2	1	59S/50PH2
2	2	1	59S/50PH2-2P
5	3	1	59S/50PH3
2	3	1	59S/50PH3-2P

Embouts standard Pozidriv - 50 mm



59S/50PZ

QTY	Length	Pieces	Part No.
5	1	1	59S/50PZ1
2	1	1	59S/50PZ1-2P

QTY	Length	Pieces	Part No.
5	2	1	59S/50PZ2
2	2	1	59S/50PZ2-2P
5	3	1	59S/50PZ3
2	3	1	59S/50PZ3-2P

Embouts standard Torx® - 50 mm



59S/50T

QTY	Length	Pieces	Part No.
5	T 8	1	59S/50T8
2	T 8	50	59S/50T8-2P
5	T 10	1	59S/50T10
2	T10	1	59S/50T10-2P
5	T 15	1	59S/50T15
2	T15	1	59S/50T15-2P
5	T 20	1	59S/50T20
2	T20	1	59S/50T20-2P
5	T 25	1	59S/50T25
2	T25	1	59S/50T25-2P
5	T 27	1	59S/50T27
5	T 30	1	59S/50T30
2	T30	1	59S/50T30-2P
5	T 40	1	59S/50T40
2	T40	50	59S/50T40-2P

Embouts standard 6 pans métrique - 50 mm



59S/50H

QTY	Length	Pieces	Part No.
5	2	1	59S/50H2
2	2	50	59S/50H2-2P
5	2.5	1	59S/50H2.5
2	2.5	50	59S/50H2.5-2P
5	3	1	59S/50H3
2	3	50	59S/50H3-2P
5	4	1	59S/50H4
2	4	50	59S/50H4-2P
5	5	1	59S/50H5

QTY	Length	Pieces	Part No.
2	5	50	59S/50H5-2P
5	6	1	59S/50H6
2	6	50	59S/50H6-2P
5	8	1	59S/50H8
2	8	50	59S/50H8-2P

Embouts standard 6 pans impérial - 50 mm  
Boîte plastique de 5 pièces



59S/50H "

QTY	Length	Pieces	Part No.
5	1/16	1	59S/50H1/16
5	5/64	1	59S/50H5/64
5	3/32	1	59S/50H3/32
5	7/64	1	59S/50H7/64
5	1/8	1	59S/50H1/8
5	9/64	1	59S/50H9/64
5	5/32	1	59S/50H5/32
5	3/16	1	59S/50H3/16
5	7/32	1	59S/50H7/32
5	1/4	1	59S/50H1/4
5	5/16	1	59S/50H5/16
5	3/8	1	59S/50H3/8

Embouts standard Robertson® - 50 mm



59S/50R

QTY	Length	Pieces	Part No.
5	#1	1	59S/50R1
2	#1	50	59S/50R1-2P
5	#2	1	59S/50R2
2	#2	50	59S/50R2-2P
5	#3	1	59S/50R3
2	#3	50	59S/50R3-2P



Embout standard Phillips - 70 mm



**59S/70PH**

X	+		
5	1	1	59S/70PH1
2	1	1	59S/70PH1-2P
5	2	1	59S/70PH2
2	2	25	59S/70PH2-2P

Embout standard Pozidriv - 70 mm



**59S/70PZ**

X	+		
5	1	1	59S/70PZ1
2	1	1	59S/70PZ1-2P
5	2	1	59S/70PZ2
2	2	1	59S/70PZ2-2P
5	3	1	59S/70PZ3
2	3	1	59S/70PZ3-2P

Embout standard Torx® - 70 mm



**59S/70T**

X	*		
5	T10	1	59S/70T10
2	T10	1	59S/70T10-2P
5	T15	1	59S/70T15

X	*		
2	T15	25	59S/70T15-2P
2	T20	1	59S/70T20-2P
5	T20	1	59S/70T20
2	T25	25	59S/70T25-2P
5	T25	1	59S/70T25
2	T27	1	59S/70T27-2P
5	T27	1	59S/70T27
2	T30	1	59S/70T30-2P
5	T30	1	59S/70T30
2	T40	1	59S/70T40-2P
5	T40	1	59S/70T40

Embout standard Torx® tamper - 70 mm



**59S/70TR**

X	*		
5	TR15	1	59S/70TR15
2	TR15	1	59S/70TR15-2P
5	TR20	1	59S/70TR20
2	TR20	25	59S/70TR20-2P
5	TR25	1	59S/70TR25
2	TR25	25	59S/70TR25-2P
5	TR27	1	59S/70TR27
2	TR27	25	59S/70TR27-2P
5	TR30	1	59S/70TR30
2	TR30	25	59S/70TR30-2P
5	TR40	1	59S/70TR40
2	TR40	25	59S/70TR40-2P

Embout standard Phillips - 125 mm



**59S/125PH**

X	+		
5	1	1	59S/125PH1
2	1	25	59S/125PH1-2P
5	2	1	59S/125PH2
2	2	25	59S/125PH2-2P
5	3	1	59S/125PH3
2	3	25	59S/125PH3-2P

Embout standard 6 pans pointe sphérique métrique - 89 mm



**59S/H BALL**

X	+		
5	3	1	59S/H3BALL
2	3	1	59S/H3BALL-2P
5	4	1	59S/H4BALL
2	4	1	59S/H4BALL-2P
5	5	1	59S/H5BALL
2	5	1	59S/H5BALL-2P
5	6	1	59S/H6BALL
2	6	1	59S/H6BALL-2P
5	8	1	59S/H8BALL
2	8	1	59S/H8BALL-2P
3	5,6,8	1	59S/HBALL-3P

Embout standard Phillips/Combi à fente - 125 mm  
Blister de 2 pièces



**59S/PH COMBI**

X	+		
2	5.0/PH1	1	59S/PH1COMBI-2P
2	6.0/PH2	1	59S/PH2COMBI-2P
2	8.0/PH3	1	59S/PH3COMBI-2P

Embout standard Pozidriv - 125 mm



**59S/125PZ**

X	+		
5	1	1	59S/125PZ1
2	1	25	59S/125PZ1-2P
5	2	1	59S/125PZ2
2	2	25	59S/125PZ2-2P
5	3	1	59S/125PZ3
2	3	25	59S/125PZ3-2P

Embouts standard Torx® - 150 mm



**59S/150T**

5	T15	1	59S/150T15
2	T15	1	59S/150T15-2P
5	T20	1	59S/150T20
2	T20	1	59S/150T20-2P
5	T25	1	59S/150T25
2	T25	1	59S/150T25-2P
5	T30	1	59S/150T30
2	T30	1	59S/150T30-2P

Embouts standard 5/32" Phillips - 25 mm



**45S/PH**

5	1	1	45S/PH1
2	1	50	45S/PH1-2P
5	2	1	45S/PH2
2	2	50	45S/PH2-2P

Embouts standard 5/32" 6 pans - 25 mm



**45S/H**

5	1.5	1	45S/H1.5
2	1.5	50	45S/H1.5-2P
5	2	1	45S/H2
2	2	50	45S/H2-2P
5	2.5	1	45S/H2.5
2	2.5	50	45S/H2.5-2P
5	3	1	45S/H3
2	3	50	45S/H3-2P

Jeu d'embouts standard et porte-embouts - 7 pcs  
PH1, PH2, PZ1, PZ2, T15, T20, 1/4 - 50 mm



**59S/7-1**

7	22 x 65 x 75 mm	1 59S/7-1

59S/PH1, 59S/PH2		
59S/PZ1, 59S/PZ2		
59S/T15, 59S/T20		

Jeu d'embouts standard et porte-embouts - 7 pcs  
T10, T15, T20, T25, T30, T40, 1/4 - 50mm



**59S/7-4**

7	22 x 65 x 75 mm	1 59S/7-4

59S/T10, 59S/T15, 59S/T20, 59S/T25, 59S/T30, 59S/T40		
--	--	--

Jeu d'embouts standard et porte-embouts - 7 pcs  
PH, PH2, 2xT15, 2xT20, T25, 1/4 50mm



**59S/7-2**

7	22 x 65 x 75 mm	1 59S/7-2

59S/PH2		
2x 59S/T15, 2x 59S/T20, 59S/T25		

Coffret d'embouts 11 pièces : 10 embouts, 1 porte embouts magnétique



**59S/TCS11-1**

11	108 x 68 x 31 mm	10 59S/TCS11-1

59S/T10CS, 59S/T15CS, 3x 59S/T20CS, 2x 59S/T25CS, 2x 59S/T30CS, 59S/T40CS		
KM653-QR-1P		

Jeu d'embouts standard et porte-embouts - 7 pcs  
TR10, TR15, TR20, TR25, TR30, TR40, 1/4 - 50mm



**59S/7-3**

7	22 x 65 x 75 mm	1 59S/7-3

59S/TR10, 59S/TR15, 59S/TR20, 59S/TR25, 59S/TR30, 59S/TR40		
--	--	--

Coffret d'embouts pour vis Phillips, Pozidriv, TORX®



**59S/10BC**

10	23 x 68 x 168 mm	1 59S/10BC



Coffret d'embouts 35 pièces : 29 embouts, 4 tourne-écrous magnétiques, 1 porte embouts magnétique et 1 douille adaptateur



### 59/S35BC

35	50 x 110 x 180 mm	1 59/S35BC



Jeu d'embouts standard et porte-embouts - 17 pcs PH1, 3xPH2, 2xPH2G, PZ1, 2xPZ2, HEX 3.0, 4.0, 5.0, 6.0, vis à fente 3.0, 4.5, 5.5, 1/4 - 50mm



### 59S/17-1

17	27 x 73 x 82 mm	1 59S/17-1



59S/0.5-3.0, 59S/0.6-4.5, 59S/0.8-5.5	
59S/PH1, 3x 59S/PH2	
2x 59S/PH2G	
59S/PZ1, 2x 59S/PZ2	
59S/H3, 59S/H4, 59S/H5, 59S/H6	

Jeu d'embouts standard et porte-embouts - 17 pcs



### 59S/17-2

17	27 x 73 x 82 mm	1 59S/17-2



59S/T7, 59S/T8, 59S/T9, 59S/T10, 2x 59S/T15, 3x 59S/T20, 3x 59S/T25, 59S/T27, 2x 59S/T30, 59S/T40



Jeu d'embouts standard et porte-embouts - 17 pcs PH1, PH2, PZ1, PZ2, PZ3, T10, T15, T20, T25, T27, T30, T40, vis 6 pans 3.0, 4.0, 5.0, 1/4 - 50mm



### 59S/17-3

17	27 x 73 x 82 mm	1 59S/17-3



59S/PH1, 2x 59S/PH2	
59S/PZ1, 59S/PZ2, 59S/PZ3	
59S/T10, 59S/T15, 59S/T20, 59S/T25, 59S/T27, 59S/T30, 59S/T40	
59S/H3, 59S/H4, 59S/H5	

Jeu d'embouts standard, porte-embouts et adaptateur douille 1/4" - 22 pcs



### 59S/22-1

22	20 x 50 x 80 mm	12 59S/22-1



59S/0.5-3.0, 59S/0.6-4.5, 59S/0.8-5.5	
59S/PH1, 59S/PH2, 59S/PH3	
59S/PH2G	
59S/PZ1, 59S/PZ2, 59S/PZ3	
59S/T6, 59S/T8, 59S/T9, 59S/T10, 59S/T15, 59S/T20, 59S/T25, 59S/T27, 59S/T30, 59S/T40	
K6650-1/4	

Jeu d'embouts standard, porte-embouts et adaptateur douille 1/4" - 22 pcs



### 59S/22-2

22	20 x 50 x 80 mm	12 59S/22-2



3x 59S/PH2	
3x 59S/PH2G	
2x 59S/PZ2	
59S/T10, 4x 59S/T15, 3x 59S/T20, 2x 59S/T25	
59S/H2.5, 59S/H3	
K6650-1/4	

Jeu d'embouts standard, porte-embouts et adaptateur douille 1/4" - 28 pcs. 4.5-6.5-8, PH 1-2-3, T6-15, TS 2x4, 2x6, 2x8, 2x10, 5/64, 3/32, 7/64, 1/18, 9/64, 5/32, 3/16, 7/32



### 59S/28

28	30 x 58 x 110 mm	1 59S/28-4



59S/0.6-4.5, 59S/1.2-6.5, 59S/1.2-8.0	
2x 59S/PH1, 2x 59S/PH2, 59S/PH3	
59S/T6, 59S/T15	
59S/H5/64, 59S/H3/32, 59S/H7/64, 59S/H1/8, 59S/H9/64, 59S/H5/32, 59S/H3/16, 59S/H7/32	
2x 59S/TS-4, 2x 59S/TS-6, 2x 59S/TS-8, 2x 59S/TS-10	
K6625-1/4	
KM653	



Jeu de 31 embouts pour vis à fente, Phillips®, Pozidriv®, TORX®, 6 pans, porte-embouts et adaptateur 1/4"



### 59/S31B

31	40,25 x 104,90 x 65,35 mm 280 x 375 x 210 mm	6	59/S31B 12 59/S31B-IP

59S/0.6-4.5, 59S/1.0-5.5		
59S/PH1, 3x 59S/PH2, 59S/PH3		
2x 59S/PH2G		
59S/PZ1, 3x 59S/PZ2, 59S/PZ3		
59S/T10, 3x 59S/T15, 3x 59S/T20, 2x 59S/T25, 59S/T27, 59S/T30		
59S/H3, 59S/H4, 59S/H5, 59S/H6		
K6625-1/4-1P		
KM653-QR-1P		

Jeu d'embouts standard et porte-embouts - 28 pcs  
3-4, 5-5.5, PH 1-2-3, PZ 1-2-3, T1-15-20-25-27-30, H 3-4-5-6, KM653-SR



### 59S/31-1

31	42 x 65 x 110 mm	12	59S/31-1

59S/0.5-3.0, 59S/0.6-4.5, 59S/0.8-5.5		
59S/PH1, 3x 59S/PH2, 59S/PH3		
2x 59S/PH2G		
59S/PZ1, 3x 59S/PZ2, 59S/PZ3		
59S/T10, 3x 59S/T15, 3x 59S/T20, 2x 59S/T25, 59S/T27, 59S/T30		
59S/H3, 59S/H4, 59S/H5, 59S/H6		
KM653-QR		

Jeu d'embouts standard et porte-embouts - 28 pcs  
4xPH2, 4xPH2G, 4xPZ2,  
2xT10, 4xT15, 5xT20, 5xT25, 2XT30, 1/4 - 60mm



### 59S/31-2

31	42 x 65 x 110 mm	1	59S/31-2

4x 59S/PH2		
4x 59S/PH2G		
4x 59S/PZ2		
2x 59S/T10, 4x 59S/T15, 5x 59S/T20, 5x 59S/T25, 2x 59S/T30		
KM653-QR		

Jeu d'embouts standard et porte-embouts - 28 pcs



### 59S/31-3

31	42 x 65 x 110 mm	12	59S/31-3

2x 59S/PH1, 2x 59S/PH2, 59S/PH3		
2x 59S/PZ1, 2x 59S/PZ2, 59S/PZ3		
2x 59S/TR10, 3x 59S/TR15, 5x 59S/TR20, 4x 59S/TR25, 59S/TR27, 4x 59S/TR30, 59S/TR40		
KM653-QR		

Jeu de 54 embouts standard, porte-embouts et adaptateur douille 1/4" - 54 pcs



### 59/S54BC

54	50 x 110 x 184 mm	10	59/S54BC

Les embouts TORX® sont colorés pour identifier facilement la taille

Jeu d'embouts standard, porte-embouts et adaptateur douille 1/4" - 54 pcs



### 59/S54BC-IP

54	300 x 190 x 280 mm	8	59/S54BC-IP

Les embouts TORX® sont colorés pour identifier facilement la taille



Jeu de 100 embouts pour vis à fente, Phillips®, Pozidriv®, 6 pans, Robertson, TORX® color et TORX® Tamper



### 59/S100BC

X	mm		
100	50 x 110 x 184 mm	1	59/S100BC
100	300 x 190 x 280 mm	8	59/S100BC-IP

Les embouts TORX® sont colorés pour identifier facilement la taille

Jeu d'embouts standard, porte-embouts, douilles 1/4" et cliquet - 26 pcs



### 2058/S26

X	mm		
26	80 x 100 x 35 mm	30	2058/S26
26	35 x 85 x 105 mm	1	SB-2058/S26

SB : Conditionnement détail sur carte plastique

K6625-1/4-1P		
59S/H6, 59S/H5, 59S/H4, 59S/H3		
59S/T15, 59S/T10, 59S/T30, 59S/T25, 59S/T20		
59S/PZ3, 59S/PZ1, 59S/PZ2		
59S/PH1, 59S/PH2, 59S/PH3		
59S/0.8-5.5, 59S/0.5-4.0		
6700SM-8, 6700SM-7, 6700SM-6, 6700SM-13, 6700SM-10		
KM753-QR-1P		

Visseuse à chocs 5/16"



### 5521

L		
125		1 5521

Embouts standard 5/16" à fente - 41 mm



### 70S/

X	mm		
5	8.0	1	70S/1.2-8.0
2	8.0	25	70S/1.2-8.0-2P
5	9.0	1	70S/1.6-9.0
2	9.0	25	70S/1.6-9.0-2P
5	10.0	1	70S/1.6-10.0
2	10.0	25	70S/1.6-10.0-2P
5	12.0	1	70S/2.0-12.0
2	12.0	25	70S/2.0-12.0-2P
5	14.0	1	70S/2.5-14.0
2	14.0	25	70S/2.5-14.0-2P

Embouts standard Phillips 5/16" - 32 à 38 mm



### 70S/PH

X			
5	1	1	70S/PH1
2	1	25	70S/PH1-2P
5	2	1	70S/PH2
2	2	25	70S/PH2-2P
5	3	1	70S/PH3
2	3	25	70S/PH3-2P
5	4	1	70S/PH4
2	4	25	70S/PH4-2P

Embouts standard 5/16" Pozidriv - 32 à 38 mm



### 70S/PZ

X			
5	1	1	70S/PZ1
2	1	25	70S/PZ1-2P
5	2	1	70S/PZ2
2	2	25	70S/PZ2-2P
5	3	1	70S/PZ3
2	3	25	70S/PZ3-2P
5	4	1	70S/PZ4
2	4	25	70S/PZ4-2P

Embouts standard 5/16" Torx® - 35 mm



### 70S/T

X			
5	T20	1	70S/T20
2	T20	25	70S/T20-2P
5	T25	1	70S/T25
2	T25	25	70S/T25-2P
5	T27	1	70S/T27
2	T27	1	70S/T27-2P
5	T30	1	70S/T30
2	T30	25	70S/T30-2P
5	T40	1	70S/T40
2	T40	25	70S/T40-2P
5	T45	1	70S/T45
2	T45	25	70S/T45-2P
5	T50	1	70S/T50
2	T50	25	70S/T50-2P
5	T55	1	70S/T55
2	T55	25	70S/T55-2P

Embouts standard 5/16" Torq-Set® métrique et impérial - 32 mm



**70S/TS**

5	8 mm	1 70S/TS8
2	8 mm	25 70S/TS8-2P
5	10 mm	1 70S/TS10
2	10 mm	25 70S/TS10-2P

Embouts à choc Torq-Set® en pouces - longueur 32 mm



**70S/TS"**

5	1/4"	1 70S/TS1/4
2	1/4"	25 70S/TS1/4-2P
5	5/16"	1 70S/TS5/16
2	5/16"	25 70S/TS5/16-2P

Embouts standard 5/16" 6 pans métrique - 30 mm



**70S/H**

5	4	1 70S/H4
2	4	25 70S/H4-2P
5	5	1 70S/H5
2	5	25 70S/H5-2P
5	6	1 70S/H6
2	6	25 70S/H6-2P
5	7	1 70S/H7
2	7	25 70S/H7-2P
5	8	1 70S/H8

2	8	25	70S/H8-2P
5	10	1	70S/H10
2	10	25	70S/H10-2P
5	12	1	70S/H12
2	12	25	70S/H12-2P
5	14	1	70S/H14
2	14	25	70S/H14-2P

Embouts standard 6 pans - 35 mm



**74S/H**

5	4	1	74S/H4
2	4	25	74S/H4-2P
5	5	1	74S/H5
2	5	25	74S/H5-2P
5	6	1	74S/H6
2	6	25	74S/H6-2P
5	7	1	74S/H7
2	7	25	74S/H7-2P
5	8	1	74S/H8
2	8	25	74S/H8-2P
5	10	1	74S/H10
2	10	25	74S/H10-2P
5	12	1	74S/H12
2	12	25	74S/H12-2P
5	14	1	74S/H14
2	14	1	74S/H14-2P
5	17	1	74S/H17
2	17	25	74S/H17-2P

Jeu visseuse à chocs 1/2" - 23 pcs



**7823**

23	45 x 70 x 197 mm	16	7823

**5521**

<b>54640</b>	
70S/1.2-8.0, 70S/1.6-10.0, 70S/2.0-12.0	
70S/PH2, 70S/PH3, 70S/PH4	
70S/T20, 70S/T25, 70S/T27, 70S/T30, 70S/T40, 70S/T45, 70S/T50, 70S/T55	
70S/H4, 70S/H5, 70S/H6, 70S/H7, 70S/H8, 70S/H10, 70S/H12, 70S/H14	

Jeu visseuse à chocs 1/2" - 15 pcs



**7865**

15	55 x 90 x 220 mm	1 7865

**5521**

<b>54640</b>	
70S/1.2-8.0, 70S/1.6-10.0	
70S/PH1, 70S/PH2, 70S/PH3, 70S/PH4	
70S/H4, 70S/H5, 70S/H6, 70S/H8	

Embouts standard Phillips à visser - 44,5 mm



**K18**

1	2	5	K18NF-2
1	2	5	K18PH-2M5
1	2	5	K18PH-2M6



Embouts standard Pozidriv à visser - 44,5 mm

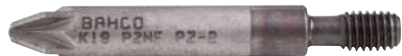

**K19PZD-2NF**

1	2	1	K19PZD-2NF
1	2	1	K19PZD-2M5

Embouts standard Torx® à visser - 44,5 mm



**K20TORX**

1	T25	10	K20TORX-T25

Embout douille à choc emmanchée - 50 mm



**K6750**

1	1/4"	1	K6750-6
1	1/4"	1	K6750-7
1	1/4"	1	K6750-8
1	1/4"	1	K6750-10
1	1/4"	1	K6750-13
1	1/4"	1	K6750-1/4
1	1/4"	1	K6750-3/8

Embout douille à choc emmanchée magnétique



**KM6750**

1		1	KM6750-6
1		1	KM6750-7
1		1	KM6750-8
1		20	KM6750-10
1		1	KM6750-11
1		1	KM6750-13
1		1	KM6750-1/4
1		1	KM6750-3/8

Porte-embouts magnétique avec système de déverrouillage rapide. Boîte de 5 pièces et le modèle KM653-QR-1P par unité sur support plastique



**KM653-QR**

5	1/4"	1	KM653-QR
1	1/4"	50	KM653-QR-1P

Porte-embout magnétique 1/4" avec bague de verrouillage, 75mm  
Par unité sur support plastique



**KM753-QR**

1	1/4"	1	KM753-QR-1P
1	1/4" mm	50	KMT753-QR-1P

Embout et support de vis universel magnétiques 1/4" - 82 mm  
Par unité sur support plastique



**KM100-SH**

1	1/4"	1	KM100-SH

Support universel pour embouts avec anneau de retenue 1/4" - 60 mm  
Boîte plastique de 5 pièces



**KR653**

1	1/4"	25	KR653-1P
5	1/4"	1	KR653

Support universel pour embouts avec anneau de retenue 1/4" - 60 mm, magnétique. Boîte plastique de 5 pièces et le modèle KM653-1P par unité sur support plastique



**KM653**

1	1/4"	25	KM653-1P
5	1/4"	1	KM653

Support universel pour embouts avec fonction pivotante 1/4" - 60 mm  
Par unité sur support plastique



**KM653-SF**

1	1/4"	1	KM653-SF

Support universel pour embouts de tournevis magnétique avec anneau de retenue 1/4" - 60 mm. Boîte de 5 pièces et le modèle KMR653-1P par unité sur support plastique



**KMR653**

1	1/4"	1	KMR653-1P
5	1/4"	1	KMR653

Adaptateur universel magnétique 1/4" avec bague de verrouillage 75mm. Boîte de 5 pièces et le modèle KMR753-1P par unité sur support plastique



**KMR753**

1	1/4"	1	KMR753-1P
5	1/4"	20	KMR753

Support universel pour embouts magnétique 1/4" - 70 mm  
Dans une boîte plastique (1 pièce)



**KM1/4-5/16-1P**

1	1/4"	50	KM1/4-5/16-1P

Support universel pour embouts en cuivre et béryllium avec anneau de retenue 1/4" - 75 mm  
Support plastique d'une unité



**KCB753**

1	1/4"	1	KCB753

Support universel pour embouts magnétique 1/4" - 150 mm. Boîte plastique de 5 pièces et le modèle KMR150-1P par unité sur support plastique



**KMR150**

1	1/4"	1	KMR150-1P
5	1/4"	1	KMR150

Adaptateur douille 6 pans 1/4" pour carré 1/4" - 25 mm  
Boîte plastique de 5 pièces



**K6625**

1	1/4"	1	K6625-1/4-1P
5	1/4"	1	K6625-1/4

Adaptateur douille 6 pans 1/4" pour carré 3/8" - 38 mm  
Boîte plastique de 5 pièces



**K6638**

1	1/4"	25	K6638-3/8-1P
5	1/4"	1	K6638-3/8

Adaptateur douille 6 pans 1/4" pour carré 1/4" ou 3/8" - 50 mm



**K6650**

1	1/4"	1	K6650-1/4-1P
5	1/4"	1	K6650-1/4
1	1/4"	1	K6650-3/8-1P
5	1/4"	1	K6650-3/8
1	1/4"	1	K6650-1/2-1P
5	1/4"	1	K6650-1/2



Adaptateur douille 6 pans 1/4" pour carré 1/4" ou 3/8"  
- 100 mm  
Boîte plastique de 5 pièces



### K66100

1	1/4"	25	K66100-1/4-1P
5	1/4"	1	K66100-1/4
1	1/4"	25	K66100-3/8-1P
5	1/4"	1	K66100-3/8

Adaptateur douille 6 pans 1/4" pour carré 1/4" - 60 mm  
Support plastique d'un adaptateur



### K6660-QR

1	1/4"	1	K6660-QR-1P

Adaptateur d'embout 6 pans 1/4" pour carré 5/16" -  
40 mm



### 54640

40	1	54640



# Tournevis



**TOURNEVIS ERGO™ AVEC POIGNÉE EN CAOUTCHOUC RAINURÉE ET CODE COULEUR**

Tournevis Ergo™ à lame fraisée  
Pour vis à fente



**BE-8010 - BE-8252**

Ø	L	l	l <sub>1</sub>	Icon 1	Icon 2
2.0	60	17	103	5	BE-8002
2.5	60	17	103	5	BE-8010
2.5	75	17	103	5	BE-8210
3.0	60	17	103	5	BE-8020
3.0	75	17	103	5	BE-8020L
3.0	100	17	103	5	BE-8022
3.0	125	17	103	5	BE-8220
3.0	200	17	103	5	BE-8225
3.5	75	17	103	5	BE-8030
3.5	125	17	103	5	BE-8230
3.5	200	20	122	5	BE-8235
4.0	100	20	122	5	BE-8040
4.0	175	20	122	5	BE-8240
5.5	125	27	122	5	BE-8241
5.5	150	27	122	5	BE-8242
5.5	200	27	122	5	BE-8250L
6.0	150	36	122	5	BE-8251
6.5	150	36	122	5	BE-8252

Tournevis Ergo™ à lame forgée  
Pour vis à fente



**BE-8150 - BE-8258**

Ø	L	l	l <sub>1</sub>	Icon 1	Icon 2
5.5 mm	100	27	122	5	BE-8150
5.5 mm	150	27	122	5	BE-8250
6.5 mm	125	36	122	5	BE-8155
6.5 mm	150	36	122	5	BE-8255
8 mm	150	36	122	5	BE-8256
8 mm	175	36	122	5	BE-8257
10 mm	200	36	161	5	BE-8258

Tournevis Ergo™ à lame forgée  
Pour vis à fente, collet 6 pans



**BE-8158 - BE-8890**

Ø	L	l	l <sub>1</sub>	Icon 1	Icon 2
5.5	125	27	122	5	BE-8158
6.5	150	36	122	5	BE-8159
8	125	36	122	5	BE-8160
8	175	36	122	5	BE-8260
8	175	36	161	5	BE-8865
10	175	36	161	5	BE-8870
12	200	36	161	5	BE-8880
14	200	36	161	5	BE-8890

Tournevis Ergo™ à lame fraisée  
Pour vis à fente. Boule à lame courte



**BE-8330 - BE-8455**

Ø	L	l	l <sub>1</sub>	Icon 1	Icon 2
3.5	25	36	58	5	BE-8330
4.0	25	36	58	5	BE-8340
5.5	25	36	58	5	BE-8350
5.5	45	36	58	5	BE-8450
6.5	25	36	58	5	BE-8355
6.5	45	36	58	5	BE-8455
8.0	25	36	58	5	BE-8360







Tournevis Ergo™  
Pour vis Phillips®



**BE-8600 - BE-8624**

Ø	L	l	l <sub>1</sub>	Icon 1	Icon 2
PH 0	60	17	103	5	BE-8600
PH 0	100	17	103	5	BE-8605
PH 0	200	20	122	5	BE-8608
PH 1	75	27	122	5	BE-8610
PH 1	75	20	122	5	BE-8611









						
PH 1	* 200	27	122	5	BE-8610L	
PH 2	100	36	122	5	BE-8620	
PH 2	100	27	122	5	BE-8621	
PH 2	150	36	122	5	BE-8622	
PH 2	* 200	36	122	5	BE-8620L	
PH 3	150	36	122	5	BE-8623	
PH 4	200	36	161	5	BE-8624	

Tournevis Ergo™  
Pour vis Phillips®, collet 6 pans

ergo®



**BE-8628 - BE-8640**







						
PH 1	100	27	122	5	BE-8628	
PH 2	125	36	122	5	BE-8629	
PH 3	150	36	122	5	BE-8630	
PH 4	200	36	161	5	BE-8640	

Tournevis Ergo™  
Pour vis Phillips®, Boule à lame courte

ergo®



**BE-8601/BE-8602**







						
PH 1	25	36	58	5	BE-8601	
PH 2	25	36	58	5	BE-8602	

Tournevis Ergo™  
Pour vis Pozidriv®

ergo®



**BE-8800 - BE-8824**







						
PZ 0	60	17	103	5	BE-8800	
PZ 1	75	27	122	5	BE-8810	
PZ 1	75	20	122	5	BE-8811	
PZ 1	200	27	122	5	BE-8810L	
PZ 2	100	36	122	5	BE-8820	
PZ 2	100	27	122	5	BE-8821	
PZ 2	200	36	122	5	BE-8820L	
PZ 3	150	36	122	5	BE-8823	
PZ 4	200	36	161	5	BE-8824	

Tournevis Ergo™  
Pour vis Pozidriv®, collet 6 pans

ergo®



**BE-8828 - BE-8840**







						
PZ 1	100	27	122	5	BE-8828	
PZ 2	125	36	122	5	BE-8829	
PZ 3	150	36	122	5	BE-8830	
PZ 4	200	36	161	5	BE-8840	

Tournevis Ergo™  
Pour vis Pozidriv®, Boule à lame courte

ergo®



**BE-8801/BE-8802**

						
PZ 1	25	36	58	5	BE-8801	
PZ 2	25	36	58	5	BE-8802	



Tournevis Ergo™  
Pour vis TORX®



**BE-8904 - BE-8945**

T 4	75	17	103	5	BE-8904	
T 5	75	17	103	5	BE-8905	
T 6	75	17	103	5	BE-8906	
T 7	75	17	103	5	BE-8907	
T 8	75	17	103	5	BE-8908	
T 9	75	17	103	5	BE-8909	
T 10	75	20	122	5	BE-8910	
T 15	100	27	122	5	BE-8915	
T 20	100	27	122	5	BE-8920	
T 25	125	27	122	5	BE-8925	
T 27	125	27	122	5	BE-8927	
T30	150	36	122	5	BE-8930	
T40	150	36	161	5	BE-8940	
T45	150	36	161	5	BE-8945	

Tournevis Ergo™  
Pour vis TORX® Tamper Resistant



**BE-7907 - BE-7940**

TR 7	75	20	122	5	BE-7907	
TR 8	75	17	103	5	BE-7908	
TR 9	75	20	122	5	BE-7909	
TR 10	75	20	122	5	BE-7910	
TR 15	100	27	122	5	BE-7915	
TR 20	100	27	122	5	BE-7920	
TR 25	125	27	122	5	BE-7925	
TR 27	125	27	122	5	BE-7927	
TR 30	150	36	122	5	BE-7930	
TR 40	150	36	161	5	BE-7940	

Tournevis Ergo™ à tête sphérique  
Pour vis TORX®



**BE-7515 - BE-7540**

T 15	100	27	122	5	BE-7515	
T 20	100	27	122	5	BE-7520	
T 25	125	27	122	5	BE-7525	

T 27	125	27	122	5	BE-7527	
T 30	150	36	122	5	BE-7530	
T 40	150	36	122	5	BE-7540	

Tournevis Ergo™  
Pour vis TORX® Plus



**BE-7715 - BE-7740**

T 15	100	27	122	5	BE-7715	
T 20	100	27	122	5	BE-7720	
T 25	125	27	122	5	BE-7725	
T 27	125	27	122	5	BE-7727	
T 30	150	36	122	5	BE-7730	
T 40	150	36	122	5	BE-7740	

Tournevis Ergo™  
Pour vis 6 pans dimensions métriques



**BE-6902 - BE-6903**

2	75	17	103	5	BE-6902	
2.5	75	17	103	5	BE-6925	
3	75	20	122	5	BE-6903	

Tournevis Ergo™ à tête sphérique  
Pour vis 6 pans dimensions métriques



**BE-8702 - BE-8710**

1.5	60	20	122	5	BE-8715	
2	100	17	103	5	BE-8702	
2.5	100	17	103	5	BE-8725	
3	100	20	122	5	BE-8703	
4	100	27	122	5	BE-8704	
5	100	36	122	5	BE-8705	
6	125	36	122	5	BE-8706	

8	150	36	122	5	BE-8708	
10	150	36	161	5	BE-8710	

Tournevis Ergo™  
Pour vis 6 pans dimensions en pouces

ergo®



**BE-8700-7/64 - BE-8700-5/16**

7/64"	100	20	122	5	BE-8700-7/64	
5/32"	100	27	122	5	BE-8700-5/32	
3/16"	100	27	122	5	BE-8700-3/16	
7/32"	100	36	122	5	BE-8700-7/32	
1/4"	125	36	122	5	BE-8700-1/4	
3/8"	150	36	161	5	BE-8700-3/8	
5/16"	150	36	122	5	BE-8700-5/16	

Tournevis Ergo™  
Pour vis Robertson

ergo®



**BE-9001 - BE-9003**

# 1	80	27	122	5	BE-9001	
# 2	80	27	122	5	BE-9002	
# 3	100	27	122	5	BE-9003	

Tournevis Ergo™  
Pour vis TRI-WING®

ergo®



**BE-9100 - BE-9105**

0	80	20	122	5	BE-9100	
1	80	20	122	5	BE-9101	
2	80	27	122	5	BE-9102	

3	80	27	122	5	BE-9103	
4	100	27	122	5	BE-9104	
5	100	27	122	5	BE-9105	

Tournevis Ergo™  
Pour vis TORQ-SET®

ergo®



**BE-8080**

1	75	27	122	5	BE-8080-1	
2	75	27	122	5	BE-8080-2	
3	75	27	122	5	BE-8080-3	
4	75	27	122	5	BE-8080-4	
5	75	27	122	5	BE-8080-5	
6	75	27	122	5	BE-8080-6	
8	100	27	122	5	BE-8080-8	
10	100	27	122	5	BE-8080-10	

Poinçon manche Ergo™, pointe ronde

ergo®



**BE-8985**

6	100	27	122	5	BE-8985	

Poinçon manche Ergo™, pointe ronde  
Type boule. Pour le pré-poinçonnage et le perçage des trous

ergo®



**BE-8986**

6	36	50	58	5	BE-8986	



Fraise manche Ergo™, pointe carrée



**BE-8980**

6	100	27	122	5	BE-8980

Clé à douille emmanchée Ergo™  
alésage normal



**BE-6400M**

4	100	20	122	5	BE-6400M-4
5	100	20	122	5	BE-6400M-5
5.5	100	20	122	5	BE-6400M-5.5
7	100	20	122	5	BE-6400M-7

Clé à douille emmanchée Ergo™  
alésage profond



**BE-78**

3	125	20	122	5	BE-7803
3.5	125	20	122	5	BE-7835
4	125	20	122	5	BE-7804
4.5	125	20	122	5	BE-7845
5	125	20	122	5	BE-7805
5.5	125	20	122	5	BE-7855
6	125	20	122	5	BE-7806
7	125	27	122	5	BE-7807
8	125	27	122	5	BE-7808
9	125	36	122	5	BE-7809
10	125	36	122	5	BE-7810
11	125	36	122	5	BE-7811

12	125	36	122	5	BE-7812
13	125	36	161	5	BE-7813
14	125	36	161	5	BE-7814

Clé à douille emmanchée Ergo™, lame flexible



**BE-76**

6	150	27	122	5	BE-7606
7	150	27	122	5	BE-7607
8	150	27	122	5	BE-7608

Jeu de 5 tournevis Ergo™  
Pour vis TORX®



**BE-9885**

X	5	1
		BE-9885

BE-8910, BE-8930, BE-8915, BE-8920, BE-8925

Jeu de 6 tournevis Ergo™  
Pour vis à fente et Phillips®



**BE-9881**

X	6	1		
		BE-9881		

BE-8020, BE-8040		
BE-8150, BE-8155		
BE-8620, BE-8610		

Jeu de 6 tournevis Ergo™  
Pour vis à fente et Pozidriv®







ergo®



**BE-9882**



		1 BE-9882
6		

BE-8020, BE-8040		
BE-8155, BE-8150		
BE-8810, BE-8820		

Jeu de 6 tournevis Ergo™  
Pour vis à fente, Phillips® et Pozidriv®







ergo®



**BE-9884**



		1 BE-9884
6		

BE-8611, BE-8621		
BE-8040, BE-8241		
BE-8811, BE-8821		

Jeu de 6 tournevis Ergo™  
Pour vis à fente, Phillips®, Pozidriv®









ergo®



**BE-9886**



		1 BE-9886
6		

BE-8030		
BE-8150		
BE-8621, BE-8611		
BE-8821, BE-8811		

Jeu de 6 tournevis Ergo™  
Pour vis à fente, Phillips®, Pozidriv® et TORX®









ergo®



**BE-9871**



		1 BE-9871
6		

BE-8220S		
BE-8920, BE-8925		
BE-8820		
BE-8611, BE-8620		



Jeu de 13 tournevis Ergo™  
Pour vis à fente, Phillips®, Pozidriv® et TORX®

ergo®



**BE-9875**



13

1 BE-9875

BE-8040		
BE-8150, BE-8155		
BE-8621		
BE-8811, BE-8821		
BE-8910, BE-8915, BE-8920, BE-8925		
BE-8010S, BE-8230S		
BE-8811S		

Jeu de 15 tournevis Ergo™  
Pour vis à fente, Phillips®, Pozidriv® et TORX®

ergo®



**BE-9877**



15

1 BE-9877

BE-8030		
BE-8150		
BE-8611, BE-8621		
BE-8811, BE-8821		
BE-8910, BE-8915, BE-8920, BE-8925		
BE-8220S, BE-8040S, BE-8050S		
BE-8611S, BE-8621S		

Jeu de tournevis ERGO™ pour vis à fente, Phillips, Pozidriv,  
TORX® - 13 pcs

ergo®



**BE-9879**



13

1 BE-9879

BE-8010, BE-8040		
BE-8150		
BE-8611, BE-8621		
BE-8811, BE-8821		
BE-8910, BE-8915, BE-8920, BE-8925		
BE-8220SL		
BE-8620SL		

Tournevis Ergo™ porte-embouts 6 pans creux 1/4"

ergo®



**BE-8577**



1/4

118

36

122

5 BE-8577

Manche Ergo™ pour lames interchangeables  
Carré 1/4" femelle

ergo®



**BE-8575**



1/4"

122

1 BE-8575

Lame 6 pans 1/4" pour vis à fente, 100mm



**8020-2P - 8252-2P**



3.0	0.5	1	8020-2P
3.5	0.6	1	8030-2P
4.0	0.8	1	8040-2P
5.5	1.0	1	8242-2P
6.5	1.2	1	8252-2P

Lame 6 pans 1/4" pour vis Phillips®, 100mm



**8600-2P - 8630-2P**



0	1	8600-2P
1	1	8610-2P
2	1	8620-2P
3	1	8630-2P

Lame 6 pans 1/4" pour vis Pozidriv®, 100mm



**8800-2P - 8830-2P**



0	1	8800-2P
1	1	8810-2P
2	1	8820-2P
3	1	8830-2P

Lame 6 pans 1/4" pour vis TORX®, 100mm



**8910-2P - 8940-2P**



10	1	8910-2P
15	1	8915-2P
20	1	8920-2P
25	1	8925-2P
27	1	8927-2P
30	1	8930-2P
40	1	8940-2P

Lame 6 pans 1/4" à tête sphérique, pour vis 6 pans 100mm



**8703-2P - 8706-2P**



3	1	8703-2P
4	1	8704-2P
5	1	8705-2P
6	1	8706-2P

Lame 6 pans 1/4" pour vis à fente, 300mm



**8040L-2P - 8252L-2P**

0.8	4.0	1	8040L-2P
1.0	5.5	1	8242L-2P
1.2	6.5	1	8252L-2P



Lame 6 pans 1/4" pour vis Phillips®, 300mm



**8610L-2P - 8620L-2P**



1	1	8610L-2P
2	1	8620L-2P

Lame 6 pans 1/4" pour vis Pozidriv®, 300mm



**8810L-2P - 8820L-2P**



1	1	8810L-2P
2	1	8820L-2P

Lames 6 pans 1/4" pour vis TORX®, 300mm



**8915L-2P - 8930L-2P**



T15	1	8915L-2P
T20	1	8920L-2P
T25	1	8925L-2P
T27	1	8927L-2P
T30	1	8930L-2P

Lame 6 pans 1/4", pour vis Phillips®, 400mm



**8620XL-1P - 8630XL-1P**



2	1	8620XL-1P
3	1	8630XL-1P

Lame 6 pans 1/4" pour vis Pozidriv®, 400mm



**8820XL-1P - 8830XL-1P**



2	1	8820XL-1P
3	1	8830XL-1P

Lame 6 pans 1/4" pour vis Pozidriv®, 400mm



**8252XL-1P - 8256XL-1P**



1.2	6.5	1	8252XL-1P
-----	-----	---	-----------



Jeu comprenant 1 manche Ergo™ + 6 lames interchangeables  
Pour vis à fente, Phillips® et Pozidriv®

ergo®



**BE-8571**



7

85 x 85 x 210 mm

1 BE-8571

BE-8575



8242-2P, 8252-2P



8610-2P, 8620-2P



8810-2P, 8820-2P



Jeu comprenant 1 manche Ergo™ + 8 lames interchangeables  
Pour vis à fente, Phillips®, Pozidriv® et TORX®

ergo®



**BE-8572**



9

85 x 80 x 210 mm

1 BE-8572

BE-8575



8242-2P, 8252-2P



8610-2P, 8620-2P



8810-2P, 8820-2P



8910-2P, 8915-2P



Jeu comprenant 1 manche Ergo™ + 7 lames interchangeables  
Pour vis TORX®

ergo®



**BE-8573**



8

85 x 85 x 210 mm

1 BE-8573

BE-8575



8910-2P, 8915-2P, 8920-2P, 8925-2P, 8927-2P, 8930-2P, 8940-2P



Jeu comprenant 1 manche Ergo™ + 7 lames interchangeables  
Pour vis à fente, Phillips®, Pozidriv® et TORX®

ergo®



**BE-8574**



8

85 x 85 x 210 mm

1 BE-8574

BE-8575



8610-2P, 8620-2P



8040-2P



8820-2P



8920-2P, 8925-2P, 8930-2P



Jeu comprenant 1 manche ERGO™ + 22 éléments interchangeables: lames et embouts  
Pour vis à fente, Phillips®, Pozidriv®, TORX® et 6 pans

ergo®



**BE-8576**

23	1	BE-8576

BE-8575		
8030-2P, 8040-2P, 8242-2P, 8252-2P		
8810-2P, 8820-2P, 8830-2P		
8610-2P, 8620-2P, 8630-2P		
8910-2P, 8915-2P, 8925-2P, 8930-2P, 8940-2P		
59S/H2, 59S/H3, 59S/H5, 59S/H4, 59S/H6, 59S/H8		

**TOURNEVIS À LAME TRAVERSANTE**

Tournevis Ergo™ lame forgée traversante  
Pour vis à fente, 6 pans au collet

ergo®



**BE-8135TB - BE-8262TB**

Ø	L	l	l <sub>1</sub>	Q	Q <sub>1</sub>
3.5 mm	75 mm	27	122 mm	10	BE-8135TB
4.5 mm	100 mm	27	122 mm	10	BE-8145TB
5.5 mm	100 mm	27	122 mm	10	BE-8150TB
6.5 mm	125 mm	36	122 mm	5	BE-8155TB
8 mm	150 mm	36	122 mm	10	BE-8256TB
10 mm	175 mm	36	122 mm	10	BE-8258TB
12 mm	200 mm	36	122 mm	10	BE-8262TB
3.5 mm	75 mm	27	122 mm	1	SBE-8135TB
4.5 mm	100 mm	27	122 mm	1	SBE-8145TB
5.5 mm	100 mm	27	122 mm	1	SBE-8150TB
6.5 mm	125 mm	36	122 mm	1	SBE-8155TB

Tournevis Ergo™ lame traversante  
Pour vis Phillips®, 6 pans au collet

ergo®



**BE-8610TB - BE-8624TB**

Ø	L	l	l <sub>1</sub>	Q	Q <sub>1</sub>
PH 1	100 mm	27	122 mm	10	BE-8610TB
PH 2	125 mm	36	122 mm	10	BE-8620TB
PH 3	150 mm	36	122 mm	10	BE-8623TB
PH 4	175 mm	36	122 mm	10	BE-8624TB
PH 1	100 mm	27	122 mm	1	SBE-8610TB
PH 2	125 mm	36	122 mm	1	SBE-8620TB

Tournevis Ergo™ lame traversante  
Pour vis Pozidriv® et 6 pans au collet

ergo®



**BE-8810TB - BE-8824TB**

Ø	L	l	l <sub>1</sub>	Q	Q <sub>1</sub>
PZ 1	100 mm	27	122 mm	10	BE-8810TB
PZ 2	125 mm	36	122 mm	10	BE-8820TB
PZ 3	150 mm	36	122 mm	10	BE-8823TB
PZ 4	175 mm	36	122 mm	10	BE-8824TB
PZ 1	100 mm	27	122 mm	1	SBE-8810TB
PZ 2	125 mm	36	122 mm	1	SBE-8820TB

Tournevis Ergo™ lame traversante  
Pour vis TORX®, 6 pans au collet

ergo®



**BE-8910TB - BE-8940TB**

Ø	L	l	l <sub>1</sub>	Q	Q <sub>1</sub>
T 10	75 mm	27	122 mm	5	BE-8910TB
T 15	100 mm	27	122 mm	5	BE-8915TB
T 20	100 mm	27	122 mm	5	BE-8920TB
T 25	100 mm	27	122 mm	5	BE-8925TB
T 27	125 mm	27	122 mm	5	BE-8927TB
T 30	150 mm	36	122 mm	5	BE-8930TB
T 40	150 mm	36	122 mm	5	BE-8940TB
T 15	100 mm	27	122 mm	1	SBE-8915TB
T 20	100 mm	27	122 mm	1	SBE-8920TB



T 25	100 mm	27	122 mm	1	SBE-8925TB
T 30	150 mm	36	122 mm	1	SBE-8930TB
T 40	150 mm	36	122 mm	1	SBE-8940TB

Jeu de 6 tournevis Ergo™ lames traversantes  
Pour vis à fente et Pozidriv®, 6 pans au collet



### BE-9882TB



6 1 BE-9882TB

BE-8135TB, BE-8145TB, BE-8150TB, BE-8155TB



BE-8810TB, BE-8820TB



Jeu de 6 tournevis Ergo™ lames traversantes  
Pour vis à fente et Phillips®, 6 pans



### BE-9881TB



6 1 BE-9881TB

BE-8135TB, BE-8145TB, BE-8150TB, BE-8155TB



BE-8610TB, BE-8620TB

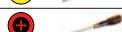

Jeu de 5 tournevis Ergo™ lame traversante  
Pour vis TORX®, 6 pans au collet



### BE-9885TB



5 1 BE-9885TB

BE-8915TB, BE-8920TB, BE-8925TB, BE-8930TB, BE-8940TB



## TOURNEVIS BAHCOFIT AVEC POIGNÉE EN CAOUTCHOUC RAINURÉ

Tournevis à lame forgée pour vis à fente



### B190



4 mm	75	24.5	95	10	B190.040.075
4 mm	100	24.5	95	10	B190.040.100
5.5 mm	100	30	105	10	B190.055.100
5.5 mm	125	30	105	10	B190.055.125
6.5 mm	125	34	117	10	B190.065.125
6.5 mm	150	34	117	10	B190.065.150
8 mm	150	34	117	10	B190.080.150
8 mm	175	34	117	10	B190.080.175
10 mm	200	34	117	10	B190.100.200
12 mm	250	34	117	10	B190.120.250
14 mm	250	34	117	10	B190.140.250
4 mm	75	24.5	95	1	SB190.040.075
4 mm	100	24.5	95	1	SB190.040.100
5.5 mm	100	30	105	1	SB190.055.100
5.5 mm	125	30	105	1	SB190.055.125
6.5 mm	125	34	117	1	SB190.065.125
6.5 mm	150	34	117	1	SB190.065.150
8 mm	150	34	117	1	SB190.080.150
8 mm	175	34	117	1	SB190.080.175
10 mm	200	34	117	1	SB190.100.200
12 mm	250	34	117	1	SB190.120.250
14 mm	250	34	117	1	SB190.140.250



## Tournevis à lame fraisée pour vis à fente



### B191

2.5 mm	75	24.5	95		10	B191.025.075
3 mm	75	24.5	95		10	B191.030.075
3 mm	100	24.5	95		10	B191.030.100
3 mm	200	24.5	95		10	B191.030.200
3.5 mm	100	24.5	95		10	B191.035.100
4 mm	100	24.5	95		10	B191.040.100
4 mm	125	24.5	95		10	B191.040.125
4 mm	250	24.5	95		10	B191.040.250
5.5 mm	125	30	105		10	B191.055.125
5.5 mm	150	30	105		10	B191.055.150
5.5 mm	300	30	105		10	B191.055.300
6.5 mm	150	34	117		10	B191.065.150
6.5 mm	300	34	117		10	B191.065.300
2.5 mm	75	24.5	95		1	SB191.025.075
3 mm	75	24.5	95		1	SB191.030.075
3 mm	100	24.5	95		1	SB191.030.100
3 mm	200	24.5	95		1	SB191.030.200
3.5 mm	100	24.5	95		1	SB191.035.100
4 mm	100	24.5	95		1	SB191.040.100
4 mm	125	24.5	95		1	SB191.040.125
4 mm	250	24.5	95		1	SB191.040.250
5.5 mm	125	30	105		1	SB191.055.125
5.5 mm	150	30	105		1	SB191.055.150
5.5 mm	300	30	105		1	SB191.055.300
6.5 mm	150	34	117		1	SB191.065.150
6.5 mm	300	34	117		1	SB191.065.300



## Tournevis pour vis Phillips®



### B192

PH0	75	24.5	95		10	B192.000.075
PH0	200	24.5	95		10	B192.000.200
PH1	100	30	105		10	B192.001.100
PH1	250	30	105		10	B192.001.250
PH2	125	34	117		10	B192.002.125
PH2	150 mm	34	117		10	B192.002.150
PH2	300	34	117		10	B192.002.300
PH3	150	34	117		10	B192.003.150
PH4	200	34	117		10	B192.004.200
PH0	75	24.5	95		1	SB192.000.075
PH0	200	24.5	95		1	SB192.000.200
PH1	100	30	105		1	SB192.001.100
PH1	250	30	105		1	SB192.001.250
PH2	125	34	117		1	SB192.002.125
PH2	300	34	117		1	SB192.002.300
PH3	150	34	117		1	SB192.003.150
PH4	200	34	117		1	SB192.004.200



## Tournevis boule pour vis à fente



### B195

4	25	33	60		10	B195.040.025
5.0	25	33	60		10	B195.050.025
6	25	33	60		10	B195.060.025
4	25	33	60		1	SB195.040.025
5	25	33	60		1	SB195.050.025
6	25	33	60		1	SB195.060.025



## Tournevis boule pour vis Phillips®



### B195PH

PH1	25	33	60		10	B195.001.025
PH2	25	33	60		10	B195.002.025
PH1	25	33	60		1	SB195.001.025
PH2	25	33	60		1	SB195.002.025



## Tournevis pour vis Pozidriv®



### B193

PZ0	75	24.5	95	10	B193.000.075
PZ1	100	30	105	10	B193.001.100
PZ2	125	34	117	10	B193.002.125
PZ3	150	34	117	10	B193.003.150
PZ4	200	34	117	10	B193.004.200
PZ0	75	24.5	95	1	SB193.000.075
PZ1	100	30	105	1	SB193.001.100
PZ2	125	34	117	1	SB193.002.125
PZ3	150	34	117	1	SB193.003.150
PZ4	200	34	117	1	SB193.004.200

## Tournevis boule pour vis Pozidriv®



### B195PZ

PZ1	25	33	60	10	B195.901.025
PZ2	25	33	60	10	B195.902.025
PZ1	25	33	60	1	SB195.901.025
PZ2	25	33	60	1	SB195.902.025

## Tournevis pour vis TORX®



### B194

T4	75	24.5	95	10	B194.004.075
T5	75	24.5	95	10	B194.005.075

T6	75	24.5	95	10	B194.006.075
T7	75	24.5	95	10	B194.007.075
T8	75	24.5	95	10	B194.008.075
T9	75	24.5	95	10	B194.009.075
T10	75	24.5	95	10	B194.010.075
T15	100	24.5	95	10	B194.015.100
T20	100	24.5	95	10	B194.020.100
T25	125	30	105	10	B194.025.125
T27	125	30	105	10	B194.027.125
T30	150	34	117	10	B194.030.150
T40	150	34	117	10	B194.040.150
T45	150	34	117	5	B194.045.150
T4	75	24.5	95	1	SB194.004.075
T5	75	24.5	95	1	SB194.005.075
T6	75	24.5	95	1	SB194.006.075
T7	75	24.5	95	1	SB194.007.075
T8	75	24.5	95	1	SB194.008.075
T9	75	24.5	95	1	SB194.009.075
T10	75	24.5	95	1	SB194.010.075
T15	100	24.5	95	1	SB194.015.100
T20	100	24.5	95	1	SB194.020.100
T25	125	30	105	1	SB194.025.125
T27	125	30	105	1	SB194.027.125
T30	150	34	117	1	SB194.030.150
T40	150	34	117	1	SB194.040.150
T45	150	34	117	1	SB194.045.150

## Tournevis pour vis TORX® Tamper resistant



### B141

TR7	75	24.5	5	B141.007.075
TR8	75	24.5	5	B141.008.075
TR9	75	24.5	5	B141.009.075
TR10	75	24.5	5	B141.010.075
TR15	100	24.5	5	B141.015.100
TR20	100	24.5	5	B141.020.100
TR25	125	30	5	B141.025.125
TR27	125	30	5	B141.027.125
TR30	150	34	5	B141.030.150
TR40	150	34	5	B141.040.150
TR7	75	24.5	1	SB141.007.075
TR8	75	24.5	1	SB141.008.075
TR9	75	24.5	1	SB141.009.075
TR10	75	24.5	1	SB141.010.075
TR15	100	24.5	1	SB141.015.100
TR20	100	24.5	1	SB141.020.100
TR25	125	30	1	SB141.025.125
TR27	125	30	1	SB141.027.125
TR30	150	34	1	SB141.030.150
TR40	150	34	1	SB141.040.150



## Tournevis à tête sphérique pour vis 6 pans



### B143

2	100	24.5	95	5	B143.020.100
2.5	100	24.5	95	10	B143.025.100
3	100	24.5	95	10	B143.030.100
4	100	24.5	95	10	B143.040.100
5	100	30	105	10	B143.050.100
6	125	34	117	10	B143.060.125
8	150	34	117	5	B143.080.150
2	100	24.5	95	1	SB143.020.100
2.5	100	24.5	95	1	SB143.025.100
3	100	24.5	95	1	SB143.030.100
4	100	24.5	95	1	SB143.040.100
5	100	30	105	1	SB143.050.100
6	125	34	117	1	SB143.060.125
8	150	34	117	1	SB143.080.150

## Tournevis pour vis Robertson (carré)



### B144

#1	100	24.5	95	5	B144.001.100
#2	125	30	105	5	B144.002.125
#3	150	34	117	5	B144.003.150
#1	100	24.5	95	1	SB144.001.100
#2	125	30	105	1	SB144.002.125
#3	150	34	117	1	SB144.003.150

## Poinçon pointe ronde



### B145

6	100	30	105	5	B145.006.100
6	100	30	105	1	SB145.006.100

## Fraise pointe carrée, alésoir



### B146

6	100	30	105	5	B146.006.100
6	100	30	105	1	SB146.006.100

## Poinçon boule pointe ronde Pour le pré-poinçonnage et le perçage des trous



### B195Awl

6	50	33	60	5	B195.006.050
6 mm	50	33	60	1	SB195.006.050

## Douille emmanchée



### B198

4	125	24.5	95	5	B198.040.125
4.5	125	24.5	95	5	B198.045.125
5	150	30	105	5	B198.050.150
5.5	150	30	105	5	B198.055.150
6	150	30	105	5	B198.060.150
6	150	34	117	5	B198.060.150F
7	150	34	117	5	B198.070.150
7	150	34	117	5	B198.070.150F
8	150	34	117	5	B198.080.150
8	150	34	117	5	B198.080.150F
9	150	34	117	5	B198.090.150
10	150	34	117	5	B198.100.150
11	150	34	117	5	B198.110.150

Ø	L	W	H	Q	Q
12	150	34	117	5	B198.120.150
13	150	34	117	5	B198.130.150
14	150	34	117	5	B198.140.150
4	125	24.5	95	1	SB198.040.125
4.5	125	24.5	95	1	SB198.045.125
5	150	30	105	1	SB198.050.150
5.5	150	30	105	1	SB198.055.150
6	150	30	105	1	SB198.060.150
6	150	34	117	1	SB198.060.150F
7	150	34	117	1	SB198.070.150
7	150	34	117	1	SB198.070.150F
8	150	34	117	1	SB198.080.150
8	150	34	117	1	SB198.080.150F
9	150	34	117	1	SB198.090.150
10	150	34	117	1	SB198.100.150
11	150	34	117	1	SB198.110.150
12	150	34	117	1	SB198.120.150
13	150	34	117	1	SB198.130.150
14	150	34	117	1	SB198.140.150

Jeu de 4 tournevis BahcoFit  
Pour vis à fente et Phillips®



**B219.004**

4		1 B219.004

B191.030.100, B191.055.125		
B192.001.100, B192.002.125		

Jeu de 2 tournevis BahcoFit  
Pour vis à fente et Phillips®



**B219.002**

2		1 B219.002

B191.040.100		
B192.001.100		

Jeu de 5 Tournevis BahcoFit  
Pour vis à fente et Phillips®



**B219.005**

5		1 B219.005

B191.030.075, B191.040.100		
B190.055.125		
B192.001.100, B192.002.125		

Jeu de 2 tournevis BahcoFit  
Pour vis à fente et Phillips®



**B219.012**

2		1 B219.012

B190.055.125		
B192.002.125		

Jeu de 5 tournevis BahcoFit  
Pour vis à fente et Pozidriv®



**B219.015**

5		1 B219.015

B191.030.075, B191.040.100		
B190.055.125		
B193.001.100, B193.002.125		



Jeu de 5 tournevis BahcoFit  
Pour vis TORX®



**B219.025**



5

1 B219.025

B194.010.075, B194.015.100, B194.020.100, B194.025.125,  
B194.030.150



Jeu de 5 tournevis BahcoFit  
Pour vis TORX® Tamper resistant



**B219.035**



5

1 B219.035

B141.010.075, B141.015.100, B141.020.100, B141.025.125,  
B141.030.150



Jeu de 6 tournevis BahcoFit  
Pour vis à fente et Phillips®



**B219.006**



6

1 B219.006

B191.030.075, B191.040.100



B190.055.125, B190.065.125



B192.001.100, B192.002.125



Jeu de 6 tournevis BahcoFit  
Pour vis à fente et Pozidriv®



**B219.016**



6

1 B219.016

B191.030.075, B191.040.100



B190.055.125, B190.065.125



B193.001.100, B193.002.125



Jeu de 6 tournevis BahcoFit  
Pour vis à fente, Phillips® et Pozidriv®



**B219.026**



6

1 B219.026

B191.030.075, B191.040.100



B192.001.100, B192.002.125



B193.001.100, B193.002.125



Jeu de 7 tournevis BahcoFit  
Pour vis Pozidriv® et TORX®



**B219.007**



7

1 B219.007

B193.001.100, B193.002.125



B194.010.075, B194.015.100, B194.020.100, B194.025.125,  
B194.030.150





Jeu de 7 tournevis BahcoFit  
Pour vis à fente et Phillips®



**B219.017**



7

1 B219.017

B191.035.100, B191.040.100



B190.055.125, B190.065.150, B190.080.150



B192.001.100, B192.002.125



Jeu de 7 tournevis BahcoFit  
Pour vis TORX®



**B219.027**

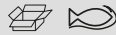

7

1 B219.027

B194.010.075, B194.015.100, B194.020.100, B194.025.125,  
B194.027.125, B194.030.150, B194.040.150



Jeu de tournevis BahcoFit™ pour vis à fente, Phillips, Pozidriv,  
TORX® - 10 pcs



**B219.110**



10

1 B219.110

B190.055.100



B192.002.125



B193.002.125



B194.010.075, B194.015.100, B194.020.100



B196.025.075, B196.080.175

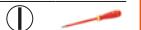

B142.001.080



806-1-1



Jeu de 8 tournevis BahcoFit  
Pour vis à fente et Phillips®



**B219.008**



8

1 B219.008

B191.040.100, B191.055.125



B190.065.150, B190.080.175



B192.001.100, B192.002.125



B195.060.025



B195.002.025



Jeu de tournevis BahcoFit™ pour vis TORX® - 10 pcs



**B219.210**



10

4,5 x 33 x 17 mm

1 B219.210

B194.006.075, B194.008.075, B194.009.075, B194.010.075,  
B194.015.100, B194.020.100, B194.025.125, B194.027.125,  
B194.030.150, B194.040.150



Jeu de 10 tournevis BahcoFit  
Pour vis à fente, Phillips®, Pozidriv® et Robertson



**B219.010**



10



1 B219.010

B191.030.075		
B190.055.100, B190.065.125, B190.080.150		
B192.001.100, B192.002.125, B192.003.150		
B195.902.025		
B144.001.100, B144.002.125		

**TOURNEVIS AVEC POIGNÉE EN CAOUTCHOUC**

Tournevis à lame forgée série 600 pour vis à fente



**611**



Ø	L	l	l	Q	Q
3.5	75	25	80	10	611-3.5-75
3.5	100	25	80	10	611-3.5-100
4.0 mm	75 mm	25	80 mm	10	611-4-75
4.0	100	25	80	10	611-4-100
5.5	100	30	97	10	611-5.5-100
5.5	125	30	97	10	611-5.5-125
6.5	25	35	60	10	611-6.5-25
6.5	125	35	110	10	611-6.5-125
6.5	150	35	110	10	611-6.5-150
8.0	150	35	110	10	611-8-150
8.0	175	35	110	10	611-8-175
10.0	200	35	110	10	611-10-200

Tournevis à lame fraisée série 600 pour vis à fente



**613**



Ø	L	l	l	Q	Q
3.0	75	25	80	10	613-3-75
3.0	100	25	80	10	613-3-100
3.5	100	25	80	10	613-3.5-100
4.0	100	25	80	10	613-4-100
4.0	125	25	80	10	613-4-125
5.5	150	30	97	10	613-5.5-150
6.5	150	35	110	10	613-6.5-150

Tournevis série 600 pour vis Phillips®



**615**



Ø	L	l	l	Q	Q
PH 0	75	25	80	10	615-0-75
PH 1	100	30	97	10	615-1-100
PH 2	25	35	60	10	615-2-25
PH 2	125	35	110	10	615-2-125
PH 3	150	35	110	10	615-3-150

Tournevis série 600 pour vis Pozidriv®



**616**



Ø	L	l	l	Q	Q
PZ 0	75	25	80	10	616-0-75
PZ 1	100	30	97	10	616-1-100
PZ 2	125	35	110	10	616-2-125
PZ 3	150	35	110	10	616-3-150

Tournevis série 600 pour vis TORX®



**618**

T 10	75	25	80	10	618-10-75	
T 15	100	25	80	10	618-15-100	
T 20	100	25	80	10	618-20-100	
T 25	125	30	97	10	618-25-125	
T 27	125	30	97	10	618-27-125	
T 30	150	35	110	10	618-30-150	
T 40	150	35	110	10	618-40-150	

Jeu de 3 tournevis série 600  
Pour vis à fente 3, 5.5 et Phillips® PH1



**600-3**

3			1	600-3

613-3-100		
611-5.5-125		
615-1-100		

Jeu de 4 tournevis série 600  
Pour vis à fente 3, 5.5 et Phillips® PH1 et PH2



**602-4-LA**

4			1	602-4-LA

613-3-100		
611-5.5-100		
615-1-100, 615-2-125		

Jeu de 5 tournevis série 600  
Pour vis à fente 3, 4, 6.5 et Phillips® PH1 et PH2



**604-5**

5			1	604-5

613-3-100		
611-4-100, 611-6.5-125		
615-1-100, 615-2-125		

Jeu de 5 tournevis série 600  
Pour vis TORX® T10, T15, T20, T25, T30



**612-5**

5			1	612-5

618-10-75, 618-15-100, 618-20-100, 618-25-125, 618-30-150		
---	--	--



Jeu de 6 tournevis série 600  
 Pour vis à fente 3, 4, Phillips® PH1, PH2, et Pozidriv® PZ1, PZ2



**605-6**



6

1 605-6

613-3-75, 613-4-100



615-1-100, 615-2-125



616-1-100, 616-2-125



Jeu de 6 tournevis série 600  
 Pour vis à fente 3, 4, 5.5, 6.5, et Pozidriv® PZ1, PZ2



**610-6**



6

1 610-6

611-5.5-100, 611-6.5-125



613-3-75, 613-4-100



616-1-100, 616-2-125



Jeu de 6 tournevis série 600  
 Pour vis à fente 3, 4, 5.5, 6.5 et Phillips® PH1 et PH2



**606-6**



6

1 606-6

611-5.5-100, 611-6.5-125



613-3-75, 613-4-100



615-1-100, 615-2-125



Jeu de 6 tournevis série 600  
 Pour vis à fente 3 à 6.5 et Phillips® PH1 et PH2



**620-6**



6

1 620-6

623-4-100, 623-3-100, 623-5.5-125, 623-6.5-150



625-1-150, 625-2-175



Jeu de 6 tournevis série 600  
 Pour vis à fente 3, 4, Phillips® PH1 et PH2 et Pozidriv® PZ1 et PZ2



**605-6-PC**



6

1 605-6-PC

613-3-75, 613-4-100



615-1-100, 615-2-125



616-1-100, 616-2-125



Jeu de 10 tournevis série 600  
 Pour vis à fente, Phillips® et Robertson



**605-10-PC-AU**



10

1 605-10-PC-AU

611-5.5-100, 611-6.5-125, 611-8-150



613-3-75



615-1-100, 615-2-125, 615-3-150

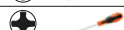

**TOURNEVIS À CLIQUET**

Tournevis à cliquet



**808050**



Tournevis à cliquet porte embout 1/4" et jeu d'embouts, 36 pcs



**59/S36BCR**



36

6 59/S36BCR

Tournevis à cliquet à leds



**808050L**



1/4

135

41.6

135 mm

25 808050L

1 808050L-SP1



Tournevis porte-embout à cliquet poignée revolver



**808050P**

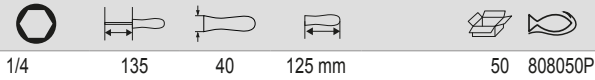

Tournevis porte-embouts à cliquet poignée revolver  
Coffret 25 pièces



**808050P-**



Tournevis court porte-embout à cliquet  
Manche en T



**808050TS**

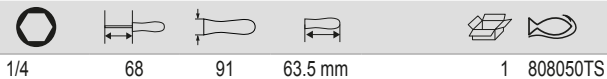

Tournevis porte-embout court à cliquet 1/4"



**808050S**



Coffret tournevis porte-embouts à cliquet manche boule +  
embouts 1/4" - 18 pces avec accessoires



**808050S-18**



Coffret tournevis porte-embouts à cliquet manche boule +  
embouts 1/4" - 22 pces avec accessoires



**808050S-22**



## TOURNEVIS AVEC POIGNÉE DE PRÉCISION

### Tournevis de précision plat



#### 700

1	50	14	87		5	700-1-50
1.2	50	14	87		5	700-1.2-50
1.5	50	14	87		5	700-1.5-50
1.8	50	14	87		5	700-1.8-50
2	50	14	87		5	700-2-50
2.5	50	14	87		5	700-2.5-50
3	50	14	87		5	700-3-50
3	100	14	87		5	700-3-100
3	200	14	87		5	700-3-200
3.5	75	14	87		5	700-3.5-75
4	75	14	87		5	700-4-75
4	250	14	87		5	700-4-250

### Tournevis pour vis Phillips



#### 701

PH 00	50	14	87		5	701-00-50
PH 0	50	14	87		5	701-0-50
PH 0	200	14	87		5	701-0-200
PH 1	75	14	87		5	701-1-75
PH 1	250	14	87		5	701-1-250

### Tournevis de précision Pozidriv



#### 702

PZ 0	50	14	87		5	702-0-50
PZ 1	75	14	87		5	702-1-75

### Tournevis de précision Torx



#### 703

T 4	50	14	87		5	703-4-50
T 5	50	14	87		5	703-5-50
T 6	50	14	87		5	703-6-50
T 7	50	14	87		5	703-7-50
T 8	50	14	87		5	703-8-50
T 9	50	14	87		5	703-9-50
T 10	50	14	87		5	703-10-50
T 15	75	14	87		5	703-15-75
T 20	75	14	87		5	703-20-75

### Tournevis de précision à tête sphérique 6 pans



#### 704

1.5	50	14	87		5	704-1.5-50
2	50	14	87		5	704-2-50
2.5	50	14	87		5	704-2.5-50
3	75	14	87		5	704-3-75
3/32	75	14	87		5	704Z-3/32

### Jeu de 6 tournevis de précision



#### 706-1

6						1 706-1

700-2-50, 700-2.5-50, 700-1.5-50, 700-3-50

701-0-50, 701-1-75



Jeu de 6 tournevis de précision



**706-2**



6

1 706-2

700-1.5-50, 700-1.2-50, 700-1-50, 700-1.8-50



701-00-50, 701-0-50



Jeu de 6 tournevis de précision



**706-3**



6

1 706-3

700-2.5-50, 700-2-50, 700-1.8-50, 700-1.5-50, 700-1.2-50, 700-1-50



Jeu de 7 tournevis de précision



**706-4**



7

1 706-4

700-2.5-50, 700-3.5-75, 700-1.5-50



701-1-75, 701-0-50



703-8-50, 703-6-50



Jeu de 24 tournevis, vis à tête fendue hexagonale  
PHILLIPS, POZIDRIV, TORX



**706-5**



24

1 706-5

700-3-50, 700-2-50, 700-3.5-75, 700-4-75, 700-1.5-50, 700-1.2-50,  
700-1-50, 700-1.8-50



701-00-50, 701-0-50, 701-1-75



702-1-75, 702-0-50



703-6-50, 703-9-50, 703-10-50, 703-7-50, 703-8-50, 703-15-75, 703-  
20-75



704-2.5-50, 704-3-75, 704-1.5-50, 704-2-50



Tournevis de précision, 4 lames



**510034**



0.25x1.5, 0.3x2, 0.4x2.5, 0.5x3

8.5

10 510034



## Tournevis porte-vis, pour vis à fente



**2784**



Tip Size	Length	Width	Weight	Part No.
2.5	6	100	1	2784-2.5
3.5	6	104	1	2784-3.5
4.5	10	110	1	2784-4.5

## Jeu de tournevis de précision



**98505/510031/510033**

Tip Size	Length	Weight	Part No.
5			5 98505
6			5 510031
3			5 510033

## TOURNEVIS AVEC POIGNÉE DE MANCHE EN T

Tournevis Hexagonal manche en T  
6 pans/900T



**900T**



Tip Size	Length	Width	Weight	Part No.
2	100	50	85	5 900T-020-100
2.5	100	50	85	5 900T-025-100
3	100	50	85	5 900T-030-100

Tip Size	Length	Width	Weight	Part No.
4	138	50	85	5 900T-040-150
5	138	60	105	5 900T-050-150
6	185	60	105	5 900T-060-200
8	185	60	105	5 900T-080-200
10	185	60	105	5 900T-100-200

## Tournevis TORX® manche en T



**901T**



Tip Size	Length	Width	Weight	Part No.
T 6	100	50	85	5 901T-006-100
T 7	100	50	85	5 901T-007-100
T 8	100	50	85	5 901T-008-100
T 9	100	50	85	5 901T-009-100
T 10	100	50	85	5 901T-010-100
T 15	138	50	85	5 901T-015-150
T 20	138	50	85	5 901T-020-150
T 25	138	60	105	5 901T-025-150
T 27	138	60	105	5 901T-027-150
T 30	185	60	105	5 901T-030-200
T 40	185	60	105	5 901T-040-200
T 45	185	60	105	5 901T-045-200
T 50	185	60	105	5 901T-050-200

## Tournevis à douille emmanchée manche en T



**902T**



Tip Size	Length	Width	Weight	Part No.
5	136	50	85	5 902T-050-150
5.5	136	50	85	5 902T-055-150
6	136	50	85	5 902T-060-150
7	160	60	105	5 902T-070-175
8	160	60	105	5 902T-080-175
9	160	60	105	5 902T-090-175
10	160	60	105	5 902T-100-175
11	160	60	105	5 902T-110-175
12	160	60	105	5 902T-120-175
13	160	60	105	5 902T-130-175



Porte-embouts manches en T/6 pans 1/4"



**905T**



1/4"	45	60	105	5	905T-060-100	

Jeu de 6 tournevis poignée en T  
3-4-5-6-8-10 mm



**903T-1**



6	1	903T-1

900T-030-100, 900T-040-150, 900T-050-150, 900T-060-200, 900T-080-200, 900T-100-200

Jeu de 6 tournevis manche en T TORX®



**903T-2**



6	1	903T-2

901T-015-150, 901T-020-150, 901T-010-100, 901T-030-200, 901T-040-200, 901T-025-150

Jeu de 6 tournevis manche en T à douille emmanchée



**903T-3**



6	1	903T-3

902T-060-150, 902T-070-175, 902T-050-150, 902T-080-175, 902T-100-175, 902T-130-175

## CONTRÔLEURS DE TENSION

Tournevis isolé, testeur de tension



**806**

3.0	65	16	75	6	806-1-1
3.5	100	17.5	90	6	806-1-2

Testeur de tension 6-24V



**806-1-3**

3	45	16	75	6	806-1-3

Tournevis isolé 1000V VDE, testeur de tension



**8045VDE**



3.5	77	14	92	10	8045VDE

Tournevis isolé 1000V VDE, testeur de tension



**8045LVDE**



3.5	42	16	90	10	8045LVDE

Contrôleur de tension 6-400V



**78802**

V	1	78802B
6		

**TOURNEVIS AVEC PORTE-EMBOUT 1/4"**

Porte-embout magnétique pour embouts 1/4"



**B705**

1/4"	125	30	105	5	B705.1/4.125
1/4"	125	30	105	1	SB705.1/4.125

Porte-embout manches en T/6 pans



**904T**

1/4"		150		5	904T-060-150

Porte-embouts 1/4"



**808050A/TORX**

1/4	115	40	115 mm	1	808050A
1/4	115	40	115 mm	50	808050TORX



## TOURNEVIS AVEC POIGNÉES EN BOIS OU PLASTIQUE

Tournevis manche bois, collet 6 pans, vis à fente



### 9710

Ø	L	l	l <sub>1</sub>	Icons	QTY	Code
3.5	75	22	95	[Screwdriver icons]	10	9710-3.5-75
5.5	100	24	100	[Screwdriver icons]	10	9710-5.5-100
6.5	125	27	110	[Screwdriver icons]	10	9710-6.5-125
8.0	150	30	120	[Screwdriver icons]	5	9710-8-150
10.0	175	32	125	[Screwdriver icons]	5	9710-10-175

Tournevis manche bois, collet 6 pans, vis Phillips



### 9778

Head	L	l	l <sub>1</sub>	Icons	QTY	Code
PH 1	80	24	100	[Screwdriver icons]	10	9778-1
PH 2	110	27	110	[Screwdriver icons]	10	9778-2
PH 3	150	30	120	[Screwdriver icons]	5	9778-3

Tournevis manche bois, collet 6 pans, vis Pozidriv



### 9778PZD

Head	L	l	l <sub>1</sub>	Icons	QTY	Code
PZ 1	80	24	100	[Screwdriver icons]	10	9778PZD-1
PZ 2	110	27	110	[Screwdriver icons]	10	9778PZD-2

Jeu de tournevis manche bois, 6 pièces à fente, PHILLIPS®



### 9710/S6

Head	QTY	Code
X	6	9710/S6

9710-4.5-90, 9710-5.5-100, 9710-6.5-125, 9710-8-150

9778-1, 9778-2

Tournevis à lame réversible  
Vis à fente 6mm, PH-2



### 1019/1067

Head	Head	QTY	Code
4,5	PH 1	10	1067
6	PH 2	10	1019

Tournevis à lame réversible



### 8052

Head	L	l	l <sub>1</sub>	Icons	QTY	Code
PH 2	80	28	110	[Screwdriver icons]	5	8052

Lame réversible, tournevis court pour vis à fente et Philips



**1016**



6

PH 2

10 1016

Set de lames réversibles  
6 lames



**6**



PH 0, PH 1, PH 2

3,5-5,0-6,5

1 6

Tournevis à lame traversante  
Pour vis à fente



**9715**



14.0

250

32

140

5 9715-14-250

Tournevis pour vis à fente et goupille filetée, lame gainée



**7372I**



2.0

63

13

80

10

7372I-2-63

2.5

75

13

80

10

7372I-2.5-75

3.0

80

13

80

10

7372I-3-80

## ACCESSOIRES

Appareil à aimanter et désaimanter



**M780**



29 x 52 x 50 mm



1 M780

Appareil à aimanter et désaimanter



**M781**



22 x 125 x 40 mm



5 M781





**BAHCO**



## Clés mâles



## 6 PANS

Clé mâle coudée, 6 pans, Acier VANADIUM - EXTRA



### 1997M

Ø	L	X	Icon	Icon
3.5	70	10	1997M-3.5	
4	74	10	1997M-4	
4.5	80	10	1997M-4.5	
5	85	10	1997M-5	
6	96	10	1997M-6	
7	102	10	1997M-7	
8	108	10	1997M-8	
9	114	10	1997M-9	
10	122	10	1997M-10	
11	129	10	1997M-11	
12	137	5	1997M-12	
14	154	5	1997M-14	
16	168	1	1997M-16	
17	177	1	1997M-17	
19	199	1	1997M-19	

Jeu de clés mâles coudées, 6 pans



### 1997M/7T

Ø	L	X	Icon	Icon
2, 3, 4, 5, 6, 7, 8 mm	7	1	1997M/7T	

1997M-4, 1997M-5, 1997M-6, 1997M-7, 1997M-8

Jeu de 10 clés mâles coudées, 6 pans



### 1997M/10T

Ø	L	X	Icon	Icon
1.5, 2, 2.5, 3, 3.5, 4, 4.5, 5, 6, 8 mm	10	1	1997M/10T	

1997M-2.5, 1997M-2, 1997M-1.5, 1997M-5, 1997M-4.5, 1997M-4, 1997M-3.5

1997M-8, 1997M-6

Jeu de 11 clés mâles coudées, 6 pans  
11 pièces



### 1997M/11T

Ø	L	X	Icon	Icon
2, 3, 4, 5, 6, 7, 8, 9, 10, 11, 12 mm	11	1	1997M/11T	

1997M-2, 1997M-5, 1997M-4, 1997M-12, 1997M-10, 1997M-11, 1997M-8, 1997M-9, 1997M-6, 1997M-7

Jeu de 9 clés mâles coudées, nickelées  
(1.5-2-2.5-3-4-5-6-8-10)



### BE-9778

Ø	L	X	Icon	Icon
1.5, 2, 2.5, 3, 4, 5, 6, 8, 10 mm	9	1	BE-9778	

1997M-1.5, 1997M-2, 1997M-2.5, 1997M-4, 1997M-5, 1997M-6, 1997M-8, 1997M-10

Jeu de 7 clés mâles coudées, 6 pans  
Acier au CHROME-VANADIUM



### 1999M/7H

Ø	L	X	Icon	Icon
2.5 3 4 5 6 8 10	1	1999M/7H		

Clé mâle coudée 6 pans  
Nickelée



### 1998M

Ø	L	X	Icon	Icon
1.5	47	10	1998M-1.5	
2	52	10	1998M-2	
2.5	59	10	1998M-2.5	
3.0	66	10	1998M-3	
4.0	74	10	1998M-4	
5.0	85	10	1998M-5	
6.0	96	10	1998M-6	
7.0	102	10	1998M-7	
8.0	108	10	1998M-8	
9.0	114	5	1998M-9	
10	122	10	1998M-10	
12.0	137	5	1998M-12	
14.0	154	1	1998M-14	
17.0	177	1	1998M-17	
19.0	199	1	1998M-19	
22.0	222	1	1998M-22	



Jeu de 6 clés mâles coudées nickelées  
6 pièces



**1998M/6T**

2, 2.5, 3, 4, 5, 6 mm	6	1	1998M/6T

1998M-4, 1998M-5, 1998M-6, 1998M-2.5, 1998M-2, 1998M-3

Jeu de 8 clés mâles coudées nickelées



**1998M/8T**

2, 2.5, 3, 4, 5, 6, 7, 8 mm	8	1	1998M/8T

1998M-3, 1998M-2, 1998M-6, 1998M-7, 1998M-4, 1998M-5, 1998M-8, 1998M-2.5

Jeu de 10 clés mâles coudées finition nickel, métriques



**1998M/10T**

2, 2.5, 3, 4, 5, 6, 7, 8, 9, 10 mm	10	1	1998M/10T

1998M-5, 1998M-4, 1998M-7, 1998M-6, 1998M-2, 1998M-3, 1998M-2.5, 1998M-8, 1998M-9, 1998M-10

Jeu de 11 clés mâles coudées nickelées



**1998M/11T**

2, 2.5, 3, 4, 5, 6, 7, 8, 9, 10, 12 mm	11	1	1998M/11T

1998M-5, 1998M-4, 1998M-7, 1998M-6, 1998M-2, 1998M-3, 1998M-2.5, 1998M-8, 1998M-9, 1998M-10, 1998M-12

Jeu de 15 clés mâles coudées nickelées



**1998M/15T**

2, 2.5, 3, 4, 5, 6, 7, 8, 9, 10, 12, 14, 17, 19, 22 mm	15	1	1998M/15T

1998M-2, 1998M-5, 1998M-4, 1998M-7, 1998M-6, 1998M-3, 1998M-2.5, 1998M-14, 1998M-17, 1998M-19, 1998M-22, 1998M-8, 1998M-9, 1998M-10, 1998M-12

Clés mâles hexagonales nickel  
Jeu de 9 pièces



**BE-9878**

1.5, 2, 2.5, 3, 4, 5, 6, 8, 10 mm	9	1	BE-9878

1998M-1.5, 1998M-2.5, 1998M-2, 1998M-3, 1998M-4, 1998M-5, 1998M-6, 1998M-8, 1998M-10

Clés mâles métriques sur anneau  
Finition nickel



**1998M/8R**

2, 2.5, 3, 4, 5, 6, 7, 8 mm	8	1	1998M/8R

Jeu de 12 clés mâles coudées, brunies



**BE-9880**

0.050; 1/16; 5/64; 3/32; 7/64; 1/8; 9/64; 5/32; 3/16; 7/32; 1/4; 5/16 mm	12	3	BE-9880

Clé mâle coudée pour vis 6 pans  
Finition brunie



**1995M**

0.9	33	10	1995M-0.9
1.5	47	10	1995M-1.5
2.0	52	10	1995M-2
2.5	59	10	1995M-2.5
3.0	66	10	1995M-3
4.0	74	10	1995M-4
5.0	85	10	1995M-5
6.0	96	10	1995M-6
7.0	102	10	1995M-7
8.0	108	10	1995M-8
9.0	114	10	1995M-9
10	122	10	1995M-10
12	137	10	1995M-12
14	154	10	1995M-14
17	177	10	1995M-17
19	199	10	1995M-19
22	222	10	1995M-22



Clé mâle pour vis à 6 pans,  
Pouce, brunie



### 1995Z

Clé (mm)	Longueur (mm)	Quantité	Modèle
1/16	47	10	1995Z-1/16
5/64	52	10	1995Z-5/64
3/32	59	10	1995Z-3/32
1/8	66	10	1995Z-1/8
5/32	74	10	1995Z-5/32
3/16	85	10	1995Z-3/16
7/32	91	10	1995Z-7/32
1/4	96	10	1995Z-1/4
5/16	108	10	1995Z-5/16
3/8	122	10	1995Z-3/8
7/16	129	10	1995Z-7/16
1/2	145	10	1995Z-1/2
5/8	168	10	1995Z-5/8
3/4	199	10	1995Z-3/4

Jeu de 6 clés mâles coudées, 6 pans, brunies  
6 pièces



### 1995M/6T

Clé (mm)	Quantité	Modèle
2, 2.5, 3, 4, 5, 6 mm	6	1 1995M/6T

1995M-2, 1995M-2.5, 1995M-6, 1995M-5, 1995M-4, 1995M-3

Jeu de 8 clés mâles coudées, 6 pans, brunies



### 1995M/8T

Clé (mm)	Quantité	Modèle
2, 2.5, 3, 4, 5, 6, 7, 8 mm	8	1 1995M/8T

1995M-2.5, 1995M-2, 1995M-6, 1995M-5, 1995M-4, 1995M-3, 1995M-7, 1995M-8

Jeu de 10 clés mâles coudées, 6 pans, brunies



### 1995M/10T

Clé (mm)	Quantité	Modèle
2, 2.5, 3, 4, 5, 6, 7, 8, 9, 10 mm	10	1 1995M/10T

1995M-2.5, 1995M-2, 1995M-6, 1995M-5, 1995M-4, 1995M-3, 1995M-9, 1995M-10, 1995M-7, 1995M-8

Jeu de 11 clés mâles coudées, 6 pans, brunies  
11 pièces



### 1995M/11T

Clé (mm)	Quantité	Modèle
2, 2.5, 3, 4, 5, 6, 7, 8, 9, 10, 12 mm	11	1 1995M/11T

1995M-2, 1995M-6, 1995M-5, 1995M-4, 1995M-2.5, 1995M-3, 1995M-9, 1995M-10, 1995M-7, 1995M-8, 1995M-12

Jeu de 15 clés mâles coudées, 6 pans, brunies



### 1995M/15T

Clé (mm)	Quantité	Modèle
2, 2.5, 3, 4, 5, 6, 7, 8, 9, 10, 12, 14, 17, 19, 22 mm	15	1 1995M/15T

1995M-2.5, 1995M-2, 1995M-6, 1995M-5, 1995M-4, 1995M-3, 1995M-9, 1995M-10, 1995M-7, 1995M-8, 1995M-17, 1995M-19, 1995M-12, 1995M-14, 1995M-22

Jeu de 9 clés mâles coudées, brunies  
(1.5-2-2.5-3-4-5-6-8-10)



### BE-9578

Clé (mm)	Quantité	Modèle
1.5, 2, 2.5, 3, 4, 5, 6, 8, 10 mm	9	1 BE-9578

1995M-2.5, 1995M-2, 1995M-1.5, 1995M-6, 1995M-5, 1995M-4, 1995M-3, 1995M-8, 1995M-10

Jeu de 7 clés mâles coudées



### BE-9777B

Clé (mm)	Quantité	Modèle
2.5 3 4 5 6 8 10	7	6 BE-9777B

Jeu de 7 clés mâles coudées, 6 pans



### BE-9776

Clé (mm)	Quantité	Modèle
1.5 2 2.5 3 4 5 6	6	6 BE-9776

Jeu de 7 clés mâles coudées, 6 pans



**BE-9777**

2.5 3 4 5 6 8 10	7	6	BE-9777

Jeu de 7 clés mâles



**BE-9787**

3/32 1/8 5/32 3/16 1/4 5/16 3/8 in	6	6	BE-9787

Jeu de 9 clés coudées 6 pans, finition brunie



**BE-9588**

1.5, 2, 2.5, 3, 4, 5, 6, 8, 10 mm	9	1	BE-9588

Clés pour vis 6 pans, finition brunie



**1995Z/10T**

1/16, 5/64, 3/32, 1/8, 5/32, 3/16, 7/32, 1/4, 5/16, 3/8 in	10	1	1995Z/10T

1995Z-1/16, 1995Z-5/64, 1995Z-3/32, 1995Z-1/8, 1995Z-5/32, 1995Z-3/16, 1995Z-3/8, 1995Z-7/32, 1995Z-1/4, 1995Z-5/16

Clé mâle coudée pour vis à 6 pans, métrique, brunie



**1995LM**

1.5	91	10	1995LM-1.5
2	102	10	1995LM-2
2.5	114	10	1995LM-2.5
3.0	129	10	1995LM-3
4.0	144	10	1995LM-4
5.0	165	10	1995LM-5
6.0	186	10	1995LM-6
7.0	197	10	1995LM-7
8.0	208	10	1995LM-8
9.0	219	10	1995LM-9
10	234	10	1995LM-10
12	262	10	1995LM-12
14	294	10	1995LM-14

1995LM-1.5, 1995LM-2, 1995LM-2.5, 1995LM-3, 1995LM-4, 1995LM-5, 1995LM-6, 1995LM-8, 1995LM-10

Clé mâle à tête sphérique, brunie



**1996M**

1.5	91	10	1996M-1.5
2.0	102	10	1996M-2
2.5	114	10	1996M-2.5
3.0	129	10	1996M-3
4.0	144	10	1996M-4
5.0	165	10	1996M-5
6.0	186	10	1996M-6
8.0	208	10	1996M-8
10	234	10	1996M-10
12	262	10	1996M-12

Clés pour vis 6 pans, finition brunie



**1995Z/12T**

1/16, 5/64, 3/32, 1/8, 5/32, 3/16, 7/32, 1/4, 5/16, 3/8, 7/16, 1/2 in	12	1	1995Z/12T

1995Z-1/16, 1995Z-5/64, 1995Z-3/32, 1995Z-1/8, 1995Z-5/32, 1995Z-3/16, 1995Z-1/2, 1995Z-7/16, 1995Z-3/8, 1995Z-7/32, 1995Z-1/4, 1995Z-5/16

Jeu de 6 clés coudées 6 pans, finition brunie



**BE-9586**

1.5, 2, 2.5, 3, 4, 5 mm	6	1	BE-9586

1995LM-1.5, 1995LM-3, 1995LM-2.5, 1995LM-2, 1995LM-4, 1995LM-5

Jeu de 9 clés mâles coudées à tête sphérique, 6 pans



**BE-9765**

1.5, 2, 2.5, 3, 4, 5 mm	6	3	BE-9765

1996M-1.5, 1996M-2.5, 1996M-2, 1996M-4, 1996M-3, 1996M-5



Jeu de 9 clés longues coudées à tête sphérique, 6 pans



**BE-9770**

1.5, 2, 2.5, 3, 4, 5, 6, 8, 10 mm	9	3	BE-9770

1996M-1.5, 1996M-2.5, 1996M-2, 1996M-4, 1996M-3, 1996M-5, 1996M-6, 1996M-10, 1996M-8

Jeu de 9 clés mâles 6 pans coudées à tête sphérique, brunies



**BE-9676**

1.5, 2, 2.5, 3, 4, 5 mm	6	1	BE-9676

1996M-5, 1996M-4, 1996M-3, 1996M-2.5, 1996M-2, 1996M-1.5

Jeu de 9 clés mâles coudées à tête sphérique, brunies



**BE-9678**

1.5, 2, 2.5, 3, 4, 5, 6, 8, 10 mm	9	1	BE-9678

1996M-4, 1996M-5, 1996M-2.5, 1996M-3, 1996M-10, 1996M-6, 1996M-8, 1996M-2, 1996M-1.5

Jeu de 9 clés mâles coudées à tête sphérique, brunies (1.5-2-2.5-3-4-5-6-8-10)



**BE-9688**

1.5, 2, 2.5, 3, 4, 5, 6, 8, 10 mm	9	1	BE-9688

1996M-1.5, 1996M-2, 1996M-2.5, 1996M-3, 1996M-4, 1996M-5, 1996M-6, 1996M-8, 1996M-10

Jeux de 7 clés 6 pans



**BE-9776B**

2.5, 3, 4, 5, 6, 8, 10	7	6	BE-9776B

Jeu de 7 clés longues coudées à tête sphérique, 6 pans



**BE-9775**

1/16, 5/64, 3/32, 1/8, 5/32, 3/16, 1/4 in	7	3	BE-9775

Jeu de 12 clés longues coudées à tête sphérique, 6 pans, finition brunie



**BE-9780**

0.05 1/16 5/64 3/32 7/64 1/8 9/64 5/32 3/16 7/32 1/4 5/16 in	12	3	BE-9780

Jeu de 13 clés longues coudées à tête sphérique, 6 pans



**BE-9785**

0.05 1/16 5/64 3/32 7/64 1/8 9/64 5/32 3/16 7/32 1/4 5/16 3/8 in	13	3	BE-9785

**TORX®**

Clé mâle pour vis Torx, brunie



**1995TORX**

T 6	75	5	1995TORX-T6
T 7	80	5	1995TORX-T7
T 8	80	5	1995TORX-T8
T 9	80	5	1995TORX-T9
T 10	86	5	1995TORX-T10
T 15	90	5	1995TORX-T15
T 20	95	5	1995TORX-T20
T 25	100	5	1995TORX-T25
T 27	105	5	1995TORX-T27
T 30	114	5	1995TORX-T30
T 40	124	5	1995TORX-T40
T 45	133	5	1995TORX-T45
T 50	152	5	1995TORX-T50
T 55	184	5	1995TORX-T55
T 60	204	5	1995TORX-T60

Jeu de 4 clés mâles coudées TORX®



**1995TORX/4T**

10, 20, 30, 40	4	1	1995TORX/4T

1995TORX-T40, 1995TORX-T30,  
1995TORX-T10, 1995TORX-T20

Jeu de 7 clés mâles coudées TORX®



**1995TORX/7T**

10, 15, 20, 25, 27, 30, 40	7	1	1995TORX/7T

1995TORX-T20, 1995TORX-T10,  
1995TORX-T15, 1995TORX-T27,  
1995TORX-T25, 1995TORX-T30,  
1995TORX-T40

Jeu de 11 clés mâles coudées TORX®



**1995TORX/11T**

7, 9, 10, 15, 20, 25, 27, 30, 40, 45, 50	11	1	1995TORX/11T

1995TORX-T7, 1995TORX-T9,  
1995TORX-T10, 1995TORX-T15,  
1995TORX-T20, 1995TORX-T25,  
1995TORX-T27, 1995TORX-T30,  
1995TORX-T40, 1995TORX-T45,  
1995TORX-T50

Jeu de 13 clés mâles coudées TORX®



**1995TORX/13T**

6, 7, 8, 9, 10, 15, 20, 25, 27, 30, 40, 45, 50	13	1	1995TORX/13T

1995TORX-T45, 1995TORX-T40,  
1995TORX-T30, 1995TORX-T27,  
1995TORX-T25, 1995TORX-T20,  
1995TORX-T15, 1995TORX-T10,  
1995TORX-T50, 1995TORX-T8,  
1995TORX-T9, 1995TORX-T6,  
1995TORX-T7

Jeu de 8 clés mâles coudées TORX, brunies  
brunies



**BE-9575**

T9, T10, T15, T20, T25, T27, T30, T40	8	1	BE-9575

1995TORX-T40, 1995TORX-T30,  
1995TORX-T27, 1995TORX-T25,  
1995TORX-T20, 1995TORX-T15,  
1995TORX-T10, 1995TORX-T9

Jeu de 8 clés mâles coudées Torx, avec aimant  
(T9-10-15-20-25-27-30-40)



**BE-9585**

T9, T10, T15, T20, T25, T27, T30, T40	8	1	BE-9585

1995TORX-T30, 1995TORX-T27,  
1995TORX-T25, 1995TORX-T20,  
1995TORX-T15, 1995TORX-T10,  
1995TORX-T9, 1995TORX-T40

Jeu de tournevis TORX®, contre-coudé, noirs  
8 pièces



**BE-8975B**

T9 - T10 - T15 - T 20 - T25 - T27 - T 30 - T40	8	6	BE-8975B

Jeu de 8 clés mâles coudées, TORX®  
Acier VANADIUM-EXTRA



**BE-8975**

T9 10 15 20 25 27 30 40	8	6	BE-8975



Clé mâle pour vis Torx, tête sphérique



**1996TORX**

	L		
T 9	80	5	1996TORX-T9
T 10	86	5	1996TORX-T10
T 15	90	5	1996TORX-T15
T 20	95	5	1996TORX-T20
T 25	100	5	1996TORX-T25
T 27	105	5	1996TORX-T27
T 30	114	5	1996TORX-T30
T 40	124	5	1996TORX-T40
T 45	133	5	1996TORX-T45
T 50	152	5	1996TORX-T50

Jeu de 5 clés mâles coudées TORX



**1996TORX/5T**

	X		
T10, T20, T25, T30, T40	5	1	1996TORX/5T

1996TORX-T10, 1996TORX-T20,  
1996TORX-T25, 1996TORX-T30,  
1996TORX-T40

Jeu de 8 clés mâles Torx  
têtes sphériques, brunies



**BE-9675**

	X		
T9, T10, T15, T20, T25, T27, T30, T40	8	1	BE-9675

1996TORX-T10, 1996TORX-T9,  
1996TORX-T15, 1996TORX-T20,  
1996TORX-T25, 1996TORX-T27,  
1996TORX-T30, 1996TORX-T40

Clé mâle torx de sécurité, brunie



**1986TORX**

	L		
TR 9	80	5	1986TORX-T9
TR 10	86	5	1986TORX-T10
TR 15	90	5	1986TORX-T15
TR 20	95	5	1986TORX-T20
TR 25	100	5	1986TORX-T25
TR 27	105	5	1986TORX-T27
TR 30	114	5	1986TORX-T30
TR 40	124	5	1986TORX-T40

Jeu de 7 clés mâles coudées TORX



**1986TORX/7T**

	X		
TR10, TR15, TR20, TR25, TR27, TR30, TR40	7	1	1986TORX/7T

1986TORX-T10, 1986TORX-T15,  
1986TORX-T20, 1986TORX-T25,  
1986TORX-T27, 1986TORX-T30,  
1986TORX-T40

Jeu de 8 clés mâles TORX, inviolables, brunies  
(T9-10-15-20-25-27-30-40)



**BE-8675**

	X		
T9, T10, T15, T20, T25, T27, T30, T40	8	1	BE-8675

1986TORX-T10, 1986TORX-T9,  
1986TORX-T20, 1986TORX-T15,  
1986TORX-T30, 1986TORX-T40,  
1986TORX-T25, 1986TORX-T27

Jeu de 8 clés pour vis TORX, finition brunie



**BE-8976B**

	X		
T9, T10, T15, T20, T25, T27, T30, T40	8	6	BE-8976B

Clé mâle pour Torx Plus, brunie



**1976TORX**

	L		
IP 6	75	5	1976TORX-T6
IP 7	80	5	1976TORX-T7
IP 8	80	5	1976TORX-T8
IP 9	80	5	1976TORX-T9
IP 10	86	5	1976TORX-T10
IP 15	90	5	1976TORX-T15
IP 20	95	5	1976TORX-T20
IP 25	100	5	1976TORX-T25
IP 27	105	5	1976TORX-T27
IP 30	114	5	1976TORX-T30
IP 40	124	5	1976TORX-T40

Clé mâle coudée TORX PLUS



**1976TORX/5T**

	X		
IP 10, IP 20, IP 25, IP 30, IP 40	5	1	1976TORX/5T

1976TORX-T10, 1976TORX-T20,  
1976TORX-T25, 1976TORX-T40,  
1976TORX-T30



Jeu de 8 clés mâles Torx plus  
brunies



### BE-7675



IP9, IP10, IP15,  
IP20, IP25, IP27,  
IP30, IP40

8

1 BE-7675

1976TORX-T10, 1976TORX-T9,  
1976TORX-T15, 1976TORX-T20,  
1976TORX-T25, 1976TORX-T30,  
1976TORX-T40, 1976TORX-T27



## DOUBLES COUDÉES

Tournevis double coudé, pour vis à fente



### 2047



4.0	100	5	2047-0.8-4
5.5	125	5	2047-1.5-5
8.0	150	5	2047-1.2-8
10.0	175	1	2047-1.6-10
12.0	200	1	2047-2-12

Tournevis coudé, pour vis Phillips



### 2047PR



PH 1 & 2	100	5	2047PR-1-2
PH 3 & 4	200	5	2047PR-3-4

Double tournevis coudé, vis Pozidriv



### 2047PZ



PZ1, PZ2	100	5	2047PZ-1-2
----------	-----	---	------------

## OUTILS MULTI-FONCTIONS

Jeu de 17 outils spécial vélo



### BKE850901N



200 x 35 x 170 mm	10	BKE850901N
-------------------	----	------------





**BAHCO**





# Pinces



## PINCES COUPANTES

Pince coupante diagonale à taillants progressifs  
Pour des cordes à piano et matériaux tendres comme le cuivre et le plastique

ergo®



### 2101G

Cu	Fe+	Piano	L		
3.5	1.8	1.6	125	5	2101G-125
3.7	2.0	1.8	140	5	2101G-140
3.8	2.5	2.0	160	5	2101G-160
4.0	2.7	2.3	180	5	2101G-180
3.5	1.8	1.6	125	5	2101G-125IP
3.7	2.0	1.8	140	5	2101G-140IP
3.8	2.5	2.0	160	5	2101G-160IP
4.0	2.7	2.3	180	5	2101G-180IP

Pincas coupantes diagonales taillants progressif sans fonction de ressort marche / arrêt. Pour le fil de piano et les matériaux plus doux comme le cuivre ou le plastique

ergo®



### 2101G\_D

Cu	Fe+	Piano	L		
3.5 mm	1.8 mm	1.6 mm	125	5	2101G-125IPD
3.7 mm	2.0 mm	1.8 mm	140	5	2101G-140IPD
3.8 mm	2.5 mm	2.0 mm	160	5	2101G-160IPD
4.0 mm	2.7 mm	2.3 mm	180	5	2101G-180IPD

Pince coupante diagonale, pour le plastique  
Taillants ras

ergo®



### 2101PG

L		
160	5	2101PG-160

mâchoires arrondies, cap. de coupe max 1,5 mm.

Pince coupante diagonale chromée, taillants progressifs  
Corde à piano et matériaux tendres comme le cuivre et le plastique

ergo®



### 2101GC

Cu	Fe+	Piano	L		
3.5	1.8	1.6	125	5	2101GC-125IP
3.7	2.0	1.8	140	5	2101GC-140IP
3.8	2.5	2.0	160	5	2101GC-160IP
4.0	2.7	2.3	180	5	2101GC-180IP

Pince coupante diagonale, taillants progressifs  
Pour cordes de piano et matériaux tel que plastique ou cuivre



### 2101D

Cu	Fe+	Piano	L		
3.5	1.8	1.6	125	5	2101D-125
3.7	2.0	1.8	140	5	2101D-140
3.8	2.5	2.0	160	5	2101D-160
4.0	2.7	2.3	180	5	2101D-180
3.5	1.8	1.6	125	5	2101D-125IP
3.7	2.0	1.8	140	5	2101D-140IP
3.8	2.5	2.0	160	5	2101D-160IP
4.0	2.7	2.3	180	5	2101D-180IP

Pince coupante Ergo™ usage intensif  
Pour les matériaux très durs

ergo®



### 21HDG

Fe+	Piano	L		
2.2	2.2	140	5	21HDG-140
2.5	2.5	160	5	21HDG-160
2.8	2.8	180	5	21HDG-180
3.2	3.0	200	5	21HDG-200
2.2	2.2	140	5	21HDG-140IP
2.5	2.5	160	5	21HDG-160IP
2.8	2.8	180	5	21HDG-180IP
3.2	3.0	200	5	21HDG-200IP

Pince coupante diagonale Ergo™ coudée usage intensif  
Pour les matériaux très durs

ergo®



**21HDG-A**

Fe+	Piano	L	Icons
2.2	2.0	140	5 21HDG-140A
2.5	2.3	160	5 21HDG-160A
2.7	2.5	180	5 21HDG-180A
3.2	3.0	200	5 21HDG-200A

Tête avec un angle de 14°

Pince coupante Ergo™ chromée usage intensif  
Pour les matériaux très durs

ergo®



**21HDGC**

Fe+	Piano	L	Icons
2.2	2.2	140	5 21HDGC-140IP
2.5	2.5	160	5 21HDGC-160IP
2.8	2.8	180	5 21HDGC-180IP
3.2	3.0	200	5 21HDGC-200IP

Pince coupante diagonale à usage industriel  
Pour les matériaux très durs



**21HDD**

Fe+	Piano	L	Icons
2.2	2.2	140	5 21HDD-140
2.5	2.5	160	5 21HDD-160
2.8	2.8	180	5 21HDD-180
3.2	3.0	200	5 21HDD-200
2.2	2.2	140	5 21HDD-140IP
2.5	2.5	160	5 21HDD-160IP
2.8	2.8	180	5 21HDD-180IP
3.2	3.0	200	5 21HDD-200IP

Pince coupante précision centrale longueur 210 mm  
Fil d'acier dur et matériaux tendres



**1520G**

Piano	L	Icons
3.8	210	5 1520 G

Pince coupante précision centrale, poignée bi-matière, lame acier forgé.

Pince coupante précision centrale  
Fil d'acier dur et matériaux tendres



**1520D**

Piano	L	Icons
3.8	205	5 1520 D

Pince coupante précision centrale, poignées gainées PVC, lame acier forgé.

Pince coupante diagonales

ergo®



**4130, 4131**

Fe	L	Icons
0.3-1.5	120	3 4130
0.3-1.5	120	3 4131

Pinces coupantes diagonales, poignées ERGOTM bi-matière, ressort de rappel.



Pince coupante diagonale, tête ovale



**C3140**

0,4-2,0 mm	130	10	C3140
0,4-2,0 mm	130	10	C3140IP

Pince coupante diagonale pour plastique  
Taillants ras



**2100PD**

1.8 mm	3.0 mm	150	5	2100PD-150

Pince coupante diagonale, tête effilée



**C3330**

0,3-1,6 mm	115	10	C3330
0,3-1,6 mm	115	10	C3330IP

Pince coupante diagonale pour le plastique  
Taillant ras, 90°



**2190PD**

1.8 mm	3.0 mm	143	5	2190PD-150

Pince coupante diagonale pour le plastique,  
angle 90°, taillants ras sans biseaux.

Pincettes coupantes diagonales, tête effilée et allégée



**C3330R/C3340R**

0,3-1,25 mm	115	10	C3330R
0,3-1,25 mm	115	10	C3330R IP
0,4-1,6 mm	130	10	C3340R
0,4-1,6 mm	130	10	C3340R IP

Pince coupante diagonale



**2171G**

2.5	1.6	1.5	150	5	2171G-140
2.5	1.6	1.5	160	5	2171G-160
2.5	1.6	1.5	185	5	2171G-180

Pince coupante diagonale, finition laquée polie,  
poignées bi-matière.

Pince coupante diagonale chromée  
Fil d'acier dur



**2666NB-2676NB**

2.7	2.0	160	1	2674 NB

Pince coupante diagonale chromée, avec biseau externe.

Pince coupante diagonale chromée  
Corde à piano



**2667B-2678B**

3.7	2.0	2.0	160	1	2676 B
4.0	2.5	2.5	200	1	2678 B

Pince coupante diagonale chromée, avec biseau externe.

Pince coupante diagonale , tête ovale



**2646M - 2649**

0.1-0.8	Ultra	108	1	2646 M
0.2-1.25	Micro	110	1	2646 R
0.2-1.25	Micro	110	1	2646 RK
0.1-1.0	Ultra	110	1	2646 RA
0.3-1.6	Micro	1125.5	1	2666
0.4-2.0	Micro	125	1	2649

Pinces coupantes diagonales, tête ovale, vis articulée, poignées avec ressort de rappel.

Pince coupante diagonale , tête pointue



**2646 - 2648A**

0.2-1.25	Micro	110	1	2646
0.2-1.25	Micro	110	1	2646 K
0.1-1.0	Ultra	110	1	2646 A
0.1-1.0	Ultra	110	1	2646 AK
0.2-1.25	Ultra	112.5	1	2666 FK
0.4-2.0	Micro	125	1	2648
0.3-1.6	Ultra	125	1	2648 A

Pinces coupantes diagonales , tête pointue, vis articulée, poignées avec ressort de rappel.

Pince coupante oblique



**4231**

0.3-1.25	119	3	4231

Pinces coupantes obliques, poignées bi-matière, angle de coupe 20°, ressort de rappel.

Pince coupante oblique 45°



**4239**

0.3-1.0	129	3	4239

Pinces coupantes obliques 45°, poignées bi-matière, angle de coupe 45°, ressort de rappel.



Pince coupante diagonale spécial plastique  
Taillant ras, 45°



**2145PD**

3.0 mm	1.8 mm	154	5	2145PD-150

Pince coupante diagonale spécial plastique,  
angle 45°, taillants à ras sans biseaux.

Pince coupante oblique 45°, à tête longue



**2787F**

0.2-1.0	Flush	117.5	1	2787 F

Pincettes coupantes obliques 45°, à tête longue,  
vis articulée, poignées avec ressort de rappel.

Pince coupante oblique 45°, à tête longue, effilée



**2787G**

0.2-0.8	Flush	117.5	1	2787 G

Pincettes coupantes obliques 45°, tête longue,  
effilée, vis articulée, poignées avec ressort de rappel.

Pince coupante en bout chromée mate



**527 GC**

2.0	160	3	527 GC-160
2.5	200	3	527 GC-200

Pince coupante en bout phosphatée  
Corde à piano



**527D**

2	160	5	527 D-160
2.5	200	5	527 D-200

Pince coupante en bout phosphatée, traitée  
anti-corrosion, poignées gainées PVC.

Tenaille russe



**2339D**

2.2	220	3	2339 D
2.2	220	5	2339 DIP
4.5 mm	300	5	2339D-300
4.5 mm	300	6	2339D-300IP

## Tenailles russes



### 2339

Fe mm	L		
2.2	220	5	2339-220
2.2	220	5	2339-220IP
2.5	250	5	2339-250IP
3.0	280	5	2339-280IP
4.5	300	6	2339-300IP

Tenailles russes, pour la coupe de fers à béton.

## Tenaille, fil de fer



### 541D

Fe mm	L		
2.0	150	5	541 D-150
2.0	180	5	541D-180
2.5	200	5	541 D-200
2.5	225	5	541D-225
2.5	250	5	541 D-250

Tenaille avec poignées gainées plastique, dureté spéciale des taillants

## Pince coupante diagonale phosphatée Corde à piano



### 1519D

Fe mm	L		
2.5	230	3	1519 D
		1	1519-9

Pince coupante diagonale phosphatée, poignées extra-longues.

## Pince coupante en bout



### C3230

L		
109	10	C3230
109	10	C3230IP

## Pince coupante oblique, embout miniature



### 2656/2656A

		L		
0.35 - 0.8	Micro	115	1	2656

coupantes obliques, embout miniature, vis articulée, poignées avec ressort de rappel.

## Coupe-câble et pince à dénuder Pour fil de cuivre et aluminium



### 2233D

		L		
10	50/35	160	5	2233 D-160
13	70/50	200	5	2233 D-200
16	95/70	240	5	2233 D-240
10	50/35	160	5	2233D-160IP
13	70/50	200	5	2233D-200IP
16	95/70	240	5	2233D-240IP

Coupe-câble et pince à dénuder, poignées gainées PVC.



Pince coupe câble pour cuivre et aluminium



**2260G**



210



5 2260 G-210

Coupe-câbles pour aluminium et cuivre



**2520**



550  
220



1 2520  
1 2520-SH

Coupe-câbles pour câbles en aluminium et cuivre avec ou sans câble porteur principal.

Coupe câbles fil de cuivre



**2620-80**



42 mm



800



1 2620-80

Coupe-câbles pour câbles en aluminium et cuivre non armés

Coupe câbles acier



**2720**



42 mm



600  
163



1 2720  
1 2720-SH

Coupe câbles acier.

Coupe câbles acier



**2235-160**



165



1 2235-160

Coupe câbles acier, ressort et mécanisme de verrouillage.

Coupe-câbles Aluminium et cuivre



**2804-2805**



16

22



34

52



250

280

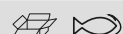

1 2804

1 2805-280

Coupe-câbles, poignées gainées PVC, câbles multibrins.



Coupe-câbles  
Fil de cuivre gainé



**2800N-2801N**

0-10		170	1	2800 N
0-15		230	1	2801 N

Coupe-câbles, poignées gainées PVC.

Coupe-boulons



**4559**

6	5	4	320	1	4559-12	
8	7	6	430	8	4559-18	
10	9	8	600	6	4559-24	
13	10	9	750	5	4559-30	
15	12	11	900	3	4559-36	
15	12	11	1060	2	4559-42	

Tête de coupe pour coupe-boulons gamme 4559



**4559 JC**

285	1	4559-12A JC
600	1	4559-18B JC
930	1	4559-24B JC
1260	1	4559-30B JC
2180	1	4559-36B JC
3025	1	4559-42A JC

Tête de coupe pour coupe-boulons gamme 4559

Coupe-boulons



**4560-210**

250	1	4560-210

Coupe-boulons avec système d'ouverture et fermeture.

**PINCES UNIVERSELLES**

Pince universelle



**2628G**

1.8	2.0	160	5	2628 G-160
2.0	2.5	180	5	2628 G-180
2.5	3.0	200	5	2628 G-200
1.8	2.0	160	5	2628 G-160IP
2.0	2.5	180	5	2628 G-180IP
2.5	3.0	200	5	2628G-200IP

Pince universelle, poignées ERGO™ bi-matière, Taillants pour matériaux résistants, becs arrondis.

Pince universelle, chromée



**2628GC**

2.0	1.8	160	5	2628 GC-160IP
2.5	2.0	180	5	2628 GC-180IP
3.0	2.5	200	5	2628 GC-200IP

Pince universelle, chromée, poignées ERGO™ bi-matière, pour matériaux résistants.



Pince universelle, poignée bi-matière  
Taillant renforcée

ergo®



**2630GC**

Fe+	Piano	L		
1.8	2.0	160	5	2630GC-160IP
2.0	2.5	180	5	2630GC-180IP
2.5	3.0	200	5	2630GC-200IP

Pince universelle, poignée bi-matière, taillants  
pour matériaux résistants, becs ronds.

Pinces mixtes à becs demi-ronds ERGO™

ergo®



**2629G**

L		
160	5	2629G-160
180	5	2629G-180
200	5	2629G-200
160	5	2629G-160IP
180	5	2629G-180IP
200	5	2629G-200IP

Pince universelle, poignées gainées PVC



**2628D**

Fe+	Piano	L		
2.0	1.8	160	5	2628 D-160
2.5	2.0	180	5	2628 D-180
3.0	2.5	200	5	2628 D-200

Pince universelle, poignées gainées PVC,  
taillants pour matériaux résistants, mâchoires arrondies.

Pince universelle, poignées gainées PVC  
Taillants renforcés



**2630DC**

Fe+	Piano	L		
2.0 mm	1.8 mm	160	5	2630DC-160IP
2.5 mm	2.0 mm	180	5	2630DC-180IP
3.0 mm	2.5 mm	200	5	2630DC-200IP

Pince universelle, poignées gainées PVC, lames  
renforcées, mâchoires arrondies.

Pince universelle, modèle américain  
Linesman



**2640D**

Cu	Fe mm	Fe+	L		
3.0	2.7	2.5	160	10	2640D-160
3.0	2.7	2.5	180	5	2640D-180
3.5	3.0	2.5	200	5	2640D-200

Pince universelle, poignées gainées PVC, forme  
traditionnelle, becs adaptés aux matériaux plats.

Pince universelle



**2688D**

Fe+	Fe mm	Cu	L		
2.5 mm	3.0 mm	3.5 mm	250	3	2688D-250

Pince universelle, traitée anti-corrosion,  
becs adaptés aux matériaux plats.

## Pince coupante universelle



### 2678G

Fe+	Piano	L		
1.7	1.3	160	5	2678 G-160
2.0	1.4	180	5	2678 G-180
2.5	1.5	205	5	2678 G-200

Pince universelle, poignées bi-matière.

## Pince 2 positions



### 2970 G-200

L		
200	5	2970G-200

## PINCES DE PRÉHENSION

### Pince à becs demi-ronds longs Fil d'acier dur



### 2430G

Cu	Fe mm	Fe+	L		
2.5	1.8	1.4	140	5	2430 G-140
3.0	1.8	1.6	160	5	2430 G-160
3.0	1.8	1.6	200	5	2430 G-200
2.5	1.8	1.4	140	5	2430 G-140 IP
3.0	1.8	1.6	160	5	2430 G-160 IP
3.0	1.8	1.6	200	5	2430 G-200 IP

Pince à becs demi-ronds, poignées bi-matière,  
Taillants pour matériaux tendres.

### Pince à becs demi-ronds long chromée Fil d'acier dur



### 2430GC

Cu	Fe mm	Fe+	L		
2.5	1.8	1.4	140	5	2430 GC-140 IP
3.0	1.8	1.6	160	5	2430 GC-160 IP
3.0	1.8	1.6	200	5	2430 GC-200 IP

Pince à becs demi-ronds, poignées bi-matière,  
taillants pour matériaux tendres.

### Pince à becs demi-ronds long Fil d'acier dur



### 2430G-HD

Cu	Piano	L		
3.0	1.6	190	5	2430 G-190HD

Pince à becs demi-ronds, poignées bi-matière,  
taillants pour matériaux tendres.

### Pince à becs demi-ronds long Fil d'acier dur, gaine PVC



### 2430D

Cu	Fe mm	Fe+	L		
2.5	1.8	1.4	140	5	2430 D-140
3.0	1.8	1.6	160	5	2430 D-160
3.0	1.8	1.6	200	5	2430 D-200
2.5	1.8	1.4	140	5	2430 D-140 IP
3.0	1.8	1.6	160	5	2430 D-160 IP
3.0	1.8	1.6	200	5	2430 D-200 IP

Pince à becs demi-ronds, poignées gainées  
PVC, taillants pour matériaux tendres.



Pinces à becs demi-ronds longs ERGO™, sans bord tranchant



**2431G**



125	5	2431G-125
140	5	2431G-140
160	5	2431G-160
180	5	2431G-180
125	5	2431G-125IP
140	5	2431G-140IP
160	5	2431G-160IP
180	5	2431G-180IP

Pince à becs demi-ronds



**4830, 4831**



135	3	4830
135	3	4831

Pinces à becs demi-ronds, poignées bi-matière, ressort de rappel.

Pinces à becs demi-ronds



**C3830/C3840**



121	10	C3830
121	10	C3830IP
144	10	C3840
144	10	C3840IP

Pinces à becs demi-ronds



**C3630/C3640**



130	10	C3630
130	10	C3630IP
145	10	C3640
145	10	C3640IP

Pince de préhension, becs demi-ronds



**2656S**



132	1	2656 S
-----	---	--------

Pince de préhension, becs demi-ronds, vis articulée, poignées avec ressort de rappel.

Pince à becs demi-ronds



**2470G**



3.0	1.5	1.0	165	5	2470 G-160
3.0	1.5	1.0	210	5	2470 G-200

Pince à becs demi-ronds

Pince extra longue à becs striés



**158-N**

Icon	Icon	Icon	Icon	Icon
280			12	158-N

Pince à becs longs demi-ronds, coudés 45°  
Fil d'acier dur - gaines PVC



**2427D**

Icon	Icon	Icon	Icon	Icon	Icon
3.0	1.8	1.6	160	5	2427 D-160
3.0	1.8	1.6	200	5	2427 D-200

Pince à becs longs demi-ronds coudés 45°  
Fil d'acier dur



**2427G**

Icon	Icon	Icon	Icon	Icon	Icon
3.0	1.8	1.6	160	5	2427 G-160
3.0	1.8	1.6	200	5	2427 G-200
3.0	1.8	1.6	160	5	2427 G-160 IP
3.0	1.8	1.6	200	5	2427 G-200 IP

Pincés à becs longs demi-ronds coudés 45°,  
Poignées bi-matière, pour matériaux tendres.

Pince à becs demi-ronds, coudée à 60°



**4833**

Icon	Icon	Icon
130	3	4833

Pincés à becs demi-ronds, coudées à 60°, poignées  
bi-matière, becs lisse et ressort de rappel.

Pince à becs longs demi-ronds, coudées à 45°, chromée  
Fil d'acier dur



**2427GC**

Icon	Icon	Icon	Icon	Icon	Icon
3.0	1.8	1.6	160	5	2427 GC-160IP
3.0	1.8	1.6	200	5	2427 GC-200IP

Poignées bi-matière  
Taillants pour matériaux tendres

Pince à becs demi-ronds coudés 45°



**C3745**

Icon	Icon	Icon
141	10	C3745
141	10	C3745IP



Pince à becs demi-ronds coudés 90°



**C3790**



125  
125



10 C3790  
10 C3790IP

Pince à becs demi-ronds, coudée à 60°



**2656R**



129



1 2656 R

Pinces à becs demi-ronds, coudées à 60°, poignées avec ressort de rappel.

Pince à becs demi-ronds coudées



**2477G-200**



3.0



1.5



1



210



5 2477 G-200

Pinces à becs demi-ronds coudées

Pince extra longues 270 mm à becs striés  
Coudées à 35°



**158-NB**



270



12 158-NB

Pince à becs plats



**2420G**



125  
125



5 2420 G-125  
5 2420G-125IP

Pinces à becs plats, poignées ERGOTM bi-matière, pour saisir les pièces plates, ressort de rappel.

Pince à becs effilés



**2421G**



140  
160  
180  
140  
160  
180



5 2421 G-140  
5 2421 G-160  
5 2421 G-180  
5 2421 G-140IP  
5 2421 G-160 IP  
5 2421 G-180 IP

Pinces à becs effilés, poignées ERGOTM bi-matière, becs striés, ressort de rappel.

## Pinces à becs plats - chromées

ergo®



### 2421GC



140	5	2421GC-140IP
160	5	2421GC-160IP
180	5	2421GC-180IP

Pinces à becs plats - chromées, poignées ERGOTM bi-matière, ressort de rappel.

## Pinces à becs plats, poignées gainées PVC



### 2421D



140	5	2421 D-140IP
160	5	2421 D-160IP
180	5	2421 D-180IP

Pinces à becs plats, poignées gainées PVC

## Pinces de connexion

ergo®



### 7835G



3.0	1.8	1.6	160	5	7835 G-160
-----	-----	-----	-----	---	------------

Pinces de connexion, poignées ERGO™, taillants affûtés, ressort de rappel.

## Pince à becs plats

ergo®



### 4430



135	3	4430
-----	---	------

Pinces à becs plats, poignées bi-matière, ressort de rappel, mâchoires lisses.

## Pince à becs plats



### C3430



129	10	C3430
129	10	C3430IP

## Pinces à becs plats



### 2646MF



120	1	2646 MF
-----	---	---------

Pinces à becs plats, surface de prise lisse de 20 mm, vis articulée, ressort de rappel.



## Pinces à becs plats



### 2471G



165



5 2471 G-160

Pinces à becs plats, finition laquée et polie, traitée anti-corrosion, poignées bi-matière.

## Pince à écrous



### 2979D



180



5 2979 D-180

Pinces à écrous, poignées PVC, capacité 3-13 mm.

## Pince à becs ronds

ergo®



### 2521G



140

160

140

160



5 2521 G-140

5 2521G-160

5 2521G-140IP

5 2521 G-160 IP

Pinces à becs ronds, poignées bi-matière, ressort de rappel.

## Pince à becs ronds - chromées

ergo®



### 2521GC



160



5 2521GC-160

Pinces à becs ronds - chromées, poignées bi-matière, ressort de rappel.

## Pince à becs ronds Gaine PVC



### 2521D



140

160

140

160



5 2521 D-140

5 2521D-160

5 2521D-140IP

5 2521D-160IP

Pinces à becs ronds, poignées gainées.

## Pince à becs ronds

ergo®



### 4530



135



3 4530

Pinces à becs ronds, poignées bi-matière, ressort de rappel.



Pince à becs ronds



**C3530**

↔ L ↔	 
127	10 C3530
127	10 C3530IP

Pince à becs courts



**2646MS**

↔ L ↔	 
120	1 2646 MS

Pince à becs courts, poignées avec ressort de rappel, vis articulée.

**PINCES MULTIPRISE**

Pince multiprises ERGO™



**8223 - 8226**

↔ L ↔	 
210	4 8223
250	4 8224
315	4 8225
400	1 8226
210	4 8223 IP
250	4 8224 IP
315	4 8225 IP

Pince multiprises ERGO™





**8224/8225C**

↔ L ↔	 
250	4 8224CIP
315	4 8225CIP

Pince multiprises ERGO™, grande ouverture





**8231**

max	↔ L ↔	 
51	225	4 8231
51	225	4 8231 IP

Pince multiprises ajustement rapide



**7223-7225**



max	↔ L ↔	 
45	200	4 7223
63	250	4 7224
70	300	4 7225
45	200	8 7223IP
63	250	4 7224IP
70	300	4 7225IP



Pince multiprises ajustement rapide, poignées PVC



**7223D**

		
16	200	8 7223D
22	250	4 7224D
25	300	4 7225D
16	200	8 7223D IP
22	250	4 7224D IP
25	300	4 7225D IP

Pince multiprise à charnière entrepassée





**6224**

		
11	250	4 6224

Pince multiprises à charnière entrepassée, poignées PVC



**6221D-6225D**

		
6	125	10 6221D
8	150	10 6222D
10	200	8 6223D
11	250	5 6224D
13	300	5 6225D
6	125	10 6221D IP
8	150	10 6222D IP
10	200	8 6223D IP
11	250	5 6224D IP
13	300	5 6225D IP

Pince multiprises



**2971G**

		
35	250	5 2971G-250

Pinces multiprises, poignée bi-matière, articulation entre-passée.

Pince multiprises



**221 D - 225 D**

	
117	5 221 D
150	5 222 D
192	5 223 D
240	5 224 D
305	5 225 D

Pinces multiprises, poignées gainées PVC, becs parallèles.

Pince de connexion



**2650**

		
65	235	1 2650
	235	1 2650 B

## Jeu de 3 pinces multiprises à charnière entrepassée



### 622-3P

110 x 50 x 390 mm	3	1260	1 622-3P

6223D, 6224D, 6225D



## Jeu de pinces multiprises



### 7224-622XD-3P

75 x 50 x 260 mm	3	813	1 7224-622XD-3P

6221D, 6224D

7224



## PINCES À CIRCLIPS

### Pince à circlips intérieurs sans ressort



### 2800

8-13	0.8	140	3 2800-140
12-25	1.2	150	3 2800-150
19-60	1.7	180	3 2800-180

40-100	2.2	225	3 2800-225
85-165	3.1	310	1 2800-300

Pinces à circlips intérieurs sans ressort,  
poignées gainées PVC, bords droits, pointes usinées.

### Pince à circlips intérieurs sans ressort



### 2890

8-15	0.8	125	3 2890-125
12-25	1.2	140	3 2890-140
19-60	1.7	180	3 2890-180
40-100	2.2	210	3 2890-210
85-165	3.1	300	1 2890-300

Pinces à circlips intérieurs sans ressort,  
poignées PVC, bords courbés à 90°, pointes usinées.

### Pince à circlips intérieurs



### 2461

8-25	1.0-2.0	140	1 2461 C8
19-60	2.0-2.5	180	1 2461 C19
40-100	2.5-3.5	255	1 2461 C40

Pinces à circlips intérieurs,  
pointes usinées, bords droits.

### Pince à circlips intérieurs



### 2463

8-25	1.0-2.0	130	1 2463 D8
19-60	2.0-2.5	170	1 2463 D19
40-100	2.5-3.5	210	1 2463 D40

Becs phosphatés à 90°



## Pince à circlips extérieurs



**2900**

Ø	g	L	Q	Q
3-10	0.8	140	3	2900-140
10-25	1.2	150	3	2900-150
19-60	1.7	180	3	2900-180
40-100	2.2	215	3	2900-215
85-165	3.1	300	1	2900-300

Pinces à circlips extérieurs, poignées PVC, becs droits, pointes usinées.

## Pince à circlips extérieurs



**2990**

Ø	g	L	Q	Q
3-10	0.8	125	3	2990-125
10-25	1.2	140	3	2990-140
19-60	1.7	180	3	2990-180
40-100	2.2	200	3	2990-200
85-165	3.1	300	1	2990-300

Pinces à circlips extérieurs, poignées gainées PVC, becs courbés à 90°, pointes usinées.

## Pince à circlips extérieurs



**2464**

Ø	g	L	Q	Q
3-10	1.0-1.5	120	1	2464 A3
10-25	1.5-2.0	120	1	2464 A10
19-60	2.0-2.5	180	1	2464 A19
40-100	2.5-3.0	210	1	2464 A40

Becs droits phosphatés  
Vis d'arrêt, ouverture de ressort.

## Pince à circlips extérieurs



**2466**

Ø	g	L	Q	Q
3-10	1.0-1.5	130	1	2466 B3
10-25	1.5-2.0	130	1	2466 B10
19-60	2.0-2.5	165	1	2466 B19
40-100	2.5-3.0	190	1	2466 B40

Pinces à circlips extérieurs, becs à 90° phosphatés noirs, vis d'arrêt, ouverture du ressort.

## Pince à circlips intérieurs et extérieurs



**2928**

Ø	Ø	L	Q	Q
7-26	3-26	160	1	2928-160
10-51	7-51	200	1	2928-200
46-102	32-102	250	1	2928-250

Pinces à circlips intérieurs et extérieurs, becs interchangeables, mécanisme de butée réglable.

## Becs de rechange pour pinces à circlips



**1/4/28**

Q	Q
2928-160	1 2928-1
2928-200	1 2928-2
2928-250	1 2928-3
2928-250	1 2928-4

Becs de rechange pour pinces à circlips

## Pince à circlips extérieurs



**2460**



175

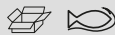

1 2460

Pinces à circlips extérieurs, ressort d'ouverture.

## Pince à circlips spéciales



**2465D**



200



1 2465D-200

Pinces à circlips spéciales, ressort d'ouverture.

## Jeu de pinces circlips



**28-29/S4**



740



1 28-29/S4

Jeu de pinces circlips

2900-180



2800-180



2990-180



2890-180



## Jeu de pinces à circlips réversibles Pinces à circlips



**9938**



1640



1 9938

Pinces à circlips réversibles,  
becs interchangeables, mécanisme de butée réglable.

2928-160, 2928-200, 2928-250



## PINCES À DÉNUDER ET OUTILS DE DEMONTAGE

Pince à dénuder  
Fil de cuivre et câble

ergo®



**2223G**



0.5-5



165



5 2223 G-150

Pinces à dénuder, poignées bi-matière ERGO™,  
avec ou sans ressort de rappel.

Pince à dénuder chromée  
Cuivre

ergo®



**2223GC**



0.5-5



165



5 2223GC-150

Pinces à dénuder, poignées ERGO™ bi-matière,  
ressort de rappel.



Pince à dénuder  
Fil de cuivre et câble



**2223D**

0,5-5	165	5	2223 D-150

Pinces à dénuder, poignées gainées PVC.

Pince à dénuder automatique



**3418 A**

20-10 AWG	0,5-6 mm <sup>2</sup>	3 mm	160	1	3418 A

Pince à dénuder automatique



**3416 A**

0,2-6 mm <sup>2</sup>	24-10 AWG	1	3416 A 1 3416 A SH

Pince à dénuder pour câble coaxial



**3417 A**

4,8-7,5	110	12 3417 A

Pince à dénuder automatique



**3416 B**

0,02-10 mm <sup>2</sup>	34-8 AWG	10	3416 B 10 3416 B SH

Outil à dégainer les câbles plats et ronds



**3517 A**

6-13 mm	120	1 3517 A

Dénudeur de gaines  
Lame de rechange : 3518ASH



**3518 A**

4-28 mm	185	1 3518 A 1 3518 A SH

Dénudeur universel avec couteau rétractable



**3518 B**

0,5-6 mm <sup>2</sup>	125	1 3518 B

Dénudeur de gaines  
3519ASH lame droite, 3519ASHB lame courbe



**3520 A**

0,5-6 mm <sup>2</sup>	1 3520 A 1 3520 A SH

Dénudeur de gaines



**3520 B**

10 3520 B 10 3520 B SH

Pince à dénuder de précision pour câbles multiconducteurs



**3619 A**

10 3619 A 10 3619 A SH

Pince à ajuster d'électricien



**3419 B**

0.25-6.00 mm	1 3419 B 1 3419 EB



## PINCES À CRÉMAILLÈRE

Pince pour cosses isolées



### CR B 01

0.50-6.00	20-10	0.75-6.00	220	5 CR B 01

Pince pour cosses non isolées



### CR B 02

0.75-6.00	1.50-6.00	14-10 220	5 CR B 02

Pince pour cosses non-isolées  
Type "Faston"



### CR B 03

0.75-6.00	1.50-6.00	14-10	220	5 CR B 03

Pince pour cosses cylindriques



### CR B 05

0.5-2.5	20-14	140	2 CR B 05

Pince pour cosses cylindriques



### CR B 06

0.5-16	20-6	220	2 CR B 06

Pince à crémaillère à débrayage  
Pour cosses isolées



### CR W 01

0.5-6.0	20-10	225	1 CR W 01



Pince à crémaillère à débrayage  
Pour cosses non isolées



**CR W 02**



Pince à crémaillère à débrayage  
Pour cosses cylindriques



**CR W 05**

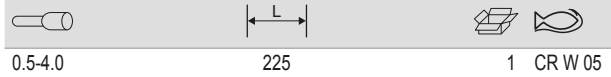

Pince à crémaillère à débrayage pour cosses isolées



**CR W 03**

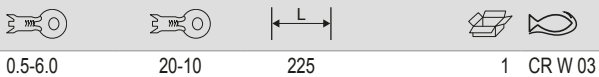

Pince à crémaillère à débrayage  
Pour cosses cylindriques



**CR W 06**

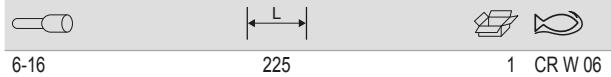

Pince à crémaillère à débrayage pour cosses de câbles  
coaxial BNC-TNC



**CR W 04**

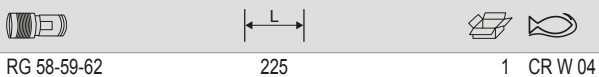

Pince à sertir  
Les connecteurs de téléphone de 4, 6 et 8 pôles



**CR W 07**



Presse à cosses  
Non-isolées



**CR L 01**

10-120	10-95	600	1	CR L 01

Presse à cosses  
Non-isolées



**CR L 02**

6-50	360	1	CR L 02

Presse à cosses  
Non-isolées



**CR L 03**

25-150	650	1	CR L 03

**JEUX DE PINCES**

Jeu de pinces de mécanique de précision

ergo®



**9733**

30 x 215 x 215 mm	8	1	9733

4130, 4131	
4239	
4830	
4530	
4231	
4430	
4833	

Jeu de 3 pinces de précision



**C3901/3**

3	1	C3901/3

C3140IP	
C3640IP	
C3830IP	

Jeu de 3 pinces de précision



**C3902/3**



3

1 C3902/3

C3330R

C3840

C3745



Pack 9031-8224



**9031-8224**



2

693

3 9031-8224

9031

8224



Jeu de pinces



**9873**



25 x 190 x 280 mm

2

1 9873

9072 P

8224



Jeu d'outils en boîte carton



**9853**



25 x 252 x 292 mm

3

1 9853

9071

2101G-160

8224



Jeu de pinces



**9897**



4

1030

1 9897

8224

2628 G-180

2101G-160

2430 G-160



## PINCES-ÉTAUX

### Pince coupe-fil



**2951**

Longueur (mm)	Quantité	Code produit
140	1	2951-140
190	1	2951-180
235	1	2951-250
300	1	2951-300

Pinces-étaux, avec coupe-fil, becs coudés multi-fonctions.

### Pince étau à bec coudé sans coupe-fil



**2953**

Longueur (mm)	Quantité	Code produit
140	1	2953-140
190	1	2953-200
235	1	2953-250
300	1	2953-300

Pinces étaux à becs coudés sans coupe-fil

### Pince-étau à mors droit



**2958**

Longueur (mm)	Quantité	Code produit
135	1	2958-140
190	1	2958-200
235	1	2958-250

Pinces-étaux à mors droits pour un usage multi-fonctions.

### Pince-étau, à mors larges



**2968**

Longueur (mm)	Quantité	Code produit
205	1	2968-190
235	1	2968-235

Pince-étau, à mors larges, avec coupe-fil, mâchoire inférieure convexe.

### Pince-étau multifonctions



**2957**

Longueur (mm)	Quantité	Code produit
250	1	2957-250

Pinces-étaux multifonctions.

### Pince-étau à bec long



**2952**

Longueur (mm)	Quantité	Code produit
155	1	2952-165
230	1	2952-235

Pinces-étaux à becs longs, mâchoires longues et minces, section courbée.

Pince-étau pour la tôle



**2967**



180



1 2967-180

Pince-étau pour la tôle.

Pince-étau à chaîne coupe-tubes  
2998-SH : chaîne



**2998**



240



1 2998-SHN  
1 2998-250

Pince-étau à chaîne coupe-tubes.

Pince-étau à bec parallèle



**2955**



235



1 2955-250

Pincés-étaux à bocs parallèles avec mâchoire articulée, mors plats.

Pince étau pour table



**2960**



1 2960-280

Pince-étau à chaîne



**2999**



230



1 2999-SHN  
1 2999-250

Pince-étau à col de cygne



**2963**



283  
458  
580



1 2963-280  
1 2963-450  
1 2963-630

Pince-étau à col de cygne.



Pince-étau à col de cygne, mors parallèles



**2964**



175	1	2964-160
280	1	2964-280
436	1	2964-450
625	1	2964-600

Pince-étau à col de cygne, mors parallèles.

Pince étau à bec parallèle



**2950**



235	1	2950-250
-----	---	----------

Pincés étaux à becs parallèles, profil de mâchoires étroites.

Pince étau fine avec becs pivotants



**2956**



282	1	2956-290
-----	---	----------

Pince étau en C



**2962**



290	1	2962-8-150
290	1	2962-8-230
290	1	2962-8-300

Pince-étau forme U



**2965**



228	1	2965-200
290	1	2965-280

Pince-étau pour tubes



**2966**



290	1	2966-280
-----	---	----------

Pince-étau pour tubes en forme de U pour tuyaux et tubes.

Pièce de rechange pour pince étou



**2951-S**



- 1 2951-S05
- 1 2951-S07
- 1 2951-S10
- 1 2951-S12

Pince-étaux à crémaillère, longues mâchoires, 4 positions



**2997**



255

- 5 2997-300

Pince-étaux à crémaillère, longues mâchoires, 4 positions.

Pince-étou à crémaillère, mâchoires courtes, 4 positions



**2997-250**



235

- 1 2997-250

Pince-étou à crémaillère, mâchoires courtes, 4 positions.

Pince-étou, serre-joints à simple vis



**2949**



- 193
- 196
- 240
- 240

- 1 2949-190IP
- 1 2949-200IP
- 1 2949-240IP
- 1 2949-250IP

Pince-étou, serre-joints à simple vis, mâchoire mobile.

Boulon de rechange pour pinces-étaux



**2949-L**



- 2949-190IP 75 mm
- 2949-200IP, 2949-240IP 120 mm
- 2949-250IP 200 mm

- 1 2949-L075
- 1 2949-L120
- 1 2949-L200

Ecou de rechange pour pinces-étaux



**2949-NUT**



M12 - L4

2949

- 1 2949-NUT



Empiècement de rechange pour pinces-étaux



**2949-YOKE**



1 2949-YOKE

Pince crantée  
0



**2690**



200



10 2690

## PINCES À RIVETER

Pince à riveter



**2681**



285



12 2681

Pince à riveter à deux mains  
Capacité : 3-6.40 mm



**1467-520**



530



1 1467-520

Pince à riveter  
Capacité 2,4 - 5 mm



**1467-250**



255



1 1467-250

Riveteuse extensible, mm



**1467-320-850**



320-850





1 1467-320-850



Pièces détachées pour riveteuses 1467



**1467**

**g**  

10	1	1467-LJ
10	1	1467-SJ
10	1	1467-L3,2
5	1	1467-S2,4
5	1	1467-L4
5	1	1467-S3,2
5	1	1467-L5
5	1	1467-S4
5	1	1467-L6
5	1	1467-S5
5	1	1467-L6,4
10	1	1467-B14

Jeu de pièces de rechange pour 2681



**2681-1**

**g**  



15	1	2681-1
----	---	--------

**PINCES SPÉCIALES**

Pince à colliers



**790450A**



  

<2.2x5 mm	1	790450A
-----------	---	---------

Pince à colliers



**790455A**



  

<9.5x2.3 mm	1	790455A
-------------	---	---------

Pince à freiner



**2855**



  

236	1	2855
287	1	2855 D

Pince à freiner, utilisation à une main



**2856**

203	1	2856-8
268	1	2856-10





**BAHCO**



## Serre-tubes et outillage pour tubes



## CLÉS SERRE-TUBES

Clé serre-tube ajustement rapide

ergo®



### 1610/1620

L	max		
320	1 in	1	1610
430	1 1/2 in	1	1620

10 fois plus rapide que les modèles standards

Écrou de rechange pour clés serre-tube ajustement rapide



### 1610-nut/1620-nut

Ø	g		
11 mm	34	1	1610-NUT
11.5 mm	48	1	1620-NUT

Clé serre-tubes modèle suédois

ergo®



### 1410/1420

L	max		
320	1	1	1410
430	1 1/2	1	1420

Clé serre tube ERGO™ avec poignée bi matière



### 1410D/1420D

L	max		
320	1 in	1	1410D
430	1 1/2 in	1	1420D

Clé serre-tubes universelle



### 140-147

L	max		
210	3/4	1	140
320	1	1	141
426	1 1/2	1	142
557	2 1/2	1	143
722	3 1/2	1	144
1060	5	1	147

Clé serre-tubes modèle suédois chromées

ergo®



### 1175

L	max		
320	1	1	1175-1
430	1 1/2	1	1175-11/2

Clé serre-tubes universelle



### DOW175

L	max		
310	1	1	DOW 175-1
420	1 1/2	1	DOW 175-11/2
560	2	1	DOW 175-2
630	3	1	DOW 175-3

Clé serre-tubes à tête inclinée



### 442 B-444 B

L	max		
320	1	1	442 B
430	2	1	443 B
545	2 1/2	1	444 B

Clé serre-tubes universelle



### 341-344

L	max		
230	1/2	1	341
330	1	1	342
420	1 1/2	1	343
530	2	1	344

Clé serre-tubes universelle



**DOW177**

L	max		
325	1	1	DOW 177-1/2-1
425	1 1/2	1	DOW 177-11/2
534	2	1	DOW 177-2

Paire de mâchoires pour clés à pipe en aluminium



**8100B**

	g		
380-10	220	1	8100B0100
380-14	430	1	8100B0140
380-18	680	1	8100B0180
380-24	1000	1	8100B0240
380-36	1810	1	8100B0360
380-48	3200	1	8100B0480

Clé Stillson



**361**

L	max		
185	1 in	1	361-8
230	1.1/2 in	1	361-10
265	1.3/4 in	1	361-12
315	2 in	1	361-14
450	2.1/2 in	1	361-18
535	3 in	1	361-24
900	4 in	1	361-36

Clé serre-tubes à tête inclinée



**DOW176**

L	max		
330	1	1	DOW 176-1
415	1 1/2	1	DOW 176-11/2
530	2	1	DOW 176-2

Mâchoire de rechange fixe en Aluminium pour clés à pipe



**8100F**

	g		
380-10	30	1	8100F0100
380-14	30	1	8100F0140
380-18	90	1	8100F0180
380-24	180	1	8100F0240
380-36	226	1	8100F0360
380-48	380	1	8100F0480

Paire de mâchoires pour clés Stillson



**8060B**

	g		
361-8	80	1	8060B0080
361-10	200	1	8060B0100
361-12	270	1	8060B0120
361-14	330	1	8060B0140
361-18	520	1	8060B0180
361-24	970	1	8060B0240
361-36	1630	1	8060B0360

Clé à crémaillère en aluminium /380



**380**

L	max		
253	1.1/2 in	1	380-10
320	2 in	1	380-14
455	2.1/2 in	1	380-18
607	3 in	1	380-24
910	4 in	1	380-36
1210	6 in	1	380-48

Écrou de rechange pour clés serre-tubes en aluminium



**8100T**

	g		
380-10	30	1	8100T0100
380-14	45	1	8100T0140
380-18	70	1	8100T0180
380-24	110	1	8100T0240
380-36	220	1	8100T0360

Écrou de rechange pour clés Stillson



**8060T**

	g		
361-8	20	1	8060T0080
361-10	20	1	8060T0100
361-12	20	1	8060T0120
361-14	40	1	8060T0140
361-18	70	1	8060T0180
361-24	90	1	8060T0240
361-36	250	1	8060T0360



### Clé à chaîne



#### 372

Length (mm)	Icon	Quantity	Part Number
1.1		1	372-1.1/2
2.1		1	372-2.1/2
4		1	372-4
6		1	372-6
8		1	372-8
12		1	372-12

### Chaîne de rechange pour clés à chaîne



#### 3074

Length (mm)	Icon	Quantity	Part Number
340		1	307401B
475		1	307411B
560		1	307421B
830		1	307431B
1000		1	307441
1400		1	307451

### Clé à chaîne



#### 370

Length (mm)	Icon	Quantity	Part Number
300		1	370-4

### Clé à sangle



#### 375

Length (mm)	Icon	Quantity	Part Number
300		1	375-8

### Clé à écrous de lavabo



#### 363

Length (mm)	Icon	Quantity	Part Number
280		1	363-32

## OUTILS DE COUPE DE TUBES

### Coupe-tubes amélioré 16 mm



#### 401-16

Length (mm)	Icon	Quantity	Part Number
3-16 mm		12	401-16

### Coupe-tubes amélioré 28 mm



#### 401-28

Length (mm)	Icon	Quantity	Part Number
3-28 mm		12	401-28

### Coupe-tubes amélioré 35 mm



#### 402-35

Length (mm)	Icon	Quantity	Part Number
3-35 mm		6	402-35

### Coupe-tubes amélioré 76 mm



#### 402-76

Length (mm)	Icon	Quantity	Part Number
12-76 mm		6	402-76

Coupe-tubes automatique



**-306**

Ø	Icon	QTY	Model
10		1	306-10
12		1	306-12
15		12	306-15
22		12	306-22

Coupe tubes



**301-16**

Ø	L	Icon	QTY	Model
3-16 mm	72		12	301-16

Mini Coupe-tubes



**301-22**

Ø	Icon	QTY	Model
3-22		12	301-22

Coupe-tubes télescopique



**302-35**

Ø	Icon	QTY	Model
8-35		6	302-35

Coupe tubes avec système d'ajustement rapide



**302-76N**

Ø	L	Icon	QTY	Model
12-76 mm	318		6	302-76N

Lame de rechange pour coupe-tubes



**306-15-95**

g	Icon	QTY	Model
10		1	306-15-95

Jeu de roues et goupille de rechange pour coupe-tubes 301/302 - 4 pcs



**302-95-SET**

g	Icon	QTY	Model
30		1	302-95-SET

Lames et tige de rechange pour coupe-tubes 401/402



**402-95-SET**

g	Icon	QTY	Model
30		1	402-95-SET

Coupe-tubes pour le plastique



**411**

Ø	Icon	QTY	Model
26 mm		4	411-26
35 mm		4	411-35
42 mm		6	411-42
63 mm		5	411-63

Coupe-tubes pour polyéthylène réticulé (PER)



**412-28-PEX**

Ø	Icon	QTY	Model
28 mm		5	412-28-PEX

Coupe-tubes pour plastique multicouches



**412-26-MULTI**

Ø	Icon	QTY	Model
26 mm		5	412-26-MULTI



Lames de rechange pour ciseaux pour plastique



**411-95**

Icon	g	Icon	Icon
1	39	50	411-26-95
1	37	50	411-35-95
1	41	50	411-42-95
1	48	30	411-63-95

Lames de rechange pour 412-28-PEX



**412-28-PEX-95**

Icon	g	Icon	Icon
1	35	30	412-28-PEX-95

Lames de rechanges pour 412-26-MULTI



**412-26-MULTI-95**

Icon	g	Icon	Icon
1	10	150	412-26-MULTI-95

**OUTILS DE CINTRAGE ET DE FORMAGE**

Pince à cintrer



**1084**

Icon	Icon	Icon	Icon
250	6,8 10 mm	5	1084

Cintreuse pour tubes



**500**

Icon	Icon	Icon	Icon
12 mm	1	500-12	
14 mm	1	500-14	
15 mm	1	500-15	
16 mm	1	500-16	
18 mm	1	500-18	
22 mm	1	500-22	

Outil à évaser, dimensions métriques  
8 dimensions . 4, 6,8,10,12,14,16 & 18 mm



**4480MM**

Icon	Icon	Icon	Icon
45	4, 6, 8, 10, 12, 14, 16, 18	1	4480MM

Outil à évaser, dimensions en pouces  
8 tailles : 3/16" -1/4"-5/16"-3/8 7/16"-1/2"-5/8"-3/4"



**4480IM**

Icon	Icon	Icon	Icon
45	5/8, 3/16, 1/4, 5/16, 3/8, 7/16, 1/2, 3/4	1	4480IM

Coupe-tubes



**4480/**

Icon	Icon	Icon	Icon
45 x 140 x 330 mm	1	4480/2-ZD	

**OUTILS D'ÉBAVURAGE**

Ebavureur crayon



**316-1**

Icon	Icon	Icon	Icon
143	12	316-1	



Crayon ébavureur pour tubes et tuyaux



**316-2**



150



12 316-2

Ebavureur : lame de rechange



**316-2-95**



3



1 316-2-95

Ebavureur interne-externe



**318-38/318-54**



10-54 mm



1 318-54

Ebavureur interne-externe



**317-40**



3-40 mm



12 317-40





**BAHCO**



## Outils pneumatiques



## CLÉS À CHOCS

Mini clé à choc papillon 3/8"





**BP704**

**BAR**     
6.3 bar 1500 min 1 BP704

Clé à chocs composite 3/8"



**BPC816**

**BAR**     
12.000 6,3 10 BPC816

Clé à choc à renvoi d'angle carré 1/2"





**BP814A**

**BAR**     
7000 min 6.2 bar 10 BP814A

Clé à choc 1/2"





**BP814**

**BAR**     
10,000 6.3 10 BP814

Clé à chocs pneumatique 1/2"



**BP815**

**BAR**     
7,000 6.3 1 BP815

Coffret clé à choc pneumatique 1/2"  
1 clé à choc pneumatique + 11 douilles à choc (10-24 mm) + 1 connecteur male 1/4"



**BP815K1**

**BAR**     
7,000 6.3 1 BP815K1

**BP815**

K7800M-10, K7800M-11, K7800M-12,  
K7800M-13, K7800M-14, K7800M-15,  
K7800M-17, K7800M-19, K7800M-22,  
K7800M-24, K7800M-21

PM5142

Coffret clé à choc pneumatique 1/2"  
1 clé à choc pneumatique 1/2" + support magnétique +  
3 douilles (17, 19 et 21 mm)



**BP815K2**

**BAR**     
7,000 6.3 1 BP815K2

Micro clé à choc 1/2"





**BPC813**

**BAR**     
10000 min 6,3 bar 10 BPC813

Coffret clé à choc 1/2" courte



**BPC813K1**

     
1/2 in 65 x 162 x 215 mm 1 BPC813K1

**BPC813**

K7800M-13, K7800M-14, K7800M-16,  
K7800M-17, K7800M-19, K7800M-21,  
K7800M-22, K7800M-24

Mini clé à choc composite 1/2"  
Format (taille) et poids identiques à la 3/8"



**BPC814**

	<b>BAR</b>		
12000 min	6,3 bar	10	BPC814

Clé à choc composite 1/2"



**BPC815**

	<b>BAR</b>		
8000 min	6,3 bar	1	BPC815

Coffret clé à choc 1/2"



**BPC815K1**

1/2 in	90 x 230 x 390 mm	1	BPC815K1

<b>BPC815</b>		
K7801M-10, K7801M-11, K7801M-12, K7801M-13, K7801M-14, K7801M-15, K7801M-17, K7801M-19, K7801M-21, K7801M-22, K7801M-24		

Coffret clé à choc 1/2"



**BPC815K2**

1/2 in	90 x 230 x 320 mm	1	BPC815K2

<b>BPC815</b>		
K7801M-19, K7801M-22, K7801M-24, K7801M-17, K7801M-13		

Coffret clé à choc 1/2"



**BPC815K3**

1/2 in	90 x 230 x 320 mm	1	BPC815K3

<b>BPC815</b>		
K7801Z-1/2, K7801Z-5/8, K7801Z-3/4, K7801Z-7/8, K7801Z-15/16		

Coffret clé à choc 1/2"



**BPC815K4**

1/2 in	90 x 230 x 320 mm	1	BPC815K4

<b>BPC815</b>		
BWSS12P5		

Coffret clé à choc 1/2"



**BPC815K6**

1/2 in	90 x 230 x 320 mm	1	BPC815K6

<b>BPC815</b>		
BWSS12P319, BWSS12P317		

Clé à chocs pneumatique 3/4"



**BP817**

	<b>BAR</b>		
4,500	6,3	1	BP817

Clé à choc composite 3/4"



**BPC817**

	<b>BAR</b>		
5000 min	6,2 bar	4	BPC817



Coffret clé à choc 3/4"



**BPC817K1**

3/4" mm	105 x 295 x 390 mm	1 BPC817K1

<b>BPC817</b>	
K8901M-24, K8901M-27, K8901M-32, K8901M-30	

Coffret clé à choc 3/4"



**BPC817K2**

3/4 in	105 x 295 x 390 mm	1 BPC817K2

<b>BPC817</b>	
K8901Z-15/16, K8901Z-1, K8901Z-1.1/16, K8901Z-1.1/8	

Clé à chocs pneumatique 1"



**BP901**

	<b>BAR</b>	
3800 min	6.2 bar	1 BP901

Clé à chocs 1" broche longue



**BP901L**

	<b>BAR</b>	
3800 min	6.2 bar	1 BP901L

Clé à choc pneumatique 1" légère version pistolet



**BP905P**

	<b>BAR</b>	
6000 min	6.2 bar	2 BP905P

Clé à choc pneumatique 1" légère



**BP905S**

	<b>BAR</b>	
6000 min	6.2 bar	2 BP905S

Clé à choc pneumatique 1" légère enclume longue



**BP905L**

	<b>BAR</b>	
6000 min	6.2 bar	2 BP905L

Protection caoutchouc pour clé à choc  
BPM91BS- BPM914 - BPM916



**BPM91B**

85 x 80 x 180 mm	162 g	1 BPM91BOOT

Kit silencieux pour clé à chocs



**BPM91MK**

30 x 25 x 25 mm	5 g	1 BPM91MK1
30 x 25 x 50 mm	10 g	1 BPM91MK2

**CLIQUETS**

Clé à rochet 1/4"



**BP700**

	<b>BAR</b>	
300 min	6.3 bar	20 BP700

Clé à rochet 3/8"



**BP721**

	<b>BAR</b>	
6.3 bar	350 min	1 BP721

Clé à rochet 3/8"



**BP820**

	<b>BAR</b>		
270	6.3	1	BP820

Clé à rochet 1/2"



**BP821**

	<b>BAR</b>		
150	6.3	1	BP821

Clé à rochet 1/2" sans couple de réaction



**BPR821**

	<b>BAR</b>		
6.3 bar	600 min	1	BPR821

Protection caoutchouc pour clé à rochet  
BP91BS - BP919 - BP920



**BP91B**

35 x 40 x 60 mm	12	1	BP91BL
30 x 30 x 45 mm	6	1	BP91BS

**MEULEUSES, PONCEUSES ET  
POLISSEUSES**

Disqueuse d'angle 6mm



**BP115**

	<b>BAR</b>		
20,000	6.3	1	BP115

Meuleuse à faible rotation par minute



**BP117**

	<b>BAR</b>		
2500	6.3	1	BP117

Meuleuse à faible rotation par minute avec mandrin  
verrouillé



**BP118**

	<b>BAR</b>		
2500	6.3	1	BP118

Mini meuleuse 6 mm



**BP822**

	<b>BAR</b>		
25,000	6.3	1	BP822

Meuleuse 6 mm



**BP822E**

	<b>BAR</b>		
25000	6.3	10	BP822E

Meuleuse abrasive



**BP420M**

67	25	1	BP420M

Meuleuse abrasive



**BP421M**

53	14	1	BP421M

Meuleuse Abrasive



**BP422M**

46	26	1	BP422M



Meuleuse abrasive



**BP423M**

53	25	1	BP423M

Meuleuse abrasive



**BP424M**

57	19	1	BP424M

Meuleuse abrasive



**BP430M**

55	12	1	BP430M

Meuleuse abrasive



**BP431M**

54	13	1	BP431M

Meuleuse abrasive



**BP432M**

44	15	1	BP432M

Meuleuse abrasive



**BP433M**

43	14	1	BP433M

Meuleuse abrasive



**BP434M**

45	13	1	BP434M

Decoupeur pneumatique 3"/75mm



**BP110**

	<b>BAR</b>		
18,000	6.3	1	BP110

Disqueuse pneumatique 5"



**BP823**

	<b>BAR</b>		
10,000	6.3	1	BP823

Disqueuse pneumatique rallongée 4" / 102 mm



**BP111E**

	<b>BAR</b>		
15000	6.3	12	BP111E

Tuyaux d'échappement pour meuleuse



**BP117EH**

50 x 100 x 50 mm	1	1	BP117EH

Derouilleur pneumatique



**BP127**

	<b>BAR</b>		
3700	6.3	1	BP127



Dérouilleur à aiguilles avec 19 aiguilles



**BP127P**

**BAR**



6.3 bar 3800 min 1 BP127P

Brosse métallique inclinée grossière



**BP830CISB**



BP830K 105 mm 1 BP830CISB

Coffret brosseuse pneumatique



**BP830K**

**BAR**



6.3 bar 4000 min 4 BP830K

Roue gomme à base de solvant



**BP830ESB**



30 mm 105 mm 1 BP830ESB

Roue gomme à base d'eau



**BP830EWB**



BP830K 105 mm 1 BP830EWB

Brosse métallique inclinée moyenne



**BP830MISB**



BP830K 105 mm 1 BP830MISB

Adaptateur pour brosse métallique droite pour BP830K



**BP830SBA**



BP830K 105 mm 1 BP830SBA

Brosse métallique droite pour BP830K



**BP830SSB**



BP830K 105 mm 1 BP830SSB

Roue de dénudage



**BP830SW**



BP830K 105 mm 1 BP830SW

Coffret ponceuse/meuleuse



**BP204K**



**BAR**



15000 6.3 1 BP204K

BP20425180, BP20410800, BP20410320, BP20425220

BP204



Pad pour ponceuse



**BP204PAD**

77	-	1	BP204PAD

Ponceuse pneumatique orbitale 5 mm



**BP601**

	<b>BAR</b>		
152	6.3	1	BP601

Disques de ponçage  
Packs de 10 ou 25 pcs



**BP204xxyyy**

77	1	BP20410320
77	1	BP20410800
77	1	BP20425180
77	1	BP20425220

Ponceuse pneumatique a bande 10 mm



**BP212**

	<b>BAR</b>		
	16,000	6.3	1
			BP212

Plateaux velcro 53 trous



**BP60102**

BP601	152 mm	1	BP60102

Ponceuse pneumatique à bande 20 mm



**BP222**

	<b>BAR</b>		
	16,000	6.3	1
			BP222

Plateau pour ponceuse Orbitale



**BP51137**

152	x	1	BP51137

Ponceuse/Meuleuse



**BP204**

	<b>BAR</b>		
	15000	6.3	1
			BP204

Ponceuse pneumatique orbitale 2,5 mm



**BP610**

	<b>BAR</b>		
152	6.3	1	BP610

Kit de 25 bandes avec grain 80/100



**BPN22201/21201**

10	1	BPN21201
20	1	BPN22201

Bonnet de laine 7"



**BP80950**

178	15	1	BP80950

Perceuse pneumatique réversible 3/8" - 200 tours/min



**BPC823**

<b>BAR</b>			
6.3 bar	2000 min	1	BPC823

Polisseuse d'angle 7"



**BP809**

	<b>BAR</b>		
2500	6.3	1	BP809

## PERCEUSES ET VISSEUSES

Perceuse pneumatique réversible 13 mm



**BP825**

	<b>BAR</b>		
450	6.3	1	BP825

Perceuse pneumatique angulaire 3/8" - 1400 tours/min



**BPA823**

<b>BAR</b>			
6.3 bar	1400 min	1	BPA823

Polisseuse verticale 7"



**BP810**

	<b>BAR</b>		
2500	6.3	1	BP810

Perceuse pneumatique réversible 1/2" - 800 tours/min



**BPC825**

<b>BAR</b>			
6.3 bar	800 min	1	BPC825

Pistolet tournevis réversible 1.800 TPM



**BP826**

	<b>BAR</b>		
1800	6.3	1	BP826



Pistolet tournevis réversible 800 TPM



**BP827**

	<b>BAR</b>		
800	6.3	1	BP827

## OUTILS DE COUPE

Scie sabre pneumatique compacte avec gâchette de sécurité



**BP828**

	<b>BAR</b>		
6.3 bar	10000 min	1	BP828

Scie sabre pneumatique



**BP824**

	<b>BAR</b>		
10,000	6.3	1	BP824

Scie sabre pneumatique à engrenage



**BPG824**

	<b>BAR</b>		
6.3 bar	7400 min	10	BPG824

Décolleur de pare-brise pneumatique



**BP233**

	<b>BAR</b>		
20	6.3	1	BP233

Lames droites  
A : Lisse



**BPBG**

15	1	BPBG3515
25	1	BPBG3525A
25	1	BPBG3525B

Couteau forme virgule



**BPBK**

30	1	BPBK30

Grattoir



**BPBSC**

15	1	BPBSC156

Couteau forme U



**BPBU**

18	1	BPBU18
24	1	BPBU24
36	1	BPBU36
60	1	BPBU60
90	1	BPBU90

Cisaille pneumatique  
capacité de coupe 1.6 mm Aluminium / 1.2 mm Acier



**BP811**

	<b>BAR</b>		
2,600	6.3	1	BP811

Couteau



**BPBG5725/9057**

57	1	BPBG5725
90	1	BPBG9057

## MARTEAUX, RIVETUSES ET MARQUEURS

Marteau burineur 3200 bpm



**BP910**

**BAR**



3200



5 BP910

6.3 bar

Ciseau, tournant, plat, 10,2 mm



**BP909TF**



170



1 BP909TF

Ciseau, tournant, plat large, 10,2 mm



**BP909TWF**



170



1 BP909TWF

Ciseau, tournant, poinçon pointu, 10,2 mm



**BP909TTP**



165



1 BP909TTP

Ciseau, tournant, griffe, 10,2 mm



**BP909TE**



139



1 BP909TE

Ciseau, tournant, marteau, 10,2 mm



**BP909TH**



108



1 BP909TH

Ciseau, tournant, poinçon droit, 10,2 mm



**BP909TSP**



165



1 BP909TSP

Ciseau, fixe, plat, 10,2 mm



**BP909NF**



190.5



1 BP909NF

Ciseau fixe, griffe, 10,2 mm



**BP909NE**



173



1 BP909NE

Riveteuse pneumatique, 880 kg de force de traction



**BP277K**

**BAR**



14



8 BP277K

6.3 bar

Riveteuse pneumatique, 1600 kg de force de traction



**BP125A**

**BAR**



19



6 BP125A

6.3 bar



Marqueur pneumatique



**BP799**

	<b>BAR</b>		
13,000	6.3	1	BP799

Pointe à graver



**BP79912**

10	1	BP79912

Pistolet de colmatage  
Cartouche applicateur 310 ml



**BP215A**

<b>BAR</b>		
3.5-4.8 bar	10	BP215A

**PISTOLETS À PEINTURE**

Pistolet a peinture



**BPHVLP01**

	<b>BAR</b>		
0.7	2-2.8	1	BPHVLP01

Jeu de buses



**BPHVLP**

1.2	1	BPHVLP0112
1.4	1	BPHVLP0114
1.7	1	BPHVLP0117
2.0	1	BPHVLP0120

**OUTILS DE NETTOYAGE ET DE SOUFFLAGE**

Soufflette



**BP218**

<b>BAR</b>		
6.3	1	BP218

Soufflette



**BP219**

<b>BAR</b>		
6.3	1	BP219

Pistolet à air comprimé avec long bec  
Longueur du bec 330mm



**BP219L**

<b>BAR</b>		
6.3	1	BP219L

Soufflette pneumatique longue, 1 mètre



**BP219XL**

<b>BAR</b>			
6.3 bar	10 l/min	10	BP219XL

Aspirateur et pistolet à air comprimé avec têtes interchangeables



**BP219V**

<b>BAR</b>		
6.3	1	BP219V

Pistolet de nettoyage



**BPN010**

**BAR**



6.2 6000-7500 1 BPN010

## ACCESSOIRES ET ÉQUIPEMENTS D'OUTILS PNEUMATIQUES

Support magnétique pour clés à chocs



**BP500**

**kg**



0.380 1 BP500

Filtere à air - Régulateur  
Capacité 200 cc



**BP254**



**BAR**

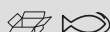

max 3800 L/min 1-8.5 1 BP254

Filtere à air - Régulateur - Lubrificateur  
Capacité 200 cc



**BP255**



**BAR**



max 3,800 1-8.5 1 BP255

Mini huileur



**BPN251**



**kg**



1/4" 0.100 1 BPN251

Filtere à air-régulateur-lubrificateur 1/2" avec option  
sortie air sec



**BP255T**

**BAR**



1-8.5 bar max 3800 l/min 1 BP255T

Sortie air sec 1/2" supplémentaire pour filtre à air-  
régulateur-lubrificateur



**BP255T-1**

**BAR**



1-8.5 bar max 3800 l/min 1 BP255T-1

Tuyaux spirales



**BPH1010**



1/4"-1/4" NPT in 10 1 BPH1010A  
1/4"-1/4" BSP in 10 1 BPH1010B

Enrouleur pneumatique



**BPHRC815/1015**



8 15 m 1 BPHRC815  
10 14+1 m 1 BPHRC1015

Tuyaux spirales 13 mm



**BPH1310**

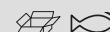

1/2"-1/2" in 10 1 BPH1310A



Adaptateur de contrôle de vitesse pour enrouleur



**BPHRSC**



76 x 88 x 114 mm



1 BPHRSC

Connecteur à air femelle 1/4"



**BPQCF14**



1/4"



10 BPQCF14

Enrouleur pneumatique



**BPHRC1020/1316**



10	20 m	1 BPHRC1020
13	15+1 m	1 BPHRC1316

Raccord d'air pivotant 1/4"



**BPSJ**



1/4" in



1 BPSJ

Enrouleur pneumatique



**BPHRO1315**



13	13+2	1 BPHRO1315
----	------	-------------

Raccord d'air pivotant 1/4" avec système de verrouillage



**BPSJL**



1/4" in



1 BPSJL





# Outils énergisés sans fils



## CLÉS À CHOCS

Clé à choc 12V - 1/4"



**BCL31IW1**

12	1/4"	1	BCL31IW1

Kit clé à choc 12 V - 1/4"



**BCL31IW1K1**

110 x 310 x 390 mm	3.1 kg	1	BCL31IW1K1

2x BCL31B1	
BCL31C1	
BCL31IW1	

Clé à choc 14,4V - 3/8"



**BCL32IW1**

14.4	3/8"	1	BCL32IW1

Kit clé à choc 14,4 V - 3/8"



**BCL32IW1K1**

110 x 310 x 390 mm	3.6 kg	1	BCL32IW1K1

BCL32IW1	
2x BCL32B1	
BCL31C1	

Kit clé à choc 18 V - 1/2"  
2 réglages de vitesse/couple



**BCL33IW1K1**

110 x 310 x 390 mm	5.77 kg	1	BCL33IW1K1

BCL33C1	
BCL33IW1	
2x BCL33B3	

Clé à choc usage intensif 18V - 1/2"



**BCL33IW2**

18	1/2"	1	BCL33IW2

Clé à choc 18V - 1/2"



**BCL33IW1**

18	1/2"	1	BCL33IW1

Kit clé à choc usage intensif 18V - 1/2"



**BCL33IW2K1**

110 x 310 x 390 mm	6.47 kg	1	BCL33IW2K1

BCL33IW2	
BCL33C1	
2x BCL33B3	

## CLIQUETS

Clé à rochet 12V - 1/4"



**BCL31R1**

12	1/4"	1	BCL31R1

Kit clé à rochet 12 V - 1/4"



**BCL31R1K1**

110 x 310 x 390 mm	3.1 kg	1	BCL31R1K1

2x BCL31B1	
BCL31C1	
BCL31R1	

**PERCEUSES ET VISSEUSES**

Perceuse mandrin automatique 13 MM - 18V, 1/2"



**BCL33D1**

18	1/2"	1	BCL33D1

Kit perceuse mandrin automatique 13 mm - 18V, 1/2"



**BCL33D1K1**

110 x 310 x 390 mm	3.7 kg	1	BCL33D1K1

BCL33C1	
BCL33D1	
2x BCL33B1	

Perceuse mandrin automatique 13 MM - 12V, 3/8"



**BCL31D1**

12	360/1550 min	1	BCL31D1

Kit perceuse mandrin automatique 13 mm - 12 V, 3/8"



**BCL31D1K1**

110 x 310 x 390 mm	3.15 kg	1	BCL31D1K1

2x BCL31B1	
BCL31C1	
BCL31D1	

Visseuse à choc 6 pans, 12V - 1/4"



**BCL31IS1**

12	1/4" in	1	BCL31IS1

Kit visseuse à choc 6 pans, 12 V - 1/4"



**BCL31IS1K1**

110 x 310 x 390 mm	3.1 kg	1	BCL31IS1K1

2x BCL31B1	
BCL31IS1	
BCL31C1	

Visseuse 12V - 1/4"



**BCL31SD1**

12	1/4" in	1	BCL31SD1

Kit visseuse 12 V - 1/4"



**BCL31SD1K1**

110 x 310 x 390 mm	2.99 kg	1	BCL31SD1K1

BCL31SD1	
2x BCL31B1	
BCL31C1	



## MEULEUSES, PONCEUSES ET POLISSEUSES

Ponceuse/Polisseuse 14,4V



### BCL32SP1

14.4	1900/6900 min	1	BCL32SP1

Polisseuse d'angle 18V, plateau 5", orbite 4,5 MM



### BCL33AP1

18	1100-3500 min	1	BCL33AP1

Kit Ponceuse / Polisseuse 14,4 V



### BCL32SP1K1

265 x 290 x 480 mm	3.29 kg	1	BCL32SP1K1

BCL32SP1	
2x BCL32B1	
BCL31C1	

Kit polisseuse d'angle 18V, plateau 5", orbite 4,5 mm



### BCL33AP1K1

265 x 290 x 480 mm	5.78 kg	1	BCL33AP1K1

BCL33AP1	
2x BCL33B3	
BCL33C1	

Mini meuleuse 6MM - 14,4V



### BCL32DG1

14.4	21000 min	1	BCL32DG1

Kit mini meuleuse 6 mm - 14,4 V



### BCL32DG1K1

110 x 310 x 390 mm	3.2 kg	1	BCL32DG1K1

BCL32DG1	
BCL32B1	
BCL31C1	

Kit graisseur 14,4 V



### BCL32G1K1

265 x 290 x 480 mm	5.22 kg	1	BCL32G1K1

BCL32G1	
BCL31C1	
2x BCL32B1	

## OUTILS DE COUPE

Scie sabre 14,4V



### BCL32RS1

14.4	3000 min	1	BCL32RS1

Kit scie sabre 14,4 V



### BCL32RS1K1

265 x 290 x 480 mm	3.5 kg	1	BCL32RS1K1

BCL32RS1	
2x BCL32B1	
BCL31C1	

## GRAISSEURS

Graisseur 14,4V



**BCL32G1**

<b>V</b>			
14.4	400	1	BCL32G1

Batterie Li-ion - 18V, 2Ah



**BCL33B1**

<b>V</b>			
18	2 A-h	1	BCL33B1

Chargeur de batterie - 18V, 2.3A



**BCL33C1**

<b>V<sub>in</sub></b>	<b>V<sub>out</sub></b>		
220	18	1	BCL33C1

## BATTERIES ET CHARGEURS

Batterie Li-ion - 12V, 2Ah



**BCL31B1**

<b>V</b>			
12	2 A-h	1	BCL31B1

Batterie Li-ion - 18V, 5Ah



**BCL33B3**

<b>V</b>			
18	2 A-h	1	BCL33B3

Chargeur rapide de batterie - 18V, 3.4A



**BCL33C2**

<b>V<sub>in</sub></b>	<b>V<sub>out</sub></b>		
220	18	1	BCL33C2

Batterie Li-ion - 14.4V, 2Ah



**BCL32B1**

<b>V</b>			
14.4	2 A-h	1	BCL32B1

Chargeur de batterie - 12V/14,4V



**BCL31C1**

<b>V<sub>in</sub></b>	<b>V<sub>out</sub></b>		
220	12/14.4 V	1	BCL31C1





**BAHCO**



## Outils automobiles



## OUTILS POUR MOTEUR

Coffret d'outils de calage pour moteurs FCA 1.4 Multiair



### BE501101

68 x 225 x 280 mm 1 BE501101

BE50110101

BE50110102

BE50110103

BE50110104

Pince de serrage de durites

### BE256M

40 x 45 x 310 mm 1 BE256M

Coffret d'outils de calage pour moteurs FCA 0.9 Essence Twinair



### BE501102

68 x 225 x 280 mm 1 BE501102

BE50110202

BE50110203

Connecteur pour testeur de bouchon de radiateur R123 / R125



### BE400P243

0.06 kg 1 BE400P243

Coffret d'outils de calage pour moteurs FCA 1.6-1.9-2.0-2.4 Diesel



### BE501203

68 x 225 x 280 mm 1 BE501203

BE50120301

BE50120302

BE50120303

BE50120305

BE50110103

Bouchon de radiateur testeur pour circuit de refroidissement



### BE400P2401

65 1 BE400P2401

Bouchon de radiateur testeur pour circuit de refroidissement



### BE400P2402

65 1 BE400P2402

Clé pour blocage Damper de Villebrequin BMW



### BE502104

60 x 98 x 269 mm 1726 g 8 BE502104



Bouchon de radiateur testeur pour circuit de refroidissement



**BE400P2403**



43.5



1 BE400P2403

Support de vilebrequin BMW



**BE502106**



80 x 70 x 260 mm



10 BE502106

Coffret d'outils de calage pour moteurs FCA 1.3 JTD MJ



**BE501204**



68 x 225 x 280 mm



1 BE501204

BE50120401



BE50120402



BE50120403



BE50120404



BE50120405



Adaptateur M42x3,0 pour tester le système de refroidissement



**BE400P2405**



0.065



1 BE400P2405

Adaptateur M59x3,0 pour tester le système de refroidissement



**BE400P2406**



0.065



1 BE400P2406

Adaptateur M62x3,0 pour tester le système de refroidissement



**BE400P2407**



0.065



1 BE400P2407

Coffret d'outils de calage pour moteurs BMW 1.8-2.0 Essence

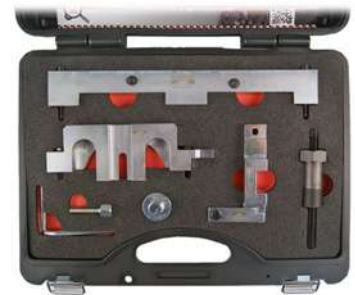

**BE502101**



95 x 270 x 350 mm



1 BE502101

BE50210101



BE50210102



BE50210103



BE50210104



BE50210105



BE50210106



BE50210107



Adaptateur M45x3,0 pour tester les systèmes de refroidissement



**BE400P2409**



0.11



1 BE400P2409

Adaptateur M50x2,5 pour tester les systèmes de refroidissement



**BE400P2410**



0.085



1 BE400P2410



Coffret d'outils de calage moteurs BMW 1.6 Essence

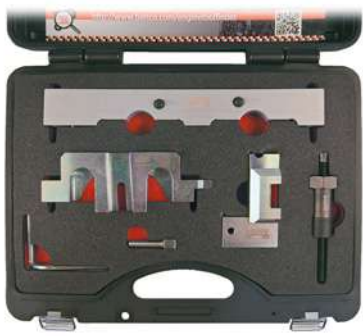

**BE502102**



270 x 95 x 355 mm

1 BE502102

BE50210103



BE50210105



BE50210107



BE50210201



BE50210202



BE50210203



Coffret d'outils de calage pour BMW 1.6-2.0 Essence

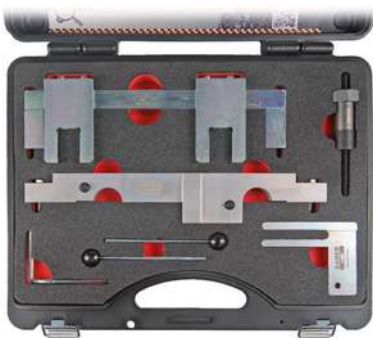

**BE502103**



80 x 300 x 375 mm

1 BE502103

BE50210301



BE50210302



BE50210303



BE50210305



BE50210105



BE50210107



Coffret d'outils de calage pour moteurs BMW 2.0-2.5-3.0 Diesel



**BE502204**



68 x 225 x 280 mm

1 BE502204

BE50220401



BE50220403



BE50220404



BE50220405



BE50210305



Douille pour bougies de préchauffage



**BE1GP58/BE1GP514**



10	70	1	BE1GP58
9	70	1	BE1GP59
10	70	1	BE1GP510
12	70	1	BE1GP512
14	70	1	BE1GP514

Coffret d'outils de calage pour moteurs BMW-MINI 1.6-2.0 Diesel



**BE503201**



68 x 225 x 280 mm

1 BE503201

BE50320101



BE50320102



BE50320103



BE50320105



BE50210305



Coffret d'outils de calage pour moteurs MINI-PAS 1.4-1.6 Essence



**BE504102**



95 x 270 x 350 mm

1 BE504102

BE50410201



BE50410202



BE50410203



BE50410204



BE50410206



BE50210105



Coffret d'outils de calage pour moteurs MINI-PSA 1.6 Diesel



**BE504201**

50 x 50 x 220 mm	1	BE504201

BE50420101	
BE50420102	
BE50420103	
BE50420104	
BE50210305	

Testeur de bougies de préchauffage



**BE100**

160	35 x 65 x 160 mm	1	BE100

Coffret d'outils de calage pour moteurs FORD 1.25-1.4-1.6 Essence



**BE505101**

68 x 225 x 280 mm	1	BE505101

BE50510101	
BE50510102	
BE50510103	
BE50510104	
BE50510105	
BE50510106	

Coffret de réparation de filetage de bougie de préchauffage



**BE1210P11**

50 x 120 x 260 mm	1	BE1210P11
112 x 13 x 95 mm	1	BE1210P9AC1

Coffret de remplissage du circuit de refroidissement sous vide  
BE4101 est un adaptateur conique



**BE410**

80 x 300 x 375 mm	4	BE410
45 x 45 x 105 mm	1	BE4101

Coffret d'outils de calage pour moteurs FORD 1.0 Ecoboost Essence



**BE505102**

95 x 270 x 350 mm	1	BE505102

BE50510201	
BE50510202	
BE50510203	
BE50510204	
BE50420102	
BE50510102	

Jeu de 5 inserts/bobines pour la restauration des fils des bougies de pré-chauffage



**BE1210P110x**

M8x1	50	1	BE1210P1101
M10x1	50	1	BE1210P1102
M10x1,25	50	1	BE1210P1103



Coffret de nettoyage des puits de bougie de préchauffage  
Guide d'alésoir BE1200P6AC1



**BE1200P6**

50 x 115 x 260 mm	1 BE1200P6 1 BE1200P6AC1

Coffret d'outils de calage pour moteurs FORD 2.0 - 2.2 - 2.4 Duratorq TDCI Diesel



**BE505203**

95 x 270 x 350 mm	1 BE505203

BE50520301	
BE50520302	
BE50520303	
BE50520304	
BE50520305	
BE50520306	
BE50520307	

Kit de réparation pour BE254



**BE2541**

100 g	1 BE2541

Coffret d'outils de calage pour moteurs FORD 1.4-1.6-1.8-2.0-2.2-2.5 Diesel



**BE505204**

95 x 270 x 350 mm	1 BE505204

BE50520401	
BE50520402	
BE50520403	
BE50520404	
BE50520405	
BE50520407	
BE50520411	
BE50520412	
BE50520413	
BE50510104	
BE50420102	
BE50420103	
BE50420104	
BE50510106	

Coffret d'outils de calage pour moteurs OPEL 1.0-1.2-1.4 Essence



**BE506101**

50 x 50 x 160 mm	1 BE506101

BE50610101	
BE50610102	
BE50610103	
BE50610104	
BE50610105	

Coffret d'outils de calage pour moteurs OPEL 1.4-1.6-1.8 Essence



**BE506102**

68 x 225 x 280 mm	1 BE506102

BE50610201	
BE50610202	
BE50610203	
BE50610204	
BE50610205	
BE50610206	

Coffret d'outils de calage pour moteurs OPEL 1.0-1.2-1.4 Ecoflex Essence



**BE506103**

95 x 270 x 350 mm 1 BE506103

- BE50610302
- BE50610304
- BE50610102
- BE50610103
- BE50610105

Coffret d'outils de calage pour moteurs OPEL 2.0 Diesel



**BE506204**

85 x 300 x 375 mm 1 BE506204

- BE50620401
- BE50620402
- BE50620403
- BE50620404
- BE50620405

Coffret d'outils de calage pour moteurs PSA 1.0-1.1-1.4-1.6-1.8-2.0-2.2 Essence



**BE507101**

95 x 270 x 350 mm 1 BE507101

- BE50710103
- BE50710104
- BE50710105
- BE50710106
- BE50710107
- BE50710108
- BE50710109
- BE50710110
- BE50710111
- BE50710112
- BE50710101
- BE50710102
- BE50710113
- BE50710114
- BE50710116
- BE50710117
- BE50710118
- BE50710119
- BE50420104

Coffret d'outils de calage pour moteurs PSA 1.0-1.2 Essence



**BE507102**

68 x 225 x 280 mm 1 BE507102

- BE50710103
- BE50710104
- BE50710105
- BE50710106
- BE50420102
- BE50420103

BE50710201

BE50710202

Coffret d'outils de calage pour moteurs PSA 1.4-1.5-1.6-1.9-2.0-2.2-2.5 Diesel



**BE507203**

85 x 300 x 375 mm 1 BE507203

- BE50720302
- BE50720304
- BE50720305
- BE50720307
- BE50720308
- BE50720310
- BE50720314
- BE50720317
- BE50720318
- BE50720319
- BE50720320
- BE50720321
- BE50720322
- BE50720323
- BE50520404
- BE50520411
- BE50710107
- BE50710104
- BE50710113
- BE50710110
- BE50710102
- BE50710106
- BE50420102
- BE50420103





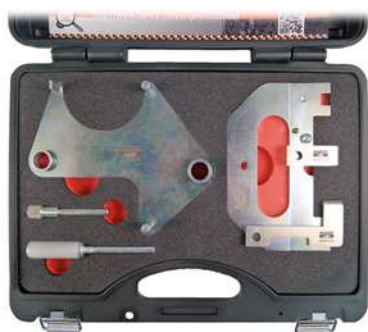

Coffret d'outils de calage pour moteurs RENAULT/  
DACIA 1.2-1.4-1.6-1.8-2.0 Essence



**BE508101**



 95 x 270 x 350 mm  1 BE508101

BE50810101	
BE50810103	
BE50810104	
BE50810106	

Pince pour déconnecter les lignes de carburant



**BE1FLD1/BE1FLD3**

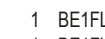
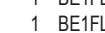











 8 mm  1 BE1FLD1  
10 mm  1 BE1FLD2  
8-10 mm  1 BE1FLD3

Coffret d'outils de calage pour moteurs Renault 1.5-  
1.9-2.2-2.5 Diesel



**BE508202**

 80 x 300 x 375 mm  1 BE508202

BE50820201	
BE50820202	
BE50820203	
BE50820204	
BE50820205	
BE50820206	
BE50820207	
BE50820208	
BE50820209	
BE50820211	
BE50810103	
BE50810104	

Jeu de 3 pinces pour déconnecter les lignes de carburant



**BE1FLDS**

 8-10  1 BE1FLDS





BE1FLD2, BE1FLD3, BE1FLD1 

Coffret d'outils de calage pour moteurs RENAULT 2.0  
Diesel



**BE508203**

 68 x 225 x 280 mm  1 BE508203

BE50820301	
BE50820302	
BE50820303	
BE50820304	
BE50210305	

Extracteur de jauge de carburant



**BE1FTW**





 75-160  1 BE1FTW

Coffret d'outils de calage pour moteurs RENAULT-  
NISSAN 1.6 Diesel



**BE508204**

 95 x 270 x 350 mm   1 BE508204

- BE50820402 
- BE50820403 
- BE50820404 
- BE50820302 

Clé à filtre à carburant pour FORD Transit 2.2L TDCI



**BE1FFWF**











 5 x 142 x 169 mm   12 BE1FFWF

Coffret d'outils de calage pour moteurs WM 1.4-1.6-  
1.8-2.0 Essence



**BE509101**

 80 x 300 x 375 mm   1 BE509101

- BE50910101 
- BE50910102 
- BE50910103 
- BE50910104 
- BE50910105 
- BE50910106 
- BE50910107 
- BE50910108 
- BE50910109 
- BE50910110 
- BE50910111 
- BE50910112 
- BE50910114 
- BE50520302 

Coffret d'outils de calage pour moteurs VW 1.2-1.4-1.6  
Essence



**BE509102**

 68 x 225 x 280 mm   1 BE509102



- BE50910201 
- BE50910202 
- BE50910203 
- BE50910205 
- BE50910206 
- BE50910207 
- BE50520302 

Coffret d'outils de calage pour moteurs VW 1.2 TSI  
Essence



**BE509103**

 50 x 50 x 210 mm   1 BE509103





- BE50910302 
- BE50910203 

Coffret d'outils de calage pour moteurs VW 1.0  
Ecoboost Essence



**BE509104**

 68 x 225 x 280 mm   1 BE509104



- BE50910401 
- BE50910402 
- BE50910403 
- BE50910404 
- BE50910203 

Coffret d'outils de calage pour moteurs vw 1.2-1.4-1.6-  
1.9-2.0 Diesel



**BE509205**

 60 x 60 x 220 mm   1 BE509205

- BE50910103 
- BE50920602 
- BE50920603 



Coffret d'outils de calage pour moteurs VW 1.9-2.0 Diesel



**BE509206**



- BE50920602
- BE50910103
- BE50920703

Coffret d'outils de calage pour moteurs VW 1.2-1.4-1.6-1.9-2.0 Diesel

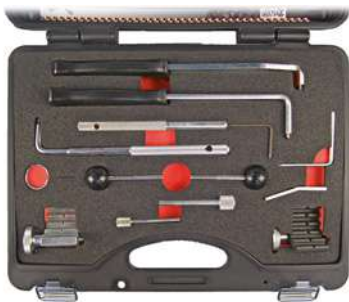

**BE509207**



- BE50920703
- BE50920707
- BE50920708
- BE50920709
- BE50920710
- BE50910103
- BE50910112
- BE50920602
- BE50920603
- BE50910109
- BE50510102

Coffret d'outils de calage pour moteurs VOLVO 1.6-1.8-1.9-2.0-2.3-2.4-2.5 Essence



**BE510101**



- BE51010101
- BE51010102
- BE51010103

Coffret d'outils de calage pour moteurs VOLVO 1.6-1.8-2.0 16V Essence



**BE510102**



- BE51010201
- BE51010202
- BE50510102
- BE50510105
- BE50510106

Coffret d'outils de calage pour moteurs VOLVO 1.6-2.0 Diesel



**BE510203**



- BE50420102
- BE50420103
- BE50420104
- BE50520407
- BE50520411
- BE50510104

Outil de blocage arbre moteur pour Volvo



**BE510304**



Coffret d'outils de calage pour moteurs SAAB 1.8i Essence



**BE511101**



- BE51110101
- BE51110102
- BE50610201
- BE50610204



Coffret d'outils de calage pour moteurs SAAB 1.6T Essence



**BE511102**

50 x 50 x 207 mm 1 BE511102

BE50610201	
BE50610202	
BE50610205	
BE50610203	

Coffret d'outils de calage pour moteurs SAAB 1.9-2.0-2.2 TID Diesel



**BE511203**

80 x 300 x 375 mm 1 BE511203

BE51120301	
BE51120302	
BE51120303	
BE51120304	
BE51120305	
BE50120302	
BE50120303	
BE50120305	
BE50610201	

Coffret pour l'extraction des électrodes des bougies M8x1 - M9x1 - M10x1 - M10x1.25



**BE513201**

95 x 270 x 350 mm 2.10 kg 1 BE513201

BE51320101	
BE51320102	
BE51320103	
BE51320104	
BE51320105	
BE51320106	
BE51320107	
BE51320108	
BE51320109	
BE51320110	
BE51320111	
BE51320112	
BE51320113	
BE51320114	

Outil de blocage universel pour pignon d'arbre à cames



**BE523106**

0.41 1 BE523106

Outil universel de blocage d'arbre à cames



**BE5100**

345 x 150 x 85 mm 1 BE5100

Testeur de tension de courroie de distribution



**BE239**

38 x 82 x 95 mm 95 mm 1 BE239

Testeur de tension électronique de courroie de distribution



**BE240**

60 x 270 x 315 mm 315 mm 1 BE240



Catalogue de valeurs de tension de courroies et accessoires de distribution, synchrone, avec forme en V ou crantée



### BE240-CAT



710



1 BE240-CAT

Outil de montage / démontage des courroies élastiques



### BE230



35 x 145 x 155 mm



1 BE230

Coffret d'extraction d'alternateur, 24 pièces



### BE500P24



55 x 270 x 370 mm



1 BE500P24  
1 BE500P2401  
1 BE500P2402  
1 BE500P2403  
1 BE500P2404  
1 BE500P2405  
1 BE500P2406  
1 BE500P2407  
1 BE500P2408  
1 BE500P2409



1 BE500P2410  
1 BE500P2411  
1 BE500P2412  
1 BE500P2413  
1 BE500P2414  
1 BE500P2415  
1 BE500P2416  
1 BE500P2417  
1 BE500P2418  
1 BE500P2419  
1 BE500P2420  
1 BE500P2421  
1 BE500P2422  
1 BE500P2423  
1 BE500P2424

Coffret d'extraction de joints toriques, 6 pièces



### 2633HD/S6



80 x 270 x 375 mm  
42 x 93 x 290 mm  
30 x 85 x 215 mm  
30 x 93 x 200 mm  
20 x 87 x 165 mm  
10 x 60 x 120 mm  
10 x 10 x 155 mm



1 2633HD/S6  
1 2633HD1  
1 2633HD2  
1 2633HD3  
1 2633HD4  
1 2633HD5  
1 2633HD6

Pince de serrage pour collier élastique



### BE258



12-55



285



1 BE258

Thermomètre laser



### BLT550



-50 +550



40 x 95 x 145 mm



10 BLT550

Réfractomètre



### 3046-REF



150



1 3046-REF

Testeur de liquide antigel



### BE401



50 x 50 x 235 mm



235 mm



1 BE401

Coffret de réparation de climatisation



**BE800P12**

43 x 90 x 200 mm 1 BE800P12

Lampe UV pour détection de fuites



**BLUVF**

450 70 x 98 x 295 mm 1 BLUVF

Jeu de connecteurs, poussoirs spéciaux



**BAC007**

240 mm 0.075 kg 1 BAC007

Jeu de douilles ouvertes



**BE5500**

10/11/12/14/17/19 25 BE5500

Coffret de pinces et bouchons à durite



**BE257**

68 x 225 x 280 mm 8 BE257  
1 BE25710  
1 BE25718  
1 BE2572  
1 BE2576

Coffret universel d'outils pour l'extraction des injecteurs



**BE512201**

140 x 415 x 600 mm 1 BE512201

BE51220101	
BE51220102	
BE51220103	
BE51220104	
BE51220105	
BE51220106	
BE51220107	
BE51220108	
BE51220109	
BE51220110	
BE51220111	
BE51220112	
BE51220113	
BE51220114	
BE51220115	
BE51220116	
BE51220117	
BE51220118	
BE51220119	
BE51220120	

Pompe de pression avec manomètre pour tester le système de refroidissement ou de réchauffement



**BE400P241**

**BAR PSI** 0-2,5 bar 0-36 psi 1 BE400P241

Coffret extracteur d'injection common rail



**BE1311P13**

80 x 355 x 445 mm 1 BE1311P13



Coffret de 4 douilles injecteurs diesel 25-27-29-30mm



**BE1310P4**

68 x 225 x 225 mm	1	BE1310P4

Douille à choc 1/2" injecteur diesel



**BE1310P425-BE1310P430**

25	1/2	1	BE1310P425
27	1/2	1	BE1310P427
29	1/2	1	BE1310P429
30	1/2	1	BE1310P430

Coffret de douilles pour bougies de préchauffage Carré 1/4"- 8, 9,10,12 et 14mm



**BE1GP5**

1/4"	110 x 240 x 40 mm	1	BE1GP5

BE1GP514, BE1GP510, BE1GP512, BE1GP58, BE1GP59

Clé en ABS pour serrage d'adaptateur de bouchon de radiateur



**BE400P2420**

0.005 kg	1	BE400P2420

Poignée en T pour douilles pour bougies de préchauffage



**BE1GP5-T**

1/4"	400	10	BE1GP5-T

Extracteur de bougie de préchauffage



**BE1205**

130	35 x 35 x 130 mm	1	BE1205

Coffret de nettoyage des sièges d'injecteurs diesel



**BE1320S17**

76 x 266 x 355 mm	10	BE1320S17

Coffret de nettoyage des sièges d'injecteur diesel



**BE1315P7**

68 x 225 x 280 mm	1	BE1315P7
25 x 180 x 275 mm	1	BE1315P71
20 x 93 x 175 mm	1	BE1315P72
19 x 93 x 140 mm	1	BE1315P73
16 x 93 x 140 mm	1	BE1315P74
20 x 56 x 96 mm	1	BE1315P75
20 x 56 x 96 mm	1	BE1315P76
23 x 56 x 96 mm	1	BE1315P77

Arrache à inertie



**BE1300SH**

235	50 x 50 x 235 mm	10	BE1300SH

Câble pour BE253, BE254 et BE255



**BE2542**

630 mm	20 g	1	BE2542

Jeu de 3 pinces pour durites



**BE256P3**

40 x 93 x 330 mm	1	BE256P3
15 x 55 x 155 mm	1	BE256-155
20 x 45 x 185 mm	1	BE256-178
10 x 55 x 250 mm	1	BE256-250

Outil pour le montage - démontage de la valve à aiguilles d'injecteurs Denso Piezo Common Rails



**BE1310DNS**

36.4 x 24 x 24 mm	12	BE1310DNS

Outil pour le montage-démontage de la valve à aiguilles d'injecteurs Denso common rail



**BE1312DNS**

12	BE1312DNS

Extracteur de joints d'injecteurs diesel



**BE1300**

230 mm	35 x 35 x 260 mm	1	BE1300

Jeu de rodoirs de soupapes



**BE762**

30 x 90 x 315 mm	12	BE762

Coffret de 450 rondelles cuivre pour injecteur



**BE1305P450**

40 x 140 x 205 mm	1	BE1305P450

Pinçe de halage pour collier EGR  
Gaine semirigide



**BE253**

870	1	BE253



Jeu de 30 rondelles cuivre pour injecteurs

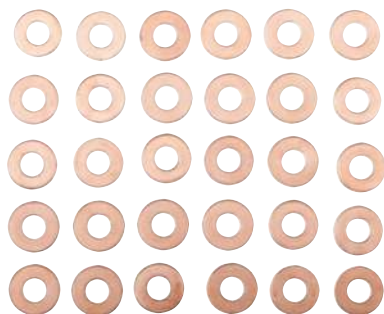

**BE1305P450B**



- 1 BE1305P450WS01
- 1 BE1305P450WS02
- 1 BE1305P450WS03
- 1 BE1305P450WS04
- 1 BE1305P450WS05
- 1 BE1305P450WS06
- 1 BE1305P450WS07
- 1 BE1305P450WS08
- 1 BE1305P450WS09
- 1 BE1305P450WS10
- 1 BE1305P450WS11
- 1 BE1305P450WS12
- 1 BE1305P450WS13
- 1 BE1305P450WS14
- 1 BE1305P450WS15

Pince à collier de serrage 45°



**BE250**

190	245	1	BE250

Pince à colliers élastiques



**BE251**

210	180	1	BE251

Coffret de mesure de retour de fuite d'injecteur common rail



**BE5350**

84 x 341 x 447 mm	5	5	BE5350
10 x 56 x 96 mm	1	1	BE5350C1
10 x 56 x 96 mm	1	1	BE5350C2
10 x 56 x 96 mm	1	1	BE5350C3
10 x 56 x 96 mm	1	1	BE5350C4
115 x 65 x 205 mm	1	1	BE5350C5

Pompe pour tarer les injecteurs diesel



**BE13ZL11**

480 x 230 x 280 mm	4.24	1	BE13ZL11

Douille 1/2" pour injection diesel



**7807**

29	80 mm	1

Jeu de 8 douilles Torx® Tamper Plus, 1/4"



**BE5008**

40 x 20 x 175 mm	1	BE5008

BE5008-45, BE5008-27, BE5008-25, BE5008-40, BE5008-30, BE5008-10, BE5008-20, BE5008-15

Douille Torx® Tamper Plus 1/4"



**BE5008-10/BE5008-45**

10	1	BE5008-10
15	1	BE5008-15
20	1	BE5008-20
25	1	BE5008-25
27	1	BE5008-27
30	1	BE5008-30
40	1	BE5008-40
45	1	BE5008-45

Pince à douille pour bougie  
Longueur: 290 mm



**BE1P**

290	20 x 50 x 290 mm	1 BE1P

Flexible bougie d'allumage



**BE1SP1F**



12 BE1SP1F

Douille pour clés à bougie avec aimant 3/8"  
Douille hexagonale, dimensions métriques



**7406ZZ**

16	65 mm	1 7406ZZ-16
21	68 mm	1 7406ZZ-21

Douille pour clés à bougie 1/2"  
Douille hexagonale, dimensions métriques



**7805ZZ**

16	67 mm	1 7805ZZ-16
21	69 mm	1 7805ZZ-21

Thermomètre 0-200°C



**BE400P244**



0.02



1 BE400P244

Coffret de 9 douilles Ribe 1/2" avec embouts, pour moteurs



**BE5102**

65 x 225 x 225 mm		1 BE5102



65 x 225 x 225 mm



1 BE5102

BE51026, BE51025, BE510210,  
BE510211, BE510212, BE510213,  
BE51027, BE51028, BE51029

Compressiomètre moteur diesel



**BE5401D**

105 x 325 x 410 mm	1 BE5401D

Adaptateur M50x2,5 pour tester le système de refroidissement



**BE400P2404**

0.055	1 BE400P2404

Douille Ribe 1/2" avec embouts



**BE51025-BE510213**

RM5	100	1 BE51025
RM6	100	1 BE51026
RM7	100	1 BE51027
RM8	100	1 BE51028
RM9	100	1 BE51029
RM10	100	1 BE510210
RM11	100	1 BE510211
RM12	100	1 BE510212
RM13	100	1 BE510213



100



1 BE51025  
1 BE51026  
1 BE51027  
1 BE51028  
1 BE51029  
1 BE510210  
1 BE510211  
1 BE510212  
1 BE510213



Douille pour clé à bougies 3/8"  
Douille hexagonale, dimensions métriques



**SBS71**

16		60 mm	1	SBS71-16
21		65 mm	1	SBS71-21

Coffret de 6 douilles XZN 1/2" avec embouts, pour moteurs



**BE5103**

65 x 225 x 225 mm	1 BE5103

Douille XZN 1/2" avec embouts



**BE51035-BE510314**

M5	140 mm	1	BE51035
M6	140 mm	1	BE51036
M8	140 mm	1	BE51038
M10	140 mm	1	BE510310
M12	140 mm	1	BE510312
M14	140 mm	1	BE510314

Clé à bougie 3/8"



**BE1SP14L**

3/8"	252 mm	1	BE1SP14L

BE51036, BE51038, BE510310,  
BE510312, BE51035, BE510314

Clé cardan de bougie de préchauffage



**BE1T14/BE1T16/BE1T21**

14	65/310	1	BE1T14
16	63/450	1	BE1T16
21	67/450	1	BE1T21

Brosse à bougie



**52**

150	12	52

Adaptateur M48x4,0 pour tester le système de refroidissement



**BE400P2408**

0.075	1	BE400P2408

Adaptateur M60x4,0 pour tester les systèmes de refroidissement



**BE400P2411**

0.11	1	BE400P2411

Adaptateur M52x3,0 pour tester les systèmes de refroidissement



**BE400P2412**

0.085	1	BE400P2412



Brosse métallique acier



**782-U**



285



1 782-U

Adaptateur M48x2,5 pour tester les systèmes de refroidissement



**BE400P2413**



0.065



1 BE400P2413

Brosse métallique pour freins



**783**



223



1 783

Adaptateur M42x2,5 pour tester les systèmes de refroidissement



**BE400P2414**



0.11



1 BE400P2414

Brosse pour nettoyage de bornes de batteries



**2555**



85



1 2555

Adaptateur M50x3,0 pour tester le système de refroidissement



**BE400P2415**



0.075 kg



1 BE400P2415

Coffret de restauration de filetage de bougie d'allumage



**BE1100**



68 x 225 x 280 mm



1.55



8 BE1100

Adaptateur M46x3,0 pour tester les systèmes de refroidissement



**BE400P2416**



0.065



1 BE400P2416

Fraise



**BE110001**



60



1 BE110001

Adaptateur M34x3,0 pour tester les systèmes de refroidissement



**BE400P2417**



0.11



1 BE400P2417



Adaptateur M46x3,0 pour tester les systèmes de refroidissement



**BE400P2418**

0.045	1	BE400P2418

BE110014 / Taraud: M14 x 1,25P  
BE110015 / Taraud étagé: M14 x 1,25P - M15,8 x 1,25P



**BE110014/BE110015**

55	1	BE110014
55	1	BE110015

Insert M14 pour réparation filetage bougie d'allumage



**BE1100AC1/BE1100AC2**

15	1	BE1100AC1
15	1	BE1100AC2

Adaptateur M52,5x3,0 pour tester les systèmes de refroidissement



**BE400P2419**

0.075	1	BE400P2419

Coffret de testeur de pression de liquide de refroidissement



**BE400P24**

127 x 435 x 510 mm	1	BE400P24

Coffret d'embouts 10mm  
32 pièces



**BE5032**

65 x 225 x 225 mm	1	BE5032

BE5049M5, BE5049M6, BE5049M8, BE5049M10, BE5049M12, BE5032M14		
BE5049T20, BE5049T25, BE5049T27, BE5049T30, BE5049T40, BE5049T45, BE5049T50, BE5049T55, BE5049T60		
BE5049H5, BE5049H6, BE5049H8, BE5049H10, BE5049H12, BE5032H14		
BE5032SQ8, BE5032SQ10		
BE5049H6L, BE5049H8L		
BE5049T45L		
BE5049M8L, BE5049M10L, BE5049M12L		
BE5032H10EL		
BE5032T55EL		
BE504901		

Embout Robertson 10mm



**BE5032SQ**

#8	30	1	BE5032SQ8
#10	30	1	BE5032SQ10

Coffret de 49 douilles et embouts 6 pans, XZN et Torx® Tamper



**BE5049**

55 x 190 x 320 mm	3.56	5	BE5049

Adaptateur 1/2" pour embouts 10mm



**BE504901**

10	36 mm	1	BE504901

Embout pour vis 6 pans, 10mm



**BE5049H**

4	30	1	BE5049H4
5	30	1	BE5049H5
6	30	1	BE5049H6
7	30	1	BE5049H7
8	30	1	BE5049H8
10	30	1	BE5049H10
12	30	1	BE5049H12
14	30	1	BE5032H14

Embout pour vis à empreintes multiples XZN, 10mm



**BE5049M**

M5	30	1	BE5049M5
M6	30	1	BE5049M6
M8	30	1	BE5049M8
M10	30	1	BE5049M10
M12	30	1	BE5049M12
M14	30	1	BE5032M14

Embout pour vis TORX®, 10mm



**BE5049T**

T20	30	1	BE5049T20
T25	30	1	BE5049T25
T27	30	1	BE5049T27
T30	30	1	BE5049T30
T40	30	1	BE5049T40
T45	30	1	BE5049T45
T50	30	1	BE5049T50
T55	30	1	BE5049T55
T60	30	1	BE5049T60

Embout pour vis TORX® Tamper, 10mm



**BE5049T**

TR20	30	1	BE5049T20H
TR25	30	1	BE5049T25H
TR27	30	1	BE5049T27H
TR30	30	1	BE5049T30H
TR40	30	1	BE5049T40H
TR45	30	1	BE5049T45H
TR50	30	1	BE5049T50H
TR55	30	1	BE5049T55H
TR60	30	1	BE5049T60H

Coffret de 9 douilles Torx® tamper 1/2" avec embouts, pour moteurs



**BE5101**

65 x 225 x 225 mm	1	BE5101

BE510150, BE510145, BE510160,  
BE510155, BE510127, BE510125,  
BE510140, BE510130



Coffret de testeur de pression d'huile moteur



**BE5200**

85 x 355 x 445 mm 25 x 105 x 195 mm	1	BE5200
	1	BE530001
	1	BE52001
	1	BE52002
	1	BE52003

Pince à segment de pistons



**BE74-55100/BE74-80120**

55-100	20 x 130 x 205 mm	1	BE74-55100
80-120	20 x 145 x 220 mm	1	BE74-80120



Pince pour retirer les soupapes des véhicules lourds



**BE76105**

70 x 315 x 380 mm 1 BE76105

Connecteur pour testeur de bouchon de radiateur R124 / R123



**BE400P242**

0.035 1 BE400P242

Adaptateur 3/8" pour embouts 10mm



**BE504902**

10 28 mm 1 BE504902

Embout pour vis 6 pans, 10mm  
Série longue 75mm



**BE5049H**

	L	
4	75	1 BE5049H4L
5	75	1 BE5049H5L
6	75	1 BE5049H6L
7	75	1 BE5049H7L
8	75	1 BE5049H8L
10	75	1 BE5049H10L
10	115	1 BE5032H10EL
12	75	1 BE5049H12L

Embout à empreintes multiples XZN  
Série longue 75mm



**BE5049M**

	L	
M5	75	1 BE5049M5L
M6	75	1 BE5049M6L
M8	75	1 BE5049M8L
M10	75	1 BE5049M10L
M12	75	1 BE5049M12L

Embout pour vis TORX®, 10mm  
Série longue 75mm



**BE5049T**

	L	
T20	75	1 BE5049T20L
T25	75	1 BE5049T25L
T27	75	1 BE5049T27L
T30	75	1 BE5049T30L
T40	75	1 BE5049T40L
T45	75	1 BE5049T45L
T50	75	1 BE5049T50L
T55	75 mm	1 BE5049T55L
T55	115	1 BE5032T55EL

Embout pour vis TORX® Tamper, 10mm  
Série longue 75mm



**BE5049T**

	L	
TR20	75	1 BE5049T20HL
TR25	75	1 BE5049T25HL
TR27	75	1 BE5049T27HL
TR30	75	1 BE5049T30HL
TR40	75	1 BE5049T40HL
TR45	75	1 BE5049T45HL
TR50	75	1 BE5049T50HL
TR55	75	1 BE5049T55HL
TR60	75	1 BE5049T60HL
TR70	100	1 BE5049T70HL
TR80	70	1 BE5049T80HL
TR30	200	1 BE5049T30HXL
TR40	200	1 BE5049T40HXL
TR45	200	1 BE5049T45HXL

Coffret de douilles et embouts 6 pans, XZN et Torx®,  
49 pièces



**BE5049t**

55 x 190 x 320 mm 3.54 kg 1 BE5049t

Douille Torx® Tamper 1/2" avec embouts



**BE510125-BE510160**

TR25	100 mm	1	BE510125
TR27	100 mm	1	BE510127
TR30	100 mm	1	BE510130
TR40	100 mm	1	BE510140
TR45	100 mm	1	BE510145
TR50	100 mm	1	BE510150
TR55	100 mm	1	BE510155
TR60	100 mm	1	BE510160

Collier à segments de pistons



**BE74-57125/BE74-90175**

80	57-125	1	BE74-57125	
165	90-175	1	BE74-90175	
80	57-125	1	BE74-57125L	

Pince à collier OETIKER™



**BPOC15**

275		12	BPOC15

Coffret pour le montage des joints SPI



**BE5150P27**

80 x 270 x 375 mm	1	BE5150P27
56 x 56 x 96 mm	1	BE5150P271
80 x 80 x 195 mm	1	BE5150P272
170 x 160 x 385 mm	1	BE5150P273

Pince pour retirer les soupapes des véhicules légers



**BE76101**

40 x 200 x 290 mm	1	BE76101

Pince pour colliers élastiques



**BE254A**

18-53 mm	1	BE254A

Compressiomètre moteur essence



**BE5400P**

70 x 160 x 260 mm	1	BE5400P

Coffret de démontage de carters de vidange



**BE700**

90 x 200 x 43 mm	1	BE700
	1	BE700BP2
	1	BE700SP15

Kit de réparation pour BE254A



**BE254A-01**

1	BE254A-01



Pince raccord durite essence et diesel



**BE6FCP**



30 BE6FCP

Support moteur à engrenage 500 kg



**BH8AC2-500**



500



1 BH8AC2-500

Jeu de 5 barres poignée en T pour vis 6 pans 4-5-6-8 & 10 mm



**BE1TH-S5**



5

1 BE1TH-S5

## OUTILS POUR ÉCHAPPEMENT

Aspirateur gaz d'échappement  
BUCPEF: kit pour filtre, BUCPEF1: filtre



**BUCPE**



2500 mm	1263 x 306 x 300 mm	1 BUCPE
105 mm	15 x 105 x 105 mm	1 BUCPEF1
121 mm	60 x 121 x 121 mm	1 BUCPEF

Rallonge tubulaire pour BUCPE  
Longueur 3M



**BUCPE3SH**



3000 mm	63,5 mm	1 BUCPE3SH
---------	---------	------------

Tuyau double échappement pour BUCPE  
Longueur 3M



**BUCPE3SDH**



420 x 530 x 3000 mm	3000 mm	1 BUCPE3SDH
---------------------	---------	-------------

Testeur de sonde rapide lambda



**BELT10**



35 x 65 x 160 mm

1 BELT10

Douille 1/2" pour sonde lambda



**7806**



22

83 mm

1 7806

Pince d'échappement universelle  
Longueur: 300 mm



**BUC50**



65

305

1 BUC50

Pince universelle d'extraction de silentblocs d'échappement



**BUC110**

360 mm	50 x 65 x 360 mm	1 BUC110

Extracteur pour tuyau d'échappement



**BUC100**

34-54	320 mm	1 BUC100

**ÉQUIPEMENTS ET OUTILS POUR VIDANGE**

Clé pour filtre à carburant 108 MM



**BE6OF108**

50	BE6OF108

Pince pour filtre à huile / carburant



**BE6OFW**

5	BE6OFW

Clé à sangle pour filtre à huile



**BE611**

65-105	25 x 55 x 210 mm	1	BE61110
65-105	1 x 12 x 382 mm	100	BE61110-1
100-155	37 x 75 x 275 mm	1	BE61155
100-155	1 x 12 x 529 mm	1	BE61155-1

Barre poignées en T avec clés mâle 6 pans



**BE1TH**

10 mm	385	5	BE1TH-10
12 mm	571	5	BE1TH-12
14 mm	801	5	BE1TH-14
2 mm	15	10	BE1TH-2
2,5 mm	20	10	BE1TH-2.5
3 mm	23	10	BE1TH-3
3,5 mm	23	10	BE1TH-3.5
4 mm	60	10	BE1TH-4
4,5 mm	60	10	BE1TH-4.5
5 mm	60	10	BE1TH-5
6 mm	127	10	BE1TH-6
7 mm	205	10	BE1TH-7
8 mm	205	10	BE1TH-8
9 mm	385	10	BE1TH-9

Clé à sangle pour filtres à huile



**BE62**

65-105 mm	42.5 x 57 x 249 mm	10	BE62110
110-155 mm	42.5 x 85 x 314 mm	10	BE62155

Jeu de 6 barres poignées en T avec clés mâles 6 pans de 2,5-3-4-5-6 et 8 mm



**BE1TH-S6**

6	30	BE1TH-S6

BE1TH-4, BE1TH-8, BE1TH-2.5, BE1TH-3, BE1TH-6, BE1TH-5

Clé à chaîne pour filtre à huile



**BE64520/BE64350**

350	60-105	1	BE64350
350	60-105	1	BE64350CH
520	60-160	1	BE64520
520	60-160	1	BE64520CH



Barres poignées en T avec douilles à cardans 6 pans, longueur 500 mm



### BE1TS

Ø	g	Icon	Icon
10 mm	485	10	BE1TS-10
11 mm	485	10	BE1TS-11
12 mm	475	10	BE1TS-12
13 mm	485	10	BE1TS-13
14 mm	485	10	BE1TS-14
15 mm	485	10	BE1TS-15
16 mm	495	10	BE1TS-16
17 mm	495	10	BE1TS-17
18 mm	510	10	BE1TS-18
19 mm	495	10	BE1TS-19
20 mm	730	8	BE1TS-20
21 mm	765	8	BE1TS-21
22 mm	745	8	BE1TS-22
24 mm	745	8	BE1TS-24
6 mm	475	10	BE1TS-6
7 mm	475	10	BE1TS-7
8 mm	485	10	BE1TS-8
9 mm	475	10	BE1TS-9

Clé ceinture caoutchouc universelle



### BE66152

Icon	Icon	Icon	Icon
150	28 x 90 x 225 mm	6	BE66152
150 mm	95 x 170 x 220 mm	8	BE661521

Jeu de 7 barres poignées en T avec douilles rotatives de 7-8-10-12-13-14 et 17 mm, longueur 500 mm

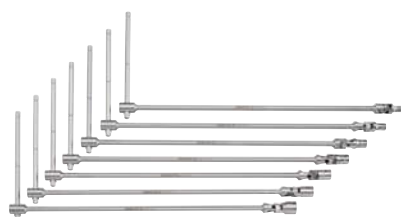

### BE1TS-S7

Icon	Icon	Icon	Icon
7		1	BE1TS-S7

BE1TS-17, BE1TS-13, BE1TS-14, BE1TS-12, BE1TS-7, BE1TS-8, BE1TS-10

Clé pour filtre à huile 3 griffes



### BE65F65120

Icon	Icon	Icon	Icon
3/8"	65-120	12	BE65F65120

Clé magnétique pour filtres à huile, 3 griffes



### BE65R

Icon	Icon	Icon	Icon
3/8-1/2"	65-120	1	BE65R65120
3/8-1/2"	80-119	1	BE65R80120
1/2"	105-160	1	BE65R106160

Coffret de clés coiffe pour filtres d'huile



### BE630

Icon	Icon	Icon	Icon
87 x 505 x 610 mm		3	BE630

Pompe à huile



### BOD4200/BOD4500

Icon	Icon	Icon	Icon
0.2	158 x 86 x 128 mm	1	BOD4200
0.5	158 x 86 x 128 mm	1	BOD4500

Couppelles pour démontage de filtres à huile individuelles



### BE630

Icon	Icon	Icon	Icon
66 mm	Fiat, Renault	1	BE630666F
64 mm	Daihatsu, Fiat, Nissan, Toyota	12	BE6306514F
65-66 mm	Daihatsu, Toyota	12	BE630656714F
66 mm	Ford, Mazda, Subaru	1	BE6306814F
73 mm	Alfa Romeo, Lexus, Toyota	1	BE6307314F
74 mm	Audi, Chrysler, GM, Rover	1	BE6307415F
74-76 mm	Audi, Ford, Mercedes Benz, Opel, VW	12	BE630747615F
74-75 mm	Audi, Ford, Isuzu, Mercedes Benz, Opel, VW	1	BE630757715F
76 mm	Fiat, Mercedes Benz, Renault	12	BE6307612F
74 mm	Audi, BMW, Mercedes Benz, Opel, Porsche, VW	12	BE6307614F
74 mm	Ford	1	BE6307630F
74 mm	Fiat, Lancia	1	BE630768F
78 mm	Ford, Honda, Nissan, Toyota	1	BE6307815F
80 mm	Honda, Isuzu, Mazda, Nissan, Opel, Subaru, Toyota	1	BE6308015F



80-82 mm	Acura, Honda, Mazda, Nissan, Subaru, Toyota	1	BE630808215F
86 mm	Volvo	1	BE6308616F
86 mm	Audi, Citroen, Peugeot, Renault, VW	1	BE6308618F
89 mm	Honda, Isuzu, Mitsubishi	1	BE6309015F
92 mm	Fiat, Lancia	1	BE6309210F
92 mm	Audi, Ford, Honda, Mazda, Mitsubishi, Nissan, Opel, Porsche, Renault, Volvo, VW	1	BE6309315F
93 mm	Ford	1	BE6309336F
93 mm	Audi, VW	1	BE6309345F
95 mm	Alfa Romeo, Chrysler, Ford, Toyota	1	BE6309515F
96 mm	Audi, Renault, VW	1	BE6309618F
101 mm	Isuzu, Mitsubishi	25	BE63010015F
24 mm	BMW	50	BE630246F
106 mm	Fiat, MAN, Scania	1	BE63010615F
27 mm	Mercedes Benz	50	BE630276F
107 mm	Volvo	1	BE63010815F
32 mm	GM, Mercedes Benz, Opel, Saab	50	BE630326F
108 mm	Renault	1	BE63010818F
36 mm	BMW, Ford, Mercedes Benz, Opel, Rover, VW	100	BE630366F
38 mm	BMW, Opel, Volvo	50	BE630386F
66.5 mm	Daihatsu, Toyota	25	BE63066514F

Clé pour filtre à huile, Toyota, Lexus, Subaru, Daihatsu 4 cylindres (1,8 à 2L)



**BE63064514F1**

Toyota, Lexus, Subaru, Daihatsu 4 cylindres (1.8-2.0l)	64.5 mm	1	BE63064514F1

Clé pour filtre à huile, Toyota, Lexus, Subaru, Daihatsu 4, 6 ou 8 cylindres (2,5 à 5,7L)



**BE63064514F2**

Toyota, Lexus, Subaru, Daihatsu 4, 6, 8 cylindres (2.5-5.7L)	64.5 mm	1	BE63064514F2

Clé filtre à huile 27 mm pour véhicules FORD et PSA



**BE6302712F**

1/2 mm	27 mm	5	BE6302712F

Cloche de filtre à huile 74 mm 14 pans



**BE6307414F**

14	1	10	BE6307414F

Clé mâle embouts carrés



**BE68**

8 mm	265 mm	12	BE6810Z
8	235	1	BE68
8 x 10	270	1	BE6810

Embout 1/4" pour démonter le puisard plastique des VAG 2 litres 4 cylindres



**BE6701VAG**

10 x 50 x 125 mm	0,02 kg	1	BE6701VAG

Coffret d'embouts pour vidange



**BE6217**

55 x 105 x 220 mm	1	BE6217



### Embouts 3/8" pour vidange



#### BE621701-BE621717

#	mm		
6	8	1	BE621701
6	9	1	BE621702
6	10	1	BE621703
6	12	1	BE621704
6	13	1	BE621705
6	14	1	BE621706
6	17	1	BE621707
4	8	1	BE621708
4	9.5	1	BE621709
4	10	1	BE621710
4	10.5	1	BE621711
4	11	1	BE621712
4	12	1	BE621713
4	13.1	1	BE621714
4	10	1	BE621715
3	10	1	BE621716
xZN	M16	1	BE621717

### Coffret de restauration des filets de carter d'huile



#### BOD10P64

mm	
68 x 225 x 280 mm	1 BOD10P64

### Mini coffret de restauration des filets de carter d'huile



#### BOD10

mm	
34 x 93 x 105 mm	1 BOD101
35 x 95 x 105 mm	1 BOD102

mm	
33 x 93 x 105 mm	1 BOD103
33 x 93 x 105 mm	1 BOD104
33 x 93 x 105 mm	1 BOD105
95 x 105 x 35 mm	1 BOD106

### Sachet d'écrous et joints de vidange



#### BOD10XNWS

M13x1.25	1 BOD101NWS
M13x1.5	1 BOD102NWS
M15x1.5	1 BOD103NWS
M17x1.5	1 BOD104NWS
M20x1.5	1 BOD105NWS
M22x1.5	1 BOD106NWS

### Récupérateur d'huile par aspiration, capacité 90 L



#### BOD8902

mm	
1000 x 413 x 632 mm	1 BOD8902

### Récupérateur d'huile mixte avec réservoir de 90 L et pré-chambre 9 L



#### BOD8903A

mm	
1700 x 419 x 608 mm	1 BOD8903A

### Récupérateur d'huile par gravité, capacité 90 L



#### BOD8901

mm	kg	
1000 x 413 x 630 mm	32	1 BOD8901

Extension d'entonnoir pour récupérateurs d'huile



**BOD8901AC1**

 620 x 620 x 150 mm  1 BOD8901AC1

Réservoir pour remplissage d'huile de transmission





**BOD6080P12**

 595 x 255 x 330 mm  1 BOD6080P12

Adaptateur pour réservoir BOD6080P12



**BOD6080P12-01**

 35  1 BOD6080P12-01

Adaptateur pour réservoir BOD6080P12



**BOD6080P12-02**

 55  1 BOD6080P12-02

Adaptateur pour réservoir BOD6080P12



**BOD6080P12-03**

 45  1 BOD6080P12-03

Adaptateur pour réservoir BOD6080P12



**BOD6080P12-04**

 6  1 BOD6080P12-04

Adaptateur pour réservoir BOD6080P12



**BOD6080P12-05**

 25  1 BOD6080P12-05

Adaptateur pour réservoir BOD6080P12



**BOD6080P12-06**

 25  1 BOD6080P12-06

Adaptateur pour réservoir BOD6080P12



**BOD6080P12-07**

 45  1 BOD6080P12-07

Adaptateur pour réservoir BOD6080P12



**BOD6080P12-08**

 45  1 BOD6080P12-08

Adaptateur pour réservoir BOD6080P12



**BOD6080P12-09**

 15  1 BOD6080P12-09



Adaptateur pour réservoir BOD6080P12



**BOD6080P12-10**

g 85 1 BOD6080P12-10

Adaptateur pour réservoir BOD6080P12



**BOD6080P12-11**

g 105 1 BOD6080P12-11

Entonnoir pour huile, capacité 1,2 L



**BOD301200**

mm 225 x 165 x 165 mm 1 BOD301200

Bac de vidange d'huile 8 L



**BOD2008**

mm 8 115 x 325 x 590 mm 1 BOD2008

Bac de vidange d'huile 16 L



**BOD1016**

mm 16 170 x 450 x 570 mm 1 BOD1016

Taraut à l'unité



**BOD10XT**

B	C	
28 mm	13	1 BOD101T
32 mm	13	1 BOD102T
32 mm	15	1 BOD103T
42 mm	17	1 BOD104T
42 mm	20	1 BOD105T
38 mm	22	1 BOD106T

Broc 2L avec bec verseur flexible



**BOD2FS**

mm 2 330 x 130 x 380 mm 20 BOD2FS

Pompe de transvasement pour bidons de 50 à 205 litres



**BOD70**

mm 230 x 250 x 1330 mm 1 BOD70

Pompe à graisse à levier



**BOD60**

mm 875 x 57 x 245 mm 1 BOD60

Pistolet graisseur professionnel



**BOD5HD400**

mm 60 x 115 x 360 mm 1 BOD5HD400

Pistolet graisseur à cartouche



**BOD5400/BOD5450**

55 x 120 x 390 mm	1 BOD5400
65 x 125 x 385 mm	1 BOD5450

Flexible pour graissage



**BOD54-1 / -2**

4.1	10.8	1	BOD54-1
4.1	10.8	1	BOD54-2

Connecteur hydraulique



**BOD54-3**

37	1 BOD54-3

**OUTILS ET ÉQUIPEMENTS POUR  
SYSTÈME DE FREINAGE**

Stylo testeur de liquide de freins



**BBR100**

20 x 20 x 150 mm	1 BBR100

Testeur de liquide de freins  
Indice de chauffe DOT 3/4/5/5.1



**BBR110**

35 x 65 x 160 mm	1 BBR110

Clés pour écrous de purge de frein



**BBR501011-BBR50121314**

3/8	10/11	50	BBR501011
3/8	12/14	50	BBR50121314

Purgeur de liquide de freins



**BBR350**

1/4"	300 x 125 x 125 mm	1 BBR350

Purgeur de frein électrique 12 V



**BBRBB12**

895 x 390 x 395 mm	14.6 kg	1 BBRBB12

Kit bouchons pour purgeurs de frein



**BBRAS14**

PN5 in	85 x 350 x 445 mm	4 BBRAS14



## Bouchons pour purgeur de freins



### BBRAS14-01/BBRAS14-14

Icon	Car Icon	Box Icon	Fish Icon
PN5 in	Universal	1	BBRAS14-01
PN5 in	Honda	1	BBRAS14-02
PN5 in	Honda Accord	1	BBRAS14-03
PN5 in	Universal	1	BBRAS14-04
PN5 in	Chrysler, Jeep, Plymouth	1	BBRAS14-05
PN5 in	Chrysler, Jeep, Plymouth, Dodge	1	BBRAS14-06
PN5 in	Nissan	1	BBRAS14-07
PN5 in	Alfa Romeo, Fiat, Peugeot, Citroën, Audi, BMW, Jaguar, Land-Rover, Mercedes, Porsche, Renault, Saab, VW, Volvo, Chrysler, Daewoo, Ford, Kia, Mazda, Mini, etc	1	BBRAS14-08
PN5 in	Hyundai, Mitsubishi, Nissan, Subaru, Chrysler, Dodge, Ford, etc.	1	BBRAS14-09
PN5 in	GM Models and Mazda	1	BBRAS14-10
PN5 in	Toyota and Lexus	1	BBRAS14-11
N/A in	Holder for universal adaptor	1	BBRAS14-12
N/A in	Syringe	1	BBRAS14-13
N/A in	Hooks, chains and roulettes for BBRAS14-01 and BBRAS14-04	1	BBRAS14-14

## Jauge d'épaisseur de plaquette de freins



### BBRPTG1

g	Box Icon	Fish Icon
68	10	BBRPTG1

## Micromètre à pied magnétique



### 1154

mm	Box Icon	Fish Icon
230 x 50 x 75 mm	1	1154

1154-DG

1154-MB

## Comparateur digital



### 1154-DG

L	mm	Box Icon	Fish Icon
0-10	0.01	1	1154-DG

## Support de base magnétique



### 1154-MB

mm	L	Box Icon	Fish Icon
70 x 96 x 297 mm	230 + 150	1	1154-MB

## Pied à coulisse aluminium



### BBR400

mm	Box Icon	Fish Icon
6 x 89 x 120 mm	1	BBR400

## Pied à coulisse digital pour disques de freins



### BBR420

L	mm	Box Icon	Fish Icon
0-60 mm	35 x 104 x 176 mm	50	BBR420

Pied à coulisse pour mesurer le diamètre des disques et tambours de freins



**BBR410**

20 x 210 x 280 mm	0.610 kg	24	BBR410

Pied à coulisse digital pour disque de frein

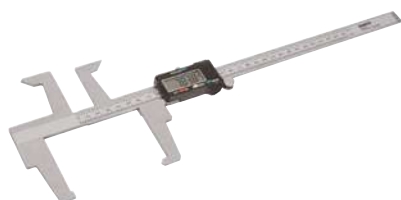

**BBR405**

20	BBR405

Repousse piston pneumatique



**BBR320**

3/8"	1/4"	1	BBR320

Coffret repousse piston manuel - 50 coupelles Carré 3/8"



**BBR300P50**

82 x 350 x 425 mm	5.56	1	BBR300P50

Coffret de 9 douilles à chocs 1/2" avec embouts Torx®, pour frein  
9 pièces



**BBR203P9**

68 x 225 x 225 mm	1	BBR203P9

BBR203P925, BBR203P960, BBR203P930, BBR203P927, BBR203P920, BBR203P945, BBR203P955, BBR203P940, BBR203P950

Douille à choc 1/2" avec embouts Torx® pour freins



**BBR203P920-BBR203P960**

T20	78 mm	1	BBR203P920
T25	78 mm	1	BBR203P925

T27	78 mm	1	BBR203P927
T30	78 mm	1	BBR203P930
T40	78 mm	1	BBR203P940
T45	78 mm	1	BBR203P945
T50	78 mm	1	BBR203P950
T55	78 mm	1	BBR203P955
T60	78 mm	1	BBR203P960

Coffret de 6 douilles à chocs XZN 1/2", pour freins



**BBR201P6**

68 x 225 x 225 mm	8	BBR201P6

BBR201P67814, BBR201P67816, BBR201P67818, BBR201P64018, BBR201P64014, BBR201P64016

Douille à chocs XZN 1/2", pour freins



**BBR201P64014-BBR201P67818**

M14	40 mm	1	BBR201P64014
M16	40 mm	1	BBR201P64016
M18	40 mm	1	BBR201P64018
M14	78 mm	1	BBR201P67814
M16	78 mm	1	BBR201P67816
M18	78 mm	1	BBR201P67818



Coffret de douilles 1/2" pentagonales et embouts, pour frein à main



### BBR202P4

43 x 90 x 200 mm	1 BBR202P4 1 BBR202P410 1 BBR202P414 1 BBR202P419 1 BBR202P455

Coffret pour le montage et le démontage des ressorts de frein



### BBR210P3

80 x 270 x 375 mm 25 x 59 x 182 mm 75 x 270 x 350 mm	1 BBR210P3 1 BBRS210P 1 BBRS210P2

Pince à tête pivotante pour enlever les ressorts de freins



### BBR6135

335	1 BBR6135

Pince pour enlever les ressorts de frein



### BBR6131

210	1 BBR6131

Pince pour ressort câble de frein



### BBR204

6 BBR204

Pincettes métalliques pour tuyaux flexibles



### BBR150i

24 BBR150i

Coffret presse à collets pour tuyaux de frein



### BBRFKM1

141 x 115 x 195 mm	1551	12 BBRFKM1

## OUTILS POUR ROUES ET TRANSMISSION

Clé en croix à 4 branches



### 29-B/BWXW1/BWXW2

17,19,21	1/2"	1 29-B
17,19,22	1/2"	1 BWXW1
24,27,32	3/4"	1 BWXW2
17, 19, 21, 22	-	1 BWXW3
24, 27, 32, 38	-	1 BWXW4

Coffret de 3 douilles à chocs pour roues 17, 19, 21 mm



### BWSS12P3

17, 19, 21 mm	45 x 125 x 145 mm	20 BWSS12P3

BWSS12P317, BWSS12P319, BWS-  
S12P321



Outil pour rotule axiale



**BS54**



57 x 57 x 70 mm

1 BS54

Coffret de 5 douilles à chocs pour roues 17, 19, 21, 22, 24 mm



**BWSS12P5**



17, 19, 21, 175 x 240 x  
22, 24 mm 50 mm

1 BWSS12P5

BWSS12P319, BWSS12P317,  
BWSS12P524, BWSS12P522, BWS-  
S12P321

Douille pour jantes aluminium



**BWSS12P**



1/2 mm	17 mm	1	BWSS12P317
1/2 mm	19 mm	1	BWSS12P319
1/2 mm	21 mm	1	BWSS12P321
1/2 mm	22 mm	1	BWSS12P522
1/2 mm	24 mm	1	BWSS12P524

Douille à choc pour roues 15 mm



**BWSMB15**

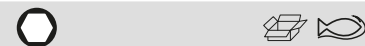

15 mm

25 BWSMB15

Douille à choc 17 mm anti-voil véhicules Mercedes



**BWSMB17**

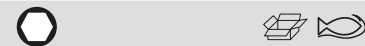

17 mm

1 BWSMB17

Douille à choc anti-voil 21 mm pour Hyundai et KIA



**BWSHK21**



1/2" in 21 mm

25 BWSHK21

Coffret de 3 douilles à chocs longues 1/2" pour roues 17, 19 et 21 mm



**BWSS12P3L**



17, 19, 21 mm 68 x 225 x 225 mm

1 BWSS12P3L

BWSS12P317L, BWSS12P319L, BWSS12P321L

Douille à choc longue 1/2" pour roues 17, 19 et 22mm



**BWSS12PL**



1/2 in	17 mm	1	BWSS12P317L
1/2 mm	19 mm	1	BWSS12P319L
1/2 mm	21 mm	1	BWSS12P321L

Sac pour écrous et boulons



**BWBB**



0.023 kg 180 x 1 x 300 mm 200 BWBB



Coffret de douilles à torsion longues 1/2", 17, 19 et 21 mm



**BWTSP3L**

68 x 225 x 150 mm	1	BWTSP3L

BWTSP317L, BWTSP319L, BWTSP321L

Douille à torsion longue 1/2", 150 mm



**BWTS317L-BWTSP321L**

1/2 in	17	1	BWTSP317L
1/2 in	19	1	BWTSP319L
1/2 in	21	1	BWTSP321L

Coffret de douilles à torsion longues 1/2": 17, 19, 21, 22, 24 mm



**BWTSP6**

55 x 105 x 217 mm	1	BWTSP6

BWTSP619, BWTSP617, BWTSP622, BWTSP621, BWTSP624

Douille à torsion longues 1/2"



**BWTSP617-BWTSP624**

17	1/2 in	1	BWTSP617
19	1/2 in	1	BWTSP619
21	1/2 in	1	BWTSP621
22	1/2 in	1	BWTSP622
24	1/2 in	1	BWTSP624

Coffret de douilles à torsion 1/2" - 3/4"



**BWTSP7**

52 x 117 x 207 mm	1	BWTSP7

Coffret de douilles à torsion 3/8" - 1/2"



**BWTSP16**

48 x 125 x 245 mm	1	BWTSP16

Douille à torsion



**BWTSP**

8	3/8" mm	1	BWTSP1608
10	3/8" mm	1	BWTSP1610
11	3/8" mm	1	BWTSP1611
12	3/8" mm	1	BWTSP1612
13	3/8" mm	1	BWTSP1613
14	3/8" mm	1	BWTSP1614
16	3/8" mm	1	BWTSP1616
17	3/8" mm	1	BWTSP1617
18	3/8" mm	1	BWTSP1618
19	3/8" mm	1	BWTSP1619
21	1/2" mm	1	BWTSP1621
22	1/2" mm	1	BWTSP1622
24	1/2" mm	1	BWTSP1624
27	1/2" mm	1	BWTSP1627
32	1/2" mm	1	BWTSP732
36	3/4" mm	1	BWTSP736
41	3/4" mm	1	BWTSP741

Coffret de tarauds



**BWHTRS12**

225 x 67 x 225 mm	1350 g	15	BWHTRS12

Coffret de 5 barres de torsion 1/2" conçu pour déserrer les écrous de roues avec une clé à choc sans dépasser le couple recommandé



### BWTB12P5

68 x 225 x 280 mm	1.74 kg	1 BWTB12P5

BWTB12P90, BWTB12P100, BWTB12P110, BWTB12P120, BWTB12P135

Barre de torsion 1/2" pour déserrer les écrous de roues avec une clé à choc sans excéder le couple recommandé



### BWTB12P90-BWTB12P200

	Nm	
200	100 Nm	1 BWTB12P100
200	110 Nm	1 BWTB12P110
200	120 Nm	1 BWTB12P120
200	135 Nm	1 BWTB12P135
200	150 Nm	1 BWTB12P150
200	160 Nm	1 BWTB12P160
200	175 Nm	1 BWTB12P175
200	190 Nm	1 BWTB12P190
200	200 Nm	1 BWTB12P200
200	90 Nm	1 BWTB12P90

Barre de torsion pour douille à choc 1"



### BZWTB

32	450	1 BZWTB0132450
32	600	1 BZWTB0132600
33	600	1 BZWTB0133600

Démonte-pneus



### 38-8 - 38-24

200	5 38-8
300	5 38-12
400	5 38-16
500	2 38-20
600	1 38-24

Démonte-pneus



### 38A

200 mm	25 38A-08
240 mm	25 38A-10
304	1 38A-12
382	25 38A-15
537	1 38A-21
655	1 38A-26

Démonte pneu pour véhicules commerciaux et camions



### 38C

645	1 38C-26

Démonte-pneus forme courbée spéciale camions



### 39-24

605	1 39-24

Cale roue



### BWC1

75 x 77 x 110 mm	25 BWC1

Pince à masse d'équilibrage



### BWP150

20 x 87 x 255 mm	1 BWP150



### Jauge digitale de profondeur des pneus



#### BWTDG1

0 - 25 mm	30 x 76 x 156 mm	50 BWTDG1

### Jauge de pression des pneus



#### BWTPG1

20 x 90 x 394 mm	10 BWTPG1

### Kit pour capteurs de pression des pneus



#### BWTPMSS9

68 x 225 x 225 mm	1049	8 BWTPMSS9

### Outil de serrage contrôlé de capteur de pression de pneu



#### BWTVCTT355

0.45 Nm	0.33 lb-ft	1 BWTVCTT355

### Capuchons de dégonflement des buses de pneu



#### BWTPMSS4C

27 x 59 x 108 mm	60	25 BWTPMSS4C

### Coffret de douilles à chocs 1/2" et embouts



#### BT15P5

60 x 85 x 255 mm		1 BT15P5

### Douille à chocs 1/2" 12 pans



#### BT15P524-BT15P532

1/2"	24	1 BT15P524
1/2"	30	1 BT15P530
1/2"	32	1 BT15P532
1/2" mm	36	1 BT15P536

### Douille à choc 3/4" spéciale pour poids lourds Scania, Volvo



#### BHVIS08

3/4 mm	95	1 BHVIS0895
3/4 mm	100	1 BHVIS08100
3/4 mm	115	1 BHVIS08115
	109	1 BHVIS109BPW12
	120	1 BHVIS120BPW16

### Douille à choc 1" parois extra-fines



#### BHVIS12 / BHVIS06

12	68	1 BHVIS1265
6	70	1 BHVIS0670
6	77	1 BHVIS0677
6	80	1 BHVIS0680
6	85	1 BHVIS0685
6	90	1 BHVIS0690
6	95	1 BHVIS0695
6	100	1 BHVIS06100
6	105	1 BHVIS06105

Douille à choc spéciale essieux BPW



**BHVISxxBPW**

3/4" mm	111	1	BHVIS111BPW12
3/4 mm	80	1	BHVIS80BPW12
3/4 mm	95	1	BHVIS95BPW9

Extracteur de moyeu avec marteau coulissant et vérin hydraulique



**BWHEPSSH8**

12 t / 265-282 mm	#4-5 / 116-135	1	BWHEPSSH8

Extracteur de moyeu avec broche hydraulique



**BWHEPS**

12	#4-5 / 116-135	1	BWHEPS

<b>BWHEP</b>	
<b>BWHEHS</b>	

Jeu d'extracteur de moyeu et marteau coulissant



**BWHEPSH8**

#4-5 / 116-135	960 x 150 x 150 mm	1	BWHEPSH8

Extracteur de moyeu



**BWHEP**

#4-5 / 116-135	90 x 147 x 147 mm	1	BWHEP

Broche hydraulique 12 T



**BWHEHS**

12	265-282	1	BWHEHS

Marteau coulissant 5kg



**BWSH5**

100 x 100 x 985 mm		2	BWSH5

Marteau coulissant 8 kg



**BWSH8**

960 x 100 x 100 mm		1	BWSH8

<b>BWSH5</b>	
<b>BWSH51</b>	
<b>BSSHE3</b>	

Masse 3,5 Kg



**BSSHE3**

60	100	1	BSSHE3



Adaptateur M18



**BWSH51**



M38 M18x38 1 BWSH51

Pince de serrage pour collier inoxydable



**BE251200**

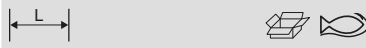

170 1 BE251200

Coffret d'outils de démontage de biellettes de direction



**BS52**



110 x 315 x 380 mm 3,08 kg 1 BS52

Cage pour outil de démontage de biellettes de direction



**BS5228-BS523945**

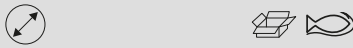

28-34 mm 1 BS5228341  
34-40 mm 1 BS5234401  
39-35 mm 1 BS5239451

Expandeur pneumatique de soufflets de cardan



**BPCVB1**



25-110 mm 138 x 138 x 455 mm 6 BPCVB1

Douille pour embout de biellette de direction



**BS56**



6 BS56

Sangle et boucles inoxydables 5mm



**BE2512005**

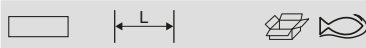

5 12 1 BE2512005

Sangle et boucles inoxydables 8mm



**BE2512008**

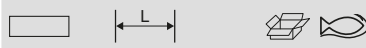

8 15 1 BE2512008

Douille Excentrique BMW



**BS45BMW**



20 BS45BMW

Outil de réglage de carrossage VAG



**BS40VAG**



20 BS40VAG

Coffret d'extraction hydraulique pour le montage et démontage des roulements et silentblocks



**BT20P49**



164 x 520 x 890 mm

1 BT20P49

Outils de pose et repose des rotules supérieures de suspensions de T4 VW



**4594VWT4**



245 x 112 x 320 mm

5 4594VWT4

Coffret pour pose et extraction des roulements de roues



**BWB14**



80 x 300 x 525 mm

2 BWB14

Extracteur de fourches



**BS6**

**A**



21 400 mm

1 BS618

26 400 mm

1 BS623

Douille pour rotule - PSA



**BS100PSA1**



56

52

1 BS100PSA1

Coffret de montage-démontage des roulements à bille et joints de roulement



**BT20P26**



150 x 310 x 535 mm

1 BT20P26

Kit extracteur de rotule avec vérin hydraulique 12T



**BWHPJ12**



12

70 mm

4 BWHPJ12

Coffret d'outils pour embrayages SAC



**BE301**



2 BE301



Centreurs d'embrayages SAC et non SAC



**BE301CM-SET**



50 BE301CM

BE301CM-01, BE301CM-02

Kit de 2 centreurs d'embrayages SAC et non SAC



**BE301CM**



15.19	174 mm	20	BE301CM-01
20.26	174 mm	20	BE301CM-02

Coffret d'outils de centrage pour embrayages



**BE310**



68 x 225 x 280 mm 1.14 8 BE310

**ÉQUIPEMENTS ET OUTILS POUR SUSPENSION**

Levier dépose bride d'amortisseur



**BS20**



35 x 210 x 1225 mm 5.08 1 BS20

Bras de levier pour suspension



**BS25**



20 Nm 200 1 BS25

Compresseur de ressort Macpherson



**BS15**



125 x 425 x 510 mm	1	BS15
43 x 110 x 160 mm	1	BS15125
165 x 160 x 385 mm	1	BS15125C
42 x 160 x 160 mm	1	BS15160
42 x 160 x 170 mm	1	BS15160C
42 x 160 x 212 mm	1	BS15212
24 x 160 x 215 mm	1	BS15212C
45 x 56 x 95 mm	1	BS1550

Compresseur de ressort mécanique



**BS10MEC**



1180 x 500 x 625 mm 66.2 1 BS10MEC

Compresseur de ressorts double piston pneumatique avec grille de protection



**BS30PG**



1180 x 500 x 625 mm 24 1 BS30PG



Adaptateur pour compresseur de ressort



**BS10AC2**

400 x 400 x 200 mm 1 1 BS10AC2

Support/extension mobile



**BS30AC1**

336 x 545 x 450 mm 1 BS30AC1

Coffret de révision d'amortisseur - 39 pièces



**BS1000**

70 x 405 x 575 mm 1 BS1000  
1 BS100001  
1 BS100002  
1 BS100003



- 1 BS100004
- 1 BS100005
- 1 BS100006
- 1 BS100007
- 1 BS100008
- 1 BS100009
- 1 BS100010
- 1 BS100011
- 1 BS100012
- 1 BS100013
- 1 BS100014
- 1 BS100015
- 1 BS100016
- 1 BS100017
- 1 BS100018
- 1 BS100019
- 1 BS100020
- 1 BS100021
- 1 BS100022
- 1 BS100023
- 1 BS100024
- 1 BS100025
- 1 BS100026
- 1 BS100027
- 1 BS100028
- 1 BS100029
- 1 BS100030
- 1 BS100031
- 1 BS100032
- 1 BS100033
- 1 BS100034
- 1 BS100035
- 1 BS100036
- 1 BS100037
- 1 BS100038
- 1 BS100039

**OUTILS ÉLECTRIQUES ET DE GESTION DE BATTERIE**

Détecteur de sauvegarde des données 12V



**BELMS12OBDL**

40 x 70 x 140 mm 8 BELMS12OBDL

BOOSTER HYBRIDE 12V À CONDENSATEUR



**BBH12-1200**

12 V 1200 A 1 BBH12-1200

Booster 12 V - 1200 CA



**BBA12-1200**

12 1200 1 BBA12-1200

Booster 12/24 V - 1.700/900 CA



**BBA1224-1700**

12/24 1700/900 1 BBA1224-1700



Booster ULTRA PUISSANT 12/24 V - 1600/3200 CA



**BBA1224-3200**

<b>V</b>	<b>CA</b>		
12/24 V	3200/1600 A	1	BBA1224-3200

Batterie 12V et 8Ah Lithium Fer phosphate



**BBL800A**

<b>V</b>			
12 V	8 A·h	1	BBL800A

Batterie de rechange pour boosters 12V



**BB1200A**

<b>V</b>		
12 V	1	BB1200A

Adaptateur USB/Micro pour BBL12-400



**BBL12-40001**

	<b>g</b>		
8 x 100 x 180 mm	10	1	BBL12-40001

Chargeur allume-cigare 12V pour BBL12-400



**BBL12-40002**

<b>g</b>		
25	1	BBL12-40002

Câbles de démarrage



**BBJL**

16	3	5	BBJL1630
25	3.5	1	BBJL2535
35	4.5	1	BBJL3545

Chargeur / mainteneur de charge automatique 12Ampères pour batteries 6/12V



**BBCE612-2**

<b>g</b>			
760	2	BBCE612-2	

Chargeur / mainteneur de charge automatique 3 Ampères pour batteries 12V et batteries Lithium LiFeP04



**BBCE12-3**

<b>V</b>	<b>A</b>			
12 V	3 A	2	BBCE12-3	

Chargeur / mainteneur de charge automatique 6 Ampères pour batteries 12V



**BBCE12-6**

<b>V</b>	<b>A</b>			
12 V	6 A	2	BBCE12-6	

Chargeur / mainteneur de charge automatique  
automatique 10 Ampères pour batteries 12V



**BBCE12-10**

<b>V</b>	<b>A</b>	
12 V	10 A	1 BBCE12-10

Chargeur / mainteneur de charge automatique 15  
Ampères pour batteries 12V avec mode show-room



**BBCE12-15S**

1730	2 BBCE12-15S

Chargeur / mainteneur de charge automatique 10  
Ampères pour batteries 24V



**BBCE24-10**

1460	2 BBCE24-10

Chargeur / mainteneur de charge automatique 100  
Ampères pour batteries 12V



**BBCE12-F100**

<b>V</b>	<b>A</b>	
12 V	4/20/70/100A	1 BBCE12-F100

Chargeur / Démarrateur automatique de batterie sur  
roues



**BBC420-BBC620**

<b>V</b>	
230	1 BBC420
230	1 BBC620

Testeur d'acide des batteries



**BB10**

50 x 50 x 285 mm	1 BB10

Application : Vérifier la densité de l'acide de batterie

Testeur digital de batterie 12 V



**BBT20**

90 x 160 x 345 mm	1 BBT20

Testeur digital de batteries 6 / 12 V



**BBT60**

228 x 285 x 80 mm	12 BBT60

Testeur digital de batteries 6 / 12 V avec imprimante



**BBT80**

64 x 130 x 251 mm	6 BBT80



Multimètre digital, True RMS, 1000 V et connexion pour PC



**BMMTRMS1**

155 x 60 x 225 mm 0,8 kg 1 BMMTRMS1

Testeur de prise de courant 13 pôles 12V  
Câble: 4 m



**BELT1213**

38 x 82 x 155 mm 1 BELT1213

Testeur de prise de courant 7 pôles 24 V (24S)  
Câble 4 m



**BELT247S**

35 x 63 x 155 mm 1 BELT247S

Testeur de clés infrarouge (IR) et radio fréquence (RF)



**BELTKEY**

35 x 63 x 160 mm 1 BELTKEY

Testeur de prise de courant 15 pôles 24 V  
Câble 4 m



**BELT2415**

38 x 83 x 155 mm 1 BELT2415

Fer à souder professionnel au gaz



**BGIS125**

25-125 W 46 x 88 x 295 mm 20 BGIS125

Testeur de prise de courant 7 pôles 12 V



**BELT127**

35 x 63 x 160 mm 1 BELT127

Testeur de prise de courant 7 pôles 24 V (24N)  
Câble 4 m



**BELT247N**

55 x 63 x 160 mm 1 BELT247N

Jeu de 16 pinces composants électriques



**BELTRP16**

58 x 215 x 265 mm 1 BELTRP16  
1 BELTRP1601

1	BELTRP1602	
1	BELTRP1603	
1	BELTRP1604	
1	BELTRP1605	
1	BELTRP1606	
1	BELTRP1607	
1	BELTRP1608	
1	BELTRP1609	
1	BELTRP1610	
1	BELTRP1611	
1	BELTRP1612	
1	BELTRP1613	
1	BELTRP1614	
1	BELTRP1615	
1	BELTRP1616	

Protecteur de surtension 12/24V



<b>BELP1224</b>			
35 x 63 x 160 mm	1	BELP1224	

Câbles de batteries longueur 400 mm pour BBL12-400



<b>BBL12-40005</b>			
125	1	BBL12-40005	

Protection de pics électriques 12V



<b>BELMS12</b>			
37 x 125 x 600 mm	25	BELMS12	

Chargeur mural Ac (avec base multi-adaptateur) pour BBL12-400



<b>BBL12-40003</b>			
130	1	BBL12-40003	

Port adaptateur 12V DC pour BBL12-400



<b>BBL12-40006</b>				
31 x 100 x 160 mm	25	1	BBL12-40006	

Protecteur de mémoires 12 V



<b>BELS12</b>			
35 x 63 x 160 mm	1	BELS12	

Jeu de 3 adaptateurs muraux AC (C, G, I) pour BBL12-400



<b>BBL12-40004</b>			
45	1	BBL12-40004	

Câbles de batteries (connexion rapide) pour chargeurs BBCE12-10 et BBCE24-10



<b>BBCEC1</b>			
68	1	BBCEC1	



Etui pour BBL12-400



**BBL12-40007**

63 x 190 x 390 mm	255	1	BBL12-40007

Connecteurs (connexion rapide) pour chargeurs BBCE612-2, BBCE12-3 et BBCE12-6



**BB CER1**

100	1	BB CER1

Câbles de batteries (connexion rapide) pour chargeurs BBCE612-2, BBCE12-3 et BBCE12-6



**BBCEC2**

68	1	BBCEC2

Connecteurs (connexion rapide) pour chargeurs BBCE12-10 et BBCE24-10



**BB CER2**

100	1	BB CER2

Chargeur de boosters automatique et électronique



**BBBC**

55 x 85 x 165 mm	1	BBBC2A
55 x 85 x 166 mm	1	BBBC4A

Prises de rechange pour chargeurs de boosters Australie, Europe et Royaume Uni



**BBBCAB**

50 x 125 x 50 mm	1	BBBCAB-AUZ
50 x 125 x 50 mm	1	BBBCAB-EU
50 x 50 x 50 mm	1	BBBCAB-UK

Fusible pour booster 16A



**BBS702026**

14 x 115 x 160 mm	15	15	BBS702026

Fusible 500A pour booster



**BBS702028**

9 x 120 x 168 mm	500	1	BBS702028

Câble allume-cigare 12V pour booster BBA12-1200, BBA1224-1700



**BBSNL4FX001**

26 x 50 x 50 mm	12 V	1	BBSNL4FX001

Câble prise allume cigare 12V



**BBACCC12V**

1	BBACCC12V

## PRESSES ET ACCESSOIRES

Presse hydraulique 15T



**BH715**

15.000	1	BH715

Presse hydrauliques 20 T, 30 T et 50 T

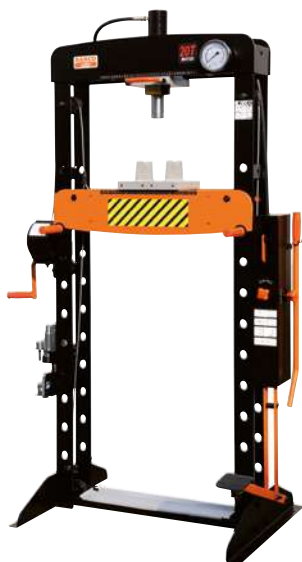

**BH720/BH730/BH750**

20.000	1	BH720
30.000	1	BH730
50.000	1	BH750

Presse hydraulique 100 T



**BH7100A**

100000 kg	1	BH7100A

Jeu de poinçons et adaptateurs pour presses hydrauliques



**BH715-13**

7.09	1	BH715-13
7.09	1	BH720-22

Grille anti-projection pour presse hydraulique

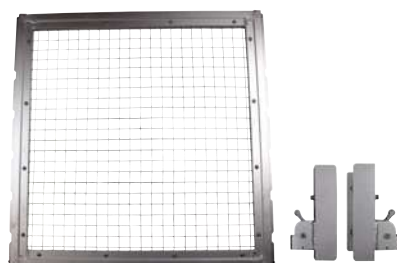

**BH7**

530	20	1	BH720SG
590	20	1	BH730SG
625	20	1	BH750SG

Grille anti-projection pour presse hydraulique 100T



**BH7100SG**

150 x 593 x 625 mm	5.54 kg	1	BH7100SG

## OUTILS ET ÉQUIPEMENTS AUTOMOBILE

Jeu de 4 housses de protection pour roues et pneus



**BWB1418S4/BWB1922S4**

355 - 470 mm	6	BWB1418S4
470 - 560 mm	6	BWB1922S4

Coupele magnétique



**1419-MD**

150	1	1419-MD



Plateau rectangulaire magnétique avec extension PVC  
240 x 140 mm



**BMR240**



250

1 BMR240

Coupelette magnétique avec extension PVC



**BMD150**



160

1 BMD150

Tabouret d'atelier pneumatique matelassé



**BLE305**



430 x 410 x 430 mm

1 BLE305

Tabouret mobile avec tiroirs



**BLE300**

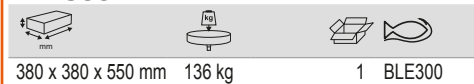

380 x 380 x 550 mm

136 kg

1 BLE300

Chariot de visite et tabouret 2 en 1



**BLE302**

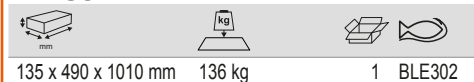

135 x 490 x 1010 mm

136 kg

1 BLE302

Chariot de visite bas



**BLE301**

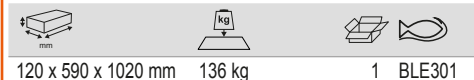

120 x 590 x 1020 mm

136 kg

1 BLE301

Kit avec chariot et tabouret



**BLE304**

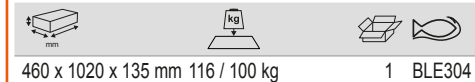

460 x 1020 x 135 mm

116 / 100 kg

1 BLE304

Couvre siège



**5750**



1390

1 5750

Bâche de protection de carrosserie



**BBS50**



900

1.2

1 BBS50



Réglophare double visée laser



**BLBT100**

1650 x 500 x 565 mm	1 BLBT100

Rail optionnel pour réglophare BLBT100



**BLBT100AC1**

150 x 150 x 1025 mm	7.77 kg
	1 BLBT100AC1

Coffret de leviers à tête articulée



**BT10P3**

80 x 270 x 375 mm	1 BT10P3

Levier à tête articulée



**BT10P325-BT10P338**

250	40 BT10P325
300	1 BT10P330
375	1 BT10P338

Jeu de 4 barres levier



**BPBLS4**

78 x 255 x 1000 mm	9050 g	2 BPBLS4

BPBL00900, BPBL30900, BPBL70600, BPBL90600

Barres de levier longues



**BPBL**

930	5 BPBL00900
925	5 BPBL30900
610	5 BPBL70600
628	5 BPBL90600

**OUTILS POUR CARROSSERIE**

Support pour pièces de carrosserie avec ventouses



**BBS3BH1**

955 mm	1 BBS3BH1

Ventouse pour support de pièces de carrosserie



**BBS3BH1-VP**

60 x 95 x 95 mm	40 BBS3BH1-VP

Support pièces d'atelier



**BBS3UH**

950 x 800 x 1200 mm	20 kg	1 BBS3UH



Ventouse caoutchouc



**BBS075**

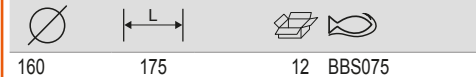

160 175 12 BBS075

Kit de deux doubles ventouses et sangle



**BBS150**

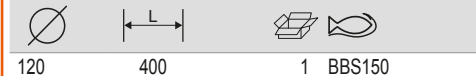

120 400 1 BBS150

Outil pour retirer les débris de verre pour pare-brises



**BBS106**



25 x 25 x 332 mm 0.145 1 BBS106

Poignée droite pour fil de démarreur



**BBS103**

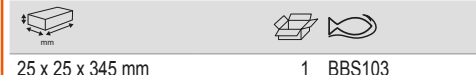

25 x 25 x 345 mm 1 BBS103

Pousseur de fil pour pare brise, poignée T



**BBS102**

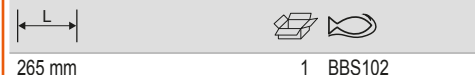

265 mm 1 BBS102

Jeu de 2 poignées de protection pour coupe-joints de pare-brise



**BBS101**

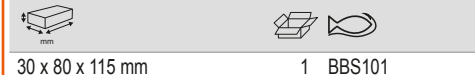

30 x 80 x 115 mm 1 BBS101

Fil pour démonter les pare-brises



**BBS150S**

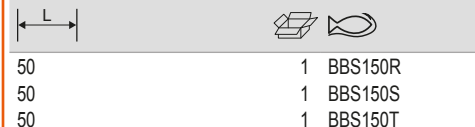

50 1 BBS150R  
50 1 BBS150S  
50 1 BBS150T

Outil pour découper les bordures de pare-brise



**BBS105**



20 x 90 x 200 mm 1 BBS105

Couteau spécifique pour découpe bare-brises uréthane



**BBS10450**

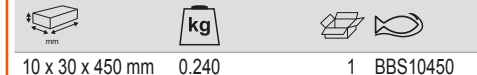

10 x 30 x 450 mm 0.240 1 BBS10450

Jeu de 3 lames droites pour couteau découpe pare-brise



**BBS107**



1 x 18 x 125 mm 1 BBS107

Jeu de 3 lames pointes courbes pour couteau découpe pare-brise



**BBS108**

	
20 x 19 x 88 mm	1 BBS108

Extracteur de bras d'essuie glace





**BBS165**



	
117 x 25 x 78 mm	10 BBS165

Coffret d'extraction de bras essuie glace



**BBS170P13**

	
80 x 275 x 375 mm	1 BBS170P13 1 BBS170P131 1 BBS170P132 1 BBS170P133

	
	1 BBS170P134 1 BBS170P135 1 BBS170P136 1 BBS170P137 1 BBS170P138 1 BBS170P139 50 BBS165SP4

Tire clous à inertie 12 kg



**BBS12SH**

		
800 mm	12 kg	1 BBS12SH

Batte à rétreindre - Surface lisse



**BBSH1F**

	
50x30	1 BBSH1F

Batte à rétreindre - Surface striée



**BBSH1M**

	
50x30	1 BBSH1M

Marteau à planer - Tête ronde bombée



**BBSH2C**

	
40	1 BBSH2C

Marteau à planer - Tête ronde bombée



**BBSH2CA**

	
40	12 BBSH2CA

Marteau à planer - Tête ronde bombée  
Embout conique



**BBSH2CP**

	
40	6 BBSH2CP

Marteau à planer - Tête ronde lisse



**BBSH2F**

	
40	6 BBSH2F



Marteau à planer - Tête carrée lisse  
Tête ronde bombée



**BBSH3CF**



40 37 6 BBSH3CF

Marteau à planer - Tête carrée lisse  
Tête ronde bombée



**BBSH3CF30**



30 25 6 BBSH3CF30

Marteau à planer - Tête carrée striée  
Tête ronde lisse



**BBSH3FS**



37 40 6 BBSH3FS

Marteau à planer - Tête carrée lisse  
Tête ronde striée



**BBSH3MF**



30 27 1 BBSH3MF

Manche de rechange pour la gamme de marteaux  
BBSH



**BBSHWH1**



160 1 BBSHWH1

Tas américain



**BBSDA**



30 x 63 x 83 mm 1 BBSDA

Tas talon



**BBSDH**



30 x 60 x 79 mm 1 BBSDH

Tas américain plat



**BBSDT**



26 x 58 x 120 mm 6 BBSDT

Tas virgule



**BBSDC**



40 x 58 x 128 mm 6 BBSDC

Tas épinoir



**BBSDW**



25 x 64 x 112 mm 6 BBSDW

Tas diablo



**BBSDD**



55 x 55 x 55 mm 1 BBSDD

Tas caoutchouc



**BBSDHR**



40 x 62 x 75 mm 1 BBSDHR

Palette pour atelier de carrosserie



**BBSS1**



25 x 56 x 390 mm

1 BBSS1

Levier double



**BBSS2**



150 x 60 x 410 mm

8 BBSS2

Levier double long



**BBSS2L**

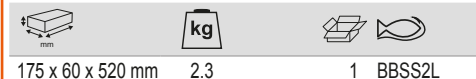

175 x 60 x 520 mm

kg

2.3

1 BBSS2L

Spatule d'extraction de clips



**2485**



240

1 2485

Pince pour garniture de porte



**BBS200**



240

1 BBS200

Kit de 12 lissettes



**BBS20P12**



35 x 355 x 585 mm

1 BBS20P12

Agrafeuse à chaud



**BBS210**

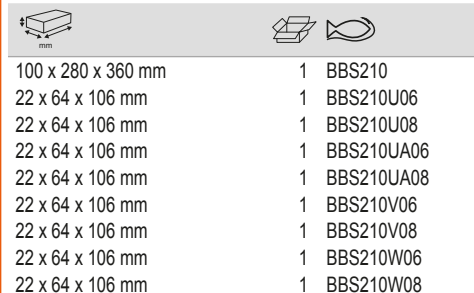

- 100 x 280 x 360 mm
- 22 x 64 x 106 mm
- 22 x 64 x 106 mm
- 22 x 64 x 106 mm
- 22 x 64 x 106 mm
- 22 x 64 x 106 mm
- 22 x 64 x 106 mm
- 22 x 64 x 106 mm
- 22 x 64 x 106 mm
- 22 x 64 x 106 mm

- 1 BBS210
- 1 BBS210U06
- 1 BBS210U08
- 1 BBS210UA06
- 1 BBS210UA08
- 1 BBS210V06
- 1 BBS210V08
- 1 BBS210W06
- 1 BBS210W06
- 1 BBS210W08

Jeu de 12 pièces pour extraction d'air bag  
(VW, Audi, Mercedes, BMW, Opel, Renault...)



**BBS100**



55 x 160 x 275 mm

- 1 BBS100
- 1 BBS10001
- 1 BBS10002
- 1 BBS10003
- 1 BBS10004
- 1 BBS10005
- 1 BBS100057
- 1 BBS10006
- 1 BBS10007
- 1 BBS10008
- 1 BBS10009
- 1 BBS10010

Jeu de 4 grattoirs pour carrosserie



**2220**



125

1 22209004B

Pince à riveter M3-M6



**1468-M6**



20 x 110 x 265 mm

1 1468-M6



Pince à riveter M4-M10



**1468-M10**

50 x 210 x 575 mm	1	1468-M10

Insert 1468-M6 pour pince à riveter



**1468-6M**

15 x 15 x 50 mm	1	1468-6M3
13 x 13 x 50 mm	1	1468-6M4
25 x 25 x 55 mm	1	1468-6M5
20 x 20 x 55 mm	1	1468-6M6

Insert 1468-M10 pour pince à riveter



**1468-10M**

17 x 17 x 90 mm	1	1468-10M4
17 x 17 x 90 mm	1	1468-10M5
20 x 20 x 90 mm	1	1468-10M6
20 x 20 x 85 mm	1	1468-10M8
20 x 20 x 85 mm	1	1468-10M10

Siège de manchon pour pince à riveter 1468-M10



**1468-10-1**

70	1	1468-10-1

Coffret de vérins portables 4 T et 10 T



**BH8PR**

220 x 480 x 1030 mm	31	1	BH8PR10000
168 x 345 x 575 mm	18.65	1	BH8PR4000

Pince de serrage pour carrosserie



**BH8BC1**

45 x 135 x 230 mm	1	BH8BC1

Pince de serrage pour carrosserie



**BH8BC2**

51 x 150 x 220 mm	1	BH8BC2

Pince de serrage pour carrosserie



**BH8BC3**

90 x 65 x 240 mm	10	BH8BC3

Pince de serrage pour carrosserie



**BH8BC4**

80 x 120 x 175 mm	6	BH8BC4

Pince de serrage pour carrosserie



**BH8BC5**

45 x 155 x 230 mm	6	BH8BC5

## MATÉRIEL DE LEVAGE

Cric bouteille vissé



### BH4S

Capacité (kg)	Dimensions (mm)	Quantité	Modèle
2000	180 x 83 x 93 mm	6	BH4S2
4000	190 x 91 x 100 mm	6	BH4S4
6000	215 x 96 x 114 mm	4	BH4S6
8000	230 x 103 x 120 mm	4	BH4S8
12000	235 x 117 x 135 mm	3	BH4S12
20000	240 x 145 x 153 mm	1	BH4S20

Barre support moteur  
Capacité 500 kilos



### BH8AC1-500

Dimensions (mm)	Poids (kg)	Quantité	Modèle
680 x 235 x 1700 mm	18,2	1	BH8AC1-500

Crics bouteilles professionnels



### BH4

Capacité (kg)	Dimensions (mm)	Quantité	Modèle
2000	180 x 103 x 103 mm	1	BH42
5000	210 x 110 x 110 mm	1	BH45
10000	220 x 124 x 128 mm	1	BH410
15000	235 x 140 x 140 mm	2	BH415
20000	240 x 165 x 160 mm	1	BH420
30000	245 x 185 x 175 mm	2	BH430

Cric aluminium 1,5 T



### BH1A1500

Capacité (kg)	Dimensions (mm)	Quantité	Modèle
1500	567 x 145 x 255 mm	1	BH1A1500

Cric aluminium 1,5 tonnes



### BH1A1500A

Capacité (kg)	Dimensions (mm)	Quantité	Modèle
1500	170 x 370 x 660 mm	1	BH1A1500A

Cric aluminium léger 2,5 T



### BH1A2500

Capacité (kg)	Dimensions (mm)	Quantité	Modèle
2500	200 x 370 x 800 mm	1	BH1A2500

Cric aluminium 2,5 tonnes



### BH1A2500A

Capacité (kg)	Dimensions (mm)	Quantité	Modèle
2500	205 x 385 x 800 mm	1	BH1A2500A

Cric 3 T compact



### BH1EU3000

Capacité (kg)	Dimensions (mm)	Quantité	Modèle
3000	1400 x 340 x 617 mm	1	BH1EU3000

Selle en caoutchouc de rechange



### BH1EU3000-03

Capacité (kg)	Dimensions (mm)	Quantité	Modèle
BH1A1500		1	BH1A1500-01
BH1A2500		1	BH1A2500-01
BH1EU3000		1	BH1EU3000-03
BH15000A		1	BH15000A-04
BH110000A		1	BH110000A-04



Kit de roues avant fixes pour crics



**BH1**

BH1A2500	1	BH1A2500-03
BH13000	1	BH13000-02
BH1EU3000	1	BH1EU3000-01
BH1M1000, BH11500, BH12000	1	BH11500-02
BH1S45	1	BH1S45-03
BH15000A	1	BH15000A-02
BH110000A	1	BH110000A-02

Cric surbaissé 2 T



**BH12000**

2000	1270 x 364 x 780 mm	1 BH12000

Traverse de levage 1 T



**BH1CB1000**

1000	145 x 125 x 710 mm	1 BH1CB1000

Cric multiusage 1T



**BH1M1000**

1000	1280 x 478 x 700 mm	1 BH1M1000

Cric compact extra plat 3T



**BH13000**

3000	1280 x 364 x 825 mm	1 BH13000

Cric châssis long haute élévation 3 T



**BH13000L**

3000	1310 x 530 x 1370 mm	1 BH13000L

Cric extra-long 1,5 T



**BH11500**

1500	1270 x 364 x 945 mm	1 BH11500

Cric 3T avec un système d'approche rapide



**BH13000QA**

3000	220 x 395 x 900 mm	1 BH13000QA

Cric 5 T extra long



**BH15000A**

5000	1260 x 375 x 2327 mm	1 BH15000A



Cric 10 T extra long



**BH110000A**

10000	1260 x 408 x 2626 mm	1	BH110000A

Extension 120 mm pour crics extra longs 5 T - 10 T



**BH15000A-EXT/BH110000A-EXT**

108 mm 151 mm		1	BH15000A-EXT BH110000A-EXT

Cric ciseau 4 T - 5 T



**BH1S45**

4000	1194 x 212 x 680 mm	1	BH1S45

Crics pneumatiques à 2 étages manche court



**BH9BJ22SSH**

2000	345 x 265 x 265 mm	1	BH9BJ22SSH

Crics pneumatiques à 2 étages manche long



**BH9BJ22**

2000	1000 x 265 x 265 mm	1	BH9BJ22SLH

Crics pneumatiques à 3 étages manche court



**BH9BJ23SSH**

2000	490 x 250 x 250 mm	1	BH9BJ23SSH

Crics pneumatiques à 3 étages manche long



**BH9BJ23**

2000	1000 x 250 x 250 mm	1	BH9BJ23SLH

Extension pour cric pneumatique



**BH9BJ260**

970 1180		1	BH9BJ260 BH9BJ280

Cric hydropneumatique 30 T



**BH230**

360	627	1	BH230



Cric compact hydro-pneumatique 15/30 T



**BH23015C**



30000 1350 x 290 x 430 mm 1 BH23015C

Cric hydro-pneumatique 60/40/20 T



**BH2604020**

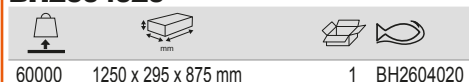

60000 1250 x 295 x 875 mm 1 BH2604020

Paire de chandelles aluminium 2,5 T



**BH3AL2500**



2500 1 BH3AL2500

Cric hydro-pneumatique 15/30T



**BH23015**

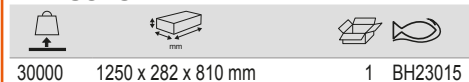

30000 1250 x 282 x 810 mm 1 BH23015

Jeu de deux extensions pour crics 45 et 75 mm



**BH2AC**



67 mm 45-75 mm 1 BH2AC1  
75 mm 45-75 mm 1 BH2AC2

Paire de chandelles à crémaillère 3 T / 6 T



**BH33000/BH36000**



3000 1 BH33000  
6000 1 BH36000

Cric hydro-pneumatique 40/20/10 T



**BH2402010**



40000 1225 x 302 x 825 mm 1 BH2402010

Selles universelles en acier pour charges lourdes



**BH2AC60**



78 x 70 x 110 mm 0.97 1 BH2AC60V110  
80 x 140 x 140 mm 2.96 1 BH2AC60-140

Paire de chandelles réglables automatiquement



**BH3A**

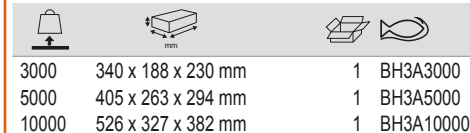

3000 340 x 188 x 230 mm 1 BH3A3000  
5000 405 x 263 x 294 mm 1 BH3A5000  
10000 526 x 327 x 382 mm 1 BH3A10000

Chandelle à base carrée 7 T - 15 T



**BH3SQ**

7000	2	BH3SQ7000
15000	2	BH3SQ15000

Chandelles pour poids lourds 16 T



**BH3HD16000**

16000	1	BH3HD16000

Vérin de fosse hydraulique double pistons 1 T



**BH5DP1000QA**

1000	1954 x 759 x 759 mm	1 BH5DP1000QA

Chandelle pour poids lourds 8 T



**BH3HD**

8000	2	BH3HD8000

Chandelle pour poids lourds 20T



**BH3HD20000A**

20000	1	BH3HD20000A

Tête gyroscopique pour vérins de fosse 1 T



**BH5US1000**

250 x 340 x 420 mm	260-510	1 BH5US1000

Chandelle pour poids lourds 12 T



**BH3HD12000**

12000	1	BH3HD12000

Vérin de fosse hydraulique simple piston 500 kg



**BH5SP500QA**

2041 x 660 x 660 mm	1 BH5SP500QA

Chariot de déplacement des véhicules



**BH1CD680**

16.22 kg	610 x 240 x 220 mm	1 BH1CD680



Rack de rangement pour chariots de déplacement des véhicules



**BH1CD680ST**

715 x 130 x 155 mm	135	1 BH1CD680ST

Grue d'atelier pliable 600 kg



**BH6PC600**

2315 x 1040 x 1480 mm	96	1 BH6PC600

Équilibreur de charge



**BH6AC1-680A**

	1 BH6AC1-680A

Élévateur hydraulique pour le montage/démontage des roues 600 kg



**BH8AC3-600**

1030 x 1050 x 1020 mm	93,5 kg	1 BH8AC3-600

Grue d'atelier pliable 1T



**BH6FC1000**

2175 x 1030 x 1480 mm	85	1 BH6FC1000

Bidon d'huile hydraulique ISO VG15, 250 ml



**BHVG15-250**

160 x 60 x 60 mm	220	12 BHVG15-250

Élévateur hydraulique pour le montage/démontage des roues 1,5 T



**BH8AC3-1500**

1730 x 1235 x 1425 mm	174 kg	1 BH8AC3-1500

Grue d'atelier pliable 2 T Euro-palette



**BH6FC2000**

2640 x 1220 x 1845 mm	170	1 BH6FC2000

Kit de roues arrière pivotantes pour crics



**BH1**

BH1A1500	1 BH1A1500-04
BH1A2500	1 BH1A2500-04
BH1M1000, BH11500, BH12000, BH13000	1 BH11500-01
BH1EU3000	1 BH1EU3000-08
BH13000L	1 BH13000L-01
BH1S45-01	1 BH1S45-01
BH15000A, BH110000A	1 BH15000A-01



# Éclairage



## ÉCLAIRAGE À MAIN

Stylo lampe torche



### BLTS7P



45



58 BLTS7P

Lampe torche articulée



### BLTFC1



180



20 BLTFC1

Kit d'éclairage



### BLTI3P



100-140



18 BLTI3P

Lampe tube



### BLS128



575



20 BLS128

Lampe torche pour espaces confinés



### BLTS10



400



20 BLTS10

## LAMPES FRONTALES

Lampe frontale légère et extrêmement durable  
260 lumens et 2 modes de lumières



### BFRL11



260 lm



1 BFRL11

## ENROULEURS

Enrouleurs 230V



### BLCR230



230



800/2000



1 BLCR230FR

230

800/2000

1 BLCR230SC

Enrouleurs 24V



### BLCR24V



230/24

60

1 BLCR24VCL

230/24

60

1 BLCR24VLL

Enrouleur 400V



### BLCR400E



400

2800/5000

1 BLCR400E

Adaptateur pour contrôler la vitesse d'enroulement



### BLCRSC

BLCR



230PL,FR,SC 76 x 91 x 117 mm

1 BLCRSC1

24VCL,VLL 76 x 91 x 117 mm

1 BLCRSC2



## Outils d'inspection



## ENDOSCOPES

### Vidéo scope



#### BE210

mm	kg		
105 x 325 x 400 mm	2.67	1	BE210
5 x 50 x 56 mm	0.04	1	ZHVIDEOBAT
40 x 44 x 75 mm	0.17	1	ZHVIDEOCHA

### Caméra d'inspection



#### BE200

mm	kg		
100 x 325 x 390 mm	2.19	1	BE200

### Câble en fibre optique Pour endoscope BE200 et vidéo scope BE210



#### BE200C

mm	L		
25	10	1	BE200CAB250SH10
25	25	1	BE200CAB250SH25
25	3	1	BE200CAB250SH3
14	1	1	BE200CAB40F1

mm	L		
5.5	1	1	BE200CAB55F1
14	3	1	BE200CAB55F3
14	1	1	BE200CAB58SR1
14	3	1	BE200CAB58SR3
14	1	1	BE200CAB80SR1
14	3	1	BE200CAB80SR3

### Miroirs et embouts magnétiques pour endoscope BE200 et vidéo scope BE210



#### BE200M

°	mm		
0	4	1	BE200MAG4
0	5.5, 5.8, 8	1	BE200MAG55
35	5.5, 5.8	1	BE200MIR5535
45	5.5, 5.8	1	BE200MIR5545
55	5.5, 5.8	1	BE200MIR5555
35	8	1	BE200MIR8035
45	8	1	BE200MIR8045
55	8	1	BE200MIR8055
35	4	1	BE200MIR4035
45	4	1	BE200MIR4045
55	4	1	BE200MIR4055

## STÉTHOSCOPES

### Stéthoscope de mécanicien



#### BE220

mm	kg		
130 x 370 x 340 mm	2.94	1	BE220

### Stéthoscope



#### 5050

L			
1050		1	5050

## MIROIRS

### Miroir flexible d'atelier



#### 2510

L	mm		
505	50x75 mm	1	2510

### Miroir articulé Ø 30mm



#### 5515GV

L	mm		
215	30	1	5515GV



Miroir de poche télescopique à tête pivotante



**5515T-52**



255-450 52 25 5515T-52

Miroir de réparation Ø 30mm



**5515M**



210 30 1 5515M

Miroir lumineux orientable



**BL1FM**



610 30x55 mm 1 BL1FM

Petit miroir Ø 18mm



**5515L**



160 21 1 5515L

Miroir de réparation Ø 28mm



**5515B**



220 31.5 25 5515B

Miroir de poche télescopique Ø 30mm



**5515T**



180-690 30 25 5515T





**BAHCO**

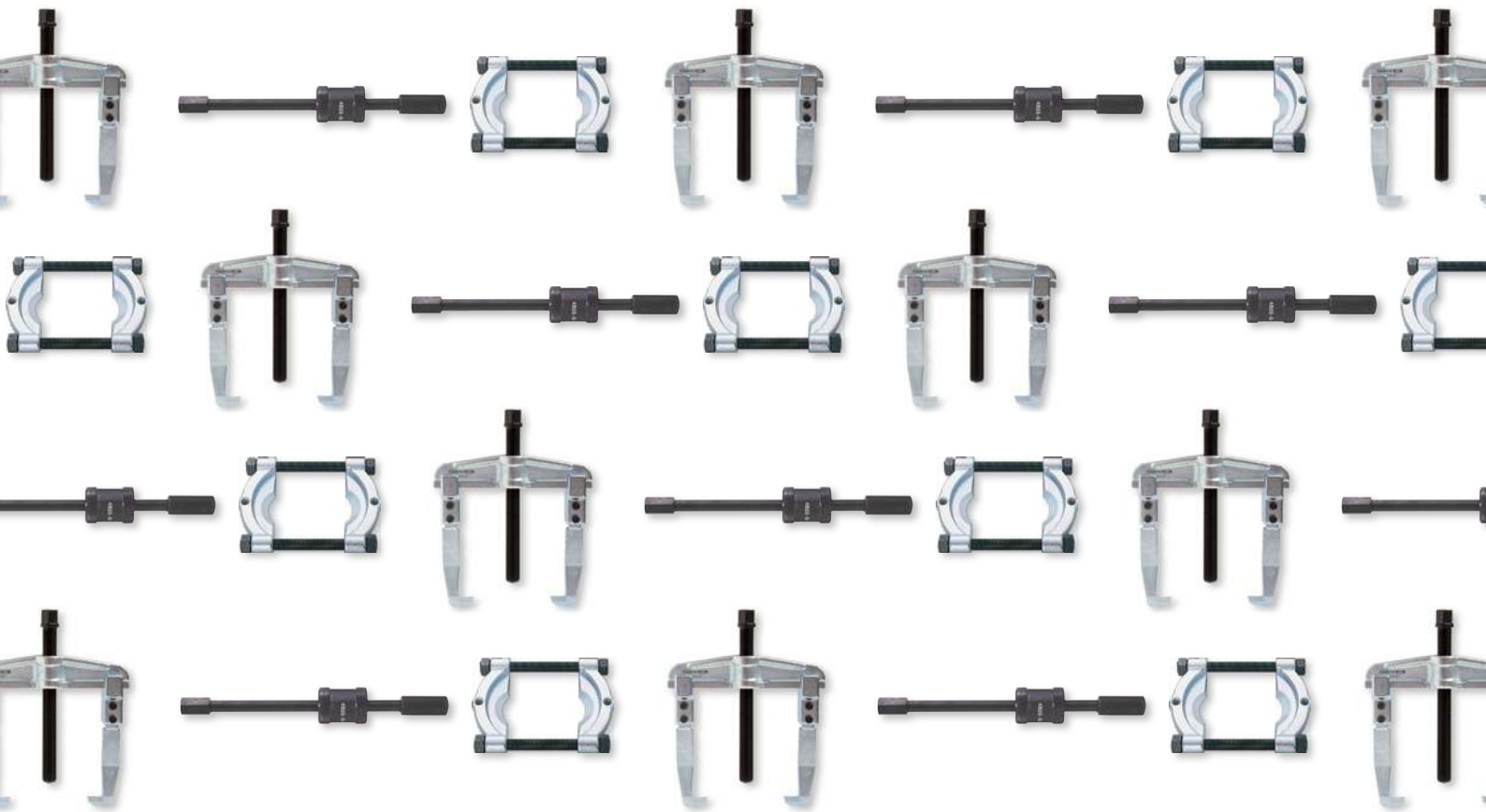

## Extracteurs



## MÉCANIQUE

### Extracteur à 2 griffes universels



#### 4532

25-80 mm	100 mm	1			4532-A
25-80 mm	200 mm	1			4532-AL
25-130 mm	100 mm	1			4532-B
25-130 mm	200 mm	1			4532-BL
50-160 mm	150 mm	1			4532-C
50-160 mm	300 mm	1			4532-CL
60-200 mm	150 mm	1			4532-D
80-250 mm	200 mm	1			4532-E
80-350 mm	200 mm	1			4532-F
110-520 mm	200 mm	1			4532-G
110-520 mm	200 mm	1			4532-G-SO
170-640 mm	225 mm	1			4532-H
135 mm		1			4532-A/B
174 mm		1			4532-B/B
220 mm		1			4532-C/B
260 mm		1			4532-D/B
330 mm		1			4532-E/B
415 mm		1			4532-F/B
580 mm		1			4532-G/B
705 mm		1			4532-H/B
	100 mm	1			4532K1
	150 mm	1			4532K2
	200 mm	1			4532K3
	225 mm	1			4532K4
	200 mm	1			4532LK1
	300 mm	1			4532LK2
	300 mm	1			4532LK3
	400 mm	1			4532LK4
	500 mm	1			4532LK5
		1			4532-OAB/S
		1			4532-CD/S
		1			4532-EFG/S
		1			4532-H/S

4532/B : support griffe 4532K : jeu de griffes

4532LK : jeu de longues griffes 4532/S : broches

### Jeu d'extracteurs à deux crochets



#### 4532ST/5

16700	1		4532ST/5

4532-A, 4532-B, 4532-C, 4532-D, 4532-E



### Extracteur à deux griffes



#### 4532-0

20-90 mm	100 mm	1			4532-0
140 mm		1			4532-O/B
	100 mm	1			4532K0

4532-0/B : support griffe 4532K0 : jeu de bras

4532-OABS/S : broche

### Extracteur à 2 griffes longues



#### 3115

80-250 mm	300 mm	1			3115

### Jeu d'extracteurs et décolleurs



#### 4574

105 x 300 x 360 mm	1		4574

4532-A, 4532-C, 4532LK1, 4532LK2



4551-C



4529-15



### Extracteur à trois crochets



#### 4543

10-60 mm	40 mm	1			4543-1
10-70 mm	74 mm	1			4543-2
10-90 mm	84 mm	1			4543-3
10-60 mm	40 mm	1			4543-10
10-70 mm	74 mm	1			4543-20
10-90 mm	84 mm	1			4543-30
70 mm		1			4543-12/B
90 mm		1			4543-3/B
70 mm		1			4543-1020/B
100 mm		1			4543-30/B
	40 mm	1			4543K110
	74 mm	1			4543K220
	84 mm	1			4543K330
		1			4543-1/S
		1			4543-2/S
		1			4543-3/S

4543-1/3:w/2 griffes 4543-10/30:w/3 griffes 4543/B





support griffe 4543K : griffe 4543/S : broche

### Extracteur à trois crochets



#### 4544

10-100 mm	80 mm	1			4544-1
10-120 mm	120 mm	1			4544-2
20-160 mm	160 mm	1			4544-3
20-200 mm	200 mm	1			4544-4
10-100 mm	80 mm	1			4544-10
10-120 mm	120 mm	1			4544-20
20-160 mm	160 mm	1			4544-30
100 mm		1			4544-1/B





			
120 mm		1	4544-2/B
160 mm		1	4544-3/B
200 mm		1	4544-4/B
100 mm		1	4544-10/B
120 mm		1	4544-20/B
160 mm		1	4544-30/B
	80 mm	1	4544K110
	120 mm	1	4544K220
	160 mm	1	4544K330
	200 mm	1	4544K440
		1	4544-110/S
		1	4544-220/S
		1	4519-1/S
		1	4544-440/S

4544-1/4:w/2 griffes 4544-10/30:w/3 griffes 4544/B  
support griffe 4544K : griffe 4544/S : crochet

### Extracteur à deux crochets



### 4541





			
20-150 mm	85 mm	1	4541-A
40-220 mm	130 mm	1	4541-B
150 mm		1	4541-A/B
220 mm		1	4541-B/B
	85 mm	1	4541KA
	130 mm	1	4541KB

4541/B : support griffe 4541K : griffe  
4532-4519/S broche

### Extracteur à trois griffes



### 4542





			
20-150 mm	85 mm	1	4542-A
40-220 mm	130 mm	1	4542-B
150 mm		1	4542-A/B
220 mm		1	4542-B/B

4542/B : support griffe de rechange 4541K : griffe de rechange  
4532-4519/S : axe

### Extracteur à deux crochets



### 4537





			
20-170 mm	130 mm	1	4537-1
20-230 mm	200 mm	1	4537-2
50-300 mm	250 mm	1	4537-3
50-350 mm	350 mm	1	4537-4
170 mm		1	4537-1/B
230 mm		1	4537-2/B
350 mm		1	4537-34/B
	130 mm	1	4537K1
	200 mm	1	4537K2
	250 mm	1	4537K3
	350 mm	1	4537K4

Pce détachée : 4537/B : support bras  
4537K : crochets 4532-4519/S : broche

### Extracteur à trois crochets



### 4528M





			
		1	4528M1/P
		1	4528M2/P
		1	4528M3/P
20-170 mm	130 mm	1	4528M1
20-230 mm	200 mm	1	4528M2
50-300 mm	250 mm	1	4528M3
50-350 mm	350 mm	1	4528M4
50-400 mm	400 mm	1	4528M5
170 mm		1	4528M1/B
230 mm		1	4528M2/B
400 mm		1	4528M345/B
	400 mm	1	4528MK5

4528M/B : support griffe 4537K-4528Mk : griffe  
4532/S-4519/S : broche

### Extracteur avec étrier



### 4519





			
20-110 mm	80-170 mm	1	4519-1
40-150 mm	90-270 mm	1	4519-2
40-150 mm	90-330 mm	1	4519-3
110 mm		1	4519-1/B
150 mm		1	4519-23/B
	170 mm	1	4519K1
	270 mm	1	4519K2
	330 mm	1	4519K3
		1	4519-2/S

4519/B : support griffe 4519K : griffe  
4519/S : broche

### Extracteur multiple, 5 pièces



### 4540

			
30-170 mm	65-140 mm	1	4540-17
	65 mm	1	4540-17/K4
	100 mm	1	4540-17/K3
	140 mm	1	4540-17/K2
	140 mm	1	4540-17/K1
		1	4540-17/S
75-250 mm	77-180 mm	1	4540-25
	77 mm	1	4540-25/K4
	122 mm	1	4540-25/K3
	180 mm	1	4540-25/K2
	180 mm	1	4540-25/K1
		1	4540-25/S

4540/S : broche 4540K : griffe K4-K3 :  
courbe K2 : concave K1 : droite



### Extracteur à deux crochets



#### 4614

6-100 mm	70-85 mm	1	4614-1		
10-140 mm	85-120 mm	1	4614-2		
100 mm		1	4614-1/B		
140 mm		1	4614-2/B		
	80 mm	1	4614K1		
	120 mm	1	4614K2		

4614/B : support griffe 4614K : jeu de bras  
4543-4532/S : broche

### Extracteur 3 griffes hydrauliques - très résistant et griffes de remplacement



#### 4528

50-350 mm	135 mm	1	4528-1		
350 mm		1	4528-1/B		
	135 mm	1	4528K1		
	235 mm	1	4528K2		
	285 mm	1	4528K3		
	335 mm	1	4528K4		
	385 mm	1	4528K5		

4528K : jeu de 3 griffes 4528/B : support  
griffe 4533HP/S : crochet hydraulique

### Extracteurs 3 griffes avec vis résistante trempée par induction



#### 4533

150-700 mm	185 mm	1	4533HP		
150-700 mm	200 mm	1	4533M		

185 mm		1	4533HPK		
200 mm		1	4533MK		
		1	4533HP/S		
		1	4533M/S		

4533HP : hydraulique / 4533M : mécanique  
4533/S : axe / 4533/K : jeu de 3 griffes de rechange

### Presse hydraulique



#### 4529

$T_n$ max			
8	60	1	4529-8
15	70	1	4529-15

### Extracteur pour décolleurs



#### 4552

4551-A-B		1	4552-1
4551-C		1	4552-2
4551-D		1	4552-3
		1	4552-1/B
		1	4552-2/B
		1	4552-3/B
		1	4552K1
		1	4552K2
		1	4552K3

4552/B : support griffe 4552K : barre d'accouplement  
4532/S : crochet

### Extracteur



#### 4551

4552-1		1	4551-A
4552-1		1	4551-B

4552-2		1	4551-C
4552-3		1	4551-D
		1	4551-A/S
		1	4551-B/S
		1	4551-C/S
		1	4551-D/S

4551/S : crochet

### Extracteur de roulements à billes intérieurs



#### 4521N

5-7		1	4521N-00
7-9		1	4521N-0
9-12		1	4521N-A
10-13		1	4521N-B
13-17		1	4521N-C
14-19		1	4521N-D
16-21		1	4521N-E
18-23		1	4521N-F
20-25		1	4521N-G
25-30		1	4521N-H
30-37		1	4521N-I
35-42		1	4521N-K
38-45		1	4521N-L
43-50		1	4521N-M
40-75		1	4521N-S
70-115		1	4521N-T

### Extracteur : 2 griffes s'utilise avec le 4521



#### 4522

35-75		1	4522-1
60-130		1	4522-2
35-75		1	4522-1/B
60-130		1	4522-2/B
		1	4522K1
		1	4522K2
136 mm		1	4522-1/S
160 mm		1	4522-2/S

4522/B : support griffe 4522K : griffe  
4522/S : broche

### Extracteur à masse coulissante



#### 4523G



Ø10x170 1 4523G

### Extracteur à masse coulissante



#### 4524G



Ø16 x 250 1 4524G

### Assortiment d'extracteurs



#### 4521N/7



95 x 360 x 310 mm 6800 1 4521N/7

4521N-D, 4521N-H, 4521N-I, 4521N-L, 4521N-S, 4521N-G

4522-2, 4522-1

### Crochet de rechange- jeu de 4pcs



#### 4581NA-4583NB

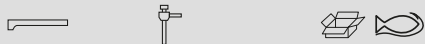

145	4581N-1	1	4581NA
120	4581N-1	1	4581NB
130	4582N-1	1	4581NB2
130	4582N-1, 4582N-2	1	4581NC
150	4582N-1, 4583N-2	1	4582NA
150	4582N-2, 4583N-2	1	4582NB
190	4583N-1	1	4583NA
235	4583N-1, 4583N-2	1	4583NB

### Extracteur de roulements à billes



#### 4581N-4583N

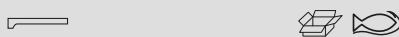

4581NA, 4581NB	1	4581N-1
4581NB2, 4581NC, 4582NA	1	4582N-1
4581NC, 4582NA, 4582NB	1	4582N-2
4582NA, 4583NA, 4583NB	1	4583N-1
4582NA, 4582NB, 4583NB	1	4583N-2

### Jeu de griffes de rechange



#### 4578



75 x 235 x 285 mm 1 4578

4581N-1, 4582N-2, 4581NA, 4581NB, 4581NB2, 4581NC

### Jeu d'extracteurs pour roulements à billes



#### 4580N/7

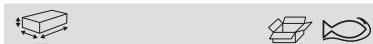

66 x 192 x 287 mm 1 4580N/7

### Chasse-rotules universel



#### 4545-N



Max 50 mm	18-22 mm	1	4545-N1
Max 90 mm	27-36 mm	1	4545-N11
Max 50 mm	26 mm	1	4545-N2
60-80 mm	26 mm	1	4545-N21
		1	4545-N1/S
		1	4545-N2/S

### Arrache-moyeux universel



#### 4518



225 mm	140 mm	1	4518-3
225 mm	140 mm	1	4518-4
225 mm	140 mm	1	4518-5



### Chasse-rotules



**4545**

18 mm	1	4545-1
25 mm	1	4545-2
29 mm	1	4545-3
40 mm	1	4545-4
45 mm	1	4545-5

### Jeu de mini-extracteurs



**4579**

65 x 210 x 275 mm	1	4579

4543-2? 4543-3, 4543-1020/B, 4543-30/B,  
4543K220, 4543k300

### Pièces détachées pour casse-écrous



**4611/B**

60	1	4611-2/B
60	1	4611-3/B

### Jeu d'extracteurs pour garages



**4577**

70 x 340 x 425 mm	1	4577

4545-N2	
4532-B	
4614-1	
4521N-D, 4521N-B, 4521N-H, 4521N-I, 4521N-G, 4521N-L	
4522-1	

### Casse-écrou mécanique



**4611**

to M16	1	4611-2
to M24	1	4611-3

4611/S1 : lame 4611/S2 : broche

### Vis d'axe de rechange pour casse-écrou



**4611/S**

90	1	4611-2/S
130	1	4611-3/S

### Coffret d'extracteurs à inertie



**4590SHS5**

79 x 230 x 500 mm	4	4590SHS5

### Casse-écrou hydraulique



**4610**

M4-M14	1	4610-1

### Extracteur de goujons



**1420-1424**

M 3-6	1	1420-1.4
M 6-8	1	1421-2.1
M 8-11	1	1422-3.1
M11-14	1	1423-4.8
M14-18	1	1424-6.2



Jeu de 5 extracteurs de goujons



**1435/5**

15 x 50 x 90 mm	110	1 1435/5

1423-4.8, 1420-1.4, 1422-3.1, 1421-2.1, 1424-6.2

Jeu de 8 extracteurs de goujons  
Pour vis de tailles M4 à M45



**1435/8**

29 x 110 x 118 mm	700	1 1435/8

1420-1.4, 1421-2.1, 1422-3.1, 1423-4.8, 1424-6.2

Extracteur de goujons



**1411-1415**

M6	1 1411-3.2
M8	1 1412-4.8
M10	1 1413-6.4
M12	1 1414-8
M14-M16	1 1415-8.7

Guides forets



**1418A-K**

6 mm	1 1418A
8 mm	1 1418B
8 mm	1 1418C
8 mm	1 1418D
10 mm	1 1418E
11 mm	1 1418F
12 mm	1 1418G
12 mm	1 1418H
13 mm	1 1418I
14 mm	1 1418K

Jeu d'extracteurs de goujons, vis, boulons cassés



**1418S**

25 x 127 x 162 mm M6-M16	1 1418S

1411-3.2, 1412-4.8, 1413-6.4, 1414-8, 1415-8.7

1418A, 1418B, 1418C, 1418D, 1418E, 1418F, 1418G, 1418H, 1418I, 1418K

Extracteur de goujons pour vis, boulons et écrous



**1419-M5/1419-M16**

M5-M10	1 1419-M5
M8-M14	1 1419-M8



M12-M20	1 1419-M12
M16-M24	1 1419-M16

Jeu d'extracteurs pour goujons cassés  
4 pièces



**1419/4**

M5-M24	430	1 1419/4

M5-M10; M8-M14; M12-M20; M16-M24

Jeu d'extracteurs de goujons 1/2" - 5/8"



**BWMSP15**

43 x 90 x 200 mm	0,54	1 BWMSP15



## Embout extracteur de goujons



### BWMSP15

Ø	Ø	Quantité	Modèle
3	1/2	1	BWMSP1501
4	1/2	1	BWMSP1502
5	1/2	1	BWMSP1503
5.5	1/2	1	BWMSP1504
6	1/2	1	BWMSP1505
8	1/2	1	BWMSP1506
10	1/2	1	BWMSP1507
1/8	1/2	1	BWMSP1508
3/16	1/2	1	BWMSP1509
1/4	1/2	1	BWMSP1510
3/8	1/2	1	BWMSP1511
11	5/8	1	BWMSP1512
12	5/8	1	BWMSP1513
14	5/8	1	BWMSP1514
1/2	5/8	1	BWMSP1515

## Coffret de montage / démontage de goujons



### 1411AUP8

228 x 198 x 80 mm	0.55 kg	1	1411AUP8

## Kit extracteur de goujons



### 1411AUP81-1411AUP84

M6	1	1411AUP81
M8	1	1411AUP82
M10	1	1411AUP83
M10	1	1411AUP84

## Extracteur de goujons



### 4591-4593

10-19 mm	1	4592
5-15	1	4591
18-28	1	4593

## Dégoujonneuse



### 4553

5-20	1	4553

## LEVIERS

### Arrache-goupilles



### 2632

170	1	2632

### Levier



### 3683

400	1	3683

### Levier spécial



### 3681

304	1	3681-11
406	1	3681-16
503	1	3681-20

### Levier spécial



### 3684

406	1	3684-16
457	1	3684-18

L		
609	1	3684-24
760	1	3684-30

### Levier spécial



### 3680

L		
400	1	3680

### Leviers avec manche plastique



### 2484-20/2484-60

L		
205	1	2484-20
305	1	2484-30
465	1	2484-45
615	1	2484-60

### Assortiment de 4 leviers



### 2484/S4

mm		
42 x 145 x 693	10	2484/S4

2484-20, 2484-30, 2484-45, 2484-60

### Jeu de barres leviers à lame traversante



### 2484T-20/2484T-60

1	2484T-20	
1	2484T-30	
1	2484T-45	
1	2484T-60	

### Jeu de barres leviers à lame traversante



### 2484T/S4

1	2484T/S4	

2484T-20, 2484T-30, 2484T-45, 2484T-60

### 780852\_PICKING TOOLS

Outil de préhension magnétique ERGO™ en néodyme, 4 mm x 290 mm

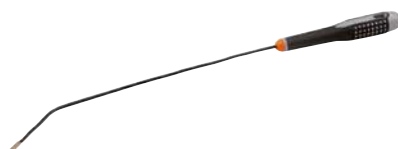

### 2535F0

Ø	L	
4 mm	290 mm	1 2535F0

### Capteur magnétique BahcoFit



### B147

Ø	L	
10	400	1 B147.001.400
13	400	1 B147.003.400
10	400	1 SB147.001.400
18	390	1 SB147.003.400

### Doigt magnétique flexible



### 2535F

Ø	L	
12	400	1 2535F1
12	395	1 2535F2
17	392	1 2535F3

### Doigt magnétique avec lumière



### 2535L

Ø	L	
20 mm	40-670 mm	12 2535L



Doigt flexible à griffes



**2509**



555



50 2509

Doigt flexible à griffes



**2530**



605 mm



1 2530

**OUTILS DE FILETAGE**

Jeu de tarauds et filières



**1460M/1**



53 x 407 x 220 mm



M5-M12



1 1460M/1

Jeu de tarauds et filières



**1460M/2**



53 x 407 x 220 mm



M5-M20



1 1460M/2

Jeu de tarauds et filières, filets américains



**1460Z/2**



53 x 407 x 220 mm



1/4-3/4



1 1460Z/2

Tourne-à-gauche



**600**



3-10



1 600.003.010

5-12

1 600.005.012

Lime à restaurer les filets intérieurs et extérieurs



**1450D-ISO**



230



1 1450D-ISO

Lime à restaurer les filets intérieurs et extérieurs



**1450D-WW**



230



1 1450D-WW

Jeu de limes à restaurer les filets



**1450D/2**



40 x 70 x 270 mm



M5-M27



1 1450D/2

1450D-ISO

1450D-WW



## Systemes de rangement et kits d'outils



## SERVANTES

Servante d'atelier premium E72  
Servante 6 tiroirs robuste avec pare-chocs latéraux pour tiroirs



### 1477K6



976 x 510 x 820 mm	1	1477K6
976 x 510 x 820 mm	1	1477K6BLACK
976 x 510 x 820 mm	1	1477K6GREY
976 x 510 x 820 mm	1	1477K6RED

Servante d'atelier premium E77  
Servante 7 tiroirs robuste avec pare-chocs latéraux pour tiroirs



### 1477K7



976 x 510 x 820 mm	1	1477K7
976 x 510 x 820 mm	1	1477K7BLACK
976 x 510 x 820 mm	1	1477K7GREY
976 x 510 x 820 mm	1	1477K7RED

Servante d'atelier Premium E77 26" , 7 tiroirs multicolore robuste avec châssis double parois



### 1477K7COLORS



976 x 510 x 820 mm	1	1477K7COLORS
--------------------	---	--------------

Servante d'atelier premium E77  
Servante 8 tiroirs robuste avec pare-chocs latéraux pour tiroirs



### 1477K8



976 x 510 x 820 mm	1	1477K8
976 x 510 x 820 mm	1	1477K8BLACK
976 x 510 x 820 mm	1	1477K8GREY
976 x 510 x 820 mm	1	1477K8RED

Servante d'atelier premium E77  
Servante 9 tiroirs robuste avec pare-chocs latéraux pour tiroirs



### 1477K9



976 x 510 x 820 mm	1	1477K9
976 x 510 x 820 mm	1	1477K9BLACK
976 x 510 x 820 mm	1	1477K9GREY
976 x 510 x 820 mm	1	1477K9WHITE
976 x 510 x 820 mm	1	1477K9RED

Servante d'atelier E72  
Servante 5 tiroirs robuste avec pare-chocs latéraux



### 1472K5



952 x 510 x 782 mm	1	1472K5GREY
952 x 510 x 782 mm	1	1472K5WHITE
952 x 510 x 782 mm	1	1472K5
952 x 510 x 782 mm	1	1472K5BLACK
952 x 510 x 782 mm	1	1472K5BLUE
952 x 510 x 782 mm	1	1472K5RED

Servante d'atelier E72  
Servante 6 tiroirs robuste avec pare-chocs latéraux



### 1472K6



952 x 510 x 782 mm	1	1472K6GREY
952 x 510 x 782 mm	1	1472K6WHITE
952 x 510 x 782 mm	1	1472K6
952 x 510 x 782 mm	1	1472K6BLACK
952 x 510 x 782 mm	1	1472K6BLUE
952 x 510 x 782 mm	1	1472K6RED

Servante d'atelier E72  
Servante 7 tiroirs robuste avec pare-chocs latéraux



### 1472K7



952 x 510 x 782 mm	1	1472K7GREY
952 x 510 x 782 mm	1	1472K7WHITE
952 x 510 x 782 mm	1	1472K7
952 x 510 x 782 mm	1	1472K7BLACK
952 x 510 x 782 mm	1	1472K7BLUE
952 x 510 x 782 mm	1	1472K7RED

Servante d'atelier E72  
Servante 8 tiroirs robuste avec pare-chocs latéraux



### 1472K8



952 x 510 x 782 mm	1	1472K8GREY
952 x 510 x 782 mm	1	1472K8WHITE
952 x 510 x 782 mm	1	1472K8
952 x 510 x 782 mm	1	1472K8BLACK
952 x 510 x 782 mm	1	1472K8BLUE
952 x 510 x 782 mm	1	1472K8RED

Coffre gamme Premium E77  
Coffre avec protection individuelle des 4 tiroirs



**1487K4**

402 x 510 x 690 mm	1	1487K4
402 x 510 x 690 mm	1	1487K4BLACK
402 x 510 x 690 mm	1	1487K4GREY

Coffre E72  
Coffre robuste 4 tiroirs



**1482K4**

386 x 510 x 691 mm	1	1482K4
386 x 510 x 691 mm	1	1482K4BLACK
386 x 510 x 691 mm	1	1482K4BLUE
386 x 510 x 691 mm	1	1482K4WHITE
386 x 510 x 691 mm	1	1482K4RED
386 x 510 x 691 mm	1	1482K4GREY

Coffre premium E87 4 tiroirs avec roues



**1487K4W**

564 x 510 x 692 mm	1	1487K4BKW
564 x 510 x 692 mm	1	1487K4W

Coffre E72 4 tiroirs avec roues



**1482K4W**

542 x 515 x 699 mm	1	1482K4W
542 x 515 x 699 mm	1	1482K4BKW

Coffre E72 5 tiroirs avec roues



**1482K5W**

542 x 515 x 699 mm	1	1482K5W

Panneau supérieur pour 1477K



**1477K-AC12**

396 x 25 x 610 mm	1	1477K-AC12

Panneau mural supérieur pour 1477K



**1477K-AC13**

400 x 25 x 365 mm	1	1477K-AC13

Porte document pour 1477K



**1477K-AC14**

327 x 25 x 240 mm	1	1477K-AC14

Plateau d'ordinateur pour 1477K



**1477K-AC15**

80 x 298 x 424 mm	1	1477K-AC15



Porte manteau pour 1477K



**1477K-AC17**



68 x 65 x 435 mm

1 1477K-AC17

Pince et anneau solides à fixer sur 1477K



**1477K-AC11**



30 x 39 x 68 mm

1 1477K-AC11

Support de pare-brise pour 1477K



**Work document board for 1477K**



106 x 115 x 208 mm

1 1477K-AC16

Tiges amovible longues pour 1477K



**1477K-AC28**



455 x 25 x 25 mm

1 1477K-AC28

Tiges amovible courtes pour 1477K



**1477K-AC29**



130 x 25 x 25 mm

1 1477K-AC29

Porte rouleaux pour 1477K et 1472K



**1477K-AC18**



33 x 265 x 313 mm

1 1477K-AC18

Porte documents pour 1477K et 1472K



**1477K-AC19**



241 x 65 x 300 mm

1 1477K-AC19

Porte aérosols pour 1477K et 1472K



**1477K-AC20**



125 x 105 x 307 mm

1 1477K-AC20

Porte outils pneumatiques pour 1477K et 1472K



**1477K-AC21**



115 x 175 x 302 mm

1 1477K-AC21

Panneau latéral pour 1477K et 1472K



**1477K-AC22**



659 x 18 x 300 mm

1 1477K-AC22



Plateau en métal pliable pour E72 et E77





**1477K-AC30**

 22 x 430 x 460 mm   1 1477K-AC30

Séparateurs de tiroirs amovibles pour servantes



**1477K-AC26**

 48 x 2 x 147 mm  0.07 kg   1 1477K-AC26

Tiroir inférieur pour 1477K



**1477K-AC10**

 110 x 390 x 495 mm   1 1477K-AC10

Système de verrouillage par code Pin pour 1477K



**1477K-AC24**

 135 x 36 x 62 mm   1 1477K-AC24

Système de verrouillage par carte magnétique pour 1477K



**1477K-AC25**

 135 x 36 x 62 mm   1 1477K-AC25

Plateau acier inoxydable pour 1477K



**1477K-ACTSS**

 35 x 495 x 670 mm   1 1477K-ACTSS

Plateau bois pour 1477K



**1477K-ACTW**

 20 x 510 x 550 mm   1 1477K-ACTW

Plateau composite pour 1477k



**1477K-ACTP**

 45 x 508 x 547 mm   1 1477K-ACTP

Plateau MDF pour 1477K



**1477K-ACTD**

 40 x 498 x 675 mm   1 1477K-ACTD

Plateau en acier inoxydable pour 1472K



**1472K-ACTSS**

 30 x 501 x 682 mm   1 1472K-ACTSS



Plateau en bois de châtaignier pour 1472K



**1472K-ACTW**

		
30 x 501 x 680 mm	1	1472K-ACTW

Plateau MDF pour 1472K



**1472K-ACTD**

		
30 x 501 x 682 mm	1	1472K-ACTD

Autocollants





**1477K-AC23**

		
1 x 210 x 300 mm	1	1477K-AC23

Servante d'atelier à hauteur basse  
Servante d'atelier robuste 7 tiroirs





**1470K7LH**

		
755x501x760	1	1470K7LH
755x501x760	1	1470K7LHBLUE
755x501x760	1	1470K7LHGREY
755x501x760	1	1470K7LHRED

Servante d'atelier série "Classique" C75  
Servante 8 tiroirs robuste





**1475K8**

		
956 x 501 x 763 mm	1	1475K8
956 x 501 x 763 mm	1	1475K8BLACK
956 x 501 x 763 mm	1	1475K8BLUE
956 x 501 x 763 mm	1	1475K8RED

Servante d'atelier série "Classique" C75  
Servante 6 tiroirs robustes





**1475K6**

		
956 x 501 x 763 mm	1	1475K6
956 x 501 x 763 mm	1	1475K6BLACK
956 x 501 x 763 mm	1	1475K6BLUE
956 x 501 x 763 mm	1	1475K6RED

Servante C75 Nouvelle Génération  
Servante robuste 6 tiroirs





**1475KXL6**

		
956 x 501 x 1100 mm	1	1475KXL6
956 x 501 x 1100 mm	1	1475KXL6BLACK
956 x 501 x 1100 mm	1	1475KXL6BLUE
956 x 501 x 1100 mm	1	1475KXL6RED

Servante d'atelier série "Classique" C75  
Servante 7 tiroirs robuste



**1475K7**

		
956 x 501 x 763 mm	1	1475K7
956 x 501 x 763 mm	1	1475K7BLACK
956 x 501 x 763 mm	1	1475K7BLUE
956 x 501 x 763 mm	1	1475K7RED

Servante 6 tiroirs C75 avec armoire latérale  
Nouvelle génération



**1475KXL6C**

		
986 x 501 x 1100 mm	1	1475KXL6C
986 x 501 x 1100 mm	1	1475KXL6CBLACK

Servante C75 "Classique"  
Servante robuste 7 tiroirs



**1475KXL7**

956 x 501 x 1100 mm	1	1475KXL7
956 x 501 x 1100 mm	1	1475KXL7BLACK
956 x 501 x 1100 mm	1	1475KXL7BLUE
956 x 501 x 1100 mm	1	1475KXL7RED

Servante C75 "Extra large"  
Servante 8 tiroirs avec armoire latérale 53"



**1475KXXL8CWTSS**

1218 x 500 x 1505 mm	1089	1	1475KXXL8CWTSS

Coffre C85 "Classique"  
Coffre robuste 4 tiroirs



**1485K4**

417 x 500 x 677 mm	1	1485K4
417 x 500 x 677 mm	1	1485K4BLACK
417 x 500 x 677 mm	1	1485K4BLUE
417 x 500 x 677 mm	1	1485K4RED

Servante C75 "Classique"  
Servante robuste 8 tiroirs



**1475KXL8**

956 x 501 x 1100 mm	1	1475KXL8
956 x 501 x 1100 mm	1	1475KXL8BLACK
956 x 501 x 1100 mm	1	1475KXL8BLUE
956 x 501 x 1100 mm	1	1475KXL8RED

Servante d'atelier XXL 53", 12 tiroirs



**1471KXXL12BKTSS**

1016 x 501 x 1440 mm	1	1471KXXL12BKTSS

Coffre C85 "Classique"  
Coffre robuste 4 tiroirs



**1485KXL4**

417 x 500 x 1016 mm	1	1485KXL4
417 x 500 x 1016 mm	1	1485KXL4BLACK
417 x 500 x 1016 mm	1	1485KXL4BLUE
417 x 500 x 1016 mm	1	1485KXL4RED

Servante C75 "Classique"  
Servante robuste 12 tiroirs



**1475KXL12**

986 x 501 x 1100 mm	1	1475KXL12RED
986 x 501 x 1100 mm	1	1475KXL12
986 x 501 x 1100 mm	1	1475KXL12BLACK

Servante d'atelier XXL robuste 53", 7 tiroirs



**1476KXXL7BK**

986 x 501 x 1430 mm	1	1476KXXL7BK

Plateau métallique pliable pour servantes



**1470K-AC1**

9 x 455 x 395 mm	1	1470K-AC1



Porte outils



**1470K-AC2**



280 x 100 x 428 mm



1 1470K-AC2

Plateau latéral avec fentes pour servantes



**1470K-ACSIDE**



822 x 20 x 418 mm



1 1470K-ACSIDE

Panneau mural pour servantes 26"

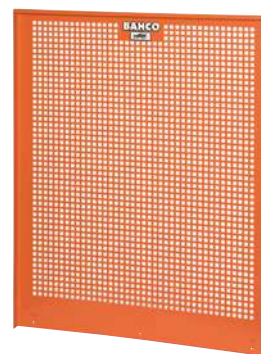

**1470K-AC8**



850 x 25 x 680 mm  
850 x 25 x 680 mm



1 1470K-AC8  
1 1470K-AC8GR

Porte accessoires pour servante



**1470K-AC3**



140 x 90 x 457 mm



1 1470K-AC3

Plateau 26" avec compartiments de rangement pour servante 26"



**1470K-AC7**



45 x 497 x 674 mm



1 1470K-AC7

Tiroir métallique réglable pour armoire latérale



**1470KXLC-TRAY**



470 x 10 x 310 mm



1 1470KXLC-TRAY

Porte-documents pour servante



**1470K-AC4**



180 x 83 x 360 mm



1 1470K-AC4

Panneau latéral métallique pour crochets



**1475K-ACSIDE**



822 x 20 x 418 mm



1 1475K-ACSIDE

Armoire latérale noire pour servante 1475KXL



**1475KXL-AC20BK**



820 x 503 x 419 mm



1 1475KXL-AC20BK

Plateau acier inoxydable 40mm



**1470K-ACTSS**

40 x 495 x 1010 mm	1	1470KXL-ACTSS
38 x 495 x 670 mm	1	1470K-ACTSS

Plateau en châtaignier 40mm



**1470K-ACTW**

40 x 500 x 1012 mm	1	1470KXL-ACTW
40 x 497 x 674 mm	1	1470K-ACTW

Plateau MDF 40mm



**1470K-ACTD**

40 x 495 x 1012 mm	1	1470KXL-ACTD
40 x 497 x 674 mm	1	1470K-ACTD

Jeu de revêtements de tiroirs - 7 pièces



**1470KAC1**

100 x 445 x 543 mm	1	1470KAC01

Servante d'atelier 2 plateaux



**1470KC2**

1051 x 435 x 764 mm	1	1470KC2

Servante d'atelier 3 plateaux



**1470KC3**

1051 x 435 x 764 mm	1	1470KC3

Servante d'atelier 3 tiroirs 2 plateaux



**1470KC5**

1051 x 435 x 1381 mm	1	1470KC5
1025 x 440 x 1315/880 mm	1	1470KC5PC

Tiroir central pour servante 1470KC2



**1470KCTRAY**

750	420	1 1470KCTRAY

Chariot de transport pliable, capacité de charge 120 kg



**1430FT120**

1077 x 520 x 487 mm	6.4 kg	1 1430FT120



**JEUX D'OUTILS MODULES MOUSSE FIT&GO**

FF1E1001-7 pcs



**FF1E1001**



38 x 181 x 445 mm



1 FF1E1001

BE-8030, BE-8040, BE-8242, BE-8252



BE-8610, BE-8620, BE-8623



FF1E1002-7 pcs



**FF1E1002**



39 x 181 x 445 mm



1 FF1E1002

BE-8242



BE-8257



BE-8040



BE-8255



BE-8030



BE-8611, BE-8621



FF1E1003-6 pcs



**FF1E1003**



38 x 181 x 445 mm



1 FF1E1003

BE-8240



BE-8150, BE-8255, BE-8256



BE-8810, BE-8820



FF1E1004-8 pcs



**FF1E1004**



40 x 181 x 445 mm



1 FF1E1004

BE-8340, BE-8350



BE-8600, BE-8610



BE-8811, BE-8800, BE-8820L, BE-8821



FF1E1005-7 pcs



**FF1E1005**



40 x 181 x 445 mm



1 FF1E1005

BE-8210, BE-8010



BE-8811, BE-8821, BE-8800



BE-8600



BE-8830



FF1E1006-6 pcs



**FF1E1006**



40 x 181 x 445 mm



1 FF1E1006

BE-8210



BE-8610, BE-8620



BE-8630



BE-8811, BE-8820



FF1E1007-6 pcs



**FF1E1007**



40 x 181 x 445 mm



1 FF1E1007

BE-8910, BE-8915, BE-8920, BE-8925, BE-8930, BE-8940



FF1E1008-6 pcs



**FF1E1008**



38 x 181 x 445 mm



1 FF1E1008

BE-7910, BE-7930, BE-7925, BE-7920, BE-7915, BE-7940



FF1E1009-6 pcs



**FF1E1009**



38 x 181 x 445 mm



1 FF1E1009

BE-8908, BE-8910, BE-8915, BE-8920, BE-8925, BE-8930



FF1E1010-6 pcs



**FF1E1010**

39 x 181 x 445 mm 1 FF1E1010

- BE-8010S, BE-8230S, BE-8050S, BE-8255S
- BE-8610S, BE-8620S

FF1E1011-6 pcs



**FF1E1011**

45 x 181 x 445 mm 1 FF1E1011

- BE-8040S, BE-8050S, BE-8255S, BE-8065S
- BE-8610S, BE-8620S

FF1E2001-37 pcs



**FF1E2001**

38 x 181 x 445 mm 1 FF1E2001

- 6700SM-10, 6700SM-11, 6700SM-14, 6700SM-13, 6700SM-12, 6700SM-4, 6700SM-9, 6700SM-8, 6700SM-7, 6700SM-6, 6700SM-5.5, 6700SM-5
- 6700TORX-E10, 6700TORX-E8, 6700TORX-E7, 6700TORX-E6, 6700TORX-E5, 6700TORX-E4
- 6709M-8, 6709M-6, 6709M-5, 6709M-4, 6709M-3
- 6709TORX-T20, 6709TORX-T15, 6709TORX-T10, 6709TORX-T40, 6709TORX-T30, 6709TORX-T27, 6709TORX-T25, 6709TORX-T8, 6709TORX-T9
- 6950SL
- 6954
- 6956
- 6960
- 6966

FF1E2002-45 pcs



**FF1E2002**

38 x 181 x 445 mm 1 FF1E2002

- 6700SM-4, 6700SM-4.5, 6700SM-5, 6700SM-5.5, 6700SM-6, 6700SM-7, 6700SM-8, 6700SM-9, 6700SM-10, 6700SM-11, 6700SM-12, 6700SM-13, 6700SM-14
- 6709PZ-1, 6709PZ-3, 6709PZ-2
- 6709PH-1, 6709PH-2, 6709PH-3
- 6709TORX-T10, 6709TORX-T15, 6709TORX-T20, 6709TORX-T25, 6709TORX-T30, 6709TORX-T40
- 6709F-4.5, 6709F-5.5, 6709F-8
- 6709M-3, 6709M-4, 6709M-5, 6709M-6, 6709M-8
- 1998M-3, 1998M-2.5, 1998M-2, 1998M-1.5
- 6950SL
- 6962-W
- 6966
- 6956
- 6960, 6961
- 7765
- 6954

FF1E2003-27 pcs



**FF1E2003**

38 x 181 x 445 mm 1 FF1E2003

- 6700SM-14, 6700SM-13, 6700SM-12, 6700SM-11, 6700SM-10, 6700SM-9, 6700SM-8, 6700SM-7, 6700SM-6, 6700SM-5.5, 6700SM-5
- BE-9778
- 6950SL
- 6956
- 6962
- 6966
- 7765
- 6954
- 1997M-12

FF1E2004-48 pcs



**FF1E2004**

44 x 181 x 445 mm 1 FF1E2004

- A6700DM-14, A6700DM-13, A6700DM-12, A6700DM-11, A6700DM-10, A6700DM-9, A6700DM-8, A6700DM-7, A6700DM-6, A6700DM-5.5, A6700DM-5
- 808050S
- 6950SL
- 6966
- 6972H
- 6962
- 7765
- 59S/31-1



FF1E2005-17 pcs



**FF1E2005**



35 x 181 x 445 mm



1 FF1E2005

- 6700SM-14, 6700SM-13, 6700SM-12, 6700SM-11, 6700SM-10, 6700SM-9, 6700SM-8, 6700SM-7, 6700SM-6, 6700SM-5.5
- 6950RN
- 6962
- 6966
- 6960
- 6954
- 6956
- 6972H

FF1E2006-35 pcs



**FF1E2006**



39 x 181 x 445 mm



1 FF1E2006

- 6700SZ-5/16, 6700SZ-5/32, 6700SZ-11/32, 6700SZ-7/16, 6700SZ-9/32, 6700SZ-3/16, 6700SZ-3/8, 6700SZ-7/32, 6700SZ-1/4, 6700SZ-1/2, 6700SZ-9/16
- 6709PZ-1, 6709PZ-2, 6709PZ-3
- 6709PH-1, 6709PH-2, 6709PH-3
- 6709TORX-T8, 6709TORX-T10, 6709TORX-T15, 6709TORX-T20, 6709TORX-T25, 6709TORX-T30
- 6709F-4.5, 6709F-6.5, 6709F-8
- 6950RN
- 6954
- 6972H
- 6960, 6962
- 6963
- 6966
- 6956
- 7765

FF1E2007-24 pcs



**FF1E2007**



35 x 181 x 445 mm



1 FF1E2007

- 6700SZ-9/32, 6700SZ-3/16, 6700SZ-3/8, 6700SZ-1/4, 6700SZ-7/16, 6700SZ-7/32, 6700SZ-1/2, 6700SZ-11/32
- 1995Z-5/64, 1995Z-5/32, 1995Z-3/8, 1995Z-3/32, 1995Z-7/32, 1995Z-1/8, 1995Z-5/16, 1995Z-3/16, 1995Z-1/4
- 6950RN
- 6954
- 6972H
- 6960, 6962
- 6956
- 6966

FF1E2008-26 pcs



**FF1E2008**



35 x 181 x 445 mm



1 FF1E2008

- 6700SM-5.5, 6700SM-8, 6700SM-7, 6700SM-6, 6700SM-12, 6700SM-11, 6700SM-10, 6700SM-9, 6700SM-14, 6700SM-13
- 1995M-3, 1995M-2, 1995M-7, 1995M-6, 1995M-5, 1995M-4, 1995M-10, 1995M-9, 1995M-8
- 6950RN
- 6960, 6962
- 6966
- 6954
- 6956
- 6972H

FF1E2101-24 pcs



**FF1E2101**



40 x 181 x 445 mm



1 FF1E2101

- 7400SM-8, 7400SM-7, 7400SM-6, 7400SM-12, 7400SM-11, 7400SM-10, 7400SM-9, 7400SM-22, 7400SM-16, 7400SM-15, 7400SM-14, 7400SM-13, 7400SM-20, 7400SM-19, 7400SM-18, 7400SM-17
- 7750SL
- 7760, 7761, 7762
- 7764
- 7766
- 7754
- 8164-1/2

FF1E2102-25 pcs



**FF1E2102**



38 x 181 x 445 mm



1 FF1E2102

- 7400SM-8, 7400SM-7, 7400SM-6, 7400SM-12, 7400SM-11, 7400SM-10, 7400SM-9, 7400SM-16, 7400SM-15, 7400SM-14, 7400SM-13, 7400SM-19, 7400SM-18, 7400SM-17
- 7409M-5, 7409M-4, 7409M-10, 7409M-8, 7409M-6
- 7750SL
- 7760, 7762
- 7754
- 7768
- 8164-1/2



FF1E2103-28 pcs



**FF1E2103**



38 x 181 x 445 mm



1 FF1E2103

7400SM-8, 7400SM-7, 7400SM-12, 7400SM-11, 7400SM-10, 7400SM-9, 7400SM-22, 7400SM-21, 7400SM-16, 7400SM-15, 7400SM-14, 7400SM-13, 7400SM-20, 7400SM-19, 7400SM-18, 7400SM-17		
7400TORX-E10, 7400TORX-E8, 7400TORX-E18, 7400TORX-E16, 7400TORX-E14, 7400TORX-E12		
7750SL		
7760, 7762		
7768		
7766		
SBS705		

FF1E2104-20 pcs



**FF1E2104**



38 x 181 x 445 mm



1 FF1E2104

7400SM-8, 7400SM-6, 7400SM-12, 7400SM-11, 7400SM-10, 7400SM-9, 7400SM-22, 7400SM-16, 7400SM-15, 7400SM-14, 7400SM-13, 7400SM-20, 7400SM-19, 7400SM-18, 7400SM-17		
7750RN		
7761, 7762		
7766		
7768		

FF1E2105-28 pcs



**FF1E2105**



35 x 181 x 445 mm



1 FF1E2105

7400TORX-E18, 7400TORX-E10, 7400TORX-E8, 7400TORX-E16, 7400TORX-E14, 7400TORX-E12, 7400TORX-E11		
7409TORX-T50, 7409TORX-T45, 7409TORX-T40, 7409TORX-T30		
7409TORX-T25-L, 7409TORX-T50-L		
7409TORX-T25		
7409TORX-T45-L, 7409TORX-T40-L, 7409TORX-T30-L		
7409M-5, 7409M-4, 7409M-10, 7409M-8, 7409M-6		
7409F-10, 7409F-8, 7409F-6.5		
7409PH-3, 7409PH-2, 7409PH-1		

FF1E2201-21 pcs



**FF1E2201**



44 x 181 x 445 mm



1 FF1E2201

7800SM-11, 7800SM-10, 7800SM-15, 7800SM-13, 7800SM-12, 7800SM-19, 7800SM-17, 7800SM-14, 7800SM-18, 7800SM-22, 7800SM-21, 7800SM-20, 7800SM-27, 7800SM-24		
7805SM-16, 7805SM-21		
8150SL		
8162-1/2, 8160-1/2		
8166-1/2		
8165-1/2		

FF1E2202-21 pcs



**FF1E2202**



45 x 181 x 445 mm



1 FF1E2202

7800SM-9, 7800SM-8, 7800SM-10, 7800SM-11, 7800SM-12, 7800SM-15, 7800SM-14, 7800SM-13, 7800SM-19, 7800SM-17, 7800SM-16, 7800SM-18, 7800SM-23, 7800SM-21, 7800SM-20, 7800SM-27, 7800SM-24		
8150-1/2		
8160-1/2, 8162-1/2		
8166-1/2		

FF1E2203-22 pcs



**FF1E2203**



50 x 181 x 445 mm



1 FF1E2203

7800SM-8, 7800SM-9, 7800SM-11, 7800SM-10, 7800SM-15, 7800SM-14, 7800SM-13, 7800SM-12, 7800SM-19, 7800SM-18, 7800SM-17, 7800SM-16, 7800SM-22, 7800SM-21, 7800SM-27, 7800SM-24, 7800SM-32, 7800SM-30		
8150RN-1/2		
8160-1/2, 8162-1/2		
8166-1/2		



FF1E2204-15 pcs



**FF1E2204**



45 x 181 x 445 mm



1 FF1E2204

7800DZ-1/2, 7800DZ-3/4, 7800DZ-19/32, 7800DZ-7/8, 7800DZ-7/16, 7800DZ-11/16, 7800DZ-9/16, 7800DZ-13/16, 7800DZ-3/8, 7800DZ-5/8, 7800DZ-15/16



8150RN-1/2



8160-1/2, 8162-1/2



8166-1/2



FF1E2205-28 pcs



**FF1E2205**



50 x 181 x 445 mm



1 FF1E2205

7800DM-10, 7800DM-11, 7800DM-12, 7800DM-13, 7800DM-14, 7800DM-15, 7800DM-16, 7800DM-17, 7800DM-18, 7800DM-19, 7800DM-20, 7800DM-21, 7800DM-22, 7800DM-23, 7800DM-24, 7800DM-25, 7800DM-26, 7800DM-27, 7800DM-28, 7800DM-30, 7800DM-32



7809M-6, 7809M-7, 7809M-8, 7809M-9, 7809M-10, 7809M-12, 7809M-14



FF1E2206-27 pcs



**FF1E2206**



50 x 181 x 445 mm



1 FF1E2206

7800SM-11, 7800SM-10, 7800SM-15, 7800SM-14, 7800SM-13, 7800SM-12, 7800SM-19, 7800SM-18, 7800SM-17, 7800SM-16, 7800SM-23, 7800SM-22, 7800SM-21, 7800SM-20, 7800SM-27, 7800SM-26, 7800SM-25, 7800SM-24, 7800SM-28, 7800SM-32, 7800SM-30



7809XZN-8, 7809XZN-10



7809PZ-3, 7809PZ-2



7809F-10, 7809F-8



FF1E2208-12 pcs



**FF1E2208**



35 x 181 x 445 mm



1 FF1E2208

7809M-9, 7809M-8, 7809M-6, 7809M-7, 7809M-17, 7809M-14, 7809M-12, 7809M-10



7809M-5-180, 7809M-6-140, 7809M-8-120, 7809M-10-140



FF1E2209-20 pcs



**FF1E2209**



35 x 181 x 445 mm



1 FF1E2209

7809M-5, 7809M-8, 7809M-7, 7809M-6, 7809M-17, 7809M-14, 7809M-12, 7809M-10



7809TORX-T27



7809XZN-10



7809TORX-T25



7809XZN-12



7809TORX-T60, 7809TORX-T40, 7809TORX-T30, 7809TORX-T55, 7809TORX-T50, 7809TORX-T45



7809XZN-6, 7809XZN-8



FF1E2207-25 pcs



**FF1E2207**



40 x 181 x 445 mm



1 FF1E2207

7809TORX-T60, 7809TORX-T55, 7809TORX-T25, 7809TORX-T20, 7809TORX-T40, 7809TORX-T30, 7809TORX-T27, 7809TORX-T50, 7809TORX-T45



7800TORX-E18, 7800TORX-E16, 7800TORX-E14, 7800TORX-E12, 7800TORX-E24, 7800TORX-E20, 7800TORX-E10, 7800TORX-E8



BE-9675











FF1E2210-14 pcs



**FF1E2210**

 38 x 181 x 445 mm  1 FF1E2210







- 7809M-5, 7809M-8, 7809M-7, 7809M-6, 7809M-19, 7809M-17, 7809M-14, 7809M-12, 7809M-10  
- BE-7606  
- BWSS12P319, BWSS12P321, BWS-S12P317  
- BE-7607  

FF1E2211-21 pcs



**FF1E2211**

 50 x 181 x 445 mm  1 FF1E2211



- 7993S0050, 7993S0060, 7993S0080, 7993S0100, 7993S0120, 7993S0140, 7993S0170, 7993S0190  
- 7994S0300, 7994S0400, 7994S0450, 7994S0500, 7994S0550, 7994S0600  
- K7801TORX-E10, K7801TORX-E12, K7801TORX-E14, K7801TORX-E16, K7801TORX-E18, K7801TORX-E20, K7801TORX-E24  

FF1E2212-12 pcs



**FF1E2212**

 40 x 181 x 445 mm  1 FF1E2212

- K7801M-17, K7801M-18, K7801M-19, K7801M-21, K7801M-22, K7801M-24, K7801M-10, K7801M-12, K7801M-13, K7801M-14, K7801M-15, K7801M-16  

FF1E2213-15 pcs



**FF1E2213**

 45 x 181 x 445 mm  1 FF1E2213





- K7806M-13, K7806M-14, K7806M-16, K7806M-17, K7806M-18, K7806M-19, K7806M-21, K7806M-22, K7806M-24, K7806M-27, K7806M-30, K7806M-32, K7806M-10, K7806M-15, K7806M-12  

FF1E2501-13 pcs



**FF1E2501**

 35 x 181 x 445 mm  1 FF1E2501





- A7402DM-14, A7402DM-13, A7402DM-12, A7402DM-11, A7402DM-10  
- 7805SM-16, 7805SM-15, 7805SM-14, 7805SM-13, 7805SM-19, 7805SM-18, 7805SM-17, 7805SM-12  

FF1E2502-7 pcs



**FF1E2502**

 45 x 181 x 445 mm  1 FF1E2502



- K560F-4, K560F-5 
- K8167S 
- K8160D-1, K8160D-2 
- K7764D, K8964D 

FF1E5005-35 pcs



**FF1E5005**

 36 x 181 x 445 mm  1 FF1E5005





- BWTSP16  
- 1418S 

FF1E5006-6 pcs



**FF1E5006**

 42 x 181 x 445 mm  1 FF1E5006

- D/S14  
- BWSS12P3  
- BWTB12P120, BWTB12P110 



FF1E5009-17 pcs



**FF1E5009**



36 x 181 x 445 mm



1 FF1E5009

BE6217



FF1E3001-9 pcs



**FF1E3001**



47 x 181 x 445 mm



1 FF1E3001

6M-6-7, 6M-8-9, 6M-10-11, 6M-12-13, 6M-14-15, 6M-16-17, 6M-18-19, 6M-21-23, 6M-22-24



FF1E3002-3 pcs



**FF1E3002**



35 x 181 x 445 mm



1 FF1E3002

6M-25-28, 6M-27-29, 6M-30-32



FF1E3003-9 pcs



**FF1E3003**



41 x 181 x 445 mm



1 FF1E3003

6Z-1/2-9/16, 6Z-15/16-1, 6Z-5/16-11/32, 6Z-5/8-3/4, 6Z-3/8-7/16, 6Z-25/32-13/16, 6Z-19/32-11/16, 6Z-1/4-5/16, 6Z-3/4-7/8



FF1E3004 -10 pcs



**FF1E3004**



39 x 181 x 445 mm



1 FF1E3004

1RM-10, 1RM-9, 1RM-8, 1RM-14, 1RM-13, 1RM-12, 1RM-11, 1RM-17, 1RM-16, 1RM-15



FF1E3005-40 pcs



**FF1E3005**



42 x 181 x 445 mm



1 FF1E3005

59S/31-1



6966

41RM-14, 41RM-13, 41RM-12, 41RM-10, 41RM-8, 41RM-19, 41RM-17



8166-1/2



FF1E3006-8 pcs



**FF1E3006**



35 x 181 x 445 mm



1 FF1E3006

1320RM-6-7, 1320RM-8-9, 1320RM-10-11, 1320RM-12-13, 1320RM-14-15, 1320RM-16-17, 1320RM-18-19, 1320RM-22-24



FF1E3007-7 pcs



**FF1E3007**



35 x 181 x 445 mm



1 FF1E3007

2M-6-7, 2M-8-9, 2M-10-11, 2M-12-13, 2M-14-15, 2M-16-17, 2M-18-19



FF1E3008-9 pcs



**FF1E3008**



50 x 181 x 445 mm



1 FF1E3008

27M-8-9, 27M-10-11, 27M-12-13, 27M-14-15, 27M-16-17, 27M-18-19, 27M-20-22, 27M-21-23, 27M-24-27







FF1E4001-4 pcs

ergo®



**FF1E4001**

 35 x 181 x 445 mm   1 FF1E4001









2628 G-180IP	
8231 IP	 
2430 G-200 IP	
2101G-160IP	

FF1E4002-4 pcs



**FF1E4002**

 35 x 181 x 445 mm   1 FF1E4002

2900-180	 
2890-180	 
2990-180	 
2800-180	 





FF1E5007-3 pcs

ergo®



**FF1E5007**

 38 x 181 x 445 mm   1 FF1E5007









1410	
9033	
8225	 

FF1E5001-7 pcs



**FF1E5001**



 45 x 181 x 445 mm   1 FF1E5001



MTB-5-25	
8045LVDE	 
WR2-MM	
1544	
1178-SCRIBE	
5515T	
1150D	

FF1E5004-35pcs



**FF1E5004**

 36 x 181 x 445 mm   1 FF1E5004





481-400	
3734S/6	
7865	

FF1E5002-11 pcs



**FF1E5002**

 35 x 181 x 445 mm   1 FF1E5002





3740-175, 3740-150, 3740-200	
3734-5, 3734-4, 3734-3, 3734-2, 3734-8, 3734-6	
481-100	
1157	

FF1E5003-11 pcs



**FF1E5003**

 35 x 181 x 445 mm   1 FF1E5003



481-300	
3735-5-120	
3739-300	
3740-125, 3740-100, 3740-150, 3740-200	
3733-5, 3733-4, 3733-3, 3733-2	

FF1E5008-4 pcs



**FF1E5008**

 37 x 181 x 445 mm   1 FF1E5008

7805ZZ-16, 7805ZZ-21	
BE1P	
BE61110	











6 pièces



**FF1E1012EH**



  
 55 x 185 x 480 mm      1 FF1E1012EH

BE-8030		
BE-8150		
BE-8621, BE-8611		
BE-8811, BE-8821		

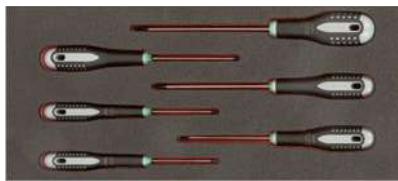

6 pièces



**FF1E1009EH**



  
 55 x 185 x 480 mm      1 FF1E1009EH

BE-8908, BE-8910, BE-8915, BE-8920, BE-8925, BE-8930		
--	---	---



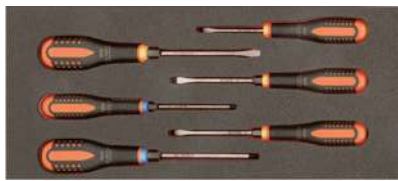

6 pièces



**FF1E1013EH**





  
 55 x 1852 x 480 mm      1 FF1E1013EH







BE-8135TB, BE-8145TB, BE-8150TB, BE-8155TB		
BE-8810TB, BE-8820TB		

46 pièces



**FF1E2009EH**





  
 55 x 185 x 480 mm      1 FF1E2009EH



59/S31B-IP		
6700SM-4, 6700SM-4.5, 6700SM-5, 6700SM-5.5, 6700SM-6, 6700SM-7, 6700SM-8, 6700SM-9, 6700SM-10, 6700SM-11, 6700SM-12, 6700SM-13		
6962-W		
6972H		
6950SL		

11 pièces



**FF1E2010EH**



  
 55 x 185 x 480 mm      1 FF1E2010EH

S0810L	
1419-MD	







18 pièces



**FF1E2106EH**





  
 55 x 185 x 480 mm      1 FF1E2106EH



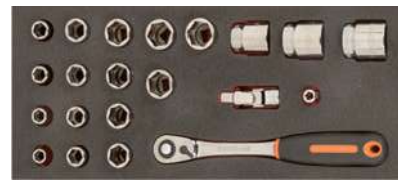

7400SM-10, 7400SM-11, 7400SM-12, 7400SM-13, 7400SM-14, 7400SM-15, 7400SM-16, 7400SM-17, 7400SM-18, 7400SM-19, 7400SM-20, 7400SM-22		
7760, 7761		
7766		
SBS750		
SBS71-16, SBS71-21		

21 pièces



**FF1E2214EH**



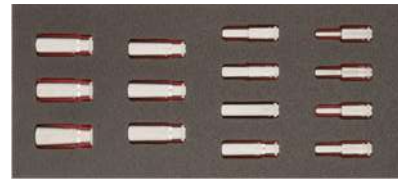

  
 55 x 185 x 480 mm      1 FF1E2214EH

7800SM-10, 7800SM-11, 7800SM-12, 7800SM-13, 7800SM-14, 7800SM-15, 7800SM-16, 7800SM-17, 7800SM-18, 7800SM-19, 7800SM-20, 7800SM-21, 7800SM-22, 7800SM-23, 7800SM-24, 7800SM-27, 7800SM-30, 7800SM-32		
8166-1/2		
7106S		
8150SL		

14 pièces



**FF1E2107EH**

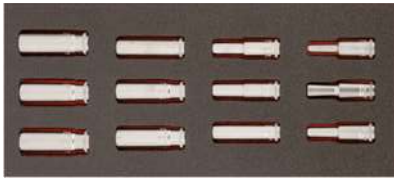

  
 55 x 185 x 480 mm      1 FF1E2107EH

12 pièces



**FF1E2215EH**





55 x 185 x 480 mm      1 FF1E2215EH

S1612L 

49 pièces



**FF1E2503EH**





55 x 185 x 480 mm      1 FF1E2503EH

BE5049 

11 pièces



**FF1E3009EH**





55 x 185 x 480 mm      1 FF1E3009EH

111M-8, 111M-10, 111M-11, 111M-12, 111M-13, 111M-14, 111M-15, 111M-16, 111M-17, 111M-18, 111M-19 

FF1E3010EH, 1/3, 5 pièces

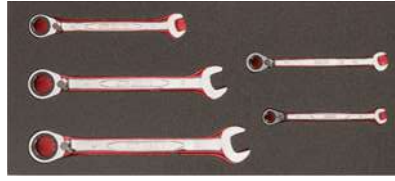

**FF1E3010EH**





55 x 185 x 480 mm      1 FF1E3010EH

1RM-8, 1RM-10, 1RM-13, 1RM-17, 1RM-19 

4 pièces



**FF1E3011EH**





55 x 185 x 480 mm      1 FF1E3011EH

8070 IP, 8071 IP, 8072 IP 1419-MD 

3 pièces

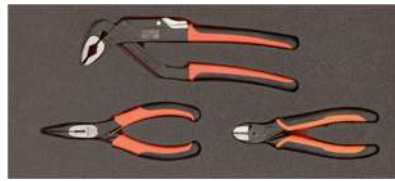



**FF1E4003EH**







55 x 185 x 480 mm      1 FF1E4003EH

8224 IP  2101G-160IP  2430 G-160 IP 





4 pièces



**FF1E4004EH**



55 x 185 x 480 mm      1 FF1E4004EH

2681  MA401  MA411  1178-SCRIBE 





23 pièces



**FF1E5010EH**

55 x 185 x 480 mm      1 FF1E5010EH

481-400  3734-2, 3734-3, 3734-4, 3734-5, 3734-6, 3734-8  3735-5-120  7865 

4 pièces

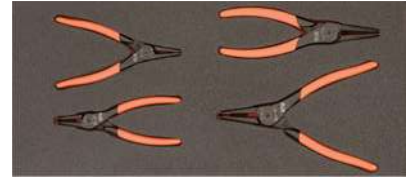

**FF1E4005EH**





55 x 185 x 480 mm      1 FF1E4005EH

2800-150, 2800-180  2900-150, 2900-180 



4 pièces

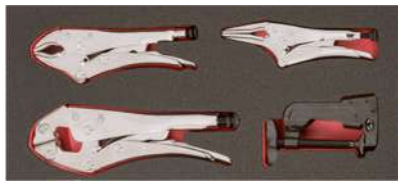

**FF1E4006EH**



55 x 185 x 480 mm 1 FF1E4006EH

2951-180	
2951BV	
2952-165	
2950-250	

11 pièces



**FF1E5011EH**



55 x 185 x 480 mm 1 FF1E5011EH

2633/S4, 2633L/S4	
2489	
2485	
KE18-01	

36 pièces



**FF1E5013EH**



55 x 185 x 480 mm 1 FF1E5013EH

BE-9770	
2058/S26	
1419-MD	

25 pièces

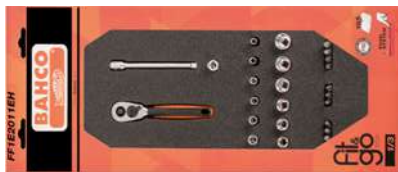

**FF1E2011EH**



55 x 185 x 480 mm 1 FF1E2011EH

SL25	
------	--

24 pièces



**FF1E2216EH**



55 x 185 x 480 mm 1 FF1E2216EH

SBS81	
-------	--

33 pièces



**FF1E2504EH**

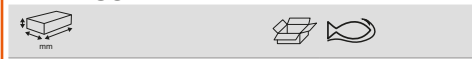

55 x 185 x 480 mm 1 FF1E2504EH

S330	
------	--

34 pièces



**FF1E2505EH**



55 x 185 x 480 mm 1 FF1E2505EH

S330AF	
--------	--

8 pièces



**FF1E5014EH**



55 x 185 x 480 mm 1 FF1E5014EH

9031P	
8224	
208	
3906-300-24-5P	

Module mousse 1/3 vide avec espaces de rangement



**FF1E5016EH**



35 x 181 x 445 mm 1 FF1E5016EH



4 pièces



**FF1E5015EH**

55 x 185 x 480 mm 1 FF1E5015EH

1-100-08-2-2	
1-210-08-2-2	
4-138-08-1-2	
4-272-05-3-2	

FF1F1001-8 pcs



**FF1F1001**

40 x 362 x 445 mm 1 FF1F1001

BE-8210, BE-8030, BE-8040, BE-8240, BE-8242, BE-8252, BE-8250L	
BE-8255, BE-8257	

FF1F1002-11 pcs



**FF1F1002**

40 x 362 x 445 mm 1 FF1F1002

BE-8020	
BE-8330	
BE-8040, BE-8242, BE-8252	
BE-8256, BE-8258	
BE-8610	
BE-8602	
BE-8620, BE-8623	

FF1F1003-11 pcs



**FF1F1003**

38 x 362 x 445 mm 1 FF1F1003

BE-8030, BE-8242	
BE-8155	
BE-8252	
BE-8870	
BE-8600, BE-8610, BE-8620, BE-8623, BE-8624	
808050TS	

FF1F1004-10 pcs



**FF1F1004**

38 x 362 x 445 mm 1 FF1F1004

BE-8904, BE-8907, BE-8908	
BE-7910, BE-7915, BE-7920, BE-7925, BE-7927, BE-7930, BE-7940	

FF1F1005-42 pcs



**FF1F1005**

43 x 362 x 445 mm 1 FF1F1005

BE-8908, BE-8909, BE-8910, BE-8915, BE-8920, BE-8925, BE-8927, BE-8930	
K6650-1/4-1P	
808050S	
808050	
59S/31-3	

FF1F1006-8 pcs



**FF1F1006**

40 x 362 x 445 mm 1 FF1F1006

BE-8230S, BE-8040S, BE-8050S, BE-8255S	
BE-8810S, BE-8820S	
BE-8610S, BE-8620S	



FF1F1007-7 pcs



**FF1F1007**

 35 x 362 x 445 mm  1 FF1F1007









901T-010-100, 901T-015-150, 901T-020-150, 901T-025-150, 901T-027-150, 901T-030-200, 901T-040-200 

FF1F1008-49 pcs



**FF1F1008**

 38 x 362 x 445 mm  1 FF1F1008











B219.026		
B705.1/4.125		
B146.006.100		
B145.006.100		
BE-9770		
59S/31-1		

FF1F1009-14 pcs



**FF1F1009**

 38 x 362 x 445 mm  1 FF1F1009



B219.026		
B219.025		
B196.030.100		
B195.002.025		
B195.050.025		

FF1F2001-44 pcs



**FF1F2001**

 37 x 362 x 445 mm  1 FF1F2001





A6800DM-11, A6800DM-10, A6800DM-9, A6800DM-8, A6800DM-13, A6800DM-12, A6800DM-4, A6800DM-7, A6800DM-6, A6800DM-5.5, A6800DM-5		
6700SM-8, 6700SM-7, 6700SM-6, 6700SM-5.5, 6700SM-12, 6700SM-11, 6700SM-10, 6700SM-9, 6700SM-14, 6700SM-5, 6700SM-13		
6709PH-2, 6709PH-1, 6709PH-3		
6709PZ-2, 6709PZ-1		
6709M-5, 6709M-4, 6709M-3, 6709M-8, 6709M-6		
6709F-5.5, 6709F-4.5, 6709F-8		
BE-9778		
6950SL		
7765		
6954		
6962		
6966		
6972H		
6956		
1997M-12		

FF1F2002-53 pcs



**FF1F2002**

 45 x 362 x 445 mm  1 FF1F2002















SL25L	
2058/S26	
6956	
1419-MD	

FF1F2101-36 pcs



**FF1F2101**

 37 x 362 x 445 mm  1 FF1F2101

7400SM-8, 7400SM-7, 7400SM-12, 7400SM-11, 7400SM-10, 7400SM-9, 7400SM-22, 7400SM-21, 7400SM-16, 7400SM-15, 7400SM-14, 7400SM-13, 7400SM-20, 7400SM-19, 7400SM-18, 7400SM-17		
7409M-8, 7409M-4, 7409M-6, 7409M-10		
A7402DM-13, A7402DM-12, A7402DM-11, A7402DM-10		
A7410DZ-5/16, A7410DZ-7/16, A7410DZ-9/16, A7410DZ-3/8, A7410DZ-5/8		
7750SL		
7762		
7754		
7766		
7764		
7757		
8164-1/2		

FF1F2102-34 pcs



**FF1F2102**

 40 x 362 x 445 mm  1 FF1F2102

S330L	
-------	---

FF1F2103-38 pcs



**FF1F2103**



35 x 362 x 445 mm



1 FF1F2103

S380



FF1F2201-35 pcs



**FF1F2201**



50 x 362 x 445 mm



1 FF1F2201

7800SM-13, 7800SM-12, 7800SM-19,  
7800SM-18, 7800SM-10, 7800SM-17,  
7800SM-22, 7800SM-21, 7800SM-20,  
7800SM-27, 7800SM-24, 7800SM-32,  
7800SM-30



7800DM-16, 7800DM-15, 7800DM-14,  
7800DM-13, 7800DM-19, 7800DM-18,  
7800DM-17, 7800DM-12, 7800DM-11,  
7800DM-10



7809M-5, 7809M-6, 7809M-7, 7809M-8,  
7809M-12, 7809M-10



8150SL



8160-1/2



8166-1/2



8154-1/2



8165-1/2



8162-1/2



FF1F2202-24 pcs



**FF1F2202**



50 x 362 x 445 mm



1 FF1F2202

S240



S81SL



FF1F5004-50 pcs



**FF1F5004**



35 x 362 x 445 mm



1 FF1F5004

BE5049



1419-MD



FF1F5013-39 pièces



**FF1F5013**



35 x 362 x 445 mm



1 FF1F5013

BS1000



FF1F2203-27 pcs



**FF1F2203**



50 x 362 x 445 mm



1 FF1F2203

K7801M-17, K7801M-18, K7801M-19,  
K7801M-21, K7801M-22, K7801M-24,  
K7801M-10, K7801M-12, K7801M-13,  
K7801M-14, K7801M-15, K7801M-16



K7806M-13, K7806M-14, K7806M-16,  
K7806M-17, K7806M-18, K7806M-19,  
K7806M-21, K7806M-22, K7806M-24,  
K7806M-27, K7806M-30, K7806M-32,  
K7806M-10, K7806M-15, K7806M-12



FF1F3001-11 pcs



**FF1F3001**



40 x 362 x 445 mm



1 FF1F3001

6M-6-7, 6M-8-9, 6M-10-11, 6M-12-13, 6M-14-15,  
6M-16-18, 6M-17-19, 6M-20-22, 6M-21-23, 6M-  
24-27, 6M-30-32



FF1F3002-18 pcs



**FF1F3002**



41 x 362 x 445 mm



1 FF1F3002

111M-24, 111M-22, 111M-27, 111M-17,  
111M-16, 111M-15, 111M-14, 111M-21,  
111M-19, 111M-18, 111M-9, 111M-8,  
111M-7, 111M-6, 111M-13, 111M-12,  
111M-11, 111M-10









FF1F3003-30 pcs



**FF1F3003**

 40 x 362 x 445 mm  1 FF1F3003

- 111M-6, 111M-7, 111M-8, 111M-9, 111M-17, 111M-16, 111M-15, 111M-14, 111M-19, 111M-18, 111M-13, 111M-12, 111M-11, 111M-10, 111M-21, 111M-20, 111M-22 
- 1320SRM-14-19 
- 1RMA-19-1/4-SQ 
- 1RMA-13-10-BIT 
- BE-9778 

- 1RM-8, 1RM-19, 1RM-10, 1RM-14, 1RM-13, 1RM-12, 1RM-18, 1RM-17, 1RM-16, 1RM-15, 1RM-22, 1RM-21 
- 1RMA-13-10-BIT 

- 4040M-6-7, 4040M-8-9, 4040M-10-11, 4040M-12-13, 4040M-14-15, 4040M-16-17, 4040M-18-19, 4040M-20-22, 4040M-21-23 

FF1F3006-7 pcs



**FF1F3006**

 35 x 362 x 445 mm  1 FF1F3006

- 1RM-19, 1RM-24, 1RM-22, 1RM-21, 1RM-27, 1RM-30 

FF1F3009-8 pcs



**FF1F3009**

 35 x 362 x 445 mm  1 FF1F3009

- 1949M-8-9, 1949M-10-11, 1949M-12-13, 1949M-14-15, 1949M-17-19, 1949M-19-22, 1949M-24-27, 1949M-30-32 

FF1F3004-13 pcs



**FF1F3004**

 42 x 362 x 445 mm  1 FF1F3004

- 111Z-3/8, 111Z-11/16, 111Z-1, 111Z-1/2, 111Z-13/16, 111Z-5/16, 111Z-5/8, 111Z-15/16, 111Z-7/16, 111Z-3/4, 111Z-1/4, 111Z-9/16, 111Z-7/8 

FF1F3007-10 pcs



**FF1F3007**

 47 x 362 x 445 mm  1 FF1F3007



- 2M-6-7, 2M-8-9, 2M-10-11, 2M-12-13, 2M-14-15, 2M-16-18, 2M-17-19, 2M-21-23, 2M-24-27, 2M-30-32 

FF1F3010-17 pcs



**FF1F3010**

 35 x 362 x 445 mm  1 FF1F3010

- 1RM/S5 
- 111M/SH12 

FF1F3005-15 pcs



**FF1F3005**

 39 x 362 x 445 mm  1 FF1F3005

FF1F3008-9 pcs



**FF1F3008**



 38 x 362 x 445 mm  1 FF1F3008

FF1F3011-13 pcs





**FF1F3011**









 35 x 362 x 445 mm  1 FF1F3011

S4RM/3T	
111M/SH12	

FF1F4001-8 pcs















<b>FF1F4001</b>		
35 x 362 x 445 mm	1	FF1F4001

2430 G-160 IP	
2421 G-180 IP	
2101G-160IP	
2628 G-200	
8224 IP	 
9029	
2951-140, 2951-300	

FF1F4002-8 pcs







<b>FF1F4002</b>		
35 x 362 x 445 mm	1	FF1F4002

2928-160	 
2951-250	
SC127	
2101G-160IP	
2430 G-160 IP	
2339 DIP	
2628 G-180IP	
8224 IP	 

FF1F4003-4 pcs











<b>FF1F4003</b>		
35 x 362 x 445 mm	1	FF1F4003

2101G-160IP	
8224 IP	 
2951-180	
2430 G-200 IP	

FF1F4004-8 pcs







<b>FF1F4004</b>		
35 x 362 x 445 mm	1	FF1F4004

2800-140, 2800-180	 
2890-140, 2890-180	 
2900-140, 2900-180	 
2990-140, 2990-180	 

FF1F4005-5 pcs











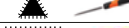

<b>FF1F4005</b>		
38 x 362 x 445 mm	1	FF1F4005

2101S-160	 1000 V HCRANO
2430 S-200	 1000 V HCRANO
2427 S-200	 1000 V HCRANO
8224 IP	 1000 V HCRANO
2628 S-180	 1000 V HCRANO

FF1F5001-10 pcs







<b>FF1F5001</b>		
40 x 362 x 445 mm	1	FF1F5001

1-100-08-1-2	
1-160-08-1-2	
1-170-08-1-2	
1-210-08-1-2	
1-230-08-1-2	
2430 G-200 IP	
2628G-200IP	
7224	
2101G-160IP	
MTB-3-16	

FF1F5002-5 pcs



<b>FF1F5002</b>		
38 x 362 x 445 mm	1	FF1F5002

2681	
MA401	
MA411	
1178-SCRIBE	
MTG-5-19	



FF1F5003-5 pcs



**FF1F5003**

35 x 362 x 445 mm 1 FF1F5003

8224	
2101G-160	
2430 G-160	
8071	
2951-250	

FF1F5005-8 pcs



**FF1F5005**

40 x 362 x 445 mm 1 FF1F5005

317	
3906-300-24-5P	
268	
2446	

FF1F5006-4 pcs



**FF1F5006**

50 x 362 x 445 mm 1 FF1F5006

CR W 01	
CR B 05	
3418 A	
BMMTRMS1	

FF1F5007-5 pcs



**FF1F5007**

45 x 362 x 445 mm 1 FF1F5007

4543-1, 4543-2, 4543-3	
4545-2	
4541-A	

FF1F5008-11 pcs



**FF1F5008**

37 x 362 x 445 mm 1 FF1F5008

2633/S4, 2633L/S4	
2489	
2485	
KE18-01	

FF1F5009-5 pcs



**FF1F5009**

60 x 362 x 445 mm 1 FF1F5009

BS618, BS623	
4545-2	
4545-N11	
4532-0	

FF1F5010-9 pcs



**FF1F5010**

45 x 362 x 445 mm 1 FF1F5010

BBR6135	
BBR6131	
BBR110	
1949M-8-9, 1949M-10-11	
7809M-6, 7809M-8, 7809M-10	
783	

FF1F5011-7 pcs



**FF1F5011**

100 x 362 x 445 mm 1 FF1F5011

BP815	
BP821	
BP822	
BP823	

FF1F5012-9 pcs



**FF1F5012**



55 x 362 x 445 mm



1 FF1F5012

BWSS12P317, BWSS12P319, BWS-S12P321

BPC814

BWTB12P120

GL008-10

783

8158-1/2

FF1A10 - 66 PCS



**FF1A10**



45 x 543 x 445 mm



1 FF1A10

BE-8020L, BE-8030

BE-8155

BE-8260

BE-8350

BE-8601, BE-8602

BE-8610, BE-8620

BE-8630

BE-8910, BE-8915, BE-8920, BE-8925, BE-8927, BE-8930, BE-8940

BE-9770

MTB-3-16

1150-1/2H/P

1177-SCRIBE

2820EF2

5515T-52

808050S

2047-0.8-4

2047PR-1-2

59S/31-1

FF1A1001 - 14 PCS



**FF1A1001**



45 x 543 x 445 mm



1 FF1A1001

2509

2535F1

BE-8040, BE-8210, BE-8230, BE-8252

BE-8255

BE-8350

BE-8628

BE-8602

BE-8610L, BE-8620L

BE-8629, BE-8630

FF1A1002 - 27 PCS



**FF1A1002**



40 x 543 x 445 mm



1 FF1A1002

BE-8210, BE-8030, BE-8040

BE-8350

BE-8242, BE-8252

BE-8257, BE-8258

BE-8880

BE-8602

BE-8610, BE-8620

BE-8630, BE-8640

BE-8800

BE-8802

BE-8810, BE-8820

BE-9578

FF1A1003 - 34 PCS



**FF1A1003**



40 x 543 x 445 mm



1 FF1A1003

BE-8158, BE-8159

BE-8350

BE-8870, BE-8880

BE-8610

BE-8602

BE-8630

BE-8908

BE-9575

BE-8909, BE-8910, BE-8915, BE-8920, BE-8925, BE-8927, BE-8930, BE-8940

BE-9578

FF1A1005 - 66 PCS



**FF1A1005**



43 x 543 x 445 mm



1 FF1A1005

59S/31-1

BE-8020, BE-8240

BE-8250, BE-8255

BE-8865

BE-8602

BE-8611

BE-9585

BE-8621

BE-8630

BE-8800

BE-8802

BE-8811, BE-8821

BE-8830

BE-8910, BE-8915, BE-8920, BE-8925

BE-9678



FF1A1006 - 29 PCS



**FF1A1006**

40 x 543 x 445 mm 1 FF1A1006

BE-8030, BE-8040		
BE-8155		
BE-8350		
BE-8602		
BE-8611, BE-8621		
BE-8630		
BE-8906, BE-8907, BE-8908, BE-8909, BE-8910, BE-8915, BE-8920, BE-8925, BE-8930, BE-8940		
BE-9688		
BE-7606, BE-7607		

FF1A1007 - 62 PCS



**FF1A1007**

44 x 543 x 445 mm 1 FF1A1007

2510		
5468-112		
5471 F-145		
BE-8040		
BE-8158, BE-8159		
BE-8220		
BE-8340		
BE-8601		
BE-8628, BE-8629		
BE-8865		
BE-8906, BE-8907, BE-8908, BE-8909, BE-8910, BE-8915, BE-8920, BE-8925, BE-8930		
BE-9770		
TL 124-SA_oldP		

FF1A1008 - 60 PCS



**FF1A1008**

49 x 543 x 445 mm 1 FF1A1008

BE-8020L		
59S/31-1		
808050		
BE-8040		
BE-8150, BE-8255, BE-8256		
BE-8340		
BE-8601		
BE-8610, BE-8620		
BE-8925, BE-8927, BE-8930, BE-8940, BE-8945		
BE-9678		

FF1A17-66 pcs



**FF1A17**

50 x 543 x 445 mm 1 FF1A17

BE-8020L		
BE-8150, BE-8155		
BE-8220		
BE-8260		
BE-8350		
BE-8601, BE-8602		
BE-8610, BE-8620		
BE-8630		
BE-9780		
2047-1-5.5		
2047PR-1-2		
706-2		
808050		
59/S28-4		

FF1A21-66 pcs



**FF1A21**

48 x 543 x 445 mm 1 FF1A21

BE-8257, BE-8255		
BE-8242, BE-8040, BE-8030		
59S/31-1		
BE-8611, BE-8620		
BE-8910, BE-8915, BE-8920		
BE-9575		
BE-8925, BE-8927, BE-8930, BE-8940		
BE-8577		
BE-8355		
BE-8602		
BE-9678		
2446		
7800SM-15		

FF1A27-65 pcs



**FF1A27**

45 x 543 x 445 mm 1 FF1A27

BE-8257, BE-8255		
BE-8242, BE-8040, BE-8030		
BE-8611		
59S/31-1		
BE-8620		
BE-8910, BE-8915		
BE-9575		
BE-8920, BE-8925, BE-8927, BE-8930, BE-8940		
BE-8577		
BE-8355		
BE-9678		
BE-8602		



FF1A40, 54 pcs



**FF1A40**

45 x 543 x 445 mm	1	FF1A40

BE-8020, BE-8040		
BE-8150, BE-8155		
BE-8611, BE-8621		
BE-8811, BE-8821		
BE-8910, BE-8915, BE-8920, BE-8925, BE-8930		
904T-060-150		
BE-9770		
59S/31-1		

FF1A49-50 pcs



**FF1A49**

50 x 543 x 445 mm	1	FF1A49

808050P	
808050S	
6972H	
038.055.100, 038.065.125, 038.080.150	
039.001.100	
59S/31-1	
039.002.125	
BE-8040	
BE-8150	
BE-8010S, BE-8230S	
BE-8155	
9045-B-250	
1150D	
426TOR9	
1179-FLX	
1178-SCRIBE	
MTS-5-25	

FF1A5001-27 pcs



**FF1A5001**

40 x 543 x 445 mm	1	FF1A5001

2430 G-200 IP	
2101G-160IP	
2628 G-180IP	
2951-180	
7224	
BE-8150, BE-8155	
BE-8355	
BE-8256	
BE-8611	
BE-8602	
BE-8620	
BE-8910, BE-8915, BE-8920, BE-8925, BE-8930, BE-8940	
BE-9770	

FF1A166, 22 pcs



**FF1A166**

40 x 543 x 445 mm	1	FF1A166

9715-14-250		
BE-3529		
BE-8010, BE-8030		
BE-8150TB, BE-8256TB		
BE-8602		
BE-8611, BE-8621		
BE-8703, BE-8704, BE-8705, BE-8706, BE-8708		
BE-8811, BE-8821		
BE-8910, BE-8915, BE-8920, BE-8925, BE-8930		
BE-8986		

37 pièces



**FF1A201LM**

40 x 445 x 543 mm	1	FF1A201LM

BE-8256TB		
BE-8620TB, BE-8623TB		
700-2-50		
701-00-50, 701-0-50, 701-1-75		
703-10-50, 703-15-75, 703-6-50, 703-7-50, 703-8-50, 703-9-50		
BE-8040SL		
BE-8040		
BE-8150, BE-8155, BE-8256		
BE-8355		
BE-8600		
BE-8602		
BE-8611, BE-8621, BE-8623		
BE-8811, BE-8821		
BE-8802		
BE-8870		
BE-9787		



FF1A01 - 77 PCS



**FF1A01**



45 x 543 x 445 mm



1 FF1A01

A6800DM-6, A6800DM-7, A6800DM-8, A6800DM-9, A6800DM-10, A6800DM-11, A6800DM-12, A6800DM-13, A6800DM-4, A6800DM-5		
6700SM-4.5, 6700SM-5, 6700SM-5.5, 6700SM-6, 6700SM-7, 6700SM-8		
59S/22-1		
6700SM-9, 6700SM-10, 6700SM-11, 6700SM-12, 6700SM-13, 6700SM-4		
6950SL		
6954		
6956		
6960, 6961		
6966		
6972H		
7800SM-18, 7800SM-19, 7800SM-10, 7800SM-11, 7800SM-12, 7800SM-13, 7800SM-14, 7800SM-15, 7800SM-16, 7800SM-17, 7800SM-22, 7800SM-27, 7800SM-24, 7800SM-30, 7800SM-32		
7805ZZ-21		
7807H		
B191.040.100, B191.055.150		
B192.001.100, B192.002.125		
8150SL		
8154-1/2		
8159-1/2, 8162-1/2		
8166-1/2		

FF1A05 - 109 PCS



**FF1A05**



50 x 543 x 445 mm



1 FF1A05

BE-9678		
SBS60-4, SBS60-7, SBS60-8, SBS60-9, SBS60-10, SBS60-11, SBS60-12, SBS60-13, SBS60-14, SBS60-4.5, SBS60-5, SBS60-5.5, SBS60-6		
SBS61		
SBS63-2, SBS63-4, SBS63-6		
SBS64		
SBS65		
SBS67		
SBS69		
SBS80-13, SBS80-14, SBS80-15, SBS80-16, SBS80-17, SBS80-18, SBS80-19, SBS80-10, SBS80-11, SBS80-12, SBS80-22, SBS80-24, SBS80-27, SBS80-21, SBS80-30, SBS80-32		
SBS88		
6956		
6972H		
7809M-12, 7809M-14, 7809M-17		
59S/31-1		
7809M-5, 7809M-19, 7809M-6, 7809M-7, 7809M-8, 7809M-10		
7809TORX-T50, 7809TORX-T55, 7809TORX-T60, 7809TORX-T20, 7809TORX-T25, 7809TORX-T27, 7809TORX-T30, 7809TORX-T40, 7809TORX-T45		
808050		
8150SL		
8154-1/2		
8160-W		
8162-1/2		
8166-1/2		

FF1A08 - 168 PCS



**FF1A08**



60 x 543 x 445 mm



1 FF1A08

A6800DM-6, A6800DM-7, A6800DM-8, A6800DM-9, A6800DM-10, A6800DM-11, A6800DM-12, A6800DM-13, A6800DM-5.5		
A7402DM-19, A7402DM-10, A7402DM-11, A7402DM-12, A7402DM-13, A7402DM-14, A7402DM-15, A7402DM-16, A7402DM-17, A7402DM-18		

1544		
6700SM-5.5, 6700SM-6, 6700SM-7, 6700SM-8, 6700SM-9, 6700SM-10, 6700SM-11, 6700SM-12, 6700SM-13		
6709M-3, 6709M-4, 6709M-5, 6709M-6, 6709M-8		
6709PH-1, 6709PH-2, 6709PH-3		
6709TORX-T20, 6709TORX-T25, 6709TORX-T27, 6709TORX-T30, 6709TORX-T40, 6709TORX-T8, 6709TORX-T9, 6709TORX-T10, 6709TORX-T15		
6950SL		
6954		
6956		
6958		
6960, 6961, 6962, 6962L		
6966		
6972H		
7400SM-6, 7400SM-7, 7400SM-8, 7400SM-9, 7400SM-10, 7400SM-11, 7400SM-12, 7400SM-13, 7400SM-14, 7400SM-15, 7400SM-16, 7400SM-17, 7400SM-18, 7400SM-19, 7400SM-22		
7407H		
7409M-8, 7409M-10, 7409M-3, 7409M-4, 7409M-5, 7409M-6, 7409M-7		
7409TORX-T25, 7409TORX-T27, 7409TORX-T30, 7409TORX-T40, 7409TORX-T45, 7409TORX-T50		
7750SL		
7754		
7758		
7760, 7761, 7762		
7764		
7765		
7766		
7800SM-18, 7800SM-19, 7800SM-21, 7800SM-22, 7800SM-24, 7800SM-27, 7800SM-30, 7800SM-32, 7800SM-10, 7800SM-11, 7800SM-12, 7800SM-13, 7800SM-14, 7800SM-15, 7800SM-16, 7800SM-17		
7807H		
7809M-12, 7809M-14, 7809M-17, 7809M-19, 7809M-5, 7809M-6, 7809M-7, 7809M-8, 7809M-10		
7809TORX-T50, 7809TORX-T55, 7809TORX-T60, 7809TORX-T20, 7809TORX-T25, 7809TORX-T27, 7809TORX-T30, 7809TORX-T40, 7809TORX-T45		
8150SL		
8154-1/2		
8160-1/2, 8162-1/2		
8164-1/2		
8165-1/2		
8166-1/2		
8964		

Douilles, 93 pcs



### FF1A106

55 x 543 x 445 mm 1 FF1A106

4040M-8-9, 4040M-10-11, 4040M-12-13, 4040M-14-15		
SBS20-7, SBS20-17, SBS20-16, SBS20-19, SBS20-18, SBS20-9, SBS20-8, SBS20-11, SBS20-10, SBS20-13, SBS20-12, SBS20-15, SBS20-14		
7805ZZ-21		
SBS85		
SBS83-10		
SBS81		
SBS61		
SBS60-5.5, SBS60-5, SBS60-7, SBS60-6, SBS60-9, SBS60-8, SBS60-11, SBS60-10, SBS60-13, SBS60-12, SBS60-4.5, SBS60-4		
K7801M-17, K7801M-19, K7801M-21, K7801M-24		
SBS80-11, SBS80-10, SBS80-13, SBS80-12, SBS80-15, SBS80-14, SBS80-17, SBS80-16, SBS80-32, SBS80-19, SBS80-18, SBS80-22, SBS80-21, SBS80-24, SBS80-23, SBS80-30, SBS80-27		
SBS83-5		
1995M-1.5, 1995M-2.5, 1995M-2		
6966		
SBS64		
SBS63-4, SBS63-2		

FF1A13-83 pcs



### FF1A13

55 x 543 x 445 mm 1 FF1A13

A6700DZ-1/2, A6700DZ-1/4, A6700DZ-11/32, A6700DZ-3/16, A6700DZ-3/8, A6700DZ-5/16, A6700DZ-7/16, A6700DZ-7/32, A6700DZ-9/16, A6700DZ-9/32		
A6710DZ-1/2, A6710DZ-1/4, A6710DZ-11/32, A6710DZ-3/16, A6710DZ-3/8, A6710DZ-5/16, A6710DZ-7/16, A6710DZ-7/32, A6710DZ-9/16, A6710DZ-9/32		
A6800DM-10, A6800DM-4		
A6800DZ-1/2, A6800DZ-1/4, A6800DZ-11/32, A6800DZ-3/16, A6800DZ-3/8, A6800DZ-5/16, A6800DZ-7/16, A6800DZ-7/32, A6800DZ-9/16, A6800DZ-9/32		
A7400DZ-1/2, A7400DZ-1/4, A7400DZ-11/16, A7400DZ-13/16, A7400DZ-17/32, A7400DZ-19/32, A7400DZ-3/4, A7400DZ-3/8, A7400DZ-5/8, A7400DZ-7/8, A7400DZ-9/16		
A7402DZ-1/2, A7402DZ-1/4, A7402DZ-11/16, A7402DZ-13/16, A7402DZ-19/32, A7402DZ-3/4, A7402DZ-3/8, A7402DZ-5/16, A7402DZ-5/8, A7402DZ-7/16, A7402DZ-7/8, A7402DZ-9/16		
6700SZ-5/32		
6950SL		
6954		
6956		
6958		
6960, 6961, 6962, 6962L		
6966		
6972H		
7407H, 7408H		
7750SL		
7752		
7754		
7758		
7760, 7761, 7762		
7764		
7765		
7766		
8164-1/2		
8165-1/2		

Douilles et accessoires 1/2", 53 pcs



### FF1A130

45 x 543 x 445 mm 1 FF1A130

7800SM-18, 7800SM-19, 7800SM-21, 7800SM-22, 7800SM-23, 7800SM-24, 7800SM-27, 7800SM-30, 7800SM-32, 7800SM-8, 7800SM-9, 7800SM-10, 7800SM-11, 7800SM-12, 7800SM-13, 7800SM-14, 7800SM-15, 7800SM-16, 7800SM-17		
8150SL		
SBS87S, SBS87		
SBS83-3, SBS83-5, SBS83-10		
SBS85		
SBS86		
SBS88		
SBS89		
7809TORX-T50, 7809TORX-T55, 7809TORX-T60, 7809TORX-T20, 7809TORX-T25, 7809TORX-T27, 7809TORX-T30, 7809TORX-T40		
7809M-14, 7809M-17, 7809M-19, 7809M-5, 7809M-6, 7809M-7, 7809M-8, 7809M-9, 7809M-10, 7809M-12		
7809TORX-T45		
7809M-5-180, 7809M-6-140, 7809M-7-100, 7809M-8-120, 7809M-10-140		



Douilles et accessoires 1/4"-1/2", 59 pcs



**FF1A137**

50 x 543 x 445 mm 1 FF1A137

7800SM-18, 7800SM-19, 7800SM-21, 7800SM-22, 7800SM-23, 7800SM-24, 7800SM-27, 7800SM-30, 7800SM-32, 7800SM-8, 7800SM-9, 7800SM-10, 7800SM-11, 7800SM-12, 7800SM-13, 7800SM-14, 7800SM-15, 7800SM-16, 7800SM-17

8150SL  
SBS87S, SBS87  
SBS83-3, SBS83-5, SBS83-10  
SBS85  
SBS86  
SBS88  
SBS89

7809TORX-T50, 7809TORX-T55, 7809TORX-T60, 7809TORX-T20, 7809TORX-T25, 7809TORX-T27, 7809TORX-T30, 7809TORX-T40, 7809TORX-T45

6700SM-4.5, 6700SM-5, 6700SM-5.5, 6700SM-6, 6700SM-7, 6700SM-8, 6700SM-9, 6700SM-10, 6700SM-11, 6700SM-12, 6700SM-13, 6700SM-14, 6700SM-4

6950SL  
SBS67  
SBS64  
SBS69  
SBS65  
SBS63-2, SBS63-4, SBS63-6

Douilles, clés mâles 6 pans, embouts, 71 pcs



**FF1A142**

50 x 543 x 445 mm 1 FF1A142

7800SM-18, 7800SM-19, 7800SM-21, 7800SM-22, 7800SM-23, 7800SM-24, 7800SM-27, 7800SM-30, 7800SM-32, 7800SM-8, 7800SM-9, 7800SM-10, 7800SM-11, 7800SM-12, 7800SM-13, 7800SM-14, 7800SM-15, 7800SM-16, 7800SM-17

8150SL  
BE-9678  
SBS87S, SBS87  
SBS83-3, SBS83-5, SBS83-10  
SBS85  
SBS86  
SBS88  
SBS89  
1547  
1150D  
59S/31-1

Douilles et pinces, 34 pcs



**FF1A146**

50 x 543 x 445 mm 1 FF1A146

2628 G-180  
2430 G-160  
8224  
2101G-160  
FS-8

7800SM-18, 7800SM-19, 7800SM-21, 7800SM-22, 7800SM-23, 7800SM-24, 7800SM-27, 7800SM-30, 7800SM-32, 7800SM-8, 7800SM-9, 7800SM-10, 7800SM-11, 7800SM-12, 7800SM-13, 7800SM-14, 7800SM-15, 7800SM-16, 7800SM-17

8150SL  
SBS87S, SBS87  
SBS83-3, SBS83-5, SBS83-10  
SBS85  
SBS86  
SBS88  
SBS89

FF1A22-58 pcs



**FF1A22**

50 x 543 x 445 mm 1 FF1A22

7800SM-18, 7800SM-19, 7800SM-21, 7800SM-22, 7800SM-23, 7800SM-24, 7800SM-27, 7800SM-30, 7800SM-32, 7800SM-10, 7800SM-12, 7800SM-13, 7800SM-14, 7800SM-16, 7800SM-17

7805SM-27, 7805SM-13, 7805SM-30, 7805SM-16, 7805SM-32, 7805SM-17, 7805SM-18, 7805SM-19, 7805SM-21, 7805SM-22, 7805SM-24

7809M-12, 7809M-14, 7809M-8, 7809M-5, 7809M-10, 7809M-6

8158-1/2  
8154-1/2  
8159-1/2, 8160-1/2  
8166-1/2  
8150SL

6700SM-4.5, 6700SM-5, 6700SM-5.5, 6700SM-6, 6700SM-7, 6700SM-8, 6700SM-9, 6700SM-10, 6700SM-11, 6700SM-12, 6700SM-13, 6700SM-4

6958  
6954  
6960, 6962  
6966  
6950SL  
4532-A

FF1A2301-26 pcs



**FF1A2301**

70 x 543 x 445 mm 1 FF1A2301

8900DM-19, 8900DM-26, 8900DM-25, 8900DM-24, 8900DM-23, 8900DM-29, 8900DM-28, 8900DM-27, 8900DM-22, 8900DM-34, 8900DM-33, 8900DM-32, 8900DM-30, 8900DM-36, 8900DM-41, 8900DM-46, 8900DM-55, 8900DM-50, 8900DM-60		
8954		
8954A		
8958A		
8961		
8965		
8966		
8952N/B		

FF1A25-50 pcs



**FF1A25**

50 x 543 x 445 mm 1 FF1A25

7800SM-18, 7800SM-19, 7800SM-21, 7800SM-22, 7800SM-23, 7800SM-24, 7800SM-27, 7800SM-30, 7800SM-32, 7800SM-10, 7800SM-12, 7800SM-13, 7800SM-14, 7800SM-15, 7800SM-16, 7800SM-17		
7805SM-27, 7805SM-13, 7805SM-30, 7805SM-32, 7805SM-16, 7805SM-17, 7805SM-18, 7805SM-19, 7805SM-21, 7805SM-22, 7805SM-24		
8154-1/2		
8159-1/2, 8160-1/2		
8166-1/2		
8150SL		
6700SM-4.5, 6700SM-5, 6700SM-5.5, 6700SM-6, 6700SM-7, 6700SM-8, 6700SM-9, 6700SM-10, 6700SM-11, 6700SM-12, 6700SM-13, 6700SM-4		
6954		
6960, 6962		
6966		
6950SL		
2953-250		

FF1A2501-83 pcs



**FF1A2501**

50 x 543 x 445 mm 1 FF1A2501

6700SM-8, 6700SM-7, 6700SM-6, 6700SM-5.5, 6700SM-12, 6700SM-11, 6700SM-10, 6700SM-9, 6700SM-13, 6700SM-5, 6700SM-4		
6700TORX-E10, 6700TORX-E8		
6709M-5, 6709M-4, 6709M-3, 6709M-8, 6709M-6		
6709TORX-T40, 6709TORX-T30, 6709TORX-T27, 6709TORX-T8, 6709TORX-T25, 6709TORX-T20, 6709TORX-T15, 6709TORX-T10		
6950SL		
6954		
6956		
6962		
6966		
7400SM-8, 7400SM-12, 7400SM-11, 7400SM-10, 7400SM-9, 7400SM-22, 7400SM-21, 7400SM-16, 7400SM-15, 7400SM-14, 7400SM-13, 7400SM-20, 7400SM-19, 7400SM-18, 7400SM-17		
7400TORX-E10, 7400TORX-E8, 7400TORX-E14, 7400TORX-E12		
7750SL		
7754		
7762		
7764		
7765		
7766		
7768		
7800SM-17, 7800SM-13, 7800SM-12, 7800SM-19, 7800SM-18, 7800SM-27, 7800SM-20, 7800SM-32, 7800SM-30		
7809M-10		
7800SM-21		
7809M-12		
7800SM-22		
7809TORX-T40, 7809TORX-T55, 7809TORX-T25, 7809TORX-T50, 7809TORX-T20		
7800SM-24		
8150SL		
8154-1/2		
8162-1/2		
8164-1/2		
8165-1/2		
8166-1/2		
8964		

Douille 1/2"-3/8", 101 pcs



**FF1A2503**

55 x 543 x 445 mm 1 FF1A2503

6700SM-4.5, 6700SM-5, 6700SM-5.5, 6700SM-6, 6700SM-7, 6700SM-8, 6700SM-9, 6700SM-10, 6700SM-11, 6700SM-12, 6700SM-13, 6700SM-14, 6700SM-4		
7800SM-18, 7800SM-19, 7800SM-21, 7800SM-22, 7800SM-23, 7800SM-24, 7800SM-26		
BE-9678		
7800SM-27, 7800SM-28, 7800SM-30, 7800SM-32, 7800SM-10, 7800SM-11, 7800SM-12, 7800SM-13, 7800SM-14, 7800SM-15, 7800SM-16, 7800SM-17, 7800SM-8, 7800SM-9		
7809M-10		
59S/31-1		
7809M-10-140		
7809M-12, 7809M-14, 7809M-17, 7809M-19, 7809M-5, 7809M-7, 7809M-8, 7809M-9, 7809M-6		
7809M-5-180, 7809M-6-140, 7809M-7-100, 7809M-8-120		
808050		
8154-1/2		
8155-1/2		
8160-1/2, 8162-1/2		
8166-1/2		
6950		
6954		
6956		
6960, 6962		
6966		



FF1A37, 46 pcs



**FF1A37**

35 x 543 x 445 mm 1 FF1A37

111M-6, 111M-7, 111M-8, 111M-9, 111M-10, 111M-11, 111M-12, 111M-13, 111M-14, 111M-15, 111M-16, 111M-17, 111M-18, 111M-19, 111M-21, 111M-22, 111M-24		
8071 IP		
2101G-160		
2430 G-160		
8224		
8150SL		

FF1A39, 54 pcs



**FF1A39**

45 x 543 x 445 mm 1 FF1A39

S410	
S1612L	
8071 IP	

FF1A5003-91 pcs



**FF1A5003**

45 x 543 x 445 mm 1 FF1A5003

111M-13, 111M-12, 111M-10, 111M-8, 111M-19, 111M-17, 111M-15		
--	--	--

6700SM-5.5, 6700SM-5, 6700SM-14, 6700SM-13, 6700SM-12, 6700SM-11, 6700SM-10, 6700SM-9, 6700SM-8, 6700SM-7, 6700SM-6		
---	--	--

6700TORX-E5, 6700TORX-E4, 6700TORX-E10, 6700TORX-E8, 6700TORX-E7, 6700TORX-E6		
---	--	--

6709TORX-T27, 6709TORX-T25, 6709TORX-T20, 6709TORX-T15, 6709TORX-T10, 6709TORX-T9, 6709TORX-T8, 6709TORX-T40, 6709TORX-T30		
--	--	--

6950	
------	--

6961, 6962	
------------	--

6966	
------	--

7400SM-13, 7400SM-12, 7400SM-11, 7400SM-10, 7400SM-9, 7400SM-8, 7400SM-21, 7400SM-19, 7400SM-18, 7400SM-17, 7400SM-16, 7400SM-15, 7400SM-14, 7400SM-22		
--	--	--

7400TORX-E18, 7400TORX-E16, 7400TORX-E14, 7400TORX-E12, 7400TORX-E11, 7400TORX-E10, 7400TORX-E8		
---	--	--

7409TORX-T30, 7409TORX-T27, 7409TORX-T25, 7409TORX-T50, 7409TORX-T45, 7409TORX-T40		
--	--	--

7750	
------	--

7760, 7761, 7762	
------------------	--

7764	
------	--

7765	
------	--

7766	
------	--

8158-1/2	
----------	--

A6800DM-8, A6800DM-7, A6800DM-6, A6800DM-14, A6800DM-13, A6800DM-12, A6800DM-11, A6800DM-10, A6800DM-9		
--	--	--

A7402DM-19, A7402DM-18, A7402DM-17, A7402DM-16, A7402DM-15, A7402DM-14, A7402DM-13, A7402DM-12, A7402DM-11, A7402DM-10		
--	--	--

FF1A5004-37 pcs



**FF1A5004**

55 x 543 x 445 mm 1 FF1A5004

1RM-19, 1RM-13, 1RM-12, 1RM-11, 1RM-10, 1RM-9, 1RM-8, 1RM-27, 1RM-7, 1RM-24, 1RM-6, 1RM-22, 1RM-17		
--	--	--

6700SM-13, 6700SM-12, 6700SM-11, 6700SM-10, 6700SM-9, 6700SM-8, 6700SM-7, 6700SM-6		
--	--	--

6950	
------	--

6960	
------	--

6966	
------	--

7800SM-19, 7800SM-17, 7800SM-32, 7800SM-30, 7800SM-13, 7800SM-27, 7800SM-24, 7800SM-22		
--	--	--

8155-1/2	
----------	--

8160-1/2	
----------	--

8166-1/2	
----------	--

SBS64	
-------	--

SBS86	
-------	--

FF1A5005-83 pcs



**FF1A5005**

50 x 543 x 445 mm 1 FF1A5005

111M-17, 111M-15, 111M-13, 111M-19, 111M-8		
--	--	--

6700SM-8, 6700SM-7, 6700SM-6, 6700SM-12, 6700SM-11, 6700SM-10, 6700SM-9, 6700SM-14, 6700SM-13, 6700SM-5, 6700SM-4		
---	--	--

6709M-5, 6709M-4, 6709M-8, 6709M-6		
------------------------------------	--	--

6950SL	
--------	--

6960-W	
--------	--

6962	
------	--

6962-W	
--------	--

6968	
------	--

7400SM-8, 7400SM-7, 7400SM-6, 7400SM-12, 7400SM-11, 7400SM-10, 7400SM-9, 7400SM-16, 7400SM-15, 7400SM-14, 7400SM-13, 7400SM-18, 7400SM-17		
---	--	--

7750SL	
--------	--

7760-W	
--------	--

7761	
------	--

7768	
------	--

7800SM-11, 7800SM-10, 7800SM-15, 7800SM-14, 7800SM-13, 7800SM-12, 7800SM-19, 7800SM-18, 7800SM-17, 7800SM-16, 7800SM-22, 7800SM-21, 7800SM-27, 7800SM-24, 7800SM-32, 7800SM-30, 7800SM-8, 7800SM-9		
--	--	--

7809M-17, 7809M-14, 7809M-12, 7809M-10, 7809M-5, 7809M-6, 7809M-7, 7809M-8		
--	--	--

7809TORX-T40, 7809TORX-T30, 7809TORX-T25, 7809TORX-T20, 7809TORX-T45		
--	--	--

8150SL	
--------	--

8160-1/2, 8162-1/2	
--------------------	--

8166-1/2	
----------	--

A6709M-6, A6709M-5, A6709M-4, A6709M-3, A6709M-2.5		
--	--	--

K6650-1/4-1P	
--------------	--

6709M-3		
---------	--	--

FF1A5013-41 pcs



**FF1A5013**



50 x 543 x 445 mm



1 FF1A5013

111M-6, 111M-7, 111M-8, 111M-9,  
111M-12, 111M-13, 111M-17, 111M-10,  
111M-11, 111M-19, 111M-20, 111M-22,  
111M-24, 111M-27, 111M-32, 111M-30

6700SM-6, 6700SM-7, 6700SM-8,  
6700SM-9, 6700SM-10, 6700SM-11,  
6700SM-12, 6700SM-13, 6700SM-14

6950

6960

6966

7800SM-19, 7800SM-17, 7800SM-13,  
7800SM-22, 7800SM-27, 7800SM-24,  
7800SM-30, 7800SM-32

8155-1/2

8160-1/2

8166-1/2

SBS64

SBS86

FF1A5032, 76 pcs



**FF1A5032**



55 x 543 x 445 mm



1 FF1A5032

6700SM-10, 6700SM-11, 6700SM-8,  
6700SM-9, 6700SM-14, 6700SM-12,  
6700SM-13, 6700SM-4, 6700SM-6,  
6700SM-7, 6700SM-5, 6700SM-4.5,  
6700SM-5.5

6950

6954

6956

6960, 6962

6966

7400SM-6, 7400SM-7, 7400SM-10,  
7400SM-11, 7400SM-8, 7400SM-9,  
7400SM-14, 7400SM-15, 7400SM-12,  
7400SM-13, 7400SM-18, 7400SM-19,  
7400SM-16, 7400SM-17, 7400SM-22,  
7400SM-20, 7400SM-21

7754

7755-3/8

7760, 7761, 7762

7766

7800DM-11, 7800DM-14, 7800DM-15,  
7800DM-12, 7800DM-13, 7800DM-18,  
7800DM-19, 7800DM-16, 7800DM-17,  
7800DM-22, 7800DM-23, 7800DM-20,  
7800DM-21, 7800DM-26, 7800DM-27,  
7800DM-24, 7800DM-30, 7800DM-32,  
7800DM-28, 7800DM-8, 7800DM-9

8154-1/2

8155-1/2

8160-1/2, 8162-1/2

8166-1/2

111M-19, 111M-17, 111M-18, 111M-15,  
111M-16, 111M-14, 111M-20

7800DM-10

FF1A55, 75 pcs



**FF1A55**



40 x 543 x 445 mm



1 FF1A55

A6700DZ-1/2, A6700DZ-1/4,  
A6700DZ-11/32, A6700DZ-3/16,  
A6700DZ-3/8, A6700DZ-5/16,  
A6700DZ-7/16, A6700DZ-7/32,  
A6700DZ-9/16, A6700DZ-9/32

BE-9775

SBS61

SBS63-2, SBS63-6, SBS63-4

SBS64

SBS65

SBS67

SBS81

SBS83-10, SBS83-5

SBS85

SBS86

6956

6972H

7800DZ-1, 7800DZ-1/2, 7800DZ-11/16,  
7800DZ-13/16, 7800DZ-15/16, 7800DZ-  
19/32, 7800DZ-3/4, 7800DZ-3/8,  
7800DZ-5/8, 7800DZ-7/8, 7800DZ-9/16

808050

7800DZ-7/16

FF1A59, 105 pcs

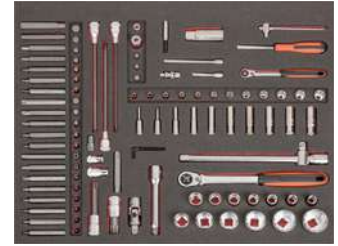

**FF1A59**



35 x 543 x 445 mm



1 FF1A59

S560

BE5049

FF1A70-105 pcs



**FF1A70**



42 x 543 x 445 mm



1 FF1A70

BE5049

S560

FF1A54-75 pcs



**FF1A54**



35 x 543 x 445 mm



1 FF1A54

S1612L

S0810L

S330L



FF1A153, 94 pièces



**FF1A153**



335 x 445 x 543 mm



1 FF1A153

S87+7

FF1A165, 177 pcs



**FF1A165**



40 x 543 x 445 mm



1 FF1A165

BE5049



S1214L



S1612L



SBS71-16



SBS87



139 pièces



**FF1A195LM**



40 x 445 x 543 mm



1 FF1A195LM

A6800DZ-9/16, A6800DZ-1/2,  
A6800DZ-1/4, A6800DZ-11/32,  
A6800DZ-3/16, A6800DZ-3/8,  
A6800DZ-5/16, A6800DZ-7/16,  
A6800DZ-7/32, A6800DZ-9/32



K6625-1/4-1P



K6650-1/4-1P



6954



6963



K6650-3/8-1P



7767



8167



59/S31B



SL25L



S330L



51 pièces



**FF1A194**



40 x 543 x 445 mm



1 FF1A194

6968



6700SM-14, 6700SM-13, 6700SM-12,  
6700SM-11, 6700SM-10, 6700SM-9,  
6700SM-8, 6700SM-7, 6700SM-6,  
6700SM-5, 6700SM-4



6709M-3, 6709M-8, 6709M-6, 6709M-5,  
6709M-4



6950SL



6960-W, 6962-W



7800SM-24, 7800SM-23, 7800SM-22,  
7800SM-13, 7800SM-12, 7800SM-11,  
7800SM-10, 7800SM-9, 7800SM-8,  
7800SM-21, 7800SM-19, 7800SM-18,  
7800SM-17, 7800SM-16, 7800SM-15,  
7800SM-14



7809M-8, 7809M-7, 7809M-10, 7809M-5,  
7809M-6



7809TORX-T20, 7809TORX-T25,  
7809TORX-T30, 7809TORX-T40



7455-200



8150SL



8160-1/2, 8162-1/2



8168



K6650-1/4-1P



67 pièces



**FF1A196LM**



40 x 445 x 543 mm



1 FF1A196LM

7800DZ-1.1/16, 7800DZ-1.1/4, 7800DZ-1.1/8, 7800DZ-1.3/16, 7800DZ-1/2, 7800DZ-11/16, 7800DZ-13/16, 7800DZ-15/16, 7800DZ-25/32, 7800DZ-3/4, 7800DZ-3/8, 7800DZ-5/8, 7800DZ-7/16, 7800DZ-7/8, 7800DZ-9/16, 7800DZ-19/32



7809M-10, 7809M-12, 7809M-14, 7809M-4, 7809M-5, 7809M-6, 7809M-7, 7809M-8



7809M-5-100, 7809M-6-100, 7809M-7-100, 7809M-8-120, 7809M-10-140



K6650-1/2-1P



S240



S1612L



8967



17 pièces



**FF1A206LM**



50 x 445 x 543 mm



1 FF1A206LM

SLX 17























192 pièces



**FF1A207LM**

 40 x 445 x 543 mm   1 FF1A207LM





1150-1/2H/P	
59/S100BC	
808050L	
K6650-1/4-1P	
6956	
6963	
K6650-3/8-1P	
8967/S3	
6966	
6954	
696EX-08	
904T-060-150	
905T-060-100	
6973A	
SL25L	
S330	





















85 pièces



**FF1A213**

 52 x 445 x 543 mm   1 FF1A213

8150SL	
8160-1/2, 8162-1/2	
7800SM-8, 7800SM-9, 7800SM-12, 7800SM-13, 7800SM-10, 7800SM-11, 7800SM-30, 7800SM-32, 7800SM-24, 7800SM-22, 7800SM-23, 7800SM-27, 7800SM-16, 7800SM-17, 7800SM-14, 7800SM-15, 7800SM-21, 7800SM-18, 7800SM-19	
7455-200	











8166-1/2	
7809TORX-T45, 7809TORX-T40, 7809TORX-T30, 7809TORX-T20, 7809TORX-T25	
7809M-6	
7809M-6-140	
7809M-5	
7809M-5-180	
7809M-8, 7809M-7, 7809M-10	
7809M-10-140, 7809M-8-120	
7809M-14, 7809M-12	
6950SL	
6962-W, 6960-W	
6968	
6700SM-9, 6700SM-10, 6700SM-7, 6700SM-8, 6700SM-13, 6700SM-14, 6700SM-11, 6700SM-12, 6700SM-4, 6700SM-6, 6700SM-5	
6709M-6, 6709M-8, 6709M-4, 6709M-5, 6709M-3	
A6709M-2.5, A6709M-5, A6709M-6, A6709M-3, A6709M-4	
6962L	
K6650-1/4-1P	
7400SM-17, 7400SM-18, 7400SM-15, 7400SM-16, 7400SM-19, 7400SM-9, 7400SM-10, 7400SM-7, 7400SM-8, 7400SM-13, 7400SM-14, 7400SM-11, 7400SM-12, 7400SM-6	
7760-W, 7761-W	
7750SL	
7768	

91 pièces



**FF1A214LM**



 40 x 445 x 543 mm   1 FF1A214LM











K6650-1/4-1P	
6956	
6963	
K6650-1/2-1P	
SL25	
S240	
8072	
2971G-250	
806-1-3	
2171G-160	
59/S31B	

79 pièces



**FF1A218LM**

 45 x 445 x 543 mm   1 FF1A218LM





1178-SCRIBE	
1547	
74WR-200	
7805ZZ-16, 7805ZZ-21	
BBR201P64014, BBR201P64016, BBR201P64018, BBR201P67814, BBR201P67816, BBR201P67818	
BWSS12P3	
MTC-3-13-C1	
S240	
7800SM-34, 7800SM-36	
SL25L	
SR200-MM	

49 pièces



**FF1A219LM**

 35 x 445 x 543 mm   1 FF1A219LM

1-100-08-2-2	
S1612L	
S18HEX	
S18TORX	





160 pièces



**FF1A229**

 50 x 445 x 543 mm  1 FF1A229



6950RN	
8150RN-1/2	
59/S100BC	

FF1A1004 - 19 PCS



**FF1A1004**

 38 x 543 x 445 mm  1 FF1A1004







900T-050-150, 900T-020-100, 900T-025-100, 900T-030-100, 900T-040-150, 900T-060-200, 900T-080-200, 900T-100-200	
BE-9777B	

Module 3/3, Tournevis poignée en T, 54 pcs



**FF1A1010**

 51 x 543 x 445 mm  1 FF1A1010

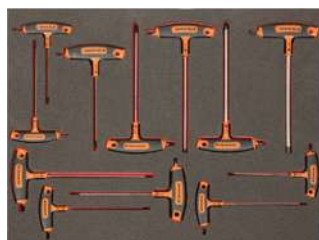

901T-010-100, 901T-015-150, 901T-020-150, 901T-025-150, 901T-027-150, 901T-030-200, 901T-040-200	
808050	
1419-MD	
7805DM-10	
BE-9678	
7805DM-12, 7805DM-13, 7805DM-17, 7805DM-19	
59S/31-1	

FF1A1011-12 pcs



**FF1A1011**

 35 x 543 x 445 mm  1 FF1A1011



903T-2	
903T-1	

Tournevis, 17 pcs



**FF1A133**

 35 x 543 x 445 mm  1 FF1A133









900T-020-100, 900T-025-100, 900T-030-100, 900T-040-150, 900T-050-150, 900T-060-200, 900T-080-200, 900T-100-200	
B194.006.075, B194.007.075, B194.008.075, B194.009.075, B194.010.075, B194.015.100, B194.020.100, B194.025.125, B194.030.150	

Tournevis, 18 pcs



**FF1A139**

 38 x 543 x 445 mm  1 FF1A139







808050	
900T-020-100, 900T-025-100, 900T-030-100, 900T-040-150, 900T-050-150, 900T-060-200, 900T-080-200, 900T-100-200	
B191.030.075, B191.040.100	
B190.055.100	
B195.050.025	
B190.065.125, B190.080.150	
B195.001.025	
B192.001.100, B192.002.125	

FF1A71-46 pcs

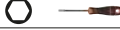

**FF1A71**

 41 x 543 x 445 mm  1 FF1A71

901T-010-100, 901T-015-150, 901T-020-150, 901T-027-150, 901T-030-200, 901T-040-200, 901T-025-150, 901T-045-200, 901T-050-200	
B190.055.125	
B191.030.075, B191.040.100	
B192.001.100	
B705.1/4.125	
B192.002.125	

39 pièces



**FF1A202LM**

40 x 445 x 543 mm 1 FF1A202LM

- 900T-025-100, 900T-030-100, 900T-040-150, 900T-050-150, 900T-060-200, 900T-080-200
- BE-8910, BE-8915, BE-8920, BE-8925, BE-8930
- BE-8020
- BE-8050SL
- BE-8040
- BE-8150, BE-8155
- BE-8355
- BE-9787
- BE-9770
- BE-9785

114 pièces



**FF1A203LM**

40 x 445 x 543 mm 1 FF1A203LM

- 59/S100BC
- 808050L
- 901T-010-100, 901T-015-150, 901T-020-150, 901T-025-150, 901T-027-150, 901T-030-200, 901T-040-200

35 pièces



**FF1A211LM**

40 x 445 x 543 mm 1 FF1A211LM

- 900T-025-100, 900T-030-100, 900T-040-150, 900T-050-150, 900T-060-200, 900T-080-200
- BE-8910, BE-8915, BE-8920, BE-8925, BE-8930
- BE-8020
- BE-8050SL
- BE-8040
- BE-8150, BE-8155
- BE-8355
- BE-9787
- BE-9770

FF1A02 - 25 pcs



**FF1A02**

45 x 543 x 445 mm 1 FF1A02

- 111M-12, 111M-13, 111M-14, 111M-17, 111M-19, 111M-22, 111M-6, 111M-7, 111M-8, 111M-10
- 6M-6-7, 6M-8-9
- 808050L
- 6M-10-11, 6M-12-13, 6M-14-15, 6M-16-17, 6M-18-19, 6M-20-22

FF1A04 - 30 PCS



**FF1A04**

50 x 543 x 445 mm 1 FF1A04

- S4RM-12-15, S4RM-16-19, S4RM-8-11
- 111M-30, 111M-32, 111M-6, 111M-7, 111M-8, 111M-9, 111M-10, 111M-11, 111M-12, 111M-13, 111M-14, 111M-15, 111M-16, 111M-17, 111M-18, 111M-19, 111M-21, 111M-22, 111M-24, 111M-27
- 6M-10-11, 6M-12-13, 6M-14-15, 6M-17-19, 6M-6-7, 6M-8-9
- 9071C

FF1A09 - 34 PCS



**FF1A09**

50 x 543 x 445 mm 1 FF1A09

- 111M-30, 111M-32, 111M-6, 111M-7, 111M-8, 111M-9, 111M-10, 111M-11, 111M-12, 111M-13, 111M-14, 111M-15, 111M-16, 111M-17, 111M-18, 111M-19, 111M-21, 111M-22, 111M-24, 111M-27
- 1320RM-10-11, 1320RM-12-13, 1320RM-8-9
- 6M-6-7, 6M-8-9, 6M-10-11, 6M-12-13, 6M-14-15, 6M-16-17, 6M-18-19, 6M-20-22, 6M-24-27, 6M-30-32
- 9071C

Clés et embouts, 19 pcs



**FF1A104**

35 x 543 x 445 mm 1 FF1A104

- 111M-32, 111M-7, 111M-8, 111M-9, 111M-10, 111M-11, 111M-12, 111M-13, 111M-14, 111M-15, 111M-16, 111M-17, 111M-18, 111M-19, 111M-21, 111M-22, 111M-24, 111M-27
- 59/S54BC



## Clés et clés à molette, 22 pcs



### FF1A112



35 x 543 x 445 mm



1 FF1A112

#### S4RM/3T

111M-6, 111M-7, 111M-8, 111M-9,  
111M-10, 111M-11, 111M-12, 111M-13,  
111M-14, 111M-15, 111M-16, 111M-17,  
111M-18, 111M-19, 111M-20, 111M-21,  
111M-22, 111M-24, 111M-27

9031

9070

## Clés mixtes, 21 pcs



### FF1A134



37 x 543 x 445 mm



1 FF1A134

111M-30, 111M-32, 111M-6, 111M-7,  
111M-8, 111M-9, 111M-10, 111M-11,  
111M-12, 111M-13, 111M-14, 111M-15,  
111M-16, 111M-17, 111M-18, 111M-19,  
111M-20, 111M-21, 111M-22, 111M-24,  
111M-27

## Clés à fourche et clés à tête flexible, 51 pcs



### FF1A135



40 x 543 x 445 mm



1 FF1A135

4040M-8-9, 4040M-10-11, 4040M-12-13,  
4040M-14-15

59S/31-1

4040M-16-17, 4040M-18-19, 4040M-20-22,  
4040M-21-23

6M-6-7, 6M-8-9, 6M-10-11, 6M-12-13,  
6M-14-15, 6M-16-17, 6M-18-19, 6M-20-22,  
6M-21-23, 6M-24-27, 6M-25-28,  
6M-30-32

## FF1A14-43 pcs



### FF1A14



46 x 543 x 445 mm



1 FF1A14

111Z-1, 111Z-1/2, 111Z-1/4, 111Z-11/16,  
111Z-13/16, 111Z-15/16, 111Z-3/4,  
111Z-3/8, 111Z-5/16, 111Z-5/8, 111Z-7/16,  
111Z-7/8, 111Z-9/16

1320RZ-1/2-9/16, 1320RZ-1/4-5/16,  
1320RZ-3/8-7/16

1931Z-1/2, 1931Z-1/4, 1931Z-11/32,  
1931Z-3/16, 1931Z-3/8, 1931Z-5/16,  
1931Z-5/32, 1931Z-7/16, 1931Z-7/32,  
1931Z-9/16, 1931Z-9/32

1950MZ-3/8

1952Z-11/32

6Z-1.1/16-1.1/4, 6Z-1-1.1/8, 6Z-1/2-9/16,  
6Z-1/4-5/16, 6Z-15/16-1, 6Z-19/32-11/16,  
6Z-25/32-13/16, 6Z-3/8-7/16,  
6Z-5/16-11/32, 6Z-5/8-3/4, 6Z-7/8-15/16

8069 C IP

9070C

## FF1A19-33 pcs



### FF1A19



50 x 543 x 445 mm



1 FF1A19

111M-30, 111M-32, 111M-6, 111M-7,  
111M-8, 111M-9, 111M-10, 111M-11,  
111M-12, 111M-13, 111M-14, 111M-15,  
111M-16, 111M-17, 111M-18, 111M-19,  
111M-20, 111M-21, 111M-22, 111M-24,  
111M-27

6M-6-7, 6M-8-9, 6M-10-11, 6M-12-13,  
6M-14-15, 6M-16-17, 6M-18-19, 6M-20-22,  
6M-21-23, 6M-24-27, 6M-30-32

92C

## FF1A20-18 pcs



### FF1A20



50 x 543 x 445 mm



1 FF1A20

2M-6-7, 2M-8-9, 2M-10-11, 2M-12-13,  
2M-14-15, 2M-16-17, 2M-18-19, 2M-20-22,  
2M-21-23, 2M-24-27, 2M-30-32

4040M-10-11, 4040M-12-13, 4040M-14-15,  
4040M-16-17, 4040M-18-19,  
4040M-21-23

2953-250

## FF1A3001-21 pcs



### FF1A3001



40 x 543 x 445 mm



1 FF1A3001

111M-32, 111M-30, 111M-24, 111M-22,  
111M-27, 111M-17, 111M-16, 111M-15,  
111M-14, 111M-21, 111M-20, 111M-19,  
111M-18, 111M-9, 111M-8, 111M-7,  
111M-6, 111M-13, 111M-12, 111M-11,  
111M-10

FF1A3002-7 pcs



**FF1A3002**

 35 x 543 x 445 mm   1 FF1A3002

111M-24, 111M-22, 111M-17, 111M-16, 111M-15, 111M-14, 111M-21, 111M-20, 111M-19, 111M-18, 111M-9, 111M-8, 111M-7, 111M-6, 111M-13, 111M-12, 111M-11, 111M-10  
1RM-19, 1RM-10, 1RM-9, 1RM-8, 1RM-14, 1RM-13, 1RM-12, 1RM-11, 1RM-18, 1RM-17, 1RM-16, 1RM-15

FF1A3003-28 pcs



**FF1A3003**

 40 x 543 x 445 mm   1 FF1A3003

1952M-27, 1952M-21, 1952M-20, 1952M-19, 1952M-18, 1952M-24, 1952M-22, 1952M-13, 1952M-12, 1952M-11, 1952M-10, 1952M-17, 1952M-16, 1952M-15, 1952M-14, 1952M-9, 1952M-8, 1952M-7, 1952M-6

BE-9778

FF1A3004-30 pcs



**FF1A3004**

 48 x 543 x 445 mm   1 FF1A3004

111M-24, 111M-22, 111M-17, 111M-16, 111M-15, 111M-14, 111M-21, 111M-20, 111M-19, 111M-18, 111M-9, 111M-8, 111M-7, 111M-6, 111M-13, 111M-12, 111M-11, 111M-10

1RM-19, 1RM-10, 1RM-9, 1RM-8, 1RM-14, 1RM-13, 1RM-12, 1RM-11, 1RM-18, 1RM-17, 1RM-16, 1RM-15

FF1A3005-28 pcs



**FF1A3005**

 38 x 543 x 445 mm   1 FF1A3005

1952M-19, 1952M-18, 1952M-22, 1952M-13, 1952M-12, 1952M-11, 1952M-10, 1952M-17, 1952M-16, 1952M-15, 1952M-14, 1952M-9, 1952M-8, 1952M-7, 1952M-6

1RM-6, 1RM-10, 1RM-9, 1RM-8, 1RM-7, 1RM-24, 1RM-22, 1RM-19, 1RM-14, 1RM-13, 1RM-12, 1RM-11, 1RM-17

FF1A5002-27 pcs



**FF1A5002**

 50 x 543 x 445 mm   1 FF1A5002

111M-30, 111M-32, 111M-6, 111M-7, 111M-8, 111M-9, 111M-10, 111M-11, 111M-12, 111M-13, 111M-14, 111M-15, 111M-16, 111M-17, 111M-18, 111M-19, 111M-20, 111M-21, 111M-22, 111M-24, 111M-27

3734S/6

FF1A5006-27 pcs



**FF1A5006**

 54 x 543 x 445 mm   1 FF1A5006

1-100-08-2-2

1-210-08-2-2

1-230-06-2-2

111M-7, 111M-8, 111M-9, 111M-10, 111M-11, 111M-12, 111M-13, 111M-14, 111M-15, 111M-16, 111M-17, 111M-18, 111M-19, 111M-21, 111M-22

1320RM-6-7, 1320RM-8-9, 1320RM-10-11, 1320RM-12-13, 1320RM-14-15, 1320RM-16-17, 1320RM-18-19, 1320RM-22-24

1-230-10-2-2

FF1A5027, 36 pcs



**FF1A5027**

 44 x 543 x 445 mm   1 FF1A5027

2M-20-22, 2M-21-23, 2M-24-27, 2M-25-28, 2M-30-32

4040M-10-11, 4040M-12-13, 4040M-14-15, 4040M-16-17, 4040M-18-19, 4040M-20-22, 4040M-21-23, 4040M-8-9

7400SM-6, 7400SM-7, 7400SM-12, 7400SM-13, 7400SM-14, 7400SM-15, 7400SM-8, 7400SM-9, 7400SM-10, 7400SM-11, 7400SM-20, 7400SM-21, 7400SM-22, 7400SM-16, 7400SM-17, 7400SM-18, 7400SM-19

7754

7755-3/8

7760, 7761, 7762

7766



FF1A56, 28 pcs



**FF1A56**

63 x 543 x 445 mm 1 FF1A56

111Z-1, 111Z-1/2, 111Z-1/4, 111Z-11/16, 111Z-13/16, 111Z-15/16, 111Z-3/4, 111Z-3/8, 111Z-5/16, 111Z-5/8, 111Z-7/16, 111Z-7/8, 111Z-9/16

1320RZ-1/2-9/16, 1320RZ-1/4-5/16, 1320RZ-3/8-7/16

6Z-1.1/16-1.1/4, 6Z-1-1.1/8, 6Z-1/2-9/16, 6Z-1/4-5/16, 6Z-15/16-1, 6Z-19/32-11/16, 6Z-25/32-13/16, 6Z-5/16-11/32, 6Z-5/8-3/4, 6Z-7/8-15/16

9031

FF1A65-28 pcs



**FF1A65**

50 x 543 x 445 mm 1 FF1A65

111M-19, 111M-17, 111M-18, 111M-24, 111M-21, 111M-22, 111M-7, 111M-8, 111M-6, 111M-11, 111M-12, 111M-9, 111M-10, 111M-15, 111M-16, 111M-13, 111M-14, 111M-20

1RM-8, 1RM-9, 1RM-12, 1RM-13, 1RM-10, 1RM-11, 1RM-17, 1RM-14, 1RM-19

319

23 pièces



**FF1A198LM**

35 x 445 x 543 mm 1 FF1A198LM

111M-10, 111M-11, 111M-12, 111M-13, 111M-14, 111M-15, 111M-16, 111M-17, 111M-18, 111M-19, 111M-20, 111M-21, 111M-22, 111M-24, 111M-27, 111M-30, 111M-32, 111M-34, 111M-8, 111M-9

23 pièces



**FF1A199LM**

35 x 445 x 543 mm 1 FF1A199LM

1RM-10, 1RM-11, 1RM-12, 1RM-13, 1RM-14, 1RM-15, 1RM-16, 1RM-17, 1RM-18, 1RM-19, 1RM-21, 1RM-22, 1RM-24, 1RM-8, 1RM-9

4040M-10-11, 4040M-12-13, 4040M-14-15, 4040M-16-17, 4040M-18-19, 4040M-8-9

9029, 9031

21 pièces



**FF1A209LM**

35 x 445 x 543 mm 1 FF1A209LM

111M-10, 111M-11, 111M-12, 111M-13, 111M-14, 111M-15, 111M-16, 111M-17, 111M-18, 111M-19, 111M-20, 111M-21, 111M-22, 111M-24, 111M-27, 111M-30, 111M-32, 111M-34, 111M-8, 111M-9

2535L

21 pièces



**FF1A220LM**

35 x 445 x 543 mm 1 FF1A220LM

111M-10, 111M-11, 111M-12, 111M-13, 111M-14, 111M-15, 111M-16, 111M-17, 111M-18, 111M-19, 111M-20, 111M-21, 111M-22, 111M-23, 111M-24, 111M-27, 111M-30, 111M-32, 111M-8, 111M-9

8071

Clés, 31 pièces



**FF1A48**

44 x 543 x 445 mm 1 FF1A48

1RM-6, 1RM-7, 1RM-8, 1RM-9, 1RM-10, 1RM-11, 1RM-12, 1RM-13, 1RM-14, 1RM-17, 1RM-19, 1RM-22, 1RM-24, 1RM-27

111M-6, 111M-7, 111M-8, 111M-9, 111M-10, 111M-11, 111M-12, 111M-13, 111M-14, 111M-15, 111M-16, 111M-17, 111M-18, 111M-19, 111M-20, 111M-21, 111M-22

FF1A170- 14 pcs



**FF1A170**

40 x 543 x 445 mm 1 FF1A170

28M-16, 28M-15, 28M-18, 28M-17, 28M-12, 28M-11, 28M-14, 28M-13, 28M-24, 28M-19, 28M-22, 28M-8, 28M-10, 28M-9

Clés mixtes et pinces, 24 pcs



**FF1A102**

40 x 543 x 445 mm 1 FF1A102

111M-32, 111M-8, 111M-9, 111M-10, 111M-11, 111M-12, 111M-13, 111M-14, 111M-15, 111M-16, 111M-17, 111M-18, 111M-19, 111M-21, 111M-22, 111M-24, 111M-27  
7224  
2800-180  
2900-180  
2890-180  
2990-180  
2101G-180  
2628 G-180IP

FF1A11-13 pcs



**FF1A11**

43 x 543 x 445 mm 1 FF1A11

2101GC-125IP, 2101GC-160IP  
21HDGC-200IP  
2427 GC-200IP  
2430 GC-200 IP  
2628 GC-160IP  
2928-160, 2928-200, 2928-250  
2951-250  
2952-165  
8224CIP

Pincas et Limes, 14 pcs



**FF1A118**

35 x 543 x 445 mm 1 FF1A118

1-100-08-2-2  
2430 G-160 IP  
2628G-200IP  
2800-180  
2900-180  
2890-180  
2990-180  
5515T  
1-170-08-2-2  
1-210-08-2-2  
1-230-08-2-2  
2535F1  
8224 IP  
2101G-180IP

Pincas et clés à tête flexible, 47 pcs



**FF1A141**

42 x 543 x 445 mm 1 FF1A141

2628 G-180  
2430 G-160  
8224  
2101G-160  
2800-180  
2890-180  
2900-180  
2990-180  
4040M-8-9, 4040M-10-11, 4040M-12-13, 4040M-14-15, 4040M-16-17, 4040M-18-19, 4040M-20-22  
59S/31-1  
4040M-21-23

Pincas et limes, 20 pcs



**FF1A145**

38 x 543 x 445 mm 1 FF1A145

2628 G-180  
2430 G-160  
8224  
2101G-160  
8045LVDE  
808050  
613-3-75  
611-4-100, 611-5.5-100, 611-6.5-150, 611-8-150  
615-1-100, 615-2-125  
611-6.5-25  
615-2-25  
1-100-08-1-2  
1-160-08-1-2  
1-170-08-2-2  
1-210-08-1-2  
1-230-08-1-2















FF1A15-12 pcs



**FF1A15**

 40 x 543 x 445 mm   1 FF1A15











2101GC-125IP, 2101GC-160IP	
2233D-240IP	
2421GC-180IP	
2427 GC-200IP	
2430 GC-200 IP	
2628 GC-160IP	
2650	 
2855, 2855 D	 
2951-180	
8224CIP	 

FF1A4001-12 pcs



**FF1A4001**



 38 x 543 x 445 mm   1 FF1A4001













1520 D	
2101G-160IP	
21HDG-200IP	
2223 G-150	
2421 G-140IP, 2421 G-180 IP	
2427 G-200 IP	
2628 G-180IP	
2681	
2951-140, 2951-300	
8224 IP	 

FF1A4002-11 pcs



**FF1A4002**



 42 x 543 x 445 mm   1 FF1A4002









2101G-160IP	
2430 G-200 IP	
2465D-200	 
2510	
2628 G-160IP	
2744	
2951-140	
2952-165	
1520 G	
527 D-160	
7224	

FF1A4003-12 pcs



**FF1A4003**

 35 x 543 x 445 mm   1 FF1A4003











2800-150, 2800-180, 2800-225	 
2890-140, 2890-180, 2890-210	 
2900-150, 2900-180, 2900-215	 
2990-140, 2990-180, 2990-200	 

FF1A50-13 pcs



**FF1A50**

 45 x 543 x 445 mm   1 FF1A50





















8223 IP, 8224 IP, 8225 IP	 
1420	
2430 G-160 IP	
2427 G-160 IP	
8069	
9070	
9031	
2101G-160IP	
21HDG-180IP	

FF1A51-23 pcs



**FF1A51**

 40 x 543 x 445 mm   1 FF1A51

1-100-08-1-2	 
1-210-08-1-2	 
1-230-08-1-2	 
4-144-08-2-2	 
1-170-08-1-2	 
3735-4-120	
3733-4, 3733-2, 3733-6	
3734-2, 3734-3, 3734-4, 3734-5, 3734-6, 3734-8	
2800-180, 2800-150	 
2890-140, 2890-180	 
2900-150, 2900-180	 
2990-140, 2990-180	 































FF1A68-30 pcs



**FF1A68**

 37 x 543 x 445 mm   1 FF1A68















1-100-08-1-2		
1-170-08-1-2		
1-210-08-1-2		
1-230-08-1-2		
2800-180		
2890-180		
2900-180		
2990-180		
3733-4, 3733-2, 3733-6		
3734-8, 3734-5, 3734-6, 3734-3, 3734-4, 3734-2		
3735-4-120		
4-144-08-2-2		
481-400		
BE-9770		

14 pièces



**FF1A200LM**



 35 x 445 x 543 mm   1 FF1A200LM











1520 G	
1620	
2101G-160	
2223 S-150	 <small>1000 V IEC60666</small>
2233 D-160	
2430 G-190HD	
2628 G-180	
2890-180	
2990-180	
C3330R	
C3530	
C3230	
C3640	
8224	 <b>17</b>

15 pièces



**FF1A223LM**

 35 x 445 x 543 mm   1 FF1A223LM









5226 DC	
158-N	
158-NB	
21HDG-200	
2430 G-190HD	
2628G-200IP	
2968-190	
8224 IP	 <b>17</b>
BE1P	
BE1TH-2.5, BE1TH-3, BE1TH-4, BE1TH-5, BE1TH-6, BE1TH-8	

FF1A03 - 18 PCS



**FF1A03**

 50 x 543 x 445 mm   1 FF1A03















BE-9770	
MTB-5-25	
3734N-4-150, 3734N-6-150	
1-100-08-2-2	
2171G-160	
2971G-250	
481-400	
2678 G-160	
306	

FF1A06 - 23 PCS



**FF1A06**

 45 x 543 x 445 mm   1 FF1A06

BE-8020L, BE-8040	
BE-8150, BE-8255, BE-8256	
BE-8350	
BE-8601	
BE-8610, BE-8620	
BE-8910, BE-8915, BE-8920, BE-8925, BE-8927, BE-8930	
MTB-3-16	
2101G-160IP	
2427 G-200 IP	
2535L	
2628 G-160IP	
2951-180	
5515T-52	
8224 IP	 <b>17</b>















FF1A07 - 15 PCS



**FF1A07**

 40 x 543 x 445 mm   1 FF1A07











3734N-3-150, 3734N-5-150, 3734N-6-150	
3735N-4-120	
3740-175	
SQZ150003	
1-100-08-2-2	
1-210-08-2-2	
1-230-08-2-2	
2744	
3625W-35	
3745-150	
481-400	
782-U	
317	

Outils de frappe et de coupe, 11 pcs



**FF1A110**

 50 x 543 x 445 mm   1 FF1A110













2535L	
426TOR9	
9572-200	
MTB-8-25	
SQZ150003	
3875-LY3	
479-24	
481-400	
529-20-L	
225-PLUS	
208	

Pinces et outils de frappe, 18 pcs



**FF1A114**

 42 x 543 x 445 mm   1 FF1A114









8224 IP	
2632	
3734-2, 3734-3, 3734-4, 3734-5, 3734-6, 3734-8	
2800-180	
2890-180	
2900-180	
2990-180	
4611-2	
479-24	
1435/5	
1178-SCRIBE	
2430 G-160 IP	
2101G-180IP	

Outils de mesure et de coupe, 9 pcs



**FF1A115**

 35 x 543 x 445 mm   1 FF1A115





1-210-08-1-2	
9045-B-250	
406T-225	
MTB-5-25	
K-AP-1	
268	
5515T-52	
319	

Clés, clés à molette et tournevis, 26 pcs



**FF1A117**

 35 x 543 x 445 mm   1 FF1A117











B191.040.100	
B190.055.125, B190.065.150	
B192.000.075, B192.001.100, B192.002.125	
111M-32, 111M-6, 111M-7, 111M-8, 111M-9, 111M-10, 111M-11, 111M-12, 111M-13, 111M-14, 111M-15, 111M-16, 111M-17, 111M-18, 111M-19, 111M-21, 111M-22, 111M-24, 111M-27	
8073 IP	

Outils de frappe et de coupe, 10 pcs



**FF1A119**

 47 x 543 x 445 mm   1 FF1A119

3734S/6	
481-300	
KGAU-01	
MTB-5-25-M-E	
137-10	
1150-1/2H/P	
426TOR9	
BLTS10	
375-8	
319	

FF1A12-19 pcs



**FF1A12**

35 x 543 x 445 mm 1 FF1A12

FS-8	
1-100-06-1-2, 1-100-06-2-2	
1-160-06-1-2	
1-210-06-1-2	
1-230-06-1-2	
2509	
2535F2	
3625W-35	
3734-3, 3734-5, 3734-8	
3735-4-120	
3740-150	
3745-150	
481-300, 481-500	
8158-1/2	
319	

Clés et pinces, 28 pcs



**FF1A121**

40 x 543 x 445 mm 1 FF1A121

111M-8, 111M-9, 111M-10, 111M-11, 111M-12, 111M-13, 111M-14, 111M-15, 111M-16, 111M-17, 111M-18, 111M-19, 111M-22	
2470 G-200	
7224	
2953-250	
6M-6-7, 6M-8-9, 6M-10-11, 6M-12-13, 6M-14-15, 6M-16-17, 6M-18-19, 6M-20-22	
2800-180	
2900-180	
2101G-160IP	

Clés et tournevis, 25 pcs



**FF1A124**

45 x 543 x 445 mm 1 FF1A124

B191.040.100	
B190.055.125, B190.065.150	
B192.000.075, B192.001.100, B192.002.125	
111M-32, 111M-6, 111M-7, 111M-8, 111M-9, 111M-10, 111M-11, 111M-12, 111M-13, 111M-14, 111M-15, 111M-16, 111M-17, 111M-18, 111M-19, 111M-21, 111M-22, 111M-24, 111M-27	

Outils de frappe et de coupe, 11 pcs



**FF1A127**

35 x 543 x 445 mm 1 FF1A127

3734S/6	
479-16	
3625W-35	
MTG-3-16	
KB18-01	
KSBG18-10DISPEN	
8224 IP	
2101G-160IP	
2628 G-180IP	
2430 G-200 IP	
2530	

Clés et limes, 18 pcs



**FF1A128**

65 x 543 x 445 mm 1 FF1A128

9029, 9031	
111Z-1/4, 111Z-5/16, 111Z-3/8, 111Z-7/16, 111Z-1/2, 111Z-9/16, 111Z-5/8, 111Z-11/16, 111Z-3/4, 111Z-13/16, 111Z-7/8, 111Z-1	
1-473-08-2-2	
361-12	
2633/S4	
S4RM/5T	

Pinces et tournevis, 16 pcs



**FF1A129**

45 x 543 x 445 mm 1 FF1A129

2171G-180	
2470 G-200	
2477 G-200	
9033, 9035	
1520 G	
808050P	
B191.040.100	
B190.055.125, B190.065.150	
B192.000.075, B192.001.100, B192.002.125	
BE-9777B	
2678 G-200	
59S/31-1	



Outils de frappe et de coupe, 25 pcs



**FF1A131**

40 x 543 x 445 mm	1 FF1A131

SQZ150003	
FS-8	
SQZ150003-SBL	
481-400	
3734-2, 3734-4, 3734-5, 3734-6, 3734-8, 3734-3	
3735-5-120	
3740-175	
BE-9678	
1547	
319	
208	
3625N-32	

Mix outils, 31 pcs



**FF1A132**

40 x 543 x 445 mm	1 FF1A132

7400SM-6, 7400SM-7, 7400SM-8, 7400SM-9, 7400SM-10, 7400SM-11, 7400SM-12, 7400SM-13, 7400SM-14, 7400SM-15, 7400SM-16, 7400SM-17, 7400SM-18, 7400SM-19	
7750SL	
SBS705	
SBS755	
SBS723, SBS724	
SBS775	
SBS760, SBS761, SBS762	

1-100-08-1-2	
1-160-08-1-2	
1-170-08-2-2	
1-210-08-1-2	
1-230-08-1-2	
2635	
1150D	
2681	

Mix douilles, pinces et tournevis, 39 pcs



**FF1A136**

40 x 543 x 445 mm	1 FF1A136

2628 G-180	
2430 G-160	
8224	
2101G-160	
6700SM-4.5, 6700SM-5, 6700SM-5.5, 6700SM-6, 6700SM-7, 6700SM-8, 6700SM-9, 6700SM-10, 6700SM-11, 6700SM-12, 6700SM-13, 6700SM-14, 6700SM-4	
6950SL	
SBS67	
SBS64	
SBS69	
SBS65	
SBS63-2, SBS63-4, SBS63-6	
2800-180	
2890-180	
2900-180	
2990-180	
B191.030.075, B191.040.100	
B190.055.100	
B195.050.025	
B190.065.125, B190.080.150	
B195.001.025	
B192.001.100, B192.002.125	
808050	

Outils de frappe et de coupe, 24 pcs



**FF1A138**

40 x 543 x 445 mm	1 FF1A138

SQZ150003	
FS-8	
SQZ150003-SBL	
481-400	
3734-2, 3734-3, 3734-4, 3734-5, 3734-6, 3734-8	
3735-5-120	
3740-175	
BE-9678	
319	
208	
3625N-32	

Outils de frappe et de coupe, 16 pcs



**FF1A143**

45 x 543 x 445 mm	1 FF1A143

SQZ150003	
FS-8	
SQZ150003-SBL	
MTB-5-25	
481-400	
3734-2, 3734-3, 3734-4, 3734-5, 3734-6, 3734-8	
3735-5-120	
3740-175	
319	
208	
3625N-32	

Tournevis et outils de coupe, 16 pcs



**FF1A147**

40 x 543 x 445 mm 1 FF1A147

2951-250, 2951-180	
SQZ150003	
SQZ150003-SBL	
B191.030.075, B191.040.100	
B190.055.100	
B195.050.025	
B190.065.125, B190.080.150	
B195.001.025	
B192.001.100, B192.002.125	
319	
208	
3625N-32	

FF1A16-18 pcs



**FF1A16**

40 x 543 x 445 mm 1 FF1A16

KE18-01	
1150-1/2H/P	
MTB-3-16	
1177-SCRIBE	
1544	
2509	
2535F2	
2632	
268	
2744	
2820EF2	
3525HB	
5471 F-145	
5515T	
5515T-52	
5516	

FF1A18-26 pcs



**FF1A18**

44 x 543 x 445 mm 1 FF1A18

1-476-04-3-2	
2633/S4	
3734S/6	
3736S/6	
481-200, 481-500	
782-U	
3625N-32	

FF1A23-21 pcs



**FF1A23**

40 x 543 x 445 mm 1 FF1A23

3735-4-120	
3734-2, 3734-3, 3734-4, 3734-5, 3734-6, 3734-8	
2630GC-180IP	
2430 GC-200 IP	
2427 GC-200IP	
2900-180	
2890-180	
2990-180	
2800-180	
7224	
2101GC-160IP	
479-16	
1547	
MTB-3-16	
SC127	
3625N-32	

FF1A24-19 pcs



**FF1A24**

45 x 543 x 445 mm 1 FF1A24

3735-4-120	
3734-2, 3734-3, 3734-4, 3734-5, 3734-6, 3734-8	
2630GC-180IP	
2430 GC-200 IP	
2900-180	
2890-180	
2990-180	
2800-180	
7224	
2101GC-160IP	
479-16	
3625N-32	
MTB-3-16	
SC127	



FF1A26-27 pcs



**FF1A26**

50 x 543 x 445 mm 1 FF1A26

- 111M-30, 111M-32, 111M-6, 111M-7, 111M-8, 111M-9, 111M-10, 111M-11, 111M-12, 111M-13, 111M-14, 111M-15, 111M-16, 111M-17, 111M-18, 111M-19, 111M-20, 111M-21, 111M-22, 111M-24, 111M-27
- 2630GC-180IP
- 2430 GC-200 IP
- 7224
- 2953-250
- 2101GC-160IP
- SC127

FF1A28-48 pcs



**FF1A28**

50 x 543 x 445 mm 1 FF1A28

- 7800SM-18, 7800SM-19, 7800SM-21, 7800SM-22, 7800SM-23, 7800SM-24, 7800SM-27, 7800SM-30, 7800SM-32, 7800SM-10, 7800SM-12, 7800SM-13, 7800SM-14, 7800SM-15, 7800SM-16, 7800SM-17
- 8154-1/2
- 8159-1/2, 8160-1/2
- 8166-1/2
- 8150SL
- 6700SM-4.5, 6700SM-5, 6700SM-5.5, 6700SM-6, 6700SM-7, 6700SM-8, 6700SM-9, 6700SM-10, 6700SM-11, 6700SM-12, 6700SM-13, 6700SM-4
- 6954
- 6960, 6962
- 6966
- 6950SL
- 3735-4-120

- 3734-2, 3734-3, 3734-4, 3734-5, 3734-6, 3734-8
- 479-16
- MTB-3-16
- 3625N-32

Outils de frappe et limes, 24 pcs



**FF1A35**

42 x 543 x 445 mm 1 FF1A35

- 317
- 1-100-08-1-2
- 1-210-08-1-2
- 1-230-08-1-2
- MTB-3-16
- 3625W-35
- 481-300
- 782-U
- BE-9770
- KG09-01
- 4040M-8-9, 4040M-10-11, 4040M-12-13, 4040M-14-15, 4040M-16-17

Tournevis, embouts et douilles, 89 pcs



**FF1A36**

50 x 543 x 445 mm 1 FF1A36

- BE-8576
- 4040M-8-9, 4040M-10-11, 4040M-12-13, 4040M-14-15, 4040M-16-17
- 808050S
- 808050
- 6972H
- K6650-1/4-1P
- 6950SL
- 59S/31-1

FF1A41, 9 pcs



**FF1A41**

42 x 543 x 445 mm 1 FF1A41

- 2171G-160
- 2470 G-160
- 2971G-250
- MTB-3-16
- WR2-12
- 3625W-35
- 481-300
- 218
- 306

FF1A5007-60 pcs



**FF1A5007**

50 x 543 x 445 mm 1 FF1A5007

- K6650-1/4-1P
- 3734-2, 3734-3, 3734-4, 3734-5, 3734-6, 3734-8
- 481-400
- 6700SM-11, 6700SM-12, 6700SM-13, 6700SM-14, 6700SM-10, 6700SM-5, 6700SM-6, 6700SM-7, 6700SM-8, 6700SM-9, 6700SM-4
- 6709F-8, 6709F-5.5
- 6709M-3, 6709M-4, 6709M-5, 6709M-6
- 6709PH-1, 6709PH-2
- 6950SL
- 6954
- 6960, 6962
- 6966

7800SM-18, 7800SM-19, 7800SM-10, 7800SM-11, 7800SM-12, 7800SM-13, 7800SM-14, 7800SM-15, 7800SM-16, 7800SM-17, 7800SM-21, 7800SM-22, 7800SM-23, 7800SM-24, 7800SM-25, 7800SM-26, 7800SM-27, 7800SM-28, 7800SM-30, 7800SM-32	
8072 IP	
B145.006.100	
8150SL	
8154-1/2	
8160-1/2, 8162-1/2	
8166-1/2	
8224 IP	

### FF1A5008-24 pcs



#### FF1A5008

50 x 543 x 445 mm 1 FF1A5008

1-100-08-2-2	
1-160-08-2-2	
1-170-08-2-2	
1-210-08-2-2	
1-230-08-2-2	
1150D	
1450D-ISO	
1547	
3625N-40	
3734-2, 3734-3, 3734-4, 3734-5, 3734-6, 3734-8	
3735-4-120, 3735-5-150	
3740-125, 3740-150	
38-20	
5515T	
9029, 9031	
MTB-3-16	

### FF1A5009-17 pcs



#### FF1A5009

38 x 543 x 445 mm 1 FF1A5009

2101S-160	
2223 S-150	
2250V-170	
2430 S-200	
2628 S-180	
8072V	
BE-8220S, BE-8040S	
BE-8340	
BE-8050S, BE-8255S, BE-8065S	
BE-8601	
BE-8610S, BE-8620S	
BE-8810S, BE-8820S	

### FF1A5010-22 pcs



#### FF1A5010

35 x 543 x 445 mm 1 FF1A5010

1-100-08-1-2	
1-160-08-1-2	
1-170-08-2-2	
1-210-08-1-2	
1-230-08-1-2	
2101G-180IP	
2427 G-200 IP	
2430 G-200 IP	
2628 G-180IP	
3733-2, 3733-4, 3733-6	
3734-2, 3734-3, 3734-4, 3734-5, 3734-6, 3734-8	
3735-4-120	
481-300	
8069 IP	
9031	

### FF1A5011-27 pcs



#### FF1A5011

44 x 543 x 445 mm 1 FF1A5011

1-476-04-3-2	
1178-SCRIBE	
1547	
2101G-160IP	
2427 G-160 IP	
2430 G-160 IP	
3734-2, 3734-3, 3734-4, 3734-5, 3734-6, 3734-8	
3735-5-120	
481-500	
BE-8020L, BE-8040	
BE-8150, BE-8255, BE-8256	
BE-8610, BE-8620	
MTB-3-16	

### FF1A5012-13 pcs



#### FF1A5012

48 x 543 x 445 mm 1 FF1A5012

141	
3734-2, 3734-3, 3734-4, 3734-5, 3734-6	
479-08	
481-1000, 481-300	
782-U	
MTS-5-25	
SQZ150003	
319	



FF1A5015, 17 pcs



**FF1A5015**

45 x 543 x 445 mm 1 FF1A5015

319	
268	
208	
2509	
2444	
2744	
5515T	
BE-8020L, BE-8040	
BE-8150, BE-8255, BE-8256	
BE-8340	
BE-8601	
BE-8610, BE-8620	
MTB-5-25	

FF1A5017, 16 pcs



**FF1A5017**

35 x 543 x 445 mm 1 FF1A5017

3734-2, 3734-3, 3734-4, 3734-5, 3734-6, 3734-8	
3735-5-120	
3740-175	
481-400	
111M-21, 111M-22, 111M-24, 111M-27, 111M-32, 111M-30	
3625N-32	

FF1A5019-47 pcs



**FF1A5019**

52 x 543 x 445 mm 1 FF1A5019

111M-17, 111M-18, 111M-19, 111M-20, 111M-6, 111M-7, 111M-8, 111M-13, 111M-14, 111M-15, 111M-16, 111M-9, 111M-10, 111M-11, 111M-12	
2101G-160IP	
2430 G-160 IP	
2628 G-180IP	
7800DM-12, 7800DM-13, 7800DM-14, 7800DM-15, 7800DM-10, 7800DM-11, 7800DM-20, 7800DM-21, 7800DM-22, 7800DM-23, 7800DM-16, 7800DM-17, 7800DM-18, 7800DM-19, 7800DM-28, 7800DM-30, 7800DM-32, 7800DM-24, 7800DM-25, 7800DM-26, 7800DM-27, 7800DM-8, 7800DM-9	
8154-1/2	
8155-1/2	
8160-1/2, 8162-1/2	
8166-1/2	
8224 IP	

FF1A5021-17 pcs



**FF1A5021**

45 x 543 x 445 mm 1 FF1A5021

--	--

BE-8020L, BE-8040	
BE-8150, BE-8255, BE-8256	
BE-8340	
BE-8601	
BE-8610, BE-8620	
319	
MTB-5-25	
2444	
268	
5515T	
2509	
2744	
208	

FF1A5022-26 pcs



**FF1A5022**

50 x 543 x 445 mm 1 FF1A5022



6700SM-4.5, 6700SM-5, 6700SM-5.5, 6700SM-6, 6700SM-7, 6700SM-8, 6700SM-9, 6700SM-10, 6700SM-11, 6700SM-12, 6700SM-13, 6700SM-14, 6700SM-4	
6950	
6954	
6956	
6960, 6962	
6966	
8070	
9031	
9072 P	
141	
2101G-160IP	
2430 G-160 IP	
2628 G-180IP	
8224 IP	















FF1A5023-16 pcs



**FF1A5023**



 45 x 543 x 445 mm   1 FF1A5023











208	
2444	
2509	
268	
2744	
319	
5515T	
BE-8020L, BE-8040	
BE-8150, BE-8255, BE-8256	
BE-8340	
BE-8601	
BE-8610, BE-8620	

FF1A5024-28 pcs



**FF1A5024**

 45 x 543 x 445 mm   1 FF1A5024





111M-12, 111M-13, 111M-6, 111M-7, 111M-8, 111M-9, 111M-10, 111M-11	
1RM-17, 1RM-18, 1RM-19, 1RM-8, 1RM-9, 1RM-10, 1RM-11, 1RM-12, 1RM-13, 1RM-14, 1RM-15, 1RM-16	
2101G-160IP	
2430 G-160 IP	
141	
2628 G-180IP	
9031	
9072 P	
8070	
8224 IP	

FF1A5028, 33 pcs



**FF1A5028**

 45 x 543 x 445 mm   1 FF1A5028









111M-6, 111M-7, 111M-8, 111M-9, 111M-10, 111M-11, 111M-14, 111M-15, 111M-16, 111M-17, 111M-18, 111M-19, 111M-20, 111M-11, 111M-13	
1419-MD	
BE-8906, BE-8907, BE-8908, BE-8909, BE-8910, BE-8915, BE-8920, BE-8925, BE-8927, BE-8930, BE-8940, BE-8945	
7805DM-12, 7805DM-13, 7805DM-17, 7805DM-10, 7805DM-19	

FF1A5029, 29 pcs



**FF1A5029**

 40 x 543 x 445 mm   1 FF1A5029









2628 G-180IP	
2101G-160IP	
2430 G-160 IP	
8224 IP	
BBR201P6	
BE5103	
2M-10-11, 2M-12-13, 2M-14-15, 2M-16-17, 2M-18-19, 2M-6-7, 2M-8-9	
7809TORX-T50, 7809TORX-T55, 7809TORX-T25, 7809TORX-T30, 7809TORX-T40, 7809TORX-T45	

FF1A5030, 45 pcs



**FF1A5030**

 52 x 543 x 445 mm   1 FF1A5030











111M-17, 111M-18, 111M-19, 111M-20, 111M-6, 111M-7, 111M-8, 111M-13, 111M-14, 111M-15, 111M-16, 111M-9, 111M-10, 111M-11, 111M-12	
2951-180, 2951-250	
7800DM-12, 7800DM-13, 7800DM-14, 7800DM-15, 7800DM-8, 7800DM-9, 7800DM-10, 7800DM-11, 7800DM-20, 7800DM-21, 7800DM-22, 7800DM-23, 7800DM-16, 7800DM-17, 7800DM-18, 7800DM-19, 7800DM-28, 7800DM-30, 7800DM-32, 7800DM-24, 7800DM-26, 7800DM-27	
8154-1/2	
8155-1/2	
8160-1/2, 8162-1/2	
8166-1/2	
3625N-32	

FF1A5031, 62 pcs



**FF1A5031**

 48 x 543 x 445 mm   1 FF1A5031

1419-MD	
7809M-10	
BE-9678	
7809M-10-140	
7809M-12, 7809M-14, 7809M-17, 7809M-19	
59S/31-1	
7809M-7, 7809M-8, 7809M-5, 7809M-9, 7809M-6	
7809M-5-180, 7809M-6-140, 7809M-7-100, 7809M-8-120	
808050	
7805DM-12, 7805DM-13, 7805DM-17, 7805DM-19, 7805DM-10	



FF1A5036-6 pcs



**FF1A5036**



38 x 543 x 445 mm



1 FF1A5036

BE255	
BE258	
BE250	
BE256P3	

FF1A5037-12 pcs



**FF1A5037**



75 x 543 x 445 mm



1 FF1A5037

BPC813	
BP814A	
BP824	
BP110	
BP118	

FF1A5038-50 pcs



**FF1A5038**



45 x 543 x 445 mm



1 FF1A5038

BBR300P50	
-----------	--

FF1A53-36pcs



**FF1A53**



45 x 543 x 445 mm



1 FF1A53

BE-8800, BE-8811, BE-8821	
BE-8830	
BE-8600, BE-8611, BE-8621	
BE-8630	
BE-8910, BE-8915, BE-8920, BE-8925	
BE-9770	
BE-9780	
3625S-44	
2800-225	
2890-210	

FF1A66-51 pcs



**FF1A66**



50 x 543 x 445 mm



1 FF1A66

038.055.100, 038.065.125, 038.080.150	
039.001.100, 039.002.125	
1178-SCRIBE	
426TOR9	
6972H	
9045-B-250	
BE-8010S	
BE-8040	
BE-8150, BE-8155	
BE-8230S	
BE-8800, BE-8811, BE-8821	
BE-8830	
MTB-5-25	
SQZ150003	
59S/31-1	

FF1A67-28 pcs



**FF1A67**



39 x 543 x 445 mm



1 FF1A67

9031	
2101G-160IP	
21HDG-180IP	
2427 G-160 IP	
2430 G-160 IP	
8224 IP	
BE-8600, BE-8611, BE-8621	
BE-8630	
BE-8910, BE-8915, BE-8920	
7865	
BE-8925	

FF1A72-18 pcs



**FF1A72**



38 x 543 x 445 mm



1 FF1A72













2101GC-160IP	
2430 GC-200 IP	
2630GC-180IP	
2800-180	
2890-180	
2900-180	
2953-200	
2990-180	
3640-200-C	
3734N-10-150, 3734N-2-150, 3734N-3-150, 3734N-4-150, 3734N-5-150, 3734N-6-150, 3734N-8-150	
479-16	
3625W-35	

FF1A154, 13 pièces



**FF1A154**

 37 x 445 x 543 mm   1 FF1A154



2171G-160	
224 D	
2470 G-160	
317	
3625W-28	
3733-4	
3734-3, 3734-6	
3735-5-120	
481-400	
KB18-01	
KSBG18-10DISPEN	
2678 G-180	

FF1A164, 50 pcs



**FF1A164**

 40 x 543 x 445 mm   1 FF1A164

















1RM-10, 1RM-11, 1RM-12, 1RM-13, 1RM-14, 1RM-15, 1RM-16, 1RM-17, 1RM-18, 1RM-19, 1RM-8	
S330	
SBS20-21, SBS20-24, SBS20-27, SBS20-32	

FF1A167, 23 pcs



**FF1A167**

 45 x 543 x 445 mm   1 FF1A167











1178-SCRIBE	
1419-MD	
2101G-160IP	
2430 G-190HD	
2628 G-180IP	
2744	
2953-250	
8224	 
9031	
BE-9770	 
BWSS12P317, BWSS12P319, BWS- S12P321	 
CR B 02	
2530	

FF1A169, 13 pièces



**FF1A169**

 35 x 445 x 543 mm   1 FF1A169













2681	
3625W-28	
3733-4	
3734-3, 3734-4, 3734-6	
3735-5-120	
481-400	
BB10	
BE66152	
BT10P330	
MA321	
MTB-3-16	

FF1A168, 36 pcs



**FF1A168**

 40 x 542 x 445 mm   1 FF1A168













1-100-08-2-2	
1-210-08-2-2	
1-230-08-2-2	
2485	
2487	
319	
268	
3740-100, 3740-150	
5515T	
782-U	
7865	
KB18-01	
KSBG18-10DISPEN	

25 pièces



**FF1A189**

 40 x 445 x 543 mm   1 FF1A189

3734S/6	
479-16	
3625W-35	
MTG-3-16	
KB18-01	
KSBG18-10DISPEN	
2101G-180IPD	
2630GC-180IP	
2470 G-200	
8224 IP	 
2530	



36 pièces



**FF1A197LM**



40 x 445 x 543 mm



1 FF1A197LM

1150-1/2H/P	
2744	
426TOR9	
K7801M-13, K7801M-15, K7801M-16, K7801M-17, K7801M-18, K7801M-19, K7801M-21, K7801M-22, K7801M-24	
K8160D-2	
K7806M-13, K7806M-14, K7806M-16, K7806M-17, K7806M-18, K7806M-19, K7806M-21, K7806M-22, K7806M-24	
KBGU-10P-DISPEN	
KERU-01	
MTC-5-16-C1	
325	
1544	

14 pièces



**FF1A205LM**



35 x 445 x 543 mm



1 FF1A205LM

2484-45	
2510	
2633/S4	
2951-180	
5515T	
BE66152	
BE-8986	
BT10P330	
2681	
1450D-ISO	
806-1-3	

24 pièces



**FF1A210LM**



40 x 445 x 543 mm



1 FF1A210LM

1RM-10, 1RM-11, 1RM-12, 1RM-13, 1RM-14, 1RM-15, 1RM-16, 1RM-17, 1RM-18, 1RM-19, 1RM-8, 1RM-9	
1520 G	
2101G-160	
2430 G-190HD	
2628 G-180	
BE-8602	
BE-8611, BE-8621	
BE-8811, BE-8821	
BE-8802	
8224	
9031	

40 pièces



**FF1A204LM**



40 x 445 x 543 mm



1 FF1A204LM

1-100-08-2-2	
1-170-08-2-2	
1-210-08-2-2	
1-230-08-2-2	
1411-3.2, 1412-4.8, 1413-6.4, 1414-8	
1435/5	
3734-2, 3734-3, 3734-4, 3734-5, 3734-6, 3734-8	
3735-4-120, 3735-5-120	
3740-150, 3740-250	
481-400	
7865	
3625N-32	

56 pièces



**FF1A208LM**



45 x 445 x 543 mm



1 FF1A208LM

2744	
7809M-10, 7809M-12, 7809M-14, 7809M-4, 7809M-5, 7809M-6, 7809M-7, 7809M-8	
K7801M-13, K7801M-15, K7801M-16, K7801M-17, K7801M-18, K7801M-19, K7801M-21, K7801M-22, K7801M-24	
K8160D-2	
KBGU-10P-DISPEN	
KERU-01	
319	
K6650-1/2-1P	
S240	

18 pièces



**FF1A212LM**



35 x 445 x 543 mm



1 FF1A212LM



















1-100-08-2-2	
1-210-08-2-2	
1-230-08-2-2	
3734-2, 3734-3, 3734-4, 3734-5, 3734-6, 3734-8	
3735-4-120	
3740-150, 3740-250	
426TOR9	
481-400	
BE-8986	
MTC-5-16-C1	
2446	
3625N-32	

31 pièces



**FF1A215LM**

 40 x 445 x 543 mm
  1 FF1A215LM































111M-10, 111M-11, 111M-12, 111M-13, 111M-14, 111M-15, 111M-16, 111M-17, 111M-18, 111M-19, 111M-20, 111M-21, 111M-22, 111M-24, 111M-8, 111M-9		
BE-8910, BE-8915, BE-8920, BE-8925, BE-8930		
BE-8020, BE-8040		
BE-8155		
BE-8355		
BE-8602		
BE-8611, BE-8621		
BE-8811, BE-8821		
BE-8802		

36 pièces



**FF1A216LM**

 40 x 445 x 543 mm
  1 FF1A216LM





















1-100-08-2-2		
1-210-08-2-2		
1-230-08-2-2		
3734-3, 3734-4, 3734-5		
3735-4-120		
481-400		
BE-8986		
BE-9770		
S4RM-8-11, S4RM-12-15, S4RM-16-19		
KB18-01		
KSBG18-10DISPEN		
MTG-3-16		
WR2-MM		
3740-200		
317		

42 pièces



**FF1A221LM**

 40 x 445 x 543 mm
  1 FF1A221LM

















1RM-10, 1RM-11, 1RM-12, 1RM-13, 1RM-14, 1RM-17, 1RM-19, 1RM-8		
2681		
4040M-10-11, 4040M-12-13, 4040M-14-15, 4040M-16-17, 4040M-18-19, 4040M-8-9		
8045LVDE		
806-1-1		
808050		
808050S		
9715-14-250		
BE-9575		
BE-9770		

65 pièces



**FF1A222LM**

 45 x 445 x 543 mm
  1 FF1A222LM











BE-7805, BE-7806, BE-7807, BE-7808, BE-7809, BE-7810, BE-7811, BE-7813, BE-7855		
D/S14		
K8160D-1, K8160D-2		
K8167S		
BE-8135TB, BE-8145TB, BE-8150TB, BE-8155TB		
BE-8610TB, BE-8620TB, BE-8623TB		
1150-1/2H/P		
59/S31B		

26 pièces



**FF1A224LM**

 40 x 445 x 543 mm
  1 FF1A224LM









1435/8	
319	
3625S-35	
3734S/6	
3735-5-150	
3740-200	
3750	
3906-300-24-2P	
479-16	
KBFU-01	
BE256P3	

60 pièces



**FF1A225LM**

 40 x 445 x 543 mm
  1 FF1A225LM

2487	
2535F1	
2633/S4	
2485	
782-U	
BE5049T	
BE66152	
2484-45	
5515T-52	



17 pièces

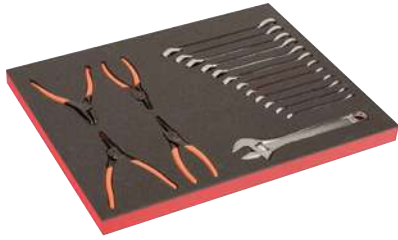

**FF1A230**



40 x 445 x 543 mm



1 FF1A230

1RM-9, 1RM-8, 1RM-11, 1RM-10, 1RM-13, 1RM-12, 1RM-15, 1RM-14, 1RM-17, 1RM-16, 1RM-19, 1RM-18



28-29/S4



8072 C



FF1A82- 25 pcs



**FF1A82**



43 x 543 x 445 mm



1 FF1A82

3734S/6



479-16



3625W-35



MTG-3-16



KB18-01



KSBG18-10DISPEN



2101G-180IP



2678 G-180



2470 G-200



720031



8224 IP



**KITS D'OUTILS PAR APPLICATION**

Servante 40" usage intensif avec 8 tiroirs



**MONSTER**



1370 x 501 x 1100 mm



1 MONSTER

FF1BSET-MONSTER



Servante usage intensif avec 9 tiroirs



**XLARGE**



1360 x 510 x 820 mm



1 XLARGE

FF1ASET-XLARGE



Servante d'atelier noire extra large 6 tiroirs avec outils + armoire latérale



**1475KXL6CBK-FF5**



986 x 501 x 1100 mm



1 1475KXL6CBK-FF5

FF1A48		
FF1A49		
FF1A50		
FF1A51		
FF1A213		
FF1A53		

Servante d'atelier noire extra large 6 tiroirs avec outils + armoire latérale



**1475KXL6CBK-FF6**



986 x 501 x 1100 mm



1 1475KXL6CBK-FF6

FF1A65		
FF1A66		
FF1A67		
FF1A68		
FF1A194		

Mètre linéaire Bahco



**BAHCO-1MW-1**



2250 x 520 x 1025 mm



1 BAHCO-1MW-1

10x 111M-8, 10x 111M-10, 10x 111M-12, 10x 111M-11, 10x 111M-14, 10x 111M-13, 10x 111M-16, 10x 111M-17, 10x 111M-19, 5x 111M-22, 5x 111M-24, 5x 111M-27, 5x 111M-30, 5x 111M-32		
5x 8072 C, 5x 8073 C		
5x 2101G-160		
5x 21HDG-180		
5x 2628 G-200		

5x 2430 G-200	
5x 2427 G-200	
5x 2223 G-150	
5x 8224	
3x 2101S-160	
3x 2628 S-180	
3x 2430 S-200	
5x 2997-300	
5x 28M-8, 5x 28M-10, 3x 28M-27, 2x 28M-30, 2x 28M-32, 3x 28M-20, 3x 28M-19, 3x 28M-22, 3x 28M-24, 5x 28M-12, 5x 28M-11, 5x 28M-14, 5x 28M-13, 5x 28M-16, 5x 28M-17	
10x B190.055.125, 10x B190.100.200, 10x B190.065.150	
10x B191.030.075, 10x B191.040.100	
10x B192.001.100, 10x B192.003.150, 10x B192.002.125	
10x B193.001.100, 10x B193.002.125	
10x B196.040.100, 10x B196.055.125, 10x B196.030.100	
10x B197.002.100, 10x B197.001.080	
6x 806-1-1	
4x BE-9578	
4x BE-9678	
4x BE-9575	
4x B219.017	
4x B220.007	
6x 482-40	
6x 483-25	
6x 3625S-35	
4x S240	
5x 319	
100x 3906-300-24-100	

Armoire avec volet roulant (1495CS18) + crochets inclus (981001100)



### 1495CS18TS1

900 x 170 x 1800 mm 1 1495CS18TS1

1495CS18

981001100

1495CS-AC1

1495TP-AC10

Armoire avec portes (1495CD60) + crochets inclus (981001100)



### 1495CD60TS1

900 x 250 x 602 mm 1 1495CD60TS1

1495CD60

981001100

1495CD-AC1

1495TP-AC10

Armoire avec volet roulant (1495CS15) + crochets inclus (981001100)



### 1495CS15TS1

900 x 170 x 1500 mm 1 1495CS15TS1

1495CS15

981001100

1495CS-AC1

1495TP-AC10

Caisse rigide 4750RCWD4 complète, 162 outils



### 4750RCWD4FF1

453 x 340 x 575 mm 1 4750RCWD4FF1

4750RCWD4

6700SM-10, 6700SM-9, 6700SM-12, 6700SM-11, 6700SM-6, 6700SM-8, 6700SM-7, 6700SM-13

A6800DM-13, A6800DM-12, A6800DM-9, A6800DM-8, A6800DM-11, A6800DM-10, A6800DM-5.5, A6800DM-7, A6800DM-6

6709M-3, 6709M-8, 6709M-6, 6709M-5, 6709M-4

6709PH-1, 6709PH-3, 6709PH-2

6709TORX-T30, 6709TORX-T27, 6709TORX-T40, 6709TORX-T15, 6709TORX-T10, 6709TORX-T25, 6709TORX-T20, 6709TORX-T9, 6709TORX-T8

6950SL

6954

6956

6958

6960, 6962, 6962L

6966

6972H

7764

7800SM-25, 7800SM-24, 7800SM-27, 7800SM-26, 7800SM-21, 7800SM-23, 7800SM-22, 7800SM-17, 7800SM-16, 7800SM-19, 7800SM-18, 7800SM-13, 7800SM-12, 7800SM-15, 7800SM-14, 7800SM-9, 7800SM-8, 7800SM-11, 7800SM-10, 7800SM-28, 7800SM-32, 7800SM-30

7809TORX-T45, 7809TORX-T25, 7809TORX-T50, 7809TORX-T30, 7809TORX-T27, 7809TORX-T40

8150RN-1/2

8159-1/2, 8160-1/2, 8162-1/2

8166-1/2

111M-30, 111M-32, 111M-27, 111M-29, 111M-24, 111M-19, 111M-18, 111M-21, 111M-15, 111M-14, 111M-17, 111M-16, 111M-11, 111M-10, 111M-13, 111M-12, 111M-7, 111M-6, 111M-9, 111M-8

9070C

BE-9770

1544

MTB-3-16

2101G-160IP

2427 G-200 IP

2430 G-200 IP

2628 G-160IP

8224 IP

1150-1/2H/P

5515T-52

2820EF2

481-300

3625W-35

8158-1/2

8154-1/2

3734-3, 3734-5, 3734-8

3735-4-120

1177-SCRIBE



Caisse ultra robuste complète, 194 outils



**4750RCHDW01FF3**

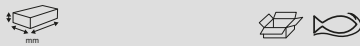

250 x 345 x 545 mm

1 4750RCHDW01FF3

4750RCHDW01	
FF2B12	
FF2B13	
FF2B14	
FF2B15	
FF2B16	

Caisse à outil usage intensif sur roues



**4750RCHDW02RF1V**



290 x 480 x 630 mm

1 4750RCHDW02RF1V



**BAHCO**

4750RCHDW02RED	
8150-1/2V	1000 V IEC60900
BMMTRMS1	
28MV-10, 28MV-15, 28MV-16, 28MV-21, 28MV-22	1000 V IEC60900
2101S-160, 2101S-180	1000 V IEC60900
2101S-200	1000 V IEC60900
2223 S-150	1000 V IEC60900
2820VDE	1000 V IEC60900
BE-8040S, BE-8050S	
BE-8703S, BE-8704S, BE-8725S	
BE-8910S, BE-8915S, BE-8920S, BE-8925S	
SC127V	1000 V IEC60900
1999MV-5, 1999MV-6, 1999MV-7, 1999MV-8, 1999MV-9, 1999MV-10	1000 V IEC60900
2430V-160	1000 V IEC60900
2678V-180, 2678V-160	1000 V IEC60900
3416 A	
806-1-1	
BE-8010S	
BE-8600S, BE-8610S	
28MV-12, 28MV-13	1000 V IEC60900
527V-160	1000 V IEC60900
BE-8065S	
BE-8620S, BE-8630S, BE-8640S	
BE-8705S, BE-8706S, BE-8708S	
BE-8930S	
2427V-200	1000 V IEC60900
2430V-200	1000 V IEC60900
2678V-200	1000 V IEC60900
2MV-10, 2MV-11, 2MV-12, 2MV-13, 2MV-14, 2MV-15, 2MV-16, 2MV-17, 2MV-18, 2MV-19	1000 V IEC60900
WR1-MM	
7800DMV-8, 7800DMV-10, 7800DMV-11, 7800DMV-12, 7800DMV-13, 7800DMV-14, 7800DMV-15, 7800DMV-16, 7800DMV-17, 7800DMV-18, 7800DMV-19, 7800DMV-20, 7800DMV-21, 7800DMV-22	1000 V IEC60900
2820VPC	1000 V IEC60900
1999MV-12	1000 V IEC60900
8162-1/2V	1000 V IEC60900
7224S	1000 V IEC60900

Caisse à outils en métal 1483KHD3RB avec 188 outils



**1483KHD3RB-FF3**

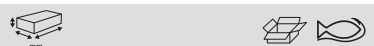

335 x 260 x 565 mm

1 1483KHD3RB-FF3

1483KHD3RB	
FF3A09	
FF3A10	
FF3A11	
FF3A12	

Caisse à outils en métal 1483KHD3RB avec 142 outils



**1483KHD3RB-FF4**

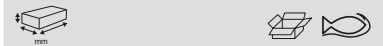

335 x 260 x 565 mm

1 1483KHD3RB-FF4

1483KHD3RB	
FF3A10	
FF3A11	
FF3A12	
FF3A13	

Composition de 32 outils dans une mallette en cuir



**982000320**

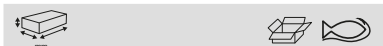

280 x 200 x 435 mm

1 982000320



4750-FOLTC-1	
2101D-160IP	
224 D	
2630D-180	
2430 D-160 IP	
8071 C IP	
483-20	
6M/8C	
541D-180	
2951-180	
B191.030.075, B191.040.100	
B190.100.200, B190.065.150	
B192.001.100, B192.002.125	
SC127	
2820EF2	
BE-9777	
MTB-3-16	

141 pièces



**FF1B01LM**

35 x 445 x 880 mm 1 FF1B01LM

6700SM-10, 6700SM-11, 6700SM-12, 6700SM-13, 6700SM-14, 6700SM-4, 6700SM-4.5, 6700SM-5, 6700SM-5.5, 6700SM-6, 6700SM-7, 6700SM-8, 6700SM-9	
6700SZ-1/2, 6700SZ-1/8, 6700SZ-9/16, 6700SZ-1/4, 6700SZ-11/32, 6700SZ-3/16, 6700SZ-3/8, 6700SZ-5/16, 6700SZ-7/16, 6700SZ-7/32, 6700SZ-9/32, 6700SZ-5/32	
6700TORX-E4, 6700TORX-E5, 6700TORX-E6, 6700TORX-E7, 6700TORX-E8, 6700TORX-E10	
6950SL	
6962L	
6972H	
7400SM-10, 7400SM-11, 7400SM-12, 7400SM-13, 7400SM-14, 7400SM-15, 7400SM-16, 7400SM-17, 7400SM-18, 7400SM-19, 7400SM-20, 7400SM-21, 7400SM-22, 7400SM-6, 7400SM-7, 7400SM-8, 7400SM-9	
7400TORX-E10, 7400TORX-E11, 7400TORX-E12, 7400TORX-E14, 7400TORX-E16, 7400TORX-E18	

7406ZZ-16, 7406ZZ-21	
7409TORX-R-T27, 7409TORX-R-T30, 7409TORX-R-T40, 7409TORX-R-T45, 7409TORX-R-T50	
7409TORX-T25, 7409TORX-T27, 7409TORX-T30, 7409TORX-T40, 7409TORX-T45, 7409TORX-T50	
7750SL	
8164-1/2	
A6800DM-10, A6800DM-12, A6800DM-13, A6800DM-4, A6800DM-5, A6800DM-5.5, A6800DM-6, A6800DM-7, A6800DM-8, A6800DM-9, A6800DM-11, A6800DM-14	
A6800DZ-9/16, A6800DZ-1/2, A6800DZ-1/4, A6800DZ-11/32, A6800DZ-3/16, A6800DZ-3/8, A6800DZ-5/16, A6800DZ-7/16, A6800DZ-7/32, A6800DZ-9/32	
A7400DZ-1/2, A7400DZ-11/16, A7400DZ-3/4, A7400DZ-3/8, A7400DZ-5/8, A7400DZ-7/16, A7400DZ-17/32, A7400DZ-9/16, A7400DZ-19/32, A7400DZ-13/16, A7400DZ-7/8, A7400DZ-1/4, A7400DZ-5/16	
K6650-1/4-1P	
K6625-1/4-1P	
6954	
6956	
6960, 6961	
6963	
6966	
7757	
7760, 7761, 7762	
7764	
7765	
7766	
7409BH-4, 7409BH-5, 7409BH-6, 7409BH-8, 7409BH-10	
A7402DM-10, A7402DM-11, A7402DM-12, A7402DM-13, A7402DM-14, A7402DM-15, A7402DM-16, A7402DM-17, A7402DM-18, A7402DM-19, A7402DM-8, A7402DM-9	
K6650-3/8-1P	

76 pièces



**FF1B02LM**

40 x 445 x 880 mm 1 FF1B02LM

7800DM-10, 7800DM-11, 7800DM-12, 7800DM-13, 7800DM-14, 7800DM-15, 7800DM-16, 7800DM-17, 7800DM-18, 7800DM-19, 7800DM-20, 7800DM-21, 7800DM-22, 7800DM-24, 7800DM-27, 7800DM-30, 7800DM-32, 7800DM-34, 7800DM-36	
7800DZ-1, 7800DZ-1.1/16, 7800DZ-1.1/4, 7800DZ-1.1/8, 7800DZ-1.3/16, 7800DZ-1/2, 7800DZ-11/16, 7800DZ-13/16, 7800DZ-15/16, 7800DZ-25/32, 7800DZ-3/4, 7800DZ-3/8, 7800DZ-5/8, 7800DZ-7/16, 7800DZ-7/8, 7800DZ-9/16, 7800DZ-19/32	
7809M-10, 7809M-12, 7809M-14, 7809M-4, 7809M-5, 7809M-6, 7809M-7, 7809M-8	
8150SL	
8159-1/2	
SBS87	
8160-1/2, 8162-1/2	
8165-1/2	
8166-1/2	
K7801M-13, K7801M-15, K7801M-16, K7801M-17, K7801M-18, K7801M-19, K7801M-21, K7801M-22, K7801M-24	
K8160D-2	
K7806M-13, K7806M-14, K7806M-16, K7806M-17, K7806M-18, K7806M-19, K7806M-21, K7806M-22, K7806M-24	
7809M-5-100, 7809M-6-100, 7809M-7-100, 7809M-8-120, 7809M-10-140	
K6650-1/2-1P	

36 pièces



**FF1B03LM**

35 x 445 x 880 mm 1 FF1B03LM

111M-10, 111M-11, 111M-12, 111M-13, 111M-14, 111M-15, 111M-16, 111M-17, 111M-18, 111M-19, 111M-20, 111M-21, 111M-22, 111M-24, 111M-27, 111M-30, 111M-32, 111M-34, 111M-8, 111M-9	
1RM-10, 1RM-11, 1RM-12, 1RM-13, 1RM-14, 1RM-15, 1RM-16, 1RM-17, 1RM-18, 1RM-19, 1RM-21, 1RM-22, 1RM-24, 1RM-27, 1RM-8, 1RM-9	



26 pièces



**FF1B04LM**

35 x 445 x 880 mm 1 FF1B04LM

1RM-30, 1RM-32	
111Z-1, 111Z-1.1/16, 111Z-1.1/4, 111Z-1.1/8, 111Z-1/2, 111Z-11/16, 111Z-13/16, 111Z-15/16, 111Z-3/4, 111Z-3/8, 111Z-5/16, 111Z-5/8, 111Z-7/16, 111Z-7/8, 111Z-9/16	
4040M-10-11, 4040M-12-13, 4040M-14-15, 4040M-16-17, 4040M-18-19, 4040M-8-9	
5515T	
BLTS7P	
2535L	

32 pièces



**FF1B05LM**

35 x 445 x 880 mm 1 FF1B05LM

1150-1/2H/P	
1520 G	
1620	
2101S-160	 1000 V EC9993
21HDG-160	
2223 S-150	 1000 V EC9993
2430 G-160	
2430 S-200	 1000 V EC9993
2628 G-180	
2628 S-180	 1000 V EC9993
2744	
426TOR9	 4.029" x 0.25mm 1000 V EC9993
KBGU-10P-DISPEN	
KERU-01	
MTC-5-16-C1	

8224	
9029, 9031	
806-1-3	
C3330R	
C3530	
C3230	
C3640	

88 pièces



**FF1B06LM**

40 x 445 x 880 mm 1 FF1B06LM

700-2.5-50, 700-2-50, 700-3-50	
701-00-50, 701-0-50, 701-1-75	
703-10-50, 703-15-75, 703-6-50, 703-7-50, 703-8-50, 703-9-50	
808050L	
BE-8010S	
BE-8020	
BE-8040SL, BE-8050SL	
BE-8040	
BE-8150, BE-8155, BE-8256	
BE-8355	
BE-8600	
BE-8600S	
BE-8602	
BE-8611	
BE-8610SL	
BE-8621	
BE-8620SL	
BE-8623	
BE-8702, BE-8725	
BE-8820SL	
BE-8870	
BE-8975B	
BE-9777B	
BE-9787	
BE-9770	
BE-9785	

169 pièces



**FF1B07LM**

40 x 445 x 880 mm 1 FF1B07LM

BE-8256TB, BE-8258TB	
BE-8620TB, BE-8623TB	
59/S100BC	
7455-200	
BE-8907, BE-8908, BE-8909, BE-8910, BE-8915, BE-8920, BE-8925, BE-8927, BE-8930, BE-8940	
BE-8811, BE-8821	
BE-8830	
BE-8802	
BE5049T	
BE-7607	

45 pièces



**FF1B08LM**

40 x 445 x 880 mm 1 FF1B08LM

1-100-08-2	
1-170-08-2	
1-210-08-2	
1-230-08-2	
1411-3.2, 1412-4.8, 1413-6.4, 1414-8	
1435/5	
2484-30, 2484-45, 2484-60	
3734-2, 3734-3, 3734-4, 3734-5, 3734-6, 3734-8	
3735-4-120, 3735-5-120	
3740-150, 3740-250	
4543-3	
4611-3	
481-400	
7865	
3625N-32	

21 pièces



**FF1B09LM**

35 x 445 x 880 mm 1 FF1B09LM

900T-025-100, 900T-030-100, 900T-040-150, 900T-050-150, 900T-060-200, 900T-080-200		
901T-010-100, 901T-015-150, 901T-020-150, 901T-025-150, 901T-027-150, 901T-030-200, 901T-040-200		
BE256-155, BE256-178, BE256-250		
BE66152		
BT10P325, BT10P330, BT10P338		
1544		

Composition de 32 outils dans une valise rigide



**983000320**

162 x 380 x 435 mm 1 983000320

4750RC01		
2101D-160IP		
224 D		
2630D-180		
2430 D-160 IP		
8071 C IP		
6M/8C		
483-20		
541D-180		
2951-180		

B191.030.075, B191.040.100		
B190.100.200, B190.065.125		
B192.001.100, B192.002.125		
SC127		
2820EF2		
BE-9777		
MTB-3-16		

20 pièces



**FF1B10LM**

45 x 445 x 880 mm 1 FF1B10LM

2633/S4		
2800-140, 2800-180		
2890-125, 2890-180		
2900-140, 2900-180		
2951-180		
2952-165		
2963-280		
2965-200		
2990-125, 2990-180		
BE-8986		
325		
2681		
CR B 02		

104 pièces



**FF1B11LM**

50 x 445 x 880 mm 1 FF1B11LM

RAIL-264		
CLIPS-1/4		
CLIPS-3/8		
CLIPS-1/2		
SLX 17		

Composition de 32 outils dans une valise rigide



**983100320**

210 x 415 x 460 mm 1 983100320

4750RC02		
2101D-160IP		
224 D		
2630D-180		
2430 D-160 IP		
8071 C IP		
483-20		
541D-180		
2951-180		
6M/8C		
B191.030.075, B191.040.100		
B190.100.200, B190.065.150		
B192.001.100, B192.002.125		
SC127		
2820EF2		
BE-9777		
MTB-3-16		



Composition de 32 outils dans une valise rigide à roulettes



### 984010320

255 x 390 x 465 mm 1 984010320

4750RCW01	
2101D-160IP	
224 D	
2630D-180	
2430 D-160 IP	
6M/8C	
8071 C IP	
483-20	
541D-180	
2951-180	
B191.030.075, B191.040.100	⓪
B190.100.200, B190.065.150	⓪
B192.001.100, B192.002.125	⊕
SC127	
2820EF2	
BE-9777	
MTB-3-16	

Composition de 34 outils dans une mallette en cuir



### 982000350

280 x 200 x 440 mm 1 982000350

**BAHCO**

4750-FOLTC-1	
2101GC-160IP	
2630GC-180IP	
2900-180	
2800-180	
1998M/10T	
8072 C IP	
2951-250	
B190.100.200, B190.065.150	⓪
B192.001.100, B192.002.125	⊕
B190.040.100	⓪
SC127	
6M/8C	
479-16	
2430 GC-200 IP	
1-110-08-2-2	
6224	

Pochette en tissu porte outils, 36 pcs



### 4750FB5ATS001

275 mm 170 1 4750FB5ATS001

4750FB5A	
2058/S26	
808050	
8070	
2101G-160	
2628 G-180	

Pochette à outils avec module mousse, 51 pcs



### 4750FB5BFF1

62 x 275 x 330 mm 1 4750FB5BFF1

4750FB5B	
808050P	
MTB-5-25	
2101G-160	
2628 G-180	
BE-9578	
9070	
59/S31B	

37 outils à usage général dans caisse à outils robuste



### 4750PTB65TS5

285 x 300 x 650 mm 1 4750PTB65TS5

2430 D-140 IP	
2630D-160	
MT-TS-3	
9572	
BE-9884	⊖
2446	
SL25	
427-16	

Pochette avec outils



### 4750-ROCO-1TS2

320 x 5 x 370 mm 1 4750-ROCO-1TS2

4750-ROCO-1	
1995M-4, 1995M-5, 1995M-6	
B190.055.125	
B192.002.125	
2678 G-180	
6M-8-9, 6M-10-11, 6M-12-13, 6M-14-17	
1936M-8-10	
9070	

Boite à outils



**3149-ORFF1**

220 x 220 x 560 mm 1 3149-ORFF1

S240	
111M-19, 111M-18, 111M-17, 111M-16, 111M-15, 111M-14, 111M-13, 111M-12, 111M-11, 111M-10, 111M-8, 111M-9	
2953-250	
224 D	
2171G-160	
2470 G-200	
BE-9770	
611-3.5-75	
613-3-100, 613-4-125	
611-5.5-125, 611-6.5-150	
615-2-25, 615-1-100, 615-2-125, 615-3-150	
KBSK-01	
MTG-5-19-E	
482-30	
3625W-28	
3745-150	
3740-150	
3734-3, 3734-5	
3735-5-120	
3149-OR	
2678 G-200	

Boite à outils



**3149-ORTS1**

220 x 220 x 560 mm 1 3149-ORTS1

S240	
111M-19, 111M-18, 111M-17, 111M-16, 111M-15, 111M-14, 111M-13, 111M-12, 111M-11, 111M-10, 111M-9, 111M-8	
2953-250	
224 D	
2171G-160	
2678 G-200	
2470 G-200	
BE-9770	
611-3.5-75	
613-3-100, 613-4-125	
611-5.5-125, 611-6.5-150	
615-2-25, 615-1-100, 615-2-125, 615-3-150	
KBSK-01	
MTG-5-19-E	
482-30	
3625W-28	
3745-150	
3740-150	
3734-3, 3734-5	
3735-5-120	
3149-OR	

Composition de 11 modules mousse



**FF1BSET-MONSTER**

40 x 445 x 880 mm 1 FF1BSET-MONSTER

FF1B01LM	
FF1B02LM	
FF1B03LM	
FF1B04LM	
FF1B05LM	
FF1B10LM	
FF1B11LM	
FF1B08LM	
FF1B09LM	
FF1B06LM	
FF1B07LM	

Composition de 12 modules mousse



**FF1ASET-XLARGE**

40 x 543 x 445 mm 1 FF1ASET-XLARGE

FF1A195LM	
FF1A196LM	
FF1A197LM	
FF1A198LM	
FF1A199LM	
FF1A200LM	
FF1A201LM	
FF1A202LM	
FF1A203LM	
FF1A204LM	
FF1A205LM	
FF1A206LM	



## FF1ASET-MAX - 195 pcs



### FF1ASET-MAX



265 x 595 x 790 mm



1 FF1ASET-MAX

111M-10, 111M-11, 111M-12, 111M-13, 111M-14, 111M-15, 111M-16, 111M-17, 111M-18, 111M-19, 111M-20, 111M-6, 111M-7, 111M-8, 111M-9		
141		
1419-MD		
1RM-10, 1RM-11, 1RM-12, 1RM-13, 1RM-14, 1RM-15, 1RM-16, 1RM-17, 1RM-18, 1RM-19, 1RM-8, 1RM-9		
2101G-160IP		
2430 G-160 IP		
2444		
2509		
2628 G-180IP		
268		
2744		
5515T		
59S/31-1		
6700SM-10, 6700SM-11, 6700SM-12, 6700SM-13, 6700SM-14, 6700SM-4, 6700SM-4.5, 6700SM-5, 6700SM-5.5, 6700SM-6, 6700SM-7, 6700SM-8, 6700SM-9		
6950		
6954		
6956		
6960, 6962		
6966		
7400SM-10, 7400SM-11, 7400SM-12, 7400SM-13, 7400SM-14, 7400SM-15, 7400SM-16, 7400SM-17, 7400SM-18, 7400SM-19, 7400SM-20, 7400SM-21, 7400SM-22, 7400SM-6, 7400SM-7, 7400SM-8, 7400SM-9		
7754		
7755-3/8		
7760, 7761, 7762		
7766		
7800DM-10, 7800DM-11, 7800DM-12, 7800DM-13, 7800DM-14, 7800DM-15, 7800DM-16, 7800DM-17, 7800DM-18, 7800DM-19, 7800DM-20, 7800DM-21, 7800DM-22, 7800DM-23, 7800DM-24, 7800DM-25, 7800DM-26, 7800DM-27, 7800DM-28, 7800DM-29, 7800DM-30, 7800DM-32, 7800DM-8, 7800DM-9		

7805DM-10, 7805DM-12, 7805DM-13, 7805DM-17, 7805DM-19		
7809M-10		
7809M-10-140		
7809M-12, 7809M-14, 7809M-17, 7809M-19, 7809M-5		
7809M-5-180		
7809M-6		
7809M-6-140		
7809M-7		
7809M-7-100		
7809M-8		
7809M-8-120		
7809M-9		
8070		
808050		
8154-1/2		
8155-1/2		
8160-1/2, 8160-10		
8166-1/2		
8224 IP		
9031		
9072 P		
BE-8020L, BE-8040		
BE-8150, BE-8255, BE-8256		
BE-8340		
BE-8601		
BE-8610, BE-8620		
BE-9678		
MTB-5-25		

### Module FF3A01 pour boîtes à outils 1483K & 1483KHD, 93 pcs



### FF3A01



64 x 245 x 505 mm



1 FF3A01

A6700DZ-1/2, A6700DZ-1/4, A6700DZ-11/32, A6700DZ-3/8, A6700DZ-5/16, A6700DZ-7/16, A6700DZ-7/32, A6700DZ-9/32		
A6710DZ-3/8, A6710DZ-5/16, A6710DZ-7/16		
A6800DZ-1/4, A6800DZ-5/16, A6800DZ-7/32, A6800DZ-9/32		
A7400DM-10, A7400DM-13		
A7400DZ-1/2, A7400DZ-11/16, A7400DZ-3/4, A7400DZ-5/8, A7400DZ-9/16		
A7402DZ-1/2, A7402DZ-3/8, A7402DZ-7/16, A7402DZ-9/16		

1320RZ-1/4-5/16, 1320RZ-3/8-7/16		
59/S28-4		
6Z-1.1/16-1.1/4, 6Z-1-1.1/8, 6Z-7/8-15/16		
6950SL		
6956		
6958		
6960, 6961		
6966		
6972H		
7407H		
7750SL		
7752		
7760, 7761		
7764		
7765		
7766		
7800DZ-1, 7800DZ-13/16, 7800DZ-7/8		
8164-1/2		
8165-1/2		

### Module FF3A02 pour boîtes à outils 1483K & 1483KHD, 13 pcs



### FF3A02



39 x 210 x 445 mm



1 FF3A02

BE-3529		
BE-8020L		
BE-8155		
BE-8260		
BE-8601		
BE-8611, BE-8621		
1150-1/2H/P		
1177-SCRIBE		
2047-1.2-8		
2047PR-1-2		
5515T-52		
9715-14-250		

Module FF3A03 pour boîtes à outils 1483K & 1483KHD, 12 pcs



### FF3A03

48 x 210 x 450 mm 1 FF3A03

MTB-3-16-M-E	
2101GC-160IP	
2421GC-180IP	
2855 D	
3658A-2, 3658A-3, 3658A-5	
8224CIP	
0454800500	

Module FF3A04 pour boîtes à outils 1483K & 1483KHD, 20 pcs



### FF3A04

45 x 210 x 445 mm 1 FF3A04

1300Z-1/2-9/16, 1300Z-1/4-5/16, 1300Z-3/8-7/16, 1300Z-5/8-3/4, 1300Z-7/8-15/16	
6Z-19/32-11/16, 6Z-25/32-13/16, 6Z-3/8-7/16, 6Z-5/8-3/4	
8158-1/2	
9070C	
6Z-1/4-5/16, 6Z-1/2-9/16	
1931Z-7/32, 1931Z-1/4	
1300Z-25/32-13/16, 1300Z-19/32-11/16	

Module FF3A05 pour boîtes à outils 1483K & 1483KHD, 95 pcs



### FF3A05

60 x 245 x 510 mm 1 FF3A05

A6700DZ-1/2, A6700DZ-1/4, A6700DZ-11/32, A6700DZ-3/16, A6700DZ-3/8, A6700DZ-5/16, A6700DZ-7/16, A6700DZ-7/32, A6700DZ-9/16, A6700DZ-9/32	
A6710DZ-1/4, A6710DZ-11/32, A6710DZ-3/8, A6710DZ-5/16, A6710DZ-7/16	
A6800DM-4	
A6800DZ-1/2, A6800DZ-1/4, A6800DZ-11/32, A6800DZ-3/8, A6800DZ-5/16, A6800DZ-7/16, A6800DZ-3/16, A6800DZ-7/32, A6800DZ-9/16, A6800DZ-9/32	
A7400DZ-1/2, A7400DZ-11/16, A7400DZ-13/16	
59/S28-4	
A7400DZ-17/32, A7400DZ-19/32, A7400DZ-3/4, A7400DZ-5/8, A7400DZ-9/16	
BE-9780	
KE18-01	
1544	
59S/TS-1/4	
6950SL	
6956	
6960, 6962	
6966	
6972H	
7407H	
7752	
7750SL	
7760, 7761	
7764	
7765	
7766	
808050	
9071C	
8164-1/2	

Module FF3A06 pour boîtes à outils 1483K & 1483KHD, 15 pcs



### FF3A06

40 x 205 x 450 mm 1 FF3A06

BE-8030	
BE-8150, BE-8155	
BE-8260	
BE-8350	
BE-8602	
BE-8610, BE-8620	
1177-SCRIBE	
2047-1-5.5	
2047PR-1-2	
5515T-52	
704Z-3/32	
1150-1/2H/P	

Module FF3A07 pour boîtes à outils 1483K & 1483KHD, 11 pcs



### FF3A07

39 x 202 x 450 mm 1 FF3A07

MTB-3-16-E	
2101GC-160IP	
2427 GC-200IP	
2628 GC-160IP	
2632	
2650	
2855	
3734-3, 3734-5, 3734-8	
8224CIP	



Module FF3A08 pour boîtes à outils 1483K & 1483KHD, 23 pcs



### FF3A08



43 x 205 x 450 mm



1 FF3A08

1320RZ-1/2-9/16, 1320RZ-1/4-5/16, 1320RZ-3/8-7/16		
1952Z-1/2, 1952Z-1/4, 1952Z-11/16, 1952Z-11/32, 1952Z-13/16, 1952Z-3/4, 1952Z-3/8, 1952Z-5/16, 1952Z-5/8, 1952Z-7/16, 1952Z-7/8, 1952Z-9/16		
6Z-19/32-11/16, 6Z-1/2-9/16, 6Z-1/4-5/16, 6Z-13/16-7/8, 6Z-3/8-7/16, 6Z-5/16-11/32, 6Z-5/8-3/4		

Module FF3A0 pour boîtes à outils 1483K & 1483KHD, 95 pcs



### FF3A09



65 x 250 x 515 mm



1 FF3A09

A6800DM-7, A6800DM-6, A6800DM-5.5, A6800DM-11, A6800DM-10, A6800DM-9, A6800DM-8, A6800DM-13, A6800DM-12		
A7402DM-19, A7402DM-18, A7402DM-17, A7402DM-12, A7402DM-11, A7402DM-10, A7402DM-16, A7402DM-15, A7402DM-14, A7402DM-13		
1544		
6700SM-8, 6700SM-7, 6700SM-6, 6700SM-5.5, 6700SM-12, 6700SM-11, 6700SM-10, 6700SM-9, 6700SM-13		
6709M-8, 6709M-6, 6709M-5, 6709M-4, 6709M-3		
6709PH-2, 6709PH-1, 6709PH-3		
6709TORX-T25, 6709TORX-T20, 6709TORX-T15, 6709TORX-T10, 6709TORX-T40, 6709TORX-T30, 6709TORX-T27, 6709TORX-T9, 6709TORX-T8		
6950SL		
6954		

6956		
6958		
6960, 6961, 6962, 6962L		
6966		
6972H		
7400SM-8, 7400SM-7, 7400SM-6, 7400SM-19, 7400SM-18, 7400SM-17, 7400SM-22, 7400SM-12, 7400SM-11, 7400SM-10, 7400SM-9, 7400SM-16, 7400SM-15, 7400SM-14, 7400SM-13		
7407H		
7409M-10, 7409M-8, 7409M-7, 7409M-6, 7409M-5, 7409M-4, 7409M-3		
7409TORX-T27, 7409TORX-T25, 7409TORX-T50, 7409TORX-T45, 7409TORX-T40, 7409TORX-T30		
7750SL		
7754		
7758		
7760, 7761		
7764		
7765		
7766		
8164-1/2		

Module FF3A10 pour boîtes à outils 1483K & 1483KHD, 53 pcs



### FF3A10



39 x 205 x 445 mm



1 FF3A10

BE-8020L, BE-8030		
BE-8155		
BE-8260		
BE-8350		
BE-8601, BE-8602		
BE-8610, BE-8620		
BE-9770		
2047-0.8-4		
2047PR-1-2		
808050P		
808050S		
59S/31-1		

Module FF3A11 pour boîtes à outils 1483K & 1483KHD, 12 pcs



### FF3A11



39 x 205 x 445 mm



1 FF3A11

1150-1/2H/P		
MTB-3-16		
1177-SCRIBE		
2101GC-160IP		
2427 GC-200IP		
2430 GC-200 IP		
2628 GC-160IP		
3734-3, 3734-5, 3734-8		
3735-4-120		
8224CIP		

Module FF3A12 pour boîtes à outils 1483K & 1483KHD, 28 pcs



### FF3A12



45 x 205 x 450 mm



1 FF3A12

111M-6, 111M-21, 111M-19, 111M-18, 111M-22, 111M-13, 111M-12, 111M-11, 111M-10, 111M-17, 111M-16, 111M-15, 111M-14, 111M-9, 111M-8, 111M-7		
2820EF2		
5515T-52		
6M-10-11, 6M-6-7, 6M-12-13, 6M-8-9, 6M-14-15, 6M-16-17, 6M-18-19, 6M-20-22		
9070C		



Module FF3A13 pour boîtes à outils 1483K & 1483KHD, 49 pcs



### FF3A13

68 x 245 x 525 mm 1 FF3A13

111M-27, 111M-32, 111M-24, 111M-30	
6M-24-27, 6M-30-32	
7800SM-19, 7800SM-18, 7800SM-17, 7800SM-16, 7800SM-22, 7800SM-21, 7800SM-11, 7800SM-10, 7800SM-15, 7800SM-14, 7800SM-13, 7800SM-12, 7800SM-27, 7800SM-32, 7800SM-30, 7800SM-24	
7807H	
7809M-10, 7809M-12, 7809M-14, 7809M-19, 7809M-17, 7809M-5, 7809M-8, 7809M-6	
7809TORX-T50, 7809TORX-T45, 7809TORX-T60, 7809TORX-T55, 7809TORX-T25, 7809TORX-T20, 7809TORX-T40, 7809TORX-T30, 7809TORX-T27	
7809M-7	
8150SL	
8154-1/2	
8160-1/2, 8162-1/2	
8164-1/2	
8165-1/2	
8166-1/2	
8964	

Module FF3A14 pour boîtes à outils 1483K & 1483KHD, 86 pcs



### FF3A14

65 x 247 x 510 mm 1 FF3A14

A6700DZ-1/2, A6700DZ-1/4, A6700DZ-3/8, A6700DZ-5/16, A6700DZ-7/16, A6700DZ-7/32, A6700DZ-9/16, A6700DZ-9/32	
A6800DZ-1/4, A6800DZ-5/16, A6800DZ-7/32, A6800DZ-9/32	

A7400DM-10, A7400DM-13	
A7400DZ-1/2, A7400DZ-11/16, A7400DZ-13/16, A7400DZ-3/4, A7400DZ-5/8, A7400DZ-7/8, A7400DZ-9/16	
A7402DZ-1/2, A7402DZ-3/8, A7402DZ-7/16, A7402DZ-9/16	
111Z-1, 111Z-1.1/8	
59/S28-4	
6Z-1.1/16-1.1/4, 6Z-1-1.1/8	
6Z/8C	
6950SL	
6958	
6960, 6961	
6966	
6972H	
7407H, 7408H	
7750SL	
7752	
7760, 7761	
7764	
7765	
7766	
7800DZ-1, 7800DZ-15/16	
8164-1/2	
8165-1/2	
1952Z-15/16	
A6700DZ-11/32	

Module FF3A15 pour boîtes à outils 1483K & 1483KHD, 14 pcs



### FF3A15

40 x 210 x 445 mm 1 FF3A15

BE-3529	
BE-8020L	
BE-8155	
BE-8260	
BE-8601, BE-8602	
BE-8611, BE-8621	
1177-SCRIBE	
2047-1.2-8	
2047PR-1-2	
5515T-52	
9715-14-250	

Module FF3A16 pour boîtes à outils 1483K & 1483KHD, 12 pcs



### FF3A16

42 x 210 x 445 mm 1 FF3A16

MTB-3-16-E	
2101GC-160IP	
2421GC-180IP	
3658A-3, 3658A-5, 3658A-8	
3735-5-120	
3740-150	
8224CIP	
2855 D	
0454800500	

Module FF3A17 pour boîtes à outils 1483K & 1483KHD, 30 pcs



### FF3A17

48 x 205 x 450 mm 1 FF3A17

BE-9780	
KE18-01	
1300Z-1/4-5/16, 1300Z-3/8-7/16	
1320RZ-1/4-5/16, 1320RZ-3/8-7/16	
1931Z-1/4, 1931Z-7/32	
1952Z-1/2, 1952Z-11/16, 1952Z-11/32, 1952Z-13/16, 1952Z-3/4, 1952Z-5/8, 1952Z-7/8, 1952Z-9/16	
2628 GC-180IP	
7758	



Composition de 109 outils



**981001100**



1 981001100

1546	
2521GC-160	
2630GC-180IP, 2630GC-200IP	
6M-12-13, 6M-14-15, 6M-10-11, 6M-6-7, 6M-8-9, 6M-20-22, 6M-21-23, 6M-24-27, 6M-25-28	
8150RN-1/2	
8154-1/2	
9048-400	
9-469-00-0-0	
1998M/10T	
3733-4	
3734-4	
814-100	
815-2-25	
9710-8-150, 9710-6.5-125	
2800-180	
815-1-100, 815-2-125	
SC127	
1-100-08-2-2	
1150-1/2H/P	
2101D-140IP	
2535F1	
3906-300-24-2P	
2951-250	
2M-6-7, 2M-8-9, 2M-10-11, 2M-12-13, 2M-14-15, 2M-16-17, 2M-18-19, 2M-20-22, 2M-21-23, 2M-24-27	
3645-150-C	
4544-10	
813-3-75, 813-4-100, 813-5.5-125	
1-100-10-2-2	
1-230-08-1-2	
2430 GC-160 IP	
3735-4-120	
2421GC-160	
2900-180	
3625W-35	
479-16	

8160-1/2, 8162-1/2	
869102500	
1-170-08-2-2	
1-210-08-2-2	
8072 C, 8071 C	
225-PLUS	
2427 GC-200IP	
3640-150-C	
7800DM-18, 7800DM-17, 7800DM-16, 7800DM-11, 7800DM-10, 7800DM-15, 7800DM-14, 7800DM-13, 7800DM-12, 7800DM-19, 7800DM-23, 7800DM-22, 7800DM-21, 7800DM-20, 7800DM-24, 7800DM-26, 7800DM-28, 7800DM-30, 7800DM-32, 7800DM-27	
813VDE-3-100	
8166-1/2	
6224	

Servante d'atelier robuste 7 tiroirs E72 + module mousse  
Servante E72 + module mousse



**1472K7BKFFM**



952 x 510 x 782 mm



1 1472K7BKFFM

**FF1ASET-AUTO13**

Panneau comprenant les outils nécessaires pour les travaux sur les roulements automobiles  
Outils et crochets inclus



**1495TP-AUTO-M1**



900 x 25 x 500 mm



1 1495TP-AUTO-M1

**1495TP09**

**BP910**

BP909TH	
BE-9678	
BE-9675	
29M-30	
2997-250	
1995LM-9, 1995LM-8, 1995LM-6	
3750	
1177-SCRIBE	
K7801M-9, K7801M-10, K7801M-11, K7801M-12, K7801M-13, K7801M-14, K7801M-15, K7801M-16, K7801M-17, K7801M-18, K7801M-19, K7801M-21, K7801M-22, K7801M-23, K7801M-24, K7801M-30, K7801M-32	
K7806M-15, K7806M-21, K7806M-24, K7806M-27	
K8901M-32, K8901M-34, K8901M-36	
K8964D	
K8167S	
K8160D-3	
2800-150	
2900-150	
3734S/6	
BE-8258TB	
9x 1495TP-ACHL40, 9x 1495TP-ACHL65, 33x 1495TP-ACHL20	

Panneau comprenant les outils nécessaires pour les travaux sur la transmission automobile  
Outils et crochets inclus



**1495TP-AUTO-M2**



900 x 25 x 500 mm



1 1495TP-AUTO-M2

1495TP09	
BE301	
K7801TORX-E10, K7801TORX-E12, K7801TORX-E14, K7801TORX-E16, K7801TORX-E18, K7801TORX-E20	
K8160D-2	
BE301CM	
BWHEPSSH8	
BE51038, BE510310, BE510312	
BP822	
BP825	
25x 1495TP-ACHL40, 4x 1495TP-ACHL65, 29x 1495TP-ACHL20	
1495TP-AC4	

Panneau comprenant les outils nécessaires pour la maintenance générale automobile  
Outils et crochets inclus



### 1495TP-AUTO-M3

900 x 25 x 500 mm 1 1495TP-AUTO-M3

1495TP09	
BE1GP5-T	
6968	
BE1SP1F	
BE6OF108	
BE6307414F	
BE6OFW	
BE1FFWF	
BE63064514F1	
BE6810Z	
BE6FCP	
52	
1546	
BE6810	
2421GC-160	
5515M	
BE1P	
7455-60	
BE1FLD2, BE1FLD1, BE1FLD3	
BE65F65120	
7764	
8164-1/2	
BE6302712F	
6962-W	
6954	
8166-1/2	
BE6701VAG	
BE62110	
BE1310P427	
7406ZZ-21, 7406ZZ-16	
BE1SP14L	
BE1GP5	
1495TP-AC3	
38x 1495TP-ACHL20, 1495TP-ACHL40, 1495TP-ACHL65	

Panneau comprenant les outils nécessaires pour la géométrie automobile  
Outils et crochets inclus



### 1495TP-AUTO-M4

900 x 25 x 500 mm 1 1495TP-AUTO-M4

1495TP09	
BS618	
4545-N1, 4545-N11	
4545-1, 4545-2	
MTB-3-16	
361-14	
8900SM-41	
BS52	
8169-1/2	
8165-1/2	
747-22, 747-21, 747-19, 747-17, 747-15, 747-14, 747-13, 747-12	
BS40VAG	
BS56	
BS100PSA1	
BS45BMW	
10x 1495TP-ACHL40, 5x 1495TP-ACHL65, 20x 1495TP-ACHL20	

Panneau comprenant les outils nécessaires pour la mécanique générale automobile  
Outils et crochets inclus



### 1495TP-AUTO-M5

900 x 25 x 500 mm 1 1495TP-AUTO-M5

1495TP09	
319	
484-1000	

SB3654BM-20	
3625S-44	
B192.004.200	
BE-8258TB	
2484/S4	
B194.030.150, B194.025.125, B194.020.100, B194.010.075	
600.005.012	
BBS165	
K7801TORX-E10, K7801TORX-E12, K7801TORX-E14, K7801TORX-E16, K7801TORX-E18, K7801TORX-E20, K7801TORX-E24	
BBR203P920, BBR203P925, BBR203P930, BBR203P940, BBR203P945, BBR203P950, BBR203P955, BBR203P960	
13x 1495TP-ACHL40, 38x 1495TP-ACHL20	
8226	

Panneau comprenant les outils nécessaires aux travaux des freins  
Outils et crochets inclus



### 1495TP-AUTO-M6

900 x 25 x 500 mm 1 1495TP-AUTO-M6

1495TP09	
FM10	
782-U	
BBR405	
BBR400	
BBR210P3	
BBR6131	
BBR204	
BBR1501	
BBR501011, BBR50121314	
2900-215	
7823	
BBR100	
1154	
6M-16-17, 6M-14-15	
1949M-17-19, 1949M-12-13, 1949M-10-11, 1949M-8-9	
2x 1495TP-ACHL40, 29x 1495TP-ACHL20	
1495TP-AC3	



62 pièces



**FF1ASET-AUTO-M1**



50 x 543 x 445 mm

1 FF1ASET-AUTO-M1

BP910	
BP909TH	
BE-9678	
BE-9675	
29M-30	
2997-250	
1995LM-9, 1995LM-8, 1995LM-6	
3750	
1177-SCRIBE	
K7801M-9, K7801M-10, K7801M-11, K7801M-12, K7801M-13, K7801M-14, K7801M-15, K7801M-16, K7801M-17, K7801M-18, K7801M-19, K7801M-21, K7801M-22, K7801M-23, K7801M-24, K7801M-30, K7801M-32	
K7806M-15, K7806M-21, K7806M-24, K7806M-27	
K8901M-32, K8901M-34, K8901M-36	
K8964D	
K8167S	
K8160D-3	
2800-150	
2900-150	
3734S/6	
BE-8258TB	

54 pièces



**FF1ASET-AUTO-M2**



60 x 543 x 445 mm

1 FF1ASET-AUTO-M2

**BAHCO**

BE301	
K7801TORX-E10, K7801TORX-E12, K7801TORX-E14, K7801TORX-E16, K7801TORX-E18, K7801TORX-E20	
K8160D-2	
BE301CM	
BWHEPSSH8	
BE51038, BE510310, BE510312	
BP822	
BP825	

34 pièces



**FF1ASET-AUTO-M3**



40 x 543 x 445 mm

1 FF1ASET-AUTO-M3

BE1GP5-T	
6968	
BE1SP1F	
BE6OF108	
BE6307414F	
BE6OFW	
BE1FFWF	
BE63064514F1	
BE6810Z	
BE6FCP	
52	
1546	
BE6810	
2421GC-160	
5515M	
BE1P	
7455-60	
BE1FLD2, BE1FLD1, BE1FLD3	
BE65F65120	
7764	
8164-1/2	
BE6302712F	
6962-W	
6954	
8166-1/2	
BE6701VAG	
BE62110	
BE1310P427	
7406ZZ-21, 7406ZZ-16	
BE1SP14L	
BE1GP5	

23 pièces



**FF1ASET-AUTO-M4**



60 x 543 x 445 mm

1 FF1ASET-AUTO-M4

BS618	
4545-N1, 4545-N11	
4545-1, 4545-2	
MTB-3-16	
361-14	
8900SM-41	
BS52	
8169-1/2	
8165-1/2	
747-22, 747-21, 747-19, 747-17, 747- 15, 747-14, 747-13, 747-12	
BS40VAG	
BS56	
BS100PSA1	
BS45BMW	

32 pièces







**FF1ASET-AUTO-M5**



45 x 543 x 445 mm



1 FF1ASET-AUTO-M5











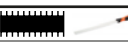



319	
484-1000	
SB3654BM-20	
3625S-44	
B192.004.200	
BE-8258TB	
2484/S4	
6225D	
B194.030.150, B194.025.125, B194.020.100, B194.010.075	
600.005.012	

<b>BBS165</b>		
K7801TORX-E10, K7801TORX-E12, K7801TORX-E14, K7801TORX-E16, K7801TORX-E18, K7801TORX-E20, K7801TORX-E24		
<b>BBR203P920, BBR203P925, BBR203P930, BBR203P940, BBR203P945, BBR203P950, BBR203P955, BBR203P960</b>		

42 pièces









<b>FF1ASET-AUTO-M6</b>		
40 x 543 x 445 mm	1	FF1ASET-AUTO-M6

<b>FM10</b>	
<b>782-U</b>	
<b>BBR405</b>	
<b>BBR400</b>	
<b>BBR210P3</b>	
<b>BBR6131</b>	
<b>BBR204</b>	
<b>BBR1501</b>	
<b>BBR501011, BBR50121314</b>	
<b>2900-215</b>	
<b>7823</b>	
<b>BBR100</b>	
<b>1154</b>	
<b>6M-16-17, 6M-14-15</b>	
<b>1949M-17-19, 1949M-12-13, 1949M-10-11, 1949M-8-9</b>	

Composition AUTO 5 modules, 196 pcs







<b>FF1ASET-AUTO1</b>		
50 x 543 x 445 mm	1	FF1ASET-AUTO1

<b>FF1A19</b>	
<b>FF1A20</b>	
<b>FF1A21</b>	
<b>FF1A22</b>	
<b>FF1A23</b>	

Composition AUTO 4 modules, 168 pcs





<b>FF1ASET-AUTO2</b>		
50 x 543 x 445 mm	1	FF1ASET-AUTO2

<b>FF1A19</b>	
<b>FF1A24</b>	
<b>FF1A21</b>	
<b>FF1A25</b>	

Composition AUTO 3 modules, 140 pcs





<b>FF1ASET-AUTO3</b>		
50 x 543 x 445 mm	1	FF1ASET-AUTO3

<b>FF1A28</b>	
<b>FF1A26</b>	
<b>FF1A27</b>	

Composition de modules mousse 3/3



<b>FF1ASET-AUTO13</b>		
50 x 543 x 445 mm	1	FF1ASET-AUTO13

<b>A6700DM-10, A6700DM-11, A6700DM-12, A6700DM-13, A6700DM-14, A6700DM-5, A6700DM-5.5, A6700DM-6, A6700DM-7, A6700DM-8, A6700DM-9</b>	
---	---

<b>A6800DM-10, A6800DM-11, A6800DM-13, A6800DM-7, A6800DM-8, A6800DM-9</b>	
--	---

<b>BE-9675</b>	
----------------	---

<b>BE-9678</b>	
----------------	---

<b>BPC813</b>	
---------------	---

<b>BWSMB15</b>	
----------------	---

<b>BWSMB17</b>	
----------------	---

<b>BWSS12P317, BWSS12P319, BWSS12P321, BWSS12P522, BWS-S12P524</b>	
--	---

<b>BWTSP6</b>	
---------------	---

<b>B147.001.400</b>	
---------------------	---

<b>B190.055.125, B190.080.150</b>	
-----------------------------------	---

<b>B191.025.075, B191.035.100</b>	
-----------------------------------	---

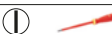
<b>B192.000.075, B192.001.100, B192.002.125</b>	
---	---

<b>B194.010.075, B194.020.100, B194.030.150, B194.040.150</b>	
---	---

<b>B196.030.100, B196.055.125</b>	
-----------------------------------	---

<b>KB18-01</b>	
----------------	---

<b>K7801M-10, K7801M-11, K7801M-12, K7801M-13, K7801M-14, K7801M-15, K7801M-16, K7801M-17, K7801M-18, K7801M-19, K7801M-21, K7801M-22, K7801M-23, K7801M-24, K7801M-27, K7801M-30, K7801M-32</b>	
--	---

<b>K8160D-1</b>	
-----------------	---

<b>K8167S</b>	
---------------	---

<b>MTB-3-16</b>	
-----------------	---

<b>111M-10, 111M-11, 111M-12, 111M-13, 111M-14, 111M-15, 111M-16, 111M-17, 111M-18, 111M-19, 111M-21, 111M-22, 111M-24, 111M-27, 111M-28, 111M-30, 111M-32, 111M-36, 111M-8, 111M-9</b>	
---	---



2171G-160	
224 D	
2800-180	
2890-180	
2900-180	
2951-250	
2990-180	
3625N-32	
3734-2, 3734-3, 3734-4, 3734-5, 3734-6, 3734-8	
3740-300	
482-40	
59/S54BC	
6950RN	
6956	
6961	
6966	
6973A	
70S/T45, 70S/T50, 70S/T55	
7106S	
7800DM-10, 7800DM-11, 7800DM-12, 7800DM-13, 7800DM-14, 7800DM-15, 7800DM-16, 7800DM-17, 7800DM-18, 7800DM-19, 7800DM-20, 7800DM-21, 7800DM-24, 7800DM-27, 7800DM-30, 7800DM-32, 7800DM-34	
7805DM-10, 7805DM-13, 7805DM-16, 7805DM-17, 7805DM-18, 7805DM-19	
7805SM-16, 7805SM-21	
7809M-10	
7809M-10-140	
7809M-12, 7809M-14, 7809M-17, 7809M-5	
7809M-5-100	
7809M-6	
7809M-6-100	
7809M-7	
7809M-7-100	
7809M-8	
7809M-8-120	
7809TORX-T30, 7809TORX-T40, 7809TORX-T45, 7809TORX-T50, 7809TORX-T55, 7809TORX-T60	
7809XZN-12-100	
783	
7994S0300, 7994S0400, 7994S0450, 7994S0500, 7994S0550, 7994S0600	
8045VDE	
8150RN-1/2	
8158-1/2	
8160-1/2, 8162-1/2	
8166-1/2	
9033	
7809TORX-T45-120, 7809TORX-T50-100	
2470 G-160	
2678 G-180	
7809TORX-T55-140, 7809TORX-T40-120	

### Composition outils 4 tiroirs



### FF1ASET-AUTO6



50 x 543 x 445 mm



1 FF1ASET-AUTO6

FF1A19

FF1A72

FF1A70

FF1A71



### Caisse ultra robuste complète, 240 outils



### 4750RCHDW01FF1



250 x 345 x 545 mm



1 4750RCHDW01FF1

4750RCHDW01

FF2B01

FF2B02

FF2B03

FF2B04

FF2B05

FF2B06



### Caisse ultra robuste complète, 159 outils



### 4750RCHDW01FF2



250 x 345 x 545 mm



1 4750RCHDW01FF2

4750RCHDW01

FF2B07

FF2B08

FF2B09

FF2B10

FF2B11



### Caisse rigide 4750RCHD01 avec compositions : FF2A07 + FF2A08 + FF2A09 + FF2A10



### 4750RCHD01FF1



215 x 410 x 475 mm



1 4750RCHD01FF1

4750RCHD01

FF2A07

FF2A08

FF2A10

FF2A09







Caisse à outils en métal 1483KHD3RB avec 129 outils



**1483KHD3RB-FF1**

 335 x 260 x 565 mm  1 1483KHD3RB-FF1











1483KHD3RB	
FF3A01	
FF3A02	
FF3A03	
FF3A04	

Caisse à outils en métal 1483KHD3RB avec 144 outils



**1483KHD3RB-FF2**

 335 x 260 x 565 mm  1 1483KHD3RB-FF2





1483KHD3RB	
FF3A05	
FF3A06	
FF3A07	
FF3A08	
2509	
2535F2	
3625N-32	
481-400	
7762	

Caisse à outils en métal 1483KHD3RB avec 142 outils



**1483KHD3RB-FF5**

 335 x 260 x 565 mm  1 1483KHD3RB-FF5





































































1483KHD3RB	
FF3A14	
FF3A15	
FF3A16	
FF3A17	

Caisse à outils 3 tiroirs usage intensif avec 124 outils



**1483KHD3RB-FF7**

 335 x 260 x 565 mm  1 1483KHD3RB-FF7

1483KHD3RB	
481-400	
2535F1	
7762	
6950SL	
6960, 6962	
6956	
7752	
6966	
6972H	
A6700DZ-3/16, A6700DZ-7/32, A6700DZ-1/4, A6700DZ-9/32, A6700DZ-5/16, A6700DZ-11/32, A6700DZ-3/8, A6700DZ-7/16, A6700DZ-1/2, A6700DZ-9/16	 
A6710DZ-1/4, A6710DZ-5/16, A6710DZ-11/32, A6710DZ-3/8, A6710DZ-7/16	 
A6800DZ-3/16, A6800DZ-7/32, A6800DZ-1/4, A6800DZ-9/32, A6800DZ-5/16, A6800DZ-11/32, A6800DZ-3/8, A6800DZ-7/16, A6800DZ-1/2, A6800DZ-9/16	 
A6800DM-4	 
BE-9780	 
59/S28-4	 
59S/TS-1/4	 
9070 P	
808050	
KE18-01	
1150-1/2H/P	
2047-1-5.5	 
2047PR-1-2	 
BE-8030	 
BE-8150	 
BE-8260	 
BE-8350	 
BE-8602	 
BE-8610, BE-8620	 
5515T-52	
1177-SCRIBE	
SR300-E	
704Z-3/32	 
MTB-3-16-M-E	
2101GC-160IP	
2427 GC-200IP	
2855	 
8224CIP	 
2628 GC-160IP	
2632	
3734-3, 3734-5, 3734-8	
1300Z-1/4-5/16	 
1320RZ-1/4-5/16, 1320RZ-3/8-7/16	 
1952Z-15/16	 
6Z-19/32-11/16	
1952Z-1, 1952Z-1/4, 1952Z-5/16, 1952Z-11/32, 1952Z-3/8, 1952Z-7/16, 1952Z-1/2, 1952Z-9/16, 1952Z-5/8, 1952Z-11/16, 1952Z-3/4, 1952Z-13/16, 1952Z-7/8	 
3625N-32	











Composition outils 4 tiroirs



**FF1ASET-AUTO6**

 50 x 543 x 445 mm   1 FF1ASET-AUTO6















FF1A19		
FF1A72		
FF1A70		
FF1A71		

Caisse ultra robuste complète, 240 outils



**4750RCHDW01FF1**

 250 x 345 x 545 mm   1 4750RCHDW01FF1











4750RCHDW01		
FF2B01		
FF2B02		
FF2B03		
FF2B04		
FF2B05		
FF2B06		

Caisse ultra robuste complète, 159 outils



**4750RCHDW01FF2**

 250 x 345 x 545 mm   1 4750RCHDW01FF2











4750RCHDW01		
FF2B07		
FF2B08		
FF2B09		
FF2B10		
FF2B11		

Caisse rigide 4750RCHD01 avec compositions :  
FF2A07 + FF2A08 + FF2A09 + FF2A10



**4750RCHD01FF1**

 215 x 410 x 475 mm   1 4750RCHD01FF1











4750RCHD01		
FF2A07		
FF2A08		
FF2A10		
FF2A09		

Caisse à outils en métal 1483KHD3RB avec 129 outils



**1483KHD3RB-FF1**

 335 x 260 x 565 mm   1 1483KHD3RB-FF1





















1483KHD3RB		
FF3A01		
FF3A02		
FF3A03		
FF3A04		

Caisse à outils en métal 1483KHD3RB avec 144 outils



**1483KHD3RB-FF2**

 335 x 260 x 565 mm   1 1483KHD3RB-FF2

1483KHD3RB		
FF3A05		
FF3A06		
FF3A07		
FF3A08		
2509		
2535F2		
3625N-32		
481-400		
7762		



### Caisse à outils en métal 1483KHD3RB avec 142 outils



### 1483KHD3RB-FF5

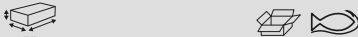

335 x 260 x 565 mm

1 1483KHD3RB-FF5

1483KHD3RB	
FF3A14	
FF3A15	
FF3A16	
FF3A17	

### Caisse à outils 3 tiroirs usage intensif avec 124 outils



### 1483KHD3RB-FF7

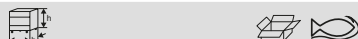

335 x 260 x 565 mm

1 1483KHD3RB-FF7

1483KHD3RB	
481-400	
2535F1	
7762	
6950SL	
6960, 6962	
6956	
7752	
6966	
6972H	
A6700DZ-3/16, A6700DZ-7/32, A6700DZ-1/4, A6700DZ-9/32, A6700DZ-5/16, A6700DZ-11/32, A6700DZ-3/8, A6700DZ-7/16, A6700DZ-1/2, A6700DZ-9/16	
A6710DZ-1/4, A6710DZ-5/16, A6710DZ-11/32, A6710DZ-3/8, A6710DZ-7/16	
A6800DZ-3/16, A6800DZ-7/32, A6800DZ-1/4, A6800DZ-9/32, A6800DZ-5/16, A6800DZ-11/32, A6800DZ-3/8, A6800DZ-7/16, A6800DZ-1/2, A6800DZ-9/16	
A6800DM-4	
BE-9780	
59/S28-4	
59S/TS-1/4	
9070 P	
808050	
KE18-01	
1150-1/2H/P	
2047-1-5.5	
2047PR-1-2	
BE-8030	
BE-8150	
BE-8260	
BE-8350	
BE-8602	
BE-8610, BE-8620	
5515T-52	
1177-SCRIBE	
SR300-E	
704Z-3/32	
MTB-3-16-M-E	
2101GC-160IP	
2427 GC-200IP	
2855	
8224CIP	
2628 GC-160IP	
2632	
3734-3, 3734-5, 3734-8	
1300Z-1/4-5/16	
1320RZ-1/4-5/16, 1320RZ-3/8-7/16	
1952Z-15/16	
6Z-19/32-11/16	
1952Z-1, 1952Z-1/4, 1952Z-5/16, 1952Z-11/32, 1952Z-3/8, 1952Z-7/16, 1952Z-1/2, 1952Z-9/16, 1952Z-5/8, 1952Z-11/16, 1952Z-3/4, 1952Z-13/16, 1952Z-7/8	
3625N-32	

### Composition d'outils de maintenance pour le forage de pétrole et gaz offshore Pour le travail en hauteur



### 1475KXL7PCFF1

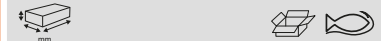

1020 x 501 x 1016 mm

1 1475KXL7PCFF1

TAH8072, TAH8075	
3875-HB100	
4750-HDLB-TAH	
TAH3640-250-C	
TAH1-143-12-1-2	
TAH479-16	
TAH484-1500	
TAH489-3600	
TAH487-5200	
TAH325	
TAHBE-9777B	
TAH2820EF2	
TAHBFRL11	
3875-LY8	
3875-MHP4	
3875-LY9	
3875-LY5	
3875-RL2	
3875-MHP6	
TAH466-250	
TAHPINRELEASER	
TAH380-10, TAH380-18	
TAH2101G-160, TAH2101G-140	
TAH2430G-200	
TAH2628G-180	
TAH2855	
TAH2958-250	
TAH8224	
TAH2484-30	
TAH3734BM-3, TAH3734BM-4, TAH3734BM-10, TAH3734BM-8, TAH- 3734BM-5, TAH3734BM-6	
TAHSCB140G	
TAHBE-8040, TAHBE-8241, TAH- BE-8252	
TAHBE-8257	
TAHBE-8350	
TAHBE-8620L, TAHBE-8611, TAH- BE-8620, TAHBE-8623	
TAHBE-8602	
TAHBE-8624	



TAH16B-27		
TAH16B-9/16		
TAH16B-30, TAH16B-24, TAH16B-25		
TAH16B-13/16		
TAH16B-22		
TAH16B-15/16		
TAH16B-32		
TAH16B-1/2		
TAH16B-19		
TAH16B-11/16		
TAH16B-21		
TAH16B-1.1/4		
TAH16B-17		
TAH16B-1.1/8		
TAH16B-18		
TAH16B-1		
TAH16B-15		
TAH16B-1.1/16		
TAH16B-16, TAH16B-13, TAH16B-14, TAH16B-12		
TAH16B-7/8, TAH16B-3/4, TAH16B-5/8		
TAH16B-10		
TAH16H-7/16, TAH16H-9/16, TAH16H-5/16, TAH16H-5/8, TAH16H-1/4, TAH16H-3/8, TAH16H-1/2		
TAH16-H8, TAH16-H6, TAH16-H4, TAH16-H5, TAH16-H17, TAH16-H12, TAH16-H14, TAH16-H10		
TAH8166		
TAH8150-1/2		
TAH8160, TAH8162		
TAH8158B-1		
TAH7455-300-1		
TAH111M-32, TAH111M-27, TAH111M-30, TAH111M-23, TAH111M-24, TAH111M-21, TAH111M-22, TAH111M-19, TAH111M-20, TAH111M-9, TAH111M-7, TAH111M-8, TAH111M-18, TAH111M-6, TAH111M-16, TAH111M-17, TAH111M-14, TAH111M-15, TAH111M-12, TAH111M-13, TAH111M-10, TAH111M-11		
TAH1949M-19-22, TAH1949M-12-14, TAH1949M-14-17, TAH1949M-10-11, TAH1949M-8-9, TAH1949M-24-27		
3875-LY60		
3875-LY70		
TAHWBB600		

Composition d'outils de maintenance mécanique pour l'industrie du pétrole et gaz offshore Pour le travail en hauteur



**1475KXL7PCFF2**



1020 x 501 x 1016 mm



1 1475KXL7PCFF2



**BAHCO**

TAH8074		
TAH3640-250-C		
TAH1-143-12-1-2		
TAH1-230-06-2-2		
TAH479-16		
TAH489-3600, TAH489-5400		
TAH325		
TAHBE-9777B		
TAHBE-9787		
TAH2487		
TAH466-250		
TAHPINRELEASER		
TAH380-14, TAH380-18		
TAH2101G-160		
TAH2430G-200		
TAH2628G-180		
TAH2855		
TAH2958-200, TAH2958-250		
TAH8224		
TAH3734BM-10, TAH3734BM-8, TAH3734BM-5, TAH3734BM-6, TAH3734BM-3, TAH3734BM-4		
TAHSCB140G		
TAHBE-8611, TAHBE-8623, TAHBE-8620L		
TAHBE-8040, TAHBE-8252		
TAHBE-8257		
TAHBE-8241		
TAHBE-8350		
TAHBE-8602		
TAH16B-19, TAH16B-21, TAH16B-17, TAH16B-18, TAH16B-22, TAH16B-32, TAH16B-24, TAH16B-25, TAH16B-27, TAH16B-30, TAH16B-12, TAH16B-15, TAH16B-16, TAH16B-13, TAH16B-14, TAH16B-10		
TAH16B-1/2, TAH16B-11/16, TAH16B-1.1/4, TAH16B-9/16, TAH16B-1.1/8, TAH16B-3/4, TAH16B-5/8, TAH16B-13/16, TAH16B-15/16, TAH16B-7/8, TAH16B-1.1/16		
TAH16-H12, TAH16-H8, TAH16-H6, TAH16-H10, TAH16-H4, TAH16-H5		
TAH8160, TAH8162		
TAH8158B-1		
TAH8166		
TAH8150-1/2		
TAH7455-300-1		
TAH111M-27, TAH111M-30, TAH111M-23, TAH111M-24, TAH111M-36, TAH111M-41, TAH111M-32, TAH111M-34, TAH111M-46, TAH111M-14, TAH111M-15, TAH111M-12, TAH111M-13, TAH111M-18, TAH111M-16, TAH111M-17, TAH111M-9, TAH111M-50, TAH111M-8, TAH111M-21, TAH111M-22, TAH111M-19, TAH111M-20, TAH111M-10, TAH111M-11		
TAH1949M-12-14, TAH1949M-14-17, TAH1949M-10-11, TAH1949M-24-27, TAH1949M-19-22		
MTS-5-25		
TAHBFRL11		
3875-HB100		
3875-HB60		
4750-HDLB-TAH		

3875-LY9		
3875-LY10		
3875-LY5		
3875-RL2		
3875-MHP4		
3875-MHP6		
4750-MTHO-TAH		
3875-LY60		
3875-LY70		

Composition d'outils de maintenance des grues dans l'industrie du pétrole et gaz offshore Pour le travail en hauteur



**4750RCHDW01FF4**



250 x 345 x 545 mm



1 4750RCHDW01FF4



TAH8075		
TAH479-32		
TAHBE-9777B		
TAHBE-9787		
TAH2820EF2		
TAHBFRL11		
TAH466-250		
TAHPINRELEASER		
TAH380-10		
TAH2101G-160		
TAH2628G-180		
TAH2855		
TAH8224		
TAHSCB140G		
TAHBE-8258		
TAHBE-8241, TAHBE-8252		
TAHBE-8620L, TAHBE-8620		
4750RCHDW01		
4750-HDLB-TAH		
3875-LY9		
3875-LY5		
3875-RL2		
3875-MHP4		
3875-MHP6		
3875-HB60		
3875-LY60		
3875-LY70		

Composition d'outils de maintenance dans l'industrie du pétrole et gaz offshore  
Pour le travail en hauteur

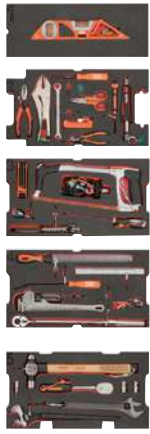

**4750RCHDW01FF9**



250 x 345 x 545 mm 1 4750RCHDW01FF9

TAH8073	
TAH84-PODGER	
TAH3640-250-C	
TAH1-143-12-1-2	
TAH479-32	
TAH325	
TAHBE-9777B	
TAH2820EF2	
TAHBFR11	
TAHPINRELEASER	
TAH380-14	
TAH2101G-140	
TAH2628G-180	
TAH2855	
TAH2958-250	
TAH2484-30	
TAH3734BM-8	
TAHSCB140G	
TAHBE-8257	
TAHBE-8602	
TAH16B-19	
TAH16B-11/16	
TAH16-H8	
TAH8150-1/2	
TAH8158B-1	
TAH7455-300-1	
TAH1949M-14-17	
4750RCHDW01	
4750-HDLB-TAH	
3875-LY9	
3875-LY5	
3875-RL2	
3875-MHP4	
3875-MHP6	
MTS-5-25	

4750-MTHO-TAH	
3875-HB60	
TAH2487	
TAH466-250	
3875-LY60	
3875-LY70	

Compositions d'outil MRO dans une caisse ultra robuste 4750RCHDW02



**4750RCHDW02FF1**

275 x 460 x 600 mm 1 4750RCHDW02FF1

4750RCHDW02	
6700SM-12, 6700SM-13, 6700SM-10, 6700SM-11, 6700SM-8, 6700SM-9, 6700SM-6, 6700SM-7, 6700SM-5.5	
A6800DM-13, A6800DM-11, A6800DM-12, A6800DM-9, A6800DM-10, A6800DM-7, A6800DM-8, A6800DM-5.5, A6800DM-6	
6709M-3, 6709M-4, 6709M-8, 6709M-5, 6709M-6	
6709PH-1, 6709PH-2, 6709PH-3	
6709TORX-T8, 6709TORX-T30, 6709TORX-T40, 6709TORX-T25, 6709TORX-T27, 6709TORX-T15, 6709TORX-T20, 6709TORX-T9, 6709TORX-T10	
6950SL	
6954	
6956	
6958	
6960, 6962, 6962L	
6966	
6972H	
7764	

7800SM-13, 7800SM-14, 7800SM-11, 7800SM-12, 7800SM-9, 7800SM-10, 7800SM-8, 7800SM-32, 7800SM-30, 7800SM-27, 7800SM-28, 7800SM-25, 7800SM-26, 7800SM-23, 7800SM-24, 7800SM-21, 7800SM-22, 7800SM-19, 7800SM-17, 7800SM-18, 7800SM-15, 7800SM-16	
7805SM-22, 7805SM-23, 7805SM-21, 7805SM-18, 7805SM-19, 7805SM-16, 7805SM-17, 7805SM-14, 7805SM-15, 7805SM-12, 7805SM-13, 7805SM-10, 7805SM-32, 7805SM-30, 7805SM-26, 7805SM-27, 7805SM-24, 7805SM-29, 7805SM-28, 7805SM-25, 7805SM-20	
7809TORX-T30, 7809TORX-T40, 7809TORX-T25, 7809TORX-T27, 7809TORX-T50, 7809TORX-T45	
8150RN-1/2	
8159-1/2, 8160-1/2	
8166-1/2	
111M-23, 111M-24, 111M-21, 111M-22, 111M-19, 111M-17, 111M-18, 111M-15, 111M-16, 111M-13, 111M-14, 111M-11, 111M-12, 111M-9, 111M-10, 111M-7, 111M-8, 111M-6, 111M-32, 111M-29, 111M-30, 111M-27, 111M-28, 111M-26, 111M-25	
8162-1/2	
1RM-18, 1RM-19, 1RM-16, 1RM-17, 1RM-14, 1RM-15, 1RM-12, 1RM-13, 1RM-10, 1RM-11, 1RM-8, 1RM-9, 1RM-6, 1RM-7	
9070C	
BE-9770	
BE-8571	
2509	
1544	
2101G-160IP	
2427 G-200 IP	
2430 G-200 IP	
2628 G-160IP	
8224 IP	
1150-1/2H/P	
5515T-52	
2820EF2	
481-300	
3625W-35	
8154-1/2	
3734-3, 3734-5, 3734-8	
3735-4-120	
1177-SCRIBE	
2535F1	
8158-1/2	
MTB-3-16	



Sac 4750FB2-19A avec 61 outils pour la maintenance



### 4750FB2-19TS001

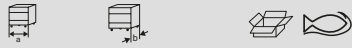

500 mm 250 1 4750FB2-19TS001

4750FB2-19A			
BE-8010S, BE-8040S, BE-8050S, BE-8220S	⊖		
BE-8610S, BE-8620S, BE-8630S	⊕		
BE-8800S, BE-8820S, BE-8830S	⊕		
706-4	⓪		
PC-12-VEN			
1-210-08-2-2			
2101G-180			
2233 D-200			
2628 G-180			
268			
3830-20-VIP, 3830-25-VIP			
3834-ARBR-730			
4130			
424P-16, 424P-20, 424P-25			
428-16			
484-1250			
806-1-1	⓪		
8231			
9031			
SL25			

Sac 4750FB2W-24A avec 72 outils



### 4750FB2W-TS001

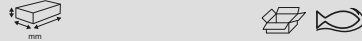

390 x 400 x 685 mm 1 4750FB2W-TS001

4750FB2W-24A			
S240			
SL25			
BE-8030, BE-8242	⊖		
BE-8155	⊖		
BE-8600, BE-8610, BE-8620	⊕		
BE-8800, BE-8810, BE-8820	⊕		
BE-8040S	⊖		
2628 G-180			
2101G-180			
7224			
1520 G			
MTB-5-25			
MA421			
268			
325			
479-16			
KERU-01			
5515T			
9071			

Composition MRO 7 modules, 256 pcs



### FF1ASET-MRO2



530 x 600 x 800 mm 1 FF1ASET-MRO2

FF1A130		
FF1A131		
FF1A132		
FF1A133		
FF1A134		
FF1A135		
FF1A136		

Composition MRO 5 modules, 188 pcs



### FF1ASET-MRO3



530 x 600 x 800 mm 1 FF1ASET-MRO3

FF1A138		
FF1A137		
FF1A134		
FF1A139		
FF1A141		

Composition MRO 4 modules, 147 pièces



### FF1ASET-MRO4

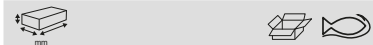

530 x 600 x 800 mm 1 FF1ASET-MRO4







FF1A143		
FF1A142		
FF1A145		
FF1A134		

Composition MRO 3 modules, 84 pcs



**FF1ASET-MRO5**

 530 x 600 x 800 mm  
  1 FF1ASET-MRO5



FF1A147		
FF1A146		
FF1A134		













































































Composition d'outils standards dans l'industrie éolienne  
Pour le travail en hauteur



**4750RCHDW02FF4**

 305 x 500 x 630 mm  
  1 4750RCHDW02FF4

TAH9070, TAH9072		
TAH3625W-35		
TAH481-300		
TAHBE-9777B		
TAH2820EF2		
TAH1150-1/2H/P		
TAH1177-SCRIBE		
TAH1544		
TAH2509		
TAH2535F2		
MTS-5-25		
TAHPINRELEASER		
TAH2427G-200		
TAH2430G-200		
TAH2628G-160		





































TAH8224		
TAH2484-30		
TAH3734BM-3, TAH3734BM-8, TAH-3734BM-5		
TAH3755BM-4		
TAHSCB140G		
TAHBE-8030, TAHBE-8020L		
TAHBE-8040S, TAHBE-8050S		
TAHBE-8155		
TAHBE-8220S		
TAHBE-8260		
TAHBE-8620S		
TAHBE-8620		
TAHBE-8630		
TAHBE-8610		
TAHBE-8610S		
TAHBE-8810, TAHBE-8820		
TAHBE-8830		
TAH08-5.5, TAH08-9, TAH08-7, TAH08-8, TAH08-13, TAH08-6, TAH08-11, TAH08-10, TAH08-12		
TAH6961, TAH6962, TAH6960		
TAH6956-1		
TAH6950		
TAH6966		
TAH6962L		
TAH6958B-1		
TAH16B-27, TAH16B-30, TAH16B-24, TAH16B-22, TAH16B-32, TAH16B-19, TAH16B-21, TAH16B-17, TAH16B-18, TAH16B-11, TAH16B-15, TAH16B-16, TAH16B-13, TAH16B-10, TAH16B-14, TAH16B-12		
TAH16-H8, TAH16-H6, TAH16-H7, TAH16-H5		
TAH16-T40, TAH16-T45, TAH16-T50, TAH16-T55		
TAH8166		
TAH8150-1/2		
TAH8160, TAH8162		
TAH8158B-1		
TAH111M-32, TAH111M-27, TAH111M-24, TAH111M-21, TAH111M-22, TAH111M-19, TAH111M-9, TAH111M-7, TAH111M-8, TAH111M-18, TAH111M-6, TAH111M-16, TAH111M-17, TAH111M-14, TAH111M-15, TAH111M-12, TAH111M-13, TAH111M-10, TAH111M-11, TAH111M-30		
TAH2101G-160		
TAH2047PR-1-2		
TAH2047-0.8-4		
TAH16-H17, TAH16-H19, TAH16-H12, TAH16-H14, TAH16-H10		
TAH16-T60		
4750RCHDW02		

Composition d'outils de maintenance dans l'industrie éolienne  
Pour le travail en hauteur



**4750RCHDW02FF15**

 480 x 290 x 630 mm  
  1 4750RCHDW02FF15

TAH1-100-06-2-4		
TAH1-210-06-2-2		
TAH1-230-06-2-2		
TAH3625PU-50		
TAH489-1100		
TAHBE64520		
TAHPINRELEASER		
TAHSCB140G		
TAH24B-50, TAH24B-46, TAH24B-41, TAH24B-38, TAH24B-36, TAH24B-32, TAH24B-30, TAH24B-27		
TAH8950N/A		
TAH8961		
TAH8953		
TAH7452-2		
TAH7455-300-1		
TAH7435-100		
TAH111M-50, TAH111M-46, TAH111M-41, TAH111M-36, TAH111M-34		
TAH7444SG-M-46, TAH7444SG-M-41, TAH7444SG-M-36, TAH7444SG-M-55, TAH7444SG-M-50		
4750RCHDW02		



Caisse ultra robuste 4750RCHDW02 complète, 167 outils pour l'industrie éolienne



### 4750RCHDW02FF2



600 x 275 x 460 mm 1 4750RCHDW02FF2

4750RCHDW02	
6700SM-12, 6700SM-13, 6700SM-10, 6700SM-11, 6700SM-8, 6700SM-9, 6700SM-6, 6700SM-7, 6700SM-5.5	
6954	
6956	
6958	
6960, 6961, 6962, 6962L	
6966	
6972H	
6950SL	
8158-1/2	
7800SM-13, 7800SM-14, 7800SM-11, 7800SM-12, 7800SM-10, 7800SM-32, 7800SM-30, 7800SM-27, 7800SM-24, 7800SM-21, 7800SM-19, 7800SM-17, 7800SM-18, 7800SM-15, 7800SM-16, 7800SM-22	
7809M-7, 7809M-6, 7809M-17, 7809M-19, 7809M-5, 7809M-14, 7809M-12, 7809M-10	
7809TORX-T60, 7809TORX-T40	
59S/31-1	
7809TORX-T55, 7809TORX-T50, 7809TORX-T45	
7809M-8	
8150SL	
8154-1/2	
8160-1/2, 8162-1/2	
8165-1/2	
8166-1/2	
111M-24, 111M-21, 111M-19, 111M-17, 111M-18, 111M-15, 111M-16, 111M-13, 111M-14, 111M-11, 111M-12, 111M-9, 111M-10, 111M-7, 111M-8, 111M-6, 111M-32, 111M-29, 111M-30, 111M-27	
BE-9770	
1177-SCRIBE	
6M-6-7, 6M-8-9, 6M-10-11, 6M-12-13, 6M-14-15, 6M-16-17, 6M-18-19, 6M-20-22, 6M-24-27, 6M-30-32	
MTB-3-16-E	
9070, 9072	

2535L	
BE-8020L, BE-8030	
BE-8155	
BE-8260	
BE-8610, BE-8620	
BE-8630	
BE-8810, BE-8820	
BE-8830	
1544	
2047-0.8-4	
TAH2047PR-1-2	
2509	
808050P	
808050S	
BE-8220S, BE-8040S, BE-8050S	
BE-8610S, BE-8620S	
2535F2	
1150-1/2H/P	
2101G-160IP	
2427 G-200 IP	
2430 G-200 IP	
2628 G-160IP	
2820EF2	
5515T-52	
8224 IP	
3625W-35	
3734-3, 3734-5, 3734-8	
3735-4-120	
481-300	
3680	
3875-RL1	
3875-WL1	
4750-3PB-2	
3750	

## CAISSES RIGIDES

Valise à outils rigide avec roulettes très résistante



### 4750RCHDW01



240 x 350 x 545 mm 1 4750RCHDW01RED  
240 x 350 x 545 mm 1 4750RCHDW01

Roues 60x20 avec roulement à billes pour faciliter le transport même chargée

Valise à outils rigide haute protection avec roues



### 4750RCHDW02



290 x 480 x 630 mm 1 4750RCHDW02RED  
290 x 480 x 630 mm 1 4750RCHDW02

Roue 60x37mm avec roulement à billes

Valise à outils rigide très résistante



### 4750RCHD01

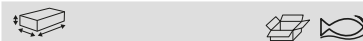

215 x 415 x 465 mm 1 4750RCHD01

Valise à outils indestructible en copolymère  
Polypropylène injecté

Valise à outils rigide renforcée avec compartiments



### 4750RCHD011



215 x 415 x 465 mm 1 4750RCHD011

Caisse à outils résistante et indestructible



**4750RCHD00**



205 x 345 x 400 mm

1 4750RCHD00

Caisses à outils à usage intensif 153,9 L sur roues



**4750RCHDW10**



460 x 560 x 860 mm

1 4750RCHDW10

Caisse à outils rigide 4 tiroirs sur roues



**4750RCWD4**



453 x 340 x 575 mm

1 4750RCWD4

453 x 340 x 575 mm

1 4750RCWD4-OR

Valise rigide avec roues



**4750RCW01**



257 x 406 x 485 mm

1 4750RCW01

257 x 406 x 485 mm

1 4750RCW011

4750RCW01 avec poche transparentes. 4750RCW011

Avec attaches caoutchouc

Valise rigide



**4750RC02**

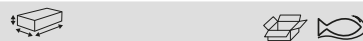

221 x 406 x 485 mm

1 4750RC02

221 x 406 x 485 mm

1 4750RC021

4750RC02 avec pochettes transparentes sur les cotés

4750RC021 avec bandes caoutchouc

Valise rigide avec système d'élastique



**4750RC01**



165 x 399 x 450 mm

1 4750RC01

Kit de 4 roues pivotantes 50x18mm



**4750RCWD-AC1**

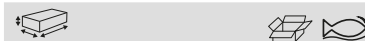

100 x 50 x 200 mm

1 4750RCWD-AC1

Panneau pivotant sous le couvercle - système d'étuis



**4750RCWD-AC2**

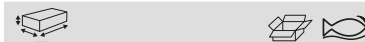

30 x 277 x 507 mm

1 4750RCWD-AC2

Panneau pivotant sous le couvercle - élastiques fixes



**4750RCWD-AC3**



5 x 277 x 507 mm

1 4750RCWD-AC3



Panneau pivotant sous le couvercle - élastiques réglables



### 4750RCWD-AC4

4 x 286 x 490 mm 1 4750RCWD-AC4

Panneau amovible renforcé pour 4750RCHDW01



### 4750RCHDW01AC1

50 x 204 x 500 mm 1 4750RCHDW01AC1

Module FF2A07 pour caisse 4750RCHD01, 64 pcs



### FF2A07

45 x 330 x 430 mm 1 FF2A07

Insert souple de rangement amovible pour 4750RCHD01



### 4750RCHD01AC1

35 x 305 x 425 mm 1 4750RCHD01AC1

Insert souple de rangement amovible pour 4750RCHDW01



### 4750RCHDW01AC2

120 x 280 x 525 mm 1 4750RCHDW01AC2

Insert souple de rangement amovible 4750RCHD01



### 4750RCHD01AC2

135 x 360 x 450 mm 1 4750RCHD01AC2

Cadenas TSA pour valise 4750RCHD



### 4750RCHD-AC1

20 x 40 x 70 mm 1 4750RCHD-AC1

A6700DZ-1/2, A6700DZ-1/4, A6700DZ-11/32, A6700DZ-3/16, A6700DZ-3/8, A6700DZ-5/16, A6700DZ-7/16, A6700DZ-7/32, A6700DZ-9/16, A6700DZ-9/32		
A6710DZ-3/8, A6710DZ-5/16, A6710DZ-7/16		
A6800DZ-1/2, A6800DZ-1/4, A6800DZ-11/32, A6800DZ-3/16, A6800DZ-3/8, A6800DZ-5/16, A6800DZ-7/16, A6800DZ-7/32, A6800DZ-9/16, A6800DZ-9/32		
A7400DZ-1/2, A7400DZ-11/16, A7400DZ-13/16, A7400DZ-19/32, A7400DZ-3/4, A7400DZ-3/8, A7400DZ-5/8, A7400DZ-7/16, A7400DZ-7/8, A7400DZ-9/16		
A7402DZ-1/2, A7402DZ-11/16, A7402DZ-13/16, A7402DZ-19/32, A7402DZ-3/4, A7402DZ-3/8, A7402DZ-5/8, A7402DZ-7/16, A7402DZ-7/8, A7402DZ-9/16		
6950SL		
6954		
6956		
6960, 6962, 6962L		
6966		
6972H		
7407H, 7408H		
7750SL		
7752		
7760, 7761, 7762		
7764		
7765		
7766		
8164-1/2		
A6710DZ-1/4		



Module FF2A08 pour caisse 4750RCHD01, 24 pcs



**FF2A08**

45 x 335 x 435 mm	1 FF2A08

1-100-04-2-2	
1-230-04-2-2	
111Z-1, 111Z-1/2, 111Z-1/4, 111Z-11/16, 111Z-3/4, 111Z-3/8, 111Z-5/16, 111Z-5/8, 111Z-7/16, 111Z-9/16	
1177-SCRIBE	
1320RZ-1/2-9/16, 1320RZ-1/4-5/16, 1320RZ-3/8-7/16	
1931Z-1/4, 1931Z-3/16, 1931Z-7/32	
1950MZ-3/8	
208	
111Z-7/8	
9031 C	

Module FF2A09 pour caisse 4750RCHD01, 56 pcs



**FF2A09**

45 x 335 x 440 mm	1 FF2A09

BE-8040, BE-8210	
BE-8260	
BE-8600, BE-8610, BE-8620	
BE-9780	
MTB-3-16-E	
2047-1-5-5	
2047PR-1-2	
59/S28-4	
2509	
2535F2	
5515T-52	
808050	
BE-8150	

Module FF2B01 pour caisse 4750RCHD01, 61 pcs



**FF2B01**

40 x 270 x 505 mm	1 FF2B01

A6700DZ-1/2, A6700DZ-1/4, A6700DZ-11/32, A6700DZ-3/16, A6700DZ-3/8, A6700DZ-5/16, A6700DZ-7/16, A6700DZ-7/32, A6700DZ-9/16, A6700DZ-9/32	
A6800DZ-1/2, A6800DZ-1/4, A6800DZ-11/32, A6800DZ-3/16, A6800DZ-3/8, A6800DZ-5/16, A6800DZ-7/16, A6800DZ-7/32, A6800DZ-9/16, A6800DZ-9/32	
A7400DZ-1/2, A7400DZ-1/4, A7400DZ-11/16, A7400DZ-17/32, A7400DZ-19/32, A7400DZ-3/4, A7400DZ-3/8, A7400DZ-5/16, A7400DZ-5/8, A7400DZ-7/16, A7400DZ-9/16	
A7402DZ-1/2, A7402DZ-1/4, A7402DZ-11/16, A7402DZ-19/32, A7402DZ-3/4, A7402DZ-3/8, A7402DZ-5/16, A7402DZ-5/8, A7402DZ-7/16, A7402DZ-9/16	
6950SL	
6954	
6956	
6958	
6960, 6961, 6962L	
6966	
6972H	
7407H	
7750SL	
7752	
7760, 7761, 7762	
7764	
7765	
7766	
8164-1/2	

Module FF2B02 pour caisse 4750RCHD01, 69 pcs



**FF2B02**

39 x 270 x 505 mm	1 FF2B02

A6700DM-5.5, A6700DM-6, A6700DM-11, A6700DM-12, A6700DM-13, A6700DM-14, A6700DM-7, A6700DM-8, A6700DM-9, A6700DM-10	
A6800DM-6, A6800DM-7, A6800DM-8, A6800DM-9, A6800DM-4, A6800DM-5, A6800DM-5.5, A6800DM-14, A6800DM-10, A6800DM-11, A6800DM-12, A6800DM-13	
A7400DM-10, A7400DM-14, A7400DM-15, A7400DM-16, A7400DM-11, A7400DM-12, A7400DM-17, A7400DM-18, A7400DM-19	
A7402DM-19, A7402DM-15, A7402DM-16, A7402DM-17, A7402DM-18, A7402DM-11, A7402DM-12, A7402DM-13, A7402DM-14, A7402DM-10	
BE-9770	
A7400DM-13	
111M-24, 111M-6, 111M-7, 111M-12, 111M-13, 111M-14, 111M-15, 111M-8, 111M-9, 111M-10, 111M-11, 111M-22, 111M-16, 111M-17, 111M-18, 111M-19	
4020L-M-5, 4020L-M-5.5	

Module FF2B03 pour caisse 4750RCHD01, 44 pcs



**FF2B03**

35 x 270 x 505 mm	1 FF2B03

A6710DM-7	
A6710DZ-1/2, A6710DZ-1/4, A6710DZ-11/32, A6710DZ-3/16, A6710DZ-3/8, A6710DZ-5/16, A6710DZ-7/16, A6710DZ-7/32, A6710DZ-9/16, A6710DZ-9/32	
BE-9780	
111Z-1, 111Z-1/2, 111Z-1/4, 111Z-11/16, 111Z-3/4, 111Z-3/8, 111Z-5/16, 111Z-5/8, 111Z-7/16, 111Z-7/8, 111Z-9/16	
1320RZ-1/2-9/16, 1320RZ-1/4-5/16, 1320RZ-3/8-7/16	
1931Z-1/4, 1931Z-3/16, 1931Z-7/32	
1950MZ-3/8	
111Z-13/16	



Module FF2B04 pour caisse 4750RCHDW01, 45 pcs



### FF2B04

42 x 270 x 505 mm	1	FF2B04

BE-8020L, BE-8040		
BE-8080-10		
BE-8150, BE-8255		
BE-8610, BE-8620		
1544		
2509		
59/S28-4		
2535F2		
5516		
700-1.5-50, 700-1-50		
701-0-50, 701-00-50		
808050		
9070C		

Module FF2B05 pour caisse 4750RCHDW01, 15 pcs



### FF2B05

35 x 270 x 510 mm	1	FF2B05

1150-1/2H/P		
MTB-3-16-M-E		
2101GC-125IP, 2101GC-160IP		
2427 GC-200IP		
2628 GC-160IP		
2650		
2820EF2		
2855		
4130		
4830		
5515T-52		
8224CIP		

Module FF2B06 pour caisse 4750RCHDW01, 6 pcs



### FF2B06

35 x 122 x 355 mm	1	FF2B06

3625N-32	
3734-5, 3734-8, 3734-3	
3735-5-120	
481-300	

Module FF2B07 pour caisse 4750RCHDW01, 62 pcs



### FF2B07

35 x 270 x 505 mm	1	FF2B07

A6700DZ-1/2, A6700DZ-1/4, A6700DZ-11/32, A6700DZ-3/16, A6700DZ-3/8, A6700DZ-5/16, A6700DZ-7/16, A6700DZ-7/32, A6700DZ-9/16, A6700DZ-9/32	
A6710DZ-3/8, A6710DZ-5/16, A6710DZ-7/16	
A6800DZ-1/2, A6800DZ-1/4, A6800DZ-11/32, A6800DZ-3/16, A6800DZ-3/8, A6800DZ-5/16, A6800DZ-7/16, A6800DZ-7/32, A6800DZ-9/16, A6800DZ-9/32	
A7400DZ-1/2, A7400DZ-11/16, A7400DZ-13/16, A7400DZ-19/32, A7400DZ-3/4, A7400DZ-3/8, A7400DZ-5/8, A7400DZ-7/16, A7400DZ-7/8, A7400DZ-9/16	
A7402DZ-1/2, A7402DZ-11/16, A7402DZ-13/16, A7402DZ-19/32, A7402DZ-3/4, A7402DZ-3/8, A7402DZ-5/8, A7402DZ-7/16, A7402DZ-7/8, A7402DZ-9/16	
6950SL	
6954	
6956	

6960, 6962, 6962L	
6966	
6972H	
7407H, 7408H	
7750SL	
7752	
7760, 7761, 7762	
7764	
7765	
7766	
8164-1/2	

Module FF2B0 pour caisse 4750RCHDW01, 25 pcs



### FF2B08

44 x 270 x 505 mm	1	FF2B08

1-100-04-2-2	
1-230-04-2-2	
111Z-1, 111Z-1/2, 111Z-1/4, 111Z-11/16, 111Z-3/4, 111Z-3/8, 111Z-5/16, 111Z-5/8, 111Z-7/16, 111Z-7/8, 111Z-9/16	
1177-SCRIBE	
1320RZ-1/2-9/16, 1320RZ-1/4-5/16, 1320RZ-3/8-7/16	
1931Z-1/4, 1931Z-3/16, 1931Z-7/32	
1950MZ-3/8	
208	
9031 C	

Module FF2B09 pour caisse 4750RCHDW01, 56 pcs



### FF2B09

47 x 270 x 505 mm	1	FF2B09

BE-8040		
BE-8150		
BE-8210		
BE-8260		

BE-8600, BE-8610, BE-8620		
BE-9780		
MTB-3-16-E		
2047-1-5.5		
2047PR-1-2		
2509		
2535F2		
5515T-52		
59/S28-4		
808050		

Module FF2B10 pour caisse 4750RCHDW01, 9 pcs



### FF2B10

37 x 270 x 505 mm	1 FF2B10

2101GC-160IP	
2427 GC-200IP	
2430 GC-200 IP	
2628 GC-160IP	
2650	
2744	
2855	
2979 D-180	
8224CIP	

Module FF2B11 pour caisse 4750RCHDW01, 7 pcs



### FF2B11

39 x 122 x 355 mm	1 FF2B11

2632	
3625N-32	
3734-2, 3734-3, 3734-4, 3734-5	
481-300	

Module FF2B12 pour caisse 4750RCHDW01, 92 pcs



### FF2B12

44 x 270 x 505 mm	1 FF2B12

A6800DM-6, A6800DM-7, A6800DM-8, A6800DM-9, A6800DM-5.5, A6800DM-10, A6800DM-11, A6800DM-12, A6800DM-13	
A7402DM-19, A7402DM-15, A7402DM-16, A7402DM-17, A7402DM-18, A7402DM-11, A7402DM-12, A7402DM-13, A7402DM-14, A7402DM-10	
6700SM-5.5, 6700SM-6, 6700SM-11, 6700SM-12, 6700SM-13, 6700SM-7, 6700SM-8, 6700SM-9, 6700SM-10	
6709M-3, 6709M-4, 6709M-5, 6709M-6, 6709M-8	
6709PH-1, 6709PH-2, 6709PH-3	
6709TORX-T20, 6709TORX-T25, 6709TORX-T27, 6709TORX-T30, 6709TORX-T8, 6709TORX-T9, 6709TORX-T10, 6709TORX-T15, 6709TORX-T40	
6954	
6956	
6958	
6960, 6961, 6962, 6962L	
6966	
6972H	
7400SM-6, 7400SM-11, 7400SM-12, 7400SM-13, 7400SM-14, 7400SM-7, 7400SM-8, 7400SM-9, 7400SM-10, 7400SM-19, 7400SM-22, 7400SM-15, 7400SM-16, 7400SM-17, 7400SM-18	
7407H	
7409M-8, 7409M-10, 7409M-4, 7409M-5, 7409M-6, 7409M-7, 7409M-3	
7409TORX-T25, 7409TORX-T27, 7409TORX-T30, 7409TORX-T40, 7409TORX-T45, 7409TORX-T50	
7750SL	
7761, 7762	
7764	
7765	
7766	
7760	
8164-1/2	
6950SL	

Module FF2B13 pour caisse 4750RCHDW01, 39 pcs



### FF2B13

50 x 270 x 505 mm	1 FF2B13

BE-9770		
111M-12, 111M-13, 111M-14, 111M-15, 111M-8, 111M-9, 111M-10, 111M-11, 111M-6, 111M-7, 111M-21, 111M-22, 111M-16, 111M-17, 111M-18, 111M-19		
6M-6-7, 6M-8-9, 6M-10-11, 6M-12-13, 6M-14-15, 6M-16-17, 6M-18-19, 6M-20-22		
9070C		
1177-SCRIBE		
2535F2		
7758		
7754		

Module FF2B14 pour caisse 4750RCHDW01, 48 pcs



### FF2B14

35 x 270 x 505 mm	1 FF2B14

BE-8020L, BE-8030		
BE-8155		
BE-8260		
BE-8350		
BE-8601, BE-8602		
BE-8610, BE-8620		
BE-8630		
1544		
2047-0.8-4		
2047PR-1-2		
2509		
808050P		
808050S		
59S/31-1		



Module FF2B15 pour caisse 4750RCHDW01, 9 pcs



### FF2B15

35 x 270 x 505 mm	1	FF2B15

1150-1/2H/P	
2101GC-160IP	
2427 GC-200IP	
2430 GC-200 IP	
2628 GC-160IP	
2820EF2	
5515T-52	
8224CIP	
MTB-3-16-E	

Module FF2B16 pour caisse 4750RCHDW01, 6 pcs



### FF2B16

34 x 122 x 355 mm	1	FF2B16

3625W-35	
3734-3, 3734-5, 3734-8	
3735-4-120	
481-300	

51 pièces



### FF2C01

45 x 390 x 530 mm	1	FF2C01

SBS81	
SL25	
BMMTRMS1	
S240	

Module FF2A10 pour caisse 4750RCHD01, 15 pcs



### FF2A10

49 x 330 x 435 mm	1	FF2A10

2101GC-160IP	
2427 GC-200IP	
2628 GC-160IP	
2632	
2650	
2855	
2979 D-180	
3625N-32	
3734-2, 3734-3, 3734-4, 3734-5	
3735-4-120	
481-300	
8224CIP	

## ÉTABLIS

Établi avec plan de travail en acier inoxydable et bloc tiroirs



### 1495KCWB15TS

1030 x 750 x 1500 mm	1	1495K6CBKWB15TS
1030 x 750 x 1500 mm	1	1495K6CBLWB15TS
1030 x 750 x 1500 mm	1	1495K6CRDWB15TS
1030 x 750 x 1500 mm	1	1495K6CWB15TS
1030 x 750 x 1500 mm	1	1495K7CBKWB15TS
1030 x 750 x 1500 mm	1	1495K7CBLWB15TS
1030 x 750 x 1500 mm	1	1495K7CRDWB15TS
1030 x 750 x 1500 mm	1	1495K7CWB15TS

1030 x 750 x 1500 mm	1	1495K8CBKWB15TS
1030 x 750 x 1500 mm	1	1495K8CBLWB15TS
1030 x 750 x 1500 mm	1	1495K8CRDWB15TS
1030 x 750 x 1500 mm	1	1495K8CWB15TS

Établi avec plan de travail en acier inoxydable et bloc tiroirs



### 1495KCWB18TS

1030 x 750 x 1800 mm	1	1495K6CBKWB18TS
1030 x 750 x 1800 mm	1	1495K6CBLWB18TS
1030 x 750 x 1800 mm	1	1495K6CRDWB18TS
1030 x 750 x 1800 mm	1	1495K6CWB18TS
1030 x 750 x 1800 mm	1	1495K7CBKWB18TS
1030 x 750 x 1800 mm	1	1495K7CBLWB18TS
1030 x 750 x 1800 mm	1	1495K7CRDWB18TS
1030 x 750 x 1800 mm	1	1495K7CWB18TS
1030 x 750 x 1800 mm	1	1495K8CBKWB18TS
1030 x 750 x 1800 mm	1	1495K8CBLWB18TS
1030 x 750 x 1800 mm	1	1495K8CRDWB18TS
1030 x 750 x 1800 mm	1	1495K8CWB18TS

Établi avec plateau bois et tiroir latéral



### 1495KWB15TW

1030 x 750 x 1500 mm	1	1495K6CBKWB15TW
1030 x 750 x 1500 mm	1	1495K6CBLWB15TW
1030 x 750 x 1500 mm	1	1495K6CRDWB15TW
1030 x 750 x 1500 mm	1	1495K6CWB15TW
1030 x 750 x 1500 mm	1	1495K7CBKWB15TW
1030 x 750 x 1500 mm	1	1495K7CBLWB15TW
1030 x 750 x 1500 mm	1	1495K7CRDWB15TW
1030 x 750 x 1500 mm	1	1495K7CWB15TW
1030 x 750 x 1500 mm	1	1495K8CBKWB15TW
1030 x 750 x 1500 mm	1	1495K8CBLWB15TW
1030 x 750 x 1500 mm	1	1495K8CRDWB15TW
1030 x 750 x 1500 mm	1	1495K8CWB15TW

Établi avec plateau bois et tiroir latéral



**1495KWB18TW**



1030 x 750 x 1800 mm	1	1495K6CBKWB18TW
1030 x 750 x 1800 mm	1	1495K6CBLWB18TW
1030 x 750 x 1800 mm	1	1495K6CRDWB18TW
1030 x 750 x 1800 mm	1	1495K6CWB18TW
1030 x 750 x 1800 mm	1	1495K7CBKWB18TW
1030 x 750 x 1800 mm	1	1495K7CBLWB18TW
1030 x 750 x 1800 mm	1	1495K7CRDWB18TW
1030 x 750 x 1800 mm	1	1495K7CWB18TW
1030 x 750 x 1800 mm	1	1495K8CBKWB18TW
1030 x 750 x 1800 mm	1	1495K8CBLWB18TW
1030 x 750 x 1800 mm	1	1495K8CRDWB18TW
1030 x 750 x 1800 mm	1	1495K8CWB18TW

Établi MDF avec tiroir latéral



**1495KWB15TD**



1030 x 750 x 1500 mm	1	1495K6CBKWB15TD
1030 x 750 x 1500 mm	1	1495K6CBLWB15TD
1030 x 750 x 1500 mm	1	1495K6CRDWB15TD
1030 x 750 x 1500 mm	1	1495K6CWB15TD
1030 x 750 x 1500 mm	1	1495K7CBKWB15TD
1030 x 750 x 1500 mm	1	1495K7CBLWB15TD
1030 x 750 x 1500 mm	1	1495K7CRDWB15TD
1030 x 750 x 1500 mm	1	1495K7CWB15TD
1030 x 750 x 1500 mm	1	1495K8CBKWB15TD
1030 x 750 x 1500 mm	1	1495K8CBLWB15TD
1030 x 750 x 1500 mm	1	1495K8CRDWB15TD
1030 x 750 x 1500 mm	1	1495K8CWB15TD

Établi avec plateau MDF et tiroir latéral



**1495KWB18TD**



1030 x 750 x 1800 mm	1	1495K6CBKWB18TD
1030 x 750 x 1800 mm	1	1495K6CBLWB18TD
1030 x 750 x 1800 mm	1	1495K6CRDWB18TD
1030 x 750 x 1800 mm	1	1495K6CWB18TD
1030 x 750 x 1800 mm	1	1495K7CBKWB18TD
1030 x 750 x 1800 mm	1	1495K7CBLWB18TD
1030 x 750 x 1800 mm	1	1495K7CRDWB18TD
1030 x 750 x 1800 mm	1	1495K7CWB18TD
1030 x 750 x 1800 mm	1	1495K8CBKWB18TD
1030 x 750 x 1800 mm	1	1495K8CBLWB18TD
1030 x 750 x 1800 mm	1	1495K8CRDWB18TD
1030 x 750 x 1800 mm	1	1495K8CWB18TD

Établi usage intensif hauteur basse (880 mm)



**1495KH6WBTS**



880 x 750 x 1500 mm	1	1495KH6BKWB15TS
880 x 750 x 1800 mm	1	1495KH6BKWB18TS
880 x 750 x 1500 mm	1	1495KH6BLWB15TS
880 x 750 x 1800 mm	1	1495KH6BLWB18TS
880 x 750 x 1500 mm	1	1495KH6RDWB15TS
880 x 750 x 1800 mm	1	1495KH6RDWB18TS
880 x 750 x 1500 mm	1	1495KH6WB15TS
880 x 750 x 1800 mm	1	1495KH6WB18TS

Établi usage intensif hauteur basse (880 mm)



**1495KH7WBTS**



880 x 750 x 1500 mm	1	1495KH7BKWB15TS
---------------------	---	-----------------



880 x 750 x 1800 mm	1	1495KH7BKWB18TS
880 x 750 x 1500 mm	1	1495KH7BLWB15TS
880 x 750 x 1800 mm	1	1495KH7BLWB18TS
880 x 750 x 1500 mm	1	1495KH7RDWB15TS
880 x 750 x 1800 mm	1	1495KH7RDWB18TS
880 x 750 x 1500 mm	1	1495KH7WB15TS
880 x 750 x 1800 mm	1	1495KH7WB18TS

Établi usage intensif hauteur basse (880 mm)



**1495KH8WBTS**



880 x 750 x 1500 mm	1	1495KH8BKWB15TS
880 x 750 x 1800 mm	1	1495KH8BKWB18TS
880 x 750 x 1500 mm	1	1495KH8BLWB15TS
880 x 750 x 1800 mm	1	1495KH8BLWB18TS
880 x 750 x 1500 mm	1	1495KH8RDWB15TS
880 x 750 x 1800 mm	1	1495KH8RDWB18TS
880 x 750 x 1500 mm	1	1495KH8WB15TS
880 x 750 x 1800 mm	1	1495KH8WB18TS

Établi usage intensif hauteur basse (880 mm)



**1495KH6WBTD**



880 x 750 x 1500 mm	1	1495KH6BKWB15TD
880 x 750 x 1800 mm	1	1495KH6BKWB18TD
880 x 750 x 1500 mm	1	1495KH6BLWB15TD
880 x 750 x 1800 mm	1	1495KH6BLWB18TD
880 x 750 x 1500 mm	1	1495KH6RDWB15TD
880 x 750 x 1800 mm	1	1495KH6RDWB18TD
880 x 750 x 1500 mm	1	1495KH6WB15TD
880 x 750 x 1800 mm	1	1495KH6WB18TD



Établi usage intensif hauteur basse (880 mm)



**1495KH7WB15TW**

Dimensions (mm)	Quantity	Product Code
880 x 750 x 1500	1	1495KH7BKWB15TW
880 x 750 x 1800	1	1495KH7BKWB18TW
880 x 750 x 1500	1	1495KH7BLWB15TW
880 x 750 x 1800	1	1495KH7BLWB18TW
880 x 750 x 1500	1	1495KH7RDWB15TW
880 x 750 x 1800	1	1495KH7RDWB18TW
880 x 750 x 1500	1	1495KH7WB15TW
880 x 750 x 1800	1	1495KH7WB18TW

Établi usage intensif hauteur basse (880 mm)



**1495KH8WB15TW**

Dimensions (mm)	Quantity	Product Code
880 x 750 x 1500	1	1495KH8BKWB15TW
880 x 750 x 1800	1	1495KH8BKWB18TW
880 x 750 x 1500	1	1495KH8BLWB15TW
880 x 750 x 1800	1	1495KH8BLWB18TW
880 x 750 x 1500	1	1495KH8RDWB15TW
880 x 750 x 1800	1	1495KH8RDWB18TW
880 x 750 x 1500	1	1495KH8WB15TW
880 x 750 x 1800	1	1495KH8WB18TW

Établi usage intensif hauteur basse (880 mm)



**1495KH6WB15TD**

Dimensions (mm)	Quantity	Product Code
880 x 750 x 1500	1	1495KH6BKWB15TD
880 x 750 x 1800	1	1495KH6BKWB18TD

Dimensions (mm)	Quantity	Product Code
880 x 750 x 1500	1	1495KH6BLWB15TW
880 x 750 x 1800	1	1495KH6BLWB18TD
880 x 750 x 1500	1	1495KH6RDWB15TD
880 x 750 x 1800	1	1495KH6RDWB18TD
880 x 750 x 1500	1	1495KH6WB15TD
880 x 750 x 1800	1	1495KH6WB18TD

Établi usage intensif hauteur basse (880 mm)



**1495KH7WB15TD**

Dimensions (mm)	Quantity	Product Code
880 x 750 x 1500	1	1495KH7BKWB15TD
880 x 750 x 1800	1	1495KH7BKWB18TD
880 x 750 x 1500	1	1495KH7BLWB15TD
880 x 750 x 1800	1	1495KH7BLWB18TD
880 x 750 x 1500	1	1495KH7RDWB15TD
880 x 750 x 1800	1	1495KH7RDWB18TD
880 x 750 x 1500	1	1495KH7WB15TD
880 x 750 x 1800	1	1495KH7WB18TD

Établi usage intensif hauteur basse (880 mm)



**1495KH8WB15TD**

Dimensions (mm)	Quantity	Product Code
880 x 750 x 1500	1	1495KH8BKWB15TD
880 x 750 x 1800	1	1495KH8BKWB18TD
880 x 750 x 1500	1	1495KH8BLWB15TD
880 x 750 x 1800	1	1495KH8BLWB18TD
880 x 750 x 1500	1	1495KH8RDWB15TD
880 x 750 x 1800	1	1495KH8RDWB18TD
880 x 750 x 1500	1	1495KH8WB15TD
880 x 750 x 1800	1	1495KH8WB18TD

Kit plateau acier inoxydable



**1495KW-TS**

Dimensions (mm)	Quantity	Product Code
1030 x 750 x 1500	1	1495KWB15TS
1030 x 750 x 1800	1	1495KWB18TS

Kit plateau bois



**1495KWB-TW**

Dimensions (mm)	Quantity	Product Code
1030 x 750 x 1500	1	1495KWB15TW
1030 x 750 x 1800	1	1495KWB18TW

Kit plateau MDF



**1495KWB-TD**

Dimensions (mm)	Quantity	Product Code
1030 x 750 x 1500	1	1495KWB15TD
1030 x 750 x 1800	1	1495KWB18TD

Établi avec plateau acier



**1495WB-TS**



1030 x 750 x 1500 mm	1	1495WB15TSBK
1030 x 750 x 1500 mm	1	1495WB15TSBL
1030 x 750 x 1500 mm	1	1495WB15TSRED
1030 x 750 x 1500 mm	1	1495WB15TS
1030 x 750 x 1800 mm	1	1495WB18TSBK
1030 x 750 x 1800 mm	1	1495WB18TSBL
1030 x 750 x 1800 mm	1	1495WB18TSRED
1030 x 750 x 1800 mm	1	1495WB18TS

Établi usage intensif



**1495WB15TSBT**



1030 x 1500 x 750 mm	1	1495WB15TSBLBT
1030 x 750 x 1500 mm	1	1495WB15TSBT

Établi ultra-résistant, plateau bois 40 mm



**1495WBAH-TW**



810 x 750 x 1500 mm	1	1495WBAH15TW
1030 x 750 x 1800 mm	1	1495WBAH18TW
810 x 750 x 1800 mm	1	1495WBAH18TWGR

Établi d'atelier robuste avec plateau bois



**1495WB-TW**



1030 x 750 x 1500 mm	1	1495WB15TWGR
1030 x 750 x 1500 mm	1	1495WB15TW
1030 x 750 x 1800 mm	1	1495WB18TWGR
1030 x 750 x 1800 mm	1	1495WB18TW

Établi usage intensif



**1495WB18TSBT**



1030 x 750 x 1800 mm	1	1495WB18TSBLBT
1030 x 750 x 1800 mm	1	1495WB18TSBT

Établi d'atelier robuste avec plateau bois



**1495WBAH-TD**



810 x 750 x 1500 mm	1	1495WBAH15TD
810 x 750 x 1800 mm	1	1495WBAH18TD

Établi avec plateau MDF



**1495WB-TD**



1030 x 750 x 1500 mm	1	1495WB15TDGR
1030 x 750 x 1500 mm	1	1495WB15TD
1030 x 750 x 1800 mm	1	1495WB18TDGR
1030 x 750 x 1800 mm	1	1495WB18TD

Établi ultra-résistant, plateau acier 40 mm



**1495WBAH-TS**



810 x 750 x 1500 mm	1	1495WBAH15TS
810 x 750 x 1500 mm	1	1495WBAH15TSBL
810 x 750 x 1800 mm	1	1495WBAH18TS
810 x 750 x 1800 mm	1	1495WBAH18TSBK
810 x 750 x 1800 mm	1	1495WBAH18TSBL
810 x 750 x 1800 mm	1	1495WBAH18TSRED

Établi pliable avec plateau MDF + acier galvanisé



**1495FWBTD**



840 x 510 x 970 mm	1	1495FWB097TD
840 x 510 x 1200 mm	1	1495FWB120TD



Etabli pliable avec plateau en acier galvanisé



### 1495FWBTS

840 x 510 x 970 mm	1	1495FWB097TS
840 x 510 x 1200 mm	1	1495FWB120TS

Plateau inférieur pour établis



### 1495WB1-AC

30 x 504 x 1500 mm	1	1495WB15-AC1
30 x 504 x 1800 mm	1	1495WB18-AC1
30 x 500 x 1500 mm	1	1495WB15-AC1GR
30 x 504 x 1800 mm	1	1495WB18-AC1GR

Tiroir pour établis



### 1495WB-AC

105 x 500 x 500 mm	1	1495WB-AC1
160 x 528 x 570 mm	1	1495WB-AC2

## ARMOIRES ET PANNEAUX

Armoire à rideau



### 1495CS1

900 x 170 x 1500 mm	1	1495CS15BK
900 x 170 x 1500 mm	1	1495CS15BL
900 x 170 x 1500 mm	1	1495CS15RED
900 x 170 x 1800 mm	1	1495CS18BK
900 x 170 x 1800 mm	1	1495CS18BL
900 x 170 x 1800 mm	1	1495CS18RED
900 x 170 x 1500 mm	1	1495CS15
900 x 170 x 1800 mm	1	1495CS18

Armoire avec rideau et crochets



### 1495CS18HK

900 x 170 x 1800 mm	1	1495CS18BLHK
900 x 170 x 1800 mm	1	1495CS18HK

Panneau mural

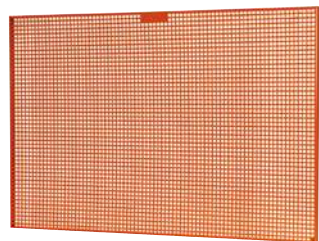

### 1495TP

500 x 25 x 600 mm	1	1495TP06GR
795 x 25 x 1200 mm	1	1495TP12GR
795 x 25 x 1495 mm	1	1495TP15GR
793 x 25 x 1800 mm	1	1495TP18GR
500 x 23 x 600 mm	1	1495TP06
795 x 25 x 1200 mm	1	1495TP12



795 x 23 x 1500 mm	1	1495TP15
795 x 23 x 1800 mm	1	1495TP18

Panneau porte outils vide



### 1495TP09

900 x 25 x 500 mm	1	1495TP09

Panneau sur roues



### 1495TP10W

1500 x 450 x 1000 mm	1	1495TP10W

Armoire murale 2 portes



### 1495CD60

900 x 250 x 602 mm	1	1495CD60BK
900 x 250 x 602 mm	1	1495CD60BL
900 x 250 x 602 mm	1	1495CD60RED
900 x 250 x 602 mm	1	1495CD60



Armoire 2 portes sur roues



**1495CD60W**



1605 x 450 x 625 mm	1	1495CD60W
1605 x 450 x 625 mm	1	1495CD60WBK
1605 x 450 x 625 mm	1	1495CD60WBL
1605 x 450 x 625 mm	1	1495CD60WRED

Kit de crochets - 24 pièces

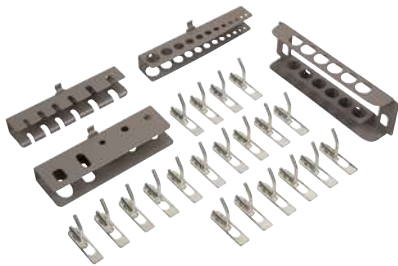

**1495CD-AC1**



1.22 kg	1	1495CD-AC1
---------	---	------------

Kit de crochets - 35 pièces

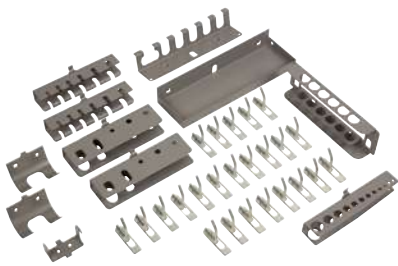

**1495CS-AC1**



2.11 kg	1	1495CS-AC1
---------	---	------------

Adaptateurs pour panneaux et établis



**1495TP-AC1**



9.5 kg	1	1495TP-AC1
--------	---	------------

Porte clés mixtes, 165x42x333mm - 12 emplacements



**1495TP-AC10**



0.43 kg	1	1495TP-AC10
---------	---	-------------

Porte chasse-goupilles 213x30x65mm - 6 trous



**1495TP-AC11**



0.16 kg	1	1495TP-AC11
---------	---	-------------

Porte marteau 70x48x46mm



**1495TP-AC12**



0.07 kg	1	1495TP-AC12
---------	---	-------------

Porte poignée T 56x37x27mm



**1495TP-AC13**



0.04 kg	1	1495TP-AC13
---------	---	-------------

Plateau 238x125x40mm



**1495TP-AC2**



0.44 kg	1	1495TP-AC2
---------	---	------------

Kit crochet et plateau pour douilles 260x80x40mm



**1495TP-AC3**



0.45 kg	1	1495TP-AC3
---------	---	------------

Bac plastique 100x90x50mm



**1495TP-AC4**



0.125 kg	1	1495TP-AC4
----------	---	------------



Porte tournevis 166x30x26mm - 6 trous

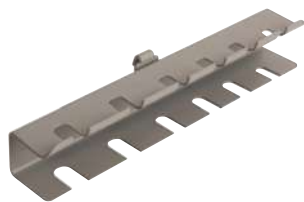

**1495TP-AC5**

kg 0.14 kg 1 1495TP-AC5

Porte pinces 175x55x26mm - 5 trous



**1495TP-AC6**

kg 0.17 kg 1 1495TP-AC6

Porte outils 46x75x36mm



**1495TP-AC7**

kg 0.79 kg 1 1495TP-AC7

Porte clés mâles 180x33x25mm - 12 trous



**1495TP-AC8**

kg 0.12 kg 1 1495TP-AC8

Porte clés tubulaires 74x50x398mm - 12 emplacements



**1495TP-AC9**

kg 0.43 kg 1 1495TP-AC9

Crochets pour armoires et panneaux - 5 pièces



**1495TP-ACH**

kg 0.116 kg 1 1495TP-ACHL20  
 0.125 kg 1 1495TP-ACHL40  
 0.144 kg 1 1495TP-ACHL65  
 0.17 kg 1 1495TP-ACHL90  
 0.102 kg 1 1495TP-ACHU20  
 0.125 kg 1 1495TP-ACHU40  
 0.146 kg 1 1495TP-ACHU65  
 0.162 kg 1 1495TP-ACHU90

## CAISSES À OUTILS MÉTALLIQUES

Caisse métallique 3 tiroirs et plateau supérieur



**1483KHD3RB**

mm 305 x 233 x 523 mm 13050 g 1 1483KHD3RB

Caisse métallique 4 tiroirs et plateau supérieur



**1483KHD4RB**

mm 390 x 260 x 593 mm 15200 g 1 1483KHD4RB

Caisse métallique 2 tiroirs et plateau supérieur



**1483K2RB**

mm 277 x 257 x 525 mm 8200 g 1 1483K2RB

Caisse métallique 3 tiroirs et plateau supérieur



**1483K3RB**

mm 334 x 260 x 523 mm 10200 g 1 1483K3RB

Chariot pour caisses métalliques 1483K







**1483CART**

     
200 x 270 x 655 mm 6.02 kg 1 1483CART

Caisse de chantier 830x440x340 mm







**1496MB4**

     
340 x 440 x 830 mm 80 1 1496MB4

Coffre à outils métallique de maçon







**1497MB13**

     
100 x 230 x 605 mm 30 1 1497MB13

Caisse de chantier 530x290x290 mm







**1496MB2**

     
290 x 290 x 530 mm 40 1 1496MB2

Caisse de chantier 910x530x430 mm







**1496MB5**

     
530 x 530 x 910 mm 150 1 1496MB5

Coffre à outils de maçon







**1497MB18**

     
122 x 270 x 640 mm 30 1 1497MB18

Caisse de chantier 690x360x310 mm







**1496MB3**

     
310 x 360 x 690 mm 60 1 1496MB3

Coffre à outils de maçon



**1497MB08**

     
100x170x573 30 1 1497MB08

Caisse à outils 5 compartiments



**3149-OR**

     
200 x 220 x 530 mm 4370 1 3149-OR



### Caisse à outils



#### 9601

mm	g	Icon 1	Icon 2
190 x 210 x 300 mm	2450	1	960100010
190 x 210 x 400 mm	3400	1	960100020
190 x 210 x 500 mm	3670	1	960100030
245 x 210 x 400 mm	4400	1	960100050
245 x 210 x 500 mm	4840	1	960100060

### Caisse à outils 3 compartiments

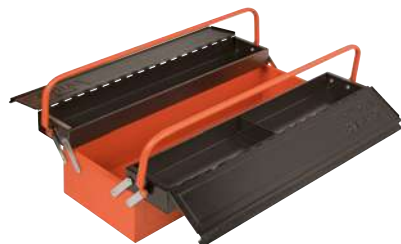

#### 1497MBF350

mm	g	Icon 1	Icon 2
160 x 200 x 530 mm	10	1	1497MBF350

### Caisse à outils 5 compartiments



#### 1497MBF550

mm	g	Icon 1	Icon 2
200 x 200 x 530 mm	12	1	1497MBF550

### Caisse à outils 7 compartiments



#### 1497MBF750

mm	g	Icon 1	Icon 2
250 x 200 x 530 mm	15	1	1497MBF750

### Caisse à outils sur roues



#### 1497MBW

mm	g	Icon 1	Icon 2
637 x 400 x 1203 mm	250	1	1497MBW

## SACS TEXTILE ET CUIR

### Sac à dos pour électriciens



#### 4750FB8

mm	g	Icon 1	Icon 2
560 x 190 x 335 mm	4	4	4750FB8

### Sac à outils



#### 3100TB

mm	g	Icon 1	Icon 2
345 x 240 x 485 mm	1	1	3100TB

### Sac ouvert 19"



#### 4750FB1-19A

mm	g	Icon 1	Icon 2
355 x 230 x 470 mm	1	1	4750FB1-19A

### Sac 19" ouvert avec option de rabat



#### 4750FB1-19B

mm	g	Icon 1	Icon 2
365 x 225 x 480 mm	4	4	4750FB1-19B

Sac 19" fermé standard



**4750FB2-19A**



370 x 230 x 470 mm



4 4750FB2-19A

Sac électricien 12"



**4750FB3-12**



285 x 190 x 285 mm



1 4750FB3-12

Présentoir de 9 sacs



**3100TB-DISP**



300 x 555 x 715 mm



1 3100TB-DISP

Sac 24" fermé standard



**4750FB2-24A**



380 x 260 x 600 mm



2 4750FB2-24A

Sac 18" porte-documents, ordinateur et outils



**4750FB4-18**



350 x 150 x 430 mm



4 4750FB4-18

Pochette en tissus porte



**4750-SF-1**



0,96



55 x 220 x 485 mm



1 4750-SF-1

Sac 24" sur roulettes



**4750FB2W-24A**



385 x 325 x 665 mm



1 4750FB2W-24A

Sac pour jeu de niveaux 416-SET-1



**4750-LV-1**



85 x 43 x 1800 mm



1 4750-LV-1

51 x 43 x 1800 mm

1 4750-LV-2

Pochette en tissus porte douilles



**4750-SF-2**



0,96



60 x 265 x 485 mm



1 4750-SF-2



Pochette



**4750FB5A**



50 x 168 x 273 mm



1 4750FB5A

Pochette porte outils compatible avec 1 module mousse 1/3 Fit&Go



**4750FB5-FG1**



65 x 210 x 470 mm



1 4750FB5-FG1

Malette à outils forme tube



**4750-TOCST-1**



220 x 170 x 495 mm



1 4750-TOCST-1

Pochette



**4750FB5B**



62 x 275 x 330 mm



1 4750FB5B

Pochette porte outils compatible avec 2 modules mousse 1/3 Fit&Go



**4750FB5-FG2**



90 x 210 x 470 mm



1 4750FB5-FG2

Malette électricien en cuir



**4750-VDEC**



290 x 190 x 445 mm



1 4750-VDEC

Pochette



**4750FB5C**



80 x 305 x 403 mm



8 4750FB5C

Malette à outils en cuir



**4750-FOLTC-1**



290 x 195 x 440 mm



1 4750-FOLTC-1

Pack de 3 petites pochettes de rangement 145 mm



**4750FB7-01**



135 x 10 x 215 mm



60 4750FB7-01

Pack de 3 grandes pochettes de rangement 145 mm



**4750FB7-02**



205 x 10 x 310 mm



60 4750FB7-02

Ceinture matelassée spéciale charge lourde avec rivet



**4750-HDB-2**



190 x 50 x 900 mm



1 4750-HDB-2

Ceinture de maintien en cuir pour charges lourdes



**4750-HDLB**



47 x 4 x 1380 mm



1 4750-HDLB-1

Petite pochette de rangement à fermeture éclair orange



**4750FB7ORLT**



135 x 10 x 215 mm



120 4750FB7ORLT

Ceinture en cuir résistant



**4750-HDBS-2**



330 x 170 x 900 mm



1 4750-HDBS-2

Porte-outils avec 2 poches pour chutes



**4750-2PP**



285 x 130 x 265 mm



1 4750-2PP-1

Grande pochette de rangement à fermeture éclair orange



**4750FB7ORBG**



205 x 10 x 310 mm



120 4750FB7ORBG

Ceinture réglable à attache rapide



**4750-QRFB-1**



50 x 4 x 1180 mm



1 4750-QRFB-1

Porte-outils universel



**4750-UP**



302 x 140 x 250 mm



1 4750-UP-1

Ceinture porte-outils trois poches



**4750-3PB**



234 x 105 x 570 mm



1 4750-3PB-1

Ceinture enfant à 3 mini sacoches



**4750-JU3PB**



125 x 55 x 395 mm



1 4750-JU3PB-1



Étui pour perceuse pour droitier et gaucher



**4750-DHO-3**

 320 x 73 x 175 mm   1 4750-DHO-3

Porte-outils pour électriciens



**4750-EP**

 345 x 120 x 260 mm   1 4750-EP-1

Porte-outils multi-fonctions



**4750-MPH-1**

 240 x 50 x 155 mm   1 4750-MPH-1

Étui pour cutter lame rétractable



**4750-KNHO-1**

 205 x 35 x 105 mm   1 4750-KNHO-1

Etui pour cutter gamme Ergo™



**4750-KNHO-0**

 200 x 10 x 85 mm   1 4750-KNHO-0

Pochette verticale pour téléphone portable



**4750-VMPPH-1**

 170 x 35 x 100 mm   1 4750-VMPPH-1

Housse de rangement pour outils



**4750-ROCO-1**

 320 x 5 x 370 mm   1 4750-ROCO-1

Protections genoux



**4750-KP**

 210 x 50 x 175 mm   1 4750-KP-1

Étui de sécateur en cuir noir



**PROF-TL**

 30 x 90 x 245 mm   4 PROF-TL

Bretelles avec clips



**4750-BWC-1**

 750 x 20 x 105 mm   1 4750-BWC-1



## BOÎTES ET CAISSES EN PLASTIQUE

Caisse à outils plastique capacité 27 litres



### 4750PTB50



27

27

3 4750PTB50

Caisse à outils plastique capacité 37 litres



### 4750PTB60



37

37

3 4750PTB60

Caisse à outils plastique capacité 60 litres



### 4750PTBW47



60

25

1 4750PTBW47

Boite à outils à usage intensif



### 4750PTB65



285 x 300 x 650 mm

2 4750PTB65

Caisses moulées



### 4750BMC

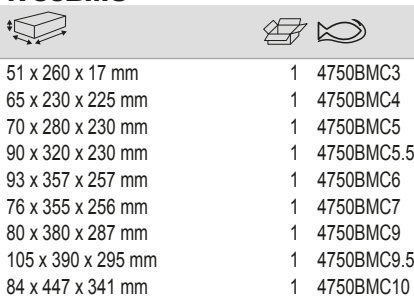

51 x 260 x 17 mm

1 4750BMC3

65 x 230 x 225 mm

1 4750BMC4

70 x 280 x 230 mm

1 4750BMC5

90 x 320 x 230 mm

1 4750BMC5.5

93 x 357 x 257 mm

1 4750BMC6

76 x 355 x 256 mm

1 4750BMC7

80 x 380 x 287 mm

1 4750BMC9

105 x 390 x 295 mm

1 4750BMC9.5

84 x 447 x 341 mm

1 4750BMC10

## JEUX D'OUTILS

Valise d'outillage



### 2010

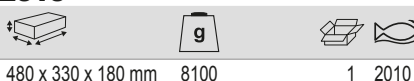

480 x 330 x 180 mm

8100

1 2010

1952M-6, 1952M-7, 1952M-8, 1952M-9, 1952M-10, 1952M-11, 1952M-12, 1952M-13, 1952M-14	
4020L-M-3, 4020L-M-3.2, 4020L-M-3.5, 4020L-M-4, 4020L-M-4.5, 4020L-M-5.5	
BE-8340, BE-8350, BE-8355	
700-1.5-50, 700-1.2-50, 700-1-50, 700-1.8-50	
3659/8T	
5550-3.2	
BE-8220S, BE-8050S	
5516 I	
5577-145	
5418	
2535L	
3524	
2648	
1150-1/2H/P	
1952Z-1/4, 1952Z-3/8, 1952Z-1/2	
BE-8620S	
BE-7845, BE-7806	
701-0-50, 701-00-50	
5550-4.5	
8045LVDE	
5574-145	
6x 2-470-16-1-0	
5515GV	
5423	
326000300	
328000000	
2656 R	
BE-3529	
BE-6400M-4, BE-6400M-5, BE-6400M-5.5, BE-6400M-7	
BE-8160	
BE-8255S	
BE-8600, BE-8610	
1995LM-1.5, 1995LM-2, 1995LM-2.5, 1995LM-3, 1995LM-4	
1997M/10T	
2047-0.8-4, 2047-1-5.5	
2421 D-140IP	
2430 GC-200 IP	
2530-40	
2744	
4750RC021	
7372I-2.5-75	
8070 C	
2223 S-150	



Coffret de maintenance spécial électricien  
28 outils



**3049-2**

180 x 435 x 270 mm	1	3049-2

268	
5470-140	
111M-7, 111M-8, 111M-10, 111M-13	
2744	
2427 S-200	1000V EC9999
8045LVDE	1000V EC9999
BE-9765	
2705R	
481-300	
9072 P	
2628 S-180	1000V EC9999
2101S-160	1000V EC9999
BE-8820S	
BE-8220S, BE-8040S, BE-8050S	
BE-8610S, BE-8620S	
BE-8255S	
B146.006.100	
4750-FOLTC-1	

Composition de 16 outils pour électricien  
Dans une mallette en cuir



**982000170**

290 x 195 x 440 mm	1	982000170

4750-FOLTC-1	
2101GC-160IP	
2800 N	
2630GC-160IP	
2421GC-160	
2521GC-160	
8071 C IP	
B196.065.150, B196.055.125, B196.030.100, B196.040.100	
B197.002.100, B197.001.080	
SC127	
2820EF2	
MTB-3-16	
6224	

Sac 4750FB4-18 avec 32 outils



**4750FB4-18TS001**

450 mm	190	1 4750FB4-18TS001

4750FB4-18	
2101G-160	
2628 G-180	
2430 G-160	
1RM/SH8	
7223	
2233 D-200	
SL25	
9070	
9031	
483-20	
BE-8020, BE-8040	
BE-8150, BE-8155	
BE-8610, BE-8620	
SC127	
SQZ150003	
BE-9777	
MTB-5-25	

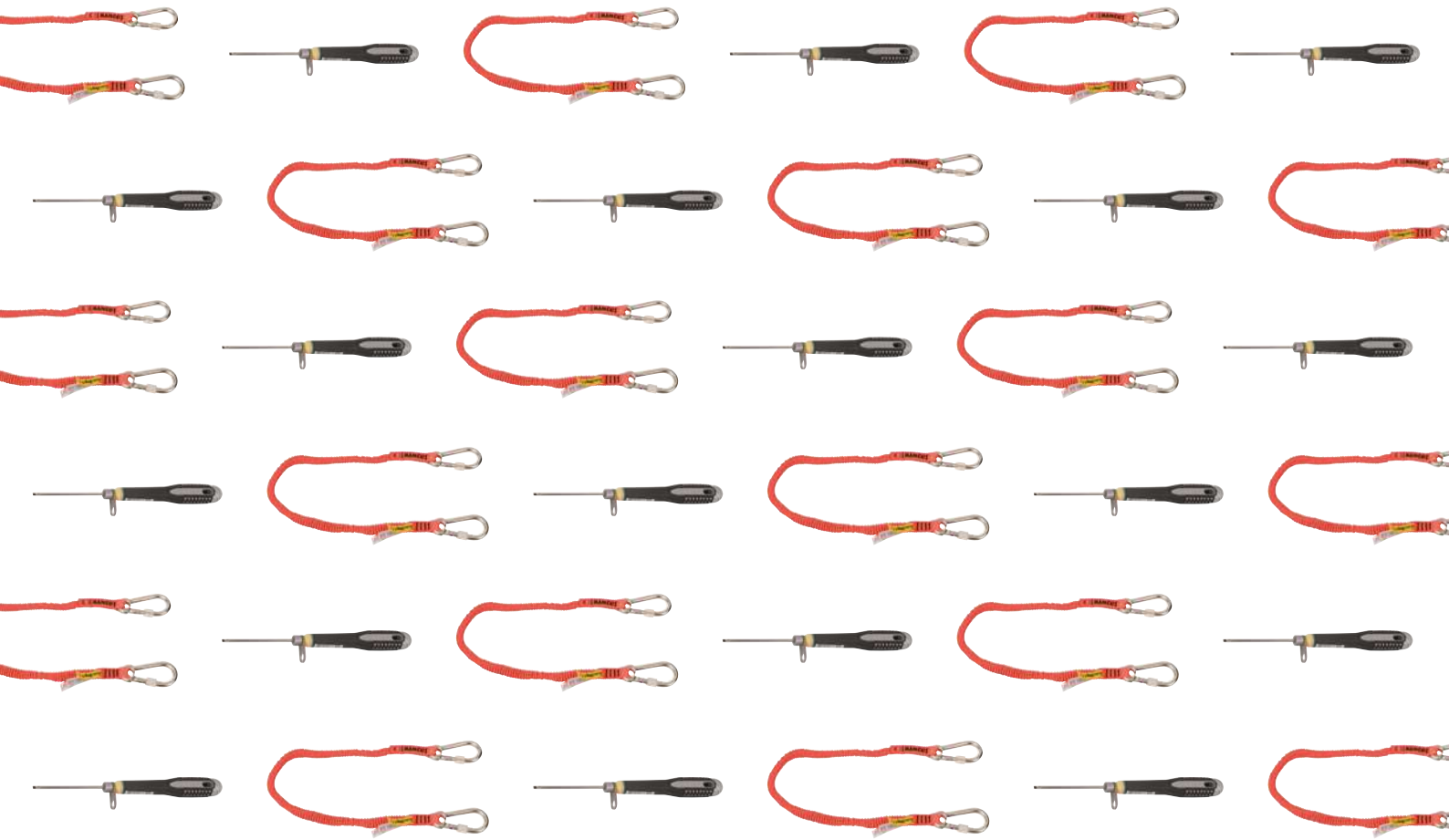

## Équipement de sécurité



## SYSTÈMES DE RANGEMENT ET LONGES

Longe supportant jusqu'à 1 Kg avec mousquetons pivotants. Selon les normes définies par le procédé de prévention de chute d'objets DROPS



**3875-LY6**

g

135



1 3875-LY60



Connecteur pour longues 3875-LY3 ou 3875-WL1



**3875-QL1**

g

40



8 3875-QL1

Longe supportant jusqu'à 3 Kg (3 daN) avec mousquetons fixes. Selon les normes définies par le procédé de prévention de chute d'objets DROPS



**3875-LY7**

g

172



1 3875-LY70



Longe courte supportant jusqu'à 1 Kg avec mousquetons fixes. Selon les normes définies par le procédé de prévention de chute d'objets DROPS



**3875-LY9**

g

90



1 3875-LY9



Longe rétractable supportant jusqu'à 1 Kg



**3875-RL1**

g

200



1 3875-RL1

Longe supportant jusqu'à 3 Kg avec mousquetons non détachables avec système de verrouillage



**3875-LY4**

g

180



8 3875-LY4



Longe supportant jusqu'à 1 Kg avec boucle amovible



**3875-LY3**

g

125



8 3875-LY3

Connecteur pour longe 3875-RL1



**3875-QRL1**

g

40



1 3875-QRL1

Longe 2 mousquetons (3daN)



**3875-LY1**

g

170



8 3875-LY1

Longe cordon poignet supportant jusqu'à 1 Kg



**3875-WL1**

g

40



8 3875-WL1

Longe rétractable supportant jusqu'à 1 Kg avec mousquetons fixes



**3875-RL2**

g

212



1 3875-RL2

Longe 1 mousqueton 1 boucle de serrage fixe



**3875-LY2**

g

120



8 3875-LY2



Longe supportant jusqu'à 6 Kg avec mousquetons fixes. Selon les normes définies par le procédé de prévention de chute d'objets DROPS



**3875-LY8**



330

1 3875-LY8

Longe supportant jusqu'à 12 Kg avec mousquetons fixes. Selon les normes définies par le procédé de prévention de chute d'objets DROPS



**3875-LY10**



270

1 3875-LY10

Cordon ressort 2m



**439000000**



100

1 439000000

Longe spirale 1,7 m



**439000001**



130

1 439000001

Longe spirale supportant jusqu'à 2 Kg avec mousquetons pivotants. Selon les normes définies par le procédé de prévention de chute d'objets DROPS



**439000002**



130

1 439000002

Longe spirale supportant jusqu'à 3 Kg avec mousquetons pivotants. Selon les normes définies par le procédé de prévention de chute d'objets DROPS



**439000003**



160

1 439000003

Longe orange haute visibilité avec clip en plastique



**439000004**



13

1 439000004

Sac de levage pour le travail en hauteur de 10 litres - Charge maxi : 1 kg



**3875-HB10**



260 x 130 x 130 mm

1 3875-HB10

Sacs de levage de 30 et 60 litres  
Selon les normes définies par le procédé de prévention de chute d'objets DROPS



**3875-HB30/3875-HB60**



270 x 270 x 350 mm

1 3875-HB30

350 x 350 x 640 mm

1 3875-HB60

Sacs de levage de 100 litres  
Selon les normes définies par le procédé de prévention de chute d'objets DROPS



**3875-HB100**



400 x 400 x 900 mm

1 3875-HB100



Sac de levage pour caisses rigides  
Selon les normes définies par le procédé de  
prévention de chute d'objets DROPS



**3875-SB70**



730 x 300 x 500 mm



1 3875-SB70

Pochette avec 4 anneaux de sécurité pour attacher les  
longes. Selon les normes définies par le procédé de  
prévention de chute d'objets DROPS



**3875-MHP4**



70 x 200 x 400 mm



1 3875-MHP4

Etui pour perceuse  
Selon les normes définies par le procédé de  
prévention de chute d'objets DROPS



**4750-DHO-4**



300 x 150 x 270 mm



1 4750-DHO-4

Petit sac à dos  
Selon les normes définies par le procédé de  
prévention de chute d'objets DROPS



**3875-BP1**



100 x 300 x 400 mm



8 3875-BP1

Pochette avec 6 anneaux de sécurité pour attacher les  
longes. Selon les normes définies par le procédé de  
prévention de chute d'objets DROPS



**MHP6**



10 x 200 x 380 mm



1 3875-MHP6

Pochette pour mètres de 5 et 8 mètres  
Selon les normes définies par le procédé de  
prévention de chute d'objets DROPS



**MTHO-TAH**



70 x 105 x 230 mm



1 4750-MTHO-TAH

Grand sac à dos  
Selon les normes définies par le procédé de  
prévention de chute d'objets DROPS



**3875-BP2**



210 x 330 x 450 mm



8 3875-BP2

Ceinture porte-outils 3 poches  
Selon les normes définies par le procédé de  
prévention de chute d'objets DROPS



**4750-3PB-2**



100 x 380 x 630 mm



1 4750-3PB-2

Pochette multi outils  
Selon les normes définies par le procédé de  
prévention de chute d'objets DROPS



**4750-UP-2**



300 x 150 x 300 mm



1 4750-UP-2

Porte marteaux  
Selon les normes définies par le procédé de prévention de chute d'objets DROPS



### 4750-HHO-2

120 x 70 x 180 mm	1 4750-HHO-2

Ceinture de maintien pour charges lourdes  
Selon les normes définies par le procédé de prévention de chute d'objets DROPS



### 4750-HDLB-TAH

50 x 120 x 460 mm	1 4750-HDLB-TAH

## CLÉS

Clé à molette série 90 avec mousqueton de sécurité  
Selon les normes définies par le procédé de prévention de chute d'objets DROPS

ergo®



### TAH90

158mm/6"	20	1	TAH9070
250mm/10"	31	1	TAH9072

Clé à molette série 80 équipée d'un mousqueton  
Selon les normes définies par le procédé de prévention de chute d'objets DROPS



### TAH80

110mm/4"	13	1	TAH8069
155mm/6"	20	1	TAH8070
205mm/8"	27	1	TAH8071
255mm/10"	31	1	TAH8072
305mm/12"	34	1	TAH8073
380mm/15"	44	1	TAH8074
460mm/18"	53	1	TAH8075
110mm/4"	13	1	TAH8069C
155mm/6"	20	1	TAH8070C
205mm/8"	27	1	TAH8071C
255mm/10"	31	1	TAH8072C
305mm/12"	34	1	TAH8073C
380mm/15"	44	1	TAH8074C
460mm/18"	53	1	TAH8075C

Clé à molette à embout fuselé avec pièce de sécurité  
Pour le travail en hauteur



### TAH84

405mm/16"	41	1	TAH84-PODGER

Clé mixte avec anneau de sécurité  
Pour le travail en hauteur



### TAH111M

6 mm	112	1	TAH111M-6
7 mm	120	1	TAH111M-7
8 mm	130	1	TAH111M-8
9 mm	136	1	TAH111M-9
10 mm	144	1	TAH111M-10
11 mm	153	1	TAH111M-11
12 mm	160	1	TAH111M-12
13 mm	165	1	TAH111M-13
14 mm	177	1	TAH111M-14
15 mm	185	1	TAH111M-15
16 mm	195	1	TAH111M-16
17 mm	200	1	TAH111M-17

18 mm	208	1	TAH111M-18
19 mm	215	1	TAH111M-19
20 mm	240	1	TAH111M-20
21 mm	250	1	TAH111M-21
22 mm	250	1	TAH111M-22
23 mm	270	1	TAH111M-23
24 mm	270	1	TAH111M-24
25 mm	290	1	TAH111M-25
27 mm	310	1	TAH111M-27
30 mm	330	1	TAH111M-30
32 mm	345	1	TAH111M-32
34 mm	347	1	TAH111M-34
36 mm	400	1	TAH111M-36
41 mm	438	1	TAH111M-41
46 mm	500	1	TAH111M-46
50 mm	540	1	TAH111M-50
55 mm	560	1	TAH111M-55
85 mm	780	1	TAH111M-85

Clé mixte coudée en pouces avec ressort de sécurité



### TAH111Z

1/4 in	112	1	TAH111Z-1/4
5/16 in	130	1	TAH111Z-5/16
3/8 in	140	1	TAH111Z-3/8
7/16 in	153	1	TAH111Z-7/16
1/2 in	169	1	TAH111Z-1/2
9/16 in	177	1	TAH111Z-9/16
5/8 mm	195	1	TAH111Z-5/8
11/16 mm	200	1	TAH111Z-11/16
3/4 in	218	1	TAH111Z-3/4
13/16 mm	250	1	TAH111Z-13/16
7/8 mm	250	1	TAH111Z-7/8
15/16 mm	270	1	TAH111Z-15/16
1 in	290	1	TAH111Z-1
1-1/16 mm	310	1	TAH111Z-1.1/16
1-1/8 mm	310	1	TAH111Z-1.1/8
1-1/4 mm	350	1	TAH111Z-1.1/4
1-5/16 mm	350	1	TAH111Z-1.5/16
1 3/8 in	410	1	TAH111Z-1.3/8
1 7/16 in	410	1	TAH111Z-1.7/16
1 1/2 in	410	1	TAH111Z-1.1/2
1 5/8 in	460	1	TAH111Z-1.5/8
1 11/16 in	460	1	TAH111Z-1.11/16
1 3/4 in	500	1	TAH111Z-1.3/4
1 13/16 in	500	1	TAH111Z-1.13/16
1 7/8 in	540	1	TAH111Z-1.7/8
2 in	540	1	TAH111Z-2
2 1/8 in	560	1	TAH111Z-2.1/8
2 1/4 in	600	1	TAH111Z-2.1/4
2 3/8 in	600	1	TAH111Z-2.3/8
2 1/2 in	680	1	TAH111Z-2.1/2
2 5/8 in	680	1	TAH111Z-2.5/8
2 3/4 in	680	1	TAH111Z-2.3/4
2 7/8 in	730	1	TAH111Z-2.7/8
3 in	730	1	TAH111Z-3



Clé mixte à cliquet avec ressort de sécurité  
Selon les normes définies par le procédé de  
prévention de chute d'objets DROPS



### TAH1RM

Ø	L		
6 mm	128	1	TAH1RM-6
7 mm	140	1	TAH1RM-7
8 mm	140	1	TAH1RM-8
9 mm	150	1	TAH1RM-9
10 mm	159	1	TAH1RM-10
11 mm	165	1	TAH1RM-11
12 mm	172	1	TAH1RM-12
13 in	178	1	TAH1RM-13
14 in	191	1	TAH1RM-14
15 in	200	1	TAH1RM-15
16 in	208	1	TAH1RM-16
17 mm	226	1	TAH1RM-17
18 in	237	1	TAH1RM-18
19 mm	248	1	TAH1RM-19
21 in	290	1	TAH1RM-21
22 in	361	1	TAH1RM-22
24 mm	323	1	TAH1RM-24
27 in	359	1	TAH1RM-27
30 mm	400	1	TAH1RM-30
32 in	425	1	TAH1RM-32

Clé polygonale double longue, coudée, métrique,  
finition chromée avec ressort de sécurité



### TAH2M

Ø	L		
6x7 mm	165	1	TAH2M-6-7
8x9 mm	180	1	TAH2M-8-9
10x11 mm	190	1	TAH2M-10-11
12x13 mm	210	1	TAH2M-12-13
14x15 mm	226	1	TAH2M-14-15
16x17 mm	246	1	TAH2M-16-17
18x19 mm	266	1	TAH2M-18-19

Clé à fourche double, métrique, avec ressort de  
sécurité. Selon les normes définies par le procédé de  
prévention de chute d'objets DROPS



### TAH6M

Ø	L		
6x7 in	122	1	TAH6M-6-7
8x9 mm	135	1	TAH6M-8-9
10x11 mm	153	1	TAH6M-10-11
12x13 mm	164	1	TAH6M-12-13
14x15 mm	183	1	TAH6M-14-15
16x17 mm	201	1	TAH6M-16-17
17x19 mm	222	1	TAH6M-17-19
18x19 mm	222	1	TAH6M-18-19
20x22 mm	225	1	TAH6M-20-22
24x27 mm	260	1	TAH6M-24-27
30x32 mm	300	1	TAH6M-30-32

Clé polygonale à tuyauter, métrique avec anneau de  
sécurité  
Pour le travail en hauteur



### TAH1949M

Ø	L		
8x9 mm	140	1	TAH1949M-8-9
10x11 mm	150	1	TAH1949M-10-11
12x14 mm	170	1	TAH1949M-12-14
14x17 mm	200	1	TAH1949M-14-17
19x22 mm	220	1	TAH1949M-19-22
24x27 mm	255	1	TAH1949M-24-27

Clé polygonale à frapper équipée d'une pièce de  
sécurité  
Pour le travail en hauteur



### TAH7444SG

Ø	L		
36 mm	205	1	TAH7444SG-M-36
41 mm	230	1	TAH7444SG-M-41
46 mm	240	1	TAH7444SG-M-46

Ø	L		
50 mm	255	1	TAH7444SG-M-50
55 mm	270	1	TAH7444SG-M-55

Clés à pipe doubles débouchées coudées, dimensions  
métriques, avec profil Dynamic-Drive™ 6 x 6 pans,  
avec anneau en acier inoxydable



### TAH29

Ø		
12 mm	1	TAH29M-12
6 mm	1	TAH29M-6
7 mm	1	TAH29M-7
8 mm	1	TAH29M-8
10 mm	1	TAH29M-10
9 mm	1	TAH29M-9
11 mm	1	TAH29M-11
13 mm	1	TAH29M-13
14 mm	1	TAH29M-14
15 mm	1	TAH29M-15
16 mm	1	TAH29M-16
17 mm	1	TAH29M-17
18 mm	1	TAH29M-18
19 mm	1	TAH29M-19
20 mm	1	TAH29M-20
21 mm	1	TAH29M-21
22 mm	1	TAH29M-22
23 mm	1	TAH29M-23
24 mm	1	TAH29M-24
25 mm	1	TAH29M-25
26 mm	1	TAH29M-26
27 mm	1	TAH29M-27
28 mm	1	TAH29M-28
29 mm	1	TAH29M-29
30 mm	1	TAH29M-30
32 mm	1	TAH29M-32

Clé en croix multi-empreintes 5 en 1 équipée d'un  
cordon Dyneema  
Pour le travail en hauteur



### TAHMK5

L		
97x25 mm	1	TAHMK5



## CLÉS SERRE-TUBES

Clé serre-tubes modèle suédois équipée d'un câble de sécurité  
Pour le travail en hauteur

ergo®



### TAH1410-TAH1420



L	max		
320	1 in	1	TAH1410
430	1 1/2 in	1	TAH1420

Clé à molette suédoise, 90 degrés équipée d'un arc manille sur le manche  
Pour le travail en hauteur



### TAH14



L	max		
210	3/4 in	1	TAH140
320	1 in	1	TAH141
426	1 1/2 in	1	TAH142
557	2-1/2 in	1	TAH143

Clé à crémaillère en aluminium avec mousqueton de sécurité  
Pour le travail en hauteur



### TAH380



L	max		
253	1.1/2 in	1	TAH380-10
354	2 in	1	TAH380-14
455	2.1/2 in	1	TAH380-18
607	3 in	1	TAH380-24

## DOUILLES ET CLIQUETS

Douilles standard 1/4", équipées de 4 trous de suspension  
Pour le travail en hauteur - 4 trous de suspension



### TAH08



Size		
5.5 mm	1	TAH08-5.5
6 mm	1	TAH08-6
7 mm	1	TAH08-7
8 mm	1	TAH08-8
9 mm	1	TAH08-9
10 mm	1	TAH08-10
11 mm	1	TAH08-11
12 mm	1	TAH08-12
13 mm	1	TAH08-13

Poignée articulée 1/4" avec ressort de sécurité  
Pour le travail en hauteur - Ressort de sécurité



### TAH6958B-1



L	
150 mm	1 TAH6958B-1

Rallonges 1/4" équipées de 4 trous de suspension  
S'adapte au travail en hauteur - 4 trous de suspension - goujon de sécurité



### TAH6960-TAH6962L



L		
50 mm	1	TAH6960
101 mm	1	TAH6961
152 mm	1	TAH6962
355 mm	1	TAH6962L

Cardan universel 1/4" équipé de 4 trous de suspension  
S'adapte au travail en hauteur - 4 trous de suspension - goujon de sécurité



### TAH6966



L	
36 mm	1 TAH6966

Douilles 1/4" pour vis 6 pans équipées de la solution 4 points  
Pour le travail en hauteur - 4 trous de suspension



### TAH08-H



Size		
3 mm	1	TAH08-H3
4 mm	1	TAH08-H4
5 mm	1	TAH08-H5
6 mm	1	TAH08-H6
8 mm	1	TAH08-H8

Douille carré 1/4", pour embouts phillips équipée de la solution 4 trous  
Pour le travail en hauteur - Système 4 trous



### TAH08-PH



Size		
1	1	TAH08-PH1
2	1	TAH08-PH2
3	1	TAH08-PH3



Douille carré 1/4" pour embouts TORX® équipée de la solution 4 points  
Pour le travail en hauteur - Système 4 points



### TAH08-T



Code	Quantité	Modèle
T-8	1	TAH08-T8
T-9	1	TAH08-T9
T-10	1	TAH08-T10
T-15	1	TAH08-T15
T-20	1	TAH08-T20
T-25	1	TAH08-T25
T-27	1	TAH08-T27
T-30	1	TAH08-T30
T-40	1	TAH08-T40

Cliquet 1/4", 72 dents / angle d'action 5°, équipé d'un cordon Dyneema. Selon les normes définies par le procédé de prévention de chute d'objets DROPS



### TAH6950



Code	Quantité	Modèle
TAH6950	1	TAH6950

Rallonge 1/4" avec manche équipé d'un anneau de sécurité  
Pour le travail en hauteur - Goujon de sécurité



### TAH6956-1



Code	Quantité	Modèle
TAH6956-1	1	TAH6956-1

Douilles standards, carré 1/2" équipées de 4 trous de suspension  
Pour le travail en hauteur - 4 trous de suspension



### TAH16B



Code	Quantité	Modèle
8 mm	1	TAH16B-8
10 mm	1	TAH16B-10
11 mm	1	TAH16B-11
12 mm	1	TAH16B-12
13 mm	1	TAH16B-13
14 mm	1	TAH16B-14
15 mm	1	TAH16B-15
16 mm	1	TAH16B-16
17 mm	1	TAH16B-17
18 mm	1	TAH16B-18
19 mm	1	TAH16B-19
21 mm	1	TAH16B-21
22 mm	1	TAH16B-22
24 mm	1	TAH16B-24
25 mm	1	TAH16B-25
27 mm	1	TAH16B-27
30 mm	1	TAH16B-30
32 mm	1	TAH16B-32

Douilles standards carré 1/2" équipées de 4 trous de suspension  
Pour le travail en hauteur - 4 trous de suspension



### TAH16B



Code	Quantité	Modèle
1/2 in	1	TAH16B-1/2
9/16 in	1	TAH16B-9/16
5/8 in	1	TAH16B-5/8
11/16 in	1	TAH16B-11/16
3/4 in	1	TAH16B-3/4
13/16 in	1	TAH16B-13/16
7/8 in	1	TAH16B-7/8
15/16 in	1	TAH16B-15/16
1 in	1	TAH16B-1
1 1/16 in	1	TAH16B-1.1/16
1 1/8 in	1	TAH16B-1.1/8
1 1/4 in	1	TAH16B-1.1/4

Poignée articulée 1/2" équipée d'un ressort de sécurité  
Pour le travail en hauteur - Ressort de sécurité



### TAH8158B-1



Code	Quantité	Modèle
TAH8158B-1	1	TAH8158B-1

Rallonges 1/2" équipées de 4 trous  
Pour le travail en hauteur - Système 4 trous



### TAH8160-8162



Code	Quantité	Modèle
TAH8160	1	TAH8160
TAH8162	1	TAH8162

Cardan universel 1/2" avec anneau de sécurité  
Pour le travail en hauteur - Système 4 trous



### TAH8166



Code	Quantité	Modèle
TAH8166	1	TAH8166



Douilles carré 1/2" pour vis 12 pans équipées de 4 trous de suspension  
Pour le travail en hauteur - 4 trous de suspension



### TAH16-H





Code	Quantité	Modèle
TAH16-H4	1	TAH16-H4
TAH16-H5	1	TAH16-H5

  	
6	1 TAH16-H6
7	1 TAH16-H7
8	1 TAH16-H8
10	1 TAH16-H10
12	1 TAH16-H12
14	1 TAH16-H14
17	1 TAH16-H17
19	1 TAH16-H19

Douilles carré 1/2" pour vis 12 pans équipées de 4 trous de suspension  
Pour le travail en hauteur - 4 trous de suspension





### TAH16H

  	
1/4	1 TAH16H-1/4
5/16	1 TAH16H-5/16
3/8	1 TAH16H-3/8
7/16	1 TAH16H-7/16
1/2	1 TAH16H-1/2
9/16	1 TAH16H-9/16
5/8	1 TAH16H-5/8

Douille carré 1/2" pour embouts TORX® équipée de la solution 4 points  
Pour le travail en hauteur - Système 4 points



### TAH16-T

  	
T30	1 TAH16-T30
T40	1 TAH16-T40
T45	1 TAH16-T45
T50	1 TAH16-T50
T55	1 TAH16-T55
T60	1 TAH16-T60

Cliquet réversible 1/2" - 80 dents, étanche, angle de débattement 4.5°, équipé d'un cordon Dyneema. Selon les normes définies par le procédé de prévention de chute d'objets DROPS



### TAH8150-1/2

  	
270 mm	1 TAH8150-1/2

Coffret de douilles métriques et accessoires 1/2" adapté pour le travail en hauteur - 22 pièces



### TAH16BM/22

  	
85 x 350 x 445 mm	1 TAH16BM/22

Coffret de douilles et accessoires en pouces 1/2" adapté pour le travail en hauteur - 17 pièces





### TAH16BZ/17

  	
80 x 300 x 380 mm	1 TAH16BZ/17

Douilles standard 3/4" équipées de 4 trous de suspension  
Pour le travail en hauteur - 4 trous de suspension







### TAH24B

  	
27 mm	1 TAH24B-27
30 mm	1 TAH24B-30
32 mm	1 TAH24B-32
36 mm	1 TAH24B-36
38 mm	1 TAH24B-38
41 mm	1 TAH24B-41
46 mm	1 TAH24B-46
50 mm	1 TAH24B-50

Clé à cliquet équipée d'une bague de sécurité pour les clés de 13 à 22 mm et d'un arc manille pour les clés de 27 à 30 mm. Pour le travail en hauteur



### TAHSC2RM

   		
13-17 mm	280	1 TAHSC2RM-13-17
15-17 mm	280	1 TAHSC2RM-15-17
19-22 mm	310	1 TAHSC2RM-19-22
27-30 mm	450	1 TAHSC2RM-27-30

Rallonges 3/4" équipées de 4 trous de suspension  
Pour le travail en hauteur - 4 trous de suspension



### TAH8961

  	
200 mm	1 TAH8961



Poignée universelle 3/4" avec câble de sécurité  
Pour le travail en hauteur



**TAH8953**

500 mm		1	TAH8953

Cliquet réversible 3/4" équipé d'un anneau de sécurité  
Selon les normes définies par le procédé de prévention de chute d'objets DROPS



**TAH8950N/A**

170 mm		1	TAH8950N/A

## TOURNEVIS

Tournevis pour vis à fente avec manche de précision  
0,18-0,8 mm et anneau de sécurité en acier inoxydable



**TAH700**

1.5 mm	137	1	TAH700-1.5-50
1.8 mm	137	1	TAH700-1.8-50
2.5 mm	137	1	TAH700-2.5-50
3 mm	187	1	TAH700-3-100

Tournevis Ergo™ pour vis à fente avec mandrin de sécurité.  
Selon les normes définies par le procédé de prévention de chute d'objets DROPS

**ergo**



**TAHBE8020L-TAHBE8252**

3.2 mm	75	1	TAHBE-8020L
3.5 mm	75	1	TAHBE-8030

4 mm	100	1	TAHBE-8040
5.5 mm	150	1	TAHBE-8241
6.5 mm	150	1	TAHBE-8252

Tournevis vis à fente Ergo™ équipé d'un cordon Dyneema.  
Selon les normes définies par le procédé de prévention de chute d'objets DROPS

**ergo**



**TAHBE8155-TAHBE8258**

6 mm	125	1	TAHBE-8155
8 mm	175	1	TAHBE-8257
8 mm	210	1	TAHBE-8258

Tournevis Ergo™ pour vis à fente, équipé d'un cordon Dyneema.  
Selon les normes définies par le procédé de prévention de chute d'objets DROPS

**ergo**



**TAHBE-8260**

9 mm	175	1	TAHBE-8260
12 mm	200	1	TAHBE-8880

Tournevis boule Ergo™ pour vis à fente équipé d'un mandrin de sécurité.  
Selon les normes définies par le procédé de prévention de chute d'objets DROPS

**ergo**



**TAHBE-8350**

5.5 mm	28	1	TAHBE-8350

Tournevis Ergo™ Phillips®, équipé d'un mandrin de sécurité.  
Selon les normes définies par le procédé de prévention de chute d'objets DROPS

**ergo**



**TAHBE8610-TAHBE8624**

PH 1	75 mm	1	TAHBE-8611
PH 1	75 mm	1	TAHBE-8610
PH 2	100 mm	1	TAHBE-8620
PH 2	200 mm	1	TAHBE-8620L
PH 3	150 mm	1	TAHBE-8623
PH 4	190 mm	1	TAHBE-8624

Tournevis pour vis Phillips avec manche de précision  
PH00-PH1 et anneau de sécurité en acier inoxydable



**TAH701**

PH00	137	1	TAH701-00-50
PH 0	137	1	TAH701-0-50

Tournevis Ergo™ pour vis Phillips®, équipé d'un cordon Dyneema.  
Selon les normes définies par le procédé de prévention de chute d'objets DROPS

**ergo**



**TAHBE-8630**

PH 3	155 mm	1	TAHBE-8630

Tournevis boule Ergo™ pour vis Phillips® avec pièce de sécurité. Selon les normes définies par le procédé de prévention de chute d'objets DROPS

ergo®



**TAHBE-8602**



PH2	30 mm	1	TAHBE-8602

Tournevis TORX® Ergo™ équipé d'un mandrin de sécurité  
Pour le travail en hauteur

ergo®



**TAHBE8910-TAHBE8930**



T10	2.72 mm	1	TAHBE-8910
T15	3.26 mm	1	TAHBE-8915
T20	3.84 mm	1	TAHBE-8920
T25	4 mm	1	TAHBE-8925
T30	6 mm	1	TAHBE-8930

Tournevis isolé Phillips® Ergo™ équipé d'un lien en Kevlar  
Pour le travail en hauteur

ergo®



**TAHBE8610S-TAHBE8640S**

PH1	80 mm	1	TAHBE-8610S
PH2	100 mm	1	TAHBE-8620S
PH3	150 mm	1	TAHBE-8630S
PH4	190 mm	1	TAHBE-8640S

Tournevis Pozidriv Ergo™ équipé d'un mandrin de sécurité. Selon les normes définies par le procédé de prévention de chute d'objets DROPS

ergo®



**TAHBE8810-TAHBE8820**



PZ 1	73 mm	1	TAHBE-8810
PZ 2	100 mm	1	TAHBE-8820

Tournevis pour vis TORX® avec manche de précision T4-T20 et anneau de sécurité en acier inoxydable



**TAH703**



T 6	137	1	TAH703-6-50
T 7	137	1	TAH703-7-50
T 8	137	1	TAH703-8-50
T 9	137	1	TAH703-9-50
T 10	137	1	TAH703-10-50
T 15	162	1	TAH703-15-75

Tournevis isolé Ergo™ pour vis TORX® équipé d'un lien en Kevlar  
Pour le travail en hauteur

ergo®



**TAHBE8910S-TAHBE8930S**

T10	2.5 mm	1	TAHBE-8910S
T15	3.26 mm	1	TAHBE-8915S
T20	3.84 mm	1	TAHBE-8920S
T25	4.4 mm	1	TAHBE-8925S
T30	5.49 mm	1	TAHBE-8930S

Tournevis Ergo™ pour vis Pozidriv®, équipé d'un cordon Dyneema. Selon les normes définies par le procédé de prévention de chute d'objets DROPS

ergo®



**TAHBE-8830**



PZ 3	150 mm	1	TAHBE-8830

Tournevis isolé Ergo™ pour vis à fente équipé d'une attache en Kevlar. Selon les normes définies par le procédé de prévention de chute d'objets DROPS

ergo®

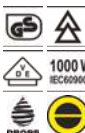

**TAHBE8040S-TAHBE8050S**

3.0 mm	100 mm	1	TAHBE-8220S
4.0 mm	100 mm	1	TAHBE-8040S
5.5 mm	125 mm	1	TAHBE-8050S
6.5 mm	155 mm	1	TAHBE-8255S

Tournevis fins isolés ERGO™ pour vis Pozidriv, manche tri matière avec cordon en kevlar

ergo®



**TAHBE-8810SL-8820SL**

PZ 2	PZ 2	1	TAHBE-8820SL



Clés mâles 6 pans courte métrique finition phosphatée avec anneau en acier inoxydable



### TAH1995M

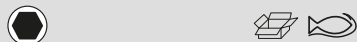

8 mm	1	TAH1995M-8
10 mm	1	TAH1995M-10
12 mm	1	TAH1995M-12

Jeu de 7 clés mâles coudées 6 pans, finition brunie, dimensions métriques avec cordon en kevlar  
Pour le travail en hauteur



### TAHBE-9777B



2,5,3,4,5,6,8,10 mm	1	TAHBE-9777B
---------------------	---	-------------

Tournevis coudé, pour vis Phillips avec anneau de sécurité  
Pour le travail en hauteur



### TAH2047PR-1-2



PH 1 & 2	1	TAH2047PR-1-2
----------	---	---------------

Clés mâles 6 pans courte en pouces finition phosphatée avec anneau en acier inoxydable



### TAH1995Z



1/2 in	1	TAH1995Z-1/2
--------	---	--------------

Jeu de 7 clés mâles coudées en pouces avec insert  
Pour le travail en hauteur



### TAHBE-9787

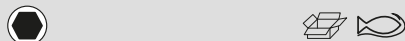

3/32, 1/8, 5/32, 3/16, 1/4, 5/16, 3/8 in	1	TAHBE-9787
--	---	------------

Jeu de 7 clés mâles 6 pans finition phosphatée avec cordon en Kevlar de 1,5 à 6 mm



### TAHBE-9776



7	1.5 2.5 3 4 5 6 mm	1	TAHBE-9776
---	--------------------	---	------------

Tournevis coudé pour vis à fente équipé d'une attache en acier  
Pour le travail en hauteur



### TAH2047-0.8-4



4.0 mm	1	TAH2047-0.8-4
--------	---	---------------

Poinçon pour douilles "Outils en Hauteur"  
Selon les normes définies par le procédé de prévention de chute d'objets DROPS



### TAHPINRELEASER

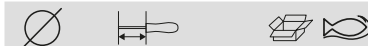

4	45	1	TAHPINRELEASER
---	----	---	----------------

## PINCES

Pince coupante diagonale avec anneau de sécurité  
Selon les normes définies par le procédé de prévention de chute d'objets DROPS



### TAH2101G

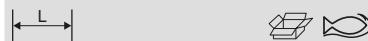

130	1	TAH2101G-125
145	1	TAH2101G-140
165	1	TAH2101G-160
185	1	TAH2101G-180
125	1	TAH2101G-125C
145	1	TAH2101G-140C
165	1	TAH2101G-160C
180	1	TAH2101G-180C

Pincettes coupante latérale usage industriel équipées d'un anneau de sécurité  
Pour le travail en hauteur

ergo®



**TAH21HDG**



210	1	TAH21HDG-200
200	1	TAH21HDG-200C

Pincettes à becs longs demi-ronds, 45° équipées d'un anneau de sécurité. Selon les normes définies par le procédé de prévention de chute d'objets DROPS

ergo®



**TAH2427G**



200	1	TAH2427G-200
-----	---	--------------

Pincette à circlips intérieurs à becs droits et finition phosphatée avec anneau en acier inoxydable



**TAH2800**



180	1	TAH2800-180
-----	---	-------------

Pince universelle avec anneau de sécurité  
Selon les normes définies par le procédé de prévention de chute d'objets DROPS

ergo®



**TAH2628G**



200	1	TAH2628G-200
170	1	TAH2628G-160
190	1	TAH2628G-180

Pince à dénuder pour le travail en hauteur

ergo®



**TAH2223G-150**



167	1	TAH2223G-150
-----	---	--------------

Pincette à circlips extérieurs à becs droits et finition phosphatée avec anneau en acier inoxydable



**TAH2900**



180	1	TAH2900-180
-----	---	-------------

Pincette à becs demi-ronds longs Ergo™ avec anneau de sécurité. Selon les normes définies par le procédé de prévention de chute d'objets DROPS

ergo®



**TAH2430G**



160	1	TAH2430G-160
200	1	TAH2430G-200

Pincettes à sertir à cliquet pour connecteurs isolés avec câble de sécurité en métal



**TAHCRW01**



225	0.5-6.0 mm <sup>2</sup>	1	TAHCRW01
-----	-------------------------	---	----------

Pincette coupe-fil à bec coudé avec plaque en métal de sécurité



**TAH2953**



140	1	TAH2953-140
300	1	TAH2953-300



Pince coupe-fil spéciale pour le travail en hauteur  
0



**TAH2951**

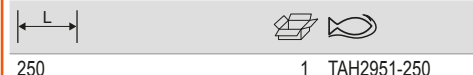

250 1 TAH2951-250

Pince 2 positions équipée d'une bague de sécurité  
Pour le travail en hauteur



**TAH2970G**



200 1 TAH2970G-200

Monture de scie à métaux avec câble de sécurité  
Selon les normes définies par le procédé de prévention de chute d'objets DROPS

ergo®



**TAH325**



300 1 TAH325

Pincettes à mors droits avec anneau de sécurité  
Pour le travail en hauteur



**TAH2958**



200 1 TAH2958-200  
245 1 TAH2958-250

Pince à freiner équipée d'un anneau de sécurité  
Pour le travail en hauteur



**TAH2855**



232 1 TAH2855

Monture de scie à métaux avec câble de sécurité  
Pour le travail en hauteur



**TAH320**



500 1 TAH320

Pince multiprise équipée d'un anneau de sécurité  
Selon les normes définies par le procédé de prévention de chute d'objets DROPS

ergo®



**TAH8224**



250 1 TAH8224

## OUTILS DE COUPE

Scies repliables avec manche bi-matière et cordon  
Dyneema de sécurité



**TAH396**



190 7 1/2 in 1 TAH396-JT

Monture de scie à métaux avec câble de sécurité  
Pour le travail en hauteur



**TAH317**



432 1 TAH317



Monture de scie à métaux en aluminium avec anneau de sécurité  
Pour le travail en hauteur



**TAH225-PLUS**



310 mm	1	TAH225-PLUS

Lime carrée bâtarde/mi-douce/douce, manche ERGO™ avec anneau de sécurité en acier inoxydable



**TAH1-160**



200 mm	1	TAH1-160-08-1-2

Lime ronde avec mandrin de sécurité  
Selon les normes définies par le procédé de prévention de chute d'objets DROPS



**TAH1-230**



310	1	TAH1-230-08-1-2
260	2	TAH1-230-06-2-2

Lime plate à bords effilés ERGO™ bâtarde/mi-douce/douce avec anneau de sécurité en acier inoxydable



**TAH1-110**



200	1	TAH1-110-08-1-2

Lime triangulaire bâtarde/mi-douce/douce, manche ERGO™ avec anneau de sécurité en acier inoxydable



**TAH1-170**



200 mm	1	TAH1-170-08-1-2

Ciseaux Electricien grande capacité équipé d'un câble de sécurité  
Pour le travail en hauteur



**TAHSCB140G**



145	43 mm	1 TAHSCB140G

Lime plate pointue équipée d'un anneau de sécurité  
Selon les normes définies par le procédé de prévention de chute d'objets DROPS



**TAH1-143**



415	1	TAH1-143-12-1-2

Lime demi-ronde avec anneau de sécurité  
Selon les normes définies par le procédé de prévention de chute d'objets DROPS



**TAH1-210**



325	1	TAH1-210-08-1-2
270	2	TAH1-210-06-2-2

Couteau d'électricien, lame repliable, manche plastique, équipé d'un cordon Dyneema  
Pour le travail en hauteur



**TAH2820EF**



195	85 mm	1 TAH2820EF2



Couteau de sécurité à la lame auto-rétractable avec cordon Dyneema de sécurité



**TAH8687**

172 m	1	TAH868700000

Massette à embouts Nylon équipée de 2 câbles de sécurité. Pour le travail en hauteur - Sécurité de la tête à la poignée



**TAH3625PW**

300	1	TAH3625W-35

Massette Carrée avec câble de sécurité  
Pour le travail en hauteur - Protection de la tête au manche



**TAH484**

1000	260	1	TAH484-1000
1500	280	1	TAH484-1500
2000	305	1	TAH484-2000

Brosse à outils usage général  
Pour le travail en hauteur



**TAH785-U & TAH52**

150	1	TAH52
290	1	TAH782-U

Marteau de serrurier avec câble de sécurité  
Pour le travail en hauteur - Protection de la tête au manche



**TAH479**

480	350	1	TAH479-16
900	400	1	TAH479-32

Massette sans rebond avec boucle de sécurité  
Pour le travail en hauteur



**TAH489**

1100	294	1	TAH489-1100
1800	300	1	TAH489-1800
2700	770	1	TAH489-2700
3600	770	1	TAH489-3600
4500	797	1	TAH489-4500
5400	795	1	TAH489-5400
6300	780	1	TAH489-6300

## MARTEAUX, LEVIERS ET BURINS

Massettes anti-rebond équipées d'un câble de sécurité  
Pour le travail en hauteur



**TAH3625PU**

620	340	1	TAH3625PU-50

Marteau de serrurier allemand avec câble de sécurité  
Pour le travail en hauteur - Protection de la tête au manche



**TAH481**

300	300	1	TAH481-300

Marteaux à panne ronde avec manche incassable et câble de sécurité en métal



**TAH490**

700	340 mm	1	TAH490-700
900	340 mm	1	TAH490-900
1100	340 mm	1	TAH490-1100

Marteau de type Espagnol avec fil de sécurité  
Selon les normes définies par le procédé de  
prévention de chute d'objets DROPS



### TAH486F

700	330	1	TAH486F-700

Marteau de charpentier arrache clous avec manche en  
acier et câble de sécurité



### TAH485

600	1	TAH485

Pincettes à décoller  
Pour le travail en hauteur



### TAH4400

20 mm	725	1	TAH440007000

Pied de biche spécial pour le travail en hauteur  
0



### TAHWBB

595	1	TAHWBB600
680	1	TAHWBB700

Chasse-goupille bi-matière avec mandrin de sécurité  
Selon les normes définies par le procédé de  
prévention de chute d'objets DROPS



### TAH3734BM

155	1	TAH3734BM-2
155	1	TAH3734BM-3
165	1	TAH3734BM-4
165	1	TAH3734BM-5
185	1	TAH3734BM-6
185	1	TAH3734BM-8
185	1	TAH3734BM-10

Pointeau gainé bi-matière équipé d'un mandrin  
Pour le travail en hauteur



### TAH3755BM

165	1	TAH3755BM-4

Burin de mécanicien avec anneau de sécurité  
Pour le travail en hauteur



### TAH3640

250	1	TAH3640-250-C

Burin pointu TAH



### TAH3739

300	1	TAH3739-300

Levier avec anneau de sécurité  
Pour le travail en hauteur



### TAH2484

305 mm	1	TAH2484-30

Levier 90° avec pièce de sécurité  
Pour le travail en hauteur



### TAH3683

400 mm	1	TAH3683

Levier à tête bombée, finition phosphatée avec câble  
de sécurité en métal



### TAH3681

304	1	TAH3681-11
406	1	TAH3681-16
503	1	TAH3681-20



## OUTILS DE MESURE

Mètres rubans longs avec revêtement nylon et boîtier ouvert, avec cordon Dyneema de sécurité



### TAHLTS

30	13	1 TAHLTS-30

Règles en acier inoxydable, dimensions métriques avec cordon Dyneema de sécurité



### TAHSRMM

300	1 TAHSR300-MM

Niveau à bulle en aluminium anodisé Torpedo équipé d'un lien Dyneema Pour le travail en hauteur



### TAH466

250	1 TAH466-250

Équerre à coulisse équipée d'un cordon Dyneema Pour le travail en hauteur



### TAHCS300

300 mm	125 mm	1 TAHCS300

Équerre équipée d'un cordon Dyneema Pour le travail en hauteur



### TAH9048-250

250 mm	165 mm	1 TAH9048-250

Équerre équipée d'un cordon Dyneema Finition noire



### TAH9045-B-250

250 mm	170 mm	1 TAH9045-B-250

Pied à coulisse avec anneau de sécurité Selon les normes définies par le procédé de prévention de chute d'objets DROPS



### TAH1150

7 x 75 x 235 mm	1 TAH1150-1/2H/P

Doigt flexible à griffes avec boucle de sécurité Pour le travail en hauteur



### TAH2509

560 mm	1 TAH2509

Doigt magnétique flexible avec cordon Dyneema Pour le travail en hauteur



### TAH2535F2

13 mm	405 mm	1 TAH2535F2

Pointe à tracer coudée équipée d'un anneau de sécurité Pour le travail en hauteur



### TAH1177

30	1 TAH1177-SCRIBE

Jauge d'épaisseur avec anneau de sécurité  
Pour le travail en hauteur



**TAH1544**



105 mm 1 TAH1544

## OUTILLAGE DYNAMOMÉTRIQUE

Clé dynamométrique avec échelle et poignée en plastique équipée d'un câble de sûreté  
Pour le travail en hauteur



**TAH7445**



20-100 Nm 1/2" inch 1 TAH7445-100A-1

Clé dynamométrique à cliquet double échelle, poignée métal équipée d'un câble de sécurité  
Pour le travail en hauteur - câble de sécurité



**TAH7455**



60-300 Nm 44.3-221.3 lb-ft 1 TAH7455-300-1

Clé dynamométrique avec échelle et poignée en plastique équipée d'un câble de sûreté  
Pour le travail en hauteur



**TAH7435**



20-100 Nm 9x12 mm 1 TAH7435-100

Têtes de cliquet réversible équipée d'un système de verrouillage  
Pour le travail en hauteur



**TAH7452-2**

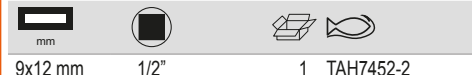

9x12 mm 1/2" 1 TAH7452-2

Tête de cliquet réversible ronde avec mécanisme de verrouillage par goupille de sécurité



**TAH7852-1**



14X18 mm 1/2" 1 TAH7852-1

## OUTILS DE SERRAGE

Serre-joints avec anneau de sécurité  
Pour le travail en hauteur



**TAH420SH-80-160**



160 80 mm 1 TAH420SH-80-160

## AUTRES OUTILS

Grattoir en carbone équipé d'un anneau de sécurité  
Pour le travail en hauteur



**TAH2487**



205 mm 1 TAH2487

Poinçons et crochets miniatures avec cordons de sécurité en Kevlar



**TAH2633**



146 1 TAH2633/S4

Clé à chaîne pour filtre à huile équipée d'une pièce de sécurité  
Pour le travail en hauteur



**TAHBE64520**



520 mm 60-160 mm 1 TAHBE64520



Lampe frontale équipée d'un cordon Dyneema  
Selon les normes définies par le procédé de  
prévention de chute d'objets DROPS



**TAHBFRL11**



90 x 95 x 115 mm	1	TAHBFRL11

Gants universels



**3875-GLOVE**

	5	3875-GLOVE

Pistolet graisseur à cartouche avec mousqueton de  
sécurité  
Pour le travail en hauteur



**TAHBOD54**

120 x 385 x 57 mm	1	TAHBOD5400
135 x 400 x 61 mm	1	TAHBOD5450

Gants de protection



**GL010**

10	5	GL010-10
8	5	GL010-8

**GANTS**

Gants multiusage



**GL008**

10	5	GL008-10
8	5	GL008-8

Gants de charpentier



**GL012**

10	5	GL012-10
8	5	GL012-8



## Outils isolés



## TOURNEVIS

Tournevis Ergo™ isolé  
Pour vis à fente

ergo®



### BE-8010S - BE-8065S

Ø	L	BE
2.5	75	5 BE-8010S
3.0	100	5 BE-8220S
3.5	100	5 BE-8230S
4.0	100	5 BE-8040S
5.5	125	5 BE-8050S
6.5	150	5 BE-8255S
8.0	175	5 BE-8065S
10	200	5 BE-8258S
12	200	5 BE-8259S

Tournevis Ergo™ isolé  
Pour vis Phillips®

ergo®



### BE-8600S - BE-8640S

Ø	L	BE
PH 0	75	5 BE-8600S
PH 1	80	5 BE-8610S
PH1	80 mm	5 BE-8611S
PH 1	150	5 BE-8612S
PH 2	100	5 BE-8620S
PH 2	100	5 BE-8621S
PH 2	175	5 BE-8622S
PH 3	150	5 BE-8630S
PH 4	200	5 BE-8640S

Tournevis Ergo™ isolé  
Pour vis Pozidriv®

ergo®



### BE-8800S - BE-8840S

Ø	L	BE
PZ 0	75	5 BE-8800S
PZ 1	80	5 BE-8810S
PZ1	80 mm	5 BE-8811S
PZ 1	150	5 BE-8812S
PZ 2	100	5 BE-8820S
PZ 2	100	5 BE-8821S
PZ 2	175	5 BE-8822S
PZ 3	150	5 BE-8830S
PZ 4	200	5 BE-8840S

Tournevis Ergo™ isolé  
Pour vis TORX®

ergo®



### BE-8910S - BE-8930S

Ø	L	BE
T 5	75	5 BE-8905S
T 6	75	5 BE-8906S
T 7	75	5 BE-8907S
T 8	75	5 BE-8908S
T 9	75	5 BE-8909S
T 10	100	5 BE-8910S
T 15	125	5 BE-8915S
T 20	125	5 BE-8920S
T 25	150	5 BE-8925S
T 30	175	5 BE-8930S

Tournevis Ergo™ isolé  
Pour vis 6 pans creux

ergo®



### BE-8725S - BE-8708S

Ø	L	BE
2.5	100	5 BE-8725S
3	125	5 BE-8703S
4	150	5 BE-8704S
5	175	5 BE-8705S
6	150	5 BE-8706S
8	200	5 BE-8708S

Tournevis combi Ergo™ isolé  
Pour vis à fente 5 & 6 et Phillips® 1 & 2

ergo®



### BE-8510S - BE-8520S

Ø	L	BE
5.0/PH1	80	5 BE-8510S
6.0/PH2	100	5 BE-8520S

Tournevis combi Ergo™ isolé  
Pour vis à fente 5 & 6 et Pozidriv® 1 & 2

ergo®



### BE-8710S - BE-8720S

Ø	L	BE
5.0/PZ1	80	5 BE-8710S
6.0/PZ2	100	5 BE-8720S

Tournevis Ergo™ isolé à lames fines  
Pour vis à fente

ergo®



### BE-8220SL - BE-8255SL

Ø	L	BE
3.0	100	10 BE-8220SL
3.5	100	10 BE-8230SL
4.0	100	10 BE-8040SL
5.5	125	10 BE-8050SL
6.5	150	10 BE-8255SL



Tournevis Ergo™ isolé à lames fines  
Pour vis Phillips®



**BE-8610SL - BE-8620SL**

PH 1	80	10	BE-8610SL
PH 2	100	10	BE-8620SL

Jeu de 14 tournevis Ergo™ isolés  
Pour vis à fente, Phillips®, Pozidriv®, TORX® et Combi PZ



**BE-9876S**

14	1	BE-9876S

BE-8010S, BE-8220S, BE-8230S, BE-8040S, BE-8050S		
BE-8611S, BE-8621S		
BE-8811S, BE-8821S		
BE-8910S, BE-8915S, BE-8920S		
BE-8710S, BE-8720S		

Tournevis Ergo™ isolé à lames fines  
Pour vis Pozidriv®



**BE-8810SL - BE-8820SL**

PZ 1	80	10	BE-8810SL
PZ 2	100	10	BE-8820SL

Tournevis Ergo™ isolé à lames fines  
Pour vis TORX®



**BE-8910SL - BE-8930SL**

T 10	100	5	BE-8910SL
T 15	100	5	BE-8915SL
T 20	100	5	BE-8920SL
T 25	125	5	BE-8925SL
T 30	150	5	BE-8930SL

Tournevis combi Ergo™ isolé à lames fines  
Pour combi vis à fente/Phillips®



**BE-8510SL - BE-8520SL**

5.0/PH1	80	10	BE-8510SL
6.0/PH2	100	10	BE-8520SL

Tournevis combi Ergo™ isolé à lames fines  
Pour combi vis à fente/Pozidriv®

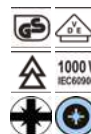

**BE-8710SL - BE-8720SL**

5.0/PZ1	80	10	BE-8710SL
6.0/PZ2	100	10	BE-8720SL

Clé à douille emmanchée Ergo™ isolée



**BE-7855S - BE-7810S**

5.5	125	5	BE-7855S
6	125	5	BE-7806S
7	125	5	BE-7807S
8	125	5	BE-7808S
9	125	5	BE-7809S
10	125	5	BE-7810S

Jeu de 2 tournevis isolés Ergo™ lames fines  
Combi vis à fente/Pozidriv®



**BE-9890SL**

2	175	1	BE-9890SL

BE-8710SL, BE-8720SL

Jeu de 2 tournevis isolés Ergo™ lames fines  
Pour vis Phillips®



**BE-9891SL**

2	1	BE-9891SL

BE-8610SL, BE-8620SL



Jeu de 2 tournevis isolés Ergo™ lames fines  
Pour vis Pozidriv®

ergo



**BE-9894SL**



2 132 1 BE-9894SL

BE-8810SL, BE-8820SL



Jeu de 4 tournevis Ergo™ isolés lames fines  
Pour vis TORX®

ergo



**BE-9880SL**



4 132 1 BE-9880SL

BE-8910SL, BE-8915SL, BE-8920SL,  
BE-8925SL



Jeu de 5 tournevis Ergo™ isolés lames fines  
Pour vis à fente et Phillips®

ergo



**BE-9881SL**



5 132 1 BE-9881SL

BE-8220SL, BE-8040SL, BE-8050SL



BE-8610SL, BE-8620SL

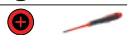

Jeu de 5 tournevis Ergo™ isolés lames fines  
Pour vis à fente et Pozidriv®

ergo



**BE-9882SL**



5 132 1 BE-9882SL

BE-8220SL, BE-8040SL, BE-8050SL



BE-8810SL, BE-8820SL



Jeu de 5 tournevis lame fine

ergo



**BE-9871SL**



5 132 1 BE-9871SL

Jeu de 5 tournevis lame fine

ergo



**BE-9872SL**



5 132 1 BE-9872SL

BE-8220SL, BE-8050SL, BE-8040S

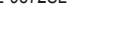

BE-8811S, BE-8821S



Jeu de 12 tournevis Ergo™ isolés  
Pour vis à fente, Phillips®, Pozidriv®, TORX® et Combi  
PH

ergo



**BE-9878SL**



12 132 1 BE-9878SL

BE-8010S



BE-8220SL, BE-8230SL, BE-8040SL,  
BE-8050SL

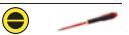

BE-8610SL, BE-8620SL

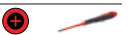

BE-8810SL, BE-8820SL

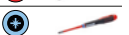

BE-8510SL, BE-8520SL



BE-8910SL



Jeu de 5 tournevis Ergo™ isolés  
Pour vis à fente et Phillips®

ergo



**BE-9881S**



5 132 1 BE-9881S

BE-8220S, BE-8040S, BE-8050S



BE-8611S, BE-8621S



Jeu de 5 tournevis Ergo™ isolés  
Pour vis à fente et Pozidriv®

ergo



**BE-9882S**



5 132 1 BE-9882S

BE-8220S, BE-8050S, BE-8040S



BE-8811S, BE-8821S



Jeu de 7 tournevis Ergo™ isolés  
Pour vis à fente et Pozidriv®

ergo



**BE-9888S**



7

1 BE-9888S

BE-8040S, BE-8050S, BE-8010S,  
BE-8220S



BE-8800S, BE-8821S, BE-8830S



Jeu de 4 tournevis Ergo™ isolés combi (8 embouts  
différents) et un testeur  
Combi: vis à fente/Phillips® et vis à fente/Pozidriv®

ergo



**BE-9885S**



5

1 BE-9885S

806-1-1



BE-8520S, BE-8510S



BE-8710S, BE-8720S



Jeu de 6 tournevis Ergo™ isolés + testeur  
Pour vis à fente et Phillips®

ergo



**BE-9887S**



7

1 BE-9887S

806-1-1



BE-8010S, BE-8050S, BE-8230S,  
BE-8040S



BE-8611S, BE-8621S



Jeu de 6 tournevis Ergo™ isolés + testeur  
Pour vis à fente et Pozidriv®

ergo



**BE-9889S**



7

1 BE-9889S

BE-8010S, BE-8040S, BE-8050S,  
BE-8230S



BE-8821S



806-1-1



BE-8811S



Jeu de 6 tournevis Ergo™ isolés  
Pour vis à fente, Pozidriv® et Combi vis à fente/  
Pozidriv®

ergo



**BE-9884S**



6

1 BE-9884S

BE-8220S, BE-8040S



BE-8710S, BE-8720S



BE-8810S, BE-8820S



Jeu de 2 tournevis Ergo™ pour installations  
électriques  
Combi vis à fente/Pozidriv®

ergo



**BE-9890S**



2

175

1 BE-9890S

Pour une utilisation sur des racks et bornes

BE-8710S, BE-8720S



Tournevis isolé pour vis à fente

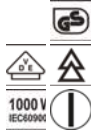

**B196**



2.5	75	10	B196.025.075
3	100	10	B196.030.100
3.5	100	10	B196.035.100
4	100	10	B196.040.100
5.5	125	10	B196.055.125
6.5	150	10	B196.065.150
8	175	10	B196.080.175
10	200	10	B196.100.200
12	200	10	B196.120.200
2.5	75	1	SB196.025.075
3	100	1	SB196.030.100
3.5	100	1	SB196.035.100
4	100	1	SB196.040.100
5.5	125	1	SB196.055.125
6.5	150	1	SB196.065.150
8	175	1	SB196.080.175
10	200	1	SB196.100.200
12	200	1	SB196.120.200

Tournevis isolé pour vis Phillips®



**B197PH**



PH0	75	10	B197.000.075
PH1	80	10	B197.001.080
PH1	150 mm	10	B197.001.150
PH2	100	10	B197.002.100
PH2	175 mm	10	B197.002.175
PH3	150	10	B197.003.150
PH4	200	10	B197.004.200
PH0	75	1	SB197.000.075
PH1	80	1	SB197.001.080
PH2	100	1	SB197.002.100
PH3	150	1	SB197.003.150
PH4	200	1	SB197.004.200



Tournevis isolé pour vis Pozidriv®



**B142PZ**

PZ0	75	10	B142.000.075
PZ1	80	10	B142.001.080
PZ1	150 mm	10	B142.001.150
PZ2	100	10	B142.002.100
PZ2	175 mm	10	B142.002.175
PZ3	150	10	B142.003.150
PZ0	75	1	SB142.000.075
PZ1	80	1	SB142.001.080
PZ2	100	1	SB142.002.100
PZ3	150	1	SB142.003.150

Tournevis isolés TORX®



**B150TORX**

T10	100 mm	10	B150.010.100
T15	125 mm	10	B150.015.125
T20	125 mm	10	B150.020.125
T25	150 mm	10	B150.025.150
T10	100 mm	1	SB150.010.100
T15	125 mm	1	SB150.015.125
T20	125 mm	1	SB150.020.125
T25	150 mm	1	SB150.025.150

Tournevis isolé combi Phillips®  
Pour utilisation sur les tableaux électriques et les boîtes de dérivation



**B148**

5.0mm/PH1	80 mm	10	B148.001.080
6.0mm/PH2	100 mm	10	B148.002.100
5.0mm/PH1	80 mm	1	SB148.001.080
6.0mm/PH2	100 mm	1	SB148.002.100

Porte-douille emmanché isolé



**B199**

5.5	6	7	8	9	10	11	12	13
125	125	125	125	125	125	125	125	125
5	5	5	5	5	5	5	5	5
B199.055.125	B199.060.125	B199.070.125	B199.080.125	B199.090.125	B199.100.125	B199.110.125	B199.120.125	B199.130.125
1	1	1	1	1	1	1	1	1
SB199.055.125	SB199.060.125	SB199.070.125	SB199.080.125	SB199.090.125	SB199.100.125	SB199.110.125	SB199.120.125	SB199.130.125

Tournevis isolé combi Pozidriv®  
Pour utilisation sur les tableaux électriques et les boîtes de dérivation



**B149**

5.0mm/PZ1	80 mm	10	B149.001.080
6.0mm/PZ2	100 mm	10	B149.002.100
5mm/PZ1	80 mm	1	SB149.001.080
6.0mm/PZ2	100 mm	1	SB149.002.100

Jeu de 2 tournevis isolés BahcoFit  
Pour vis à fente et Phillips®



**B220.002**

2	90	1	B220.002

B196.030.100

B197.001.080

Jeu de 2 tournevis isolés BahcoFit  
Pour vis combi Pozidriv®



**B220.012**

2	182	1	B220.012

B149.001.080, B149.002.100

Jeu de 5 tournevis isolés BahcoFit  
Pour vis à fente et Phillips®



**B220.005**

5	1	B220.005

B196.030.100, B196.040.100,  
B196.055.125

B197.001.080, B197.002.100

Jeu de 5 tournevis isolés BahcoFit  
Pour vis à fente et Pozidriv®



**B220.015**



5 1 B220.015



- B196.035.100, B196.040.100, B196.065.150
- B142.001.080, B142.002.100

Jeu de 7 tournevis isolés BahcoFit  
Pour vis à fente et Phillips®



**B220.007**



7 1 B220.007



- B196.030.100, B196.040.100, B196.055.125, B196.065.150
- B197.000.075, B197.001.080, B197.002.100

Jeu de 7 tournevis isolés BahcoFit  
Pour vis à fente et Pozidriv®



**B220.017**



7 1 B220.017



- B196.025.075, B196.040.100, B196.055.125, B196.065.150
- B142.000.075, B142.001.080, B142.002.100

Jeu de 7 tournevis isolés BahcoFit  
Pour vis à fente et Phillips®



**B220.027**



7 1 B220.027



- B196.030.100, B196.040.100, B196.055.125
- B197.000.075, B197.001.080, B197.002.100
- 806-1-1

Tournevis isolé série 600 pour vis à fente



**623**



3.0	100	10	623-3-100
3.5	100	10	623-3.5-100
4.0	100	10	623-4-100
5.5	125	10	623-5.5-125
6.5	150	10	623-6.5-150



Tournevis isolé série 600 pour vis Phillips®



**625PH**



PH 0	100	10	625-0-100
PH 1	150	10	625-1-150
PH 2	175	10	625-2-175



Manche de tournevis à cliquet 1000V avec 6 lames interchangeables



**808061**



7 85 x 85 x 218 mm 5 808061



- 808060
- 8610SL-2P, 8620SL-2P
- 8010SL-2P, 8050SL-2P, 8220SL-2P, 8040SL-2P

Manche de tournevis à cliquet 1000V avec 6 lames interchangeables



**808062**



7 85 x 85 x 215 mm 5 808062



- 808060
- 8820SL-2P, 8810SL-2P
- 8010SL-2P, 8050SL-2P, 8220SL-2P, 8040SL-2P

Manche de tournevis à cliquet 1000V  
Utilisable avec des lames interchangeables



**808060**



36 122 1 808060



Lame interchangeable à diamètre réduit pour vis à fente. 100mm



**8010SL-2P - 8050SL-2P**

Ø	L	Q	Q
0.4	2.5	1	8010SL-2P
0.5	3.0	1	8220SL-2P
0.8	4.0	1	8040SL-2P
1.0	5.5	1	8050SL-2P

Lame interchangeable de 100 mm, diamètre réduit Embout Phillips®



**8610SL-2P - 8620SL-2P**

Ø	L	Q	Q
1		1	8610SL-2P
2		1	8620SL-2P

Lame interchangeable de 100 mm, diamètre réduit Embout Pozidriv®



**8810SL-2P - 8820SL-2P**

Ø	L	Q	Q
1		1	8810SL-2P
2		1	8820SL-2P

Lame interchangeable de 100 mm, diamètre réduit Combi vis à fente/Phillips®



**8510SL-2P - 8520SL-2P**

Ø	L	Q	Q
5.0	1	1	8510SL-2P
6.0	2	1	8520SL-2P

Lame interchangeable de 100 mm, diamètre réduit pour vis à fente/Pozidriv® (Combi) Combi vis à fente/Pozidriv®



**8710SL-2P - 8720SL-2P**

Ø	L	Q	Q
5.0	1	1	8710SL-2P
6.0	2	1	8720SL-2P

Lame interchangeable de 100 mm, diamètre réduit Embout TORX®



**8910SL-2P - 8930SL-2P**

Ø	L	Q	Q
10		1	8910SL-2P
15		1	8915SL-2P
20		1	8920SL-2P
25		1	8925SL-2P
30		1	8930SL-2P

**PINCES**

Pince coupante diagonale poignées isolées Pour corde à piano, matériaux plus doux comme le plastique ou le fil de cuivre

ergo®



**2101S**

Ø	L	Q	Q
3.7	2.0	3	2101S-140
3.8	2.5	3	2101S-160
4.0	2.7	3	2101S-180

Pinces coupantes diagonales isolées, poignées isolées.

Pince coupante diagonale taillants progressifs, poignées isolées. Pour le fil de piano et les matériaux plus doux comme le plastique ou le cuivre



**2101S-200**

Ø	L	Q	Q
4.5	3.0	3	2101S-200

Coupe-câble pour câble cuivre et aluminium



**2260S**

L	Q	Q
210	2	2260 S-210

Coupe-câble électrique isolé à cliquet



**2806**



35	255	1	2806-35V
52	340	1	2806-52V

Pince coupante en bout isolée



**527V**



2	160	2	527V-160
2.5	200	2	527V-200

Coupe-boulons isolé



**2820VBC**



	630	1	2820VBC

Coupe-câble isolé aluminium et cuivre  
Pour l'aluminium et le cuivre



**2520S**



	552	1	2520 S

Coupe-câble isolé



**2250V**



	170	2	2250V-170
	230	2	2250V-230

Pince coupante diagonale chromée, isolée  
Fil d'acier dur



**2674 NVDE**



3.7	2.0	1	2674 NVDE

Pince coupante diagonale chromée, isolée, avec biseau externe.

Pince coupante diagonale isolée



**2171V**



2.7	160	2	2171V-160
2.8	180	2	2171V-180
4.0 mm	200	2	2171V-200

Coupe-câble isolé pour cuivre et aluminium  
Pour l'aluminium et le cuivre



**2260V**



	210	2	2260V-210

Pince universelle isolée jusqu'à 1000 volts

ergo®



**2628S**



2.0	1.8	3	2628 S-160
2.5	2.0	3	2628 S-180
3.0	2.5	3	2628 S-200

Pinces universelles isolées jusqu'à 1000 volts, poignées plastique.



Pinces coupantes isolées

ergo®



**2630SC**



180	3	2630SC-180	

Pince à bec demi-rond isolée, pointe courbée

ergo®



**2427S**



3.0 mm	1.8 mm	3	2427S-160
3.0	1.8	3	2427 S-200

Pince à bec demi-rond avec poignées isolées  
Pour fil d'acier dur



**2430V**



3.0	160	2	2430V-160
3.0	200	2	2430V-200

Pince universelle isolée



**2678V**



2.7	160	2	2678V-160
3.0	180	2	2678V-180
4.0	200	2	2678V-200

Pinces coupantes isolées

ergo®



**2421S**



140	3	2421S-140
160	3	2421S-160
180	3	2421S-180

Pince isolée à bec demi-rond coudée à 45°



**2427V**



3.0	200	2	2427V-200

Pinces becs demi-ronds isolées, poignées gainées  
jusqu'à 1000 volts  
Fil d'acier dur

ergo®



**2430S**



2.5 mm	1.8 mm	3	2430S-140
3.0	1.8	3	2430 S-160
3.0	1.8	3	2430 S-200

Pinces à becs ronds isolées

ergo®



**2521S**



140	3	2521S-140
160	3	2521S-160

Pince à bec plat isolée



**2421V**



160	2	2421V-160

Pinces à becs demi-ronds, modèle isolé, poignées  
plastique, taillants pour matériaux tendres.

**BAHCO**



Pince à bec rond isolée



**2521V**

160	2	2521V-160



Pince multiprises ajustement rapide, poignées isolées 1000V



**7224S**

16	250	4 7224S



Clé à molette isolée



**8071VLT - 8073VLT**

205mm/8"	1	8071VLT
255mm/10"	1	8072VLT
305mm/12"	1	8073VLT



Pince à dénuder isolée  
Fil de cuivre et câble

ergo®



**2223S**

165	3	2223 S-150



Clé à molette isolée



**8070V - 8074V**

165mm/6"	2	8070V
205mm/8"	2	8071V
260mm/10"	2	8072V
310mm/12"	2	8073V
390mm/15"	2	8074V



Clé à fourche isolée



**6MV**

6	5	6MV-6
7	5	6MV-7
8	5	6MV-8
9	5	6MV-9
10	5	6MV-10
11	5	6MV-11
12	5	6MV-12
13	5	6MV-13
14	5	6MV-14
15	5	6MV-15
16	5	6MV-16
17	3	6MV-17
18	3	6MV-18
19	3	6MV-19
20	3	6MV-20
21	3	6MV-21
22	3	6MV-22
23	3	6MV-23
24	3	6MV-24
27	2	6MV-27
30	2	6MV-30
32	2	6MV-32



Pince à dénuder isolée  
Pour fils et câbles en cuivre



**2223V**

160	0.5-5	2	2223V-160



Clé à molette isolée



**8070VL-8073VL**

160mm/6"	1	8070VL
210mm/8"	1	8071VL
260mm/10"	1	8072VL
310mm/12"	1	8073VL



### Clé polygonale coudée isolée



**2MV**



Ø	Longueur	Quantité	Modèle
6.0		5	2MV-6
7.0		5	2MV-7
8.0		5	2MV-8
9.0		5	2MV-9
10.0		5	2MV-10
11.0		5	2MV-11
12.0		5	2MV-12
13.0		5	2MV-13
14.0		5	2MV-14
15.0		5	2MV-15
16.0		5	2MV-16
17.0		3	2MV-17
18.0		3	2MV-18
19.0		3	2MV-19
21.0		3	2MV-21
22.0		3	2MV-22
23.0		3	2MV-23
24.0		3	2MV-24

### Poignée en T isolée



**28MV**



Ø	Longueur	Quantité	Modèle
8.0		2	28MV-8
9.0		2	28MV-9
10.0		2	28MV-10
11.0		2	28MV-11
12.0		2	28MV-12
13.0		2	28MV-13
14.0		2	28MV-14
15.0		2	28MV-15
16.0		2	28MV-16
17.0		2	28MV-17
18.0		2	28MV-18
19.0		2	28MV-19
20.0		2	28MV-20
21.0		2	28MV-21
22.0		2	28MV-22

### Clé en croix isolée 6 pans



**2820V**



Ø	Longueur	Quantité	Modèle
7x9x11x13		1	2820V13
8x10x13x17		1	2820V17

### Clé mâle coudée isolée 6 pans



**1999MV**



Ø	Longueur	Quantité	Modèle
3		5	1999MV-3
4		5	1999MV-4
5		5	1999MV-5
6		5	1999MV-6
7		5	1999MV-7
8		5	1999MV-8
9		5	1999MV-9
10		3	1999MV-10
12		3	1999MV-12

## DOUILLES ET CLIQUETS ISOLÉS

### Douille 1/2" isolée



**7800DMV**



Ø	Longueur	Quantité	Modèle
8		10	7800DMV-8
10		10	7800DMV-10

Ø	Longueur	Quantité	Modèle
11		10	7800DMV-11
12		10	7800DMV-12
13		10	7800DMV-13
14		10	7800DMV-14
15		10	7800DMV-15
16		10	7800DMV-16
17		10	7800DMV-17
18		10	7800DMV-18
19		10	7800DMV-19
20		10	7800DMV-20
21		10	7800DMV-21
22		10	7800DMV-22
24		5	7800DMV-24
27		5	7800DMV-27
30		5	7800DMV-30
32		5	7800DMV-32

### Cliquet isolé 1/2"



**8150-1/2V**



Longueur	Quantité	Modèle
270	1	8150-1/2V

### Poignée en T 1/2" isolée



**8154-1/2V**



Longueur	Longueur	Quantité	Modèle
200	190 mm	1	8154-1/2V

Rallonge isolée 1/2"



**8160-1/2V - 8162-1/2V**



125	1	8160-1/2V
250	1	8162-1/2V

Couteau isolé à lame droite



**2820VP**



50 mm	180	2	2820VP

Couteau coupe-câble isolé avec protection



**2820VDE**



55.5 mm	180	10	2820VDE

## CISEAUX ET COUTEAUX

Ciseaux isolés pour électricien



**SC127V**



50 mm	130	5	SC127V

Couteau isolé à lame courbe



**2820VPC**



50 mm	180	2	2820VPC

## BRUCELLES

Brucelle isolée



**2820VTEE**



150	1	2820VTEE

Ciseaux isolés pour électricien



**SC150NGV**



38 mm	150	5	SC150NGV

Couteau isolé à lame courbe avec guide



**2820VHELP**



38 mm	180	1	2820VHELP

## ÉQUIPEMENT DE SÉCURITÉ

Pose-fusible de sécurité isolé



**2820VFP**



458 g	1	2820VFP



Tapis isolant



**2820VM**



1000	1000	1	2820VM

Gants isolés



**2820VG**



500 V	1	2820VG05
1000 V	1	2820VG10

Gants en coton pour porter sous gants isolants  
Taille unique



**2820VGCOT**

50	1	2820VGCOT

**JEUX D'OUTILS**

Jeu de 8 clés à fourche isolées



**6MV/8T**



8	1	6MV/8T

6MV-11, 6MV-10, 6MV-13, 6MV-12, 6MV-14, 6MV-17, 6MV-18, 6MV-19		
---	--	--

Jeu de 10 clés à fourche isolées  
10 pcs



**6MV/10T**



10	1	6MV/10T

6MV-12, 6MV-10, 6MV-11, 6MV-13, 6MV-14, 6MV-16, 6MV-17, 6MV-18, 6MV-19, 6MV-22		
--	--	--

Jeu de 10 outils isolés pour électricien



**3045/1VDE**



10	225 x 70 x 300 mm	1	3045/1VDE

BE-8010S, BE-8040S, BE-8050S, BE-8220S, BE-8230S, BE-8255S		
BE-8620S		
2171V-160		
2430V-160		
2678V-180		

Jeu de 10 outils isolés  
10 pcs



**3045V-1**



10	60 x 240 x 330 mm	1	3045V-1

2171V-160		
2678V-180		
2223V-160		
BE-8220S, BE-8040S, BE-8050S		
BE-8610S, BE-8620S		
2820VP		
SC127V		

Composition de 19 outils isolés dans une mallette en cuir  
19 pcs



### 3045V-2



19 200 x 285 x 445 mm

1 3045V-2

2171V-160	1000 V IEC60900	
2678V-180	1000 V IEC60900	
2430V-160	1000 V IEC60900	
2223V-160	1000 V IEC60900	
BE-8220S, BE-8040S, BE-8050S, BE-8255S		
BE-8610S, BE-8620S		
6MV-10, 6MV-11, 6MV-13, 6MV-12, 6MV-14, 6MV-17, 6MV-19	1000 V IEC60900	
2820VP	1000 V IEC60900	
SC150NGV	1000 V IEC60900	

Jeu de 11 douilles isolées 1/2"  
11 pcs



### 7811DMV



11 270 x 79 x 350 mm

1 7811DMV

7800DMV-13, 7800DMV-10, 7800DMV-11, 7800DMV-22, 7800DMV-17, 7800DMV-19, 7800DMV-20	1000 V IEC60900	
8150-1/2V	1000 V IEC60900	
8154-1/2V	1000 V IEC60900	
8160-1/2V	1000 V IEC60900	
BE-8050S		





**BAHCO**

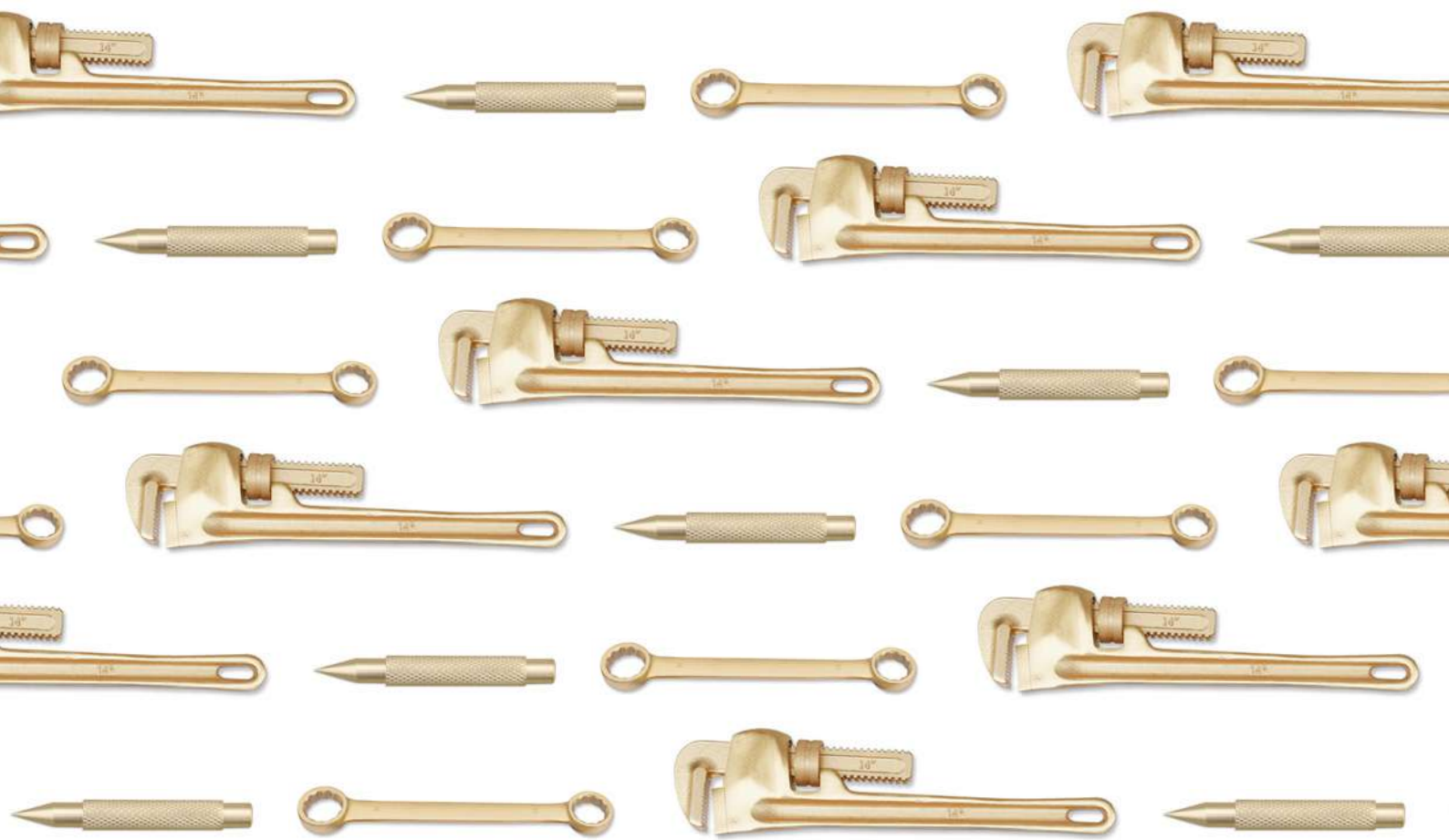

## Outils antidéflagrants



## CLÉS

Clé à molette antidéflagrante AL-BR



### NS001

Icon	L	Icon	Icon
18	150mm/6"	1	NS001-150
24	200mm/8"	1	NS001-200
30	250mm/10"	1	NS001-250
36	300mm/12"	1	NS001-300
46	375mm/15"	1	NS001-375
55	450mm/18"	1	NS001-450
65	600mm/24"	1	NS001-600
75	900mm/36"	1	NS001-900

Clé à molette antidéflagrante



### NSB001

Icon	L	Icon	Icon
18	150mm/6"	1	NSB001-150
24	200mm/8"	1	NSB001-200
30	250mm/10"	1	NSB001-250
36	300mm/12"	1	NSB001-300
48	375mm/15"	1	NSB001-375
55	450mm/18"	1	NSB001-450
65	600mm/24"	1	NSB001-600
75	900mm/36"	1	NSB001-900

Clé mixte antidéflagrante



### NS002

Icon	Icon	Icon
6	5	NS002-6
7	5	NS002-7
8	5	NS002-8
9	5	NS002-9
10	10	NS002-10
11	5	NS002-11
12	5	NS002-12
13	10	NS002-13
14	5	NS002-14
15	5	NS002-15
16	5	NS002-16
17	10	NS002-17
18	5	NS002-18
19	10	NS002-19
20	5	NS002-20
21	5	NS002-21
22	10	NS002-22
23	5	NS002-23
24	10	NS002-24
25	5	NS002-25
26	5	NS002-26
27	5	NS002-27
28	5	NS002-28
29	10	NS002-29
30	10	NS002-30
31	5	NS002-31
32	5	NS002-32
33	5	NS002-33
34	5	NS002-34
35	5	NS002-35
36	5	NS002-36
38	5	NS002-38
40	5	NS002-40
41	5	NS002-41
42	5	NS002-42
46	5	NS002-46
50	5	NS002-50
52	5	NS002-52
55	5	NS002-55
60	1	NS002-60
65	1	NS002-65
70	1	NS002-70
75	1	NS002-75
80	1	NS002-80

Clé mixte antidéflagrante CU-BE



### NSB002



Icon	Icon	Icon
6 mm	5	NSB002-6
7 mm	5	NSB002-7
8 mm	5	NSB002-8
9 mm	5	NSB002-9
10 mm	5	NSB002-10
11 mm	5	NSB002-11
12 mm	5	NSB002-12
13 mm	5	NSB002-13
17 mm	5	NSB002-17
14 mm	5	NSB002-14
15 mm	5	NSB002-15
16 mm	5	NSB002-16
18 mm	5	NSB002-18
19 mm	5	NSB002-19
20 mm	5	NSB002-20
21 mm	5	NSB002-21
22 mm	5	NSB002-22
25 mm	5	NSB002-25
23 mm	5	NSB002-23
26 mm	5	NSB002-26
24 mm	5	NSB002-24
27 mm	5	NSB002-27
28 mm	5	NSB002-28
29 mm	5	NSB002-29
30 mm	5	NSB002-30
31 mm	1	NSB002-31
32 mm	10	NSB002-32
33 mm	1	NSB002-33
34 mm	1	NSB002-34
35 mm	1	NSB002-35
36 mm	5	NSB002-36
38 mm	1	NSB002-38
40 mm	1	NSB002-40
41 mm	5	NSB002-41
42 mm	1	NSB002-42
46 mm	1	NSB002-46
50 mm	1	NSB002-50
52 mm	1	NSB002-52
55 mm	1	NSB002-55
60 mm	1	NSB002-60
65 mm	1	NSB002-65
70 mm	1	NSB002-70
75 mm	1	NSB002-75
80 mm	1	NSB002-80





## Clé à fourche double antidéflagrante



### NS006



 	
6x7 mm	1 NS006-0607
6x8 mm	1 NS006-0608
7x8 mm	1 NS006-0708
7x9 mm	1 NS006-0709
8x9 mm	1 NS006-0809
8x10 mm	1 NS006-0810
9x10 mm	1 NS006-0910
9x11 mm	1 NS006-0911
10x11 mm	1 NS006-1011
10x12 mm	1 NS006-1012
10x13 mm	1 NS006-1013
10x14 mm	1 NS006-1014
11x13 mm	1 NS006-1113
11x14 mm	1 NS006-1114
12x13 mm	1 NS006-1213
12x14 mm	1 NS006-1214
13x15 mm	1 NS006-1315
14x15 mm	1 NS006-1415
14x16 mm	1 NS006-1416
14x17 mm	1 NS006-1417
16x17 mm	1 NS006-1617
16x18 mm	1 NS006-1618
17x19 mm	1 NS006-1719
17x22 mm	1 NS006-1722
18x19 mm	1 NS006-1819
18x20 mm	1 NS006-1820
19x20 mm	1 NS006-1920
19x22 mm	1 NS006-1922
19x24 mm	1 NS006-1924
20x22 mm	1 NS006-2022
21x22 mm	1 NS006-2122
21x23 mm	1 NS006-2123
22x23 mm	1 NS006-2223
22x24 mm	1 NS006-2224
22x27 mm	1 NS006-2227
23x26 mm	1 NS006-2326
24x25 mm	1 NS006-2425
24x26 mm	1 NS006-2426
24x27 mm	1 NS006-2427
24x30 mm	1 NS006-2430
25x28 mm	1 NS006-2528
26x29 mm	1 NS006-2629
27x29 mm	1 NS006-2729
27x30 mm	1 NS006-2730
27x32 mm	1 NS006-2732
28x30 mm	1 NS006-2830
30x31 mm	1 NS006-3031
30x32 mm	1 NS006-3032
30x34 mm	1 NS006-3034
30x36 mm	1 NS006-3036
32x34 mm	1 NS006-3234
32x35 mm	1 NS006-3235
32x36 mm	1 NS006-3236
33x35 mm	1 NS006-3335
34x36 mm	1 NS006-3436
35x36 mm	1 NS006-3536
36x38 mm	1 NS006-3638
36x41 mm	1 NS006-3641
38x42 mm	1 NS006-3642



 	
41x46 mm	1 NS006-4146
46x50 mm	1 NS006-4650
50x52 mm	1 NS006-5052
50x55 mm	1 NS006-5055
50x60 mm	1 NS006-5060
50x62 mm	1 NS006-5062
55x60 mm	1 NS006-5560
60x65 mm	1 NS006-6065
65x70 mm	1 NS006-6570

## Clé à fourche double antidéflagrante CU-BE



### NSB006



 	
6X7 mm	1 NSB006-0607
6X8 mm	1 NSB006-0608
7X8 mm	1 NSB006-0708
7X9 mm	1 NSB006-0709
8X9 mm	1 NSB006-0809
8X10 mm	1 NSB006-0810
9X10 mm	1 NSB006-0910
9X11 mm	1 NSB006-0911
10X11 mm	1 NSB006-1011
10X12 mm	1 NSB006-1012
10X13 mm	1 NSB006-1013
10X14 mm	1 NSB006-1014
11X13 mm	1 NSB006-1113
11X14 mm	1 NSB006-1114
12X13 mm	1 NSB006-1213
12X14 mm	1 NSB006-1214
13X15 mm	1 NSB006-1315
14X15 mm	1 NSB006-1415
14X16 mm	1 NSB006-1416
14X17 mm	1 NSB006-1417
16X17 mm	1 NSB006-1617
16X18 mm	1 NSB006-1618
17X19 mm	1 NSB006-1719
17X22 mm	1 NSB006-1722
18X19 mm	1 NSB006-1819
18X20 mm	1 NSB006-1820
19X20 mm	1 NSB006-1920
19X22 mm	1 NSB006-1922
19X24 mm	1 NSB006-1924
20X22 mm	1 NSB006-2022
21X22 mm	1 NSB006-2122
21X23 mm	1 NSB006-2123
22X23 mm	1 NSB006-2223
22X24 mm	1 NSB006-2224
22X27 mm	1 NSB006-2227
23X26 mm	1 NSB006-2326
24X25 mm	1 NSB006-2425
24X26 mm	1 NSB006-2426
24X27 mm	1 NSB006-2427
24X30 mm	1 NSB006-2430
25x28 mm	1 NSB006-2528
26x29 mm	1 NSB006-2629
27-29 mm	1 NSB006-2729
27x30 mm	1 NSB006-2730
27x32 mm	1 NSB006-2732

 	
28x30 mm	1 NSB006-2830
30x31 mm	1 NSB006-3031
30x32 mm	1 NSB006-3032
30x34 mm	1 NSB006-3034
30x36 mm	1 NSB006-3036
32x34 mm	1 NSB006-3234
32x35 mm	1 NSB006-3235
32x36 mm	1 NSB006-3236
33x35 mm	1 NSB006-3335
34x36 mm	1 NSB006-3436
35x36 mm	1 NSB006-3536
36x38 mm	1 NSB006-3638
36x41 mm	1 NSB006-3641
38x42 mm	1 NSB006-3642
41x46 mm	1 NSB006-4146
46x50 mm	1 NSB006-4650
50x52 mm	1 NSB006-5052
50x55 mm	1 NSB006-5055
50x60 mm	1 NSB006-5060
50x62 mm	1 NSB006-5062
55x60 mm	1 NSB006-5560
60x65 mm	1 NSB006-6065
65x70 mm	1 NSB006-6570

## Clé polygonale double antidéflagrante



### NS010



 	
6x7	1 NS010-0607
7x9	1 NS010-0709
8x9	1 NS010-0809
9x11	1 NS010-0911
10x11	1 NS010-1011
10x12	1 NS010-1012
12x14	1 NS010-1214
13x15	1 NS010-1315
14x17	1 NS010-1417
16x18	1 NS010-1618
17x19	1 NS010-1719
17x22	1 NS010-1722
18x19	1 NS010-1819
19x21	1 NS010-1921
19x22	1 NS010-1922
20x22	1 NS010-2022
21x23	1 NS010-2123
22x24	1 NS010-2224
24x27	1 NS010-2427
25x28	1 NS010-2528
26x28	1 NS010-2628
27x30	1 NS010-2730
27x32	1 NS010-2732
30x32	1 NS010-3032
30x36	1 NS010-3036
32x36	1 NS010-3236
36x41	1 NS010-3641
41x46	1 NS010-4146
46x50	1 NS010-4650



## Clé polygonale double antidéflagrante CU-BE





### NSB010

 	
6X7 mm	1 NSB010-0607
7X9 mm	1 NSB010-0709
8X9 mm	1 NSB010-0809
9X11 mm	1 NSB010-0911
10X11 mm	1 NSB010-1011
10X12 mm	1 NSB010-1012
12X14 mm	1 NSB010-1214
13X15 mm	1 NSB010-1315
14X17 mm	1 NSB010-1417
16X18 mm	1 NSB010-1618
17X19 mm	1 NSB010-1719
17X22 mm	1 NSB010-1722
18X19 mm	1 NSB010-1819
19X21 mm	1 NSB010-1921
19X22 mm	1 NSB010-1922
20X22 mm	1 NSB010-2022
21X23 mm	1 NSB010-2123
22X24 mm	1 NSB010-2224
24X27 mm	1 NSB010-2427
25X28 mm	1 NSB010-2528
26X28 mm	1 NSB010-2628
27X30 mm	1 NSB010-2730
27X32 mm	1 NSB010-2732
30X32 mm	1 NSB010-3032
30X36 mm	1 NSB010-3036
32X36 mm	1 NSB010-3236
36X41 mm	1 NSB010-3641
41X46 mm	1 NSB010-4146
46X50 mm	1 NSB010-4650

## Clé polygonale double contre coudée antidéflagrante AL-BR



### NS011



 	
6x7 mm	1 NS011-0607
8x9 mm	1 NS011-0809
10x11 mm	1 NS011-1011
12x13 mm	1 NS011-1213
14x15 mm	1 NS011-1415
16x17 mm	1 NS011-1617
18x19 mm	1 NS011-1819
20x22 mm	1 NS011-2022
21x23 mm	1 NS011-2123

 	
24x26 mm	1 NS011-2426
25x28 mm	1 NS011-2528
27x29 mm	1 NS011-2729
30x32 mm	1 NS011-3032

## Clé polygonale double contre coudée antidéflagrante CU-BE





### NSB011



 	
6x7 mm	1 NSB011-0607
8x9 mm	1 NSB011-0809
10x11 mm	1 NSB011-1011
12x13 mm	1 NSB011-1213
14x15 mm	1 NSB011-1415
16x17 mm	1 NSB011-1617
18x19 mm	1 NSB011-1819
20x22 mm	1 NSB011-2022
21x23 mm	1 NSB011-2123
24x26 mm	1 NSB011-2426
25x28 mm	1 NSB011-2528
27x29 mm	1 NSB011-2729
30x32 mm	1 NSB011-3032

## Clé à fourche à frapper antidéflagrante



### NS100



 	
17	1 NS100-17
19	1 NS100-19
22	1 NS100-22
24	1 NS100-24
25	1 NS100-25
27	1 NS100-27
28	1 NS100-28
29	1 NS100-29
30	1 NS100-30
32	1 NS100-32
33	1 NS100-33
34	1 NS100-34
35	1 NS100-35
36	1 NS100-36
37	1 NS100-37
38	1 NS100-38
41	1 NS100-41
42	1 NS100-42
45	1 NS100-45
46	1 NS100-46



 	
47	1 NS100-47
50	1 NS100-50
52	1 NS100-52
54	1 NS100-54
55	1 NS100-55
56	1 NS100-56
58	1 NS100-58
60	1 NS100-60
63	1 NS100-63
65	1 NS100-65
67	1 NS100-67
70	1 NS100-70
71	1 NS100-71
75	1 NS100-75
77	1 NS100-77
80	1 NS100-80
82	1 NS100-82
85	1 NS100-85
88	1 NS100-88
90	1 NS100-90
94	1 NS100-94
95	1 NS100-95
100	1 NS100-100
105	1 NS100-105
110	1 NS100-110
115	1 NS100-115
120	1 NS100-120

## Clé à frapper antidéflagrante CU-BE



### NSB100



 	
17	1 NSB100-17
19	1 NSB100-19
22	1 NSB100-22
24	1 NSB100-24
25	1 NSB100-25
27	1 NSB100-27
28	1 NSB100-28
29	1 NSB100-29
30	1 NSB100-30
32	1 NSB100-32
33	1 NSB100-33
34	1 NSB100-34
35	1 NSB100-35
36	1 NSB100-36
37	1 NSB100-37
38	1 NSB100-38
41	1 NSB100-41
42	1 NSB100-42
45	1 NSB100-45
46	1 NSB100-46
47	1 NSB100-47
50	1 NSB100-50
52	1 NSB100-52
54	1 NSB100-54
55	1 NSB100-55
56	1 NSB100-56
58	1 NSB100-58
60	1 NSB100-60



	 
63	1 NSB100-63
65	1 NSB100-65
67	1 NSB100-67
70	1 NSB100-70
71	1 NSB100-71
75	1 NSB100-75
77	1 NSB100-77
80	1 NSB100-80
82	1 NSB100-82
85	1 NSB100-85
88	1 NSB100-88
90	1 NSB100-90
94	1 NSB100-94
95	1 NSB100-95
100	1 NSB100-100
105	1 NSB100-105
110	1 NSB100-110
115	1 NSB100-115
120	1 NSB100-120

Clé polygonale à frapper antidéflagrante métrique - AL-BR



### NS104



	 
17 mm	1 NS104-17
19 mm	1 NS104-19
20 mm	1 NS104-20
22 mm	1 NS104-22
24 mm	1 NS104-24
25 mm	1 NS104-25
26 mm	1 NS104-26
27 mm	1 NS104-27
28 mm	1 NS104-28
29 mm	1 NS104-29
30 mm	1 NS104-30
31 mm	1 NS104-31
32 mm	1 NS104-32
33 mm	1 NS104-33
34 mm	1 NS104-34
35 mm	1 NS104-35
36 mm	1 NS104-36
37 mm	1 NS104-37
38 mm	1 NS104-38
39 mm	1 NS104-39
40 mm	1 NS104-40
41 mm	1 NS104-41
42 mm	1 NS104-42
43 mm	1 NS104-43
44 mm	1 NS104-44
45 mm	1 NS104-45
46 mm	1 NS104-46
47 mm	1 NS104-47
48 mm	1 NS104-48
49 mm	1 NS104-49
50 mm	1 NS104-50
51 mm	1 NS104-51
52 mm	1 NS104-52
53 mm	1 NS104-53
54 mm	1 NS104-54



	 
55 mm	1 NS104-55
56 mm	1 NS104-56
57 mm	1 NS104-57
58 mm	1 NS104-58
59 mm	1 NS104-59
60 mm	1 NS104-60
61 mm	1 NS104-61
62 mm	1 NS104-62
63 mm	1 NS104-63
64 mm	1 NS104-64
65 mm	1 NS104-65
66 mm	1 NS104-66
67 mm	1 NS104-67
68 mm	1 NS104-68
69 mm	1 NS104-69
70 mm	1 NS104-70
71 mm	1 NS104-71
72 mm	1 NS104-72
73 mm	1 NS104-73
74 mm	1 NS104-74
75 mm	1 NS104-75
76 mm	1 NS104-76
77 mm	1 NS104-77
78 mm	1 NS104-78
79 mm	1 NS104-79
80 mm	1 NS104-80
81 mm	1 NS104-81
82 mm	1 NS104-82
83 mm	1 NS104-83
84 mm	1 NS104-84
85 mm	1 NS104-85
86 mm	1 NS104-86
87 mm	1 NS104-87
88 mm	1 NS104-88
89 mm	1 NS104-89
90 mm	1 NS104-90
92 mm	1 NS104-92
94 mm	1 NS104-94
95 mm	1 NS104-95
98 mm	1 NS104-98
100 mm	1 NS104-100
105 mm	1 NS104-105
110 mm	1 NS104-110
115 mm	1 NS104-115
120 mm	1 NS104-120

Clé polygonale à frapper antidéflagrante, métrique - CU-BE



### NSB104

	 
17 mm	1 NSB104-17
19 mm	1 NSB104-19
20 mm	1 NSB104-20
22 mm	1 NSB104-22
24 mm	1 NSB104-24
25 mm	1 NSB104-25
26 mm	1 NSB104-26
27 mm	1 NSB104-27
28 mm	1 NSB104-28

	 
29 mm	1 NSB104-29
30 mm	1 NSB104-30
31 mm	1 NSB104-31
32 mm	1 NSB104-32
33 mm	1 NSB104-33
34 mm	1 NSB104-34
35 mm	1 NSB104-35
36 mm	1 NSB104-36
37 mm	1 NSB104-37
38 mm	1 NSB104-38
39 mm	1 NSB104-39
40 mm	1 NSB104-40
41 mm	1 NSB104-41
42 mm	1 NSB104-42
43 mm	1 NSB104-43
44 mm	1 NSB104-44
45 mm	1 NSB104-45
46 mm	1 NSB104-46
47 mm	1 NSB104-47
48 mm	1 NSB104-48
49 mm	1 NSB104-49
50 mm	1 NSB104-50
51 mm	1 NSB104-51
52 mm	1 NSB104-52
53 mm	1 NSB104-53
54 mm	1 NSB104-54
55 mm	1 NSB104-55
56 mm	1 NSB104-56
57 mm	1 NSB104-57
58 mm	1 NSB104-58
59 mm	1 NSB104-59
60 mm	1 NSB104-60
61 mm	1 NSB104-61
62 mm	1 NSB104-62
63 mm	1 NSB104-63
64 mm	1 NSB104-64
65 mm	1 NSB104-65
66 mm	1 NSB104-66
67 mm	1 NSB104-67
68 mm	1 NSB104-68
69 mm	1 NSB104-69
70 mm	1 NSB104-70
71 mm	1 NSB104-71
72 mm	1 NSB104-72
73 mm	1 NSB104-73
74 mm	1 NSB104-74
75 mm	1 NSB104-75
76 mm	1 NSB104-76
77 mm	1 NSB104-77
78 mm	1 NSB104-78
79 mm	1 NSB104-79
80 mm	1 NSB104-80
81 mm	1 NSB104-81
82 mm	1 NSB104-82
83 mm	1 NSB104-83
84 mm	1 NSB104-84
85 mm	1 NSB104-85
86 mm	1 NSB104-86
87 mm	1 NSB104-87
88 mm	1 NSB104-88
89 mm	1 NSB104-89
90 mm	1 NSB104-90
92 mm	1 NSB104-92
94 mm	1 NSB104-94
95 mm	1 NSB104-95
98 mm	1 NSB104-98
100 mm	1 NSB104-100
105 mm	1 NSB104-105
110 mm	1 NSB104-110
115 mm	1 NSB104-115
120 mm	1 NSB104-120



## Clé polygonale à frapper antidéflagrante, en pouces



### NS106

Size	Quantity	Part Number
5/8 in	1	NS106-20
11/16 in	1	NS106-22
3/4 in	1	NS106-24
25/32 in	1	NS106-25
13/16 in	1	NS106-26
7/8 in	1	NS106-28
15/16 in	1	NS106-30
1 in	1	NS106-32
1 1/16 in	1	NS106-34
1 1/8 in	1	NS106-36
1 3/16 in	1	NS106-38
1 1/4 in	1	NS106-40
1 5/16 in	1	NS106-42
1 3/8 in	1	NS106-44
1 13/32 in	1	NS106-45
1 7/16 in	1	NS106-46
1 1/2 in	1	NS106-48
1 9/16 in	1	NS106-50
1 5/8 in	1	NS106-52
1 11/16 in	1	NS106-54
1 3/4 in	1	NS106-56
1 13/16 in	1	NS106-58
1 7/8 in	1	NS106-60
1 15/16 in	1	NS106-62
2 in	1	NS106-64
2 1/16 in	1	NS106-66
2 1/8 in	1	NS106-68
2 3/16 in	1	NS106-70
2 13/64 in	1	NS106-71
2 1/4 in	1	NS106-72
2 5/16 in	1	NS106-74
2 3/8 in	1	NS106-76
2 7/16 in	1	NS106-78
2 1/2 in	1	NS106-80
2 9/16 in	1	NS106-82
2 5/8 in	1	NS106-84
2 3/4 in	1	NS106-88
2 13/16 in	1	NS106-90
2 7/8 in	1	NS106-92
2 15/16 in	1	NS106-94
3 in	1	NS106-96
3 1/16 in	1	NS106-98
3 1/8 in	1	NS106-100
3 1/4 in	1	NS106-104
3 3/8 in	1	NS106-108
3 1/2 in	1	NS106-112
3 9/16 in	1	NS106-114
3 5/8 in	1	NS106-116
3 3/4 in	1	NS106-120
3 7/8 in	1	NS106-124
3 15/16 in	1	NS106-126
4 in	1	NS106-128
4 1/8 in	1	NS106-132
4 1/4 in	1	NS106-136
4 5/16 in	1	NS106-138
4 1/2 in	1	NS106-144

Size	Quantity	Part Number
4 9/16 in	1	NS106-146
4 11/16 in	1	NS106-150
4 7/8 in	1	NS106-156
4 15/16 in	1	NS106-158

## Clé polygonale à frapper antidéflagrante, pouces CU-BE



### NSB106

Size	Quantity	Part Number
5/8 in	1	NSB106-20
11/16 in	1	NSB106-22
3/4 in	1	NSB106-24
25/32 in	1	NSB106-25
13/16 in	1	NSB106-26
7/8 in	1	NSB106-28
15/16 in	1	NSB106-30
1 in	1	NSB106-32
1.1/16 in	1	NSB106-34
1.1/8 in	1	NSB106-36
1.3/16 in	1	NSB106-38
1.1/4 in	1	NSB106-40
1.5/16 in	1	NSB106-42
1.3/8 in	1	NSB106-44
1.13/32 in	1	NSB106-45
1.7/16 in	1	NSB106-46
1.1/2 in	1	NSB106-48
1.9/16 in	1	NSB106-50
1.5/8 in	1	NSB106-52
1.11/16 in	1	NSB106-54
1.3/4 in	1	NSB106-56
1.13/16 in	1	NSB106-58
1.7/8 in	1	NSB106-60
1.15/16 in	1	NSB106-62
2 in	1	NSB106-64
2.1/16 in	1	NSB106-66
2.1/8 in	1	NSB106-68
2.3/16 in	1	NSB106-70
2.13/64 in	1	NSB106-71
2.1/4 in	1	NSB106-72
2.5/16 in	1	NSB106-74
2.3/8 in	1	NSB106-76
2.7/16 in	1	NSB106-78
2.1/2 in	1	NSB106-80
2.9/16 in	1	NSB106-82
2.5/8 in	1	NSB106-84
2.3/4 in	1	NSB106-88
2.13/16 in	1	NSB106-90
2.7/8 in	1	NSB106-92
2.15/16 in	1	NSB106-94
3 in	1	NSB106-96
3.1/16 in	1	NSB106-98
3.1/8 in	1	NSB106-100
3.1/4 in	1	NSB106-104
3.3/8 in	1	NSB106-108
3.1/2 in	1	NSB106-112
3.9/16 in	1	NSB106-114
3.5/8 in	1	NSB106-116

Size	Quantity	Part Number
3.3/4 in	1	NSB106-120
3.7/8 in	1	NSB106-124
3.15/16 in	1	NSB106-126
4 in	1	NSB106-128
4.1/8 in	1	NSB106-132
4.1/4 in	1	NSB106-136
4.5/16 in	1	NSB106-138
4.1/2 in	1	NSB106-144
4.9/16 in	1	NSB106-146
4.11/16 in	1	NSB106-150
4.7/8 in	1	NSB106-156
4.15/16 in	1	NSB106-158

## SERRE-TUBES ET OUTILLAGE POUR VALVES

Serre-tube antidéflagrant grande capacité - AL-BR



### NS200

Size	Length (L)	Quantity	Part Number
25	200	1	NS200-200
30	250	1	NS200-250
40	300	1	NS200-300
50	350	1	NS200-350
60	450	1	NS200-450
75	600	1	NS200-600
85	900	1	NS200-900
110	1200	1	NS200-1200

Serre-tube antidéflagrant grande capacité - CU-BE



### NSB200

Size	Length (L)	Quantity	Part Number
25	200	1	NSB200-200
30	250	1	NSB200-250
40	300	1	NSB200-300
50	350	1	NSB200-350
60	450	1	NSB200-450
75	600	1	NSB200-600
85	900	1	NSB200-900
110	1200	1	NSB200-1200

Clé à ergot antidéflagrante valve longue - AL-BR



**NS202**

L	
370	1 NS202-350

Clé à ergot antidéflagrante valve longue - CU-BE



**NSB202**

L	
375	1 NSB202-350

Clé à ergot antidéflagrante - AL-BR



**NS203**

L	
215	1 NS203-200
215	1 NS203-215
290	1 NS203-290
400	1 NS203-400
490	1 NS203-490
800	1 NS203-800

Clé à ergot antidéflagrante - CU-BE



**NSB203**

L	
215	1 NSB203-200
215	1 NSB203-215

L	
290	1 NSB203-290
400	1 NSB203-400
490	1 NSB203-490
800	1 NSB203-800

Clé à ergot antidéflagrante - AL-BR



**NS204**

L	
200	1 NS204-30
300	1 NS204-32
250	1 NS204-35
300	1 NS204-40
350	1 NS204-45
375	1 NS204-48
400	1 NS204-50
450	1 NS204-55
500	1 NS204-60
550	1 NS204-65
600	1 NS204-70
650	1 NS204-75
700	1 NS204-80
750	1 NS204-85
800	1 NS204-90

Clé à ergot antidéflagrante - CU-BE



**NSB204**

L	
200	1 NSB204-30
300	1 NSB204-32
250	1 NSB204-35
300	1 NSB204-40

L	
350	1 NSB204-45
375	1 NSB204-48
400	1 NSB204-50
450	1 NSB204-55
500	1 NSB204-60
550	1 NSB204-65
600	1 NSB204-70
650	1 NSB204-75
700	1 NSB204-80
750	1 NSB204-85
800	1 NSB204-90

**DOUILLES ET CLIQUETS**

Douille 1/2" antidéflagrante - AL-BR



**NS220**

6 mm	1 NS220-06
7 mm	1 NS220-07
8 mm	1 NS220-08
9 mm	1 NS220-09
10 mm	1 NS220-10
11 mm	1 NS220-11
12 mm	1 NS220-12
13 mm	1 NS220-13
14 mm	1 NS220-14
15 mm	1 NS220-15
16 mm	1 NS220-16
17 mm	1 NS220-17
18 mm	1 NS220-18
19 mm	1 NS220-19
20 mm	1 NS220-20
21 mm	1 NS220-21
22 mm	1 NS220-22
23 mm	1 NS220-23
24 mm	1 NS220-24
25 mm	1 NS220-25
26 mm	1 NS220-26
27 mm	1 NS220-27
28 mm	1 NS220-28
29 mm	1 NS220-29
30 mm	1 NS220-30
32 mm	1 NS220-32



Douille 1/2" antidéflagrante - CU-BE



**NSB220**

Ø		
6 mm	1	NSB220-06
7 mm	1	NSB220-07
8 mm	1	NSB220-08
9 mm	1	NSB220-09
10 mm	1	NSB220-10
11 mm	1	NSB220-11
12 mm	1	NSB220-12
13 mm	1	NSB220-13
14 mm	1	NSB220-14
15 mm	1	NSB220-15
16 mm	1	NSB220-16
17 mm	1	NSB220-17
18 mm	1	NSB220-18
19 mm	1	NSB220-19
20 mm	1	NSB220-20
21 mm	1	NSB220-21
22 mm	1	NSB220-22
23 mm	1	NSB220-23
24 mm	1	NSB220-24
25 mm	1	NSB220-25
26 mm	1	NSB220-26
27 mm	1	NSB220-27
28 mm	1	NSB220-28
29 mm	1	NSB220-29
30 mm	1	NSB220-30
32 mm	1	NSB220-32

Douille 3/4" antidéflagrante - AL-BR



**NS224**

Ø		
17 mm	1	NS224-17
18 mm	1	NS224-18
19 mm	1	NS224-19
21 mm	1	NS224-21
22 mm	1	NS224-22
23 mm	1	NS224-23
24 mm	1	NS224-24
26 mm	1	NS224-26
27 mm	1	NS224-27
28 mm	1	NS224-28
29 mm	1	NS224-29
30 mm	1	NS224-30

Ø		
32 mm	1	NS224-32
34 mm	1	NS224-34
36 mm	1	NS224-36
38 mm	1	NS224-38
41 mm	1	NS224-41
46 mm	1	NS224-46
50 mm	1	NS224-50

Douille 3/4" antidéflagrante - CU-BE



**NSB224**

Ø		
17 mm	1	NSB224-17
18 mm	1	NSB224-18
19 mm	1	NSB224-19
21 mm	1	NSB224-21
22 mm	1	NSB224-22
23 mm	1	NSB224-23
24 mm	1	NSB224-24
26 mm	1	NSB224-26
27 mm	1	NSB224-27
28 mm	1	NSB224-28
29 mm	1	NSB224-29
30 mm	1	NSB224-30
32 mm	1	NSB224-32
34 mm	1	NSB224-34
36 mm	1	NSB224-36
38 mm	1	NSB224-38
41 mm	1	NSB224-41
46 mm	1	NSB224-46
50 mm	1	NSB224-50

Douille 1" antidéflagrante - AL-BR



**NS228**

Ø		
22 mm	1	NS228-22
24 mm	1	NS228-24

Ø		
26 mm	1	NS228-26
27 mm	1	NS228-27
28 mm	1	NS228-28
29 mm	1	NS228-29
30 mm	1	NS228-30
31 mm	1	NS228-31
32 mm	1	NS228-32
34 mm	1	NS228-34
36 mm	1	NS228-36
38 mm	1	NS228-38
41 mm	1	NS228-41
46 mm	1	NS228-46
50 mm	1	NS228-50
55 mm	1	NS228-55
60 mm	1	NS228-60
65 mm	1	NS228-65
70 mm	1	NS228-70
75 mm	1	NS228-75
80 mm	1	NS228-80

Douille 1" antidéflagrante - CU-BE



**NSB228**

Ø		
22 mm	1	NSB228-22
24 mm	1	NSB228-24
26 mm	1	NSB228-26
27 mm	1	NSB228-27
28 mm	1	NSB228-28
29 mm	1	NSB228-29
30 mm	1	NSB228-30
31 mm	1	NSB228-31
32 mm	1	NSB228-32
34 mm	1	NSB228-34
36 mm	1	NSB228-36
38 mm	1	NSB228-38
41 mm	1	NSB228-41
46 mm	1	NSB228-46
50 mm	1	NSB228-50
55 mm	1	NSB228-55
60 mm	1	NSB228-60
65 mm	1	NSB228-65
70 mm	1	NSB228-70
75 mm	1	NSB228-75
80 mm	1	NSB228-80

Adaptateur antidéflagrant AL-BR



**NS232**

mm	mm		
1/2"	3/4"	1	NS232-16-24
3/4"	1/2"	1	NS232-24-16
3/4"	1"	1	NS232-24-32
1"	3/4"	1	NS232-32-24

Extension antidéflagrant - CU-BE



**NSB234**

L	mm		
100 mm	16.4	1	NSB234-16-100
200 mm	16.4	1	NSB234-16-200
250 mm	16.4	1	NSB234-16-250
200 mm	25	1	NSB234-24-200
250 mm	34	1	NSB234-32-250

Poignée coulissante en T antidéflagrante - AL-BR



**NS238**

mm	L		
1/2"	250	1	NS238-16-250
3/4"	260	1	NS238-24-250
1"	300	1	NS238-32-300

Adaptateur antidéflagrant CU-BE



**NSB232**

mm	mm		
1/2"	3/4"	1	NSB232-16-24
3/4"	1/2"	1	NSB232-24-16
3/4"	1"	1	NSB232-24-32
1"	3/4"	1	NSB232-32-24

Cardan universel articulé antidéflagrant - AL-BR



**NS236**

mm	mm		
1/2"	1/2"	1	NS236-16
3/4"	3/4"	1	NS236-24
1"	1"	1	NS236-32

Poignée coulissante en T antidéflagrante - CU-BE



**NSB238**

mm	L		
1/2"	250	1	NSB238-16-250
3/4"	250	1	NSB238-24-250
1"	300	1	NSB238-32-300

Extension antidéflagrant - AL-BR



**NS234**

mm	mm		
1/2"	1/2"	1	NS234-16-100
1/2"	1/2"	1	NS234-16-200
1/2"	1/2"	1	NS234-16-250
3/4"	3/4"	1	NS234-24-200
1"	1"	1	NS234-32-250

Cardan universel articulé antidéflagrant - CU-BE



**NSB236**

mm	mm		
1/2"	1/2"	1	NSB236-16
3/4"	3/4"	1	NSB236-24
1"	1"	1	NSB236-32

Poignée coudée 1/2" antidéflagrante - AL-BR



**NS240**

mm	L		
1/2"	230 mm	1	NS240-16-230



Poignée coudée 1/2" antidéflagrante - CU-BE



**NSB240**

1/2"	370	1	NSB240-16-230

Villebrequin 1/2" antidéflagrant - AL-BR



**NS243**

1/2"	390 mm	1	NS243-16-400

Douille pour bougie d'allumage 1/2" antidéflagrante - CU-BE



**NSB247**

1/2"	13	1	NSB247-26

Cliquet antidéflagrant - AL-BR



**NS242**

245 mm	630	1	NS242-16
320 mm	1460	1	NS242-24
550 mm	3190	1	NS242-32

Villebrequin 1/2" antidéflagrant - CU-BE



**NSB243**

1/2"	395 mm	1	NSB243-16-400

Douille tournevis 1/2" antidéflagrante - AL-BR



**NS248**

13	1	NS248-16-52

Cliquet antidéflagrant - CU-BE



**NSB242**

245 mm	710	1	NSB242-16
320 mm	1660	1	NSB242-24
550 mm	3680	1	NSB242-32

Douille pour bougie d'allumage 1/2" antidéflagrante - AL-BR



**NS247**

1/2"	13	1	NS247-26

Douille tournevis 1/2" antidéflagrante - CU-BE



**NSB248**

13	1	NSB248-16-52



## TOURNEVIS

Tournevis antidéflagrant vis à fente AL-BR

ergo®



### NS300

Ø	L	Q	Q
3 mm	50 mm	1	NS300-3-50
3 mm	75 mm	1	NS300-3-75
4 mm	75 mm	1	NS300-4-75
4.5 mm	50 mm	1	NS300-4.5-50
4.5 mm	100 mm	1	NS300-4.5-100
5 mm	75 mm	1	NS300-5-75
5 mm	100 mm	1	NS300-5-100
6 mm	100 mm	1	NS300-6-100
6 mm	125 mm	1	NS300-6-125
6 mm	150 mm	1	NS300-6-150
7 mm	150 mm	1	NS300-7-150
8 mm	150 mm	1	NS300-8-150
8 mm	200 mm	1	NS300-8-200
9 mm	250 mm	1	NS300-9-250
10 mm	200 mm	1	NS300-10-200
10 mm	300 mm	1	NS300-10-300
11 mm	250 mm	1	NS300-11-250
11 mm	300 mm	1	NS300-11-300
11 mm	350 mm	1	NS300-11-350
12 mm	400 mm	1	NS300-12-400
13 mm	450 mm	1	NS300-13-450

Tournevis à fente Ergo™ antidéflagrant

ergo®



### NSB300

Ø	L	Q	Q
3 mm	50 mm	1	NSB300-3-50
3 mm	75 mm	1	NSB300-3-75
4 mm	75 mm	1	NSB300-4-75
4.5 mm	60 mm	1	NSB300-4.5-50
4.5	95	1	NSB300-4.5-100
5 mm	75 mm	1	NSB300-5-75
5 mm	100 mm	1	NSB300-5-100
6	105	1	NSB300-6-100
6 mm	125 mm	1	NSB300-6-125
6 mm	160 mm	1	NSB300-6-150
7 mm	150 mm	1	NSB300-7-150
8	150	1	NSB300-8-150
8 mm	200 mm	1	NSB300-8-200

Ø	L	Q	Q
9 mm	250 mm	1	NSB300-9-250
9 mm	200 mm	1	NSB300-10-200
10	318	1	NSB300-10-300
11 mm	250 mm	1	NSB300-11-250
11 mm	300 mm	1	NSB300-11-300
11	350	1	NSB300-11-350
12	400	1	NSB300-12-400
13	450	1	NSB300-13-450

Tournevis d'électricien antidéflagrants AL-BR

ergo®



### NS301

Ø	L	Q	Q
3 mm	50 mm	1	NS301-3-50
4 mm	100 mm	1	NS301-4-100
4 mm	150 mm	1	NS301-4-150
5 mm	100 mm	1	NS301-5-100
5 mm	200 mm	1	NS301-5-200
6 mm	100 mm	1	NS301-6-100
8 mm	150 mm	1	NS301-8-150
10 mm	200 mm	1	NS301-10-200
10 mm	300 mm	1	NS301-10-300

Tournevis Electricien antidéflagrants CU-BE

ergo®



### NSB301

Ø	L	Q	Q
3 mm	50 mm	1	NSB301-3-50
4 mm	100 mm	1	NSB301-4-100
4 mm	150 mm	1	NSB301-4-150
5 mm	100 mm	1	NSB301-5-100
5 mm	210 mm	1	NSB301-5-200
6 mm	100 mm	1	NSB301-6-100
8 mm	155 mm	1	NSB301-8-150
10 mm	200 mm	1	NSB301-10-200
10 mm	300 mm	1	NSB301-10-300

Tournevis antidéflagrant Ergo™ Phillips® AL-BR

ergo®



### NS302

Ø	L	Q	Q
PH0	50 mm	1	NS302-0-50
PH1	100 mm	1	NS302-1-100
PH2	125 mm	1	NS302-2-125
PH3	150 mm	1	NS302-3-150
PH4	300 mm	1	NS302-4-300

Tournevis Ergo™ Phillips® antidéflagrant

ergo®



### NSB302

Ø	L	Q	Q
PH0	65	1	NSB302-0-50
PH1	120	1	NSB302-1-100
PH2	125	1	NSB302-2-125
PH3	150	1	NSB302-3-150
PH4	300	1	NSB302-4-300

Tournevis antidéflagrant Ergo™ Pozidriv® AL-BR

ergo®



### NS304

Ø	L	Q	Q
PZ0	50 mm	1	NS304-0-50
PZ1	100 mm	1	NS304-1-100
PZ2	125 mm	1	NS304-2-125
PZ3	150 mm	1	NS304-3-150
PZ4	300 mm	1	NS304-4-300



Tournevis Ergo™ Pozidriv® antidéflagrant



**NSB304**

PZ0	50	1	NSB304-0-50	
PZ1	100	1	NSB304-1-100	
PZ2	125	1	NSB304-2-125	
PZ3	150	1	NSB304-3-150	
PZ4	300	1	NSB304-4-300	

Clés mâles coudées antidéflagrantes AL-BR



**NS320**

2	1	NS320-2	
3	1	NS320-3	
4	1	NS320-4	
5	1	NS320-5	
6	1	NS320-6	
7	1	NS320-7	
8	1	NS320-8	
9	1	NS320-9	
10	1	NS320-10	

Clés mâles coudées antidéflagrantes CU-BE



**NSB320**

2	1	NSB320-2	
3	1	NSB320-3	
4	1	NSB320-4	
5	1	NSB320-5	
6	1	NSB320-6	
7	1	NSB320-7	
8	1	NSB320-8	
9	1	NSB320-9	
10	1	NSB320-10	

**PINCES**

Pince universelle antidéflagrante AL-BR



**NS400**

155	1	NS400-160
175	1	NS400-180
200	1	NS400-200

Pinces multiprises antidéflagrantes AL-BR



**NS412**

200	1	NS412-200

Pince coupante antidéflagrante CU-BE



**NSB400**

157	1	NSB400-160
175	1	NSB400-180
200	1	NSB400-200

Pinces multiprises antidéflagrantes CU-BE



**NSB412**

200	1	NSB412-200

Pince coupante diagonale antidéflagrante AL-BR



**NS402**

150	1	NS402-160
200	1	NS402-200

Pince coupante diagonale antidéflagrante CU-BE



**NSB402**

155	1	NSB402-160
200	1	NSB402-200

Pince coupante diagonale antidéflagrante grande capacité AL-BR



**NS403**

150	1	NS403-160
180	1	NS403-180

Pince coupante diagonale antidéflagrante grande capacité CU-BE



**NSB403**

155	1 NSB403-160
180	1 NSB403-180

Pince à becs plats antidéflagrante AL-BR



**NS404**

150	1 NS404-160

Pince à becs plats antidéflagrante CU-BE



**NSB404**

155	1 NSB404-160

Pince à becs ronds antidéflagrante AL-BR



**NS405**

160	1 NS405-160

Pince à becs ronds antidéflagrante CU-BE



**NSB405**

155	1 NSB405-160

Pincettes à becs plats antidéflagrantes AL-BR



**NS406**

160	1 NS406-160
180	1 NS406-180
200	1 NS406-200

Pince à becs longs antidéflagrante CU-BE



**NSB406**

155	1 NSB406-160
180	1 NSB406-180
200	1 NSB406-200

Pince à dénuder antidéflagrante AL-BR



**NS407**

170	1 NS407-160

Pince à dénuder antidéflagrante CU-BE

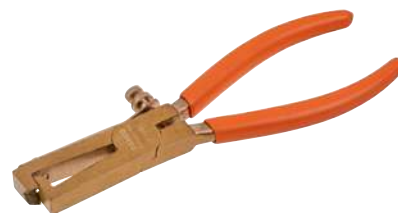

**NSB407**

170	1 NSB407-160

Pince multiprise antidéflagrante AL-BR



**NS408**

260	1 NS408-250
300	1 NS408-300

Pince multiprise antidéflagrante CU-BE



**NSB408**

255	1 NSB408-250
300	1 NSB408-300

Pincettes serre-tubes antidéflagrantes AL-BR



**NS411**

200	1 NS411-200



Pinces serre-tubes antidéflagrantes CU-BE



**NSB411**

Longueur (mm)	Quantité	Modèle
205	1	NSB411-200

Tenaille antidéflagrante AL-BR



**NS413**

Longueur (mm)	Quantité	Modèle
180	1	NS413-180
195	1	NS413-200

Tenaille antidéflagrante CU-BE



**NSB413**

Longueur (mm)	Quantité	Modèle
185	1	NSB413-180
195	1	NSB413-200

**MARTEAUX, LEVIERS ET BURINS**

Marteau de serrurier antidéflagrant, type allemand, manche hickory



**NS500**

Longueur (mm)	Quantité	Modèle
2000	1	NS500-2000
2500	1	NS500-2500
3000	1	NS500-3000
4000	1	NS500-4000

Marteau de machiniste antidéflagrant manche en fibre de verre



**NS504-FB**

Longueur (mm)	Quantité	Modèle
100	1	NS504-100-FB
200	1	NS504-200-FB
300	1	NS504-300-FB
500	1	NS504-500-FB
800	1	NS504-800-FB
1000	1	NS504-1000-FB
1500	1	NS504-1500-FB
2000	1	NS504-2000-FB

Marteau de serrurier à panne ronde antidéflagrant, manche hickory AL-BR



**NS506**

Longueur (mm)	Quantité	Modèle
340	1	NS506-300
450	1	NS506-450
670	1	NS506-700
910	1	NS506-900

Marteau à panne fendue antidéflagrant AL-BR



**NS508-FB**

Longueur (mm)	Quantité	Modèle
500	1	NS508-500-FB
700	1	NS508-700-FB

Marteau pioche antidéflagrants AL-BR



**NS512-FB8**

Longueur (mm)	Quantité	Modèle
230	1	NS512-200-FB
400	1	NS512-400-FB
640	1	NS512-600-FB
970	1	NS512-900-FB

Marteau antidéflagrant manche fibre de verre



**NS502-FB**

Longueur (mm)	Quantité	Modèle
450	1	NS502-450-FB
1000	1	NS502-1000-FB
1500	1	NS502-1500-FB
2000	1	NS502-2000-FB
2500	1	NS502-2500-FB
3000	1	NS502-3000-FB
4500	1	NS502-4500-FB
5000	1	NS502-5000-FB
6800	1	NS502-6800-FB
8000	1	NS502-8000-FB
10000	1	NS502-10000-FB
12000	1	NS502-12000-FB

Marteau de mécanicien antidéflagrant CU-BE manche en fibre de verre



**NS5B04-FB**

Longueur	Quantité	Modèle
100	1	NSB504-100-FB
200	1	NSB504-200-FB
300	1	NSB504-300-FB
500	1	NSB504-500-FB
800	1	NSB504-800-FB
1000	1	NSB504-1000-FB
1500	1	NSB504-1500-FB
2000	1	NSB504-2000-FB

Marteau de serrurier à panne ronde antidéflagrant, manche hickory CU-BE



**NSB506**

Longueur	Quantité	Modèle
300	1	NSB506-300
450	1	NSB506-450
680	1	NSB506-700
910	1	NSB506-900

Marteau de serrurier antidéflagrant, type allemand, manche fibre de verre AL-BR



**NS500-FB**

Longueur	Quantité	Modèle
1000	1	NS500-1000-FB
1500	1	NS500-1500-FB
2000	1	NS500-2000-FB
2500	1	NS500-2500-FB
3000	1	NS500-3000-FB
3500	1	NS500-3500-FB

Marteau de serrurier antidéflagrant, type allemand, manche hickory CU-BE



**NSB500**

Longueur	Quantité	Modèle
2000	1	NSB500-2000
2500	1	NSB500-2500
3000	1	NSB500-3000
4000	1	NSB500-4000

Marteau à panne fendue antidéflagrant CU-BE



**NSB508-FB**

Longueur	Quantité	Modèle
500	1	NSB508-500-FB
700	1	NSB508-700-FB

Marteau de serrurier à panne ronde antidéflagrant, manche fibre de verre



**NS506-FB**

Longueur	Quantité	Modèle
310	1	NS506-300-FB
470	1	NS506-450-FB
700	1	NS506-700-FB
910	1	NS506-900-FB

Massette antidéflagrante CU-BE manche en fibre de verre



**NSB502-FB**

Longueur	Quantité	Modèle
450	1	NSB502-450-FB
1000	1	NSB502-1000-FB
1500	1	NSB502-1500-FB
2000	1	NSB502-2000-FB
2500	1	NSB502-2500-FB
3000	1	NSB502-3000-FB
4500	1	NSB502-4500-FB
5000	1	NSB502-5000-FB
6800	1	NSB502-6800-FB
8000	1	NSB502-8000-FB
10000	1	NSB502-10000-FB
12000	1	NSB502-12000-FB

Marteau pioche antidéflagrants CU-BE



**NSB512-FB**

Longueur	Quantité	Modèle
200	1	NSB512-200-FB
400	1	NSB512-400-FB
600	1	NSB512-600-FB
900	1	NSB512-900-FB

Marteau de serrurier antidéflagrant, type allemand, manche fibre de verre CU-BE



**NSB500-FB**

Longueur	Quantité	Modèle
1000	1	NSB500-1000-FB
1500	1	NSB500-1500-FB
2000	1	NSB500-2000-FB
2500	1	NSB500-2500-FB
3000	1	NSB500-3000-FB
3500	1	NSB500-3500-FB



Marteau de serrurier à panne ronde antidéflagrant CU-BE manche en fibre de verre



**NSB506-FB**

Length (mm)	Quantity	Part Number
300	1	NSB506-300-FB
450	1	NSB506-450-FB
680	1	NSB506-700-FB
900	1	NSB506-900-FB

Length (mm)	Quantity	Part Number
150	1	NSB600-150-25
150	1	NSB600-150-30
150	1	NSB600-150-40
150	1	NSB600-150-50
180	1	NSB600-180-13
180	1	NSB600-180-32
180	1	NSB600-180-50
200	1	NSB600-200-20
200	1	NSB600-200-30
200	1	NSB600-200-40
200	1	NSB600-200-50
230	1	NSB600-230-40
250	1	NSB600-250-40
300	1	NSB600-300-50

Burin coupe transversale antidéflagrant AL-BR



**NS604**

Length (mm)	Quantity	Part Number
140	1	NS604-150
200	1	NS604-200
300	1	NS604-300

Coin antidéflagrant



**NS600**

Length (mm)	Quantity	Part Number
80	1	NS600-80-13
100	1	NS600-100-50
135	1	NS600-135-50
150	1	NS600-150-25
150	1	NS600-150-30
150	1	NS600-150-40
150	1	NS600-150-50
180	1	NS600-180-13
180	1	NS600-180-32
180	1	NS600-180-50
200	1	NS600-200-20
200	1	NS600-200-30
200	1	NS600-200-40
200	1	NS600-200-50
230	1	NS600-230-40
250	1	NS600-250-40
300	1	NS600-300-50

Pince à décoffrer antidéflagrante AL-BR



**NS602**

Width (mm)	Length (mm)	Quantity	Part Number
16	460	1	NS602-460
20	600	1	NS602-600
22	760	1	NS602-760
22	935	1	NS602-900

Burin coupe transversale antidéflagrant CU-BE



**NSB604**

Length (mm)	Quantity	Part Number
140	1	NSB604-150
200	1	NSB604-200
300	1	NSB604-300

Coins antidéflagrants CU-BE



**NSB600**

Length (mm)	Quantity	Part Number
80	1	NSB600-80-13
100	1	NSB600-100-50
135	1	NSB600-135-50

Pince à décoffrer antidéflagrante CU-BE



**NSB6028**

Width (mm)	Length (mm)	Quantity	Part Number
16 mm	460	1	NSB602-460
20 mm	600	1	NSB602-600
22 mm	760	1	NSB602-760
22 mm	920	1	NSB602-900

Burin dé mécanicien antidéflagrant AL-BR



**NS606**

Length (mm)	Quantity	Part Number
150	1	NS606-150
200	1	NS606-200
250	1	NS606-250
300	1	NS606-300
400	1	NS606-400

Burin de mécanicien antidéflagrant CU-BE



**NSB606**

Length (mm)	Quantity	Part Number
150	1	NSB606-150
200	1	NSB606-200
250	1	NSB606-250
300	1	NSB606-300
400	1	NSB606-400

Pointeau antidéflagrant AL-BR



**NS608**

Length (mm)	Quantity	Part Number
100	1	NS608-100

Pointeau antidéflagrant CU-BE



**NSB608**

Length (mm)	Quantity	Part Number
100	1	NSB608-100

**GRATTOIRS**

Grattoir d'angle antidéflagrant AL-BR



**NS700**

Width (mm)	Length (mm)	Quantity	Part Number
45	300	1	NS700-300

Grattoir coudé antidéflagrant



**NSB700**

Width (mm)	Length (mm)	Quantity	Part Number
45	310	1	NSB700-300

Couteau de peintre plat antidéflagrant



**NS702**

Width (mm)	Length (mm)	Quantity	Part Number
30	325	1	NS702-200

Grattoir plat antidéflagrant



**NSB702**

Width (mm)	Length (mm)	Quantity	Part Number
20	325	1	NSB702-200

Lame de grattoir antidéflagrante longue AL-BR



**NS704**

Width (mm)	Length (mm)	Quantity	Part Number
100	225	1	NS704-225

Grattoir antidéflagrant, grande lame



**NSB704**

Width (mm)	Length (mm)	Quantity	Part Number
100	720	1	NSB704-225



Couteau de peintre flexible antidéflagrant AL-BR



**NS706**

	L		
50	200	1	NS706-50
80	200	1	NS706-80

Grattoir antidéflagrant lame flexible



**NSB706**

	L		
50	200	1	NSB706-50
80	200	1	NSB706-80

Grattoir 3 faces antidéflarant



**NS708**

L		
440	1	NS708-360

Grattoir trois carré triangulaire antidéflagrant



**NSB708**

L		
450	1	NSB708-360

Grattoir triangulaire antidéflagrant AL-BR



**NS710**

L		
470	1	NS710-450

Grattoir lame triangulaire antidéflagrant



**NSB710**

L		
470	1	NSB710-450

**GRANDS OUTILS ET OUTILS DE BALCON**

Pioche antidéflagrante AL-BR



**NS800**

L		
910	1	NS800-1100
910	1	NS800-1700
965	1	NS800-2000

Pioche antidéflagrante CU-BE



**NSB800**

L		
910	1	NSB800-1100
910	1	NSB800-1700
910	1	NSB800-2000

Pelle ronde antidéflagrante AL-BR



**NS802**

L		
1370	1	NS802-290



Pelle ronde antidéflagrante CU-BE



**NSB802**



1450



1 NSB802-290

Brosse antidéflagrante



**NS804**



290



1 NS804-290

Extracteurs à 3 griffes réversibles antidéflagrants - CU-BE



**NSB810**



50-100 mm	105 mm	1	NSB810-100
60-150 mm	175 mm	1	NSB810-150
70-200 mm	250 mm	1	NSB810-200
80-350 mm	320 mm	1	NSB810-350

**EXTRACTEURS**

Extracteur à 3 griffes réversibles antidéflagrant AL-BR



**NS810**



50-100 mm	105 mm	1	NS810-100
60-150 mm	175 mm	1	NS810-150
70-200 mm	250 mm	1	NS810-200
80-350 mm	320 mm	1	NS810-350



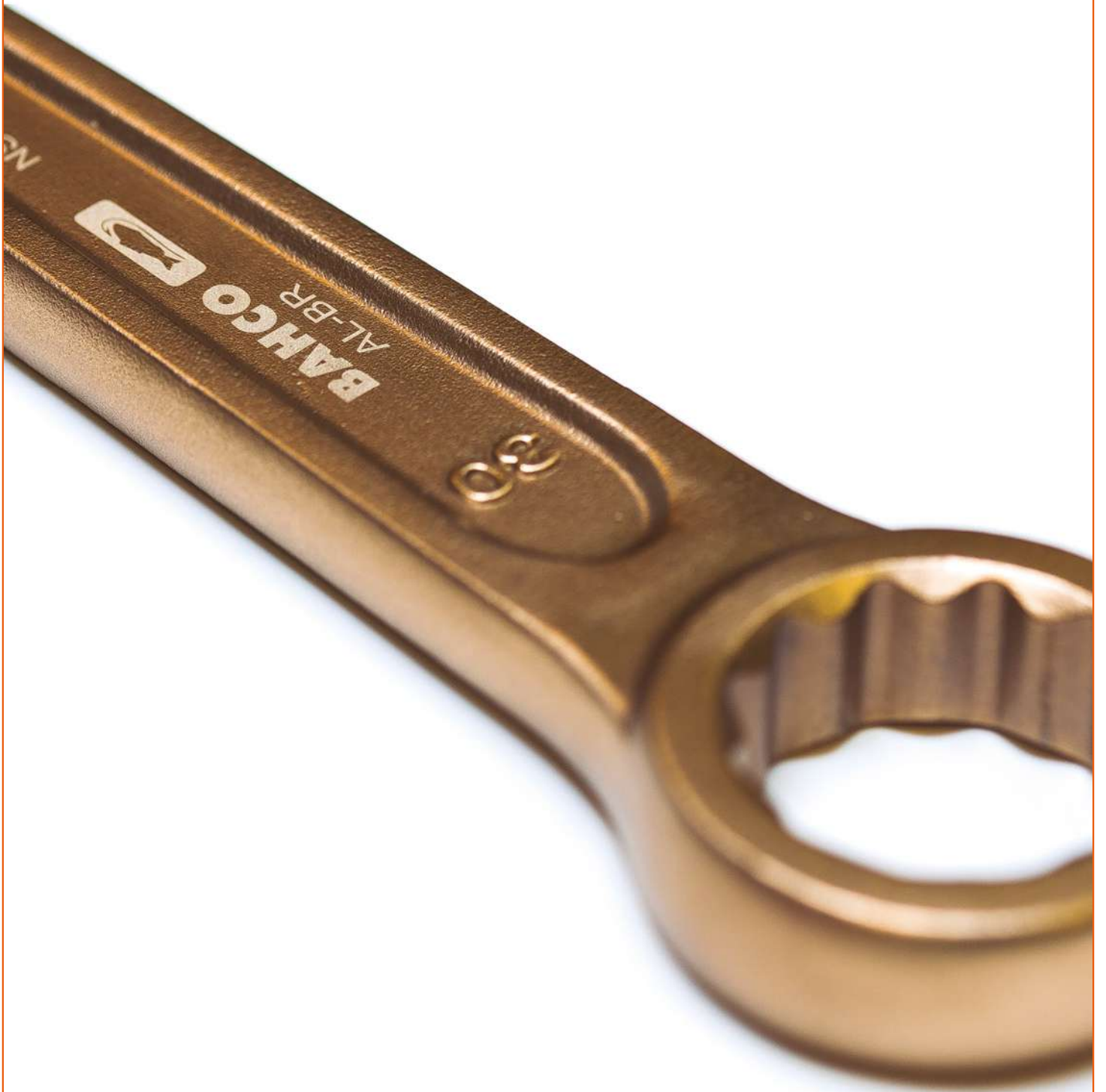

**BAHCO**



## Outils en acier inoxydable



## SERVANTES D'ATELIER

Servante d'atelier robuste 7 tiroirs acier inoxydable  
Châssis, tiroirs, glissières et roues en acier inoxydable



### 1470K7SS



956 x 500 x 762 mm

1 1470K7SS

Servante d'atelier robuste 7 tiroirs acier inoxydable  
Châssis, tiroirs, glissières et roues en acier inoxydable



### 1475KXL7SS



986 x 501 x 1100 mm

1 1475KXL7SS

## CLÉS

Clé à molette écrou central en acier inoxydable



### SS001



Size	Length (mm)	Weight (g)	Part No.
100mm/4"	13		SS001-100
150mm/6"	18		SS001-150
200mm/8"	24		SS001-200
250mm/10"	30		SS001-250
300mm/12"	36		SS001-300
375mm/15"	46		SS001-375
450mm/18"	55		SS001-450
600mm/24"	60		SS001-600

Clé mixte en acier inoxydable, métrique



### SS002



Size	Length (mm)	Weight (g)	Part No.
6 mm	105		SS002-6
8 mm	120		SS002-8
10 mm	120		SS002-10
11 mm	135		SS002-11
12 mm	135		SS002-12
13 mm	150		SS002-13
14 mm	150		SS002-14
15 mm	175		SS002-15
16 mm	175		SS002-16
17 mm	195		SS002-17
19 mm	195		SS002-19
21 mm	195		SS002-21
22 mm	215		SS002-22
24 mm	215		SS002-24
27 mm	215		SS002-27
32 mm	245		SS002-32

Jeu de clés mixtes en acier inoxydable, métrique  
6 pièces



### SS002-6-2



Quantity	Weight (g)	Part No.
6	710	SS002-6-2

SS002-8, SS002-10, SS002-12, SS002-14,  
SS002-17, SS002-19

Jeu de clés mixtes en acier inoxydable, métrique  
9 pièces



### SS002-9-2



Quantity	Weight (g)	Part No.
9	924	SS002-9-2

SS002-8, SS002-10, SS002-11, SS002-12,  
SS002-13, SS002-14, SS002-15, SS002-17,  
SS002-19



Clé mixte en acier inoxydable, pouces



### SS003



Size	Length (mm)	Weight (g)	Part No.
1/4 in	105		SS003-8
5/16 in	120		SS003-10
11/32 in	135		SS003-11
3/8 in	135		SS003-12
7/16 in	150		SS003-14
1/2 in	175		SS003-16
9/16 in	175		SS003-18
5/8 in	195		SS003-20
11/16 in	195		SS003-22
3/4 in	215		SS003-24
25/32 in	215		SS003-25
13/16 in	245		SS003-26
7/8 in	245		SS003-28
15/16 in	265		SS003-30

Clé polygonale double, contre coudée en acier inoxydable, métrique



### SS011



Size	Length (mm)	Weight (g)	Part No.
5.5*7 mm	180		SS011-0507
6*7 mm	180		SS011-0607
8*9 mm	190		SS011-0809
8*10 mm	190		SS011-0810
9*11 mm	215		SS011-0911
10*12 mm	215		SS011-1012
12*14 mm	225		SS011-1214
14*17 mm	255		SS011-1417
16*18 mm	280		SS011-1618
17*19 mm	280		SS011-1719
17*22 mm	300		SS011-1722
22*24 mm	330		SS011-2224
24*27 mm	340		SS011-2427
24*30 mm	350		SS011-2430
30*32 mm	370		SS011-3032

Jeu de clés polygonales doubles contre-coudées en acier inoxydable, métrique  
9 pièces



### SS011-9-3

9	2470	1	SS011-9-3

SS011-0810, SS011-1012, SS011-1214, SS011-1417, SS011-1719, SS011-1722, SS011-2224, SS011-2427, SS011-3032

Jeu de clés polygonales doubles contre-coudées en acier inoxydable, métrique  
11 pièces



### SS011-11-3

11	3100	1	SS011-11-3

SS011-0810, SS011-0911, SS011-1012, SS011-1214, SS011-1417, SS011-1719, SS011-1722, SS011-2224, SS011-2427, SS011-2430, SS011-3032

## DOUILLES ET CLIQUETS

Douille 1/4" en acier inoxydable, 6 pans, métrique



### SS210

4 mm	25	1	SS210-4
4.5 mm	25	1	SS210-4.5

5 mm	25	1	SS210-5
5.5 mm	25	1	SS210-5.5
6 mm	25	1	SS210-6
7 mm	25	1	SS210-7
8 mm	25	1	SS210-8
9 mm	25	1	SS210-9
10 mm	25	1	SS210-10
11 mm	25	1	SS210-11
12 mm	26	1	SS210-12
13 mm	26	1	SS210-13
14 mm	26	1	SS210-14

Douille 1/2" en acier inoxydable, 6 pans, métrique



### SS220

8 mm	40	1	SS220-8
9 mm	40	1	SS220-9
10 mm	40	1	SS220-10
11 mm	40	1	SS220-11
12 mm	40	1	SS220-12
13 mm	40	1	SS220-13
14 mm	40	1	SS220-14
15 mm	40	1	SS220-15
16 mm	40	1	SS220-16
17 mm	40	1	SS220-17
18 mm	42	1	SS220-18
19 mm	42	1	SS220-19
20 mm	42	1	SS220-20
21 mm	43	1	SS220-21
22 mm	43	1	SS220-22
23 mm	43	1	SS220-23
24 mm	43	1	SS220-24
25 mm	43	1	SS220-25
26 mm	43	1	SS220-26
27 mm	46	1	SS220-27
28 mm	46	1	SS220-28
29 mm	46	1	SS220-29
30 mm	46	1	SS220-30
31 mm	46	1	SS220-31
32 mm	46	1	SS220-32

Douille 3/4" en acier inoxydable, 6 pans, métrique



### SS224

17 mm	50	1	SS224-17
19 mm	50	1	SS224-19
22 mm	55	1	SS224-22
24 mm	55	1	SS224-24
27 mm	55	1	SS224-27
30 mm	60	1	SS224-30
32 mm	60	1	SS224-32
34 mm	60	1	SS224-34
36 mm	60	1	SS224-36
41 mm	65	1	SS224-41
46 mm	65	1	SS224-46
50 mm	70	1	SS224-50
55 mm	75	1	SS224-55
60 mm	75	1	SS224-60
65 mm	80	1	SS224-65

Rallonge en acier inoxydable



### SS234

100 mm	1	SS234-16-100
200 mm	1	SS234-16-200
250 mm	1	SS234-16-250
100 mm	1	SS234-24-100
200 mm	1	SS234-24-200
250 mm	1	SS234-24-250

Cardan universel en acier inoxydable



### SS236

56 mm	1	SS236-08-80
80 mm	1	SS236-16-80
110 mm	1	SS236-24-110



Poignée coulissante en T en acier inoxydable



**SS238**

L			
250	1	SS238-08-250	
250	1	SS238-16-250	
350	1	SS238-24-350	

Vilebrequin en acier inoxydable



**SS243**

L			
300 mm	1	SS243-08	
390 mm	1	SS243-16	
450 mm	1	SS243-24	

Cliquet réversible en acier inoxydable



**SS242**

L			
200 mm	1	SS242-08-200	
245 mm	1	SS242-16-245	
320 mm	1	SS242-24-320	

**TOURNEVIS**

Tournevis Ergo™ acier inoxydable  
Pour vis à fente



**BE-8020i - BE-8252i**

	L		
3.0	60	5	BE-8020i
3.5	75	5	BE-8030i

	L		
4.0	100	5	BE-8040i
5.5	125	5	BE-8241i
6.5	150	5	BE-8252i

Tournevis Ergo™ acier inoxydable  
Pour vis Phillips®



**BE-8600i - BE-8623i**

	L		
PH 0	60	5	BE-8600i
PH 1	75	5	BE-8610i
PH 2	100	5	BE-8620i
PH 3	150	5	BE-8623i

Tournevis Ergo™ acier inoxydable  
Pour vis Pozidriv®



**BE-8800i - BE-8823i**

	L		
PZ 0	60	5	BE-8800i
PZ 1	75	5	BE-8810i
PZ 2	100	5	BE-8820i
PZ 3	150	5	BE-8823i

Tournevis Ergo™ acier inoxydable  
Pour vis TORX®



**BE-8910i - BE-8925i**

	L		
T 10	75	5	BE-8910i
T 15	100	5	BE-8915i
T 20	100	5	BE-8920i
T 25	125	5	BE-8925i

Jeu de 6 tournevis Ergo™ acier inoxydable  
Pour vis à fente et Phillips®



**BE-9881i**

6		1	BE-9881i

BE-8020i, BE-8040i, BE-8241i, BE-8252i

BE-8610i, BE-8620i

Jeu de 6 tournevis Ergo™ acier inoxydable  
Pour vis à fente et Pozidriv®



**BE-9882i**

6		1	BE-9882i

BE-8020i, BE-8040i, BE-8241i, BE-8252i

BE-8810i, BE-8820i

**CLÉS MÂLES**

Jeu de 13 clés mâles coudées 6 pans à tête sphérique, acier inoxydable, pouces



**BE-9785i**

0.05; 1/16; 5/64; 3/32; 7/64; 1/8; 9/64; 5/32; 3/16; 7/32; 1/4; 5/16; 3/8; mm		1	BE-9785i

Clé mâle 6 pans à tête sphérique en acier inoxydable, métrique



**SS324**

1.5	1 SS324-1.5
2	1 SS324-2
2.5	1 SS324-2.5
3	1 SS324-3
4	1 SS324-4
5	1 SS324-5
6	1 SS324-6
8	1 SS324-8
10	1 SS324-10

Jeu de 9 clés mâles coudées 6 pans à tête sphérique en acier inoxydable, 9 pcs, métriques



**BE-9770i**

1.5; 2; 2.5; 3; 4; 5; 6; 8; 10 mm	20 BE-9770i

SS324-1.5, SS324-2, SS324-2.5, SS324-3, SS324-4, SS324-5, SS324-6, SS324-8, SS324-10

Clé mâle 6 pans à tête sphérique en acier inoxydable, pouces



**SS325**

5/64" in	1 SS325-2.5
7/64" in	1 SS325-3.5
1/8" in	1 SS325-4
9/64" in	1 SS325-4.5
5/32" in	1 SS325-5
3/16" in	1 SS325-6
7/32" in	1 SS325-7
1/4" in	1 SS325-8
5/16" in	1 SS325-10
3/8" in	1 SS325-12
3/32" in	1 SS325-3

Jeu de 13 clés mâles coudées à tête sphérique acier inoxydable, 6 pans en pouces



**BE-9786i**

0.05; 1/16; 5/64; 3/32; 7/64; 1/8; 9/64; 5/32; 3/16; 7/32; 1/4; 5/16; 3/8; mm	1 BE-9786i

SS325-2.5, SS325-3, SS325-3.5, SS325-4, SS325-4.5, SS325-5, SS325-6, SS325-7, SS325-8, SS325-10, SS325-12

**EMBOUS**

Embouts à torsion en acier inoxydable Phillips - 25 mm



**65I/PH**

10	1	1 65I/PH1
2	1	1 65I/PH1-2P
10	2	1 65I/PH2
2	2	1 65I/PH2-2P
10	3	1 65I/PH3
2	3	1 65I/PH3-2P

Embouts à torsion en acier inoxydable Pozidriv - 25 mm



**65I/PZ**

10	1	1 65I/PZ1
2	1	1 65I/PZ1-2P
10	2	1 65I/PZ2
2	2	1 65I/PZ2-2P
10	3	1 65I/PZ3
2	3	1 65I/PZ3-2P

Embouts à torsion en acier inoxydable Torx® - 25 mm



**65I/T**

5	T10	1 65I/T10
2	T10	1 65I/T10-2P
5	T15	1 65I/T15
2	T15	1 65I/T15-2P
5	T20	1 65I/T20
2	T20	1 65I/T20-2P
5	T25	1 65I/T25
2	T25	1 65I/T25-2P
5	T30	1 65I/T30
2	T30	1 65I/T30-2P
5	T40	1 65I/T40
2	T40	1 65I/T40-2P

Support universel pour embouts en acier inoxydable avec anneau de retenue 1/4" - 75 mm. Boîte plastique de 5 pièces et modèle KSR753-1P par unité sur support plastique



**KSR753**

1	1/4"	1 KSR753-1P
5	1/4"	1 KSR753

Jeu d'embouts à torsion en acier inoxydable - 7 pcs



**65I/7**

22 x 65 x 75 mm		1 65I/7-1

65I/PH2	
65I/PZ2	
65I/T15, 65I/T20, 65I/T25, 65I/T30	



## PINCES

Pince universelle en acier inoxydable



### SS400

L	
155	1 SS400-160
175	1 SS400-180
200	1 SS400-200

Pince coupante diagonale en acier inoxydable



### SS402

L	
150	1 SS402-160
195	1 SS402-200

Pince deux positions en acier inoxydable



### SS412

L	
200	1 SS412-200

Pince à bec demi-ronds en acier inoxydable



### SS406

L	
150	1 SS406-160
175	1 SS406-200

Pince multiprises en acier inoxydable



### SS410

L	
250	1 SS410-250
300	1 SS410-300

Pince-étau en acier inoxydable



### SS415

L	
255	1 SS415-225

## MARTEAUX

Marteau rivoir en acier inoxydable



### SS506

L	
200	1 SS506-200-FB
300	1 SS506-300-FB
450	1 SS506-500-FB

L	
680	1 SS506-700-FB
900	1 SS506-900-FB
1100	1 SS506-1100-FB

Massette en acier inoxydable



### SS502

L	
1000	1 SS502-1000-FB
1500	1 SS502-1500-FB
2000	1 SS502-2000-FB
2500	1 SS502-2500-FB
3000	1 SS502-3000-FB
3600	1 SS502-3600-FB

## POINÇONS ET BURINS

Pied de biche en acier inoxydable



### SS603

L	
500	1 SS603-15-500
500	1 SS603-19-500
500	1 SS603-20-500
500	1 SS603-23-500
800	1 SS603-23-800
600	1 SS603-25-600
1000	1 SS603-30-1000

Burin plat en acier inoxydable



### SS610

L	
160	1 SS610-16-160
200	1 SS610-18-200
300	1 SS610-24-300
400	1 SS610-25-400
500	1 SS610-30-500



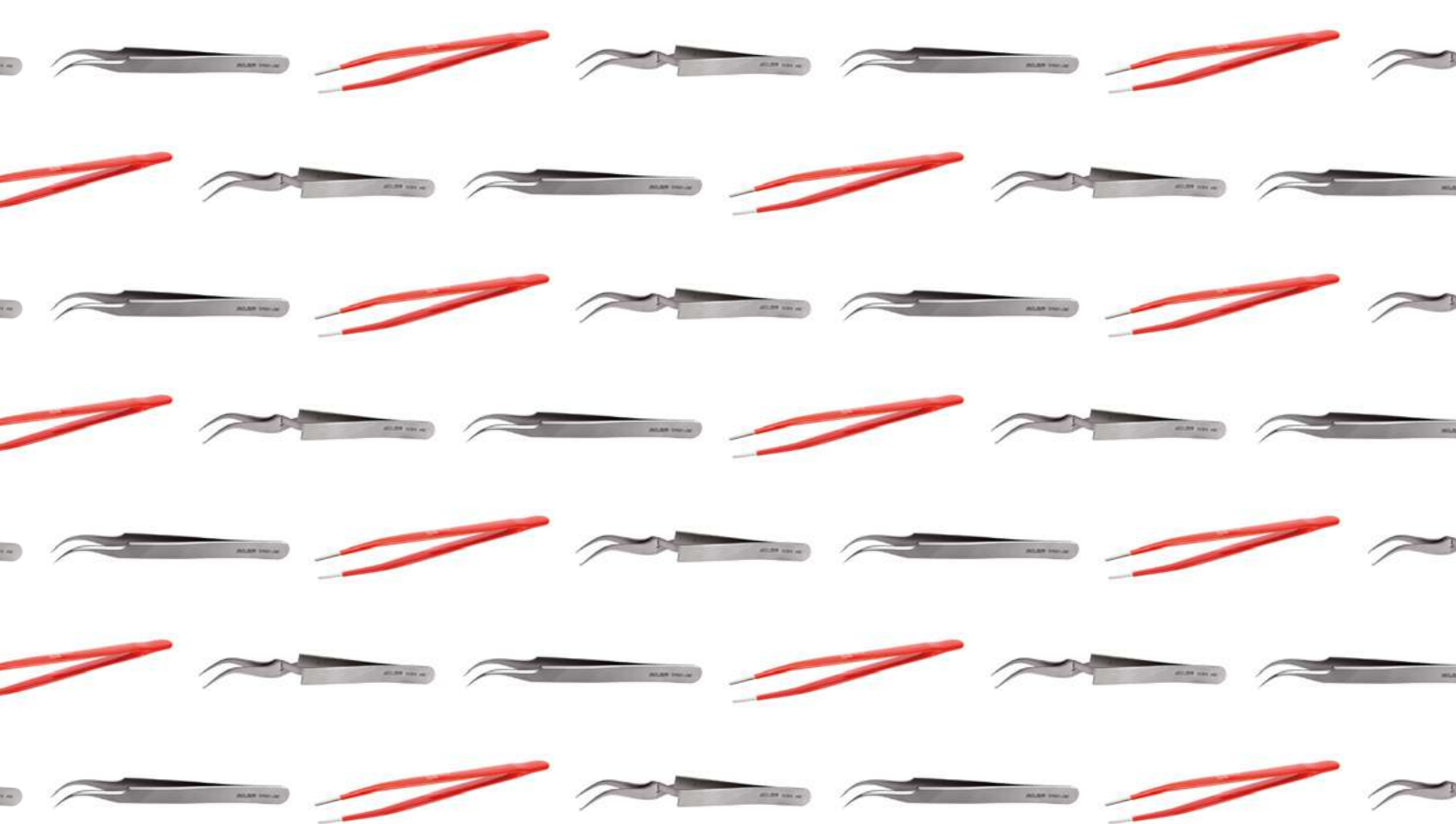

## Brucelles et autres outils pour l'électronique



## BRUCELLES

Brucelles multi-usage, Acier spécial



**5468**



112



5 5468-112

Brucelles multi-usage, Acier spécial



**5469**



127

127

127



5 5469-127

5 5469 R

5 5469 I

Brucelle multi-usage, Acier spécial



**5469B**



120

120

120



5 5469 B

5 5469 BI

5 5469 BR

Brucelles pointue, acier spécial



**5479**



130



5 5479-130

Brucelles multi-usage, Acier spécial



**5471F**



120

145

200

250

300

120

145

200

120

145



5 5471 F-120

5 5471 F-145

5 5471 F-200

5 5471 F-250

5 5471 F-300

5 5471 FI-120

5 5471 FI-145

5 5471 FI-200

5 5471 FR-120

5 5471 FR-145

Brucelles multi-usage, acier spécial



**5475R/5475K**



150

100



5 5475 R

5 5475 K

Brucelles multi-usage, acier spécial



**5516**



150

150



5 5516

5 5516 I

Brucelles antimagnétique, Titane



**5463AMT**



120



5 5463 AMT

Brucelles antimagnétique, Titane



**5465AMT**



110



5 5465 AMT

Brucelles antimagnétique gainée en PVC  
Acier inoxydable anti-acide



**5469AMI**



130



1 5469 AMI

Brucelles pointue, Acier spécial



**5517**



155

155



5 5517

5 5517 I

Pince Brucelle à becs croisés, acier spécial



**5518**



155



5 5518

Brucelles pour prise, acier inoxydable antimagnétique



**5575**



145



5 5575-145

Brucelles CMS pour l'électronique  
Acier inoxydable antimagnétique, anti-acide



**5540AM**



120



5 5540 AM

Brucelle CMS pour l'électronique  
Acier inoxydable antimagnétique, anti-acide



**5545AM**



120



5 5545 AM

Brucelles pour prise  
Acier inoxydable antimagnétique - pointes revêtues



**5576**



145



5 5576-145

Brucelles CMS pour l'électronique  
Acier inoxydable antimagnétique, anti-acide



**5541AM**



120



5 5541 AM

Brucelles CMS pour l'électronique  
Acier inoxydable antimagnétique, anti-acide



**5546AM**



120



5 5546 AM

Brucelles CMS pour l'électronique  
Acier inoxydable antimagnétique, anti-acide



**5543AM**



120



5 5543 AM

Brucelle CMS pour l'électronique  
Acier inoxydable antimagnétique, anti-acide



**5547AM**



120



5 5547 AM

Assortiment de 7 Brucelles



**5570/7**



115



245



1 5570/7

Brucelles CMS pour l'électronique  
Acier inoxydable antimagnétique, anti-acide



**5544AM**



115



5 5544 AM

Brucelles CMS pour l'électronique  
Acier inoxydable antimagnétique, anti-acide



**5549AM**



120



5 5549 AM

5571-145	
5572-145	
5573-145	
5574-145	
5575-145	
5576-145	
5577-145	



Brucelles pour l'électronique  
Acier inoxydable antimagnétique, anti-acide



**5488AM**



115



5 5488 AM

Brucelles à sertir, acier inoxydable antimagnétique



**5572**



145



5 5572-145

Brucelles CMS pour l'électronique  
Acier inoxydable antimagnétique, anti-acide



**5588AM**



120



5 5588 AM

Brucelles pour l'électronique  
Acier inoxydable antimagnétique, anti-acide



**5489AM**



115



5 5489 AM

Brucelles à sertir, acier inoxydable antimagnétique



**5573**



145



5 5573-145

Brucelles CMS pour l'électronique  
Acier inoxydable antimagnétique, anti-acide



**5589AM**



120



5 5589 AM

Brucelles pour l'électronique  
Acier inoxydable antimagnétique, anti-acide



**5490AM**



115



5 5490 AM

Brucelles à sertir, Acier inoxydable antimagnétique



**5578**



122



5 5578-115

Brucelles CMS pour l'électronique  
Acier inoxydable antimagnétique, anti-acide



**5590AM**



120



5 5590 AM

Brucelles à sertir, acier inoxydable antimagnétique



**5571**



145



5 5571-145

Brucelles à sertir, acier inoxydable antimagnétique



**5579**



115



5 5579-115

Jeu de Brucelles CMS  
Acier inoxydable antimagnétique, anti-acide



**5568/5**



100



1 5568/5

- 5489 AM
- 5583 AM
- 5589 AM
- 5584 AM
- 5546 AM

Brucelles d'horloger , acier spécial



**5463**



120

120



5 5463-120

5 5463 R

Brucelles de bijoutier, acier spécial



**5470**



120

140

160

140

160

140

160



5 5470-120

5 5470-140

5 5470-160

5 5470 R-140

5 5470 R-160

5 5470 I-140

5 5470 I-160

Brucelles à billes, acier inoxydable antimagnétique



**5484R**



145



5 5484 R

Brucelles pinçante, acier spécial



**5473**



90



5 5473-90

Brucelles absorbant la chaleur  
Acier inoxydable antimagnétique - pointes en cuivre



**5577**



145



5 5577-145

Brucelles coupante pour l'électronique  
Acier inoxydable antimagnétique, anti-acide



**5493**



115



5 5493-115

Brucelles d'horloger , acier spécial



**5464**



110

110



5 5464-105

5 5464 R

Brucelle à souder, Acier spécial



**5476H**



160



5 5476 H

Brucelles d'horloger , Acier spécial



**5465**



105



5 5465 R

Brucelles à déssouder, Acier inoxydable antimagnétique



**5574**



145



5 5574-145



## OUTILS À SOUDER

Pistolet à souder



**3250**

100	400	1	325001000
		1	3250010SH

3250010SH : pointe de rechange

Fer à souder pour travaux difficiles



**322500**

30	370	1	322500300
40	375	1	322500500
80	380	1	322500800

Fer à souder électrique léger et compact



**32600**

18	390	1	326000200
25	420	1	326000300

Fer à souder électrique avec contrôle de température



**3270**

50	200-500 °C	1	327020500

Fer à souder électronique, solide et résistant



**329500**

30	380	1	329500300
40	420	1	329500400

Fer à souder pour travaux difficiles



**329600**

50	400	1	329600500
80	410	1	329600800

Pièces détachées pour fer à souder version droite et orientée



**3225**

st	1 322510300
ang	1 322510400
st	1 322510500
ang	1 322510600
ang	1 322510700
st	1 322510800

Pointes pour fer à souder



**326010**

5	1 326010200
5	1 326020200
5	1 326030200

Embouts de rechange fer à souder 3270  
SH1=rond 0,5mm; SH2=plat 2mm; SH3=plat 3mm;  
SH4=plat 4mm



**327020500-SH**

0,5mm	1 327020500-SH1
2mm	1 327020500-SH2
3mm	1 327020500-SH3
4mm	1 327020500-SH4

Embouts de rechange, forme ciseaux et forme crayon



**3295**

5	1 329500350
5	1 329500450

Embouts de rechange



**3296**

10	1 329600100
10	1 329600200

Pompe à dessouder



**3280**

58	1 328000000

Fil d'étain (Sn)  
Ø 0.8 mm



**3290**

mm	Icon	QTY	Part No.
2000		1	329000330
4000		1	329000500

Jeu de tire-ressorts, 6 pièces



**5419/6T**

mm	Icon	QTY	Part No.
5 x 78 x 110		1	5419/6T

Outils de syntonisation et d'équilibrage



**5551-5554**

mm	Icon	QTY	Part No.
220		1	5551
205		1	5552
195		1	5553
180		1	5554

## MÉCANIQUE DE PRÉCISION

Assortiment de crochets et poinçons pour le traçage



**2633/**

mm	Icon	QTY	Part No.
17 x 80 x 150		12	2633/S4
12 x 12 x 275		12	2633L/S4

Levier de dessoudage

ergo®



**BE-3529**

mm	Icon	QTY	Part No.
197		5	BE-3529

Jeu d'outils de syntonisation et d'équilibrage



**5600/4**

g	Icon	QTY	Part No.
75		1	5600/4

5551, 5552, 5553, 5554

Tire-ressorts



**5418**

mm	Icon	QTY	Part No.
145		1	5418

Tournevis d'ajustage, avec manchon guide



**5550**

mm	Icon	QTY	Part No.
140		10	5550-3.2
140		5	5550-4.5

Pincettes gratte-verniss



**2530-32/2530-40**

mm	Icon	QTY	Part No.
130		5	2530-40



Grattoir en carbone



**2487**



210



12 2487

Grattoir triangulaire pour mécanicien de précision



**3525HB**



168



5 3525HB

Grattoir triangulaire, 3524-k lame seule



**3524**



24  
5



1 3524  
1 3524L-K

Loupe électronique



**3046-OP**



105



12 3046-OP





## Outils de mesure



## MÈTRES RUBAN

Mètre ruban magnétique inoxydable



### MTS

↔ L	▬	📦	🐟
5	25	6	MTS-5-25
5	25	6	MTS-5-25-E
8	25	6	MTS-8-25
8	25	6	MTS-8-25-E

Mètre ruban



### MTB

↔ L	▬	📦	🐟
3	16	6	MTB-3-16
3	16	6	MTB-3-16-M
3	16	6	MTB-3-16-M-E
5	25	6	MTB-5-25
5	25	6	MTB-5-25-M
5	25	6	MTB-5-25-M-E
8	25	6	MTB-8-25
8	25	6	MTB-8-25-M
8	25	6	MTB-8-25-M-E

Mètre ruban Classe I



### MTB

↔ L	▬	📦	🐟
5	25	6	MTB-5-25-C1

Mètre ruban



### MTG

↔ L	▬	📦	🐟
3	16	12	MTG-3-16
3	16	12	MTG-3-16-E
5	19	12	MTG-5-19
5	19	12	MTG-5-19-E
8	25	4	MTG-8-25
8	25	4	MTG-8-25-E

Mètre ruban compact Classe I



### MTC

↔ L	▬	📦	🐟
3	13	6	MTC-3-13-C1
5	16	6	MTC-5-16-C1

Ruban de mesure Compact Classe II



### MTC

↔ L	▬	📦	🐟
3	13	6	MTC-3-13
5	16	6	MTC-5-16

Mètre ruban métrique compact 3M



### MT-TS-3

↔ L	▬	📦	🐟
3	13	12	MT-TS-3

Mètre ruban



### 1162N

↔ L	▬	📦	🐟
3	13	1	1162N-1/2

Mètre ruban avec adhésif  
Lecture : L pour gauche, R pour droite



### BT

↔ L	▬	📦	🐟
3	13	12	BTR-3-13
6	13	12	BTR-6-13
3	13	12	BTL-3-13
6	13	12	BTL-6-13

Mètre ruban



**LTG**

L	mm	Icon	Icon	QTY	Model
10	10	[Icon]	[Icon]	6	LTG-10
20	13	[Icon]	[Icon]	6	LTG-20
30	13	[Icon]	[Icon]	6	LTG-30

Mètre ruban



**LTB**

L	mm	Icon	Icon	QTY	Model
10	13	[Icon]	[Icon]	6	LTB-10
20	13	[Icon]	[Icon]	6	LTB-20
30	13	[Icon]	[Icon]	6	LTB-30

Ruban mesure longue



**LT-STEEL**

L	mm	Icon	Icon	QTY	Model
30	13	[Icon]	[Icon]	5	LT-STEEL-30
50	13	[Icon]	[Icon]	5	LT-STEEL-50

Mètre ruban



**LTS**

L	mm	Icon	Icon	QTY	Model
30	13	[Icon]	[Icon]	5	LTS-30
30	13	[Icon]	[Icon]	5	LTS-30-E
50	13	[Icon]	[Icon]	5	LTS-50
50	13	[Icon]	[Icon]	5	LTS-50-E
100	13	[Icon]	[Icon]	5	LTS-100
100	13	[Icon]	[Icon]	5	LTS-100-E

**ODOMÈTRES**

Odomètre, Ø 150 mm



**MW-150**

L	mm	Icon	Icon	QTY	Model
150		[Icon]	[Icon]	2	MW-150

Odomètre, Ø 250 mm



**MW-250**

L	mm	Icon	Icon	QTY	Model
940		[Icon]	[Icon]	2	MW-250

**NIVEAUX À BULLE**

Niveau à bulle



**466**

L	mm	Icon	Icon	QTY	Model
400		[Icon]	[Icon]	4	466-400
400		[Icon]	[Icon]	4	466-400-M
600		[Icon]	[Icon]	4	466-600
600		[Icon]	[Icon]	4	466-600-M
800		[Icon]	[Icon]	4	466-800
800		[Icon]	[Icon]	4	466-800-M
1000		[Icon]	[Icon]	4	466-1000
1000		[Icon]	[Icon]	4	466-1000-M
1200		[Icon]	[Icon]	4	466-1200
1200		[Icon]	[Icon]	4	466-1200-M
1800		[Icon]	[Icon]	4	466-1800
2000		[Icon]	[Icon]	4	466-2000

Niveau à bulle précision 0.5 mm / m



**426**

L	mm	Icon	Icon	QTY	Model
400	49x22 mm	[Icon]	[Icon]	1	426-400
600	49x22 mm	[Icon]	[Icon]	1	426-600
800	49x22 mm	[Icon]	[Icon]	1	426-800
1000	49x22 mm	[Icon]	[Icon]	1	426-1000
1200	49x22 mm	[Icon]	[Icon]	1	426-1200

400 mm et 600 mm avec 2 fioles. 600 mm jusqu'à 1200 mm avec 3 fioles

Niveau à bulle Précision ± 0,5 mm par mètre



**416**

L	mm	Icon	Icon	QTY	Model
400		[Icon]	[Icon]	10	416-400
600		[Icon]	[Icon]	10	416-600
800		[Icon]	[Icon]	10	416-800
1000		[Icon]	[Icon]	10	416-1000
1200		[Icon]	[Icon]	10	416-1200
1500		[Icon]	[Icon]	10	416-1500
1800		[Icon]	[Icon]	10	416-1800
2000		[Icon]	[Icon]	10	416-2000



Niveau trapèze en aluminium



**405**

400	5	405-400
600	5	405-600
800	10	405-800
1000	5	405-1000

Niveau trapèze en aluminium



**405 M**

400	5	405-400-M
600	5	405-600-M
800	5	405-800-M
1000	5	405-1000-M

Niveau trapèze en aluminium léger



**405L**

400	10	405L-400
600	10	405L-600

Niveau trapèze en aluminium léger



**405L M**

400	5	405L-400-M
600	5	405L-600-M

Niveau à bulle robuste en aluminium injecté  
Les modèles en -M possèdent une base magnétique



**406**

300	1	406-300
400	5	406-400
500	5	406-500
600	5	406-600
800	5	406-800

Niveaux en aluminium injecté robustes, magnétiques



**406**

300	1	5	406-300-M
400	1	5	406-400-M
500	1	5	406-500-M
600	1	5	406-600-M

Niveau en plastique  
Précision 1,0 mm/m



**406P**

400	10	406P-400
600	10	406P-600

Kit de 3 niveaux à bulles 600, 1200, 1800 avec un sac de transport en tissu  
Référence du sac : 4750-LV-1



**416-SET+BAG**

3	1	416-SET+BAG

416-SET-1

4750-LV-1

Jeu de 3 niveaux  
600 mm, 1200 mm, 1800 mm



**416-SET-1**

3	5	416-SET-1

416-600, 416-1200, 416-1800

Jeu de 3 niveaux  
600 mm, 1200 mm, 2000 mm



**416-SET-2**

3	5	416-SET-2

416-600, 416-1200, 416-2000

Niveau à bulle Torpedo magnétique plastique  
Tolérance ± 1,0 mm/m



**406T-225**

228	10	406T-225

DISP est un présentoir de comptoir de 12 pièces

Niveau torpille  
Précision 0,5 mm/m



**426TOR9**



230



10 426TOR9

Niveau Torpedo  
Précision 0,5 mm / m



**466-250**



250



10 466-250

Niveau



**466-LINE**



75



12 466-LINE

Niveau double lecture



**466-BE1**



20



12 466-BE1

Niveau à 3 bulles



**466-POST**



120 x 75 x 80 mm



6 466-POST

Niveau à bulle à bords droits avec poignées  
Précision ± 1 mm/m



**486**



1800

2000

2400



5 486-1800

5 486-2000

5 486-2400

Niveau à bulle à bords droits sans poignées  
Précision ± 1 mm/m



**486-xxxWH**



1800

2000

2400



5 486-1800WH

5 486-2000WH

5 486-2400WH

Niveau à bulle double profile en T  
Précision ± 0,5 mm/m



**496**



1500

1800



5 496-1500

5 496-1800

Fiole de recharge



**496-SPARE**



496-1500, 496-1800



1 496-SPARE

## MARQUAGE

Cordeau traceur 30 m vitesse de rembobinage x 5



**CL-1441**



185



36 CL-1441

Cordeau traceur 30 m vitesse de rembobinage x1



**CL-1331**



185



48 CL-1331



Cordeau traceur enroulement 3 vitesses  
CL-1221-SET = CL-1221 + bouteille craie bleue 227 g,  
niveau 75 mm



### CL-1221

130	6	CL-1221

Poudre à tracer, 227 g



### CHALK

227	6	CHALK-BLUE
227	6	CHALK-WHITE
227	6	CHALK-RED
227	6	CHALK-YELLOW

Cordeau traceur CL-1441 + craie bleue



### CL-1441-SET

610	16	CL-1441-SET

CL-1441	
CHALK-BLUE	

Cordeau traceur CL-1331 + craie bleue



### CL-1331-SET

550	16	CL-1331-SET

CL-1331	
CHALK-BLUE	

Jeu : cordeau traceur + craie bleue + niveau



### CL-1221-SET

180	4	CL-1221-SET

CHALK-BLUE	
466-LINE	
CL-1221	

Fil à plomb 5 m



### PBS

5	6	PBS-700

Fil à plomb en cuivre  
Poids 227 g



### PBB

185 mm	227	8	PBB-8

Crayon HB  
FSC Certificat No. : CERT-0060481



### P-HB

175	25	25 P-HB

FSC Certificat Code : QMI-COC-001417  
Dossier No. : 1627439

Présentoir de 200 crayons P-HB  
Présentoir cage



### PENCIL-200

180	200	1 PENCIL-200-DISP

Crayon porte-mines de charpentier HB



**P-MEC**

Length (mm)	Quantity	Code
150 mm	1	24 P-MEC
100 mm	5	12 P-MEC-LEAD

Pointe à tracer en carbure de tungstène avec pointe interchangeable 160mm  
Diamètre pointe 3mm



**1179-SCRIBE**

Length (mm)	Quantity	Code
150	5	1179-SCRIBE
	1	1179-TIPS

Pointe à tracer en carbure de tungstène 150mm  
Pointe 2.5mm



**1178-SCRIBE**

Length (mm)	Quantity	Code
150	5	1178-SCRIBE

Pointe à tracer coudée 230mm  
Diamètre 4mm et angle 70°



**1177-SCRIBE**

Length (mm)	Quantity	Code
230	5	1177-SCRIBE

**RÈGLES**

Mètre bois 1 m  
MM : métrique uniquement



**WR1**

Length (mm)	Quantity	Code
1	17	50 WR1
1	17	50 WR1-MM

Mètre bois 2m  
MM: métrique uniquement



**WR2**

Length (mm)	Quantity	Code
2	17	25 WR2
2	17	25 WR2-MM

Mètre bois 2m 12 sections



**WR2-12**

Length (mm)	Quantity	Code
2	17	25 WR2-12

Râpe de carrossier



**1179-FLX**

Length (mm)	Quantity	Code
160	12	100 1179-FLX

Règle acier  
-E = métrique/impérial



**SR**

Length (mm)	Quantity	Code
150	19	12 SR150-MM
200	19	12 SR200-MM
300	25	12 SR300-MM
600	30	20 SR600-MM
1000	35	20 SR1000-MM

Règle en acier  
Double marquage en mm et pouces



**SR**

Length (mm)	Quantity	Code
6	6	12 SR150-E
8	8	12 SR200-E
12	12	12 SR300-E
24	24	20 SR600-E
39	40	20 SR1000-E

**ÉQUERRES**

Équerre



**9045-B**

Length (mm)	Quantity	Code
220	170 mm	6 9045-B-200
250	170 mm	6 9045-B-250
300	170 mm	6 9045-B-300
400	170 mm	1 9045-B-400



## Équerre



### 9048

↔ L	↙	📦	🐟
200	165 mm	10	9048-200
250	165 mm	10	9048-250
300	180 mm	10	9048-300
350	180 mm	10	9048-350
400	180 mm	10	9048-400

## Équerre pour plan



### 3085

↔ L	↙	📦	🐟
400	200 mm	1	308504000
500	250 mm	1	308505000
600	300 mm	1	308506000
800	400 mm	1	308508000
1000	500 mm	1	308510000

## Équerre à coulisse



### CS

↔ L	↙	📦	🐟
152	90 mm	12	CS150
305	125 mm	12	CS300
407	125 mm	12	CS400

## Fausse équerre



### 9572

↔ L	↙	📦	🐟
235	115 mm	6	9572-200
250	150 mm	6	9572-250

## Fausse équerre



### 9574

↔ L	↙	📦	🐟
215	165 mm	10	9574-200
285	170 mm	10	9574-250
300	170 mm	10	9574-300

## Fausse équerre



### 9575

↔ L	↙	📦	🐟
250	110 mm	6	9575-250

## Équerre de charpentier plate



### FCS-600/FCS-1000

↔ L	↙	📦	🐟
600	300 mm	6	FCS-600
800	300 mm	6	FCS-800
1000	360 mm	6	FCS-1000

## Fausse équerre pour plaque de plâtre



### AS-1200

↔ L	↙	📦	🐟
1265	560 mm	3	AS-1200

## MESURE DE PRÉCISION

### Pied à coulisse digital



### 1150D

↔ L	📦 mm	📦	🐟
150	25 x 90 x 245 mm	1	1150D



Pied à coulisse



**1150**

150	9 x 75 x 235 mm	1	1150-1/2H/P

Jauge d'épaisseur métrique, 13 lames  
0,05-1,00 mm



**1546**

13	100	1 1546

(0,05-0,30) x 0,05mm (0,30-1,00) x 0,10 mm

Jauge de filetage métrique 60°



**1535**

24	67	1 1535

Jauge d'épaisseur métrique, 26 lames  
0,03 - 1,00 mm

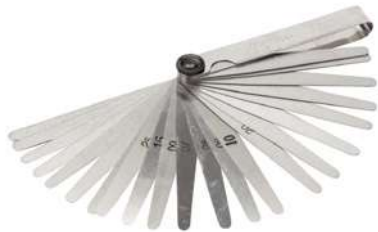

**1544**

26	100	1 1544

(0,03-0,10) x 0,01mm (0,10-1,00) x 0,05 mm

Jauge d'épaisseur métrique, 20 lames  
0,05 - 1,00 mm



**1547**

20	100	20 1547

incréments de 0,05 mm

Jauge de filetage métrique 60° & Whitworth 55



**1537**

0.25-6.0 / 4-62	70	1 1537





**BAHCO**



## Outils pour cloisons



## GRATTOIRS

Grattoir ergonomique avec étui

ergo®



625

ergo



25

5 625

Grattoir ergonomique

ergo®



650

ergo



50

5 650

Grattoir ergonomique

ergo®



665

ergo



60

5 665

Lame pour grattoir à peinture



850 / 865



50

10 850-1

65

10 865-1

Lame grattoir

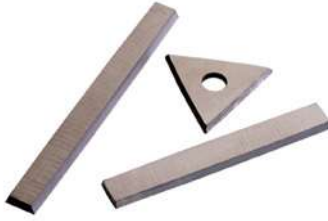

449/442/451



50

10 442-3P

25

10 449

50

10 442

65

10 451

Lames grattoir pour grattoir 625



-625



3

10 625-DROP

3

10 625-PEAR

3

10 625-ROUND

Coffret de grattoirs

ergo®



SCRAPER-SET2



50 x 145 x 265 mm

1 SCRAPER-SET2

625



625-DROP, 625-PEAR, 625-ROUND

650



Racloir d'ébéniste



474



130

10 474-125-0.60

130

10 474-125-0.80

150

10 474-150-0.60

150

10 474-150-0.80

Couteau de peintre



2155



30

195

12 215500300

40

195

12 215500400

50

195

12 215500500

60

215

12 215500600

70

220

12 215500700

80

225

12 215500800

90

230

12 215500900

100

234

12 215501000

Racloir manche plastique  
Lame en acier carbone



216



30

215

12 216000300

40

215

12 216000400

50

215

12 216000500

60

215

12 216000600

70

215

12 216000700

80

215

12 216000800

90

215

12 216000900

100

215

12 216001000

120

215

12 216001200

Couteau de peintre  
Poignée bi-matière, lame en acier carbone



**2150**

Blade width (mm)	Blade length (mm)	Quantity	Product code
30	225	12	215000030
40	225	12	215000040
50	225	12	215000050
60	225	12	215000060
70	225	12	215000070
80	225	12	215000080
90	220	12	215000090
100	220	12	215000100
120	220	12	215000120

Couteau de peintre poignée bi-matière



**2161**

Blade width (mm)	Blade length (mm)	Quantity	Product code
40	215	12	216100040
60	215	12	216100060
80	215	12	216100080
100	215	12	216100100
120	215	12	216100120

Couteau de peintre rigide



**2165**

Blade width (mm)	Blade length (mm)	Quantity	Product code
30	180	12	216500300
50	180	12	216500500
75	200	12	216500750
100	200	12	216501000

Couteau à enduire



**2190**

Blade width (mm)	Blade length (mm)	Quantity	Product code
100 mm	235	5	219001000
120 mm	230	5	219001200
140 mm	245	5	219001400
160 mm	235	5	219001600
200 mm	245	5	219002000

Couteau à enduire



**2192**

Blade width (mm)	Blade length (mm)	Quantity	Product code
100 mm	235	5	219201000
120 mm	230	5	219201200
140 mm	235	5	219201400
160 mm	245	5	219201600
200 mm	235	5	219202000

Couteau à enduire



**2193**

Blade width (mm)	Quantity	Product code
250	10	219302500
300	10	219303000
350	10	219303500

Spatule à encoller



**2212**

Blade width (mm)	Blade length (mm)	Quantity	Product code
130 mm	120	5	221201200
130 mm	200	5	221202000
130 mm	300	5	221203000

Spatule à encoller



**2213**

Blade width (mm)	Blade length (mm)	Quantity	Product code
130 mm	120	5	221301200
130 mm	200	5	221302000
130 mm	300	5	221303000

Couteau à lame crochetée



**2488**

Blade length (mm)	Quantity	Product code
210	12	2488

Spatule à mastiquer



**2489**

Blade length (mm)	Quantity	Product code
235	12	2489



## OUTILS DE MAÇON

Truelle



**2301**

Blade Length (mm)	Blade Width (mm)	Blade Thickness (mm)	Blade Shape	Quantity	Product Code
145	110		Square	6	2301A0000
160	115		Square	6	2301B0000
175	125		Square	6	2301C0000

Truelle



**2304**

Blade Length (mm)	Blade Width (mm)	Blade Thickness (mm)	Blade Shape	Quantity	Product Code
110	180		Rectangular	6	2304A0000
115	200		Rectangular	6	2304C0000

Truelle arrondie



**2309**

Blade Length (mm)	Blade Width (mm)	Blade Thickness (mm)	Blade Shape	Quantity	Product Code
125	75		Rounded Triangle	6	230912500

Truelle



**2302**

Blade Length (mm)	Blade Width (mm)	Blade Thickness (mm)	Blade Shape	Quantity	Product Code
180	110		Rectangular	6	2302A0000
180	100		Rectangular	6	2302B0000
190	125		Rectangular	6	2302C0000

Truelle triangulaire



**2307**

Blade Length (mm)	Blade Width (mm)	Blade Thickness (mm)	Blade Shape	Quantity	Product Code
135	60		Triangle	6	230713500

Truelle en coins



**2360**

Blade Length (mm)	Blade Width (mm)	Blade Thickness (mm)	Blade Shape	Quantity	Product Code
120	97		Square	6	236001200

Truelle



**2303**

Blade Length (mm)	Blade Width (mm)	Blade Thickness (mm)	Blade Shape	Quantity	Product Code
70	110		Rectangular	6	2303B0000
80	135		Rectangular	6	2303D0000
95	165		Rectangular	6	2303F0000
105	190		Rectangular	6	2303H0000
110	215		Rectangular	6	2303J0000
115	225		Rectangular	6	2303K0000
120	240		Rectangular	6	2303L0000

Truelle pointue



**2308**

Blade Length (mm)	Blade Width (mm)	Blade Thickness (mm)	Blade Shape	Quantity	Product Code
120	70		Pointed Triangle	6	2308A0000
150	100		Pointed Triangle	6	2308B0000

Truelle pour coins intérieurs



**2361**

Blade Length (mm)	Blade Width (mm)	Blade Thickness (mm)	Blade Shape	Quantity	Product Code
145	165		Square	6	236101200

## OUTILS DE PLÂTRIER

Truelle forme rectangulaire



**204**

Blade Length	Blade Width	Quantity	Product Code
300	150	12	204030150
300	160	12	204030160
300	180	12	204030180
500	130	6	204050130

Platoir cranté



**209**

Blade Length	Blade Width	Quantity	Product Code
270	115	12	209027040

Platoir cranté



**2092**

Blade Length	Blade Width	Quantity	Product Code
275	115	12	209227060
280	130	12	209228100
500	130	6	209250100

Platoir en acier inoxydable



**2045**

Blade Length	Blade Width	Quantity	Product Code
300	140	12	204530140
500	130	6	204550130

Platoir en acier inoxydable



**2045A**

Blade Length	Blade Width	Quantity	Product Code
140	300	12	2045A3000

Taloche en plastique



**211**

Blade Length	Blade Width	Quantity	Product Code
350	180	5	211035180
420	210	5	211042210

Taloche plastique



**2120**

Blade Length	Blade Width	Quantity	Product Code
270	180	5	212027180
330	220	8	212033220

Taloche plastique avec extrémité pointue



**213**

Blade Length	Blade Width	Quantity	Product Code
265	140	5	213026140

Taloche pour carreleur



**2122**

Blade Length	Blade Width	Quantity	Product Code
250	100	10	212202500

Taloche avec base en mousse



**2123**

Blade Length	Blade Width	Quantity	Product Code
140	280	10	212302900



Taloche en caoutchouc dur



**2125**

220	135	10	212502150

Chemin de fer pour plâtrier



**2145xxxD**

20 x 45 x 275 mm	1	2145020D0	
25 x 45 x 275 mm	1	2145025D0	
30 x 45 x 275 mm	1	2145030D0	
35 x 45 x 275 mm	1	2145035D0	

Elévateur de plaques



**2504**

300 x 750 x 1400 mm	1	250400000	

Taloche en caoutchouc souple



**2126**

140	220	10	212602150
140	280	10	212602800

Chemin de fer : lames droites



**2145xxxL**

20 x 45 x 275 mm	1	2145020L0	
25 x 45 x 275 mm	1	2145025L0	
30 x 45 x 275 mm	1	2145030L0	
35 x 45 x 275 mm	1	2145035L0	

Jeu de pièces pour élévateur (2 ressorts + frein)



**250400010**

80	1	250400010	

Rabot à plâtre aluminium



**2127**

90	435	6	212704350

Chemin de fer : lames courbes



**2145xxxC**

25 x 45 x 225 mm	1	2145025C0	
35 x 45 x 210 mm	1	2145039C0	

Kit de rechange pour lève-plaque (câble)



**250400020**

180	1	250400020	



Kit de rechange pour lève-plaque (poignée)



**250400030**

80	1 250400030

Pince à onglets à angle variable



**8640**

230	50 864002450

Lame de rechange pour 8641



**864100010**

5	1 864100010

Pince de fixation



**250501800**

185	50 250501800

Lame de rechange pour 8640



**864000010**

20	1 864000010

Pince à sertir les profilés sans rivet



**671002600**

260	50 671002600

Pince de fixation



**250502450**

245	50 250502450

Pièce détachée pour onglet 864



**864000020**

20	1 864000020

Pince à sertir les profilés sans rivet



**671002850**

295	50 671002850

Pince à onglet



**8641**

245	50 864102400





**BAHCO**



## Scies à métaux mains



## MONTURES DE SCIES À MÉTAUX MAINS

Monture de scie à métaux ERGO™ 300 mm

ergo®



**325**



300



5 325

Monture de scie à métaux professionnelle



**225-PLUS**



300



5 225-PLUS

Monture de scie à métaux bi-matière 300 mm



**319**



300



5 319

Monture de scie à métaux



**317**



432



10 317

Monture de scie à métaux



**306**



440



10 306

Monture de scie à métaux



**320**



504



10 320

Monture de scie à métaux



**304**



517



10 304

Mini monture de scie à métaux



**208**



330



5 208

Scie à guichet



**321**



330



5 321

Scie à guichet Stiletto/210

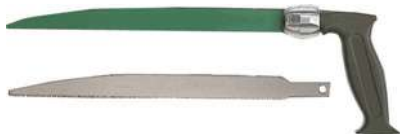

**210**



360



10 210

Mini scie pour le métal



**268**



150



5 268

Mini scie pour le métal



**239**

L	Icones	Quantité	Code
260		5	239

Mini scie pour le métal



**238**

L	Icones	Quantité	Code
150		5	238

Mini scie



**228**

L	Icones	Quantité	Code
150		5	228
150		5	228-BULK

Mini scie pour le métal



**219**

L	Icones	Quantité	Code
291		5	219

Mini scie pour le métal



**218**

L	Icones	Quantité	Code
235		10	218
235		1	218-BULK

**LAMES DE SCIES MÉTAUX MAIN**

Lame Spiro Bimétal SANDFLEX®



**3806-SPIRO**

L	Icones	Quantité	Code
600		10	3806-600-32

Lame de scie métaux main  
Nouvelle SANDFLEX bi-métallique + Cobalt



**3906**

L	Icones	Quantité	Code
250		100	3906-250-18-100
250		100	3906-250-24-100
250		100	3906-250-32-100
300		100	3906-300-14-100
300		100	3906-300-18-100
300		100	3906-300-24-100
300		100	3906-300-32-100
300		100	3818-300-PROG-100
300		10	3906-300-18-2P
300		10	3906-300-24-2P
300		10	3906-300-32-2P
300		10	3906-300-3P
250		10	3906-250-18-5P
250		10	3906-250-24-5P
250		10	3906-250-32-5P
300		10	3906-300-14-5P
300		10	3906-300-18-5P

L	Icones	Quantité	Code
300		10	3906-300-24-5P
300		10	3906-300-32-5P
300		10	3818-300-PROG-5P
300		10	3906-300-14-10P
300		10	3906-300-18-10P
300		10	3906-300-24-10P
300		10	3906-300-32-10P

Lames de scies métaux main, HSS



**3905**

L	Icones	Quantité	Code
250		100	3905-250-24-100
300		100	3905-300-14-100
300		100	3905-300-18-100
300		10	3905-300-24-2P
300		100	3905-300-24-100
300		100	3905-300-32-100

Lame au carbure de tungstène



**3816**

L	Icones	Quantité	Code
300		5	3816-300

Lame pour mini scie au carbure de tungstène



**215**

L	Icones	Quantité	Code
150		1	215-150



Lames pour scies à chantourner

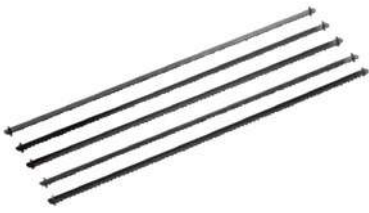

**228-P**

L	mm	mm	Q	Ref.
150	15	10	228-15-5P	
150	32	10	228-32-5P	
150	32	10	228-32-10P	
150	32	1	228-32-100P	

Lame au carbure de tungstène



**216-R**

L	mm	mm	Q	Ref.
150	20	1	216-150-R	
300	20	1	216-300-R	

Scie à guichet/321-SB



**321-SB**

L	mm	mm	Q	Ref.
310	7	10	321-7-SB	
310	18	10	321-18-SB	
310	24	10	321-24-SB	



## Scies à main



## SCIES À MAIN POUR MATÉRIAUX DE CONSTRUCTION

Scie multi-usage



**PC-GNP**

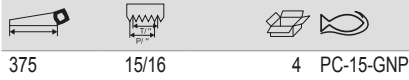

375 15/16 4 PC-15-GNP

Lame de scie Superior multi-usages



**EX-16-GNP-C**



400 15/16 10 EX-16-GNP-C

Scie à guichet - dents trempées



**3150**



300 9/10 4 3150-12-XT9-HP

Scie à dos



**NP-COM**



300 7/8 4 NP-12-COM

Scie à guichet - dents trempées



**PC-COM**



300 9/10 4 PC-12-COM

Scie placo



**PC-6-DRY**



160 8 6 PC-6-DRY

Scie spéciale plaques de plâtre



**PC-PLS**



600 7/8 4 PC-24-PLS

Lame de scie Superior, spéciale plâtre



**EX-22-PLS-C**



550 7/8 10 EX-22-PLS-C

Scie à main pour couper tous types de plastiques



**PC-22-PLC**

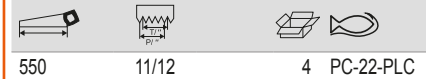

550 11/12 4 PC-22-PLC

Scie spéciale mousse polystyrène



**PC-DECO**



400 18/19 4 PC-16-DECO

Scie pour couper du béton poreux ou des blocs Leca®  
Denture carbure



**255-34**



620 1,3 2 255-34

Scie pour couper du béton poreux ou des blocs Leca®  
Denture carbure



**255-17/34**



620 0,6 2 255-17/34



### Scie pour béton cellulaire



**256**

650	2	4	256-26

### Scie pour matériaux isolants PC-22-INS-10P/24P : display de 10/24pcs



**PC-22-INS**

550	WT	4	PC-22-INS

### Scie multi-usage



**369**

360	13/14	20	369-BLADE

### Scie multi-usage



**300**

350	15/16	4	300-14-F15/16-HP

## SCIES À MAIN POUR BOIS

### Scie égoïne - dents trempées



**NP**

400	7/8	4	NP-16-U7/8-HP
475	7/8	10	NP-19-U7/8-HP
550	7/8	10	NP-22-U7/8-HP

### Lame BHS Prizecut +



**EX-NPP-22**

550	7/8	10	EX-NPP-22

### Lame de scie Medium



**EX-XT9**

475	9/10	10	EX-19-XT9-C
550	9/10	10	EX-22-XT9-C

### Scie à tronçonner



**NP-FLEEM**

550	7	10	NP-22-F7/8-HP

### Scie égoïne - dents trempées



**PC-GT7**

475	7/8	4	PC-19-GT7
550	7/8	4	PC-22-GT7

### Lame BHS Prizecut



**EX-22-U7**

550	7/8	10	EX-22-U7

### Scie égoïne réaffûttable



**PC-FILE**

400	7/8	4	PC-16-FILE-U7
475	7/8	4	PC-19-FILE-U7
550	7/8	4	PC-22-FILE-U7
600	7/8	4	PC-24-FILE-U7

### Scie pour boîte à outil supérieure Pour matériaux d'épaisseur fine à moyenne

ergo



**2600-16**

400	11/12	4	2600-16-XT11-HP



Scie à dos - dents trempées



**3180**

350	11/12	4	3180-14-XT11-HP

Scie égoïne supérieure  
Pour matériaux d'épaisseur fine à moyenne



**3090**

500	11/12	4	3090-20-XT11-HP

Scie spéciale stratifiés et parquets



**SUP-LAM**

500	11/12	4	SUP-20-LAM

Scie à panneau - dents trempées



**3240**

350	11/12	4	3240-14-XT11-HP

Scie égoïne pour matériaux en bois épaisseur moyen à épais



**244**

500	7/8	10	244-20-U7/8-HP
550	7/8	10	244-22-U7/8-HP

Lame Superior coupe fine



**EX-20-XT11-C**

500	11/12	10	EX-20-XT11-C

Scie égoïne - dents trempées



**2500 XT**

400	11/12	4	2500-16-XT-HP
475	9/10	4	2500-19-XT-HP
550	9/10	4	2500-22-XT-HP
600	7/8	4	2500-24-XT7-HP

Lame de scie Superior Laminator



**EX-20-LAM-C**

500	11/12	10	EX-20-LAM-C

Lame de scie à dos Superior



**EX-14-TEN-C**

350	11/12	10	EX-14-TEN-C

Scie égoïne - dents trempées  
Superior



**2600**

475	9/10	4	2600-19-XT-HP
550	9/10	4	2600-22-XT-HP

Scie Laminator



**PC-LAM**

500	11/12	4	PC-20-LAM

Lame de scie à panneaux Superior



**EX-14-VEN-C**

350	11/12	10	EX-14-VEN-C

Scie égoïne - dents trempées



**PC-GT9**

475	9/10	4	PC-19-GT9
550	9/10	4	PC-22-GT9

Scie de précision - boîte à ongles



**PC-PRC**

500	9/10	4	PC-20-PRC

Lame de scie Barracuda



**EX-244P-22**

550	7/8	10	EX-244P-22

Scie pour boîte à outils - dents trempées



**PC-TBX**

375	11/12	4	PC-15-TBX

Scie à dos



**NP-TEN**

300	15/16	10	NP-12-TEN

Scie égoïne pour matériaux en bois d'épaisseur moyenne



**244P**

500	7/8	4	244P-20-U7-HP
550	7/8	10	244P-22-U7-HP

Scie à dos - dents trempées



**PC-TEN**

300	11/12	4	PC-12-TEN

Scie à dos



**NP-VEN**

300	15/16	10	NP-12-VEN

Scie égoïne - dents trempées Superior

ergo®



**2700**

550	7/8	4	2700-22-XT7-HP
600	7/8	4	2700-24-XT7-HP

Scie à panneaux - dents trempées



**PC-VEN**

300	11/12	4	PC-12-VEN

Lame de scie pour matériaux brut ou épais



**EX-XT7**

550	7/8	10	EX-22-XT7-C
600	7/8	10	EX-24-XT7-C

Scie gros débits



**PC-TIM**

600	3.5/4.5	4	PC-24-TIM



## Boîtes à onglets



### 233



65 x 135 x 300 mm	5	233-300
75 x 135 x 300 mm	5	233-300-A
65 x 135 x 400 mm	5	233-400

## Boîtes à onglets



### 234-W

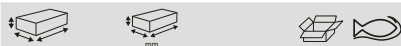

245	53 x 77 x 245 mm	10	234-W1
300	63 x 95 x 300 mm	10	234-W2
300	80 x 100 x 300 mm	10	234-W3

## Boîtes à onglets en aluminium



### 234-A

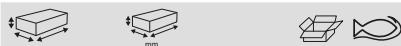

245	55 x 65 x 245 mm	1	234-A1
245	40 x 106 x 245 mm	1	234-A2

## SCIES À MAIN DE PRÉCISION

### Scie japonaise de menuiserie



#### PC-12-PS

305	13.5	4	PC-12-14-PS
305	13.5	10	PC-12-14-PS-B

### Scie japonaise



#### PC-11-PS

270	18.5	4	PC-11-19-PS
270	18.5	10	PC-11-19-PS-B

### Scie coupe tirante double tranchant



#### PC-9-PS

240	6-8.5 / 17	4	PC-9-9/17-PS
240	6-8.5 / 17	10	PC-9-9/17-PS-B

### Scie à dos - poignée droite



#### PC-DTF

250	15/16	10	PC-10-DTF

## Scie à dos - poignée droite



#### PC-DTR

250	13/14	10	PC-10-DTR

## Scie à dos - poignée droite



#### PC-DTL

250	13/14	10	PC-10-DTL

## MANCHES ET AFFÛTEURS

Poignée BHS  
M = Medium

ergo®



#### EX-

120 x 330 x 60 mm	4 EX-LL
120 x 330 x 60 mm	4 EX-RM
120 x 330 x 60 mm	4 EX-RL

## Affûteur HSS



### SHARP-INS



206



100 SHARP-INS

## SCIES À CHANTOURNER ET LAMES DE SCIE

### Scie à chantourner



### 302



130



5 302

### Scie à chantourner



### 502



130



5 502

### Scie à chantourner



### 502/



130

500



5 502-SET2

5 502-SET6

## Assortiment de lames pour mini scies



### 302-6X4P



130



1 302-6X4P

### Lames

Types de denture : 1 : Fine, 3 et 5 : Moyenne, 7 : Grosse



### 302M



1

130



1 302-71M-12P

3

130

1 302-73M-12P

5

130

1 302-75M-12P

7

130

1 302-77M-12P

### Lames de rechange - bois/plastique 1: fine



### 302S



1

130



1 302-81S-12P

3

130

1 302-83S-12P

5

130

1 302-85S-12P

Lames pour scie à chantourner, pour le bois et le plastique 1-3= fine, 5-7= moyenne, 9-11=épais



### 302W



1

130



1 302-51W-12P

3

130

1 302-53W-12P

5

130

1 302-55W-12P



7

130

1 302-57W-12P

9

130

1 302-59W-12P

11

130

1 302-511W-12P

## SCIES À CHANTOURNER ET LAMES DE SCIE

### Scie à chantourner



### 301



165



5 301

### Lame de scie à chantourner

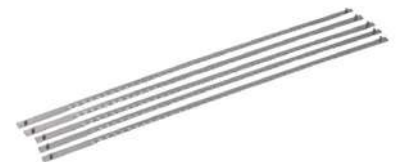

### 303



165



10 303-5P

## SCIES MUSICALES

### Scie égoïne musicale



### 296



750



1 296





**BAHCO**



## Ciseaux à bois



## BURINS POUR LE TRAVAIL DU BOIS

Ciseau à bois Ergo™ anti-fissures  
Compatible usage intensif avec un marteau métallique



434	
Longueur (mm)	Quantité
6	4
8	4
10	4
12	4
14	4
15	4
16	4
18	4
20	4
22	4
25	4
28	4
30	4
32	4
35	4
38	4
50	4

Compatible usage intensif avec un marteau métallique

Jeu de 3 ciseaux à bois Ergo™ anti-fissures dans  
boîte carton  
Compatible usage intensif avec un marteau métallique



434-S3-EUR	
Longueur (mm)	Quantité
3	1

Compatible usage intensif avec un marteau métallique

434-12, 434-18, 434-25

Jeu de 6 ciseaux à bois ERGO™ anti-fissures dans  
une pochette pliable en cuir  
0



434-S6-LR	
Longueur (mm)	Quantité
6	1

434-6, 434-10, 434-12, 434-18, 434-25, 434-32

Coffret de 6 ciseaux à bois Ergo™ anti-fissures  
Compatible usage intensif avec un marteau métallique



434-S6-EUR	
Longueur (mm)	Quantité
6	1

Compatible usage intensif avec un marteau métallique

434-6, 434-10, 434-12, 434-18, 434-25, 434-32

Jeu de 8 ciseaux à bois Ergo™ anti-fissures dans  
coffret en bois  
Compatible usage intensif avec un marteau métallique



434-S8-EUR	
Longueur (mm)	Quantité
8	1

Compatible usage intensif avec un marteau métallique

434-6, 434-10, 434-12, 434-16, 434-18, 434-25, 434-32, 434-38

Jeu de 6 ciseaux à bois Ergo™ anti-fissures dans  
pochette solide  
Pochette en polyester haute qualité



434-S6-PP	
Longueur (mm)	Quantité
6	1

Compatible usage intensif avec un marteau métallique

434-6, 434-10, 434-12, 434-18, 434-25, 434-32

Ciseau à bois professionnel poignée bi-matière



424P	
Longueur (mm)	Quantité
4	4
6	4
8	4
10	4
12	4
14	4
15	4
16	4
18	4
20	4
22	4
24	4
25	4
26	4
28	4
30	4
32	4
35	4
38	4
40	4

Jeu de 3 ciseaux à bois professionnel poignée bi-  
matière



424P-S3-EUR	
Longueur (mm)	Quantité
3	1

424P-25, 424P-12, 424P-18

Jeu de 6 ciseaux à bois professionnels poignée bi-  
matière dans une pochette pliable en cuir  
0



424P-S6-LR	
Longueur (mm)	Quantité
6	1

424P-6, 424P-10, 424P-12, 424P-18, 424P-25, 424P-32



Jeu de 6 ciseaux à bois professionnels poignée bi-matière dans coffret en bois



**424P-S6-EUR**

6	1 424P-S6-EUR

424P-12, 424P-10, 424P-6, 424P-18, 424P-25, 424P-32

Jeu de 6 ciseaux à bois professionnels poignée bi-matière dans coffret en bois



**424P-S6-GER**

6	1 424P-S6-GER

424P-10, 424P-12, 424P-16, 424P-20, 424P-26, 424P-6

Jeu de 8 ciseaux à bois professionnels poignée bi-matière dans coffret en bois



**424P-S8-EUR**

8	1 424P-S8-EUR

424P-12, 424P-38, 424P-32, 424P-25, 424P-18, 424P-16, 424P-6, 424P-10

Jeu de 6 ciseaux à bois professionnels poignée bi-matière dans pochette solide  
Rangés dans une pochette polyester haute qualité



**424P-S6-PP**

6	1 424P-S6-PP

424P-6, 424P-10, 424P-12, 424P-18, 424P-25, 424P-32

Ciseau à bois poignée mono matière en polypropylène



**414**

6	4 414-6
8	4 414-8
10	4 414-10
12	4 414-12
14	4 414-14
15	4 414-15
16	4 414-16
18	4 414-18
20	4 414-20
22	4 414-22
25	4 414-25
28	4 414-28
30	4 414-30
32	4 414-32
35	4 414-35
38	4 414-38

Ciseau à bois poignée rouge mono matière  
5 pcs



**1031**

4	5 1031-4
6	5 1031-6
8	5 1031-8

10	5 1031-10
12	5 1031-12
14	5 1031-14
16	5 1031-16
18	5 1031-18
20	5 1031-20
22	5 1031-22
25	5 1031-25
28	5 1031-28
30	5 1031-30
32	5 1031-32
40	5 1031-40

Jeu de 3 ciseaux à bois poignée mono matière en polypropylène  
Manche en polypropylène



**141-S3-EUR**

3	1 414-S3-EUR

414-18, 414-25, 414-12

Jeu de 5 ciseaux à bois poignée rouge mono matière sous blister  
5 pcs



**9883**

5	1 9883

1031-16, 1031-20, 1031-12, 1031-6, 1031-25



Ciseau à bois poignée bois



**425**

4		4	425-4
6		4	425-6
8		4	425-8
10		4	425-10
12		4	425-12
14		4	425-14
15		4	425-15
16		4	425-16
18		4	425-18
20		4	425-20
22		4	425-22
24		4	425-24
25		4	425-25
26		4	425-26
28		4	425-28
30		4	425-30
32		4	425-32
35		4	425-35
38		4	425-38
40		4	425-40

Jeu de 3 ciseaux à bois poignée bois dans boîte carton 3 pcs



**425-081**

3		1	425-081

425-12, 425-18, 425-25

Jeu de 5 ciseaux à bois poignée bois dans boîte carton 5 pcs



**425-082**

5		1	425-082

425-12, 425-10, 425-6, 425-25, 425-18

Jeu de 6 ciseaux à bois poignée bois dans coffret en bois 6 pcs



**425-083**

6		1	425-083

425-10, 425-12, 425-6, 425-25, 425-18, 425-32

Poignée de rechange pour ciseaux à bois 1031



**956**

108	50	1	956

**GOUGES**

Gouge professionnelle poignée bi-matière



**422P**

6		4	422P-6
10		4	422P-10
12		4	422P-12
16		4	422P-16
20		4	422P-20
25		4	422P-25

**CISEAUX À BOIS POUR DÉMOLITION**

Couteau ciseau à bois



**2448**

231	12	12	2448
240	12	12	SB-2448

Couteau multi-usages II  
SB : sur carte, 2449 display de 12 pièces



**2449**

240	12	12	2449
231	10	10	SB-2449

## ACCESSOIRES POUR CISEAUX À BOIS

Pierre d'affûtage naturelle



**528-700**



150



1 528-700

Kit d'affûtage pour burins



**529-SK**



220 x 10 x 170 mm



650



1 529-SK

Bloc d'affûtage



**SBC110**



30 x 65 x 110 mm



67



1 SBC110-65

Pierre d'affûtage - 2 grains



**528-COM**



150



1 528-COM

Bloc d'affûtage pour les outils coupant du bois



**BP-40**



160 mm



1 BP-40

Etui de protection plastique  
Avec clip pour porter à la ceinture



**WC-HOL**



292 mm



1 WC-HOL





**BAHCO**



## Ciseaux et couteaux



## CISAILLES À TÔLE

Cisaille à tôle articulée  
Coupe droite



**MA421**



250 10 MA421

8698M0250: pièces-détachées

Cisaille à tôle articulée  
Coupe droite, longue



**MA431**



290 1 MA431

8698M0250: pièces-détachées

Cisaille à tôle articulée  
Coupe à droite



**MA411**



250 10 MA411

8698M0250: pièces-détachées

Cisaille à tôle articulée renforcée  
Coupe à droite



**MA321**



260 10 MA321

8697M0260: pièces-détachées

Cisaille à tôle articulée  
Coupe à gauche



**MA401**



250 10 MA401

8698M0250: Jeu de pièces détachées

Cisaille à tôle articulée renforcée  
Coupe à gauche



**MA311**



260 10 MA311

8697M0260: pièces-détachées

Cisaille à tôle démultipliée, Type aviation  
Coupes rectilignes



**MA225**



250 4 MA225

Cisaille à tôle démultipliée, Type aviation  
Coupes rectilignes et courbes à droite



**MA225R**



250 4 MA225R

Cisaille à tôle démultipliée, Type aviation  
Coupes rectilignes et courbes à gauche



**MA225L**



250 4 MA225L

Cisaille à tôle articulée renforcée à chantourner  
Coupe à droite



**MA361**



260 10 MA361

8697M0260: pièces-détachées

Cisaille à tôle articulée renforcée à chantourner  
Coupe à gauche



**MA351**



250 10 MA351

8697M0260: pièces-détachées

Cisaille à tôle démultipliée  
Passe franc



**MA325**



250 4 MA325

Cisaille à tôle  
Passe-franc



**MR340**



340



2 MR340

Cisaille à tôle  
Coupes rectilignes, courbes à gauche



**586D**



280



4 586D

Cisaille à tôle , Coupes rectilignes, lames larges



**M526**



260



4 M526

Cisaille à tôle  
Coupes rectilignes, courbes à droite



**583D**



280



4 583D

Cisaille à tôle , Coupes rectilignes et à gauche



**M227L**



270



4 M227L

Cisaille à tôle modèle spécial  
Coupe à droite



**8691**



255 mm  
300 mm



6 869102500  
6 869103000

Cisaille à tôle  
Coupes rectilignes, courbes à gauche



**584D**



280



4 584D

Cisaille à tôle , Coupes rectilignes et à droite



**M227R**



270



4 M227R

Cisaille à tôle, modèle spécial  
Type Catalan



**8692**



300 mm



6 869203000

Cisaille à tôle  
Coupes rectilignes, courbes à droite



**585D**



280



4 585D

Cisaille à tôle  
Passe-franc



**M330**



11 3/4



4 M330

Cisaille à tôle  
Coupes rectilignes, lames fines



**MR126**



260



4 MR126



Cisaille à tôle ,  
Coupes rectilignes et à gauche



**MR227L**



270



4 MR227L

Cisaille à tôle  
Coupes rectilignes et à droite



**MR227R**



270



4 MR227R

Cisaille à tôle  
Coupes rectilignes, une lame fine, une lame large



**MR726**



260



4 MR726

Cisaille à tôle démultipliée à 2 mains



**M6376**



760



1 M6376  
1 M6376-SH

Cisaille à tôle démultipliée à 2 mains



**M676**



760



1 M676  
1 M676-SH

Cisaille à tôle grignoteuse



**M926**



250



1 M926  
1 M926-SH

Ciseaux multi-usages



**2744**



190



6 2744

## CISEAUX

Ciseaux Electricien grande capacité



**SCB140**



90 mm



140



10 SCB140

Ciseaux Electricien rainurés grande capacité



**SCB140G**



43 mm



140



10 SCB140G

Ciseaux Electricien  
S = lame dentelée



**SC127/SC127S**



45 mm



130



10 SC127

45 mm

127

10 SC127S



Ciseaux d'électricien à lames incurvées



**SC140/SC140C**

50 mm	145	10	SC140
50 mm	145	10	SC140C

Ciseaux d'électricien



**SC150NG**

38 mm	155	10	SC150NG

Ciseaux spéciaux



**2704**

110		1	2704A

Forceps



**2705R**

160		1	2705R

**COUTEAUX**

Couteau Utility Ergo™ lame rétractable



**KERU01**

170		26 mm	5	KERU-01

Couteau Utility Ergo™ lame fixe



**KEFU-01**

170		26 mm	5	KEFU-01

Cutter Ergo™ 18 mm



**KE18-01**

161		26 mm	5	KE18-01

Cutter à lame rétractable ETP



**KBRU-01**

170		26 mm	5	KBRU-01

Cutter à lame rétractable



**KGRU-01**

160		26 mm	5	KGRU-01

Couteau Utility lame rétractable twist



**KGRU-02**

145		26 mm	5	KGRU-02

Couteau Utility mini rétractable



**KMU-01**

90		26 mm	5	KMU-01

Cutter à lame rétractable



**SQZ150003**

170		60 mm	6	SQZ150003



Couteau Utility lame fixe ETP



**KBFU-01**



170 26 mm 5 KBFU-01

Couteau Utility lame fixe



**KGFU-01**



160 26 mm 5 KGFU-01

Lames couteau Utility



**KBGU**



0.635 x 19 x 60 mm 1 KBGU-100P

Lames de couteaux trapézoïdales dans un présentoir de 5 pièces



**KBGU-5P-DISPEN**



0.635 x 19 x 60 mm 20 KBGU-5P-DISPEN

Distributeur de 10 lames trapézoïdales



**KBGU-10P-DISPEN**

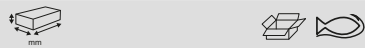

0.635 x 19 x 60 mm 20 KBGU-10P-DISPEN

Lames de couteaux Utility double crochet dans un présentoir de 5 pièces



**KBGH-5P-DISPEN**

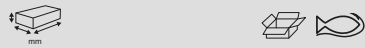

0.635 x 19 x 60 mm 20 KBGH-5P-DISPEN

Lames de couteaux Utility Safety dans un présentoir de 5 pièces



**KBGR-5P-DISPEN**

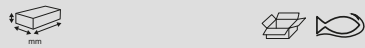

0.635 x 19 x 55 mm 20 KBGR-5P-DISPEN

Boîte de 12 Lames de rechange standard



**SQZ150003-SBL**

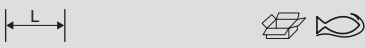

60 1 SQZ150003-SBL

Boîte de 12 lames de rechange



**SQZ150003-HSBL**



51 6 SQZ150003-HSBL

Cutter 9 mm ETP



**KB09-01**

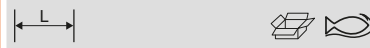

140 5 KB09-01

Cutter 18 mm ETP



**KB18-01**

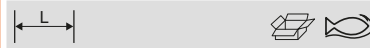

160 5 KB18-01

Cutter 9mm



**KG09-01**

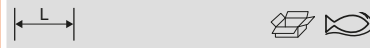

140 5 KG09-01  
140 10 KG09-01-3P

Cutter 18mm



**KG18-01**



160



5 KG18-01

Distributeur de 5 lames à segments cassants de 18 mm



**KUBG18-5DISPEN**



15 x 30 x 130 mm



20 KUBG18-5DISPEN

Mini couteau universel Utility



**SQZ-MINI**



160



24 SQZ-MINI

Distributeur de 5 lames à segments cassants de 9 mm



**KUBG09-5DISPEN**



15 x 20 x 100 mm

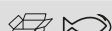

20 KUBG09-5DISPEN

Distributeur de lames sécables 18 mm, 10 unités



**KSBG18-10DISPEN**



15 x 30 x 130 mm



20 KSBG18-10DISPEN

Distributeur de lames pour couteau universel



**SQZ-MINI-BLADE**



28 mm



1 SQZ-MINI-BLADE

Distributeur de 10 lames à segments cassants de 9 mm



**KSBG09-10DISPEN**



1 x 9 x 85 mm



20 KSBG09-10DISPEN

Couteau Utility



**KGAU-01**



160



5 KGAU-01

Couteau sport double lame



**KBTU-01**



160



20 mm



5 KBTU-01

Lames non sécables



**KUBG**



0.7 x 85 x 9 mm  
1 x 110 x 18 mm



60 KUBG09-5P  
20 KUBG18-5P

Étui pour couteaux de la gamme Utility



**KHU-01**



90



4 KHU-01

Couteau Sport



**KBSK-01**



170



5 KBSK-01



Couteau lame rétractable Utility Sport



**KBSU-01**

160	5	KBSU-01	

Couteau Utility Sport



**KGSU-01**

160	5	KGSU-01	

Couteau multi-usages



**2444**

220	100 mm	15	2444

Couteau flottant de sauvetage



**1446-FLOAT**

226	102 mm	15	1446-FLOAT

Couteau de sécurité



**2446-SAFE**

215	15	2446-SAFE	

Sceau pour couteaux 1446



**BUCKET 1446**

30l	75	BUCKET 1446	

Couteau LAPLANDER



**2444-LAP**

220	100 mm	10	2444-LAP

Couteau, sur carte plastique



**SB-2444**

220	100 mm	1	SB-2444

Couteau multi-usages, robuste avec une solide lame en acier  
Etui spécial avec deux boutons



**2446**

225	100 mm	15	2446

Couteau robuste avec une lame en acier trempé pour tout usage  
Etui spécifique



**2446-OV**

220	100 mm	15	2446-OV

Couteau multi-usages avec lame solide en acier inoxydable  
Etui spécial avec bouton double couteau



**1446**

220	100 mm	15	1446

Couteau robuste multi-usages avec une lame en acier trempé  
Etui spécifique



**1446-OV**

225	100 mm	15	1446-OV

Couteau pour lino



**2446-LINO**

180	55 mm	12	2446-LINO

Couteau d'électricien pour dénuder  
Pour droitiers



**2446-ELR**

34 mm	145	12	2446-ELR

Couteau d'électricien, lame repliable, manche bois



**2820EF1**

90 mm	200	12	2820EF1

Couteau d'électricien, pour dénuder avec les deux mains



**2446-EL**

32 mm	150	12	2446-EL

Couteau d'électricien avec guide



**2446-EL-HELP**

43 mm	160	12	2446-EL-HELP

Couteau d'électricien, lame repliable, manche plastique



**2820EF2**

85 mm	195	8	2820EF2

Couteau d'électricien, pour dénuder avec les deux mains



**SB2446-EL**

150	32 mm	10	SB2446-EL

Poinçon d'électricien



**2820EK-01**

25 mm	130	12	2820EK-01

Couteau d'électricien, lame repliable, manche plastique



**2820EF3**

80 mm	170	1	2820EF3

Couteau d'électricien pour dénuder  
Pour gauchers



**2446-ELL**

34 mm	150	12	2446-ELL

Couteau d'électricien isolé



**2820EK**

95 mm	205	6	2820EK

Couteau d'électricien, lames repliables, manche plastique  
2 lames



**2820EF4**

75-85 mm	170	1	2820EF4



Outil multi-usages



**MTT151**



150



6 MTT151

Grattoir métallique pour surfaces vitrées



**KRSS-01**



80



10 KRSS-01

Mini Multitool avec anneau porte-clés



**MTT121**



110



8 MTT121

Grattoir manche bi-matière en plastique, pour surfaces vitrées



**KBWS-01**



70



10 KBWS-01

Outil multi-fonction 12 en 1 corps aluminium



**MTT051**



165



6 MTT051

**BAHCO**



## Serre-joints et étaux



## SERRE-JOINTS

### Serre-joint automatique



#### QCB

L			
456	6	QCB-150	
606	6	QCB-300	
756	6	QCB-450	
906	4	QCB-600	
1206	4	QCB-900	
1556	8	QCB-1250	

### Serre-joint automatique



#### QCG

L			
380	6	QCG-150	
530	6	QCG-300	

### Serre-joint automatique



#### QC

X	L		
1	230 mm	10	QC-115A
2	230 mm	10	QC-115A-2P
1	305 mm	6	QC-150A
2	305 mm	6	QC-150A-2P
1	475 mm	6	QC-300A
2	475 mm	6	QC-300A-2P

### Serre-joint acier



#### 3066

L			
405	90 mm	5	306601500
300	90 mm	5	306602000
260	90 mm	5	306603000
510	90 mm	5	306604000

### Serre-joint acier



#### 3067

L			
415	125 mm	5	306703000
510	125 mm	5	306704000
610	125 mm	5	306705000
710	125 mm	5	306706000
910	125 mm	5	306708000
1115	125 mm	5	306710000
1310	125 mm	2	306712000
1610	125 mm	2	306715000

### Serre-joint acier



#### 3068

L			
430	155 mm	5	306803000
535	155 mm	5	306804000
640	155 mm	2	306805000
730	155 mm	2	306806000
820	155 mm	2	306808000
1135	155 mm	2	306810000
1335	155 mm	2	306812000
1630	155 mm	1	306815000
2130	155 mm	1	306820000

### Serre-joint acier Poignée en T



#### 3069

L			
430	225 mm	2	306903000
540	225 mm	2	306904000
638	225 mm	2	306905000
730	225 mm	2	306906000
932	225 mm	2	306908000
1130	225 mm	2	306910000

### Serre-joint à pompe



#### 420SH

L			
100	50 mm	10	420SH-50-100
200	50 mm	10	420SH-50-200
120	60 mm	12	420SH-60-120
300	60 mm	12	420SH-60-300
160	80 mm	12	420SH-80-160
200	100 mm	10	420SH-100-200
250	120 mm	8	420SH-120-250
300	120 mm	8	420SH-120-300
400	120 mm	6	420SH-120-400
500	120 mm	6	420SH-120-500
600	120 mm	6	420SH-120-600
800	120 mm	6	420SH-120-800
1000	120 mm	6	420SH-120-1000
1250	120 mm	6	420SH-120-1250
1500	120 mm	6	420SH-120-1500
400	140 mm	6	420SH-140-400
400	175 mm	6	420SH-175-400



Pince de serrage rapide



**420SC**

	g		
25 mm	60	10	420SC-25
50 mm	120	5	420SC-50

**ÉTAUX**

Etau d'établi à guide carré



**834V**

100		1	834V-4
125		1	834V-5
150		1	834V-6
175		1	834V-7

Vis de réglage du jeu

Etau à guide carré



**6072**

100		1	607201000
125		1	607201250
150		1	607201500
175		1	607201750

Etau acier à guide rond



**6010**

80		1	601000800
100		1	601001000
125		1	601001250
150		1	601001500

Etau à agrafe



**834V-2**

63		1	834V-2

Paire de mors avec vis pour étau 6072



**6072M**

100		1	6072M1000
125		1	6010M1250
150		1	6072M1500
175		1	6072M1750

Jeu de 2 mors pour 834V



**833P**

100		1	833PJ-4
125		1	833PJ-5
150 / 175		1	833PJ-67

Broche pour étau 6072



**6070H**

100		1	6070H1000
125		1	6070H1250
150		1	6070H1500
175		1	6070H1750

2 mors pour étau 6010



**6010M**

80		1	6010M0800
100		1	6010M1000
150		1	6010M1500



Broche et vis pour étau 6010



**6010H**

↓ ↑	↓ ↑	↓ ↑
80	1	6010H0800
100	1	6010H1000
125	1	6010H1250
150	1	6010H1500

Mors en aluminium



**833AJ**

↓ ↑	↓ ↑	↓ ↑
100	1	833AJ-4
125	1	833AJ-5
150	1	833AJ-6

2 mors avec broche pour étau 834V-2



**6040M/H**

↓ ↑	↓ ↑	↓ ↑
63	1	6040M0630

Mors en fibre



**833FJ**

↓ ↑	↓ ↑	↓ ↑
100	1	833FJ-4
125	1	833FJ-5
150	1	833FJ-6

**ACCESSOIRES POUR ÉTAUX**

Base tournante pour 834V



**833SB**

↓ ↑	↓ ↑	↓ ↑
80	100	1 833SB-4
100	125	1 833SB-5
125	150	1 833SB-6
150	175	1 833SB-7



## Marteaux



## MARTEAUX DE COFFREUR

Marteau arrache-clous Ergo™

ergo®



**529**

ergo

450	4 529-16-L
450	4 529-16-XL
570	4 529-20-L
570	4 529-20-XL

Marteau arrache-clous Ergo™

ergo®



**529S**

450	4 529S-16-XL
570	4 529S-20-XL

Marteau arrache-clous



**429**

230	4 429-8
370	4 429-13
450	4 429-16
570	4 429-20

Marteau à panne fendue



**428**

450	4 428-16

Marteau à panne fendue manche fibre de verre



**428F**

230	4 428F-8
370	4 428F-13
454	4 428F-16
567	4 428F-20
680	4 428F-24

Marteau de coffreur manche en fibre de verre



**428S**

454	4 428S-16
567	4 428S-20

Marteau à panne fendue



**427**

370	4 427-13
680	4 427-24
230	4 427-8
450	4 427-16
570	4 427-20

Marteau à panne fendue manche bois Hickory



**427S**

454	4 427S-16
567	4 427S-20

Marteau de coffreur



**427**

700	6 427-700

Marteau de coffreur



**428**

Icon	Icon
700	6 428-700

**ARRACHE-CLOUS**

Arrache-clou compact avec ressort interne



**36**

Icon	Icon
220	5 36

Arrache-clou



**38**

Icon	Icon
450	1 38

Arrache-clou avec manche confortable et mâchoires spécialement durcies

**MARTEAUX DE MÉCANICIEN**

Marteau de serrurier - tête ronde



**479**

Icon	Icon
230	6 479-08
340	6 479-12
450	6 479-16
570	6 479-20
800	6 479-24
900	6 479-32

Marteau de serrurier tête ronde manche fibre de verre



**479F**

Icon	Icon
230	6 479F-08
340	6 479F-12
450	6 479F-16
570	6 479F-20
800	6 479F-24
900	6 479F-32

Marteau de serrurier



**481**

Icon	Icon
100	6 481-100
200	6 481-200
300	6 481-300



400	6 481-400
500	6 481-500
800	6 481-800
1000	6 481-1000
1500	6 481-1500
2000	6 481-2000

Marteau de serrurier manche fibre de verre



**481F**

Icon	Icon
100	6 481F-100
1000	6 481F-1000
1500	4 481F-1500
200	6 481F-200
2000	4 481F-2000
300	6 481F-300
400	6 481F-400
500	6 481F-500
800	6 481F-800

Marteau Rivoir



**482**

Icon	Icon
300	6 482-25
400	6 482-28
500	6 482-30
800	6 482-35
1000	6 482-40
1500	6 482-45



Marteau rivoir manche fibre de verre



**482F**

Icon	Icon	Icon
300	4	482F-25
400	4	482F-28
470	6	482F-30
800	4	482F-35
1000	2	482F-40
1500	4	482F-45

Marteau de menuisier



**480**

Icon	Icon	Icon
230	4	480-08
280	4	480-10
340	4	480-12
400	4	480-14
570	4	480-20

Marteau de précision



**492**

Icon	Icon	Icon
100	4	492-3.5

**MARTEAUX DE CONSTRUCTION**

Marteau de charpentier



**485**

Icon	Icon	Icon
600	6	485

Marteau de charpentier arrache clou  
SH-485W : Manche de rechange avec coin, SH-485W-PLATES : rails de rechange avec rivets



**485W**

Icon	Icon	Icon
650	4	485W-650
750	4	485W-750
	1	SH-485W
	1	SH-485W-PLATES

Marteau de menuisier



**483**

Icon	Icon	Icon
100	6	483-16
160	6	483-20
200	6	483-22
300	6	483-25
400	6	483-28
500	6	483-30

Marteau de menuisier manche fibre de verre



**483F**

Icon	Icon	Icon
100	6	483F-16
160	6	483F-20
200	6	483F-22
300	6	483F-25
400	6	483F-28
500	4	483F-30

Marteau de précision



**490**

Icon	Icon	Icon
100	4	490-3.5

Massette



**484**

Icon	Icon	Icon
1000	6	484-1000
1250	6	484-1250
1500	6	484-1500
2000	6	484-2000

Massette manche fibre de verre



**484F**

Icon	Icon	Icon
1000	6	484F-1000
1250	6	484F-1250
1500	6	484F-1500
2000	4	484F-2000

Marteau à tête carrée  
Manche en bois



**488**

Icon	Icon	Icon
2000	2	488-2000
3000	2	488-3000
4000	2	488-4000
5000	2	488-5000
6000	1	488-6000

Briqueteur de type espagnol



**486-700**

Icon	Icon	Icon
700	6	486-700

Marteau club avec poignée Hickory



**407**

Icon	Icon	Icon
700	6	407-700
1000	6	407-1000
1400	6	407-1400

Marteau traineau à tête carré  
Poignée de fibre de verre



**488F**

Icon	Icon	Icon
2000	2	488F-2000
3000	2	488F-3000
4000	2	488F-4000
5000	4	488F-5000
6000	2	488F-6000

Briqueteur de type espagnol



**486F**

Icon	Icon	Icon
700	6	486F-700

Marteau club poignée fibre de verre



**407F**

Icon	Icon	Icon
700	6	407F-700
1000	6	407F-1000
1400	6	407F-1400

Marteau de maçon  
SH-486W : Poignée de rechange



**486W**

Icon	Icon	Icon
500	4	486W-500
600	4	486W-600
	1	SH-486W

Marteau de maçon



**486**

Icon	Icon	Icon
600	4	486



### Chevillette de maçon



#### 4401



255	10	440102500
300	10	440103000

### Manche de rechange en bois



#### WSH



407	1	SH-407
491-3000 & 491-4000	12	SH-491-34
491-5000 & 491-6000	12	SH-491-56
488-2000	10	SH-488-2000
488-3000, 488-4000	10	SH-488-34
488-5000, 488-6000	10	SH-488-56
427-700	10	SH-427-700
486-700, 495-500, 495-600, 493-500, 493-600	10	SH-486-493-495

### Manche de rechange en fibre de verre



#### FSH



488f-2000	10	SH-488F-2000
488F-3000 & 488F-4000	1	SH-488F-34
488F-5000 & 488F-6000	1	SH-488F-56
428-700	10	SH-428-700
486F-700, 495F-500, 495F-600, 493F-500, 493F-600	10	SH-486F493F495F

## MARTEAUX SPÉCIAUX

### Hache de pelle de type espagnole



#### 493



500	6	493-500
600	6	493-600

### Hache de pelle de type espagnol



#### 493F



500	6	493F-500
600	6	493F-600

### Pioche de pelle de type espagnol



#### 495



500	6	495-500
600	6	495-600

### Pelle de type espagnol



#### 495F



500	6	495F-500
600	1	495F-600

### Hachette de plâtrier



#### 494



600	4	494-600
-----	---	---------

## MASSES

### Massette anti-rebond



#### 3625AR



550	34	3625AR-35
1430	18	3625AR-50
1550	12	3625AR-60



### Embouts de rechange pour marteaux 3625AR



#### 3625ARL

Ø	Icon	Qty	Part No.
35 mm		6	3625ARL-35
50 mm		6	3625ARL-50
60 mm		6	3625ARL-60

### Manche de rechange pour marteaux 3625AR



#### 3625ARLH

Icon	L	Qty	Part No.
	290	80	3625ARLH-35
	300	50	3625ARLH-50
	390	16	3625ARLH-60

### Massette anti-rebond



#### 3625PU

Icon	Qty	Part No.
	12	3625PU-30
	6	3625PU-50
	6	3625PU-60

### Marteau anti-rebond



#### 3625PU-105

Icon	g	Qty	Part No.
	5600	4	3625PU-105

### Marteau de serrurier



#### 491

Icon	Qty	Part No.
	4	491-3000
	4	491-4000
	4	491-5000
	4	491-6000

### Massette sans rebond



#### 489-1100/489-1800

Icon	Qty	Part No.
	1	489-1100
	1	489-1800

### Massette sans rebond



#### 489-2700/489-5400

Icon	Qty	Part No.
	1	489-2700
	1	489-3600
	1	489-4500
	1	489-5400

## MARTEAUX ET MAILLETS SOUPLES

### Embouts de rechange Polyflex



#### 3625Y

g	Qty	Part No.
150	1	3625Y-22
240	1	3625Y-27
340	1	3625Y-32
430	1	3625Y-35
570	1	3625Y-40
930	1	3625Y-50
1270	1	3625Y-60

### Paire d'embouts de rechange pour 3625Y



#### 3625YL

Icon	Ø	Qty	Part No.
	22 mm	1	3625YL-22
	27 mm	1	3625YL-27
	32 mm	1	3625YL-32
	35 mm	1	3625YL-35
	40 mm	1	3625YL-40
	50 mm	1	3625YL-50
	60 mm	1	3625YL-60



### Embouts de rechange Superflex



#### 3625N

g		
170	5	3625N-22
250	5	3625N-27
333	5	3625N-32
560	5	3625N-40
1200	1	3625N-60

### Paire d'embouts de rechange pour 3625W et 3625S



#### 3625WL

3625W-22	22 mm	10	3625WL-22
3625W-28, 3625S-28	28 mm	10	3625WL-28
3625W-35, 3625S-35	35 mm	10	3625WL-35
3625W-44, 3625S-44	44 mm	10	3625WL-44
3625W-55	55 mm	6	3625WL-55

### Maillet en caoutchouc



#### 3625RM

g		
290	50	3625RM-55
460	40	3625RM-65
660	30	3625RM-75
850	20	3625RM-90

### Paire d'embouts de rechange pour 3625N



#### 3625NL

3625N-27	27 mm	1	3625NL-27
3625N-32	32 mm	1	3625NL-32
3625N-40	40 mm	1	3625NL-40
3625N-50	50 mm	1	3625NL-50
3625N-60	60 mm	1	3625NL-60

### Manche de rechange pour marteaux 3625W



#### 3625WLH

3625W-22		50	3625WLH-22
3625W-28		50	3625WLH-28
3625W-35		80	3625WLH-35
3625W-44		50	3625WLH-44
3625W-55		16	3625WLH-55

### Masse tête en cuivre



#### 4130

500	12	413005000
1000	12	413010000
1500	12	413015000
2000	6	413020000
3000	1	413030000
4000	1	413040000

### Massette à embouts nylon WL extrémité de rechange, WLH manche de rechange



#### 3625W

g		
150	120	3625W-22
250	72	3625W-28
490	40	3625W-35
1050	18	3625W-44
1470	12	3625W-55

### Maillet à bout nylon



#### 3625S

g		
350	50	3625S-28
610	30	3625S-35
1100	18	3625S-44



## Outils pour travaux forestiers et d'abattage d'arbres



## HACHES, HACHETTES ET MASSES

Hachette



**HUS**

380	830	4	HUS-0.6-380
500	1030	4	HUS-0.8-500

Hachette type allemand, manche frêne



**HGPS**

360	714	4	HGPS-0.6-360-WB
380	944	4	HGPS-0.8-380-WB
400	1130	4	HGPS-1.0-400-WB
360	810	10	HGPS-0.6-360
380	930	4	HGPS-0.8-380
400	1180	4	HGPS-1.0-400

Hache d'abattage avec poignée composite



**CUC**

360	640	4	CUC-0.4-360

Hachette



**HUS-1.0-650**

650	1610	4	HUS-1.0-650

Hachette multi-usages, manche fibre de verre



**HFGPS**

380	1010	4	HFGPS-0,7-400FG

Hache d'abattage légère avec poignée composite



**CUC-0.8-600**

600	1220	4	CUC-0.8-600

Hache type allemand, manche en frêne



**FGS-810**

800	2230	4	FGS-1.6-810
800	2480	4	FGS-1.8-810

Hache type canadien, manche Hickory



**FCP**

800	2540	4	FCP-1.8-810
850	3000	2	FCP-2.3-860

Hache type allemand, manche en frêne



**FGS**

700	1730	4	FGS-1.25-700-WB
810	2210	4	FGS-1.6-810-WB
600	1330	4	FGS-1.0-600
700	1850	4	FGS-1.25-700

Hache d'abattage, manche fibre de verre



**FFSS**

900	2400	4	FFSS-1.5-900FG

Hache, manche frêne



**SUS**

800	2660	4	SUS-2.0-800

Merlin type canadien, manche Hickory





**MCP**

800	3300	2	MCP-2.5-810

### Hache à fendre avec poignée composite



#### SUC

			
450	980	4	SUC-0.7-450
600	1310	4	SUC-0.9-600
710	1550	4	SUC-1.0-710
780	2300	4	SUC-1.7-800

### Masse couple, manche fibre de verre



#### LS-MASSE

			
900	4800	2	LS-MASSE-4FG
900	4450	2	LS-MASSE-4

### Masse couple, manche fibre de verre





#### LS-MASSE-TR

			
900	4840	2	LS-MASSE-TR-4FG

### Manche de rechange





#### SH

		
800	1	SH-FCS-810
900	1	SH-FCS-860
600	1	SH-FGS-600
700	12	SH-FGS-700
800	1	SH-FGS-800
900	1	SH-FGS-1.8-810
375	1	SH-HGPS-400FG
400	1	SH-HGPS-400
900	12	SH-MES-F-900
360	12	SH-HGPS-360
380	1	SH-HGPS-380
380	1	SH-HUS-380
500	1	SH-HUS-500
650	1	SH-HUS-650
900	12	SH-MES-900
915	12	SH-MES-900FG
800	12	SH-SUS-800
800	1	SH-MCS-800
905	1	SH-FCP-860

### Hache à refendre



#### LS/MES

			
900	3270	2	LS-MERLIN-2.5
900	3330	2	LS-MERLIN-2.5FG
900	3620	2	MES-3.0-900

### Merlin 3.5 kg



#### MES

			
900	3880	2	MES-3.5-900
900	4310	2	MES-3.5-900FG

### Pioche



#### PAGS-2.0-900FG

			
900	3000	1	PAGS-2.0-900FG

### Têtes de pioche



#### PAGS

			
450	2000	1	PAGS-2.0

### Manche de rechange pour pioche



#### SH-PAGS

			
900	690	1	SH-PAGS-900
920	1030	1	SH-PAGS-900FG



## COINS

Coins de calage



### LS-COIN

← L →	g		
260	295	2	LS-COIN 26 CM
190	170	4	LS-COIN 19 CM

Coins à fendre en acier



### WT

← L →	g		
220	2000	4	W-T-2.0

Coins à fendre en acier



### WS

← L →	g		
230	1500	4	W-S-1.5
250	2000	4	W-S-2.0
260	2500	4	W-S-2.5



## Burins et poinçons



## BURINS

Burin de mécanicien



### 3740

L		
100	5	3740-100
125	5	3740-125
150	1	3740-150
175	5	3740-175
200	5	3740-200
250	5	3740-250
300	5	3740-300

Burin de Mécanicien



### SB-3740

L		
125	5	SB-3740-125
150	5	SB-3740-150
175	5	SB-3740-175
200	5	SB-3740-200
250	5	SB-3740-250
300	5	SB-3740-300

Burin de mécanicien



### 3640

L		
150	6	3640-150-C
200	5	3640-200-C
250	5	3640-250-C
300	6	3640-300-C

Burin avec tête sécurisée contre les impacts



### 3756

L			
125	10 mm	5	3756-125
150	12 mm	50	3756-150

Bédane de mécanicien



### 3745

L			
150	6 mm	5	3745-150
175	7 mm	5	3745-175
200	8 mm	5	3745-200
250	9 mm	5	3745-250

Bédane avec corps octogonal



### 3749

L			
125	10 mm	1	3749-125

Burin à coupe en bout



### 3750

L		
240	5	3750

Ciseau



### 8740

L		
200	5	874002000
250	5	874002500
300	5	874003000
350	5	874003500
400	5	874004000
500	5	874005000

Burin de maçon



### 3736M

L		
200	5	3736M-200
250	5	3736M-250
300	5	3736M-300
400	5	3736M-400

Jeu de burins et bédanes



### 3736S/6

g		
840	1	3736S/6

3735-4-120, 3735-5-150

3733-3

3749-125

3756-125, 3756-150



Burin pointu



**3739-250 / -400**

L	Ø	Icone	Quantité	Code
250	16 mm		5	3739-250
300	18 mm		5	3739-300
400	18 mm		5	3739-400

Burin de maçon pointu avec protecteur



**3739H**

L	Ø	Icone	Quantité	Code
250	16 mm		2	3739H-250
300	18 mm		2	3739H-300
400	18 mm		2	3739H-400

**BURINS, RÉAFFÛTABLES**

Ciseau



**8741**

L	Icone	Quantité	Code
200		6	874102000
250		5	874102500
300		5	874103000
350		4	874103500
400		5	874104000

**BURINS GAINÉS**

Burin à coupe en bout avec protecteur



**3750H**

L	Icone	Quantité	Code
240		1	3750H

**BURINS À MANCHE BI-MATIÈRE**

Burin gainé 15mm - vendu au détail



**SB3654BM**

L	Icone	Quantité	Code
155		5	SB3654BM-15
185		5	SB3654BM-20

Broche de maçon



**8746**

L	Ø	Icone	Quantité	Code
200	14 mm		5	874602000
250	14 mm		5	874602500
300	16 mm		5	874603000
350	16 mm		5	874603500
400	18 mm		5	874604000

Burin de maçon avec protecteur



**3736MH**

L	Icone	Quantité	Code
250		2	3736MH-250
300		2	3736MH-300
400		2	3736MH-400

Module mixte pour maçons



**3654BMS/7**

g	Icone	Quantité	Code
920		1	3654BMS/7

Ciseau d'électricien



**8760**

L	Icone	Quantité	Code
200		10	876002000
250		5	876002500



Burin de carrossier



**8770**

Ø	L	Icon
240		8 877002400

**POINÇONS**

Pointeau gainé



**3643**

Ø	L	Icon
3	100	5 3643-100
4	120	5 3643-120
5	120	5 3643-150

Pointeau



**3735**

Ø	L	Icon
4	120	5 3735-4-120
5	120	5 3735-5-120
5	150	5 3735-5-150

Pointeau corps hexagonal



**3735N**

Ø	L	Icon
2	100	10 3735N-2-100
4	120	10 3735N-4-120
5	120	10 3735N-5-120
6	150	10 3735N-6-150
8	150	10 3735N-8-150
2	100	1 SB-3735N-2-100
4	120	60 SB-3735N-4-120
5	120	1 SB-3735N-5-120
6	150	1 SB-3735N-6-150
8	150	1 SB-3735N-8-150

Jeu de pointeaux  
tailles 2-4-6-8mm



**3735NS/4**

g	Icon
340	25 3735NS/4

3735N-6-150, 3735N-8-150, 3735N-2-100,  
3735N-4-120

Pointeau



**1157**

Ø	L	Icon
2	130	60 1157

Chasse-clous gainé



**3644**

Ø	L	Icon
2	120	5 3644-120
3	125	5 3644-125
4	130	5 3644-130
4	150	5 3644-150
5	165	5 3644-165
6	180	5 3644-180
8	200	5 3644-200

Jeu de chasse-goupilles gainés



**3659**

Ø	L	Icon
0.9	75	5 3659-0.9
1.4	85	5 3659-1.4
1.8	85	5 3659-1.8
2.4	90	5 3659-2.4
2.8	95	5 3659-2.8
3.4	95	5 3659-3.4
3.9	100	5 3659-3.9
** 5.9	100	5 3659-6.0

Chasse-clous



**3733**

Ø	L	Icon
2	120	5 3733-2
3	120	5 3733-3
4	120	5 3733-4
5	120	5 3733-5
6	120	5 3733-6

### Chasse-goupilles gainé



#### 3646

Ø	L	Icon	Icon
2	115	5	3646-115
3	125	5	3646-125
4	150	5	3646-150
5	165	5	3646-165
6	180	5	3646-180
8	200	5	3646-200

### Chasse-goupilles gainé



#### 3658A

Ø	L	Icon	Icon
2	150	5	3658A-2
2	150	5	3658A-3
4	150	5	3658A-4
4	150	5	3658A-5
6	150	5	3658A-6
7	150	5	3658A-8

### Chasse-goupilles



#### 3734

Ø	L	Icon	Icon
2	150	5	3734-2
3	150	5	3734-3
4	150	5	3734-4
5	150	5	3734-5
6	150	5	3734-6
8	150	5	3734-8

### Chasse-goupilles



#### 3734N

Ø	L	Icon	Icon
2	150	10	3734N-2-150
3	150	10	3734N-3-150
4	150	10	3734N-4-150
5	150	10	3734N-5-150
6	150	10	3734N-6-150
7	150	10	3734N-7-150
8	150	10	3734N-8-150
9	150	10	3734N-9-150
10	150	10	3734N-10-150
2	150	1	SB-3734N-2-150
3	150	1	SB-3734N-3-150
4	150	60	SB-3734N-4-150
5	150	1	SB-3734N-5-150
6	150	60	SB-3734N-6-150
7	150	1	SB-3734N-7-150
8	150	1	SB-3734N-8-150
10	150	1	SB-3734N-10-150

### Jeu de chasse-goupilles gainés



#### 3646/6

g	Icon	Icon
730	1	3646/6

3646-115, 3646-125, 3646-150, 3646-165, 3646-180, 3646-200

### Jeu de burins et bédanes



#### 3654R

g	Icon	Icon
870	1	3654R

### Jeu de chasse-goupilles



#### 3659/8

g	Icon	Icon
270	1	3659/8

3659-0.9, 3659-1.4, 3659-1.8, 3659-2.4, 3659-2.8, 3659-3.4, 3659-3.9, 3659-6.0

### Jeu de chasse-goupilles



#### 3734S/6

g	Icon	Icon
720	1	3734S/6

3734-2, 3734-3, 3734-4, 3734-5, 3734-6, 3734-8



Jeu de burins, chasse-goupilles et pointeaux



**3656/10**

1260	1	3656/10

Jeu de chasse-goupilles gainés



**3658A/6**

560	1	3658A/6

3658A-2, 3658A-3, 3658A-4, 3658A-5, 3658A-6, 3658A-8

Jeu de chasse goupilles



**3659/8T**

170	1	3659/8T

3659-0.9, 3659-2.8, 3659-2.4, 3659-1.8, 3659-6.0, 3659-3.9, 3659-3.4, 3659-1.4

Jeu de 5 chasse-clous



**3733S/5**

410	1	3733S/5

2, 4, 6, 8, 10 mm

3733-2, 3733-4, 3733-6, 3733-8, 3733-10

Jeu chasse goupilles  
9 pcs 2-10 mm



**3734NS/9**

750	10	3734NS/9

3734N-10-150, 3734N-9-150, 3734N-8-150, 3734N-7-150, 3734N-6-150, 3734N-5-150, 3734N-4-150, 3734N-3-150, 3734N-2-150

Chasse-goupille gainé



**3732**

2	125	60	SB-3732-2-125
2.5	125	60	SB-3732-2.5-125
3.2	125	60	SB-3732-3.2-125
4	125	1	SB-3732-4-125

Découpe-joints



**B400**

--	--	--

2	1	B400.002
3	1	B400.003
4	1	B400.004
5	1	B400.005
6	1	B400.006
7	1	B400.007
8	1	B400.008
9	1	B400.009
10	1	B400.010
11	1	B400.011
12	1	B400.012
13	1	B400.013
14	1	B400.014
15	1	B400.015
16	1	B400.016
17	1	B400.017
18	1	B400.018
19	1	B400.019
20	1	B400.020
21	1	B400.021
22	1	B400.022
23	1	B400.023
24	1	B400.024
25	1	B400.025
26	1	B400.026
27	1	B400.027
28	1	B400.028
29	1	B400.029
30	1	B400.030
31	1	B400.031
32	1	B400.032
33	1	B400.033
34	1	B400.034
35	1	B400.035
36	1	B400.036
37	1	B400.037
38	1	B400.038
39	1	B400.039
40	1	B400.040
41	1	B400.041
42	1	B400.042
43	1	B400.043
44	1	B400.044
45	1	B400.045
46	1	B400.046
47	1	B400.047
48	1	B400.048
49	1	B400.049
50	1	B400.050

Poignée pour découpe-joints de 2 à 20 mm



**JLB.M.20N**



95 320 1 JLB.M.20N

Jeu de découpe-joints, 11 pièces



**400,003,020**



3-20 400.003.020

Pince rotative à crans



**2635**



245 1 2635

Poignée pour découpe-joints de 2 à 30 mm



**JLB.M.30N**

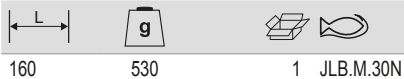

160 530 1 JLB.M.30N

Jeu de découpe-joints, 16 pièces



**400,003,030**



3-30 400.003.030

Poinçonneuse tournante



**4630**



220 1 4630

Poignée pour découpe-joints de 2 à 50 mm



**JLBM50M53PA**



170 780 1 JLBM50M53PA

Coffret de découpe-joints de 2 à 50 mm



**400,002,050**



2-50 mm 400.002.050

Emporte-Pièce



**6900**

	1	690000160
16	1	690000200
20	1	690000220
22	1	690000250
25	1	690000300
30	1	690000320
32	1	690000350
35	1	690000400
40	1	690000500
50	1	690000630
63	1	



Jeu de 7 emporte-pièces



**6907**

4080	1	69079019P

- 690000160, 690000250, 690000200, 690000320, 690000500, 690000400, 690000630
- 690900120, 690900080, 690900100, 690900200, 690900140

Vis pour emporte-pièces



**6909**

16	4	690900080
20-25	4	690900100
30-35	2	690900120
40-50	2	690900140
63	1	690900200

**POINÇONS AVEC MANCHE BI-MATIÈRE**

Chasse-clous gainé



**SB3755BM**

4	165	1	SB3755BM-4
6	185	5	SB3755BM-6

Chasse-goupilles gainé



**SB3734BM**

10	180	5	SB3734BM-10
3	155	5	SB3734BM-3
4	165	5	SB3734BM-4
5	165	5	SB3734BM-5
6	185	5	SB3734BM-6
8	185	5	SB3734BM-8

Jeu de chasse goupilles bimatière



**3734BMS/7**

900	1	3734BMS/7



## Pieds de biche



## PINCES À DÉCOFFRER

Pied de biche ajustable 260 mm



### APB260

260 mm	410	10	APB260

Pied de biche ajustable 360 mm



### APB360

360 mm	543	10	APB360

Pied de biche Crowfoot - extrémité fine



### CFP250

250	6	CFP250

Pied de biche Crowfoot - extrémité large de 10"



### CFW250

250 mm	6	CFW250

Pied de biche premium



### WBP

14 mm	346	20	WBP300
16 mm	487	12	WBP500
17 mm	625	12	WBP625
17 mm	704	10	WBP710
20 mm	890	6	WBP900

Pied de biche



### WBB

391	14 mm	10	WBB400
500	16 mm	10	WBB500
595	18 mm	10	WBB600
680	18 mm	6	WBB700
810	18 mm	6	WBB800
1000	20 mm	4	WBB1000
1200	20 mm	4	WBB1200
1500	22 mm	1	WBB1500

Pied de biche plat



### WBF380

374	35 mm	12	WBF380

Pied de biche plat mini



### WBMF190

18 mm	188	24	WBMF190

Jeu de pieds de biche premium comprenant :  
WBP300, WBF380 & WBMF190



### WBP-3P-3FMF

1600	1	WBP-3P-3FMF

WBP300

WBF380

WBMF190



Jeu de pieds de biche premium comprenant :  
WBP625, WBF380 & WBMF190



**WBP-3P-6FMF**

3000	1 WBP-3P-6FMF
WBP625	
WBF380	
WBMF190	

Jeu de pieds de biche Premium comprenant :  
WBP300, WBP625 & WBP900



**WBP-3P-963**

4740	1 WBP-3P-963
WBP900, WBP625, WBP300	

Jeu de pieds de biche Premium corps octogonal pour plus de robustesse



**WBP-3P-96F**

6000	1 WBP-3P-96F
WBP900, WBP625	
WBF380	





**BAHCO**



## Outils de plantation et de culture



## PELLES

Petite pelle à grains ou à neige



**LST-72324**



780

5 LST-72324

Pelle à grains ou à neige large



**LST-73524**



1270

5 LST-73524

Pelle à rebord



**LST-70120**



1295

5 LST-70120

## BÊCHES

Bêche à bord droit taille M



**LST-61121**



1080

5 LST-61121

Dresse bordure



**LST-63102**



1045

5 LST-63102

## FOURCHES

Fourche à bêcher forgée taille M



**LST-51121**



1030

5 LST-51121

Fourche à bêcher forgée taille L



**LST-52121**



1200

5 LST-52121

Aérateur de sol 4 dents



**LST-52102**



1110

5 LST-52102

Griffe rotative



**LST-99102**



1030

4 LST-99102

Fourche à fumier 4 dents



**LST-50123**



1215

5 LST-50123

## RÂTEAUX

Râteau 12 dents



**LST-30111**



1470

5 LST-30111

Râteau 16 dents



**LST-32011**



1545

5 LST-32011

Balai à feuilles ou à gazon 21 dents



**LST-41312**



1555



5 LST-41312

Balai à feuilles ou à gazon 29 dents



**LST-42312**



1730



5 LST-42312

Balai à gazon 16 dents



**LST-40311**



1700



5 LST-40311

**PETITS OUTILS DE JARDIN**

Binette



**P262**



315



10 P262

Binette



**P272**



450



5 P272

Serfouette panne & langue



**P268**



320



10 P268

Serfouette panne & langue



**P278**



455



5 P278

Serfouette panne & fourche



**P267**



320



10 P267

Serfouette panne & fourche



**P277**



455



5 P277

Transplantoir



**P263**



370



10 P263

Griffe



**P264**



315



10 P264



Griffe



**P274**



470



5 P274

Couteau désherbeur



**P269**



315



10 P269

Petit râteau



**P276**



450



5 P276

Fourche



**P270**



305



10 P270

Petit rateau



**P266**



335



10 P266

Plantoir à bulbes



**P241**



340



5 P241



## Outils arboricoles



## SÉCATEURS

Sécateur ergonomique à poignée fixe



**PX**

15	2 PX-S1
20	2 PX-S2
15	2 PX-M1
20	2 PX-M2
20	2 PX-M2-L
30	2 PX-M3
20	2 PX-L2
30	2 PX-L3

Sécateur ergonomique à poignée tournante



**PXR**

20 mm	2 PXR-S2-L
15	2 PXR-S1
20	2 PXR-S2
15	2 PXR-M1
20	2 PXR-M2
20	2 PXR-M2-L
30	2 PXR-M3
15	2 PXR-L1
20	2 PXR-L2

Tête de coupe pour PX-PXR



**R801P-R804P**

1	1 R801P
2	1 R802P

3	1 R803P
2	1 R804P

Lames de rechange pour PX-PXR



**R211P/R300P/R500P/R600P**

Px/ PXR N° 2, P1-20, P2-20	1 R211P
PX/ PXR N° 2, P1-20, P2-20	80 R211P-BULK80
Px/ PXR N° 1	1 R300P
Px/ PXR N° 3	40 R500P
Px-M2-L & PXR-M2-L	1 R600P

Contre-lames pour sécateur PX-PXR



**R303P-R603P**

Px-S1, Px-M1, Px-L1, PXR-M1, PXR-L1	1 R303P
Px-S2, Px-M2, Px-L2, PXR-M2, PXR-L2	1 R403P
Px-S3, Px-M3, Px-L3, PXR-M3, PXR-L3	1 R503P
Px-M2-L, PXR-M2-L	1 R603P

Paires de poignées Ergo™ pour sécateurs PX et PXR  
Livrées avec ressort



**R811P-RT825P**

Px-S	1 R811P
Px-M	1 R812P
Px-L	1 R813P
Px-M2-L	1 R815P
PXR-S	1 RT821P

PxR-M	1 RT822P
PxR-L	6 RT823P
PxR-M2-L	1 RT824P
PXR-S2-L	6 RT825P

Boulon d'axe pour sécateur Ergo™ PX-PXR



**R900P**

PX & PXR	20	1 R900P

Système de blocage d'écrou



**R901P**

PX & PXR	10	30 R901P

Set de vis de poignées pour PX-PXR



**R902P**

PX & PXR	20	24 R902P



Jeu de butées pour PX et PXR



**R903P/R1269P**

	g		
PX & PXR, P1 & P2, P64	10	1	R903P
PX & PXR, P1 & P2, P64	486	50	R1269P-BULK50

Fermeoir + plaquette pour PX et PXR



**R904P**

	g		
Px & PxR	10	1	R904P

Jeux de ressorts pour PX et PXR



**R905P-R907P**

	g		
PX & PXR, P64	10	1	R905P
PX & PXR, P64	164	50	R905P-BULK50
PX & PXR	10	1	R906P
PX & PXR	220	50	R906P-BULK50
PX & PXR	10	1	R907P

Sécateur forgé



**P3**

20	2	P3-20-F	
25	2	P3-23-F	

Sécateur



**P110**

20	2	P110-20-F	
25	2	P110-23-F	

Sécateurs, poignées composites



**P1**

20	5	P1-20	
30	5	P1-23	

Sécateurs à une main



**P108**

20	2	P108-20-F	
25	2	P108-23-F	

Sécateurs à une main, forgés, gainés



**P5**

20	2	P5-20-F	
25	2	P5-23-F	

Sécateur à enclume



**P138**

20	6	P138-22-F	



Sécateur à enclume



**P39**

25 mm	2	P39-22



Sécateur ergonomique à poignée tournante

ergo®



**PG-R-M**

20	2	PG-R-M2-F



Sécateur



**P126**

15 20	6	P126-19-F P126-22-F



Cueille-fleurs



**P64**

12 12	6 12	P64-20 P64-20-BULK12



Sécateur pour jardiniers, gauchers et droitiers



**PG-01-F/PG-03-L**

12-20 12-20	6 2	PG-01-F PG-03-L

Sécateur



**PG-12-F**

20 20 mm	10 15	PG-12-F PG-12-BULK15



Sécateur ergonomique de jardin à poignée fixe

ergo®



**PG-S/M/L**

15 20 20	2 2 2	PG-S1-F PG-M2-F PG-L2-F



Sécateur



**P121**

15 20 25	6 6 6	P121-18-F P121-20-F P121-23-F



Enclume + vis pour P138-22 et P38-20





**R221P/R222P**

P138-22 P138-22	1 50	R221P R221P-BULK50

Lame de rechange pour P1 et P2





**R201P/R171P**

  	
P1-22, P2-22	1 R201P
P1-22, P2-22	80 R201P-BULK80
P6-20, P7-20	1 R171P

Boulon d'axe pour P1, P2, P6, P7  
et échenilloirs P34-27A





**R239P/R141P/R142P/R157H**

  	
P34-27A, P3-20, P3-23, P5-20, P5-23, P108-20, P108-23, P110-20, P110-23	24 R142P
P39-22	24 R157H
P1-20, P1-22, P2-20, P2-22, P6-20, P7-20	1 R239P

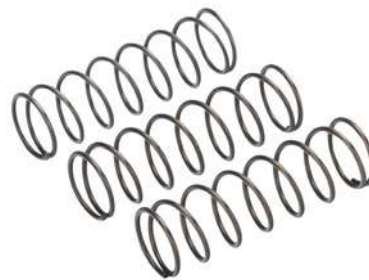
Ressort pour sérateurs P121, P138, P38, PG-04





**R438P/R463P**

  	
P39-22	1 R439P
P121-23	1 R463P
P138-22	1 R438P
P138-22	50 R438P-BULK50

Lame de rechange pour P3, P108, P138, P38  
et échenilloirs P134 et P34



**R112PG-R124PG/R224P**

  	
P3-20, P5-20	1 R112PG
P108-20, P110-20	1 R114PG
P3-23, P5-23	30 R122PG
P108-23, P110-23, P34-27A	30 R124PG
P138-22	1 R223P
P138-22	80 R223P-BULK80
P39-22	40 R224P

Contre-lame pour sérateur P108, P110





**R113PG/R123PG**

  	
P108-20, P110-20	30 R113PG
P108-23, P110-23	30 R123PG

Ressort et butée pour P1, P2, P6, P7



**R1069P**

  	
P1-20, P2-20, P6-20, P7-20	12 R1069P

Contre-lame pour sérateur P1, P2, P6 et P7





**R202P/R271P**

  	
P1-22, P2-22	1 R202P

Fermeture pour sérateur P3, P5, P108, P110



**R341P/R474P**

  	
P3-20, P3-23	12 R341P
P5-20, P5-23, P108-20, P108-23, P110-20, P110-23	1 R474P

Ressorts, butées + cuvettes



**R1068**

  	
P3-20, P3-23, P5-20, P5-23, P108-20, P108-23, P110-20, P110-23	1 R1068



Ressorts + butées pour P5 nouvelle version



**R1080P**

P5-20, P5-23	1	R1080P

Ensemble de vis + écrous + fermail



**R1601**

P1-20, P1-22, P2-20, P6-20, P7-20	1	R1601

Fermail livré avec vis + écrou



**R478P/R480P**

P108 P5	1 1	R478P R480P

**OUTILS POUR LA CUEILLETTE DE FRUITS**

Épinette



**P123**

10 10 10	15 30 56	P123-19-BULK15 P123-19-BULK30 P123-19-BULK56

Épinette



**P127**

6	30	P127-19-BULK30

Épinette



**P128**

6 6	6 30	P128-19 P128-19-BULK30

Épinette



**P129**

6	30	P129-19-BULK30

Pièces de rechange ressorts + butées  
P123/P127/P128/P129



**R1071/R1075**

P123, P127, P128, P129	20	14	R1071
P123, P127, P128, P129	130	50	R1075-BULK50

**ÉBRANCHEURS**

Ebrancheur pro super léger



**P114-SL**

30 30 30	400 500 600	2 2 2	P114-SL-40 P114-SL-50 P114-SL-60

Ebrancheur



**P16**

Icon	L	Icon	Icon
	30	400	2 P16-40
	30	500	2 P16-50-F
	30	600	2 P16-60-F

Ebrancheur pro Arboriculteur



**P160-SL**

Icon	L	Icon	Icon
	45	600	2 P160-SL-60
	45	750	1 P160-SL-75
	45	900	1 P160-SL-90

Ebrancheur démultiplié à enclume



**P173-SL**

Icon	L	Icon	Icon
	45 mm	850 mm	1 P173-SL-85

Ebrancheur à lames croisantes manches bois



**P16-40W**

Icon	L	Icon	Icon
	30 mm	400 mm	2 P16-40W

Ebrancheur



**P19**

Icon	L	Icon	Icon
	50	800	1 P19-80-F

Ébrancheur pour tailler les arbres et arbustes



**P130-P140**

Icon	L	Icon	Icon
	40	450	6 P130-F
	40	600	6 P140-F

Ebrancheur pro super léger



**P116-SL**

Icon	L	Icon	Icon
	35	400	2 P116-SL-40
	35	500	2 P116-SL-50
	35	600	2 P116-SL-60
	35	700	2 P116-SL-70

Ebrancheur démultiplié



**P280-SL**

Icon	L	Icon	Icon
	55 mm	600 mm	2 P280-SL-60
	55	800	2 P280-SL-80

Ebrancheur Expert



**PG-18**

Icon	L	Icon	Icon
	40	610	2 PG-18-60-F



## Ebrancheur léger 45cm



### PG-18-45



40 450 2 PG-18-45-F

## Ebrancheur télescopique Expert



### PG-19



40 700 - 900 2 PG-19-F

## Lame pour ébrancheurs



### R114V/R373A

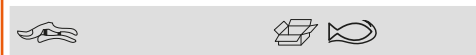

P14	28	R160A-BULK28
P14	25	R114V
P14	28	R114V-BULK28
P280	1	R181P
P-SL2, P116-SL	1	R16V
P-SL2, P116-SL	14	R16V-BULK14
P-SL, P114-SL	8	R115V
P-SL, P114-SL	14	R115V-BULK14
P172-85, P172-65	1	R172A
P16-40W	25	R116VP
P16	1	R116V
P16	36	R116V-BULK36
P19-80	1	R119V
P160	1	R160A
P180-70	20	R180V
P173-SL-85	25	R373A

## Contre-lame pour ébrancheurs



### R214V/R26V/R260A...



P14	1	R214V
P14	28	R214V-BULK28
P116-SL	8	R216SL
P-SL-40/45/60	1	R215V
P114-SL	1	R214SL
P160	16	R260A
P16*	40	R716VCB
P180-70	1	R680V
P19-80	1	R619V

## Butées de rechange pour ébrancheurs et cisailles à haies



### R430V-R516V

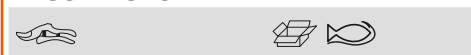

P-SL, P-SL2, P114, P116 - all 40 cm	1	R430V
P-SL, P-SL2, P114, P116, P52-SL, P54-SL	22	R440V

## Enclume + vis pour ébrancheur P172



### R372H

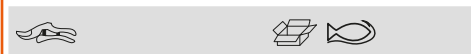

P172-65 /-85, P172-SL	1	R372H
-----------------------	---	-------

## Boulon d'axe pour ébrancheurs



### R312V-R318V/R143PV/R144PV/R146



P16	1	R143PV
P16*	1	R143PVCB
P160	24	R144PV
P14, P174, P176-75	24	R146VS
P14, P174, P176-75	50	R146VS-BULK50
P114-SL, P116-SL	22	R166V
P172-65 /-85	1	R312V
P-SL-40 /-45 /-60	1	R315V
P280-(SL)	22	R328V
P180-70, P19-80, P172	1	R318V

## Jeu complet vis/boulons de poignées



### R415V-R773V



P-SL, P-SL2, P114, P116	1	R415V
P180-70	1	R419V
P19-80	1	R519V
P14, P16	1	R615V
P160	24	R660V
P172-SL	14	R772V
P280-SL-80	1	R773V

## Came pour ajuster la lame à l'enclume



### R272H

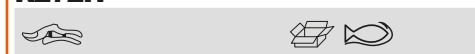

P172-65/-85, P172-SL-85	1	R272H
-------------------------	---	-------

## SCIES SUR PERCHES ET ÉCHENILLOIRS

Perche télescopique en aluminium



### ATP-200

2000-3520	1	ATP-200-350
2070-5040	1	ATP-200-500

Perches télescopiques



### AP-/FP-

2000 - 5000	1	AP-5M
2000 - 3500	1	AP-3M
1800 - 3200	1	FP-3M

Perche télescopique courte en aluminium léger



### ATP-110-210

1100 - 2100 mm	1	ATP-110-210

Perche à section en aluminium (base)



### ASP-1850G

1870 mm	1	ASP-1850G

Perche à section gainée en aluminium (base)



### ASP-1500G

1570 mm	1	ASP-1500G

Perche à section en aluminium (extension)



### ASP-1850

1870 mm	1	ASP-1850

Extension en aluminium pour perche à section



### ASP-1200

1270 mm	1	ASP-1200

Adaptateur pour scies sur perches



### ASP-AS

135 mm	4	ASP-AS

Adaptateur pour échenilloirs P34-37 et P34-27A-F



### ASP-ATP

160 mm	100	4	ASP-ATP

Adaptateur pour ATP-110-210



### RAUNI

ATP-110-210	82	6	RAUNI

Crochet pour perche avec adaptateur pour perches ASP et ATP-110-210



### ASP-AS-HOOK

325	4	ASP-AS-HOOK



Echenilloir à lames croisantes, Triple démultiplication



**P34-37**

40	2	P34-37

Échenilloirs avec action à double levier



**P134**

35 mm	2	P134
35 mm	2	P134-BULK

Echenilloir à lames croisantes, Double démultiplication



**P34-27A**

30	2	P34-27A-F

Echenilloir système coupe automatique



**AP-234**

30	2200	2	AP-234-F

Coupe-branches télescopique sur perche



**ATP-230-410**

32 mm	2370 - 4110 mm	2	ATP-230-410

Jeu échenilloir + sections



**ASP3740-P**

40 mm	1	ASP3740-P3437

**ASP-1850G**

**ASP-1850**

**P34-37**

**ASP-ATP**

**4750-PSTB-1**

Lame de rechange pour échenilloir



**R137E**

P34-37	30	R137E

Scie sur perche, coupe fine, s'adapte sur le système ASP



**ASP-AS-C-F**

330	7	5	ASP-AS-C33-JT-F

Scie sur perche, coupe moyenne, s'adapte sur le système ASP



**ASP-AS-C-M**

360	6,2	5	ASP-AS-C36-JT-M

Scie sur perche, grosse coupe, s'adapte sur le système ASP



**ASP-AS-C-C**

390	5,4	5	ASP-AS-C39-JT-C
450	5,4	2	ASP-AS-C45-JT-C

Scies arboricoles



**339-/340-**

360	250	4	339-6T
360	250	4	340-6T



Scies arboricoles pour perche télescopique  
Ø 25 mm



**383-/384-**

	g		
360	320	4	383-6T
360	320	4	384-6T
360	320	4	384-5T

Scies arboricoles pour perche télescopique Ø 25 mm



**385-/386-**

	g		
360	410	4	385-6T
360	410	4	386-6T

Jeu scie sur perche 360 mm + extensions



**ASP3740-C36JTM**

	g		
1950 mm	2819	1	ASP3740-C36JTM

ASP-1850G		
ASP-1850		
ASP-AS-C36-JT-M		
4750-PSTB-1		

Jeu scie sur perche 450 mm + extensions



**ASP3740-C45JTC**

	g		
1950 mm	2863	1	ASP3740-C45JTC

ASP-1850G		
ASP-1850		
ASP-AS-C45-JT-C		
4750-PSTB-1		

Jeu scie sur perche 390 mm + extensions



**ASP3740-C39JTC**

	g		
1950 mm	2838	1	ASP3740-C39JTC

ASP-1850G		
ASP-1850		
ASP-AS-C39-JT-C		
4750-PSTB-1		

Came et vis pour ATP-200-350/500



**RCAM**

	g		
ATP-200-350 ; ATP-200-500 ; ATP-110-210	29	20	RCAM30
ATP-200-500 ; ATP-110-210	37	20	RCAM36

Boulon d'axe complet



**R142P/R337E**

P34-37		1	R337E

Contre lame de rechange pour échenilloir P34-27A



**R133PG**

P34-27A		1	R133PG

Ressorts de rechange pour échenilloirs



**R427AE/R427E/R437E**

P134, P34-27A P34-37		18	R427AE R437E



## CISAILLES À HAIES

Cisaille à haies manches courts



**P51**

570	25	2	P51-F



Cisaille à haies manche en bois



**P57-25**

540	23	4	P57-25-F
540	23	4	P57-25-W-F



Cisaille légère de précision avec manches en aluminium



**P52-SL-20**

590 mm	18	2	P52-SL-20



Cisaille à haie professionnelle



**P51-SL**

570	25	2	P51-SL



Cisailles à haies, manches courts



**P54-SL**

500	18	2	P54-SL-20
550	22.5	2	P54-SL-25



Cisaille à haie ultra légère - Expert



**PG-56**

540	23	2	PG-56-F



Cisaille à haies professionnelle, manches longs



**P51H-SL**

730	1076 g	2	P51H-SL



Cisailles à haies, manches longs



**P54H-SL**

600	18	2	P54H-SL-20
650	22.5	2	P54H-SL-25



Cisaille à haies télescopique Expert



**PG-57-F**

800-1050 mm	20	2	PG-57-F



## Cisaille à haies



### P59



580 21 6 P59-25-F

## Butées pour cisailles à haies



### R440V-R516V

P14, P16, P180-70, P19-80, P160-60, P51	22	R515VS
P160, P160-SL, P280-SL	22	R516V
P53-SL, P54H-SL, P52-SL-20	22	R444V

## Axe complet, boulon/écrou et rondelle pour cisailles à haie



### R146VC/R147V

P51, P51H, P52, P53, P54, P52-SL-20	22	R146VC
P55, P57	24	R147V

## CISAILLES À GAZON

### Cisaille à gazon orientable 3 positions



### GS-76

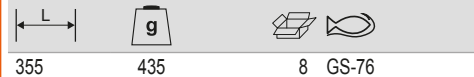

355 435 8 GS-76

### Cisaille à gazon orientable 9 positions (180°)



### GS-180

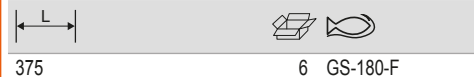

375 6 GS-180-F

### Cisaille à gazon



### P74



1100 2000 1 P74

### Cisaille à gazon



### P75

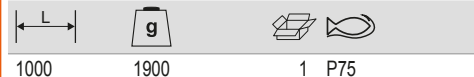

1000 1900 1 P75

## COUTEAUX DE JARDIN

### Greffoir



### P11



180 70 6 P11

### Serpette



### P20



190 100 6 P20

### Couteau de jardin



### K-AP-1



175 10 K-AP-1

### Couteau de jardin



### K-GP-1



170 10 K-GP-1



## CISEAUX

Ciseaux de petite taille



**FS-5**



125



10 FS-5



Ciseaux de taille moyenne



**FS-8**



165



10 FS-8



Ciseaux de grande taille



**FS-7.5**



200



10 FS-7.5



## SCIES À BÛCHES

Scie à bûches avec lame pour bois vert / sec  
23 : bois vert / 51 : bois sec

ergo®



**10**



530	21	5	10-21-51
607	24	5	10-24-23
607	24	5	10-24-51
759	30	5	10-30-23
759	30	5	10-30-51

Scie à bûches



**331-21**



530	21	5	331-21-51-KP
-----	----	---	--------------

Scie à bûches ergonomique

ergo®



**332**



530	21	5	332-21-51
-----	----	---	-----------

Scie à bûches, bois vert



**331-15**



378	15	5	331-15-23
-----	----	---	-----------

Scie à bûche professionnelle  
-23 : lame denture américaine



**SE -15/-16**



530	21	5	SE-16-21
530	21	5	SE-16-21-23
607	24	5	SE-15-24
759	30	5	SE-15-30
759	30	5	SE-15-30-23
810	32	5	SE-15-32
912	36	5	SE-15-36
912	36	5	SE-15-36-23

Scie à bûches à lame pivotante



**3-24-51**



607	24	5	3-24-51
-----	----	---	---------

Scie à bûches à lame pivotante



**2-21-51**



530 21 5 2-21-51

Scie à bûches à lame pivotante



**333**



350 14 5 333

Scie pour tubes de ventilation



**14-24**



607 24 5 14-24-3810

Monture de scie polyvalente



**9-12**



320 12 5 9-12-51/3806-KP

Lame de scie à bûches - bois sec



**51**



320	12	10	51-12
530	21	10	51-21
607	24	10	51-24
759	30	10	51-30
810	32	10	51-32
912	36	10	51-36

Lame de scie à bûches - bois vert



**23**



378	15	10	23-15
530	21	10	23-21
607	24	10	23-24
759	30	10	23-30
810	32	10	23-32
912	36	10	23-36

Lame de scie à bois



**333-5**



350 14 10 333-5

**SCIES ARBORICOLES**

Scie arboricole



**349**

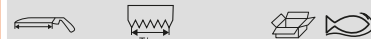

300 7 4 349

Scie arboricole repliable



**PG-72**



190 7 4 PG-72

Scie couteau pliable, denture XT, revêtement spécial



**396-LAP**



190 200 10 396-LAP  
190 44 100 396-BLADE



Scie arboricole repliable, denture JS



**396-JS**

190	5	4	396-JS

Scie arboricole avec étui, sans velcro



**51-JS**

240	4	5124-JS-H
280	4	5128-JS-H

Lames de rechange pour scies 41-JT



**4724-JT/4728-JT**

240	1	4724-JT
280	1	4728-JT

Scie arboricole repliable, denture JT



**396-JT**

190	7	4	396-JT

Scie arboricole, Denture JT



**41-JT**

240	4	4124-JT-H
280	4	4128-JT-H

Lame de rechange pour scie 396-JS



**396-JS-BLADE**

190	1	396-JS-BLADE

Scie arboricole repliable, denture trempée XT



**396-HP**

190	7	4	396-HP

Jeu de couteau et scie pliable



**LAP-KNIFE**

329	10	LAP-KNIFE

Lame de rechange pour scie 396-JT



**396-JT-BLADE**

190	1	396-JT-BLADE

Scies arboricoles poignée bois



**4211-/4212-**

280	4	4211-11-6T
360	4	4211-14-6T
280	4	4212-11-6T
360	4	4212-14-6T

Lames de rechange pour scies 41-JS, 51-JS



**5724-JS/5728-JS**

240	1	5724-JS
280	1	5728-JS

Lame de rechange pour scie 396-HP



**396-HP-BLADE**

190	1	396-HP-BLADE

Lames de rechange pour scies 4211,4212,339,340 et échenilloirs P34-37



### 4400-/4420-

Length	Quantity	Model
280	10	4400-11
360	10	4400-14
280	10	4420-11
360	10	4420-14
280	10	4400-11-BULK
360	10	4400-14-BULK
280	10	4420-11-BULK
360	10	4420-14-BULK

## PIÈCES DÉTACHÉES ET ACCESSOIRES

Lame de rechange courbée pour scies sur perches, coupe fine



### AS-F-BLADE

Length	Quantity	Model
330	7	AS-C33-JT-F

Lame de rechange courbée pour scies sur perches, coupe moyenne



### AS-M-BLADE

Length	Quantity	Model
360	6,2	AS-C36-JT-M

Lame de rechange courbée pour scies sur perches, grosse coupe



### AS-C-C-BLADE

Length	Quantity	Model
390	5,4	AS-C39-JT-C
450	5,4	AS-C45-JT-C

Sac de transport pour perche



### 4750-PSTB-1

Length	Weight	Quantity	Model
1910 mm	1040 g	1	4750-PSTB-1

## ACCESSOIRES ET MAINTENANCE

Pierre d'affûtage synthétique, 2 grains 180/400



### LS-COMBISS

Length	Quantity	Model
100	1	LS-COMBISS

Pierre d'affûtage naturelle



### LS-NATURAL

Length	Quantity	Model
70	1	LS-NATURAL

Pierre d'affûtage synthétique, grain 220



### LS-TRIANGLE

Length	Quantity	Model
100	1	LS-TRIANGLE

Pierre d'affûtage synthétique, grain 320



### LS-CORINDON

Length	Quantity	Model
100	1	LS-PIERRE CORINDON

Affûteur, lame carbure



### SHARP-X

Length	Quantity	Model
100	10	SHARP-X
100	1	SHARP-X-DISP



Pierre d'affûtage synthétique, grain 180



**LS-PIERRE-FAUX**



230



1 LS-PIERRE-FAUX

Etui cuir pour sécateurs



**PROF-H**



86



2 PROF-H

Pierre d'affûtage synthétique "Carbor", grain 220



**LS-6160-23**



230



1 LS-6160-23

Etui pour ébrancheur



**PROF-LOPP**



390



1 PROF-LOPP

Huile d'entretien 50ml



**LUB-2015**



60



6 LUB-2015

Etui pour sécateur



**PROF-SEC**



150



1 PROF-SEC





## Outils pneumatiques pour l'extérieur



## SÉCATEURS

Sécateur pneumatique



**9210**



Lame pour 9210



**9210-1**

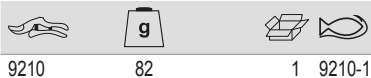

Tête de coupe pour 9210



**9210-10**



Kit de joints pour 9210



**9210-20**



Manchons cuivre pour 9210



**9210-1720100**



Kit de joints pour 9210



**9210-1230235**



Piston pour 9210



**9210-1690148**



Amortisseurs pour 9210



**9210-1730107**



Ressorts pour 9210



**9210-1640142**



Tige de connexion pour 9210



**9210-1700118**



Rivet pour 9210



**9210-1770106**



Caches protège-poussière pour 9210



**9210-1230219**



9210 8.6 20 9210-1230219

Coque sécateur pour 9210



**9210-1710266**



9210 193 1 9210-1710266

Set de vis pour 9210



**9210-1060238**



9210 10 20 9210-1060238

Set de vis pour 9210



**9210-1060177**



9210 7 1 9210-1060177

Cache frontal pour 9210



**9210-1830137**



9210 9.5 1 9210-1830137

Pièce de rechange poignées 9210



**9210-1320281**



9210 35 10 9210-1320281





**BAHCO**



## Outils de précision Lindström





## PINCES POUR L'ÉLECTRONIQUE ET LA MÉCANIQUE DE PRÉCISION

Pince coupante diagonale, Tête pointue et effilée







**7190, 7191**

				
0.2-1.0	Micro		10	7190
0.2-1.0	Micro		10	7190 CO
0.1-1.0	Flush		10	7191
0.1-1.0	Flush		10	7191 CO

Pince coupante diagonale, Tête pointue



**8143-8165**

				
0.2-1.25	Micro		10	8143
0.2-1.25	Flush		10	8144
0.2-1.25	Flush		10	8144 CO
0.1-1.0	Ultra		10	8145
0.3-1.6	Micro		10	8153
0.2-1.6	Flush		10	8154
0.2-1.6	Flush		10	8154 CO
0.2-1.25	Ultra		10	8155
0.4-2.0	Micro		10	8163
0.4-2.0	Micro		10	8163 CO
0.3-2.0	Flush		10	8164
0.3-1.6	Ultra		10	8165
0.3-1.6	Ultra		10	8165 CO

Pince coupante diagonale,

ergo®







**P6160**

				
1.5		Flush	10	P6160

Pince coupante diagonale, Tête ovale







**8130-8162**

				
0.2-1.0	Micro		10	8130
0.1-1.0	Flush		10	8131
0.1-1.0	Flush		10	8131 CO
0.1-0.8	Ultra		10	8132
0.2-1.25	Micro		10	8140
0.2-1.25	Micro		10	8140 CO
0.1-1.25	Flush		10	8141
0.1-1.25	Flush		10	8141 CO
0.1-1.0	Ultra		10	8142
0.1-1.0	Ultra		10	8142 CO
0.3-1.6	Micro		10	8150
0.3-1.6	Micro		10	8150 CO
Max 0.5	Micro		10	8150 J
0.2-1.6	Flush		10	8151
0.2-1.6	Flush		10	8151 CO
0.1-1.25	Ultra		10	8152
0.4-2.0	Micro		10	8160
0.4-2.0	Micro		10	8160 CO
Max 0.5	Micro		10	8160 J
0.3-2.0	Flush		10	8161
0.3-2.0	Flush		10	8161 CO
0.3-1.6	Ultra		10	8162

Pince coupante diagonale, Tête pointue et effilée



**8146-8158**





				
0.2-1.0	Micro		10	8146
0.1-1.0	Flush		10	8147
0.1-0.8	Ultra		10	8148
0.1-0.8	Ultra		10	8148 CO
0.3-1.25	Micro		10	8156
0.2-1.25	Flush		10	8157
0.2-1.0	Ultra		10	8158

Pince coupante diagonale, Tête pointue

ergo®



**RX 8143-RX 8145**





				
0.2-1.25	Micro		10	RX 8143
0.1-1.25	Flush		10	RX 8144
0.1-1.0	Ultra		10	RX 8145

Pince coupante diagonale, Tête pointue et effilée

ergo®



**RX 8146-RX 8148**

				
0.2-1.0	Micro		10	RX 8146
0.1-1.0	Flush		10	RX 8147
0.1-0.8	Ultra		10	RX 8148

Pince coupante diagonale, coupante en bout

ergo®



**RX 8149**

0.1-0.6	Flush	10	RX 8149

Pince coupante diagonale, Tête ovale

ergo®



**RX 8130-RX 8162**

0.2-1.0	Micro	10	RX 8130
0.1-1.0	Flush	10	RX 8131
0.1-0.8	Ultra	10	RX 8132
0.2-1.25	Micro	10	RX 8140
0.1-1.25	Flush	10	RX 8141
0.1-1.0	Ultra	10	RX 8142
0.3-1.6	Micro	10	RX 8150
0.2-1.6	Flush	10	RX 8151
0.2-1.25	Ultra	10	RX 8152
0.4-2.0	Micro	10	RX 8160
0.3-2.0	Flush	10	RX 8161
0.3-1.6	Ultra	10	RX 8162

Pince coupante oblique, à angle inversé



**7280**

0.2-08	Flush	10	7280

Pince coupante oblique 45°, Miniature



**7285**

0.2-1.0	Flush	10	7285

Pince coupante oblique 20°, Tête courte



**8211**

0.2-1.2	Flush	10	8211

Pince coupante oblique 45°, Tête longue



**8247**

0.2-1.0	Flush	10	8247
0.2-1.0	Flush	10	8247 CO

Pince coupante oblique 45°, Tête longue, effilée



**8248**

0.2-0.8	Flush	10	8248
0.2-0.8	Flush	10	8248 CO

Pince coupante oblique 20°, Tête courte

ergo®



**RX 8211**

0.2-1.2	Flush	10	RX 8211

Pince coupante oblique 45°, Tête longue

ergo®



**RX 8247**

0.2-1.0	Flush	10	RX 8247

Pince coupante oblique 45°, Tête longue effilée

ergo®



**RX 8248**

0.2-0.8	Flush	10	RX 8248



Pince coupante oblique, serie Supreme



**7290.7291**

0.35-1.25	Micro		10	7290
0.35-1.25	Flush		10	7291

Pince coupante oblique



**7293**

0.35-1.0	Flush		10 7293

Pince à becs plats



**7490**

20		10 7490
20		10 7490 CO

Pince de préhension à becs plats

ergo®



**RX 7490**

20		10 RX 7490

Pince à becs ronds



**7590**

20		1 7590
20		10 7590 CO

Pince de préhension à becs ronds

ergo®



**RX 7590**

20		10 RX 7590

Pince à bec demi-rond/7890, 7891



**7890, 7891**

32.5		10 7890
32.5		10 7890 CO
32.5		10 7891
32.5		10 7891 CO

Pince à becs longs demi-ronds



**7892**

20		10 7892

Pince universelle courte



**7893**

20		10 7893

Pince de préhension à becs demi-ronds  
RX7890 mâchoires lisses, RX7891 mâchoires  
denteelées

ergo®



**RX 7890, RX 7891**

32		10 RX 7890
32		10 RX 7891



Pince de préhension à becs demi-ronds courbés

ergo®



**RX 7892**



29



10 RX 7892

Pince coupante à bout miniature



**7292**



0.35 - 0.8



Flush



10 7292

Ressort de rappel pour série RX



**RX 01**



5



1 RX 01

Pince de préhension à becs demi-ronds courts

ergo®



**RX 7893**



20



10 RX 7893

Pince Kevlar multi-usage



**HS6000**



2.0



Flush



10 HS6000

**BRUCELLES POUR L'ÉLECTRONIQUE ET LA MÉCANIQUE DE PRÉCISION**

Pince Bruxelles - Style BOLEY



**TL 00-SA-ET**



120



1 TL 00-SA-ET

Pince coupante diagonale  
Fils d'acier dur et matériaux doux



**TRX 8180**



4.5



2.5



5 TRX 8180

Retenues de fil



**813/814**



8130-8132, Rx 8130-8132



1 813

Pince Bruxelles



**TL 3-SA-ET**



120



1 TL 3-SA-ET



Brucelle haute précision  
Bords plats, pointes solides, striées



**TL 00B-SA**

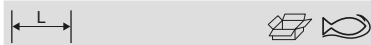

120 1 TL 00B-SA

Acier inoxydable, antimagnétique, antiacide

Brucelle haute précision  
Bords plats, pointes fines



**TL 0-SA**

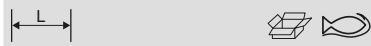

120 1 TL 0-SA

Acier inoxydable, antimagnétique, antiacide

Brucelle haute précision  
Pointed plates courbées et arrondies



**TL 2AB-SA**



120 1 TL 2AB-SA

Acier inoxydable, antimagnétique, antiacide

Brucelle haute précision  
Bords plats, pointes solides, striées



**TL 00D-SA**



120 1 TL 00D-SA

Acier inoxydable, antimagnétique, antiacide

Brucelle haute précision  
Pointes fines, striées



**TL 10G-SA**

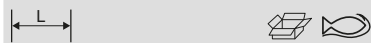

110 1 TL 10G-SA

Acier inoxydable, antimagnétique, antiacide

Brucelle haute précision  
Pointes épaissies et arrondies



**TL 2A-SA**



120 1 TL 2A-SA

Acier inoxydable, antimagnétique, antiacide

Brucelle haute précision  
Bords plats, pointes épaissies



**TL 00-SA**



120 1 TL 00-SA

Acier inoxydable, antimagnétique, antiacide

Brucelle haute précision  
Pour les fils souple de 0,1 à 0,25mm



**TL 15AP**



115 1 TL 15AP

Acier carbone

Brucelle haute précision  
Pointes épaissies et affûtée



**TL 2-SA**



120 1 TL 2-SA

Acier inoxydable, antimagnétique, antiacide

Brucelle haute précision  
Bords plats, pointes fines



**TL 0C9-SA**



90 1 TL 0C9-SA

Acier inoxydable, antimagnétique, antiacide

Brucelle haute précision  
Pointes précises et épaissies



**TL 1-SA**

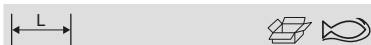

120 1 TL 1-SA

Acier inoxydable, antimagnétique, antiacide

Brucelle haute précision  
Dents très effilées



**TL 3C-SA**



110 1 TL 3C-SA

Acier inoxydable, antimagnétique, antiacide

Brucelle haute précision  
Dents très effilées



**TL 3C-TA**



Titane, antimagnétique, antiacide  
Extra-légère

Brucelle haute précision  
Pointes très effilées, légèrement courbées



**TL 5A-SA**



Acier inoxydable, antimagnétique, antiacide

Brucelle haute précision  
Longues pointes légèrement courbées



**TL 65A-SA**



Acier inoxydable, antimagnétique, antiacide

Brucelle haute précision  
Très effilées



**TL 3-SA**



Acier inoxydable, antimagnétique, antiacide

Brucelle haute précision  
Pointes très effilées



**TL 5B-SA**



Acier inoxydable, antimagnétique, antiacide

Brucelle haute précision  
Pointes fines et solides, légèrement courbées



**TL 7A-SA**



Acier inoxydable, antimagnétique, antiacide

Brucelle haute précision  
Pointes extra-fines et effilées



**TL 4-SA**



Acier inoxydable, antimagnétique, antiacide

Brucelle haute précision  
Pointes coniques très effilées



**TL 5-SA**



Acier inoxydable, antimagnétique, antiacide

Brucelle haute précision  
Pointes fines et légèrement courbées



**TL 7-SA**



Acier inoxydable, antimagnétique, antiacide

Brucelle haute précision  
Extra-fine, pointes courbées



**TL 51S-SA**



Acier inoxydable, antimagnétique, antiacide

Pince Brucelles haute précision



**TL 5-TA**



Acier inoxydable, antimagnétique, antiacide

Brucelle haute précision  
Pointes longues et fines



**TL SS-SA**



Acier inoxydable, antimagnétique, antiacide



Brucelle Multi-usage à action inversée  
Style 2A



**TL 2AX-SA**



120

1 TL 2AX-SA

Acier inoxydable, antimagnétique, antiacide

Brucelle - usage industriel  
Acier inoxydable, antimagnétique, antiacide



**TL 2-SA-SL**



120

5 TL 2-SA-SL

Brucelle - usage industriel  
Acier inoxydable, antimagnétique, antiacide



**TL 5A-SA-SL**



115

5 TL 5A-SA-SL

Brucelle - usage industriel  
Acier inoxydable - antimagnétique, antiacide



**TL 00-SA-SL**



120

5 TL 00-SA-SL

Brucelle - usage industriel  
Acier inoxydable, antimagnétique, antiacide



**TL 3C-SA-SL**



110

5 TL 3C-SA-SL

Brucelle - usage industriel  
Acier inoxydable, antimagnétique, antiacide



**TL 5-SA-SL**



110

5 TL 5-SA-SL

Brucelle, usage industriel  
Acier inoxydable, antimagnétique, antiacide



**TL 1-SA-SL**



120

5 TL 1-SA-SL

Brucelle - usage industriel  
Acier inoxydable, antimagnétique, antiacide



**TL 3-SA-SL**



120

5 TL 3-SA-SL

Brucelle - usage industriel  
Acier inoxydable, antimagnétique, antiacide



**TL 7A-SA-SL**



115

5 TL 7A-SA-SL

Brucelle - usage industriel  
Acier inoxydable, antimagnétique, antiacide



**TL 2A-SA-SL**



120

5 TL 2A-SA-SL

Brucelle - usage industriel  
Acier inoxydable, antimagnétique, antiacide



**TL 4-SA-SL**



110

5 TL 4-SA-SL

Brucelle - usage industriel  
Acier inoxydable, antimagnétique, antiacide



**TL 7-SA-SL**



115

5 TL 7-SA-SL

Brucelle pour usage industriel  
Acier inoxydable, anti-magnétique, anti-acide



**TL AC-SA-SL**



AC-SA 110 mm 5 TL AC-SA-SL

Brucelle multiusage  
Becs striés, arrondis et résistants



**TL 124-SA**



150 1 TL 124-SA

Acier inoxydable, antimagnétique, antiacide

Brucelle multiusage  
Becs fins et striés



**TL 231-SA**

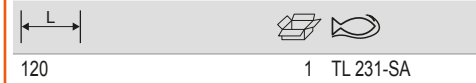

120 1 TL 231-SA

Acier inoxydable, antimagnétique, antiacide

Brucelle, usage industriel  
Acier inoxydable, antimagnétique, antiacide



**TL SS-SA-SL**



140 5 TL SS-SA-SL

Brucelle à usage multiple  
Becs striés, arrondis et résistants



**TL 475-SA**



140 1 TL 475-SA

Acier inoxydable, antimagnétique, antiacide

Brucelle - Pointe de grande précision  
Pointes droites et striées pour composants Ø2.0mm



**TL 577-SA**



115 1 TL 577-SA

Acier inoxydable, antimagnétique, antiacide

Brucelle - usage industriel  
Acier inoxydable, antimagnétique, antiacide



**TL AA-SA-SL**



130 5 TL AA-SA-SL

Brucelle multiusage  
Becs striés avec guide



**TL 648-SA**



150 1 TL 648-SA

Acier inoxydable, antimagnétique, antiacide

Brucelle - Pointe haute précision  
Pointes angle 90° pour composants Ø2.0mm avec becs striés



**TL 578-SA**



115 1 TL 578-SA

Acier inoxydable, antimagnétique, antiacide

Brucelle - usage industriel  
Acier inoxydable, antimagnétique, antiacide



**TL MM-SA-SL**



130 5 TL MM-SA-SL

Brucelle multiusage  
Becs fins striés avec guide



**TL 649-SA**



150 1 TL 649-SA

Acier inoxydable, antimagnétique, antiacide

Brucelle - Maniement des composants  
Pointes angle 90°, pour composants Ø1.0mm avec becs striés



**TL 582-SA**



115 1 TL 582-SA

Acier inoxydable, antimagnétique, antiacide



Brucelle - Style BOLEY  
Pointes fines et solides



**TL AA-S**



130

1 TL AA-S

Acier inoxydable

Brucelle - Pointes en fibre de carbone  
Bord plat et pointes épaisses



**TL 00CFR-SA**



130

1 TL 00CFR-SA

Cors en acier et pointe en fibre de carbone

Brucelle pointes fibre de carbone  
Pointes 3mm, style 2A



**TL 269CF-SA**



130

1 TL 269CF-SA

Corps en acier inoxydable et pointes en fibre de c

Brucelles - Style BOLEY  
Pointes fines et solides



**TL AA-SA**



130

1 TL AA-SA

Acier inoxydable, antimagnétique, antiacide

Brucelle - Pointes en fibre de carbone  
Pointes arrondies



**TL 2ACFR-SA**



130

1 TL 2ACFR-SA

Corps en acier et pointes en fibre de carbone

Embouts de rechange à bord plat et pointes épaisses



**TL 249ACF**



40

1 TL 249 ACF

Brucelle pointes fibre de carbone  
Bord plat et pointes épaisses



**TL 249CFR-SA**



130

1 TL 249CFR-SA

Corps en acier inoxydable et pointe carbone

Brucelle - Pointes en fibre de carbone  
Pointes extra-fines



**TL 5CFR-SA**



130

1 TL 5CFR-SA

Corps en acier et pointe en fibre de carbone

Jeu d'embouts de rechange extra-fins



**TL 259ACF**



40

1 TL 259 ACF

Brucelle pointes fibre de carbone  
Pointes spéciales extra-fines



**TL 259CFR-SA**



130

1 TL 259 CFR-SA

Corps en acier inoxydable et pointes carbone

Brucelle - Pointes en fibre de carbone  
Pointes fines coudées



**TL 7CFR-SA**



130

1 TL 7CFR-SA

Corps en acier et pointes en fibre de carbone

Embouts de rechange



**TL 2AACF**



40

1 TL 2AACF

Embouts de rechange



**TL 5ACF**



40 1 TL 5ACF

Brucelle - CMS



**TL SM105-SA**



120 1 TL SM 105-SA

Acier inoxydable, antimagnétique, antiacide

Brucelles CMS



**TL SM110-SA**



120 1 TL SM 110-SA

Acier inoxydable, antimagnétique, antiacide

Pointe fine coudée, interchangeable



**TL 7ACF**



130 1 TL 7ACF

Brucelle - CMS



**TL SM107-SA**



120 1 TL SM 107-SA

Acier inoxydable, antimagnétique, antiacide

Brucelles CMS



**TL SM111-SA**



120 1 TL SM 111-SA

Acier inoxydable, antimagnétique, antiacide

Brucelle - CMS



**TL SM103-SA**



115 1 TL SM 103-SA

Acier inoxydable, antimagnétique, antiacide

Brucelle - CMS



**TL SM108-SA**



120 1 TL SM 108-SA

Acier inoxydable, antimagnétique, antiacide

Brucelle



**TL SM115-SA**



120 1 TL SM 115-SA

Acier inoxydable, antimagnétique, antiacide

Brucelle - CMS



**TL SM104-SA**



120 1 TL SM 104-SA

Acier inoxydable, antimagnétique, antiacide

Brucelle - CMS



**TL SM109-SA**



120 1 TL SM 109-SA

Acier inoxydable, anti-magnétique, anti-acide

Brucelle - CMS



**TL SM117-SA**



120 1 TL SM 117-SA

Acier inoxydable, antimagnétique, antiacide



Jeu de pinces Brucelles, pour composants CMS



**9854**

20 x 200 x 180 mm	1	9854
20 x 200 x 180 mm	1	9854W

TL 5C-SA	
TL 5-SA-SL	
TL SM 107-SA	
TL SM 108-SA	
TL SM 115-SA	
9854W	

Jeu de pinces Brucelles, Titane



**9856**

10 x 200 x 110 mm	1	9856

TL 3C-TA	
TL 3-TA	
TL 5-TA	
TL AA-TA	

Jeu de pinces brucelles, Pointes fines



**9858**

8 x 200 x 65 mm	1	9858
8 x 200 x 65 mm	1	9858W

9858W	
TL AA-SA-SL	
TL SS-SA-SL	

Jeu de pinces Brucelles



**9855**

10 x 200 x 110 mm	1	9855
10 x 200 x 110 mm	1	9855W

9855W	
TL SS-SA-SL	
TL AA-SA-SL	
TL 2A-SA-SL	
TL 7A-SA-SL	
TL 4-SA-SL	

Jeu de pinces Brucelles  
5 pièces



**9857**

10 x 200 x 110 mm	1	9857

TL 00-SA-SL	
TL 1-SA-SL	
TL 5-SA-SL	
TL 7-SA-SL	
TL 3C-SA-SL	
9855W	

Jeu de pinces brucelles, Pointes robustes



**9859**

8 x 200 x 65 mm	1	9859

9858W	
TL 00B-SA	
TL 2A-SA-SL	



## TOURNEVIS DYNAMOMÉTRIQUES

Tournevis dynamométrique réglable avec échelle et fenêtre de visualisation - Antistatique



### MA500-1 - MA500-3



16-80 cNm Nm	1	MA500-1A
40-200 cNm Nm	1	MA500-2A
90-450 cNm Nm	1	MA500-3A

Tournevis dynamométrique pré-réglé avec échelle et fenêtre de visualisation - Antistatique



### PS501



4-22 c	1	PS501-1
7-70 c	1	PS501-2
15-170 c	1	PS501-3
45-450 c	1	PS501-4





**BAHCO**



1-100-04-1-0	7311518019006	10	24
1-100-04-1-2	7311518244125	5	24
1-100-04-2-0	7311518019013	10	24
1-100-04-2-2	7311518244132	5	24
1-100-04-3-0	7311518019020	10	24
1-100-06-1-0	7311518019037	10	24
1-100-06-1-2	7311518000233	5	24
1-100-06-2-0	7311518019044	10	24
1-100-06-2-2	7311518003593	5	24
1-100-06-3-0	7311518019051	10	24
1-100-06-3-2	7311518293581	5	24
1-100-08-1-0	7311518019068	10	24
1-100-08-1-2	7311518000264	5	24
1-100-08-2-0	7311518019075	10	24
1-100-08-2-2	7311518003609	5	24
1-100-08-3-0	7311518019082	10	24
1-100-08-3-2	7311518295585	5	24
1-100-10-1-0	7311518019099	10	24
1-100-10-1-2	7311518000295	5	24
1-100-10-2-0	7311518019105	10	24
1-100-10-2-2	7311518003616	5	24
1-100-10-3-0	7311518019112	10	24
1-100-10-3-2	7311518295592	5	24
1-100-12-1-0	7311518019129	5	24
1-100-12-1-2	7311518028053	5	24
1-100-12-2-0	7311518019136	5	24
1-100-12-2-2	7311518244118	5	24
1-100-12-3-0	7311518019143	5	24
1-100-12-3-2	7311518295608	5	24
1-100-14-1-0	7311518019150	5	24
1-100-14-2-0	7311518019167	5	24
1-102-06-2-0	7311518019198	10	24
1-102-06-3-0	7311518019204	10	24
1-102-08-1-0	7311518019211	10	24
1-102-08-2-0	7311518019228	10	24
1-102-08-3-0	7311518019235	10	24
1-104-10-2-0	7311518019242	10	24
1-104-10-3-0	7311518019259	10	24
1-104-12-2-0	7311518019266	5	24
1-104-12-3-0	7311518019273	5	24
1-104-14-3-0	7311518019297	5	24
1-106-08-1-0	7311518019303	10	24
1-106-08-1-2	7311518000301	5	24
1-106-10-1-0	7311518019310	10	24
1-106-10-1-2	7311518000325	5	24
1-106-12-1-0	7311518019327	5	24
1-106-12-1-2	7311518295615	5	24
1-110-04-1-0	7311518019334	10	24
1-110-04-2-0	7311518019341	10	24
1-110-04-3-0	7311518044046	10	24
1-110-06-1-0	7311518019358	10	24
1-110-06-1-2	7311518295622	5	24
1-110-06-2-0	7311518019365	10	24
1-110-06-2-2	7311518003623	5	24
1-110-06-3-0	7311518019372	10	24
1-110-06-3-2	7311518295639	5	24
1-110-08-1-0	7311518019389	10	24
1-110-08-1-2	7311518000332	5	24
1-110-08-2-0	7311518019396	10	24
1-110-08-2-2	7311518003630	5	24
1-110-08-3-0	7311518019402	10	24
1-110-08-3-2	7311518295646	5	24
1-110-10-1-0	7311518019419	10	24
1-110-10-1-2	7311518000349	5	24
1-110-10-2-0	7311518019426	10	24
1-110-10-2-2	7311518003647	5	24
1-110-10-3-0	7311518019433	10	24
1-110-10-3-2	7311518295653	5	24
1-110-12-1-0	7311518019440	5	24
1-110-12-1-2	7311518295660	5	24
1-110-12-2-0	7311518019457	5	24
1-110-12-2-2	7311518295677	5	24
1-110-12-3-0	7311518019464	5	24
1-110-12-3-2	7311518295684	5	24
1-110-14-1-0	7311518019488	5	24
1-111-04-1-0	7311518044053	10	25
1-111-04-2-0	7311518019518	10	25
1-111-04-3-0	7311518019525	10	25
1-111-06-1-0	7311518019549	10	25
1-111-06-2-0	7311518019556	10	25
1-111-06-2-2	7311518000363	5	25
1-111-06-3-0	7311518019563	10	25
1-111-08-1-0	7311518019570	10	25
1-111-08-2-0	7311518019587	10	25
1-115-11-3-1	7311518003791	10	25
1-143-04-1-0	7311518105983	10	25
1-143-06-1-0	7311518019631	10	25
1-143-06-1-2	7311518022341	5	25
1-143-08-1-0	7311518019662	10	25
1-143-08-1-2	7311518028077	5	25
1-143-10-1-0	7311518019693	10	25
1-143-10-1-2	7311518022358	5	25
1-143-12-1-0	7311518019723	5	25
1-143-12-1-2	7311518295691	5	25
1-160-04-1-0	7311518019785	10	26
1-160-04-1-2	7311518244057	5	26



1-160-04-2-0	7311518019792	10	26
1-160-04-2-2	7311518244095	5	26
1-160-04-3-0	7311518019808	10	26
1-160-06-1-0	7311518019815	10	26
1-160-06-1-2	7311518000370	5	26
1-160-06-2-0	7311518019822	10	26
1-160-06-2-2	7311518003685	5	26
1-160-06-3-0	7311518019839	10	26
1-160-06-3-2	7311518295707	5	26
1-160-08-1-0	7311518019846	10	26
1-160-08-1-2	7311518000394	5	26
1-160-08-2-0	7311518019853	10	26
1-160-08-2-2	7311518003692	5	26
1-160-08-3-0	7311518019860	10	26
1-160-08-3-2	7311518295714	5	26
1-160-10-1-0	7311518019877	10	26
1-160-10-1-2	7311518000400	5	26
1-160-10-2-0	7311518019884	10	26
1-160-10-2-2	7311518295721	5	26
1-160-10-3-0	7311518019891	10	26
1-160-10-3-2	7311518295738	5	26
1-160-12-1-0	7311518019907	5	26
1-160-12-1-2	7311518295745	5	26
1-160-12-2-0	7311518019914	5	26
1-160-12-2-2	7311518295752	5	26
1-160-12-3-0	7314150292059	5	26
1-160-12-3-2	7311518298005	5	26
1-170-04-1-0	7311518044060	10	26
1-170-04-2-0	7311518019945	10	26
1-170-04-2-2	7311518244088	5	26
1-170-04-3-0	7311518019952	10	26
1-170-06-1-0	7311518019969	10	26
1-170-06-1-2	7311518244071	5	26
1-170-06-2-0	7311518019976	10	26
1-170-06-2-2	7311518003715	5	26
1-170-06-3-0	7311518019983	10	26
1-170-06-3-2	7311518295769	5	26
1-170-08-1-0	7311518019990	10	26
1-170-08-1-2	7311518000417	5	26
1-170-08-2-0	7311518020002	10	26
1-170-08-2-2	7311518003722	5	26
1-170-08-3-0	7311518020019	10	26
1-170-08-3-2	7311518295783	5	26
1-170-10-1-0	7311518020026	10	26
1-170-10-1-2	7311518028107	5	26
1-170-10-2-0	7311518020033	10	26
1-170-10-2-2	7311518244064	5	26
1-170-10-3-0	7311518020040	10	26
1-170-10-3-2	7311518295806	5	26
1-170-12-1-0	7311518020057	5	26
1-170-12-2-0	7311518020064	5	26
1-210-04-1-0	7311518020071	10	26
1-210-04-1-2	7311518243944	5	25
1-210-04-2-0	7311518020088	5	25
1-210-04-2-2	7311518244040	5	25
1-210-04-3-0	7311518020095	10	25
1-210-06-1-0	7311518020101	10	25
1-210-06-1-2	7311518000424	5	25
1-210-06-2-0	7311518020118	10	25
1-210-06-2-2	7311518003654	5	25
1-210-06-3-0	7311518020125	10	25
1-210-06-3-2	7311518293574	5	25
1-210-08-1-0	7311518020132	10	25
1-210-08-1-2	7311518000455	5	25
1-210-08-2-0	7311518020149	10	25
1-210-08-2-2	7311518000479	5	25
1-210-08-3-0	7311518020156	10	25
1-210-08-3-2	7311518295837	5	25
1-210-10-1-0	7311518020163	10	25
1-210-10-1-2	7311518000493	5	26
1-210-10-2-0	7311518020170	10	25
1-210-10-2-2	7311518003661	5	26
1-210-10-3-0	7311518020187	10	25
1-210-10-3-2	7311518295844	5	26
1-210-12-1-0	7311518020194	5	25
1-210-12-1-2	7311518028121	5	25
1-210-12-2-0	7311518020200	5	25
1-210-12-2-2	7311518244149	5	26
1-210-12-3-0	7311518020217	5	25
1-210-12-3-2	7311518295851	5	26
1-210-14-1-0	7311518020224	5	25
1-230-04-1-0	7311518020248	10	26
1-230-04-1-2	7311518244163	5	26
1-230-04-2-0	7311518020255	10	26
1-230-04-2-2	7311518244156	5	26
1-230-04-3-0	7311518020262	10	26
1-230-06-1-0	7311518020279	10	26
1-230-06-1-2	7311518000509	5	26
1-230-06-2-0	7311518020286	10	26
1-230-06-2-2	7311518000523	5	26
1-230-06-3-0	7311518020293	10	26
1-230-06-3-2	7311518293567	5	26
1-230-08-1-0	7311518020309	10	26
1-230-08-1-2	7311518000547	5	26
1-230-08-2-0	7311518020316	10	26
1-230-08-2-2	7311518000554	5	26





1-230-08-3-0	7311518020323	10	26
1-230-08-3-2	7311518295882	5	26
1-230-10-1-0	7311518020330	10	26
1-230-10-1-2	7311518000578	5	26
1-230-10-2-0	7311518020347	10	26
1-230-10-2-2	7311518003678	5	26
1-230-10-3-0	7311518020354	10	26
1-230-10-3-2	7311518295899	5	26
1-230-12-1-0	7311518020361	5	26
1-230-12-1-2	7311518295912	5	26
1-230-12-2-0	7311518020378	5	26
1-230-12-2-2	7311518295929	5	26
1-230-12-3-0	7311518020385	5	26
1-230-12-3-2	7311518295905	5	26
1-320-08-2-0	7311518191276	10	25
1-320-08-2-2	7311518270865	5	25
1-320-10-2-0	7311518020477	10	25
1-320-10-2-2	7311518270872	5	25
1-320-12-2-0	7311518020484	5	25
1-320-12-2-2	7311518270889	5	25
1-473-06-2-2	7311518201098	5	27
1-473-08-2-2	7311518201104	5	27
1-473-10-2-2	7311518201111	5	27
1-476-04-3-2	7311518010928	1	27
1-477-08-2-2	7311518037994	5	27
1-477-10-2-2	7311518201074	5	27
1-478-08-1-2	7311518141127	5	27
1-478-10-1-2	7311518241995	5	27
1-479-08-1-2	7311518176747	5	28
1-479-08-2-2	7311518180607	5	28
10-21-51	7311518229344	5	626
10-24-23	7311518229368	5	626
10-24-51	7311518229351	5	626
10-30-23	7311518229382	5	626
10-30-51	7311518229375	5	626
1016	7314150218189	10	211
1019	8412814010199	10	210
1031-10	7314150025442	5	567
1031-12	7314150025459	5	567
1031-14	7314150025466	5	567
1031-16	7314150025473	5	567
1031-18	7314150025480	5	567
1031-20	7314150025497	5	567
1031-22	7314150025503	5	567
1031-25	7314150025510	5	567
1031-28	7314150025527	5	567
1031-30	7314150025534	5	567
1031-32	7314150025541	5	567
1031-4	7314150025411	5	567
1031-40	7314150025558	5	567
1031-6	7314150025428	5	567
1031-8	7314150025435	5	567
1067	8412814010670	10	210
1084	7311518277291	5	262
10RM-10	7314153014351	1	48
10RM-13	7314153014368	1	48
10RM-14	7314150221677	1	48
10RM-17	7314153014375	1	48
10RM-19	7314153014382	1	48
10RM-8	7314153014344	1	48
10RM/SH6	7314150222971	1	49
10RZ-1/2	7314150358786	1	48
10RZ-11/16	7314150358816	1	48
10RZ-3/4	7314150358823	1	48
10RZ-3/8	7314150358762	1	48
10RZ-5/16	7314150358748	1	48
10RZ-5/8	7314150358809	1	48
10RZ-7/16	7314150358779	1	48
10RZ-9/16	7314150358793	1	48
111M-10	7314151828653	10	42
111M-100	7314150401499	1	42
111M-11	7314151828660	10	42
111M-12	7314151828677	10	42
111M-13	7314151828684	10	42
111M-14	7314151828691	10	42
111M-15	7314151828707	10	42
111M-16	7314151828714	10	42
111M-17	7314151828721	10	42
111M-18	7314151828738	10	42
111M-19	7314151828745	10	42
111M-20	7314151828752	10	42
111M-21	7314151828769	10	42
111M-22	7314151828776	5	42
111M-23	7314151828783	5	42
111M-24	7314151828790	5	42
111M-25	7314151828806	5	42
111M-26	7314151828813	5	42
111M-27	7314151828820	5	42
111M-28	7314151828837	5	42
111M-29	7314151828844	5	42
111M-30	7314151828851	5	42
111M-32	7314151828868	5	42
111M-33	7314150222223	5	42
111M-34	7314151828875	5	42
111M-36	7314150135516	1	42
111M-38	7314150222230	1	42



111M-41	7314150135523	1	42
111M-46	7314150135530	1	42
111M-50	7314151828608	10	42
111M-55	7314150135547	1	42
111M-55	7314150135554	1	42
111M-6	7314151828615	10	42
111M-60	7314150135561	1	42
111M-65	7314150135578	1	42
111M-7	7314151828622	10	42
111M-70	7314150135585	1	42
111M-75	7314150135592	1	42
111M-8	7314151828639	10	42
111M-80	7314150135608	1	42
111M-85	7314150352999	1	42
111M-9	7314151828646	10	42
111M-90	7314150401475	1	42
111M-95	7314150401482	1	42
111M/11T	7314151828899	1	43
111M/14T	7314151828905	1	44
111M/17T	7314151828912	1	44
111M/17TL	7314150197859	1	44
111M/24T	7314150197866	1	44
111M/26T	7314151828929	1	44
111M/S10	7314150212965	1	43
111M/SH12	7314153013347	1	43
111M/SH5	7314150325252	1	43
111M/SH8	7314150197873	1	43
111Z-1	7314151829063	3	42
111Z-1.1/16	7314151829070	5	42
111Z-1.1/2	7314150135752	1	42
111Z-1.1/4	7314151829094	5	42
111Z-1.1/8	7314151829087	5	42
111Z-1.11/16	7314150135615	1	42
111Z-1.13/16	7314150135639	1	42
111Z-1.3/4	7314150135622	1	42
111Z-1.3/8	7314150135738	1	42
111Z-1.5/16	7314151829100	5	42
111Z-1.5/8	7314150135769	1	42
111Z-1.7/16	7314150135745	1	42
111Z-1.7/8	7314150135646	1	42
111Z-1/2	7314151828981	5	42
111Z-1/4	7314151828943	5	42
111Z-11/16	7314151829018	5	42
111Z-13/16	7314151829032	5	42
111Z-15/16	7314151829056	3	42
111Z-2	7314150135653	1	42
111Z-2.1/2	7314150135721	1	42
111Z-2.1/4	7314150135691	1	42
111Z-2.1/8	7314150135677	1	42
111Z-2.3/4	7314150135783	1	42
111Z-2.3/8	7314150135707	1	42
111Z-2.5/8	7314150135776	1	42
111Z-2.7/8	7314150135790	1	42
111Z-3	7314150135806	1	42
111Z-3/4	7314151829025	5	42
111Z-3/8	7314151828967	5	42
111Z-5/16	7314151828950	5	42
111Z-5/8	7314151829001	5	42
111Z-7/16	7314151828974	5	42
111Z-7/8	7314151829049	5	42
111Z-9/16	7314151828998	5	42
111Z/11T	7314151829124	1	44
111Z/8T	7314151829117	1	44
1150-1/2H/P	7314150129263	1	543
1150D	7311518276614	1	542
1154	7314150249831	1	316
1154-DG	7314150249800	1	316
1154-MB	7314150249817	1	316
1157	7311518277031	60	600
1162N-1/2	7314151847241	1	536
1175-1	7314150106943	1	258
1175-11/2	7314150103768	1	258
1177-SCRIBE	7314150120550	5	541
1178-SCRIBE	7314150120567	5	541
1179-FLX	7311518276997	100	541
1179-SCRIBE	7314150120574	5	541
1179-TIPS	7314150120581	1	541
11M-10	7314151829155	5	45
11M-11	7314151829162	5	45
11M-12	7314151829179	5	45
11M-13	7314151829186	5	45
11M-14	7314151829193	5	45
11M-15	7314151829209	5	45
11M-16	7314151829216	5	45
11M-17	7314151829223	5	45
11M-18	7314151829230	5	45
11M-19	7314151829247	5	45
11M-21	7314151829254	5	45
11M-22	7314151829261	5	45
11M-24	7314151829278	5	45
11M-27	7314151829285	1	45
11M-30	7314151829292	1	45
11M-32	7314151829308	1	45
11M-36	7314151829315	1	45
11M-38	7314151829322	1	45
11M-8	7314151829131	5	45



11M-9	7314151829148	5	45
11M/S8	7314151829384	1	45
11Z-1	7314150355303	5	45
11Z-1/2	7314150355235	5	45
11Z-11/16	7314150355266	5	45
11Z-13/16	7314150355280	5	45
11Z-15/16	7314150355297	5	45
11Z-3/4	7314150355273	5	45
11Z-3/8	7314150355211	5	45
11Z-5/8	7314150355259	5	45
11Z-7/16	7314150355228	5	45
11Z-9/16	7314150355242	5	45
1300Z-1-1.1/8	7314153000989	1	55
1300Z-1/2-9/16	7314151039998	1	55
1300Z-1/4-5/16	7314153000965	1	55
1300Z-15/16-1	7314153005656	1	55
1300Z-19/32-11/16	7314151040000	1	55
1300Z-25/32-13/16	7314153000972	1	55
1300Z-3/8-7/16	7314151039981	1	55
1300Z-5/8-3/4	7314151040017	1	55
1300Z-7/8-15/16	7314153005649	1	55
1320RM-10-11	7314153014511	1	49
1320RM-12-13	7314153014528	1	49
1320RM-14-15	7314153014535	1	49
1320RM-16-17	7314153014542	1	49
1320RM-17-19	7314150359196	1	49
1320RM-18-19	7314153014559	1	49
1320RM-22-24	7314150221646	1	49
1320RM-6-7	7314153014498	1	49
1320RM-8-9	7314153014504	1	49
1320RM/SH8	7314150229888	1	50
1320RZ-1/2-9/16	7314153014580	1	49
1320RZ-1/4-5/16	7314153014566	1	49
1320RZ-3/4-13/16	7314150359264	1	49
1320RZ-3/4-7/8	7314150359271	1	49
1320RZ-3/8-7/16	7314153014573	1	49
1320RZ-5/8-11/16	7314150359257	1	49
1320RZ-7/8-15/16	7314150359288	1	49
1320SRM-14-19	7314150190355	1	50
1320SRM/S29	7314150188673	1	50
1321RZ-1/2-9/16	7314150359349	1	50
1321RZ-3/4-7/8	7314150359363	1	50
1321RZ-3/8-7/16	7314150359332	1	50
1321RZ-5/8-11/16	7314150359356	1	50
133SGM-100	7314151828523	1	58
133SGM-105	7314151828530	1	58
133SGM-110	7314151828547	1	59
133SGM-115	7314151828554	1	59
133SGM-120	7314151828561	1	59
133SGM-27	7314151828363	1	58
133SGM-30	7314151828370	1	58
133SGM-32	7314151828387	1	58
133SGM-36	7314151828394	1	58
133SGM-41	7314151828400	1	58
133SGM-46	7314151828417	1	58
133SGM-50	7314151828424	1	58
133SGM-55	7314151828431	1	58
133SGM-60	7314151828448	1	58
133SGM-65	7314151828455	1	58
133SGM-70	7314151828462	1	58
133SGM-75	7314151828479	1	58
133SGM-80	7314151828486	1	58
133SGM-85	7314151828493	1	58
133SGM-90	7314151828509	1	58
133SGM-95	7314151828516	1	58
14-24-3810	7311518002879	5	627
140	7314150008797	1	258
141	7314150008827	1	258
1410	7314150106332	1	258
1410D	7314150452842	1	258
1411-3.2	7314151040437	1	359
1411AUP8	7314150205936	1	360
1411AUP81	7314150230839	1	360
1411AUP82	7314150230846	1	360
1411AUP83	7314150230853	1	360
1411AUP84	7314150230860	1	360
1412-4.8	7314151040444	1	359
1413-6.4	7314151040451	1	359
1414-8	7314151040468	1	359
1415-8.7	7314151040475	1	359
1418A	7314151040505	1	359
1418B	7314151040512	1	359
1418C	7314151040529	1	359
1418D	7314151040536	1	359
1418E	7314151040543	1	359
1418F	7314151040550	1	359
1418G	7314151040567	1	359
1418H	7314151040574	1	359
1418I	7314151040581	1	359
1418K	7314151040598	1	359
1418S	7314151040604	1	359
1419-M12	7314150257423	1	359
1419-M16	7314150358045	1	359
1419-M5	7314150257409	1	359
1419-M8	7314150257416	1	359
1419-MD	7311518277352	1	333



1419/4	7314150125036	1	359
142	7314150008841	1	258
1420	7314150103744	1	258
1420-1.4	7314151696337	1	358
1420D	7314150452859	1	258
1421-2.1	7314151696412	1	358
1422-3.1	7314151696689	1	358
1423-4.8	7314151696764	1	358
1424-6.2	7314151696849	1	358
143	7314150008872	1	258
1430FT120	7314150342006	1	371
1435/5	7314151040734	1	359
1435/8	7314151040741	1	359
144	7314150008902	1	258
1446	7314150128631	15	578
1446-FLOAT	7314150438464	15	578
1446-OV	7314150313679	15	578
1450D-ISO	7314151040970	1	362
1450D-VWV	7314151040987	1	362
1450D/2	7314151040963	1	362
1460M/1	7314151041090	1	362
1460M/2	7314151041106	1	362
1460Z/2	7314151041120	1	362
1467-250	7314150124268	1	254
1467-320-850	7314150178636	1	254
1467-520	7314150124275	1	254
1467-B14	7314150301645	1	255
1467-L3.2	7314150209071	1	255
1467-L4	7314150209057	1	255
1467-L5	7314150209040	1	255
1467-L6	7314150209064	1	255
1467-L6.4	7314150209088	1	255
1467-LJ	7314150209033	1	255
1467-S2.4	7314150209026	1	255
1467-S3.2	7314150209019	1	255
1467-S4	7314150209002	1	255
1467-S5	7314150208999	1	255
1467-SJ	7314150208982	1	255
1468-10-1	7314150342471	1	340
1468-10M10	7314150243457	1	340
1468-10M4	7314150243419	1	340
1468-10M5	7314150243426	1	340
1468-10M6	7314150243433	1	340
1468-10M8	7314150243440	1	340
1468-6M3	7314150243372	1	340
1468-6M4	7314150243389	1	340
1468-6M5	7314150243396	1	340
1468-6M6	7314150243402	1	340
1468-M10	7314150243228	1	340
1468-M6	7314150243211	1	339
147	7314150008933	1	258
147-1	7314150367047	1	131
147-1.1/4	7314150367061	1	131
147-1.1/8	7314150367054	1	131
147-1/2	7314150366965	1	131
147-11/16	7314150366996	1	131
147-13	7314150366644	1	131
147-13/16	7314150367016	1	131
147-14	7314150366651	1	131
147-15	7314150366668	1	131
147-15/16	7314150367030	1	131
147-16	7314150366675	1	131
147-17	7314150366682	1	131
147-18	7314150366699	1	131
147-19	7314150366705	1	131
147-21	7314150366712	1	131
147-22	7314150366729	1	131
147-24	7314150366736	1	131
147-25	7314150366743	1	131
147-27	7314150366750	1	131
147-3/4	7314150367009	1	131
147-30	7314150366767	1	131
147-32	7314150366774	1	131
147-33	7314150366781	1	131
147-34	7314150366798	1	131
147-35	7314150366804	1	131
147-36	7314150366811	1	131
147-37	7314150366828	1	131
147-38	7314150366835	1	131
147-39	7314150366842	1	131
147-41	7314150366859	1	131
147-45	7314150366866	1	131
147-46	7314150366873	1	131
147-5/8	7314150366989	1	131
147-50	7314150366880	1	131
147-55	7314150366897	1	131
147-60	7314150366903	1	131
147-68	7314150366910	1	131
147-7/16	7314150366958	1	131
147-7/8	7314150367023	1	131
147-70	7314150366927	1	131
147-75	7314150366934	1	131
147-9/16	7314150366972	1	131
147-90	7314150366941	1	131
1470K-AC1	7314150226498	1	369
1470K-AC2	7314150226504	1	370



# 1470K-AC3



1470K-AC3	7314150226511	1	370
1470K-AC4	7314150226528	1	370
1470K-AC7	7314150271320	1	370
1470K-AC8	7314150328581	1	370
1470K-AC8GR	7314150328598	1	370
1470K-ACSIDE	7314150226535	1	370
1470K-ACD	7314150297269	1	371
1470K-ACTSS	7314150297283	1	371
1470K-ACTW	7314150297276	1	371
1470K7LH	7314150360444	1	368
1470K7LHBLUE	7314150407491	1	368
1470K7LHGREY	7314150407767	1	368
1470K7LHRED	7314150407507	1	368
1470K7SS	7314150343287	1	522
1470KAC01	7314150165124	1	371
1470KC2	7314150226696	1	371
1470KC3	7314150229680	1	371
1470KC5	7314150226665	1	371
1470KC5PC	7314150226672	1	371
1470KCTRAY	7314150226702	1	371
1470KXL-ACTD	7314150297290	1	371
1470KXL-ACTSS	7314150297313	1	371
1470KXL-ACTW	7314150297306	1	371
1470KXLC-TRAY	7314150285549	1	370
1471KXXL12BK TSS	7314150365432	1	369
1472K-ACTD	7314150399345	1	368
1472K-ACTSS	7314150399338	1	367
1472K-ACTW	7314150393152	1	368
1472K5	7314150349463	1	364
1472K5BLACK	7314150349500	1	364
1472K5BLUE	7314150349616	1	364
1472K5GREY	7314150403813	1	364
1472K5RED	7314150349562	1	364
1472K5WHITE	7314150403707	1	364
1472K6	7314150349470	1	364
1472K6BLACK	7314150349531	1	364
1472K6BLUE	7314150349623	1	364
1472K6GREY	7314150403820	1	364
1472K6RED	7314150349579	1	364
1472K6WHITE	7314150399888	1	364
1472K7	7314150349487	1	364
1472K7BKFFM	7314150447718	1	432
1472K7BLACK	7314150349548	1	364
1472K7BLUE	7314150349630	1	364
1472K7GREY	7314150403837	1	364
1472K7RED	7314150349586	1	364
1472K7WHITE	7314150403714	1	364
1472K8	7314150349494	1	364
1472K8BLACK	7314150349555	1	364
1472K8BLUE	7314150349647	1	364
1472K8GREY	7314150404018	1	364
1472K8RED	7314150349593	1	364
1472K8WHITE	7314150403721	1	364
1475K-ACSIDE	7314150419968	1	370
1475K6	7314150349654	1	368
1475K6BLACK	7314150349685	1	368
1475K6BLUE	7314150349760	1	368
1475K6RED	7314150349715	1	368
1475K7	7314150349661	1	368
1475K7BLACK	7314150349692	1	368
1475K7BLUE	7314150349814	1	368
1475K7RED	7314150349746	1	368
1475K8	7314150349678	1	368
1475K8BLACK	7314150349708	1	368
1475K8BLUE	7314150349821	1	368
1475K8RED	7314150349753	1	368
1475KXL-AC20BK	7314150353903	1	370
1475KXL12	7314150350223	1	369
1475KXL12BLACK	7314150350230	1	369
1475KXL12RED	7314150402731	1	369
1475KXL6	7314150349968	1	368
1475KXL6BLACK	7314150349999	1	368
1475KXL6BLUE	7314150350162	1	368
1475KXL6C	7314150350193	1	368
1475KXL6C BK-FF5	7314150437467	1	420
1475KXL6C BK-FF6	7314150437474	1	420
1475KXL6C BLACK	7314150350209	1	368
1475KXL6RED	7314150350124	1	368
1475KXL7	7314150349975	1	369
1475KXL7BLACK	7314150350070	1	369
1475KXL7BLUE	7314150350179	1	369
1475KXL7PCFF1	7314150309597	1	439
1475KXL7PCFF2	7314150345540	1	440
1475KXL7RED	7314150350148	1	369
1475KXL7SS	7314150349517	1	522
1475KXL8	7314150349982	1	369
1475KXL8BLACK	7314150350094	1	369
1475KXL8BLUE	7314150350186	1	369
1475KXL8RED	7314150350155	1	369
1475KXXL8CWTSS	7314150400157	1	369
1476KXXL7BK	7314150439935	1	369
1477K-AC10	7314150353163	1	367
1477K-AC11	7314150369874	1	366
1477K-AC12	7314150369195	1	365
1477K-AC13	7314150369218	1	365
1477K-AC14	7314150369225	1	365



1477K-AC15	7314150369249	1	365
1477K-AC16	7314150369256	1	366
1477K-AC17	7314150369270	1	366
1477K-AC18	7314150369287	1	366
1477K-AC19	7314150369676	1	366
1477K-AC20	7314150369683	1	366
1477K-AC21	7314150370412	1	366
1477K-AC22	7314150369706	1	366
1477K-AC23	7314150369867	1	368
1477K-AC24	7314150370429	1	367
1477K-AC25	7314150370436	1	367
1477K-AC26	7314150414864	1	367
1477K-AC28	7314150370481	1	366
1477K-AC29	7314150370498	1	366
1477K-AC30	7314150469949	1	367
1477K-ACTD	7314150370474	1	367
1477K-ACTP	7314150383764	1	367
1477K-ACTSS	7314150370450	1	367
1477K-ACTW	7314150370467	1	367
1477K6	7314150350391	1	364
1477K6BLACK	7314150351091	1	364
1477K6GREY	7314150351138	1	364
1477K6RED	7314150403653	1	364
1477K7	7314150350407	1	364
1477K7BLACK	7314150351107	1	364
1477K7COLORS	7314150400140	1	364
1477K7GREY	7314150351145	1	364
1477K7RED	7314150403660	1	364
1477K8	7314150350414	1	364
1477K8BLACK	7314150351114	1	364
1477K8GREY	7314150351183	1	364
1477K8RED	7314150403677	1	364
1477K9	7314150350940	1	364
1477K9BLACK	7314150351121	1	364
1477K9GREY	7314150351190	1	364
1477K9RED	7314150403684	1	364
1477K9WHITE	7314150403691	1	364
148-1	7314150367801	1	132
148-1/2	7314150367726	1	132
148-11/16	7314150367757	1	132
148-13	7314150367559	1	132
148-13/16	7314150367771	1	132
148-14	7314150367566	1	132
148-15	7314150367573	1	132
148-15/16	7314150367795	1	132
148-16	7314150367580	1	132
148-17	7314150367597	1	132
148-18	7314150367603	1	132
148-19	7314150367610	1	132
148-21	7314150367627	1	132
148-22	7314150367634	1	132
148-24	7314150367641	1	132
148-27	7314150367658	1	132
148-28	7314150367665	1	132
148-3/4	7314150367764	1	132
148-30	7314150367672	1	132
148-32	7314150367689	1	132
148-34	7314150367696	1	132
148-36	7314150367702	1	132
148-41	7314150367719	1	132
148-5/8	7314150367740	1	132
148-7/8	7314150367788	1	132
148-9/16	7314150367733	1	132
1482K4	7314150415779	1	365
1482K4BKW	7314150426126	1	365
1482K4BLACK	7314150415786	1	365
1482K4BLUE	7314150415793	1	365
1482K4GREY	7314150415809	1	365
1482K4RED	7314150415816	1	365
1482K4W	7314150425174	1	365
1482K4WHITE	7314150415823	1	365
1482K5W	7314150431274	1	365
1483CART	7314150273256	1	457
1483K2RB	7314150230013	1	456
1483K3RB	7314150230037	1	456
1483KHD3RB	7314150230099	1	456
1483KHD3RB-FF1	7314150233564	1	437
1483KHD3RB-FF2	7314150233571	1	437
1483KHD3RB-FF3	7314150233588	1	422
1483KHD3RB-FF4	7314150233595	1	422
1483KHD3RB-FF5	7314150233601	1	437
1483KHD3RB-FF7	7314150336050	1	437
1483KHD4RB	7314150230105	1	456
1485K4	7314150349838	1	369
1485K4BLACK	7314150349920	1	369
1485K4BLUE	7314150349944	1	369
1485K4RED	7314150349937	1	369
1485KXL4	7314150350247	1	369
1485KXL4BLACK	7314150350346	1	369
1485KXL4BLUE	7314150350360	1	369
1485KXL4RED	7314150350353	1	369
1487K4	7314150351206	1	365
1487K4BKW	7314150426133	1	365
1487K4BLACK	7314150351213	1	365
1487K4GREY	7314150351237	1	365
1487K4W	7314150425181	1	365



1495CD-AC1	7314150296965	1	455
1495CD60	7314150296927	1	454
1495CD60BK	7314150326952	1	454
1495CD60BL	7314150326969	1	454
1495CD60RED	7314150326976	1	454
1495CD60TS1	7314150325627	1	421
1495CD60W	7314150303656	1	455
1495CD60WBK	7314150327713	1	455
1495CD60WBL	7314150327720	1	455
1495CD60WRED	7314150327744	1	455
1495CS-AC1	7314150296910	1	455
1495CS15	7314150296934	1	454
1495CS15BK	7314150326853	1	454
1495CS15BL	7314150326860	1	454
1495CS15RED	7314150326877	1	454
1495CS15TS1	7314150325610	1	421
1495CS18	7314150296941	1	454
1495CS18BK	7314150326884	1	454
1495CS18BL	7314150326891	1	454
1495CS18BLHK	7314150407620	1	454
1495CS18HK	7314150407613	1	454
1495CS18RED	7314150326907	1	454
1495CS18TS1	7314150325603	1	421
1495FWB097TD	7314150296675	1	453
1495FWB097TS	7314150296651	1	454
1495FWB120TD	7314150296682	1	453
1495FWB120TS	7314150296668	1	454
1495K6CBKWB15TD	7314150369072	1	451
1495K6CBKWB15TS	7314150368990	1	450
1495K6CBKWB15TW	7314150369034	1	450
1495K6CBKWB18TD	7314150369690	1	451
1495K6CBKWB18TS	7314150369591	1	450
1495K6CBKWB18TW	7314150369638	1	451
1495K6CBLWB15TD	7314150369317	1	451
1495K6CBLWB15TS	7314150369119	1	450
1495K6CBLWB15TW	7314150369232	1	450
1495K6CBLWB18TD	7314150369829	1	451
1495K6CBLWB18TS	7314150369744	1	450
1495K6CBLWB18TW	7314150369782	1	451
1495K6CRDWB15TD	7314150368969	1	451
1495K6CRDWB15TS	7314150368600	1	450
1495K6CRDWB15TW	7314150368655	1	450
1495K6CRDWB18TD	7314150369553	1	451
1495K6CRDWB18TS	7314150369478	1	450
1495K6CRDWB18TW	7314150369515	1	451
1495K6CWB15TD	7314150368563	1	451
1495K6CWB15TS	7314150368440	1	450
1495K6CWB15TW	7314150368501	1	450
1495K6CWB18TD	7314150369430	1	451
1495K6CWB18TS	7314150369355	1	450
1495K6CWB18TW	7314150369393	1	451
1495K7CBKWB15TD	7314150369089	1	451
1495K7CBKWB15TS	7314150369003	1	450
1495K7CBKWB15TW	7314150369041	1	450
1495K7CBKWB18TD	7314150369713	1	451
1495K7CBKWB18TS	7314150369607	1	450
1495K7CBKWB18TW	7314150369645	1	451
1495K7CBLWB15TD	7314150369324	1	451
1495K7CBLWB15TS	7314150369164	1	450
1495K7CBLWB15TW	7314150369263	1	450
1495K7CBLWB18TD	7314150369836	1	451
1495K7CBLWB18TS	7314150369751	1	450
1495K7CBLWB18TW	7314150369799	1	451
1495K7CRDWB15TD	7314150368976	1	451
1495K7CRDWB15TS	7314150368624	1	450
1495K7CRDWB15TW	7314150368662	1	450
1495K7CRDWB18TD	7314150369560	1	451
1495K7CRDWB18TS	7314150369485	1	450
1495K7CRDWB18TW	7314150369522	1	451
1495K7CWB15TD	7314150368570	1	451
1495K7CWB15TS	7314150368464	1	450
1495K7CWB15TW	7314150368518	1	450
1495K7CWB18TD	7314150369447	1	451
1495K7CWB18TS	7314150369362	1	450
1495K7CWB18TW	7314150369409	1	451
1495K8CBKWB15TD	7314150369096	1	451
1495K8CBKWB15TS	7314150369010	1	450
1495K8CBKWB15TW	7314150369058	1	450
1495K8CBKWB18TD	7314150369720	1	451
1495K8CBKWB18TS	7314150369614	1	450
1495K8CBKWB18TW	7314150369652	1	451
1495K8CBLWB15TD	7314150369331	1	451
1495K8CBLWB15TS	7314150369188	1	450
1495K8CBLWB15TW	7314150369294	1	450
1495K8CBLWB18TD	7314150369843	1	451
1495K8CBLWB18TS	7314150369768	1	450
1495K8CBLWB18TW	7314150369805	1	451
1495K8CRDWB15TD	7314150368945	1	451
1495K8CRDWB15TS	7314150368631	1	450
1495K8CRDWB15TW	7314150368693	1	450
1495K8CRDWB18TD	7314150369577	1	451
1495K8CRDWB18TS	7314150369492	1	450
1495K8CRDWB18TW	7314150369539	1	451
1495K8CWB15TD	7314150368587	1	451
1495K8CWB15TS	7314150368471	1	450
1495K8CWB15TW	7314150368525	1	450



1495K8CWB18TD	7314150369454	1	451
1495K8CWB18TS	7314150370061	1	450
1495K8CWB18TW	7314150369416	1	451
1495KH6BKWB15TD	7314150418954	1	452
1495KH6BKWB15TS	7314150420063	1	451
1495KH6BKWB15TW	7314150417704	1	451
1495KH6BKWB18TD	7314150420575	1	452
1495KH6BKWB18TS	7314150420728	1	451
1495KH6BKWB18TW	7314150420452	1	451
1495KH6BLWB15TD	7314150418961	1	451
1495KH6BLWB15TS	7314150420216	1	451
1495KH6BLWB15TW	7314150417803	1	452
1495KH6BLWB18TD	7314150420629	1	452
1495KH6BLWB18TS	7314150420759	1	451
1495KH6BLWB18TW	7314150420483	1	451
1495KH6RDWB15TD	7314150418947	1	452
1495KH6RDWB15TS	7314150420032	1	451
1495KH6RDWB15TW	7314150417575	1	451
1495KH6RDWB18TD	7314150420544	1	452
1495KH6RDWB18TS	7314150420698	1	451
1495KH6RDWB18TW	7314150420421	1	451
1495KH6WB15TD	7314150418923	1	452
1495KH6WB15TS	7314150420001	1	451
1495KH6WB15TW	7314150417407	1	451
1495KH6WB18TD	7314150420513	1	452
1495KH6WB18TS	7314150420650	1	451
1495KH6WB18TW	7314150420377	1	451
1495KH7BKWB15TD	7314150419951	1	452
1495KH7BKWB15TS	7314150420193	1	451
1495KH7BKWB15TW	7314150418282	1	452
1495KH7BKWB18TD	7314150420605	1	452
1495KH7BKWB18TS	7314150420735	1	451
1495KH7BKWB18TW	7314150420469	1	452
1495KH7BLWB15TD	7314150419982	1	452
1495KH7BLWB15TS	7314150420223	1	451
1495KH7BLWB15TW	7314150418299	1	452
1495KH7BLWB18TD	7314150420636	1	452
1495KH7BLWB18TS	7314150420766	1	451
1495KH7BLWB18TW	7314150420490	1	452
1495KH7RDWB15TD	7314150419937	1	452
1495KH7RDWB15TS	7314150420049	1	451
1495KH7RDWB15TW	7314150418275	1	452
1495KH7RDWB18TD	7314150420551	1	452
1495KH7RDWB18TS	7314150420704	1	451
1495KH7RDWB18TW	7314150420438	1	452
1495KH7WB15TD	7314150418978	1	452
1495KH7WB15TS	7314150420018	1	451
1495KH7WB15TW	7314150417926	1	452
1495KH7WB18TD	7314150420520	1	452
1495KH7WB18TS	7314150420667	1	451
1495KH7WB18TW	7314150420407	1	452
1495KH8BKWB15TD	7314150419975	1	452
1495KH8BKWB15TS	7314150420209	1	451
1495KH8BKWB15TW	7314150418329	1	452
1495KH8BKWB18TD	7314150420612	1	452
1495KH8BKWB18TS	7314150420742	1	451
1495KH8BKWB18TW	7314150420476	1	452
1495KH8BLWB15TD	7314150419999	1	452
1495KH8BLWB15TS	7314150420360	1	451
1495KH8BLWB15TW	7314150418336	1	452
1495KH8BLWB18TD	7314150420643	1	452
1495KH8BLWB18TS	7314150420773	1	451
1495KH8BLWB18TW	7314150420506	1	452
1495KH8RDWB15TD	7314150419944	1	452
1495KH8RDWB15TS	7314150420056	1	451
1495KH8RDWB15TW	7314150418312	1	452
1495KH8RDWB18TD	7314150420568	1	452
1495KH8RDWB18TS	7314150420711	1	451
1495KH8RDWB18TW	7314150420445	1	452
1495KH8WB15TD	7314150418985	1	452
1495KH8WB15TS	7314150420025	1	451
1495KH8WB15TW	7314150418305	1	452
1495KH8WB18TD	7314150420537	1	452
1495KH8WB18TS	7314150420674	1	451
1495KH8WB18TW	7314150420414	1	452
1495KWB15TD	7314150296637	1	452
1495KWB15TS	7314150338115	1	452
1495KWB15TW	7314150296613	1	452
1495KWB18TD	7314150296644	1	452
1495KWB18TS	7314150338122	1	452
1495KWB18TW	7314150296620	1	452
1495TP-AC1	7314150297030	1	455
1495TP-AC10	7314150297207	1	455
1495TP-AC11	7314150297214	1	455
1495TP-AC12	7314150297221	1	455
1495TP-AC13	7314150297238	1	455
1495TP-AC2	7314150297122	1	455
1495TP-AC3	7314150297139	1	455
1495TP-AC4	7314150297146	1	455
1495TP-AC5	7314150297153	1	456
1495TP-AC6	7314150297160	1	456
1495TP-AC7	7314150297177	1	456
1495TP-AC8	7314150297184	1	456
1495TP-AC9	7314150297191	1	456
1495TP-ACHL20	7314150297047	1	456
1495TP-ACHL40	7314150297054	1	456



# 1495TP-ACHL65

1495TP-ACHL65	7314150297061	1	456
1495TP-ACHL90	7314150297078	1	456
1495TP-ACHU20	7314150297085	1	456
1495TP-ACHU40	7314150297092	1	456
1495TP-ACHU65	7314150297108	1	456
1495TP-ACHU90	7314150297115	1	456
1495TP-AUTO-M1	7314150438266	1	432
1495TP-AUTO-M2	7314150438273	1	432
1495TP-AUTO-M3	7314150438280	1	433
1495TP-AUTO-M4	7314150438297	1	433
1495TP-AUTO-M5	7314150438303	1	433
1495TP-AUTO-M6	7314150438310	1	433
1495TP06	7314150296989	1	454
1495TP06GR	7314150326914	1	454
1495TP09	7314150438624	1	454
1495TP10W	7314150297023	1	454
1495TP12	7314150296996	1	454
1495TP12GR	7314150326921	1	454
1495TP15	7314150297009	1	454
1495TP15GR	7314150326938	1	454
1495TP18	7314150297016	1	454
1495TP18GR	7314150326945	1	454
1495WB-AC1	7314150296576	1	454
1495WB-AC2	7314150296583	1	454
1495WB15-AC1	7314150296590	1	454
1495WB15-AC1GR	7314150327218	1	454
1495WB15TD	7314150296521	1	453
1495WB15TDGR	7314150327133	1	453
1495WB15TS	7314150296514	1	453
1495WB15TSBK	7314150326983	1	453
1495WB15TSBL	7314150326990	1	453
1495WB15TSBLBT	7314150407668	1	453
1495WB15TSBT	7314150407651	1	453
1495WB15TSRED	7314150327003	1	453
1495WB15TW	7314150296538	1	453
1495WB15TWGR	7314150327140	1	453
1495WB18-AC1	7314150296606	1	454
1495WB18-AC1GR	7314150327225	1	454
1495WB18TD	7314150296552	1	453
1495WB18TDGR	7314150327157	1	453
1495WB18TS	7314150296545	1	453
1495WB18TSBK	7314150327010	1	453
1495WB18TSBL	7314150327027	1	453
1495WB18TSBLBT	7314150407644	1	453
1495WB18TSBT	7314150407637	1	453
1495WB18TSRED	7314150327034	1	453
1495WB18TW	7314150296569	1	453
1495WB18TWGR	7314150327164	1	453
1495WBAH15TD	7314150312993	1	453
1495WBAH15TS	7314150313006	1	453
1495WBAH15TSBL	7314150327058	1	453
1495WBAH15TW	7314150313013	1	453
1495WBAH18TD	7314150313037	1	453
1495WBAH18TS	7314150313044	1	453
1495WBAH18TSBK	7314150327089	1	453
1495WBAH18TSBL	7314150327119	1	453
1495WBAH18TSRED	7314150327126	1	453
1495WBAH18TW	7314150313051	1	453
1495WBAH18TWGR	7314150327201	1	453
1496MB2	7314150273478	1	457
1496MB3	7314150273485	1	457
1496MB4	7314150273492	1	457
1496MB5	7314150273508	1	457
1497MB08	7314150349869	1	457
1497MB13	7314150349876	1	457
1497MB18	7314150349913	1	457
1497MBF350	7314150321391	1	458
1497MBF550	7314150321407	1	458
1497MBF750	7314150321414	1	458
1497MBW	7314150330164	1	458
14A-32	7314150368228	1	129
14A-9	7314150368211	1	129
14F-1/2	7314150366200	1	131
14F-3/4	7314150366217	1	131
14P-1/2	7314150366064	1	130
14Q-1/2	7314150366026	1	130
14R-1/2	7314150365920	1	130
14R-3/4	7314150365937	1	130
14T-1/2	7314150366125	1	130
14T-3/4	7314150366132	1	130
14W	7314150357031	1	129
1519 D	7314150032747	3	229
1519-9	7314150026074	1	229
1520 D	7311518278922	5	225
1520 G	7311518266516	5	225
1535	7314150214808	1	543
1537	7314150214822	1	543
1544	7311518276560	1	543
1546	7314150214792	1	543
1547	7311518276577	20	543
158-N	7311518277239	12	235
158-NB	7311518277246	12	236
1610	7314150404186	1	258
1610-NUT	7314150409594	1	258
1620	7314150404193	1	258
1620-NUT	7314150409754	1	258

166-6-16-2.5-12	7311518021979	12	28
166-6-16-2.5-2	7311518209698	5	28
167-1	7314150419067	1	134
167-1.1/16	7314150419074	1	134
167-1.1/4	7314150419104	1	134
167-1.1/8	7314150419081	1	134
167-1.3/16	7314150419098	1	134
167-1/2	7314150418930	1	134
167-10	7314150418657	1	133
167-11	7314150418664	1	133
167-11/16	7314150419364	1	134
167-12	7314150418671	1	133
167-13	7314150418688	1	133
167-13/16	7314150419036	1	134
167-14	7314150418695	1	133
167-15	7314150418701	1	133
167-15/16	7314150419050	1	134
167-16	7314150418718	1	133
167-17	7314150418725	1	133
167-18	7314150418732	1	133
167-19	7314150418749	1	133
167-20	7314150418763	1	133
167-21	7314150418770	1	133
167-22	7314150418787	1	133
167-23	7314150418794	1	133
167-24	7314150418800	1	133
167-25	7314150418817	1	133
167-26	7314150418824	1	133
167-27	7314150418831	1	133
167-28	7314150418848	1	134
167-3/4	7314150419029	1	133
167-3/8	7314150418909	1	134
167-30	7314150418855	1	133
167-32	7314150418862	1	133
167-36	7314150418886	1	133
167-5/16	7314150418893	1	134
167-5/8	7314150419012	1	134
167-7	7314150418619	1	133
167-7/16	7314150418916	1	134
167-7/8	7314150419043	1	134
167-8	7314150418626	1	133
167-8-21-3.2-12	7311518021986	12	28
167-9	7314150418640	1	133
167-9/16	7314150419005	1	134
168-1	7314150419562	1	134
168-1.1/16	7314150419579	1	134
168-1.3/16	7314150419586	1	134
168-1/2	7314150419487	1	134
168-10	7314150419272	1	134
168-11	7314150419289	1	134
168-11/16	7314150419517	1	134
168-12	7314150419296	1	134
168-13	7314150419302	1	134
168-13/16	7314150419531	1	134
168-14	7314150419319	1	134
168-15	7314150419326	1	134
168-15/16	7314150419555	1	134
168-16	7314150419333	1	134
168-17	7314150419340	1	134
168-18	7314150419357	1	134
168-19	7314150419371	1	134
168-20	7314150419388	1	134
168-21	7314150419395	1	134
168-22	7314150419401	1	134
168-23	7314150419418	1	134
168-24	7314150419425	1	134
168-26	7314150419432	1	134
168-27	7314150419449	1	134
168-3/4	7314150419524	1	134
168-3/8	7314150419463	1	134
168-5/16	7314150419456	1	134
168-5/8	7314150419500	1	134
168-6-3.2-1P	7311518152338	12	28
168-6-3.2-3P	7311518152413	12	28
168-6-3.5-1P	7311518152345	12	28
168-6-3.5-3P	7311518152420	12	28
168-7	7314150419241	1	134
168-7/16	7314150419470	1	134
168-7/8	7314150419548	1	134
168-8	7314150419258	1	134
168-8-4.0-1P	7311518152352	12	28
168-8-4.0-3P	7311518152437	12	28
168-8-4.0-6	7311518217419	6	28
168-8-4.5-1P	7311518152369	12	28
168-8-4.5-3P	7311518152444	12	28
168-8-4.5-6	7311518217426	6	28
168-8-4.8-1P	7311518152376	12	28
168-8-4.8-3P	7311518152451	12	28
168-8-4.8-6	7311518217433	6	28
168-8-5.2-1P	7311518152383	12	28
168-8-5.2-3P	7311518152468	12	28
168-8-5.2-6	7311518217440	6	28
168-8-5.5-1P	7311518152390	12	28
168-8-5.5-3P	7311518152475	12	28
168-8-5.5-6	7311518217457	6	28
168-8-6.3-1P	7311518152406	12	28





168-8-6.3-3P	7311518152482	12	28
168-9	7314150419265	1	134
168-9/16	7314150419494	1	134
168-COMBI-4.0	7311518209667	10	28
168-COMBI-4.0-6922	7311518209612	10	28
168-COMBI-4.5	7314150272860	10	28
168-COMBI-4.8	7311518209674	10	28
168-COMBI-4.8-6920	7311518209643	10	28
168-COMBI-5.5	7311518209681	10	28
168-COMBI-5.5-6924	7311518209650	10	28
169-10	7314150419630	1	135
169-11	7314150419647	1	135
169-12	7314150419654	1	135
169-13	7314150419661	1	135
169-14	7314150419678	1	135
169-15	7314150419715	1	135
169-16	7314150419722	1	135
169-17	7314150419739	1	135
169-18	7314150419746	1	135
169-19	7314150419753	1	135
169-20	7314150419760	1	135
169-21	7314150419777	1	135
169-22	7314150419784	1	135
169-23	7314150419791	1	135
169-24	7314150419807	1	135
169-27	7314150419814	1	135
169-7	7314150419609	1	134
169-8	7314150419616	1	134
169-9	7314150419623	1	134
16F-1/2	7314150418565	1	133
16F-1/4	7314150418541	1	133
16F-3/8	7314150418558	1	133
16R-1/2	7314150418602	1	133
16R-1/4	7314150418589	1	133
16R-3/8	7314150418596	1	133
1931M-10	7314151049256	5	51
1931M-11	7314151049263	5	51
1931M-12	7314151049270	5	51
1931M-13	7314151049287	5	51
1931M-14	7314151049294	5	51
1931M-17	7314151049324	5	51
1931M-4	7314151049171	5	51
1931M-4.5	7314151049188	5	51
1931M-5	7314151049195	5	51
1931M-5.5	7314151049201	5	51
1931M-6	7314151049218	5	51
1931M-7	7314151049225	5	51
1931M-8	7314151049232	5	51
1931M-9	7314151049249	5	51
1931M/10T	7314151049409	1	53
1931Z-1/2	7314151049775	5	52
1931Z-1/4	7314151049713	5	52
1931Z-1/8	7314150371563	5	52
1931Z-11/32	7314151049744	5	52
1931Z-11/32-3/8	7314150371624	5	52
1931Z-13/64	7314151049683	5	52
1931Z-15/64-1/4	7314150371570	5	52
1931Z-3/16	7314151049676	5	52
1931Z-3/8	7314151049751	5	52
1931Z-5/16	7314151049737	5	52
1931Z-5/32	7314151049669	5	52
1931Z-5/8	7314151049799	5	52
1931Z-7/16	7314151049768	5	52
1931Z-7/32	7314151049690	5	52
1931Z-9/16	7314151049782	5	52
1931Z-9/32	7314151049720	5	52
1931Z-9/32-5/16	7314150371600	5	52
1931Z/12T	7314150107674	1	53
1933M/6T	7314151821654	1	53
1936M-10-11	7314151051402	25	61
1936M-10-13	7314151344146	25	61
1936M-12-13	7314151051419	25	61
1936M-13-17	7314151830144	20	61
1936M-14-15	7314151051426	5	61
1936M-14-17	7314151051129	15	61
1936M-16-17	7314151051433	15	61
1936M-17-19	7314151051136	10	61
1936M-18-19	7314151051440	10	61
1936M-19-22	7314151051150	8	61
1936M-20-22	7314151830151	8	61
1936M-21-23	7314151830168	8	61
1936M-22-24	7314151830175	5	61
1936M-24-26	7314151830182	5	61
1936M-24-27	7314151051181	5	61
1936M-25-28	7314151830199	5	61
1936M-30-32	7314151051501	1	61
1936M-30-34	7314151838577	4	61
1936M-36-41	7314151830205	4	61
1936M-46-50	7314151830212	2	61
1936M-6-7	7314151051389	50	61
1936M-8-10	7314151830137	30	61
1936M-8-9	7314151051396	5	61
1936M/12	7314151830250	1	61
1936M/7	7314151830243	1	61
1943M-11-13	7314151052829	1	56
1943M-13-15	7314151804732	1	56



1943M-13-17	7314151804749	1	56
1943M-14-16	7314151052836	1	56
1943M-14-17	7314151052843	1	56
1943M-15-17	7314151052850	1	56
1943M-19-22	7314151052867	1	56
1943Z-11/16-13/16	7314150355174	1	56
1943Z-5/16-3/8	7314150355136	1	56
1943Z-5/8-3/4	7314150355167	1	56
1943Z-7/16-1/2	7314150355143	1	56
1943Z-9/16-5/8	7314150355150	1	56
1949M-10-11	7314151055394	1	57
1949M-10-12	7314151055400	1	57
1949M-12-13	7314151055417	1	57
1949M-12-14	7314151055424	1	57
1949M-14-15	7314151304546	1	57
1949M-14-17	7314151055448	1	57
1949M-17-19	7314151055455	1	57
1949M-19-22	7314151055462	1	57
1949M-22-24	7314151304553	1	57
1949M-24-27	7314151055479	1	57
1949M-30-32	7314151304577	1	57
1949M-8-9	7314151304539	1	57
1949Z-1-1.1/8	7314151055547	1	57
1949Z-1/2-9/16	7314151055509	1	57
1949Z-3/4-7/8	7314151055530	1	57
1949Z-3/8-7/16	7314151055486	1	57
1949Z-5/8-3/4	7314151055523	1	57
1950MZ-3/8	7314150130207	1	58
1952M-10	7314151057213	10	46
1952M-11	7314151057220	10	46
1952M-12	7314151057237	10	46
1952M-13	7314151057244	10	46
1952M-14	7314151057251	10	46
1952M-15	7314151057268	10	46
1952M-16	7314151057275	10	46
1952M-17	7314151057282	10	46
1952M-18	7314151057299	10	46
1952M-19	7314151057305	10	46
1952M-20	7314151057312	10	46
1952M-21	7314151057329	10	46
1952M-22	7314151057336	5	46
1952M-23	7314151057343	5	46
1952M-24	7314151057350	5	46
1952M-25	7314151057367	5	46
1952M-26	7314151057374	5	46
1952M-27	7314151057381	5	46
1952M-28	7314151057398	1	46
1952M-29	7314151325763	1	46
1952M-30	7314151057404	1	46
1952M-32	7314151057411	1	46
1952M-34	7314151838553	1	46
1952M-36	7314151057428	1	46
1952M-41	7314151057435	1	46
1952M-46	7314151840105	1	46
1952M-50	7314151840112	1	46
1952M-55	7314151840129	1	46
1952M-6	7314151057176	10	46
1952M-60	7314151840136	1	46
1952M-65	7314150135226	1	46
1952M-7	7314151057183	10	46
1952M-70	7314150135301	1	46
1952M-75	7314150135325	1	46
1952M-8	7314151057190	10	46
1952M-80	7314150135509	1	46
1952M-9	7314151057206	10	46
1952M/10	7314151057688	1	47
1952M/14T	7314151057695	1	47
1952M/17T	7314151057473	1	47
1952M/26T	7314151057701	1	47
1952M/7T	7314151806637	1	47
1952M/SH12	7314153013330	1	46
1952M/SH6	7314153013286	1	46
1952Z-1	7314151057602	1	46
1952Z-1.1/16	7314151057619	1	46
1952Z-1.1/2	7314151057756	1	46
1952Z-1.1/4	7314151057633	1	46
1952Z-1.1/8	7314151057626	1	46
1952Z-1.3/8	7314151057732	1	46
1952Z-1.5/16	7314151057718	1	46
1952Z-1.5/8	7314151057763	1	46
1952Z-1.7/16	7314151057749	1	46
1952Z-1/2	7314151057527	5	46
1952Z-1/4	7314151057480	5	46
1952Z-11/16	7314151057558	5	46
1952Z-11/32	7314150111046	5	46
1952Z-13/16	7314151057572	5	46
1952Z-15/16	7314151057596	5	46
1952Z-3/4	7314151057565	5	46
1952Z-3/8	7314151057503	5	46
1952Z-5/16	7314151057497	5	46
1952Z-5/8	7314151057541	5	46
1952Z-7/16	7314151057510	5	46
1952Z-7/8	7314151057589	5	46
1952Z-9/16	7314151057534	5	46
1952Z/11T	7314151057725	1	47
1976TORX-T10	7314150123438	5	220



# 1976TORX-T15



1976TORX-T15	7314150123452	5	220
1976TORX-T20	7314150123469	5	220
1976TORX-T25	7314150123476	5	220
1976TORX-T27	7314150123490	5	220
1976TORX-T30	7314150123506	5	220
1976TORX-T40	7314150123513	5	220
1976TORX-T6	7314150122240	5	220
1976TORX-T7	7314150123384	5	220
1976TORX-T8	7314150123391	5	220
1976TORX-T9	7314150123414	5	220
1976TORX/5T	7314150126927	1	220
1986TORX-T10	7314150123537	5	220
1986TORX-T15	7314150123544	5	220
1986TORX-T20	7314150123551	5	220
1986TORX-T25	7314150123568	5	220
1986TORX-T27	7314150123575	5	220
1986TORX-T30	7314150123582	5	220
1986TORX-T40	7314150123599	5	220
1986TORX-T9	7314150122233	5	220
1986TORX/7T	7314150123735	1	220
1995LM-1.5	7314150122172	10	217
1995LM-10	7314150123254	10	217
1995LM-12	7314150123261	10	217
1995LM-14	7314150123278	10	217
1995LM-2	7314150122189	10	217
1995LM-2.5	7314150123162	10	217
1995LM-3	7314150123179	10	217
1995LM-4	7314150123186	10	217
1995LM-5	7314150123209	10	217
1995LM-6	7314150123216	10	217
1995LM-7	7314150123223	10	217
1995LM-8	7314150123230	10	217
1995LM-9	7314150123247	10	217
1995M-0.9	7314150216291	10	215
1995M-1.5	7314150122158	10	215
1995M-10	7314150122912	10	215
1995M-12	7314150122943	10	215
1995M-14	7314150122967	10	215
1995M-17	7314150122974	10	215
1995M-19	7314150122981	10	215
1995M-2	7314150122745	10	215
1995M-2.5	7314150122752	10	215
1995M-22	7314150122998	10	215
1995M-3	7314150122769	10	215
1995M-4	7314150122776	10	215
1995M-5	7314150122790	10	215
1995M-6	7314150122813	10	215
1995M-7	7314150122837	10	215
1995M-8	7314150122851	10	215
1995M-9	7314150122875	10	215
1995M/10T	7314150123643	1	216
1995M/11T	7314150123650	1	216
1995M/15T	7314150123667	1	216
1995M/6T	7314150123629	1	216
1995M/8T	7314150123636	1	216
1995TORX-T10	7314150123308	5	218
1995TORX-T15	7314150123322	5	218
1995TORX-T20	7314150123339	5	218
1995TORX-T25	7314150123346	5	218
1995TORX-T27	7314150123353	5	218
1995TORX-T30	7314150123360	5	218
1995TORX-T40	7314150123377	5	218
1995TORX-T45	7314150123407	5	218
1995TORX-T50	7314150123421	5	218
1995TORX-T55	7314150216963	5	218
1995TORX-T6	7314150122196	5	218
1995TORX-T60	7314150216970	5	218
1995TORX-T7	7314150123285	5	218
1995TORX-T8	7314150123292	5	218
1995TORX-T9	7314150122219	5	218
1995TORX/11T	7314150123742	1	219
1995TORX/13T	7314150123759	1	219
1995TORX/4T	7314150123674	1	219
1995TORX/7T	7314150123711	1	219
1995Z-1/16	7314150122165	10	216
1995Z-1/2	7314150123117	10	216
1995Z-1/4	7314150123070	10	216
1995Z-1/8	7314150123025	10	216
1995Z-3/16	7314150123056	10	216
1995Z-3/32	7314150123018	10	216
1995Z-3/4	7314150123155	10	216
1995Z-3/8	7314150123094	10	216
1995Z-5/16	7314150123087	10	216
1995Z-5/32	7314150123049	10	216
1995Z-5/64	7314150123001	10	216
1995Z-5/8	7314150123131	10	216
1995Z-7/16	7314150123100	10	216
1995Z-7/32	7314150123063	10	216
1995Z/10T	7314150215980	1	217
1995Z/12T	7314150215997	1	217
1996M-1.5	7314150122202	10	217
1996M-10	7314150122721	10	217
1996M-12	7314150122738	10	217
1996M-2	7314150122653	10	217
1996M-2.5	7314150122660	10	217
1996M-3	7314150122677	10	217



1996M-4	7314150122684	10	217
1996M-5	7314150122691	10	217
1996M-6	7314150122707	10	217
1996M-8	7314150122714	10	217
1996TORX-T10	7314150122783	5	220
1996TORX-T15	7314150122806	5	220
1996TORX-T20	7314150122820	5	220
1996TORX-T25	7314150122844	5	220
1996TORX-T27	7314150122868	5	220
1996TORX-T30	7314150122882	5	220
1996TORX-T40	7314150122899	5	220
1996TORX-T45	7314150122905	5	220
1996TORX-T50	7314150122929	5	220
1996TORX-T9	7314150122226	5	220
1996TORX/5T	7314150123698	1	220
1997M-10	7314151059354	10	214
1997M-11	7314151059361	10	214
1997M-12	7314151059378	5	214
1997M-14	7314151059385	5	214
1997M-16	7314151059392	1	214
1997M-17	7314151059408	1	214
1997M-19	7314151059415	1	214
1997M-3.5	7314151302078	10	214
1997M-4	7314151059293	10	214
1997M-4.5	7314151302085	10	214
1997M-5	7314151059309	10	214
1997M-6	7314151059316	10	214
1997M-7	7314151059323	10	214
1997M-8	7314151059330	10	214
1997M-9	7314151059347	10	214
1997M/10T	7314151302108	1	214
1997M/11T	7314151059453	1	214
1997M/7T	7314151059439	1	214
1998M-1.5	7314150185719	10	214
1998M-10	7314150185801	10	214
1998M-12	7314150185818	5	214
1998M-14	7314150185825	1	214
1998M-17	7314150185832	1	214
1998M-19	7314150185849	1	214
1998M-2	7314150185726	10	214
1998M-2.5	7314150185733	10	214
1998M-22	7314150185856	1	214
1998M-3	7314150185740	10	214
1998M-4	7314150185757	10	214
1998M-5	7314150185764	10	214
1998M-6	7314150185863	10	214
1998M-7	7314150185771	10	214
1998M-8	7314150185788	10	214
1998M-9	7314150185795	5	214
1998M/10T	7314150186228	1	215
1998M/11T	7314150186235	1	215
1998M/15T	7314150186242	1	215
1998M/6T	7314150186204	1	215
1998M/8R	7314150186266	1	215
1998M/8T	7314150186211	1	215
1999M/7H	7314151801076	1	214
1999MV-10	7314150121496	3	496
1999MV-12	7314150121502	3	496
1999MV-3	7314150121427	5	496
1999MV-4	7314150121434	5	496
1999MV-5	7314150121441	5	496
1999MV-6	7314150121458	5	496
1999MV-7	7314150121465	5	496
1999MV-8	7314150121472	5	496
1999MV-9	7314150121489	5	496
1RM-10	7314153000576	1	47
1RM-11	7314153000583	1	47
1RM-12	7314153000590	1	47
1RM-13	7314153000606	1	47
1RM-14	7314153000613	1	47
1RM-15	7314153000620	1	47
1RM-16	7314153000637	1	47
1RM-17	7314153000644	1	47
1RM-18	7314153000651	1	47
1RM-19	7314153000668	1	47
1RM-21	7314150214495	1	47
1RM-22	73141530005915	1	47
1RM-24	73141530005922	1	47
1RM-27	7314153014177	1	47
1RM-30	7314153014184	1	47
1RM-32	7314153014191	1	47
1RM-6	7314153014146	1	47
1RM-7	7314153014153	1	47
1RM-8	7314153000552	1	47
1RM-9	7314153000569	1	47
1RM/S5	7314150225514	10	49
1RM/SH12	7314150219780	10	48
1RM/SH6	7314150219773	1	48
1RM/SH8	7314150223015	1	48
1RMA-10-1/4-BIT	7314153014634	1	51
1RMA-10-1/4-SQ	7314153014603	1	51
1RMA-13-10-BIT	7314150223008	1	51
1RMA-13-3/8-SQ	7314153014610	1	51
1RMA-13-5/16-BIT	7314153014641	1	51
1RMA-19-1/2-SQ	7314153014627	1	51
1RMA-19-1/4-SQ	7314150190638	1	51



1RMA/S4	7314153014658	1	51
1RMA/S8	7314153014665	1	49
1RZ-1/2	7314153014245	1	48
1RZ-1/4	7314150153725	1	48
1RZ-11/16	7314153014269	1	48
1RZ-11/32	7314150358915	1	48
1RZ-15/16	7314150358939	1	48
1RZ-3/4	7314153014276	1	48
1RZ-3/8	7314153014214	1	48
1RZ-5/16	7314153014207	1	48
1RZ-5/8	7314153014252	1	48
1RZ-7/16	7314153014221	1	48
1RZ-7/8	7314150358922	1	48
1RZ-9/16	7314153014238	1	48
1RZ/SH8	7314150223022	1	49
1Z-1	7314150375189	10	43
1Z-1/2	7314150375103	10	43
1Z-1/4	7314150375042	20	43
1Z-11/16	7314150375134	10	43
1Z-11/32	7314150375073	10	43
1Z-13/16	7314150375158	10	43
1Z-15/16	7314150375172	5	43
1Z-3/16	7314150375028	20	43
1Z-3/4	7314150375141	10	43
1Z-3/8	7314150375080	10	43
1Z-5/16	7314150375066	10	43
1Z-5/8	7314150375127	10	43
1Z-7/16	7314150375097	10	43
1Z-7/32	7314150375035	20	43
1Z-7/8	7314150375165	10	43
1Z-9/16	7314150375110	10	43
1Z-9/32	7314150375059	20	43
2-21-51	7315962500011	5	627
2-300-14-0-0	7311518044138	10	33
2-300-14-2-0	7311518044145	10	33
2-300-14-4-0	7311518108786	10	33
2-300-14-D-1P	7311518189105	10	36
2-300-16-0-0	7311518020491	10	33
2-300-16-1-0	7311518020507	10	33
2-300-16-2-0	7311518020514	10	33
2-300-16-4-0	7311518020521	10	33
2-300-16-D-1P	7311518189129	10	36
2-300-18-0-0	7311518190545	10	33
2-300-18-2-0	7311518190552	10	33
2-301-14-0-0	7311518190569	10	33
2-301-14-2-0	7311518108748	10	33
2-301-14-D-1P	7311518189136	1	36
2-301-16-0-0	7311518108755	10	33
2-301-16-1-0	7311518020538	10	33
2-301-16-2-0	7311518020545	10	33
2-302-14-0-0	7311518044152	10	34
2-302-14-2-0	7311518044169	10	34
2-302-14-4-0	7311518108793	10	34
2-302-14-D-1P	7311518189150	10	36
2-302-16-0-0	7311518108762	10	34
2-302-16-1-0	7311518020552	10	34
2-302-16-2-0	7311518020569	10	34
2-302-16-4-0	7311518108809	10	34
2-302-16-D-1P	7311518189167	10	36
2-302-18-0-0	7311518190613	10	34
2-302-18-2-0	7311518190620	10	34
2-303-14-2-0	7311518044176	10	34
2-303-14-D-1P	7311518189174	10	36
2-303-16-0-0	7311518108779	10	34
2-303-16-1-0	7311518020576	10	34
2-303-16-2-0	7311518020583	10	34
2-303-16-4-0	7311518108830	10	34
2-303-16-D-1P	7311518189198	1	36
2-303-18-0-0	7311518190644	10	34
2-303-18-2-0	7311518190668	10	34
2-304-14-0-0	7311518044183	10	33
2-304-14-2-0	7311518044190	10	33
2-304-14-4-0	7311518108878	10	33
2-304-14-D-1P	7311518189204	10	36
2-304-16-0-0	7311518020590	10	33
2-304-16-1-0	7311518020606	10	33
2-304-16-2-0	7311518020613	10	33
2-304-16-4-0	7311518020620	10	33
2-304-16-D-1P	7311518189211	10	36
2-304-18-0-0	7311518190712	10	33
2-304-18-2-0	7311518190736	10	33
2-305-16-1-0	7311518020637	10	33
2-305-16-2-0	7311518108908	10	33
2-306-14-D-1P	7311518189228	1	36
2-306-16-1-0	7311518020644	10	34
2-306-16-2-0	7311518108854	10	34
2-307-14-0-0	7311518044206	10	33
2-307-14-2-0	7311518044213	10	33
2-307-14-4-0	7311518108885	10	33
2-307-14-D-1P	7311518189235	10	36
2-307-16-0-0	7311518020651	10	33
2-307-16-1-0	7311518020668	10	33
2-307-16-2-0	7311518020675	10	33
2-307-16-4-0	7311518020682	10	33
2-307-16-D-1P	7311518189242	10	36
2-307-18-0-0	7311518190965	10	33



2-307-18-2-0	7311518190972	10	33
2-308-14-2-0	7311518044220	10	34
2-308-14-D-1P	7311518189259	1	36
2-308-16-0-0	7311518108861	10	34
2-308-16-1-0	7311518020699	10	34
2-308-16-2-0	7311518020705	10	34
2-309-16-2-0	7311518108946	10	34
2-309-16-4-0	7311518191054	10	34
2-313-16-0-0	7311518191177	10	33
2-470-14-0-0	7311518191191	10	34
2-470-14-2-0	7311518109080	10	34
2-470-14-4-0	7311518191207	10	34
2-470-16-1-0	7311518010942	10	35
2-470-16-2-0	7311518109097	10	35
2-471-16-1-0	7311518010959	5	35
2-472-14-0-0	7311518191214	5	35
2-472-14-2-0	7311518109103	5	35
2-472-16-0-0	7311518191238	5	35
2-472-16-1-0	7311518010966	5	36
2-472-16-2-0	7311518108922	5	36
2010	7314151584610	1	463
204030150	8413345400855	12	549
204030160	8413345400862	12	549
204030180	8413345400879	12	549
204050130	8413345097970	6	549
204530140	8413345097918	12	549
204550130	8413345097956	6	549
2045A3000	8413345097932	12	549
2047-0.8-4	7314151060459	5	221
2047-1-5.5	7314151060473	5	221
2047-1-2-8	7314151060480	5	221
2047-1.6-10	7314151060497	1	221
2047-2-12	7314151060503	1	221
2047PR-1-2	7314151060558	5	221
2047PR-3-4	7314151060565	5	221
2047PZ-1-2	7314150216390	5	221
2058/S26	7314151849276	30	176
2058/S26-2	7314151849283	1	168
208	7311518017545	5	554
209027040	8413345400947	12	549
209227060	8413345400961	12	549
209228100	8413345099233	12	549
209250100	8413345099585	6	549
210	7315965100379	10	554
2100PD-150	7314150205691	5	226
2101D-125	7314150106387	5	224
2101D-125IP	7314150106431	5	224
2101D-140	7314150106394	5	224
2101D-140IP	7314150106325	5	224
2101D-160	7314150106400	5	224
2101D-160IP	7314150106318	5	224
2101D-180	7314150106417	5	224
2101D-180IP	7314150106448	5	224
2101G-125	7314150106462	5	224
2101G-125IP	7314150106516	5	224
2101G-125IPD	7314150335039	5	224
2101G-140	7314150106479	5	224
2101G-140IP	7314150106288	5	224
2101G-140IPD	7314150335053	5	224
2101G-160	7314150106486	5	224
2101G-160IP	7314150106295	5	224
2101G-160IPD	7314150335060	5	224
2101G-180	7314150106493	5	224
2101G-180IP	7314150106523	5	224
2101G-180IPD	7314150335077	5	224
2101GC-125IP	7314150106547	5	224
2101GC-140IP	7314150106554	5	224
2101GC-160IP	7314150106561	5	224
2101GC-180IP	7314150106578	5	224
2101PG-160	7314150113972	5	224
2101S-140	7314150106592	3	492
2101S-160	7314150106608	3	492
2101S-180	7314150106615	3	492
2101S-200	7314150106622	3	492
211035180	8413345000147	5	549
211042210	8413345000154	5	549
212027180	8413345000178	5	549
212033220	8413345129435	8	549
212202050	8413345110266	10	549
212302900	8413345110280	10	549
212502150	8413345110303	10	550
212602150	8413345110327	10	550
212602800	8413345129404	10	550
212704350	8413345122184	6	550
213026140	8413345000185	5	549
2145020D0	8413345097994	1	550
2145020L0	8413345098045	1	550
2145025C0	8413345098083	1	550
2145025D0	8413345098007	1	550
2145025L0	8413345098052	1	550
2145030D0	8413345098014	1	550
2145030L0	8413345098069	1	550
2145035D0	8413345098021	1	550
2145035L0	8413345098076	1	550
2145039C0	8413345098090	1	550
2145PD-150	7314150114009	5	228





215-150	7311518017576	1	555
215000030	8413345131971	12	547
215000040	8413345131988	12	547
215000050	8413345131995	12	547
215000060	8412243557944	12	547
215000070	8413345132008	12	547
215000080	8413345132015	12	547
215000090	8413345132022	12	547
215000100	8413345132039	12	547
215000120	8413345132046	12	547
215500300	7314150220120	12	546
215500400	8413345122627	12	546
215500500	8413345122641	12	546
215500600	8413345122665	12	546
215500700	8413345122689	12	546
215500800	8413345122702	12	546
215500900	8413345137478	12	546
215501000	8413345122726	12	546
216-150-R	7311518017583	1	556
216-300-R	7311518017798	1	556
216000300	8413345403658	12	546
216000400	8413345403665	12	546
216000500	8413345403672	12	546
216000600	8413345403689	12	546
216000700	8413345403696	12	546
216000800	8413345403702	12	546
216000900	8413345403719	12	546
216001000	8413345403726	12	546
216001200	8413345403740	12	546
216100040	8413345132053	12	547
216100060	8413345132091	12	547
216100080	8413345132060	12	547
216100100	8413345132077	12	547
216100120	8413345132084	12	547
216500300	8413345407274	12	547
216500500	8413345407281	12	547
216500750	8413345407298	12	547
216501000	8413345407304	12	547
2171G-140	7314150116232	5	226
2171G-160	7314150116133	5	226
2171G-180	7314150116140	5	226
2171V-160	7314150126798	2	493
2171V-180	7314150126804	2	493
2171V-200	7314150466009	2	493
218	7311518017521	10	555
218-BULK	7311518140946	1	555
219	7311518140953	5	555
219001000	8413345029865	5	547
219001200	8413345029872	5	547
219001400	8413345029889	5	547
219001600	8413345029896	5	547
219002000	8413345029902	5	547
2190PD-150	7314150114016	5	226
219201000	8413345029667	5	547
219201200	8413345029674	5	547
219201400	8413345029681	5	547
219201600	8413345029698	5	547
219202000	8413345029704	5	547
219302500	8413345129466	10	547
219303000	8413345129473	10	547
219303500	8413345129480	10	547
21HDD-140	7314150231256	5	225
21HDD-140IP	7314150231263	5	225
21HDD-160	7314150231270	5	225
21HDD-160IP	7314150231287	5	225
21HDD-180	7314150231294	5	225
21HDD-180IP	7314150231300	5	225
21HDD-200	7314150231317	5	225
21HDD-200IP	7314150231324	5	225
21HDG-140	7314150231331	5	224
21HDG-140A	7314150237654	5	225
21HDG-140IP	7314150231348	5	224
21HDG-160	7314150231355	5	224
21HDG-160A	7314150237661	5	225
21HDG-160IP	7314150231362	5	224
21HDG-180	7314150231379	5	224
21HDG-180A	7314150237678	5	225
21HDG-180IP	7314150231386	5	224
21HDG-200	7314150231409	5	224
21HDG-200A	7314150238439	5	225
21HDG-200IP	7314150231416	5	224
21HDGC-140IP	7314150231423	5	225
21HDGC-160IP	7314150231430	5	225
21HDGC-180IP	7314150231447	5	225
21HDGC-200IP	7314150231454	5	225
221 D	7314150037070	5	240
221201200	8413345029711	5	547
221202000	8413345029728	5	547
221203000	8413345029735	5	547
221301200	8413345029742	5	547
221302000	8413345029759	5	547
221303000	8413345029766	5	547
222 D	7314150037087	5	240
22209004B	8413345401333	1	339
2223 D-150	7314150033591	5	244
2223 G-150	7314150113651	5	243



2223 S-150	7314150032983	3	495
2223GC-150	7314150123919	5	243
2223V-160	7314150134113	2	495
223 D	7314150037094	5	240
2233 D-160	7314150114023	5	229
2233 D-200	7314150114030	5	229
2233 D-240	7314150114047	5	229
2233D-160IP	7314150114054	5	229
2233D-200IP	7314150114061	5	229
2233D-240IP	7314150114078	5	229
2235-160	7314150179695	1	230
224 D	7314150037100	5	240
225 D	7314150037117	5	240
225-PLUS	7311518029708	5	554
2250V-170	7314150128730	2	493
2250V-230	7314150128747	2	493
2260 G-210	7314150205684	5	230
2260 S-210	7314150206759	2	492
2260V-210	7314150128754	2	493
227-22	7314150419845	1	133
227-24	7314150419852	1	133
227-27	7314150419869	1	133
227-30	7314150419876	1	133
227-32	7314150419883	1	133
227-34	7314150419890	1	133
227-36	7314150419906	1	133
227-41	7314150419913	1	133
227-46	7314150419920	1	133
228	7311518014995	5	555
228-15-5P	7311518031442	10	556
228-22	7314150420070	1	134
228-24	7314150420087	1	134
228-27	7314150420094	1	134
228-30	7314150420100	1	134
228-32	7314150420117	1	134
228-32-100P	7311518150990	1	556
228-32-10P	7311518010867	10	556
228-32-5P	7311518031459	10	556
228-34	7314150420124	1	134
228-36	7314150420131	1	134
228-41	7314150420148	1	134
228-46	7314150420155	1	134
228-BULK	7311518009069	5	555
228-SD	7311518277048	24	163
228-SET-SD	7314150217946	1	163
229-SD	7311518277055	24	163
22F-3/4	7314150419821	1	133
22R-3/4	7314150419838	1	133
23-15	7311518274665	10	627
23-21	7311518012274	10	627
23-24	7311518003852	10	627
23-30	7311518003869	10	627
23-32	7311518003876	10	627
23-36	7311518003883	10	627
230-SD	7311518280956	25	163
2301A0000	8413345091282	6	548
2301B0000	8413345091305	6	548
2301C0000	8413345091329	6	548
2302A0000	8413345091343	6	548
2302B0000	8413345091367	6	548
2302C0000	8413345091381	6	548
2303B0000	8413345091404	6	548
2303D0000	8413345091428	6	548
2303F0000	8413345091442	6	548
2303H0000	8413345091466	6	548
2303J0000	8413345091480	6	548
2303K0000	8413345091503	6	548
2303L0000	8413345091527	6	548
2304A0000	8413345091541	6	548
2304C0000	8413345091565	6	548
230713500	8413345091589	6	548
2308A0000	8413345091602	6	548
2308B0000	8413345091626	6	548
230912500	8413345091640	6	548
232-SD	7314150214839	1	163
233-300	7311518044015	5	562
233-300-A	7311518044039	5	562
233-400	7311518044022	5	562
2339 D	7314150032792	3	228
2339 DIP	7314150103508	5	228
2339-220	7314150442461	5	229
2339-220IP	7314150101061	5	229
2339-250IP	7314150101078	5	229
2339-280IP	7314150101948	5	229
2339-300IP	7314150123865	6	229
2339D-300	7314150411245	5	228
2339D-300IP	7314150411238	6	228
234-A1	7311518013653	1	562
234-A2	7311518013660	1	562
234-SD	7314150214846	25	163
234-W1	7311518013608	10	562
234-W2	7311518013615	10	562
234-W3	7311518013622	10	562
236001200	8413345129077	6	548
236101200	8413345129060	6	548
238	7311518011314	5	555



239	7311518010874	5	555
2420 G-125	7314150102525	5	236
2420G-125IP	7314150447091	5	236
2421 D-140IP	7314150101979	5	237
2421 D-160IP	7314150101986	5	237
2421 D-180IP	7314150101993	5	237
2421 G-140	7314150102532	5	236
2421 G-140IP	7314150102006	5	236
2421 G-160	7314150102549	5	236
2421 G-160 IP	7314150100576	5	236
2421 G-180	7314150102556	5	236
2421 G-180 IP	7314150100583	5	236
2421GC-140IP	7314150447107	5	237
2421GC-160IP	7314150447114	5	237
2421GC-180IP	7314150233229	5	237
2421S-140	7314150447121	3	494
2421S-160	7314150447138	3	494
2421S-180	7314150447145	3	494
2421V-160	7314150126774	2	494
2427 D-160	7314150032846	5	235
2427 D-200	7314150169030	5	235
2427 G-160	7314150100408	5	235
2427 G-160 IP	7314150100743	5	235
2427 G-200	7314150100415	5	235
2427 G-200 IP	7314150100750	5	235
2427 GC-160IP	7314150102051	5	235
2427 GC-200IP	7314150102075	5	235
2427 S-200	7314150033027	3	494
2427S-160	7314150447008	3	494
2427V-200	7314150126903	2	494
2430 D-140	7314150032853	5	233
2430 D-140 IP	7314150100774	5	233
2430 D-160	7314150032860	5	233
2430 D-160 IP	7314150100781	5	233
2430 D-200	7314150032884	5	233
2430 D-200 IP	7314150100804	5	233
2430 G-140	7314150102563	5	233
2430 G-140 IP	7314150102143	5	233
2430 G-160	7314150024070	5	233
2430 G-160 IP	7314150100811	5	233
2430 G-190HD	7311518259945	5	233
2430 G-200	7314150100422	5	233
2430 G-200 IP	7314150100835	5	233
2430 GC-140 IP	7314150102150	5	233
2430 GC-160 IP	7314150102167	5	233
2430 GC-200 IP	7314150102174	5	233
2430 S-160	7314150206742	3	494
2430 S-200	7314150033010	3	494
2430S-140	7314150446995	3	494
2430V-160	7314150126880	2	494
2430V-200	7314150126897	2	494
2431G-125	7314150447015	5	234
2431G-125IP	7314150447053	5	234
2431G-140	7314150447022	5	234
2431G-140IP	7314150447060	5	234
2431G-160	7314150447039	5	234
2431G-160IP	7314150447077	5	234
2431G-180	7314150447046	5	234
2431G-180IP	7314150447084	5	234
244-20-U7/8-HP	7311518012519	10	560
244-22-U7/8-HP	7311518012526	10	560
2444	7311518286750	15	578
2444-LAP	7314150237463	10	578
2446	7314150128648	15	578
2446-EL	7314150270736	12	579
2446-EL-HELP	7314150394500	12	579
2446-ELL	7314150370153	12	579
2446-ELR	7314150370146	12	579
2446-LINO	7314150270750	12	579
2446-OV	7314150313662	15	578
2446-SAFE	7314150453078	15	578
2448	7314150136049	12	568
2449	7314150194056	12	568
244P-20-U7-HP	7311518235499	4	561
244P-22-U7-HP	7311518235482	10	561
2460	7314151063467	1	243
2461 C19	7314151063498	1	241
2461 C40	7314151063504	1	241
2461 C8	7314151063481	1	241
2463 D19	7314151063511	1	241
2463 D40	7314151063528	1	241
2463 D8	7314151588878	1	241
2464 A10	7314151063535	1	242
2464 A19	7314151063542	1	242
2464 A3	7314151406516	1	242
2464 A40	7314151063559	1	242
2465D-200	7314150120826	1	243
2466 B10	7314151063573	1	242
2466 B19	7314151063580	1	242
2466 B3	7314151406868	1	242
2466 B40	7314151063597	1	242
247-24	7314150367078	1	131
247-27	7314150367085	1	131
247-30	7314150367092	1	131
247-32	7314150367108	1	131
247-34	7314150367115	1	131



247-36	7314150367122	1	131
247-41	7314150367139	1	131
247-46	7314150367146	1	131
247-50	7314150367153	1	131
247-55	7314150367160	1	131
247-60	7314150367177	1	131
2470 G-160	7314150116188	5	234
2470 G-200	7314150116195	5	234
2471 G-160	7314150116225	5	238
2477 G-200	7314150116201	5	236
248-24	7314150367818	1	132
248-27	7314150367825	1	132
248-30	7314150367832	1	132
248-32	7314150367849	1	132
248-34	7314150367856	1	132
248-36	7314150367863	1	132
248-41	7314150367870	1	132
248-46	7314150367887	1	132
248-50	7314150367894	1	132
248-55	7314150367900	1	132
248-60	7314150367917	1	132
2484-20	7314150233250	1	361
2484-30	7314150233267	1	361
2484-45	7314150233274	1	361
2484-60	7314150233281	1	361
2484/S4	7311518276553	10	361
2484T-20	7314150455102	1	361
2484T-30	7314150455119	1	361
2484T-45	7314150455126	1	361
2484T-60	7314150455133	1	361
2484T/S4	7314150455096	1	361
2485	7314150242382	1	339
2487	7311518276058	12	534
2488	7311518276072	12	547
2489	7311518276065	12	547
24A-14	7314150368235	1	129
24A-27	7314150368242	1	129
24F-1	7314150366231	1	131
24F-3/4	7314150366224	1	131
24R-1	7314150365951	1	130
24R-3/4	7314150365944	1	130
24T-1	7314150366156	1	130
24T-3/4	7314150366149	1	130
24W	7314150368266	1	129
2500-16-XT-HP	7311518160159	4	560
2500-19-XT-HP	7311518160722	4	560
2500-22-XT-HP	7311518140922	4	560
2500-24-XTT-HP	7311518181338	4	560
250400000	8413345129374	1	550
250400010	7314150314430	1	550
250400020	7314150393008	1	550
250400030	7314150393015	1	551
250501800	8413345128964	50	551
250502450	8413345128957	50	551
2509	7314151064280	50	362
2510	7314151064297	1	350
2520	7314150023752	1	230
2520 S	7314150033041	1	493
2520-SH	7311518197506	1	230
2521 D-140	7314150032907	5	238
2521 G-140	7314150100293	5	238
2521 G-160 IP	7314150100620	5	238
2521D-140IP	7314150447176	5	238
2521D-160	7314150127139	5	238
2521D-160IP	7314150447183	5	238
2521G-140IP	7314150447169	5	238
2521G-160	7314150447152	5	238
2521GC-160	7314150127146	5	238
2521S-140	7314150447190	3	494
2521S-160	7314150447206	3	494
2521V-160	7314150126781	2	495
2530	7314150326761	1	362
2530-40	7314151317294	5	533
2535F0	7314150402236	1	361
2535F1	7314151064495	1	361
2535F2	7314150233854	1	361
2535F3	7314150180233	1	361
2535L	7314150125357	12	361
255-17/34	7314150272372	2	558
255-34	7314150272365	2	558
2555	7311518276041	1	303
256-26	7311518000080	4	559
2600-16-XT11-HP	7311518239527	4	559
2600-19-XT-HP	7311518160760	4	560
2600-22-XT-HP	7311518160777	4	560
2620-80	7311518200947	1	230
2628 D-160	7314150123193	5	232
2628 D-180	7314150042661	5	232
2628 D-200	7314150123315	5	232
2628 G-160	7314150042999	5	231
2628 G-160IP	7314150055357	5	231
2628 G-180	7314150042678	5	231
2628 G-180IP	7314150044030	5	231
2628 G-200	7314150103539	5	231
2628 GC-160IP	7314150101863	5	231
2628 GC-180IP	7314150101870	5	231



## 2628 GC-200IP



2628 GC-200IP	7314150101887	5	231
2628 S-160	7314150206735	3	493
2628 S-180	7314150044054	3	493
2628 S-200	7314150043002	3	493
2628G-200IP	7314150101085	5	231
2629G-160	7314150446933	5	232
2629G-160IP	7314150446964	5	232
2629G-180	7314150446940	5	232
2629G-180IP	7314150446971	5	232
2629G-200	7314150446957	5	232
2629G-200IP	7314150446988	5	232
2630DC-160IP	7314150446896	5	232
2630DC-180IP	7314150446902	5	232
2630DC-200IP	7314150446919	5	232
2630GC-160IP	7314150180165	5	232
2630GC-180IP	7314150180172	5	232
2630GC-200IP	7314150180189	5	232
2630SC-180	7314150446926	3	494
2632	7314151065706	1	360
2633/S4	7311518276942	12	533
2633HD/S6	7314150205783	1	296
2633HD1	7314150230464	1	296
2633HD2	7314150230471	1	296
2633HD3	7314150230488	1	296
2633HD4	7314150230495	1	296
2633HD5	7314150230501	1	296
2633HD6	7314150230518	1	296
2633L/S4	7311518276959	12	533
2635	7311518276348	1	603
2640D-160	7314150123766	10	232
2640D-180	7314150123773	5	232
2640D-200	7314150123797	5	232
2646	7314151304638	1	227
2646 A	7314151304645	1	227
2646 AK	7314151396619	1	227
2646 K	7314151495862	1	227
2646 M	7314151487928	1	227
2646 MF	7314151573683	1	237
2646 MS	7314151573768	1	239
2646 R	7314151304706	1	227
2646 RA	7314151834838	1	227
2646 RK	7314151496678	1	227
2648	7314151304713	1	227
2648 A	7314151304720	1	227
2649	7314150058013	1	227
2650	7314151065829	1	240
2650 B	7314151065843	1	240
2656	7314151304737	1	229
2656 R	7314151473976	1	236
2656 S	7314150058044	1	234
2666	7314150058006	1	227
2666 FK	7314151066079	1	227
2674 NB	7314151066321	1	227
2674 NVDE	7314151498535	1	493
2676 B	7314151066390	1	227
2678 B	7314151066468	1	227
2678 G-160	7314150116157	5	233
2678 G-180	7314150116164	5	233
2678 G-200	7314150116171	5	233
2678V-160	7314150126835	2	494
2678V-180	7314150126842	2	494
2678V-200	7314150126859	2	494
268	7311518017538	5	554
2681	7311518276706	12	254
2681-1	7314150116980	1	255
2688D-250	7314150123520	3	232
2690	7314150411108	10	254
26S-1216	7314151830236	8	62
26S-16	7314150345588	5	62
26S-610	7314151830229	10	62
2700-22-XT7-HP	7311518191672	4	561
2700-24-XT7-HP	7311518191665	4	561
2704A	7314151066963	1	575
2705R	7314151821470	1	575
2720	7314150179701	1	230
2720-SH	7314150179718	1	230
2744	7314151809096	6	574
277-30	7314150367184	1	131
277-32	7314150367191	1	131
277-34	7314150367207	1	131
277-36	7314150367214	1	131
277-41	7314150367221	1	131
277-46	7314150367238	1	131
277-50	7314150367245	1	131
277-55	7314150367252	1	131
277-60	7314150367269	1	131
278-30	7314150367924	1	132
278-32	7314150367931	1	132
278-34	7314150367948	1	132
278-36	7314150367955	1	132
278-41	7314150367962	1	132
278-46	7314150367979	1	132
278-50	7314150367986	1	132
278-55	7314150367993	1	132
278-60	7314150368006	1	132
2784-2.5	7314150215607	1	207



2784-3.5	7314150215614	1	207
2784-4.5	7314150215621	1	207
2787 F	7314151474270	1	228
2787 G	7314150058020	1	228
27A-24	7314150368259	1	129
27F-1	7314150366248	1	131
27M-10-11	7314150180523	10	61
27M-12-13	7314150180547	10	61
27M-13-17	7314150180790	10	61
27M-14-15	7314150180554	10	61
27M-16-17	7314150180561	10	61
27M-16-18	7314150180806	10	61
27M-18-19	7314150180578	10	61
27M-20-22	7314150180585	10	61
27M-21-23	7314150180592	5	61
27M-21-24	7314150180813	5	61
27M-24-26	7314150180608	5	61
27M-24-27	7314150180820	5	61
27M-25-28	7314150180622	5	61
27M-27-29	7314150180639	5	61
27M-30-32	7314150180646	5	61
27M-6-7	7314150180509	10	61
27M-8-9	7314150180516	10	61
27M/10	7314150180677	1	62
27M/12	7314150180684	1	62
27M/12T	7314150180783	1	61
27M/6	7314150180653	1	61
27M/8	7314150180660	1	62
27M/8T	7314150180776	1	61
27R-1	7314150365968	1	130
27T-1	7314150366163	1	130
28-29/S4	7314150179688	1	243
2800 N	7314151318338	1	231
2800-140	7314150121632	3	241
2800-150	7314150034567	3	241
2800-180	7314150034581	3	241
2800-225	7314150034604	3	241
2800-300	7314150122622	1	241
2801 N	7314151318352	1	231
2804	7314151692698	1	230
2805-280	7314151826123	1	230
2806-35V	7314150122103	1	493
2806-52V	7314150122110	1	493
2820EF1	7314150122042	12	579
2820EF2	7314150122059	8	579
2820EF3	7314150122066	1	579
2820EF4	7314150122073	1	579
2820EK	7314150122035	6	579
2820EK-01	7314150270743	12	579
2820V13	7314150121823	1	496
2820V17	7314150121830	1	496
2820VBC	7314150121915	1	493
2820VDE	7314151605476	10	497
2820VFP	7314150121922	1	497
2820VGO5	7314150121953	1	498
2820VGO10	7314150121960	1	498
2820VGCOT	7314150121977	1	498
2820VHELP	7314150121908	1	497
2820VM	7314150121946	1	498
2820VVP	7314150121885	2	497
2820VPC	7314150121892	2	497
2820VTEE	7314150121939	1	497
2855	7314151825805	1	255
2855 D	7314151822569	1	255
2856-10	7314150437214	1	255
2856-8	7314150437207	1	255
2890-125	7314150122639	3	241
2890-140	7314150034550	3	241
2890-180	7314150034574	3	241
2890-210	7314150034598	3	241
2890-300	7314150122646	1	241
28M-10	7314151834678	5	59
28M-11	7314151834685	5	59
28M-12	7314151834692	5	59
28M-13	7314151834708	5	59
28M-14	7314151834715	5	59
28M-15	7314151834722	5	59
28M-16	7314151834739	5	59
28M-17	7314151834746	5	59
28M-18	7314151834753	3	59
28M-19	7314151834760	3	59
28M-20	7314150122561	3	59
28M-21	7314151834777	3	59
28M-22	7314151834784	3	59
28M-23	7314150122578	3	59
28M-24	7314151834791	3	59
28M-25	7314150122585	3	59
28M-26	7314150122592	3	59
28M-27	7314151834807	3	59
28M-28	7314150122608	1	59
28M-29	7314150122615	1	59
28M-30	7314151834814	1	59
28M-32	7314151834821	1	59
28M-6	7314151834630	5	59
28M-7	7314151834647	5	59
28M-8	7314151834654	5	59

28M-9	7314151834661	5	59
28M/11	7314151838126	1	60
28M/12	7314151838133	1	60
28M/15	7314151838140	1	60
28M/8	7314151838119	1	60
28MV-10	7314150121298	2	496
28MV-11	7314150121304	2	496
28MV-12	7314150121311	2	496
28MV-13	7314150121328	2	496
28MV-14	7314150121335	2	496
28MV-15	7314150121342	2	496
28MV-16	7314150121359	2	496
28MV-17	7314150121366	2	496
28MV-18	7314150121373	2	496
28MV-19	7314150121380	2	496
28MV-20	7314150121397	2	496
28MV-21	7314150121403	2	496
28MV-22	7314150121410	2	496
28MV-8	7314150121274	2	496
28MV-9	7314150121281	2	496
29-B	7311518277703	1	318
2900-140	7314150121045	3	242
2900-150	7314150034499	3	242
2900-180	7314150034512	3	242
2900-215	7314150034536	3	242
2900-300	7314150121076	1	242
2928-1	7314150056583	1	242
2928-160	7314150056514	1	242
2928-2	7314150056590	1	242
2928-200	7314150056521	1	242
2928-250	7314150056538	1	242
2928-3	7314150056606	1	242
2928-4	7314150056613	1	242
2949-190IP	7314150123926	1	253
2949-200IP	7314150123940	1	253
2949-240IP	7314150123957	1	253
2949-250IP	7314150123971	1	253
2949-L075	7314150440559	1	253
2949-L120	7314150440566	1	253
2949-L200	7314150440573	1	253
2949-NUT	7314150440580	1	253
2949-YOKE	7314150440597	1	254
2950-250	7314150124039	1	252
2951-140	7314150124084	1	250
2951-180	7314150102204	1	250
2951-250	7314150102211	1	250
2951-300	7314150102228	1	250
2951-S05	7314150447299	1	253
2951-S07	7314150447305	1	253
2951-S10	7314150447312	1	253
2951-S12	7314150447329	1	253
2952-165	7314150103836	1	250
2952-235	7314150103843	1	250
2953-140	7314150124046	1	250
2953-200	7314150124053	1	250
2953-250	7314150124060	1	250
2953-300	7314150124077	1	250
2955-250	7314150102235	1	251
2956-290	7314150413690	1	252
2957-250	7314150102259	1	250
2958-140	7314150124107	1	250
2958-200	7314150124114	1	250
2958-250	7314150102242	1	250
296	7311518034146	1	563
2960-280	7314150412808	1	251
2962-8-150	7314150412815	1	252
2962-8-230	7314150413706	1	252
2962-8-300	7314150413713	1	252
2963-280	7314150102280	1	251
2963-450	7314150124138	1	251
2963-630	7314150124145	1	251
2964-160	7314150124183	1	252
2964-280	7314150102297	1	252
2964-450	7314150124190	1	252
2964-600	7314150124206	1	252
2965-200	7314150124152	1	252
2965-280	7314150102266	1	252
2966-280	7314150102273	1	252
2967-180	7314150102396	1	251
2968-190	7314150124091	1	250
2968-235	7314150103850	1	250
2970G-200	7314150134946	5	233
2971G-250	7314150117154	5	240
2979 D-180	7314150034246	5	238
2990-125	7314150121250	3	242
2990-140	7314150034482	3	242
2990-180	7314150034505	3	242
2990-200	7314150034529	3	242
2990-300	7314150121267	1	242
2997-250	7314150124237	1	253
2997-300	7314150124244	5	253
2998-250	7314150124213	1	251
2998-SHN	7314150447275	1	251
2999-250	7314150124169	1	251
2999-SHN	7314150447282	1	251
29M-10	7314150122318	5	60

29M-11	7314150122325	5	60
29M-12	7314150122332	5	60
29M-13	7314150122349	5	60
29M-14	7314150122356	5	60
29M-15	7314150122363	5	60
29M-16	7314150122370	5	60
29M-17	7314150122387	5	60
29M-18	7314150122394	3	60
29M-19	7314150122401	3	60
29M-20	7314150122417	3	60
29M-21	7314150122424	3	60
29M-22	7314150122431	3	60
29M-23	7314150122448	3	60
29M-24	7314150122455	3	60
29M-25	7314150122462	3	60
29M-26	7314150122479	3	60
29M-27	7314150122486	3	60
29M-28	7314150122493	1	60
29M-29	7314150122509	1	60
29M-30	7314150122516	1	60
29M-32	7314150122523	1	60
29M-6	7314150122271	5	60
29M-7	7314150122288	5	60
29M-8	7314150122295	5	60
29M-9	7314150122301	5	60
29M/10	7314150122547	1	60
29M/14	7314150122554	1	60
29M/8	7314150122530	1	60
2M-10-11	7314151001223	5	55
2M-10-13	7314151001513	5	55
2M-12-13	7314151001230	5	55
2M-13-17	7314151343972	5	55
2M-14-15	7314151001247	5	55
2M-16-17	7314151001254	5	55
2M-16-18	7314151001575	5	55
2M-17-19	7314151000844	5	55
2M-18-19	7314151001261	5	55
2M-19-22	7314151000868	5	55
2M-20-22	7314151001278	5	55
2M-21-23	7314151001285	5	55
2M-22-24	7314151001612	5	55
2M-24-26	7314151001292	5	55
2M-24-27	7314151000899	5	55
2M-25-28	7314151001308	5	55
2M-27-29	7314150205332	1	55
2M-27-30	7314151001636	5	55
2M-27-32	7314151001322	5	55
2M-30-32	7314151000929	5	55
2M-32-36	7314151001667	1	55
2M-36-41	7314151001681	1	55
2M-41-46	7314151001704	1	55
2M-46-50	7314151001711	1	55
2M-6-7	7314151001209	5	55
2M-8-10	7314151001506	5	55
2M-8-9	7314151001216	5	55
2M/10T	7314150212996	1	55
2M/12T	7314151001414	1	55
2M/13	7314150213016	1	56
2M/8T	7314151001391	1	55
2M/S8	7314151827335	1	55
2MV-10	7314150121113	5	496
2MV-11	7314150121120	5	496
2MV-12	7314150121137	5	496
2MV-13	7314150121144	5	496
2MV-14	7314150121151	5	496
2MV-15	7314150121168	5	496
2MV-16	7314150121175	5	496
2MV-17	7314150121182	3	496
2MV-18	7314150121199	3	496
2MV-19	7314150121205	3	496
2MV-21	7314150121212	3	496
2MV-22	7314150121229	3	496
2MV-23	7314150121236	3	496
2MV-24	7314150121243	3	496
2MV-6	7314150121069	5	496
2MV-7	7314150121083	5	496
2MV-8	7314150121090	5	496
2MV-9	7314150121106	5	496
2Z-1-1.1/8	7314151001827	1	55
2Z-1.1/16-1.1/4	7314151001834	1	55
2Z-1/2-9/16	7314151001445	1	55
2Z-1/4-5/16	7314151001421	1	55
2Z-13/16-7/8	7314151001797	1	55
2Z-15/16-1	7314151001810	1	55
2Z-3/4-7/8	7314151001773	1	55
2Z-3/8-7/16	7314151001438	1	55
2Z-5/16-3/8	7314151001728	1	55
2Z-5/8-11/16	7314151001452	1	55
2Z-9/16-5/8	7314151001735	1	55
2Z/7T	7314150217373	1	56
3-24-51	7315962500028	5	626
3-330-12-1-0	7311518020712	5	32
3-330-12-2-0	7311518020729	5	32
3-330-14-1-0	7311518020736	5	32
3-330-14-2-0	7311518020743	5	32
3-331-14-1-0	7311518020750	5	33



# 300-14-F15/16-HP



300-14-F15/16-HP	7311518005955	4	559
301	7311518001384	5	563
301-16	7314150456048	12	261
301-22	7311518293673	12	261
302	7311518013349	5	563
302-35	7311518293680	6	261
302-511W-12P	7311518207786	1	563
302-51W-12P	7311518013356	1	563
302-53W-12P	7311518013363	1	563
302-55W-12P	7311518013370	1	563
302-57W-12P	7311518013387	1	563
302-59W-12P	7311518207779	1	563
302-6X4P	7311518017590	1	563
302-71M-12P	7311518013394	1	563
302-73M-12P	7311518013400	1	563
302-75M-12P	7311518013417	1	563
302-76N	7314150456307	6	261
302-77M-12P	7311518207793	1	563
302-81S-12P	7311518013677	1	563
302-83S-12P	7311518013684	1	563
302-85S-12P	7311518207809	1	563
302-95-SET	7314150456321	1	261
303-5P	7311518031435	10	563
304	7311518265533	10	554
3045/1VDE	7314151783815	1	498
3045V-1	7314150128785	1	498
3045V-2	7314150128792	1	499
3046-OP	7311518276980	12	534
3046-REF	7311518276966	1	296
3049-2	7314151848118	1	464
306	7311518265540	10	554
306-10	7314150120246	1	261
306-12	7314150120253	1	261
306-15	7311518297107	12	261
306-15-95	7311518297329	1	261
306-22	7311518297114	12	261
306601500	8413345098700	5	582
306602000	8413345098717	5	582
306603000	8413345217033	5	582
306604000	8413345217095	5	582
306703000	8413345217194	5	582
306704000	8413345098755	5	582
306705000	8413345098762	5	582
306706000	8413345098779	5	582
306708000	8413345098786	5	582
306710000	8413345098793	5	582
306712000	8413345123334	2	582
306715000	8413345123341	2	582
306803000	8413345098809	5	582
306804000	8413345098816	5	582
306805000	8413345098823	2	582
306806000	8413345098830	2	582
306808000	8413345098847	2	582
306810000	8413345098854	2	582
306812000	8413345098861	2	582
306815000	8413345098878	1	582
306820000	8413345098885	1	582
306903000	8413345123402	2	582
306904000	8413345123419	2	582
306905000	8413345123426	2	582
306906000	8413345123433	2	582
306908000	8413345123457	2	582
306910000	8413345123471	2	582
307401B	7314150254958	1	260
307411B	7314150254965	1	260
307421B	7314150254972	1	260
307431B	7314150254989	1	260
307441	7314150235933	1	260
307451	7314150235940	1	260
308504000	8413345035156	1	542
308505000	8413345035194	1	542
308506000	8413345035163	1	542
308508000	8413345035170	1	542
308510000	8413345035187	1	542
3090-20-XT11-HP	7311518181369	4	560
31	7314150004942	5	41
31 IP	7314150004959	50	41
3100TB	7314150125364	1	458
3100TB-DISP	7314150400300	1	459
310M-24	7314151829612	1	59
310M-27	7314151829629	1	59
310M-30	7314151829636	1	59
310M-32	7314151829643	1	59
310M-36	7314151829650	1	59
310M-38	7314151829667	1	59
310M-41	7314151829674	1	59
310M-46	7314151829681	1	59
310M-50	7314151829698	1	59
310M-55	7314151829704	1	59
310M-60	7314151829711	1	59
310M-65	7314151829728	1	59
310M-70	7314151829735	1	59
310M-75	7314151829742	1	59
310M-80	7314151829759	1	59
310M-85	7314151829766	1	59
310M-90	7314151829773	1	59



310M-95	7314151829780	1	59
3115	7314150055326	1	354
3149-OR	7311518292249	1	457
3149-ORFF1	7314150292479	1	427
3149-ORTS1	7314150292066	1	427
3150-12-XT9-HP	7311518181406	4	558
315M-27	7314150133291	1	59
315M-30	7314150133307	1	59
315M-32	7314150133314	1	59
315M-36	7314150133321	1	59
315M-41	7314150133345	1	59
315M-46	7314150133352	1	59
315M-50	7314150133369	1	59
315M-55	7314150133376	1	59
315M-60	7314150133383	1	59
315M-65	7314150133390	1	59
315M-70	7314150133406	1	59
315M-75	7314150133413	1	59
315M-80	7314150133420	1	59
315Z-1.1/16	7314150133437	1	59
315Z-1.1/2	7314150133505	1	59
315Z-1.1/4	7314150133468	1	59
315Z-1.1/8	7314150133444	1	59
315Z-1.11/16	7314150133529	1	59
315Z-1.13/16	7314150133543	1	59
315Z-1.15/16	7314150133567	1	59
315Z-1.3/16	7314150133451	1	59
315Z-1.3/4	7314150133536	1	59
315Z-1.3/8	7314150133482	1	59
315Z-1.5/16	7314150133475	1	59
315Z-1.5/8	7314150133512	1	59
315Z-1.7/16	7314150133499	1	59
315Z-1.7/8	7314150133550	1	59
315Z-2	7314150133574	1	59
315Z-2.1/16	7314150133581	1	59
315Z-2.1/2	7314150133642	1	59
315Z-2.1/4	7314150133611	1	59
315Z-2.1/8	7314150133598	1	59
315Z-2.15/16	7314150133697	1	59
315Z-2.3/16	7314150133604	1	59
315Z-2.3/4	7314150133673	1	59
315Z-2.3/8	7314150133635	1	59
315Z-2.5/16	7314150133628	1	59
315Z-2.5/8	7314150133666	1	59
315Z-2.7/8	7314150133680	1	59
315Z-2.9/16	7314150133659	1	59
315Z-3	7314150133703	1	59
315Z-3.1/8	7314150133840	1	59
316-1	7311518296216	12	262
316-2	7311518296223	12	263
316-2-95	7311518296278	1	263
317	7311518240936	10	554
317-40	7311518296230	12	263
318-54	7311518296254	1	263
3180-14-XT11-HP	7311518181390	4	560
319	7311518240943	5	554
320	7311518265557	10	554
321	7311518001841	5	554
321-18-SB	7311518129125	10	556
321-24-SB	7311518129132	10	556
321-7-SB	7311518129149	10	556
322500300	8413345012829	1	532
322500500	8413345012836	1	532
322500800	8413345012843	1	532
322510300	8413345015899	1	532
322510400	8413345137386	1	532
322510500	8413345015905	1	532
322510600	8413345137393	1	532
322510700	8413345137409	1	532
322510800	8413345015912	1	532
3240-14-XT11-HP	7311518243005	4	560
325	7311518214852	5	554
325001000	8413345000505	1	532
3250010SH	8413345137492	1	532
326000200	8413345000529	1	532
326000300	8413345012881	1	532
326010200	8413345016100	1	532
326020200	8413345016117	1	532
326030200	8413345016124	1	532
327020500	7314150330584	1	532
327020500-SH1	7314150361021	1	532
327020500-SH2	7314150361038	1	532
327020500-SH3	7314150361045	1	532
327020500-SH4	7314150361052	1	532
328000000	8413345000734	1	532
3280M	7314151071318	1	53
329000330	8413345000741	1	533
329000500	8413345000758	1	533
329500300	7314150181001	1	532
329500350	7314150181049	1	532
329500400	7314150181018	1	532
329500450	7314150181056	1	532
329600100	7314150181063	1	532
329600200	7314150181070	1	532
329600500	7314150181025	1	532
329600800	7314150181032	1	532





331-15-23	7311518274658	5	626
331-21-51-KP	7311518003814	5	626
332-21-51	7311518229337	5	626
333	7311518005832	5	627
333-5	7311518005849	10	627
339-6T	7311518128371	4	622
33H	7314150266791	5	41
340-6T	7311518002008	4	622
341	7314150113729	1	258
3416 A	7314150216260	1	244
3416 A SH	7314150410941	1	244
3416 B	7314150411160	10	244
3416 B SH	7314150411191	10	244
3417 A	7314150216277	12	244
3418 A	7314150216284	1	244
3419 B	7314151812416	1	245
3419 EB	7314151812621	1	245
342	7314150113736	1	258
343	7314150113743	1	258
344	7314150113750	1	258
349	7311518018924	4	627
3517 A	7314150410910	1	244
3518 A	7314150216376	1	245
3518 A SH	7314150216383	1	245
3518 B	7314150410927	1	245
3520 A	7314150410934	1	245
3520 A SH	7314150410958	1	245
3520 B	7314150411177	10	245
3520 B SH	7314150411207	10	245
3524	7314151073336	1	534
3524L-K	7314151339807	1	534
3525HB	7314151073350	5	534
36	7314150223381	5	587
361-10	7311518295202	1	259
361-12	7311518295219	1	259
361-14	7311518295226	1	259
361-18	7311518295233	1	259
361-24	7311518295240	1	259
361-36	7311518295257	1	259
361-8	7311518295196	1	259
3619 A	7314150411184	10	245
3619 A SH	7314150411214	10	245
3625AR-35	7314150214723	34	590
3625AR-50	7314150214730	18	590
3625AR-60	7314150214747	12	590
3625ARL-35	7314150214754	6	591
3625ARL-50	7314150214761	6	591
3625ARL-60	7314150214778	6	591
3625ARLH-35	7314150218677	80	591
3625ARLH-50	7314150218684	50	591
3625ARLH-60	7314150218691	16	591
3625N-22	7314151073602	5	592
3625N-27	7314151073626	5	592
3625N-32	7314151073640	5	592
3625N-40	7314151073688	5	592
3625N-60	7314151073718	1	592
3625NL-27	7314151073848	1	592
3625NL-32	7314151073855	1	592
3625NL-40	7314151073879	1	592
3625NL-50	7314151073886	1	592
3625NL-60	7314151073893	1	592
3625PU-105	7314150170098	4	591
3625PU-30	7311518276119	12	591
3625PU-50	7311518276126	6	591
3625PU-60	7311518276133	6	591
3625RM-55	7314150120758	50	592
3625RM-65	7314150120765	40	592
3625RM-75	7314150319820	30	592
3625RM-90	7314150120390	20	592
3625S-28	7314150183906	50	592
3625S-35	7314150183913	30	592
3625S-44	7314150183920	18	592
3625W-22	7314150120406	120	592
3625W-28	7314150120413	72	592
3625W-35	7314150120420	40	592
3625W-44	7314150120437	18	592
3625W-55	7314150120444	12	592
3625WL-22	7314150120451	10	592
3625WL-28	7314150120468	10	592
3625WL-35	7314150120475	10	592
3625WL-44	7314150120482	10	592
3625WL-55	7314150120499	6	592
3625WLH-22	7314150219025	50	592
3625WLH-28	7314150218981	50	592
3625WLH-35	7314150218998	80	592
3625WLH-44	7314150219001	50	592
3625WLH-55	7314150219018	16	592
3625Y-22	7314151074074	1	591
3625Y-27	7314151074081	1	591
3625Y-32	7314151074098	1	591
3625Y-35	7314151074104	1	591
3625Y-40	7314151074111	1	591
3625Y-50	7314151074128	1	591
3625Y-60	7314151074135	1	591
3625YL-22	7314151074159	1	591
3625YL-27	7314151074166	1	591



3625YL-32	7314151074173	1	591
3625YL-35	7314151074180	1	591
3625YL-40	7314151074197	1	591
3625YL-50	7314151074203	1	591
3625YL-60	7314151074210	1	591
363-32	7311518295578	1	260
3640-150-C	7314150180691	6	598
3640-200-C	7314150180714	5	598
3640-250-C	7314150180721	5	598
3640-300-C	7314150180738	6	598
3643-100	7314151074654	5	600
3643-120	7314151074678	5	600
3643-150	7314151074685	5	600
3644-120	7314151074708	5	600
3644-125	7314151074722	5	600
3644-130	7314151074746	5	600
3644-150	7314151074760	5	600
3644-165	7314151074777	5	600
3644-180	7314151074791	5	600
3644-200	7314151074807	5	600
3646-115	7314151074937	5	601
3646-125	7314151074944	5	601
3646-150	7314151074951	5	601
3646-165	7314151074968	5	601
3646-180	7314151074975	5	601
3646-200	7314151074982	5	601
3646/6	7314151074999	1	601
3654BMS/7	7314150220816	1	599
3654R	7314151075132	1	601
3656/10	7314151075279	1	602
3658A-2	7314151075293	5	601
3658A-3	7314151075309	5	601
3658A-4	7314151075316	5	601
3658A-5	7314151075323	5	601
3658A-6	7314151075330	5	601
3658A-8	7314151075347	5	601
3658A/6	7314151075354	1	602
3659-0.9	7314151075507	5	600
3659-1.4	7314151075514	5	600
3659-1.8	7314151597351	5	600
3659-2.4	7314151075538	5	600
3659-2.8	7314151597436	5	600
3659-3.4	7314151075552	5	600
3659-3.9	7314151075569	5	600
3659-6.0	7314151075576	5	600
3659/8	7314151075583	1	601
3659/8T	7314151472573	1	602
3680	7314151075835	1	361
3681-11	7314150132980	1	360
3681-16	7314150132997	1	360
3681-20	7314150133000	1	360
3683	7314151075866	1	360
3684-16	7314150133017	50	360
3684-18	7314150133024	1	360
3684-24	7314150133031	1	361
3684-30	7314150133048	1	361
369-BLADE	7311518016531	20	559
370-4	7311518296193	1	260
372-1.1/2	7314150133239	1	260
372-12	7314150133284	1	260
372-2.1/2	7314150133246	1	260
372-4	7314150133253	1	260
372-6	7314150133260	1	260
372-8	7314150133277	1	260
3733-2	7314151834371	5	600
3733-3	7314151834388	5	600
3733-4	7314151834395	5	600
3733-5	7314151834401	5	600
3733-6	7314151834418	5	600
3733S/5	7314150220809	1	602
3734-2	7314151834296	5	601
3734-3	7314151834319	5	601
3734-4	7314151834326	5	601
3734-5	7314151834333	5	601
3734-6	7314151834340	5	601
3734-8	7314151834357	5	601
3734BMS/7	7314150220755	1	604
3734N-10-150	7314150218110	10	601
3734N-2-150	7314150218042	10	601
3734N-3-150	7314150218059	10	601
3734N-4-150	7314150218066	10	601
3734N-5-150	7314150218073	10	601
3734N-6-150	7314150218080	10	601
3734N-7-150	7314150218097	10	601
3734N-8-150	7314150218103	10	601
3734N-9-150	7314150218127	10	601
3734NS/9	7314150218134	10	602
3734S/6	7314151834470	1	601
3735-4-120	7314151834265	5	600
3735-5-120	7314151834272	5	600
3735-5-150	7314151834289	5	600
3735N-2-100	7314150217953	10	600
3735N-4-120	7314150217960	10	600
3735N-5-120	7314150217977	10	600
3735N-6-150	7314150217984	10	600
3735N-8-150	7314150217991	10	600





3735NS/4	7314150218004	25	600
3736M-200	7314150220878	5	598
3736M-250	7314151834142	5	598
3736M-300	7314151834159	5	598
3736M-400	7314151834166	5	598
3736MH-250	7314151834173	2	599
3736MH-300	7314151834180	2	599
3736MH-400	7314151834197	2	599
3736S/6	7314151834463	1	598
3739-250	7314151834203	5	599
3739-300	7314151834210	5	599
3739-400	7314151834227	5	599
3739H-250	7314151834234	2	599
3739H-300	7314151834241	2	599
3739H-400	7314151834258	2	599
3740-100	7314151834005	5	598
3740-125	7314151834012	5	598
3740-150	7314151834029	1	598
3740-175	7314151834036	5	598
3740-200	7314151834043	5	598
3740-250	7314151834050	5	598
3740-300	7314151834067	5	598
3745-150	7314151834081	5	598
3745-175	7314151834098	5	598
3745-200	7314151834104	5	598
3745-250	7314151834111	5	598
3749-125	7314150457915	1	598
375-8	7311518296209	1	260
3750	7314151834128	5	598
3750H	7314151834135	1	599
3756-125	7314150457892	5	598
3756-150	7314150457908	50	598
38	7314150021734	1	587
38-12	7314151831264	5	321
38-16	7314151831271	5	321
38-20	7314151831288	2	321
38-24	7314151831295	1	321
38-8	7314151831257	5	321
380-10	7314150133178	1	259
380-14	7314150133185	1	259
380-18	7314150133192	1	259
380-24	7314150133208	1	259
380-36	7314150133215	1	259
380-48	7314150133222	1	259
3802-300-25-1.25-10	7311518111229	10	21
3802-300-25-1.25-14	7311518111236	10	21
3802-300-25-1.25-6	7311518143299	10	21
3802-300-32-1.60-10	7311518111274	10	21
3802-300-32-1.60-6	7311518111298	10	21
3802-350-25-1.25-10	7311518111335	10	21
3802-350-25-1.25-14	7311518111342	10	21
3802-350-25-1.25-6	7311518111359	10	21
3802-350-32-1.60-10	7311518111397	10	21
3802-350-32-1.60-14	7311518111403	10	21
3802-350-32-1.60-4	7311518111410	10	21
3802-350-32-1.60-6	7311518111427	10	21
3802-350-32-1.60-8	7311518140908	10	21
3802-400-25-1.25-10	7311518111496	10	21
3802-400-25-1.25-14	7311518111502	10	21
3802-400-25-1.25-6	7311518111519	10	21
3802-400-32-1.60-10	7311518111557	10	21
3802-400-32-1.60-14	7311518111564	10	21
3802-400-32-1.60-4	7311518111571	10	21
3802-400-32-1.60-6	7311518111588	10	21
3802-400-32-1.60-8	7311518111595	10	21
3802-400-38-2.00-10	7311518111649	10	21
3802-400-38-2.00-4	7311518111656	10	21
3802-400-38-2.00-6	7311518111663	10	21
3802-425-32-1.60-10	7311518111694	10	21
3802-425-32-1.60-6	7311518111700	10	21
3802-450-32-1.60-10	7311518111731	10	21
3802-450-32-1.60-14	7311518111748	10	21
3802-450-32-1.60-4	7311518111755	10	21
3802-450-32-1.60-6	7311518111762	10	21
3802-450-38-2.00-10	7311518111816	10	21
3802-450-38-2.00-10-KA	7311518111823	10	22
3802-450-38-2.00-4	7311518111830	10	21
3802-450-38-2.00-4-KA	7311518111847	10	22
3802-450-38-2.00-6	7311518111854	10	21
3802-450-38-2.00-6-KA	7311518111861	10	22
3802-450-38-2.00-8	7311518111878	10	21
3802-450-38-2.00-8-KA	7311518111885	10	22
3802-475-38-2.00-8	7311518113117	10	21
3802-500-38-2.00-10	7311518111953	10	21
3802-500-38-2.00-4	7311518111960	10	21
3802-500-38-2.00-6	7311518111977	10	21
3802-500-38-2.00-8	7311518113070	10	21
3802-500-45-2.25-10	7311518111984	10	21
3802-500-50-2.50-4	7311518112028	10	21
3802-500-50-2.50-4-KA	7311518112035	10	22
3802-500-50-2.50-6	7311518112042	10	21
3802-500-50-2.50-6-KA	7311518112059	10	22
3802-525-38-2.00-10	7311518112073	10	21
3802-525-38-2.00-6	7311518112097	10	21
3802-525-38-2.00-8	7311518112103	10	21
3802-550-38-2.00-6	7311518112158	10	21



3802-550-50-2.50-10	7311518112196	10	21
3802-550-50-2.50-4	7311518112202	10	21
3802-550-50-2.50-4-KA	7311518112219	10	22
3802-550-50-2.50-6	7311518112226	10	21
3802-550-50-2.50-8	7311518112240	5	21
3802-550-50-2.50-8-KA	7311518113315	10	22
3802-575-50-2.50-3-KA	7311518112301	10	21
3802-575-50-2.50-4	7311518112318	10	21
3802-575-50-2.50-4-KA	7311518112325	10	22
3802-575-50-2.50-6	7311518112332	10	21
3802-575-50-2.50-6-KA	7311518112349	10	22
3802-600-50-2.50-4	7311518112417	10	21
3802-600-50-2.50-6	7311518112431	10	21
3802-600-50-2.50-8	7311518112455	10	21
3802-650-50-2.50-4	7311518112509	5	21
3802-650-50-2.50-4-KA	7311518112523	5	22
3802-650-50-2.50-6	7311518112530	5	21
3802-650-50-2.50-6-KA	7311518112554	5	22
3802-700-50-2.50-2-KA	7311518112578	5	22
3802-700-50-2.50-3	7311518112585	5	21
3802-700-50-2.50-4	7311518112608	5	21
3802-700-50-2.50-4-KA	7311518112615	5	22
3802-700-50-2.50-6	7311518112622	5	21
3802-700-50-2.50-6-KA	7311518112639	5	22
3802-750-50-2.50-4	7311518112660	5	21
3802-750-50-2.50-6	7311518112677	5	21
3806-600-32	7311518018092	10	555
3809-300-25-1.25-10	7311518113711	10	20
3809-300-25-1.25-14	7311518113728	10	20
3809-300-32-1.60-10	7311518113735	10	20
3809-300-32-1.60-6	7311518113742	10	20
3809-350-25-1.25-10	7311518113759	10	20
3809-350-25-1.25-14	7311518113766	10	20
3809-350-25-1.25-6	7311518113773	10	20
3809-350-32-1.60-10	7311518113780	10	20
3809-350-32-1.60-14	7311518113797	10	20
3809-350-32-1.60-4	7311518113803	10	20
3809-350-32-1.60-6	7311518113810	10	20
3809-350-32-1.60-8	7311518113827	10	20
3809-350-32-2.00-10	7311518113834	10	20
3809-350-32-2.00-4	7311518113841	10	20
3809-350-32-2.00-6	7311518113858	10	20
3809-350-38-2.00-10	7311518113865	10	20
3809-350-38-2.00-6	7311518113889	10	20
3809-400-25-1.25-10	7311518178666	10	20
3809-400-32-1.60-10	7311518113896	10	20
3809-400-32-1.60-14	7311518113902	10	20
3809-400-32-1.60-4	7311518113919	10	20
3809-400-32-1.60-6	7311518113933	10	20
3809-400-32-1.60-8	7311518113940	10	20
3809-400-32-2.00-10	7311518113957	10	20
3809-400-32-2.00-4	7311518113964	10	20
3809-400-32-2.00-6	7311518113971	10	20
3809-400-32-2.00-6-KA	7311518158248	10	21
3809-400-32-2.00-8	7311518114152	10	20
3809-400-38-2.00-10	7311518113988	10	20
3809-400-38-2.00-4	7311518113995	10	20
3809-400-38-2.00-6	7311518114008	10	20
3809-425-32-1.60-10	7311518114015	10	20
3809-425-32-1.60-6	7311518197759	10	20
3809-450-32-1.60-10	7311518114022	10	20
3809-450-32-1.60-14	7311518114039	10	20
3809-450-32-1.60-4	7311518114046	10	20
3809-450-32-1.60-6	7311518114053	10	20
3809-450-32-2.00-10	7311518114060	10	20
3809-450-32-2.00-4	7311518114077	10	20
3809-450-32-2.00-6	7311518114084	10	20
3809-450-38-2.00-10	7311518114091	10	20
3809-450-38-2.00-10-KA	7311518114107	10	21
3809-450-38-2.00-4	7311518114114	10	20
3809-450-38-2.00-4-KA	7311518114121	10	21
3809-450-38-2.00-6	7311518114138	10	20
3809-450-38-2.00-6-KA	7311518114145	10	21
3809-450-38-2.00-8	7311518114176	10	20
3809-450-45-2.25-4	7311518114206	10	20
3809-450-45-2.25-6	7311518114213	10	20
3809-475-45-2.25-6	7311518114237	10	20
3809-500-38-2.00-10	7311518114244	10	20
3809-500-38-2.00-4	7311518114251	10	20
3809-500-38-2.00-6	7311518114268	10	20
3809-500-45-2.25-4	7311518114275	10	20
3809-500-45-2.25-6	7311518114299	10	20
3809-500-45-2.25-6-KA	7311518114305	10	21
3809-500-50-2.50-4	7311518114312	10	20
3809-500-50-2.50-4-KA	7311518114329	10	21
3809-500-50-2.50-6	7311518114336	10	20
3809-500-50-2.50-6-KA	7311518114343	10	21
3809-500-50-2.50-8	7311518114350	10	20
3809-525-38-2.00-10	7311518114367	10	20
3809-525-38-2.00-6	7311518114374	10	20
3809-525-45-2.25-4	7311518114381	10	20
3809-525-45-2.25-6	7311518114398	10	20
3809-550-45-2.25-4	7311518114411	10	20
3809-550-45-2.25-6	7311518114428	10	20
3809-550-50-2.50-4	7311518114435	10	20
3809-550-50-2.50-4-KA	7311518114442	10	21



3809-550-50-2.50-6	7311518114459	10	20
3809-550-50-2.50-6-KA	7311518114466	10	21
3809-575-45-2.25-4	7311518114473	10	20
3809-575-50-2.50-10-KA	7311518114497	10	21
3809-575-50-2.50-3	7311518114602	10	20
3809-575-50-2.50-3-KA	7311518114503	10	21
3809-575-50-2.50-4	7311518114510	10	20
3809-575-50-2.50-4-KA	7311518114527	10	21
3809-575-50-2.50-6	7311518114534	10	20
3809-575-50-2.50-6-KA	7311518114541	10	21
3809-600-38-2.00-6	7311518227579	10	20
3809-600-45-2.25-4	7311518172275	10	20
3809-600-45-2.25-6	7311518114558	10	20
3809-600-50-2.50-3	7311518114565	10	20
3809-600-50-2.50-4	7311518114572	10	20
3809-600-50-2.50-4-KA	7311518114589	10	21
3809-600-50-2.50-6	7311518114596	10	20
3809-600-50-2.50-6-KA	7311518114626	10	21
3809-650-50-2.50-3-KA	7311518114640	5	21
3809-650-50-2.50-4	7311518114657	5	20
3809-650-50-2.50-4-KA	7311518114664	5	21
3809-650-50-2.50-6	7311518114671	5	20
3809-650-50-2.50-6-KA	7311518114688	5	21
3809-700-50-2.50-3-KA	7311518114695	5	21
3809-700-50-2.50-4	7311518114701	5	21
3809-700-50-2.50-4-KA	7311518114718	5	21
3809-700-50-2.50-6	7311518114725	5	21
3809-700-50-2.50-6-KA	7311518114732	5	21
3809-750-50-2.50-4	7311518114749	5	21
3809-750-50-2.50-6	7311518234409	5	21
3815-200-2.0-32-1-03BW	7311518160258	1	17
3815-200-2.0-32-1-04BW	7311518160241	1	17
3815-225-2.0-32-1-03BW	7311518160319	1	17
3815-225-2.0-32-1-04BW	7311518158347	1	17
3815-225-2.0-32-1-05BW	7311518160302	1	17
3815-225-2.0-32-1-06C	7311518160296	1	17
3815-250-2.0-32-1-03BW	7311518160586	1	17
3815-250-2.0-32-1-03BWS	7311518167851	1	17
3815-250-2.0-32-1-04BW	7311518160579	1	17
3815-250-2.0-32-1-04BWS	7311518174392	1	17
3815-250-2.0-32-1-05BW	7311518158354	1	17
3815-250-2.0-32-1-06C	7311518160562	1	17
3815-250-2.0-40-2-03BW	7311518160340	1	18
3815-250-2.0-40-2-04BW	7311518174446	1	18
3815-250-2.0-40-2-05BW	7311518160333	1	18
3815-275-2.5-32-1-04BW	7311518160593	1	17
3815-275-2.5-32-1-04BWS	7311518185541	1	17
3815-275-2.5-32-1-05BW	7311518158361	1	17
3815-275-2.5-32-1-06C	7311518174590	1	17
3815-275-2.5-32-1-08C	7311518174583	1	17
3815-275-2.5-40-2-03BW	7311518176433	1	18
3815-275-2.5-40-2-04BW	7311518160623	1	18
3815-275-2.5-40-2-05BW	7311518158378	1	18
3815-275-2.5-40-2-06C	7311518160616	1	18
3815-275-2.5-40-2-08C	7311518160609	1	18
3815-300-2.5-32-1-04BW	7311518160630	1	17
3815-300-2.5-32-1-05BW	7311518158385	1	17
3815-300-2.5-32-1-05C	7311518174699	1	17
3815-300-2.5-32-1-06C	7311518174705	1	17
3815-300-2.5-32-1-08C	7311518174712	1	17
3815-315-2.5-32-1-04BW	7311518160210	1	17
3815-315-2.5-32-1-05BW	7311518160203	1	17
3815-315-2.5-32-1-06C	7311518160197	1	17
3815-315-2.5-32-1-08C	7311518160401	1	17
3815-315-2.5-40-2-04BW	7311518160456	1	18
3815-315-2.5-40-2-05BW	7311518160449	1	18
3815-315-3.0-40-2-06C	7311518174842	1	18
3815-350-2.5-32-1-04BW	7311518197605	1	17
3815-350-2.5-32-1-06C	7311518197612	1	17
3815-370-3.0-50-4-08C	7311518174989	1	18
3815-370-3.0-50-4-10C	7311518174996	1	18
3815-400-3.5-50-4-10C	7311518160494	1	18
3816-300	7311518015749	5	555
3818-300-PROG-100	7311518288105	100	555
3818-300-PROG-5P	7314150265589	10	555
383-6T	7311518128876	4	623
3830-102-C	7311518225612	1	138
3830-102-VIP	7311518042035	4	138
3830-105-C	7311518225629	1	138
3830-105-VIP	7311518042042	4	138
3830-108-C	7311518228521	1	138
3830-108-VIP	7311518042059	4	138
3830-111-C	7311518228538	1	138
3830-111-VIP	7311518042066	4	138
3830-114-C	7311518225636	1	138
3830-114-VIP	7311518042073	4	138
3830-121-C	7311518225643	1	138
3830-121-VIP	7311518042080	1	138
3830-127-C	7311518225650	1	138
3830-127-VIP	7311518042097	1	138
3830-133-C	7311518228545	1	138
3830-133-VIP	7311518042103	1	138
3830-14-C	7311518228347	1	138
3830-14-VIP	7311518041618	6	138
3830-140-C	7311518228552	1	138
3830-140-VIP	7311518042110	1	138



3830-146-C	7311518228569	1	138
3830-146-VIP	7311518042127	1	138
3830-152-C	7311518225667	1	138
3830-152-VIP	7311518042134	1	138
3830-16-C	7311518225353	1	138
3830-16-VIP	7311518041625	6	138
3830-168	7311518040659	1	138
3830-17-C	7311518228354	1	138
3830-17-VIP	7311518041632	6	138
3830-177-HIGH	7311518101329	1	138
3830-19-4P	7314150428557	1	138
3830-19-C	7311518225360	1	138
3830-19-VIP	7311518041649	6	138
3830-20-4P	7314150428601	1	138
3830-20-C	7311518225377	1	138
3830-20-VIP	7311518041656	6	138
3830-21-C	7311518228361	1	138
3830-21-VIP	7311518041663	6	138
3830-210	7311518040666	1	138
3830-22-4P	7314150428649	1	138
3830-22-C	7311518225384	1	138
3830-22-VIP	7311518041670	6	138
3830-24-C	7311518228378	1	138
3830-24-VIP	7311518041687	6	138
3830-25-4P	7314150428663	1	138
3830-25-C	7311518225391	1	138
3830-25-VIP	7311518041694	6	138
3830-27-4P	7314150428670	1	138
3830-27-C	7311518225407	1	138
3830-27-VIP	7311518041700	6	138
3830-29-4P	7314150428922	1	138
3830-29-C	7311518225414	1	138
3830-29-VIP	7311518041717	6	138
3830-30-4P	7314150433483	1	138
3830-30-C	7311518225421	1	138
3830-30-VIP	7311518041724	6	138
3830-32-4P	7314150428687	1	138
3830-32-C	7311518225438	1	138
3830-32-VIP	7311518041731	6	138
3830-33-C	7311518228385	1	138
3830-33-VIP	7311518041748	6	138
3830-35-4P	7314150428700	1	138
3830-35-C	7311518225445	1	138
3830-35-VIP	7311518041755	6	138
3830-37-C	7311518228392	1	138
3830-37-VIP	7311518041762	6	138
3830-38-C	7311518225452	1	138
3830-38-VIP	7311518041779	6	138
3830-40-C	7311518228408	1	138
3830-40-VIP	7311518041786	6	138
3830-41-C	7311518225469	1	138
3830-41-VIP	7311518041793	6	138
3830-43-C	7311518228415	1	138
3830-43-VIP	7311518041809	6	138
3830-44-C	7311518225476	1	138
3830-44-VIP	7311518041816	6	138
3830-46-C	7311518228422	1	138
3830-46-VIP	7311518041823	6	138
3830-48-C	7311518225483	1	138
3830-48-VIP	7311518041830	6	138
3830-50-C	7311518260873	1	138
3830-50-VIP	7311518260866	6	138
3830-51-C	7311518225490	1	138
3830-51-VIP	7311518041847	6	138
3830-52-C	7311518228439	1	138
3830-52-VIP	7311518041854	4	138
3830-54-C	7311518225506	1	138
3830-54-VIP	7311518041861	4	138
3830-55-C	7311518270919	1	138
3830-55-VIP	7311518270902	4	138
3830-56-C	7311518228446	1	138
3830-56-VIP	7311518152703	4	138
3830-57-C	7311518225513	1	138
3830-57-VIP	7311518041878	4	138
3830-59-C	7311518228453	1	138
3830-59-VIP	7311518041885	4	138
3830-60-C	7311518225520	1	138
3830-60-VIP	7311518041892	4	138
3830-62-VIP	7311518234645	4	138
3830-64-C	7311518225537	1	138
3830-64-VIP	7311518041908	4	138
3830-65-C	7311518228460	1	138
3830-65-VIP	7311518041915	4	138
3830-67-C	7311518225544	1	138
3830-67-VIP	7311518041922	4	138
3830-68-C	7311518228477	1	138
3830-68-VIP	7311518196530	4	138
3830-70-C	7311518225551	1	138
3830-70-VIP	7311518041939	4	138
3830-73-C	7311518228484	1	138
3830-73-VIP	7311518041946	4	138
3830-76-C	7311518225568	1	138
3830-76-VIP	7311518041953	4	138
3830-79-C	7311518228491	1	138
3830-79-VIP	7311518041960	4	138
3830-83-C	7311518225575	1	138



# 3830-83-VIP



3830-83-VIP	7311518041977	4	138
3830-86-C	7311518228507	1	138
3830-86-VIP	7311518041984	4	138
3830-89-C	7311518225582	1	138
3830-89-VIP	7311518041991	4	138
3830-92-C	7311518225599	1	138
3830-92-VIP	7311518042004	4	138
3830-95-C	7311518225605	1	138
3830-95-VIP	7311518042011	4	138
3830-98-C	7311518228514	1	138
3830-98-VIP	7311518042028	4	138
3832-102	7311518558567	4	145
3832-105	7311518558581	4	145
3832-108	7311518558604	4	145
3832-111	7311518558611	4	145
3832-114	7311518558628	4	145
3832-121	7311518558642	1	145
3832-127	7311518558666	1	145
3832-133	7311518558673	1	145
3832-14	7311518557744	6	145
3832-140	7311518558680	1	145
3832-146	7311518558697	1	145
3832-152	7311518558703	1	145
3832-16	7311518557768	6	145
3832-17	7311518557782	6	145
3832-19	7311518557805	6	145
3832-20	7311518557812	6	145
3832-21	7311518557829	6	145
3832-22	7311518557843	6	145
3832-24	7311518557867	6	145
3832-25	7311518557881	6	145
3832-27	7311518557904	6	145
3832-29	7311518557928	6	145
3832-30	7311518557942	6	145
3832-32	7311518557966	6	145
3832-33	7311518557980	6	145
3832-35	7311518558000	6	145
3832-37	7311518558024	6	145
3832-38	7311518558048	6	145
3832-40	7311518558062	6	145
3832-41	7311518558086	6	145
3832-43	7311518558109	6	145
3832-44	7311518558123	6	145
3832-46	7311518558147	6	145
3832-48	7311518558161	6	145
3832-51	7311518558185	6	145
3832-52	7311518558208	4	145
3832-54	7311518558222	4	145
3832-56	7311518558239	4	145
3832-57	7311518558246	4	145
3832-59	7311518558260	4	145
3832-60	7311518558284	4	145
3832-64	7311518558307	4	145
3832-65	7311518558321	4	145
3832-67	7311518558345	4	145
3832-68	7311518558352	4	145
3832-70	7311518558369	4	145
3832-73	7311518558383	4	145
3832-76	7311518558406	4	145
3832-79	7311518558420	4	145
3832-83	7311518558444	4	145
3832-86	7311518558468	4	145
3832-89	7311518558482	4	145
3832-92	7311518558505	4	145
3832-95	7311518558529	4	145
3832-98	7311518558543	4	145
3833-102-C	7314150263899	1	142
3833-105-C	7314150263905	1	142
3833-108-C	7314150263912	1	142
3833-109-C	7314150263929	1	142
3833-111-C	7314150263936	1	142
3833-114-C	7314150263943	1	142
3833-121-C	7314150263950	1	142
3833-127-C	7314150263967	1	142
3833-133-C	7314150401581	1	142
3833-140-C	7314150263974	1	142
3833-152-C	7314150263981	1	142
3833-159-C	7314150263998	1	142
3833-168	7314150413546	1	142
3833-177	7314150413539	1	142
3833-19-C	7314150263561	1	142
3833-20-C	7314150263578	1	142
3833-210	7314150413522	1	142
3833-22-C	7314150263585	1	142
3833-225	7314150413515	1	142
3833-25-C	7314150263592	1	142
3833-27-C	7314150263608	1	142
3833-29-C	7314150263615	1	142
3833-30-C	7314150263622	1	142
3833-32-C	7314150263639	1	142
3833-35-C	7314150263646	1	142
3833-38-C	7314150263653	1	142
3833-40-C	7314150263660	1	142
3833-41-C	7314150263677	1	142
3833-44-C	7314150263684	1	142
3833-48-C	7314150263691	1	142



3833-51-C	7314150263707	1	142
3833-54-C	7314150263714	1	142
3833-56-C	7314150314676	1	142
3833-57-C	7314150263721	1	142
3833-60-C	7314150263738	1	142
3833-62-C	7314150314683	1	142
3833-64-C	7314150263745	1	142
3833-65-C	7314150263752	1	142
3833-67-C	7314150263769	1	142
3833-68-C	7314150263776	1	142
3833-70-C	7314150263783	1	142
3833-71-C	7314150314690	1	142
3833-73-C	7314150263790	1	142
3833-74-C	7314150314706	1	142
3833-76-C	7314150263806	1	142
3833-77-C	7314150263813	1	142
3833-78-C	7314150314713	1	142
3833-79-C	7314150263820	1	142
3833-83-C	7314150263837	1	142
3833-86-C	7314150263844	1	142
3833-89-C	7314150263851	1	142
3833-92-C	7314150263868	1	142
3833-95-C	7314150263875	1	142
3833-98-C	7314150263882	1	142
3833-PROMO-42	7314150464951	1	143
3833-SET-101	7314150315383	1	143
3833-SET-201	7314150315406	1	143
3833-SET-202	7314150315420	1	143
3833-SET-203	7314150315444	1	143
3833-SET-204	7314150315468	1	143
3833-SET-205	7314150330874	1	144
3833-SET-207	7314150330898	1	144
3833-SET-208	7314150330904	1	144
3833-SET-301	7314150315376	1	144
3833-SET-302	7314150315390	1	144
3833-SET-303	7314150315413	1	144
3833-SET-304	7314150315437	1	145
3834-ADP	7311518454425	1	147
3834-ARBR-11152	7311518015596	1	146
3834-ARBR-11152-C	7311518225698	1	146
3834-ARBR-11152QC	7311518167967	1	146
3834-ARBR-11152QC-C	7311518225711	1	146
3834-ARBR-1130	7311518015572	4	146
3834-ARBR-1130-C	7311518228583	1	146
3834-ARBR-16152	7311518015602	1	146
3834-ARBR-16152QC	7311518453152	1	146
3834-ARBR-630	7311518015558	1	146
3834-ARBR-630-C	7311518228576	1	146
3834-ARBR-730	7311518167974	1	146
3834-ARBR-730-C	7311518225674	1	146
3834-ARBR-9100	7311518015589	1	146
3834-ARBR-9100-C	7311518228590	1	146
3834-ARBR-9100EL	7314150265077	1	145
3834-ARBR-9100ESM	7314150390458	1	145
3834-ARBR-9100QC	7311518249830	1	146
3834-ARBR-9100QC-C	7311518225704	1	146
3834-ARBR-930	7311518015565	1	146
3834-ARBR-930-C	7311518225681	1	146
3834-ARBR-930EL	7314150265053	1	145
3834-ARBR-930ESM	7314150390465	1	145
3834-ARBR-SD152QC	7311518203825	1	146
3834-ARBR-SD30	7311518203818	1	146
3834-DRL	7311518234638	1	146
3834-DRL-CT	7311518953201	1	146
3834-DRL-EL	7314150265114	1	146
3834-DRL-ES	7314150265091	1	146
3834-DRL-HSS-ES	7314150339396	1	146
3834-DRL-L	7314150265138	1	146
3834-ES	7311518454418	1	147
3834-EXT-1	7311518040673	1	146
3834-EXT-2	7311518168070	1	146
3834-M6X29-SET	7314150383450	1	147
3834-M8X10-SET	7314150383429	1	147
3834-M8X5-SET	7314150383443	1	147
3834-M8X6-SET	7314150383436	1	147
3834-PROMO-122	7314150432059	1	138
3834-PROMO-122-76	7314150459193	1	139
3834-PROMO-82	7314150432042	1	138
3834-SET-103	7314150134908	1	142
3834-SET-152	7314150255658	1	142
3834-SET-42	7311518241988	1	139
3834-SET-53	7314150127153	1	139
3834-SET-61	7311518266431	1	139
3834-SET-62	7311518228040	1	139
3834-SET-62-16/50	7311518258887	1	140
3834-SET-65-16/51	7311518159900	1	140
3834-SET-65-22/64	7311518159917	1	140
3834-SET-72	7311518044992	1	140
3834-SET-72-35/83	7314150444229	1	139
3834-SET-73	7311518254339	1	140
3834-SET-73-22/68	7314150134809	1	140
3834-SET-77	7314150235919	1	141
3834-SET-84-ES	7314150470587	1	141
3834-SET-86	7311518224295	1	141
3834-SET-87	7311518181772	1	141
3834-SET-92	7311518044985	1	141



3834-SET-93	7314150414741	1	141
3834-SET-94	7311518166458	1	142
3834-SET-95	7311518159894	1	142
3834-UPSIZE	7314150344567	1	146
3835-SET-64	7314150423309	1	145
3835-SET-711	7314150465835	1	145
384-5T	7311518159795	4	623
384-6T	7311518002039	4	623
3845-18-10P	7311518101602	1	147
3845-24-10P	7311518101619	1	147
3845-32-10P	7311518101626	1	147
385-6T	7311518002053	4	623
3851-10-0.6-10/14	7311518182717	1	12
3851-10-0.6-H-4	7311518282776	1	12
3851-10-0.6-H-6	7311518282806	1	12
3851-10-0.6-HA-4	7314150139309	1	12
3851-10-0.9-10/14	7311518182823	1	12
3851-10-0.9-H-4	7311518282851	1	12
3851-10-0.9-H-6	7311518282868	1	12
3851-10-0.9-R-14	7314150312399	1	12
3851-13-0.5-10/14	7311518282813	1	12
3851-13-0.5-14/18	7311518282790	1	12
3851-13-0.5-H-4	7311518292072	1	12
3851-13-0.5-R-10	7311518331306	1	12
3851-13-0.5-R-14	7311518331320	1	12
3851-13-0.5-R-18	7311518331344	1	12
3851-13-0.5-R-24	7311518282820	1	12
3851-13-0.6-10/14	7311518183271	1	12
3851-13-0.6-5/8	7311518183233	1	12
3851-13-0.6-6/10	7311518183240	1	12
3851-13-0.6-8/12	7311518185572	1	12
3851-13-0.6-H-3	7311518282769	1	12
3851-13-0.6-H-4	7311518282745	1	12
3851-13-0.6-H-6	7311518282738	1	12
3851-13-0.6-HA-4	7311518282752	1	12
3851-13-0.6-HA-6	7311518282561	1	13
3851-13-0.6-R-10	7311518183110	1	12
3851-13-0.6-R-14	7311518183158	1	12
3851-13-0.6-R-18	7311518183196	1	12
3851-13-0.9-10/14	7311518183868	1	12
3851-13-0.9-6/10	7311518183585	1	12
3851-13-0.9-H-3	7311518282936	1	12
3851-13-0.9-H-4	7311518282943	1	12
3851-13-0.9-H-6	7311518286125	1	12
3851-13-0.9-HA-4	7311518281052	1	13
3851-13-0.9-R-14	7311518182359	1	12
3851-13-0.9-R-6	7311518183301	1	12
3851-16-0.5-H-3	7314150168989	1	12
3851-20-0.9-10/14	7311518282585	1	12
3851-20-0.9-4/6	7311518183905	1	12
3851-20-0.9-5/8	7311518183929	1	12
3851-20-0.9-6/10	7311518183936	1	12
3851-20-0.9-8/12	7311518282578	1	12
3851-20-0.9-H-3	7314150399515	1	12
3851-20-0.9-H-4	73141503998294	1	12
3851-20-0.9-HA-3	7311518282646	1	13
3851-20-0.9-HA-4	7311518282653	1	13
3851-20-0.9-R-18	7311518332587	1	12
3851-27-0.9-10/14	7311518165475	1	13
3851-27-0.9-2/3	7311518126377	1	13
3851-27-0.9-3/4	7311518126384	1	13
3851-27-0.9-4/6	7311518126391	1	13
3851-27-0.9-5/8	7311518126407	1	13
3851-27-0.9-6/10	7311518126414	1	13
3851-27-0.9-8/12	7311518160692	1	13
3851-27-0.9-HA-3	7311518282684	1	13
3851-27-0.9-HA-4	7314150398317	1	13
3851-27-0.9-P-3	7311518157135	1	12
3851-27-0.9-P-4	7311518157661	1	12
3851-27-0.9-R-6	7311518126353	1	12
3851-34-1.1-2/3	7311518126476	1	13
3851-34-1.1-3/4	7311518126483	1	13
3851-34-1.1-4/6	7311518126490	1	13
3851-34-1.1-5/8	7311518126506	1	13
3851-34-1.1-6/10	7311518165505	1	13
3851-41-1.3-1.4/2	7311518211837	1	13
3851-41-1.3-2/3	7311518126568	1	13
3851-41-1.3-3/4	7311518126575	1	13
3851-41-1.3-4/6	7311518126582	1	13
3851-41-1.3-5/8	7311518262488	1	13
3851-54-1.3-1.4/2	7314150459360	1	13
3851-54-1.3-2/3	7311518163716	1	13
3851-54-1.3-4/6	7311518168025	1	13
3851-54-1.3-8/12	7314150358311	1	13
3851-54-1.6-1.4/2	7311518211431	1	13
3851-54-1.6-1/1.4	7311518188542	1	13
3851-54-1.6-2/3	7311518126636	1	13
3851-54-1.6-3/4	7311518126643	1	13
3851-54-1.6-4/6	7314150398539	1	13
3851-6-0.6-10/14	7311518180652	1	12
3851-6-0.6-H-6	7311518282707	1	12
3851-6-0.9-10/14	7311518180768	1	12
3851-6-0.9-H-6	7311518282714	1	12
3851-67-1.6-7/1	7311518200909	1	13
3851-67-1.6-1.4/2	7314150273317	1	13
3851-67-1.6-1/1.4	7311518178840	1	13



3851-67-1.6-2/3	7311518335243	1	13
3851-67-1.6-3/4	7311518328597	1	13
3851-67-1.6-4/6	7311518194963	1	13
3851-80-1.6-7/1	7311518255367	1	13
3851-80-1.6-1.4/2	7311518255350	1	13
3851-80-1.6-1/1.4	7311518197377	1	13
3851-80-1.6-4/6	7314150393657	1	13
3853-20-0.9-5/7-VS	7311518331689	1	14
3853-20-0.9-8/11-VS	7311518331702	1	14
3853-27-0.9-3/4	7311518285395	1	14
3853-27-0.9-4/6	7311518183998	1	14
3853-27-0.9-5/7-VS	7311518331115	1	14
3853-27-0.9-5/8	7311518202118	1	14
3853-27-0.9-8/11-VS	7311518331122	1	14
3853-34-1.1-2/3	7311518282875	1	14
3853-34-1.1-3/4	7311518184094	1	14
3853-34-1.1-4/6	7311518184087	1	14
3853-34-1.1-5/7-VS	7311518331726	1	14
3853-34-1.1-5/8	7311518202149	1	14
3853-34-1.1-8/11-VS	7311518331719	1	14
3853-41-1.3-2/3	7311518282882	1	14
3853-41-1.3-2/3-W	7314150370115	1	14
3853-41-1.3-2/3-WS	7314150415113	1	15
3853-41-1.3-3/4	7311518185770	1	14
3853-41-1.3-3/4-W	7311518338053	1	14
3853-41-1.3-3/4-WS	7314150415120	1	15
3853-41-1.3-4/6	7311518184100	1	14
3853-41-1.3-5/7-VS	7311518331733	1	14
3853-41-1.3-5/8	7311518202286	1	14
3853-54-1.3-3/4	7311518184124	1	14
3853-54-1.3-3/4-W	7314150352876	1	14
3853-54-1.3-5/8	7311518197568	1	14
3853-54-1.6-2/3	7311518282899	1	14
3853-54-1.6-2/3-W	7311518338077	1	14
3853-54-1.6-2/3-WS	7314150415151	1	15
3853-54-1.6-3/4	7311518216757	1	14
3853-54-1.6-3/4-W	7311518338091	1	14
3853-54-1.6-3/4-WS	7314150415168	1	15
3853-54-1.6-4/6	7311518222055	1	14
3853-67-1.6-2/3	7311518282905	1	14
3853-67-1.6-2/3-W	7311518338114	1	14
3853-67-1.6-2/3-WS	7314150415175	1	15
3853-67-1.6-3/4	7311518282912	1	15
3853-67-1.6-3/4-W	7311518338138	1	15
3853-67-1.6-3/4-WS	7314150415182	1	15
3853-67-1.6-5/8-W	7311518338152	1	15
3854-27-0.9-PHX-2/3	7314150440603	1	13
3854-27-0.9-PHX-3/4	7314150440610	1	13
3854-27-0.9-PHX-4/6	7314150440627	1	13
3854-27-0.9-PQ-3/4	7314150137480	1	14
3854-27-0.9-PQ-4/6	7314150197828	1	14
3854-34-1.1-PHX-1.4/2	7314150440634	1	13
3854-34-1.1-PHX-2/3	7314150440641	1	13
3854-34-1.1-PHX-3/4	7314150440658	1	13
3854-34-1.1-PHX-4/6	7314150440665	1	13
3854-34-1.1-PQ-2/3	7311518282726	1	14
3854-34-1.1-PQ-3/4	7314150135813	1	14
3854-34-1.1-PQ-4/6	7314150197835	1	14
3854-41-1.3-PHX-1.4/2	7314150440672	1	13
3854-41-1.3-PHX-2/3	7314150440689	1	13
3854-41-1.3-PHX-3/4	7314150440696	1	13
3854-41-1.3-PHX-4/6	7314150440702	1	13
3854-41-1.3-PQ-1.4/2	7314150129355	1	14
3854-41-1.3-PQ-2/3	7311518280604	1	14
3854-41-1.3-PQ-3/4	7311518282950	1	14
3854-41-1.3-PQ-4/6	7314150197842	1	14
3854-54-1.3-PHX-1.4/2	7314150440719	1	13
3854-54-1.3-PHX-2/3	7314150440733	1	13
3854-54-1.3-PHX-3/4	7314150440740	1	13
3854-54-1.6-PHX-7/1	7314150440757	1	13
3854-54-1.6-PHX-1.4/2	7314150440771	1	13
3854-54-1.6-PHX-1/1.4	7314150440764	1	13
3854-54-1.6-PHX-2/3	7314150440788	1	13
3854-54-1.6-PHX-3/4	7314150440795	1	13
3854-54-1.6-PQ-9/1.2	7314150133857	1	14
3854-54-1.6-PQ-1.4/2	7314150127092	1	14
3854-54-1.6-PQ-2/3	7311518265137	1	14
3854-54-1.6-PQ-3/4	7311518282929	1	14
3854-54-1.6-PQ-4/6	7311518330637	1	14
3854-67-1.6-PHX-7/1	7314150440801	1	13
3854-67-1.6-PHX-1.4/2	7314150440825	1	13
3854-67-1.6-PHX-1/1.4	7314150440818	1	13
3854-67-1.6-PHX-2/3	7314150440832	1	13
3854-67-1.6-PQ-9/1.2	7314150133888	1	14
3854-67-1.6-PQ-1.4/2	7314150133901	1	14
3854-67-1.6-PQ-2/3	7311518290160	1	14
3854-67-1.6-PQ-3/4	7311518330644	1	14
3854-80-1.6-PHX-7/1	7314150440849	1	13
3854-80-1.6-PHX-1.4/2	7314150440863	1	13
3854-80-1.6-PHX-1/1.4	7314150440856	1	13
3854-80-1.6-PQ-9/1.2	7314150133895	1	14
3854-80-1.6-PQ-1.4/2	7314150215966	1	14
3854-80-1.6-PQ-2/3	7314150215973	1	14
3854-80-1.6-PQ-3/4	7311518330651	1	14
3857-13-0.5-EZ-S	7311518331849	1	12
3857-13-0.6-EZ-L	7311518264789	1	12





3857-13-0.6-EZ-M	7311518264772	1	12
3857-13-0.6-EZ-M-3P1140	7314150321100	1	153
3857-13-0.6-EZ-M-3P690	7314150325641	1	153
3857-13-0.6-EZ-M-3P730	7314150325658	1	153
3857-13-0.6-EZ-M-3P835	7314150325665	1	153
3857-13-0.6-EZ-M-3P900	7314150321094	1	153
3857-13-0.6-EZ-S	7311518264765	1	12
3857-20-0.9-EZ-L	7311518264819	1	12
3857-20-0.9-EZ-M	7311518264802	1	12
3857-20-0.9-EZ-S	7311518264796	1	12
3857-27-0.9-EZ-L	7311518264840	1	12
3857-27-0.9-EZ-M	7311518264833	1	12
3857-27-0.9-EZ-S	7311518264826	1	12
3857-34-1.1-EZ-L	7311518264871	1	12
3857-34-1.1-EZ-M	7311518264864	1	12
3857-34-1.1-EZ-S	7311518264857	1	12
3858-34-1.1-PHX-1.4/2	7314150441198	1	14
3858-34-1.1-PHX-2/3	7314150441204	1	14
3858-34-1.1-PHX-3/4	7314150441211	1	14
3858-41-1.3-PHX-1.4/2	7314150441013	1	14
3858-41-1.3-PHX-2/3	7314150441020	1	14
3858-41-1.3-PHX-3/4	7314150441037	1	14
3858-41-1.3-PQ-1.4/2	7314150395583	1	14
3858-41-1.3-PQ-2/3	7314150395590	1	14
3858-41-1.3-PQ-3/4	7314150395606	1	14
3858-54-1.3-PHX-1.4/2	7314150441068	1	14
3858-54-1.3-PHX-2/3	7314150441044	1	14
3858-54-1.3-PHX-3/4	7314150441051	1	14
3858-54-1.6-PHX-7/1	7314150441075	1	14
3858-54-1.6-PHX-1.4/2	7314150441099	1	14
3858-54-1.6-PHX-1/1.4	7314150441082	1	14
3858-54-1.6-PHX-2/3	7314150441105	1	14
3858-54-1.6-PHX-3/4	7314150441112	1	14
3858-54-1.6-PQ-9/1.2	7314150395613	1	14
3858-54-1.6-PQ-1.4/2	7314150395620	1	14
3858-54-1.6-PQ-2/3	7314150395637	1	14
3858-67-1.6-PHX-7/1	7314150441129	1	14
3858-67-1.6-PHX-1.4/2	7314150441143	1	14
3858-67-1.6-PHX-1/1.4	7314150441136	1	14
3858-67-1.6-PHX-2/3	7314150441150	1	14
3858-67-1.6-PQ-9/1.2	7314150395644	1	14
3858-67-1.6-PQ-1.4/2	7314150395651	1	14
3858-80-1.6-PHX-7/1	7314150441167	1	14
3858-80-1.6-PHX-1.4/2	7314150441181	1	14
3858-80-1.6-PHX-1/1.4	7314150441174	1	14
3858-80-1.6-PQ-9/1.2	7314150395668	1	14
386-6T	7311518152017	4	623
3860-100-1.1-TMC-1.4/2	7314150336968	1	15
3860-27-0.9-TCA-3	7311518330750	1	15
3860-27-0.9-TC-D-3	7314150413010	1	15
3860-27-0.9-TC-D-3/4	7314150413027	1	15
3860-27-0.9-TCZ-3/4	7314150263493	1	15
3860-34-1.1-TCA-0.8/1.0	7314150341658	1	15
3860-34-1.1-TCA-2	7311518330767	1	15
3860-34-1.1-TCA-2/3	7311518330781	1	15
3860-34-1.1-TCA-3	7311518330774	1	15
3860-34-1.1-TC-D-2/3	7314150413034	1	15
3860-34-1.1-TC-D-3/4	7314150413041	1	15
3860-34-1.1-TC-D-3/4-W	7314150413058	1	15
3860-34-1.1-TCZ-2/3	7311518330880	1	15
3860-34-1.1-TCZ-3/4	7311518330897	1	15
3860-41-1.3-TCA-1.4/2	7311518330620	1	15
3860-41-1.3-TCA-2/3	7311518330675	1	15
3860-41-1.3-TC-D-1.4/2	7314150413065	1	15
3860-41-1.3-TC-D-1.9/2.1	7314150413072	1	15
3860-41-1.3-TC-D-2/3	7314150413089	1	15
3860-41-1.3-TC-D-3/4	7314150413096	1	15
3860-41-1.3-TCZ-2/3	7311518330903	1	15
3860-41-1.3-TCZ-3/4	7311518330910	1	15
3860-41-1.3-TMC-1.4/2	7314150129379	1	15
3860-41-1.3-TMC-2/3	7311518330224	1	15
3860-54-1.3-TMC-1.4/2	7314150288748	1	15
3860-54-1.3-TMC-2/3	7311518335267	1	15
3860-54-1.6-TCA-1.4/2	7311518330798	1	16
3860-54-1.6-TCA-1/1.25	7311518330934	1	16
3860-54-1.6-TCD-1.4/2	7314150413119	1	15
3860-54-1.6-TCD-1.9/2.1	7314150413133	1	15
3860-54-1.6-TCD-2/3	7314150413140	1	15
3860-54-1.6-TCD-3/4	7314150413157	1	15
3860-54-1.6-TMC-7/1	7314150263431	1	15
3860-54-1.6-TMC-1.4/2	7314150137978	1	15
3860-54-1.6-TMC-1/1.25	7314150154340	1	15
3860-54-1.6-TMC-2/3	7314150189366	1	15
3860-67-1.6-TCD-1.4/2	7314150413164	1	15
3860-67-1.6-TCD-1/1.25	7314150413171	1	15
3860-67-1.6-TMC-1.4/2	7314150137985	1	15
3860-67-1.6-TMC-1/1.25	7314150154364	1	15
3860-67-1.6-TMC-2/3	7314150189359	1	15
3860-80-1.1-TMC-1.4/2	7314150382767	1	15
3860-80-1.6-TCD-5/0.8	7314150413188	1	15
3860-80-1.6-TMC-7/1	7314150154371	1	15
3860-80-1.6-TMC-1.4/2	7314150182992	1	15
3860-80-1.6-TMC-1/1.25	7314150182336	1	15
3860-80-1.6-TMC-2/3	7314150215959	1	15
3861-27-0.9-H-1.33	7311518329716	1	18
3861-34-0.9-H-1.15	7311518258894	1	18



3861-34-1.1-H-1.15	7311518258900	1	18
3861-41-1.1-H-1.15	7314150129294	1	18
3861-54-1.1-H-1.15	7314150129270	1	18
3862-33-0.9-H-1.15	7314150320325	1	18
3862-33-1.1-H-1.15	7311518331269	1	18
3862-40-1.1-H-1.15	7311518331283	1	18
3868-27-0.9-TSX-3/4	7311518329693	1	16
3868-34-1.1-TSS-2/3	7311518329266	1	16
3868-34-1.1-TSX-2	7311518203016	1	16
3868-34-1.1-TSX-2/3	7311518255343	1	16
3868-34-1.1-TSX-3/4	7311518232375	1	16
3868-41-1.3-TSS-1.4/2	7311518243142	1	16
3868-41-1.3-TSS-2/3	7311518270643	1	16
3868-41-1.3-TSX-1.4/2	7311518214210	1	16
3868-41-1.3-TSX-1.6	7311518203092	1	16
3868-41-1.3-TSX-2	7311518203085	1	16
3868-41-1.3-TSX-2/3	7311518232382	1	16
3868-41-1.3-TSX-3/4	7311518232399	1	16
3868-54-1.3-TSX-1.4/2	7311518214876	1	16
3868-54-1.3-TSX-2/3	7314150416394	1	16
3868-54-1.6-TSS-1.4/2	7311518243166	1	16
3868-54-1.6-TSS-1/1.25	7311518243173	1	16
3868-54-1.6-TSS-2/3	7311518280383	1	16
3868-54-1.6-TSX-1.4/2	7311518214869	1	16
3868-54-1.6-TSX-1.6	7311518203108	1	16
3868-54-1.6-TSX-1/1.25	7311518213114	1	16
3868-54-1.6-TSX-2/3	7311518232405	1	16
3868-54-1.6-TSX-3/4	7311518270360	1	16
3868-67-1.6-TSS-7/1	7311518274115	1	16
3868-67-1.6-TSS-1.4/2	7311518243197	1	16
3868-67-1.6-TSS-1/1.25	7311518243180	1	16
3868-67-1.6-TSS-2/3	7311518328825	1	16
3868-67-1.6-TSX-7/1	7311518212865	1	16
3868-67-1.6-TSX-1.4/2	7311518265496	1	16
3868-67-1.6-TSX-1/1.25	7311518213084	1	16
3868-67-1.6-TSX-2/3	7314150203536	1	16
3868-80-1.1-TSX-3/4	7311518330200	1	16
3868-80-1.6-TSS-7/1	7314150216253	1	16
3868-80-1.6-TSS-1.4/2	7314150203529	1	16
3868-80-1.6-TSS-2/3	7314150398553	1	16
3868-80-1.6-TSX-7/1	7311518212872	1	16
3868-80-1.6-TSX-1/1.25	7314150277278	1	16
3868-80-1.6-TSX-2/3	7314150203543	1	16
3869-13-0.9-TS-3	7311518200589	1	17
3869-20-0.9-TS-3	7311518177300	1	17
3869-20-0.9-TS-4	7311518197742	1	17
3869-27-0.9-TS-3	7311518177348	1	17
3869-27-0.9-TS-4	7311518182595	1	17
3869-34-1.1-TS-2	7314150330508	1	17
3869-34-1.1-TS-3	7311518177355	1	17
3870-BANDCALC	7311518238926	1	19
3870-BRUSH-100-10	7311518269876	4	19
3870-BRUSH-100-10-HEX	7311518333935	4	19
3870-BRUSH-100-12	7311518269883	4	19
3870-BRUSH-100-13	7314150321131	1	19
3870-BRUSH-60-6	7311518279523	4	19
3870-BRUSH-80-10	7311518278311	4	19
3870-BRUSH-80-6	7311518269906	4	19
3870-BRUSH-80-8	7311518269890	4	19
3870-REFRACTOMETER	7311518192129	1	19
3870-TACHO METER	7311518145620	1	19
3870-TENSION METER	7311518145637	1	19
3870-WEDGE-3	7311518262747	1	20
3870-WHEEL	7314150398652	1	20
3875-BP1	7314150187737	8	468
3875-BP2	7314150187744	8	468
3875-GLOVE	7314150353330	5	484
3875-HB10	7314150349777	1	467
3875-HB100	7314150289783	1	467
3875-HB30	7314150187720	1	467
3875-HB60	7314150187713	1	467
3875-LY1	7314150191253	8	466
3875-LY10	7314150315062	1	467
3875-LY2	7314150191260	8	466
3875-LY3	7314150191284	8	466
3875-LY4	7314150262878	8	466
3875-LY60	7314150436521	1	466
3875-LY70	7314150442751	1	466
3875-LY8	7314150309689	1	467
3875-LY9	7314150313310	1	466
3875-MHP4	7314150187805	1	468
3875-MHP6	7314150187812	1	468
3875-QL1	7314150191307	8	466
3875-QLR1	7314150194797	1	466
3875-RL1	7314150194780	1	466
3875-RL2	7314150312948	1	466
3875-SB70	7314150326839	1	466
3875-WL1	7314150191291	8	466
3881-100-1.6-THS-7/1	7311518329617	1	17
3881-34-1.1-THQ-2/3	7311518265793	1	16
3881-41-1.3-THQ-1.4/2	7314150129447	1	16
3881-41-1.3-THQ-2/3	7314150129454	1	16
3881-41-1.3-THS-1.4/2	7311518273712	1	17
3881-54-1.6-THQ-1.4/2	7314150128860	1	17
3881-54-1.6-THQ-2/3	7314150138739	1	17
3881-54-1.6-THS-1.4/2	7314150138784	1	17



3881-54-1.6-THS-1/1.25	7311518269050	1	17
3881-67-1.6-THQ-1.4/2	7314150120369	1	17
3881-67-1.6-THQ-1/1.25	7314150180097	1	17
3881-67-1.6-THQ-2/3	7311518328832	1	17
3881-67-1.6-THS-1.4/2	7314150138791	1	17
3881-67-1.6-THS-1/1.25	7311518269043	1	17
3881-67-1.6-THS-2/3	7311518328849	1	17
3881-80-1.6-THQ-7/1	7311518332938	1	17
3881-80-1.6-THQ-1.4/2	7311518328856	1	17
3881-80-1.6-THQ-1/1.25	7314150133918	1	17
3881-80-1.6-THQ-2/3	7311518328863	1	17
3881-80-1.6-THS-7/1	7311518279202	1	17
3881-80-1.6-THS-1.4/2	7314150195312	1	17
3881-80-1.6-THS-2/3	7314150215942	1	17
38A-08	7314150433469	25	321
38A-10	7314150431564	25	321
38A-12	7314150237944	1	321
38A-15	7314150237951	25	321
38A-21	7314150237968	1	321
38A-26	7314150237975	1	321
38C-26	7314150237982	1	321
39-24	7314151831301	1	321
3905-250-24-100	7311518299255	100	555
3905-300-14-100	7311518292201	100	555
3905-300-18-100	7311518292218	100	555
3905-300-24-100	7311518292225	100	555
3905-300-24-2P	7311518299248	10	555
3905-300-32-100	7311518292232	100	555
3906-250-18-100	7311518250997	100	555
3906-250-18-5P	7314150265534	10	555
3906-250-24-100	7311518251000	100	555
3906-250-24-5P	7314150265541	10	555
3906-250-32-100	7311518251017	100	555
3906-250-32-5P	7314150265558	10	555
3906-300-14-100	7311518233563	100	555
3906-300-14-10P	7311518233693	10	555
3906-300-14-5P	7314150265565	10	555
3906-300-18-100	7311518233570	100	555
3906-300-18-10P	7311518233723	10	555
3906-300-18-2P	7311518233617	10	555
3906-300-18-5P	7314150265572	10	555
3906-300-24-100	7311518233587	100	555
3906-300-24-10P	7311518233730	10	555
3906-300-24-2P	7311518233624	10	555
3906-300-24-5P	7311518237417	10	555
3906-300-32-100	7311518233594	100	555
3906-300-32-10P	7311518233747	10	555
3906-300-32-2P	7311518233631	10	555
3906-300-32-5P	7311518237424	10	555
3906-300-3P	7311518233754	10	555
3911-115-T41-I	7314150454570	50	150
3911-115-T41-IM	7314150454587	50	150
3911-115-T42-M	7314150454679	25	150
3911-1151T41-IM	7314150460595	50	150
3911-125-T41-I	7314150454594	50	150
3911-125-T41-IM	7314150454600	50	150
3911-125-T42-M	7314150454686	25	150
3911-150-T41-I	7314150454624	50	150
3911-150-T42-M	7314150454709	25	151
3911-180-T41-I	7314150454631	50	150
3911-180-T41-IM	7314150454655	50	150
3911-180-T42-M	7314150454693	25	151
3911-230-T41-I	7314150454648	50	150
3911-230-T41-IM	7314150454662	50	150
3911-230-T42-M	7314150454716	50	151
3912-115-T41-IM	7314150454808	50	150
3912-115-T42-ST	7314150454723	25	151
3912-125-T41-IM	7314150454815	50	150
3912-125-T42-ST	7314150454730	25	151
3912-180-T42-ST	7314150454747	25	151
3912-230-T42-ST	7314150454754	50	151
3916-115-10P-CE	7314150455348	100	151
3916-115-10S-UE	7314150455270	100	151
3916-125-10P-CE	7314150455355	100	151
3916-125-10S-UE	7314150455287	100	151
3916-150-10S-UE	7314150455294	50	151
3916-180-10S-UE	7314150455300	50	151
3916-230-10L-RC	7314150455232	25	151
3916-230-10S-UE	7314150455317	25	151
3917-115-7S-C	7314150455324	100	151
3917-115-7S-U	7314150455249	100	151
3917-125-7S-C	7314150455331	100	151
3917-125-7S-U	7314150455256	100	151
3917-230-7S-U	7314150455263	25	151
3921-115-T27-IM	7314150454617	25	151
3921-125-T27-IM	7314150454761	25	151
3921-150-T27-IM	7314150454778	25	151
3921-180-T27-IM	7314150454785	25	151
3921-230-T27-IM	7314150454792	25	151
3926-115IM-C120	7314150454860	20	151
3926-115IM-C40	7314150454839	20	151
3926-115IM-C60	7314150454846	20	151
3926-115IM-C80	7314150454853	20	151
3926-125IM-C120	7314150454914	20	151
3926-125IM-C40	7314150454884	20	151
3926-125IM-C60	7314150454891	20	151



3926-125IM-C80	7314150454907	20	151
3927-115IM-P120	7314150454952	20	151
3927-115IM-P40	7314150454921	20	151
3927-115IM-P60	7314150454938	20	151
3927-115IM-P80	7314150454945	20	151
3927-125IM-P120	7314150455010	20	151
3927-125IM-P40	7314150454976	20	151
3927-125IM-P60	7314150454983	20	151
3927-125IM-P80	7314150455003	20	151
3940-100-14-SC-2P	7314150364466	5	148
3940-100-14-SC-5P	7314150364473	5	148
3940-100-14-ST-10P	7314150364336	1	148
3940-100-14-ST-2P	7314150364312	5	148
3940-100-14-ST-5P	7314150364329	5	148
3940-100-18-SC-2P	7314150364442	5	148
3940-100-18-SC-5P	7314150364459	5	148
3940-100-18-ST-10P	7314150364367	1	148
3940-100-18-ST-2P	7314150364343	5	148
3940-100-18-ST-5P	7314150364350	5	148
3940-100-24-SC-2P	7314150364558	5	148
3940-100-24-SC-5P	7314150364565	5	148
3940-100-24-ST-10P	7314150364435	1	148
3940-100-24-ST-2P	7314150364411	5	148
3940-100-24-ST-5P	7314150364428	5	148
3940-150-10-HST-10P	7314150364039	1	148
3940-150-10-HST-2P	7314150364015	5	148
3940-150-10-HST-5P	7314150364022	5	148
3940-150-10-ST-100P	7314150362196	1	148
3940-150-10-ST-10P	7314150362189	1	148
3940-150-10-ST-2P	7314150362165	5	148
3940-150-10-ST-5P	7314150362411	5	148
3940-150-14-HST-10P	7314150362370	1	148
3940-150-14-HST-2P	7314150362325	5	148
3940-150-14-HST-5P	7314150362363	5	148
3940-150-14-ST-100P	7314150364183	1	148
3940-150-14-ST-10P	7314150364176	1	148
3940-150-14-ST-2P	7314150364152	5	148
3940-150-14-ST-5P	7314150364169	5	148
3940-150-18-HST-10P	7314150364060	1	148
3940-150-18-HST-2P	7314150364046	5	148
3940-150-18-HST-5P	7314150364053	5	148
3940-150-18-ST-100P	7314150364107	1	148
3940-150-18-ST-10P	7314150364091	1	148
3940-150-18-ST-2P	7314150364071	5	148
3940-150-18-ST-5P	7314150364084	5	148
3940-150-24-ST-100P	7314150364404	1	148
3940-150-24-ST-10P	7314150364398	1	148
3940-150-24-ST-2P	7314150364374	5	148
3940-150-24-ST-5P	7314150364381	5	148
3940-150-4/6-SC-10P	7314150361847	1	148
3940-150-4/6-SC-2P	7314150361823	5	148
3940-150-4/6-SC-5P	7314150361830	5	148
3940-150-5/8-DSL-10P	7314150361991	1	149
3940-150-5/8-DSL-2P	7314150361977	5	149
3940-150-5/8-DSL-5P	7314150361984	5	149
3940-150-5/8-SL-100P	7314150361724	1	148
3940-150-5/8-SL-10P	7314150361717	1	148
3940-150-5/8-SL-2P	7314150361687	2	148
3940-150-5/8-SL-5P	7314150361700	5	148
3940-150-6-ST-10P	7314150361786	1	148
3940-150-6-ST-2P	7314150361762	5	148
3940-150-6-ST-5P	7314150361779	5	148
3940-150-8/12-ST-100P	7314150362158	1	148
3940-150-8/12-ST-10P	7314150362141	1	148
3940-150-8/12-ST-2P	7314150362127	5	148
3940-150-8/12-ST-5P	7314150362134	5	148
3940-228-10-DSL-10P	7314150362028	1	148
3940-228-10-DSL-2P	7314150362004	5	148
3940-228-10-DSL-5P	7314150362011	5	148
3940-228-10-HST-10P	7314150362400	1	148
3940-228-10-HST-2P	7314150362387	5	148
3940-228-10-HST-5P	7314150362394	5	148
3940-228-10-ST-100P	7314150362110	1	148
3940-228-10-ST-10P	7314150362103	1	148
3940-228-10-ST-2P	7314150362080	5	148
3940-228-10-ST-5P	7314150362097	5	148
3940-228-10/14-PR09-100P	7314150361526	1	149
3940-228-10/14-PR09-10P	7314150361519	1	149
3940-228-10/14-PR13-100P	7314150361649	1	149
3940-228-10/14-PR13-10P	7314150451265	1	149
3940-228-14-HST-10P	7314150362226	1	148
3940-228-14-HST-2P	7314150362202	5	148
3940-228-14-HST-5P	7314150362219	5	148
3940-228-14-ST-100P	7314150364145	1	148
3940-228-14-ST-10P	7314150364138	1	148
3940-228-14-ST-2P	7314150364114	5	148
3940-228-14-ST-5P	7314150364121	5	148
3940-228-18-HST-10P	7314150362271	1	148
3940-228-18-HST-2P	7314150362233	5	148
3940-228-18-HST-5P	7314150362264	5	148
3940-228-18-ST-100P	7314150364220	1	148
3940-228-18-ST-10P	7314150364213	1	148
3940-228-18-ST-2P	7314150364190	5	148
3940-228-18-ST-5P	7314150364206	5	148
3940-228-5/8-DSL-10P	7314150361939	1	149
3940-228-5/8-DSL-2P	7314150361915	5	149



### 3940-228-5/8-DSL-5P



3940-228-5/8-DSL-5P	7314150361922	5	149
3940-228-6-SL-10P	7314150361755	1	148
3940-228-6-SL-2P	7314150361731	5	148
3940-228-6-SL-5P	7314150361748	5	148
3940-228-8/12-PR13-100P	7314150361601	1	149
3940-228-8/12-ST-100P	7314150362073	1	148
3940-228-8/12-ST-10P	7314150362066	1	148
3940-228-8/12-ST-2P	7314150362042	5	148
3940-228-8/12-ST-5P	7314150362059	5	148
3940-300-10-HST-10P	7314150362448	1	148
3940-300-10-HST-2P	7314150362424	5	148
3940-300-10-HST-5P	7314150362431	5	148
3940-300-14-HST-10P	7314150362301	1	148
3940-300-14-HST-2P	7314150362288	5	148
3940-300-14-HST-5P	7314150362295	5	148
3940-300-14-ST-100P	7314150364268	1	148
3940-300-14-ST-10P	7314150364251	1	148
3940-300-14-ST-2P	7314150364237	5	148
3940-300-14-ST-5P	7314150364244	5	148
3940-300-18-HST-10P	7314150364008	1	148
3940-300-18-HST-2P	7314150363988	5	148
3940-300-18-HST-5P	7314150363995	5	148
3940-300-18-ST-100P	7314150364305	1	148
3940-300-18-ST-10P	7314150364299	1	148
3940-300-18-ST-2P	7314150364275	5	148
3940-300-18-ST-5P	7314150364282	5	148
3940-300-5/8-DSL-10P	7314150361960	1	149
3940-300-5/8-DSL-2P	7314150361946	5	149
3940-300-5/8-DSL-5P	7314150361953	5	149
3940-300-6-SL-10P	7314150361816	1	148
3940-300-6-SL-2P	7314150361793	5	148
3940-300-6-SL-5P	7314150361809	5	148
3940-300-8/12-SL-100P	7314150361908	1	148
3940-300-8/12-SL-10P	7314150361892	1	148
3940-300-8/12-SL-2P	7314150361878	5	148
3940-300-8/12-SL-5P	7314150361885	5	148
3940-HDD-SET-5P	7314150401703	5	147
3940-METAL-SET-5P	7314150401673	1	147
3940-MIX-SET-10P	7314150401666	4	147
3940-MIX-SET-5P	7314150401659	5	147
3942-150-7-SL-10P	7314150364534	1	149
3942-150-7-SL-2P	7314150364510	5	149
3942-150-7-SL-5P	7314150364527	5	149
3942-228-11-HSL-10P	7314150364831	1	149
3942-228-11-HSL-2P	7314150364817	5	149
3942-228-11-HSL-5P	7314150364824	5	149
3942-228-5-HSL-10P	7314150364657	1	149
3942-228-5-HSL-2P	7314150364633	5	149
3942-228-5-HSL-5P	7314150364640	5	149
3942-228-7-HSL-10P	7314150364749	1	149
3942-228-7-HSL-2P	7314150364725	5	149
3942-228-7-HSL-5P	7314150364732	5	149
3942-228-7-SL-10P	7314150364503	1	149
3942-228-7-SL-2P	7314150364480	5	149
3942-228-7-SL-5P	7314150364497	5	149
3942-300-5-HSL-10P	7314150364688	1	149
3942-300-5-HSL-2P	7314150364664	5	149
3942-300-5-HSL-5P	7314150364671	5	149
3942-300-7-HSL-10P	7314150364770	1	149
3942-300-7-HSL-2P	7314150364756	5	149
3942-300-7-HSL-5P	7314150364763	5	149
3942-300-7-SL-10P	7314150364619	1	149
3942-300-7-SL-2P	7314150364596	5	149
3942-300-7-SL-5P	7314150364602	5	149
3942-WOOD-SET-5P	7314150401680	5	147
3944-300-3-MEAT-1P	7314150364862	5	149
3946-100-G-ST-2P	7314150364930	5	149
3946-150-6-SL-1P	7314150364916	5	149
3946-150-G-ST-2P	7314150364947	5	149
3946-228-3-ST-1P	7314150364886	5	149
3946-300-3-ST-1P	7314150364879	5	149
3946-300-6-ST-1P	7314150364923	5	149
396-BLADE	7311518299057	100	627
396-HP	7311518152284	4	628
396-HP-BLADE	7311518156404	1	628
396-JS	7311518223250	4	628
396-JS-BLADE	7311518223267	1	628
396-JT	7311518168056	4	628
396-JT-BLADE	7311518168063	1	628
396-LAP	7311518172367	10	627
4-138-06-1-0	7311518020927	10	29
4-138-06-1-2	7311518000592	5	29
4-138-08-1-0	7311518020934	10	29
4-138-08-1-2	7311518000615	5	29
4-138-10-1-0	7311518020958	10	29
4-138-10-1-2	7311518000646	5	29
4-138-12-1-0	7311518020965	5	29
4-138-12-1-2	7311518194734	5	29
4-140-06-1-0	7311518020989	10	29
4-140-08-1-0	7311518020996	10	29
4-140-08-1-2	7311518028169	5	29
4-140-10-1-0	7311518022488	10	29
4-140-10-1-2	7311518194741	5	29
4-142-06-1-0	7311518021016	10	29
4-142-08-1-0	7311518021023	10	29
4-142-10-1-0	7311518021030	10	29



4-144-08-2-0	7311518021054	10	29
4-144-08-2-2	7311518201319	5	29
4-152-08-2-2	7311518000691	5	29
4-153-08-1-2	7311518000707	5	29
4-154-08-2-2	7311518000714	10	30
4-155-08-2-0	7311518116194	10	30
4-155-10-2-0	7311518116200	5	30
4-183-04-2-0	7311518021108	10	30
4-183-04-2-2	7311518201401	5	30
4-183-05-2-0	7311518021122	10	30
4-183-05-2-2	7311518201418	5	30
4-183-06-2-0	7311518021139	10	30
4-183-06-2-2	7311518000769	5	30
4-183-07-2-0	7311518021146	10	30
4-183-07-2-2	7311518194710	5	30
4-183-08-2-0	7311518021153	10	30
4-183-08-2-2	7311518194727	5	30
4-183-10-2-0	7311518021160	10	30
4-183-45-2-0	7311518021115	10	30
4-186-04-2-0	7311518021191	10	30
4-186-04-2-2	7311518201425	5	30
4-186-05-2-0	7311518021214	10	30
4-186-05-2-2	7311518028213	5	30
4-186-06-2-0	7311518021221	10	30
4-186-06-2-2	7311518000837	5	30
4-186-07-2-0	7311518021238	10	30
4-186-08-2-0	7311518021245	10	30
4-186-45-2-0	7311518021207	10	30
4-187-04-2-0	7311518021269	10	30
4-187-05-2-0	7311518021283	10	30
4-187-05-2-2	7311518201449	5	30
4-187-06-2-0	7311518021290	10	30
4-187-06-2-2	7311518022464	5	30
4-187-07-2-0	7311518021306	10	30
4-187-45-2-0	7311518021276	10	30
4-188-05-2-0	7311518021337	10	30
4-188-05-2-2	7311518201456	5	31
4-188-06-2-0	7311518021344	10	30
4-190-06-2-0	7311518021368	10	31
4-190-06-2-2	7311518000899	5	31
4-190-07-2-0	7311518021375	10	31
4-190-07-2-2	7311518000905	5	31
4-190-08-2-0	7311518021382	10	31
4-190-08-2-2	7311518000912	5	31
4-192-06-2-0	7311518021412	10	31
4-192-06-2-2	7311518201463	5	31
4-192-07-2-0	7311518021429	10	31
4-192-08-2-0	7311518021436	10	31
4-192-08-2-2	7311518201487	5	31
4-202-85-2-0	7311518021474	10	31
4-203-85-2-0	7311518021481	10	31
4-204-85-2-0	7311518021498	10	31
4-272-05-3-2	7311518201500	5	31
4-272-06-3-0	7311518021597	10	31
4-272-06-3-2	7311518001025	5	31
400.002.050	7314150249848	1	603
400.003.020	8412814403205	1	603
400.003.030	8412814403304	1	603
401-16	7314150400270	12	260
401-28	7314150384082	12	260
402-35	7314150384099	6	260
402-76	7314150384105	6	260
402-95-SET	7314150400997	1	261
4020L-M-3	7314151077693	5	45
4020L-M-3.2	7314151405038	5	45
4020L-M-3.5	7314151077709	5	45
4020L-M-4	7314151077716	5	45
4020L-M-4.5	7314151077723	5	45
4020L-M-5	7314151077730	5	45
4020L-M-5.5	7314151077747	5	45
4040M-10-11	7314151078287	1	62
4040M-10-13	7314153000750	1	62
4040M-12-13	7314151078294	1	62
4040M-13-17	7314151804565	1	62
4040M-14-15	7314151078300	1	62
4040M-16-17	7314151078317	1	62
4040M-16-18	7314151839635	1	62
4040M-17-19	7314151804572	1	62
4040M-18-19	7314151078324	1	62
4040M-20-22	7314151078331	1	62
4040M-21-23	7314151078348	1	62
4040M-24-27	7314151831974	1	62
4040M-6-7	7314151831967	1	62
4040M-8-9	7314151078270	1	62
4040M/6T	7314150112197	1	62
4040M/S6	7314150112180	1	62
4040Z-1/2-9/16	7314151831998	1	62
4040Z-13/16-7/8	7314150355099	1	62
4040Z-3/8-7/16	7314151831981	1	62
4040Z-5/8-11/16	7314151832001	1	62
4040Z-5/8-3/4	7314153001023	1	62
405-1000	7314150399758	5	538
405-1000-M	7314150399765	5	538
405-400	7314150399673	5	538
405-400-M	7314150399680	5	538
405-600	7314150399697	5	538



Code	Code	Code	Code
405-600-M	7314150399703	5	538
405-800	7314150399710	10	538
405-800-M	7314150399741	5	538
405L-400	7314150400461	10	538
405L-400-M	7314150400492	5	538
405L-600	7314150400478	10	538
405L-600-M	7314150400485	5	538
406-300	7314150183678	1	538
406-300-M	7314150186358	5	538
406-400	7314150183685	5	538
406-400-M	7314150183838	5	538
406-500	7314150183692	5	538
406-500-M	7314150186365	5	538
406-600	7314150245819	5	538
406-600-M	7314150245840	5	538
406-800	7314150245826	5	538
406P-400	7314150302574	10	538
406P-600	7314150302581	10	538
406T-225	7314150315130	10	538
407-1000	7314150369928	6	589
407-1400	7314150373703	6	589
407-700	7314150369911	6	589
407F-1000	7314150383801	6	589
407F-1400	7314150383818	6	589
407F-700	7314150383795	6	589
40B-115-165	7314153011879	10	63
40B-165-230	7314150214587	1	63
40B-19-50	7314153011848	10	63
40B-22-35	7314150214563	1	63
40B-32-75	7314153011855	10	63
40B-35-60	7314150213726	1	63
40B-50-120	7314153011862	10	63
40B-60-90	7314150213733	1	63
40B-95-155	7314150214570	1	63
4106-155-230	7314150213801	1	63
4106-19-50	7314153011886	10	63
4106-20-35	7314150213764	1	63
4106-32-75	7314153011893	10	63
4106-35-60	7314150213771	1	63
4106-60-90	7314150213788	1	63
4106-90-155	7314150213795	5	63
411-26	7314150412068	4	261
411-26-95	7314150412259	50	262
411-35	7314150412082	4	261
411-35-95	7314150412266	50	262
411-42	7314150412112	6	261
411-42-95	7314150412273	50	262
411-63	7314150412136	5	261
411-63-95	7314150412280	30	262
412-26-MULTI	7314150412174	5	261
412-26-MULTI-95	7314150412303	150	262
412-28-PEX	7314150412150	5	261
412-28-PEX-95	7314150412297	30	262
4124-JT-H	7311518267803	4	628
4128-JT-H	7311518267810	4	628
4130	7314150100019	3	225
413005000	8413345011860	12	592
413010000	8413345011877	12	592
413015000	8413345011884	12	592
413020000	8413345011891	6	592
413030000	8413345119986	1	592
413040000	8413345119993	1	592
4131	7314150100026	3	225
414-10	7311518238148	4	567
414-12	7311518238155	4	567
414-14	7311518238162	4	567
414-15	7311518238179	4	567
414-16	7311518238186	4	567
414-18	7311518238193	4	567
414-20	7311518238209	4	567
414-22	7311518238216	4	567
414-25	7311518238223	4	567
414-28	7311518238230	4	567
414-30	7311518238247	4	567
414-32	7311518238254	4	567
414-35	7311518238261	4	567
414-38	7311518238278	4	567
414-6	7311518238117	4	567
414-8	7311518238131	4	567
414-S3-EUR	7311518249205	1	567
416-1000	7314150314027	10	537
416-1200	7314150308798	10	537
416-1500	7314150314034	10	537
416-1800	7314150308804	10	537
416-2000	7314150308811	10	537
416-400	7314150314003	10	537
416-600	7314150308781	10	537
416-800	7314150314010	10	537
416-SET-1	7314150308828	5	538
416-SET-2	7314150308835	5	538
416-SET+BAG	7314150365470	1	538
41RM-10	7314153014429	1	48
41RM-11	7314153014436	1	48
41RM-12	7314153014443	1	48
41RM-13	7314153014450	1	48
41RM-14	7314153014467	1	48

Code	Code	Code	Code
41RM-17	7314153014474	1	48
41RM-19	7314153014481	1	48
41RM-21	7314150219742	1	48
41RM-8	7314153014412	1	48
41RM/SH8	7314150220656	10	49
41RZ-1/2	7314150359011	1	48
41RZ-11/16	7314150359042	1	48
41RZ-13/16	7314150359066	1	48
41RZ-3/4	7314150359059	1	48
41RZ-3/8	7314150358991	1	48
41RZ-5/16	7314150358984	1	48
41RZ-5/8	7314150359035	1	48
41RZ-7/16	7314150359004	1	48
41RZ-7/8	7314150359073	1	48
41RZ-9/16	7314150359028	1	48
420SC-25	7314150169825	10	583
420SC-50	7314150169832	5	583
420SH-100-200	7314150359691	10	582
420SH-120-1000	7314150359790	6	582
420SH-120-1250	7314150359806	6	582
420SH-120-1500	7314150359813	6	582
420SH-120-250	7314150359707	8	582
420SH-120-300	7314150359745	8	582
420SH-120-400	7314150359752	6	582
420SH-120-500	7314150359769	6	582
420SH-120-600	7314150359776	6	582
420SH-120-800	7314150359783	6	582
420SH-140-400	7314150359820	6	582
420SH-175-400	7314150359837	6	582
420SH-50-100	7314150359646	10	582
420SH-50-200	7314150359653	10	582
420SH-60-120	7314150359660	12	582
420SH-60-300	7314150359677	12	582
420SH-80-160	7314150359684	12	582
4211-11-6T	7311518152000	4	628
4211-14-6T	7311518128883	4	628
4212-11-6T	7311518002060	4	628
4212-14-6T	7311518002077	4	628
422P-10	7311518248369	4	568
422P-12	7311518248376	4	568
422P-16	7311518248383	4	568
422P-20	7311518248390	4	568
422P-25	7311518248406	4	568
422P-6	7311518248352	4	568
4231	7314150100033	3	227
4239	7314150100088	3	227
424P-10	7311518238315	4	566
424P-12	7311518238322	4	566
424P-14	7311518238339	4	566
424P-15	7311518238346	4	566
424P-16	7311518238353	4	566
424P-18	7311518238360	4	566
424P-20	7311518238377	4	566
424P-22	7311518238384	4	566
424P-24	7311518238391	4	566
424P-25	7311518238407	4	566
424P-26	7311518238414	4	566
424P-28	7311518238421	4	566
424P-30	7311518238438	4	566
424P-32	7311518238445	4	566
424P-35	7311518238452	4	566
424P-38	7311518238469	4	566
424P-4	7311518238285	4	566
424P-40	7311518238476	4	566
424P-6	7311518238292	4	566
424P-8	7311518238308	4	566
424P-S3-EUR	7311518249199	1	566
424P-S6-EUR	7311518269968	1	567
424P-S6-GER	7311518280086	1	567
424P-S6-LR	7314150423804	1	566
424P-S6-PP	7314150326662	1	567
424P-S8-EUR	7311518276393	1	567
425-081	7311518010669	1	568
425-082	7311518010676	1	568
425-083	7311518010683	1	568
425-10	7311518004613	4	568
425-12	7311518004620	4	568
425-14	7311518004637	4	568
425-15	73115180117767	4	568
425-16	7311518004644	4	568
425-18	7311518004651	4	568
425-20	7311518004668	4	568
425-22	7311518004675	4	568
425-24	7311518005993	4	568
425-25	7311518004682	4	568
425-26	7311518006006	4	568
425-28	7311518004699	4	568
425-30	7311518004705	4	568
425-32	7311518004712	4	568
425-35	73115180117774	4	568
425-38	7311518004729	4	568
425-4	7311518030810	4	568
425-40	73115180117781	4	568
425-6	7311518004590	4	568
425-8	7311518004606	4	568
426-1000	7311518004309	1	537





426-1200	7311518004316	1	537
426-400	7311518004255	1	537
426-600	7311518004279	1	537
426-800	7311518004293	1	537
426TOR9	7314150125319	10	539
427-13	7314150403578	4	586
427-16	7311518025410	4	586
427-20	7311518025427	4	586
427-24	7314150402878	4	586
427-700	7314150338092	6	586
427-8	7314150402854	4	586
427S-16	7314150404247	4	586
427S-20	7314150404261	4	586
428-16	7311518012380	4	586
428-700	7314150338108	6	587
428F-13	7314150436392	4	586
428F-16	7314150436408	4	586
428F-20	7314150436422	4	586
428F-24	7314150436439	4	586
428F-8	7314150436378	4	586
428S-16	7314150424030	4	586
428S-20	7314150424047	4	586
429-13	7311518012250	4	586
429-16	7311518012403	4	586
429-20	7311518012410	4	586
429-8	7311518040703	4	586
42RM/S12	7314150384785	1	49
4307	7314151079444	1	63
4310	7314151079451	1	63
434-10	7311518238506	4	566
434-12	7311518238513	4	566
434-14	7311518238520	4	566
434-15	7311518238537	4	566
434-16	7311518238544	4	566
434-18	7311518238551	4	566
434-20	7311518238568	4	566
434-22	7311518238575	4	566
434-25	7311518238582	4	566
434-28	7311518238599	4	566
434-30	7311518238605	4	566
434-32	7311518238612	4	566
434-35	7311518238629	4	566
434-38	7311518238636	4	566
434-50	7311518285388	4	566
434-6	7311518238483	4	566
434-8	7311518238490	4	566
434-S3-EUR	7311518249212	1	566
434-S6-EUR	7311518267544	1	566
434-S6-LR	7314150423811	1	566
434-S6-PP	7314150326655	1	566
434-S8-EUR	7311518295110	1	566
439000000	8413345129282	1	467
439000001	7314150268788	1	467
439000002	7314150309702	1	467
439000003	7314150309719	1	467
439000004	7314150427666	1	467
4400-11	7311518200596	10	629
4400-11-BULK	7311518200633	10	629
4400-14	7311518200602	10	629
4400-14-BULK	7311518200640	10	629
440102500	8413345098977	10	590
440103000	8413345098991	10	590
4411-1.00	7314150372744	1	160
4411-1.50	7314150372768	1	160
4411-10.00	7314150372973	1	160
4411-10.20	7314150372980	1	160
4411-10.50	7314150470488	1	160
4411-11.00	7314150372997	1	160
4411-11.50	7314150470495	1	160
4411-12.00	7314150373000	1	160
4411-12.50	7314150470501	1	160
4411-13.00	7314150373017	1	160
4411-2.00	7314150372775	1	160
4411-2.50	7314150372782	1	160
4411-3.00	7314150372799	1	160
4411-3.25	7314150372805	1	160
4411-3.30	7314150372812	1	160
4411-3.50	7314150372829	1	160
4411-4.00	7314150372836	1	160
4411-4.20	7314150372843	1	160
4411-4.25	7314150372850	1	160
4411-4.50	7314150372867	1	160
4411-5.00	7314150372874	1	160
4411-5.50	7314150372881	1	160
4411-6.00	7314150372898	1	160
4411-6.50	7314150372904	1	160
4411-6.80	7314150372911	1	160
4411-7.00	7314150372928	1	160
4411-7.50	7314150372935	1	160
4411-8.00	7314150372942	1	160
4411-8.50	7314150372959	1	160
4411-9.00	7314150372966	1	160
4411-9.50	7314150394463	1	160
4413-1.00	7314150371754	1	161
4413-1.50	7314150371761	1	161
4413-10.00	7314150372034	1	161



4413-10.20	7314150372041	1	161
4413-10.50	7314150470556	1	161
4413-11.00	7314150372058	1	161
4413-11.50	7314150470563	1	161
4413-12.00	7314150372065	1	161
4413-12.50	7314150470570	1	161
4413-13.00	7314150372072	1	161
4413-2.00	7314150371785	1	161
4413-2.50	7314150371792	1	161
4413-3.00	7314150371815	1	161
4413-3.25	7314150371822	1	161
4413-3.30	7314150371877	1	161
4413-3.50	7314150371884	1	161
4413-4.00	7314150371891	1	161
4413-4.20	7314150371907	1	161
4413-4.25	7314150371914	1	161
4413-4.50	7314150371921	1	161
4413-5.00	7314150371938	1	161
4413-5.50	7314150371945	1	161
4413-6.00	7314150371952	1	161
4413-6.50	7314150371969	1	161
4413-6.80	7314150371976	1	161
4413-7.00	7314150371983	1	161
4413-7.50	7314150371990	1	161
4413-8.00	7314150372003	1	161
4413-8.50	7314150372010	1	161
4413-9.00	7314150372027	1	161
4413-9.50	7314150394456	1	161
4415-1.00	7314150394210	1	162
4415-1.50	7314150394227	1	162
4415-10.00	7314150394401	1	162
4415-10.50	7314150470525	1	162
4415-11.00	7314150394418	1	162
4415-11.50	7314150470532	1	162
4415-12.00	7314150394425	1	162
4415-12.50	7314150470549	1	162
4415-13.00	7314150394432	1	162
4415-13.50	7314150441495	1	162
4415-14.00	7314150441501	1	162
4415-14.50	7314150441518	1	162
4415-15.00	7314150441525	1	162
4415-15.50	7314150441532	1	162
4415-16.00	7314150441549	1	162
4415-16.50	7314150441556	1	162
4415-17.00	7314150441563	1	162
4415-17.50	7314150441570	1	162
4415-18.00	7314150441587	1	162
4415-18.50	7314150441594	1	162
4415-19.00	7314150441600	1	162
4415-19.50	7314150441617	1	162
4415-2.00	7314150394234	1	162
4415-2.50	7314150394241	1	162
4415-20.00	7314150441624	1	162
4415-3.00	7314150394258	1	162
4415-3.25	7314150394265	1	162
4415-3.50	7314150394272	1	162
4415-4.00	7314150394289	1	162
4415-4.25	7314150394296	1	162
4415-4.50	7314150394302	1	162
4415-5.00	7314150394319	1	162
4415-5.50	7314150394326	1	162
4415-6.00	7314150394333	1	162
4415-6.50	7314150394340	1	162
4415-7.00	7314150394357	1	162
4415-7.50	7314150394364	1	162
4415-8.00	7314150394371	1	162
4415-8.50	7314150394388	1	162
4415-9.00	7314150394395	1	162
442	7311518002848	10	546
442 B	7314150008957	1	258
442-3P	7314150309610	10	546
4420-11	7311518200619	10	629
4420-11-BULK	7311518200657	10	629
4420-14	7311518200626	10	629
4420-14-BULK	7311518200664	10	629
443 B	7314150008971	1	258
4430	7314150100040	3	237
4435-12.4	7314150465163	1	163
444 B	7314150009008	1	258
4480/2-ZD	7311518276911	1	262
4480IM	7314150263165	1	262
4480MM	7314150263158	1	262
449	7311518005337	10	546
44Z-1/2-9/16	7314150375233	10	56
44Z-1/4-5/16	7314150375196	10	56
44Z-11/16-13/16	7314150375264	5	56
44Z-11/16-3/4	7314150375257	5	56
44Z-3/8-7/16	7314150375219	10	56
44Z-5/16-3/8	7314150375202	10	56
44Z-5/8-3/4	7314150375240	5	56
44Z-7/16-1/2	7314150375226	10	56
451	7311518014506	10	546
4511-0.50-10P	7314150373079	1	160
4511-0.75-10P	7314150373062	1	160
4511-1.00-10P	7314150373055	1	160
4511-1.50-10P	7314150373086	1	160



4511-1.75-10P	7314150373093	1	160
4511-10.00-5P	7314150373444	1	160
4511-10.20-5P	7314150373468	1	160
4511-10.30-5P	7314150373475	1	160
4511-10.50-5P	7314150373482	1	160
4511-10.80-5P	7314150373499	1	160
4511-11.00-5P	7314150373505	1	160
4511-11.50-5P	7314150373512	1	160
4511-12.00-5P	7314150373529	1	160
4511-12.50-5P	7314150373536	1	160
4511-12.80-5P	7314150373543	1	160
4511-13.00-5P	7314150373550	1	160
4511-13.50-1P	7314150373567	1	160
4511-14.00-1P	7314150373574	1	160
4511-14.50-1P	7314150373581	1	160
4511-15.00-1P	7314150373598	1	160
4511-15.50-1P	7314150373604	1	160
4511-16.00-1P	7314150373611	1	160
4511-16.50-1P	7314150373628	1	160
4511-17.00-1P	7314150373635	1	160
4511-17.50-1P	7314150373642	1	160
4511-18.00-1P	7314150373659	1	160
4511-18.50-1P	7314150373673	1	160
4511-19.00-1P	7314150373680	1	160
4511-19.50-1P	7314150373697	1	160
4511-2.00-10P	7314150373109	1	160
4511-2.50-10P	7314150373116	1	160
4511-2.70-10P	7314150373123	1	160
4511-2.90-10P	7314150373130	1	160
4511-20.00-1P	7314150373666	1	160
4511-3.00-10P	7314150373147	1	160
4511-3.10-10P	7314150373185	1	160
4511-3.25-10P	7314150373192	1	160
4511-3.30-10P	7314150373208	1	160
4511-3.50-10P	7314150373215	1	160
4511-3.80-10P	7314150373222	1	160
4511-4.00-10P	7314150373239	1	160
4511-4.20-10P	7314150373246	1	160
4511-4.50-10P	7314150373253	1	160
4511-4.80-10P	7314150373260	1	160
4511-5.00-10P	7314150373277	1	160
4511-5.20-10P	7314150373284	1	160
4511-5.50-10P	7314150373291	1	160
4511-6.00-10P	7314150373307	1	160
4511-6.20-10P	7314150373314	1	160
4511-6.50-10P	7314150373321	1	160
4511-6.80-10P	7314150373338	1	160
4511-7.00-10P	7314150373345	1	160
4511-7.20-10P	7314150373352	1	160
4511-7.50-10P	7314150373369	1	160
4511-7.80-10P	7314150373376	1	160
4511-8.00-10P	7314150373383	1	160
4511-8.50-10P	7314150373390	1	160
4511-8.60-10P	7314150373406	1	160
4511-8.80-10P	7314150373413	1	160
4511-9.00-10P	7314150373420	1	160
4511-9.20-10P	7314150373437	1	160
4511-9.50-10P	7311518339081	1	160
4511-9.60-10P	7314150373451	1	160
4511-SET-19	7314150373031	1	161
4511-SET-25	7314150373048	1	161
4511-SET-6	7314150373024	1	160
4513-1.00-10P	7314150372119	1	161
4513-1.50-10P	7314150372126	1	161
4513-1.75-10P	7314150372133	1	161
4513-10.00-5P	7314150391998	1	161
4513-10.20-5P	7314150392001	1	161
4513-10.30-5P	7314150392018	1	161
4513-10.50-5P	7314150392025	1	161
4513-10.80-5P	7314150392032	1	161
4513-11.00-5P	7314150392049	1	161
4513-11.50-5P	7314150392056	1	161
4513-12.00-5P	7314150392063	1	161
4513-12.50-5P	7314150392070	1	161
4513-12.80-5P	7314150392087	1	161
4513-13.00-5P	7314150392094	1	161
4513-13.50-1P	7314150392100	1	161
4513-14.00-1P	7314150392117	1	161
4513-14.50-1P	7314150392124	1	161
4513-15.00-1P	7314150392131	1	161
4513-15.50-1P	7314150392148	1	161
4513-16.00-1P	7314150392155	1	161
4513-16.50-1P	7314150392162	1	161
4513-17.00-1P	7314150392179	1	161
4513-17.50-1P	7314150392186	1	161
4513-18.00-1P	7314150392193	1	161
4513-18.50-1P	7314150392209	1	161
4513-19.00-1P	7314150392216	1	161
4513-19.50-1P	7314150392223	1	161
4513-2.00-10P	7314150372140	1	161
4513-2.50-10P	7314150372157	1	161
4513-2.70-10P	7314150372164	1	161
4513-2.90-10P	7314150372171	1	161
4513-20.00-1P	7314150392230	1	161
4513-3.00-10P	7314150372188	1	161
4513-3.10-10P	7314150372195	1	161



4513-3.25-10P	7314150372201	1	161
4513-3.30-10P	7314150372218	1	161
4513-3.50-10P	7314150372225	1	161
4513-3.80-10P	7314150372232	1	161
4513-4.00-10P	7314150372249	1	161
4513-4.20-10P	7314150372256	1	161
4513-4.50-10P	7314150372263	1	161
4513-4.80-10P	7314150372270	1	161
4513-5.00-10P	7314150372287	1	161
4513-5.20-10P	7314150372294	1	161
4513-5.50-10P	7314150372300	1	161
4513-6.00-10P	7314150372317	1	161
4513-6.20-10P	7314150372324	1	161
4513-6.50-10P	7314150372331	1	161
4513-6.80-10P	7314150372348	1	161
4513-7.00-10P	7314150372355	1	161
4513-7.20-10P	7314150372362	1	161
4513-7.50-10P	7314150372379	1	161
4513-7.80-10P	7314150372386	1	161
4513-8.00-10P	7314150372393	1	161
4513-8.50-10P	7314150372409	1	161
4513-8.60-10P	7314150372416	1	161
4513-8.80-10P	7314150372423	1	161
4513-9.00-10P	7314150372430	1	161
4513-9.20-10P	7314150372447	1	161
4513-9.50-10P	7314150372454	1	161
4513-9.60-10P	7314150372461	1	161
4513-SET-19	7314150372096	1	162
4513-SET-25	7314150372102	1	162
4513-SET-6	7314150372089	1	161
4515-1.00-10P	7314150441228	1	162
4515-1.50-10P	7314150441235	1	162
4515-10.00-10P	7314150441426	1	162
4515-10.50-5P	7314150441433	1	162
4515-11.00-5P	7314150441440	1	162
4515-11.50-5P	7314150441457	1	162
4515-12.00-5P	7314150441464	1	162
4515-12.50-5P	7314150441471	1	162
4515-13.00-5P	7314150441488	1	162
4515-2.00-10P	7314150441242	1	162
4515-2.50-10P	7314150441259	1	162
4515-3.00-10P	7314150441266	1	162
4515-3.25-10P	7314150441273	1	162
4515-3.50-10P	7314150441280	1	162
4515-4.00-10P	7314150441297	1	162
4515-4.25-10P	7314150441303	1	162
4515-4.50-10P	7314150441310	1	162
4515-5.00-10P	7314150441327	1	162
4515-5.50-10P	7314150441334	1	162
4515-6.00-10P	7314150441341	1	162
4515-6.50-10P	7314150441358	1	162
4515-7.00-10P	7314150441365	1	162
4515-7.50-10P	7314150441372	1	162
4515-8.00-10P	7314150441389	1	162
4515-8.50-10P	7314150441396	1	162
4515-9.00-10P	7314150441402	1	162
4515-9.50-10P	7314150441419	1	162
4515-SET-19	7314150394449	1	162
4515-SET-25	7314150441709	1	162
4518-3	7314151716547	1	357
4518-4	7314151716622	1	357
4518-5	7314151716899	1	357
4519-1	7314151716974	1	355
4519-1/B	7314150225149	1	355
4519-1/S	7314151843762	1	355
4519-2	7314151717193	1	355
4519-2/S	7314151843977	1	355
4519-23/B	7314150225156	1	355
4519-3	7314151717278	1	355
4519K1	7314150225163	1	355
4519K2	7314150225170	1	355
4519K3	7314150225187	1	355
4521N-0	7314151837723	1	356
4521N-00	7314151837716	1	356
4521N-A	7314151837730	1	356
4521N-B	7314151837747	1	356
4521N-C	7314151837754	1	356
4521N-D	7314151837761	1	356
4521N-E	7314151837778	1	356
4521N-F	7314151837785	1	356
4521N-G	7314151837792	1	356
4521N-H	7314151837808	1	356
4521N-I	7314151837815	1	356
4521N-K	7314151837822	1	356
4521N-L	7314151837839	1	356
4521N-M	7314151837846	1	356
4521N-S	7314151839789	1	356
4521N-T	7314151839796	1	356
4521N/7	7314151839802	1	357
4522-1	7314151081591	1	356
4522-1/B	7314150225033	1	356
4522-1/S	7314150225064	1	356
4522-2	7314151081614	1	356
4522-2/B	7314150225057	1	356
4522-2/S	7314150225071	1	356
4522K1	7314150225088	1	356





4522K2	7314150225095	1	356
4523G	7314151846695	1	357
4524G	7314151718596	1	357
4528-1	7314151718671	1	356
4528-1/B	7314150224692	1	356
4528K1	7314151837662	1	356
4528K2	7314151837679	1	356
4528K3	7314151837686	1	356
4528K4	7314151837693	1	356
4528K5	7314151837709	1	356
4528M1	7314151718916	1	355
4528M1/B	7314150224654	1	355
4528M1/P	7314150330959	1	355
4528M2	7314151719050	1	355
4528M2/B	7314150224661	1	355
4528M2/P	7314150330980	1	355
4528M3	7314151719135	1	355
4528M3/P	7314150330973	1	355
4528M345/B	7314150224678	1	355
4528M4	7314151719210	1	355
4528M5	7314151719487	1	355
4528MK5	7314150224685	1	355
4529-15	7314151719647	1	356
4529-8	7314151719562	1	356
4530	7314150100095	3	238
4532-0	7314151719722	1	354
4532-A	7314151082109	1	354
4532-A/B	7314150224401	1	354
4532-AL	7314150221912	1	354
4532-B	7314151082116	1	354
4532-B/B	7314150224418	1	354
4532-BL	7314150221929	1	354
4532-C	7314151082123	1	354
4532-C/B	7314150224425	1	354
4532-CD/S	7314151818067	1	354
4532-CL	7314150221936	1	354
4532-D	7314151082130	1	354
4532-D/B	7314150224432	1	354
4532-E	7314151082147	1	354
4532-E/B	7314150224449	1	354
4532-EFG/S	7314151838386	1	354
4532-F	7314151082154	1	354
4532-F/B	7314150224456	1	354
4532-G	7314151082161	1	354
4532-G-SO	7314151841003	1	354
4532-G/B	7314150224463	1	354
4532-H	7314151719999	1	354
4532-H/B	7314150224470	1	354
4532-H/S	7314151838393	1	354
4532-O/B	7314150224388	1	354
4532-OAB/S	7314151818050	1	354
4532K1	7314151082185	1	354
4532K2	7314151082192	1	354
4532K3	7314151082208	1	354
4532K4	7314151720148	1	354
4532K0	7314151720063	1	354
4532LK1	7314151082215	1	354
4532LK2	7314151082222	1	354
4532LK3	7314151082239	1	354
4532LK4	7314151082246	1	354
4532LK5	7314151720223	1	354
4532ST/5	7314151720490	1	354
4533HP	7314151793043	1	356
4533HP/S	7314150224487	1	356
4533HPK	7314150224500	1	356
4533M	7314151793050	1	356
4533M/S	7314150224494	1	356
4533MK	7314150224517	1	356
4537-1	7314151720650	1	355
4537-1/B	7314150224562	1	355
4537-2	7314151720735	1	355
4537-2/B	7314150224579	1	355
4537-3	7314151720810	1	355
4537-34/B	7314150224586	1	355
4537-4	7314151721039	1	355
4537K1	7314150224593	1	355
4537K2	7314150224609	1	355
4537K3	7314150224616	1	355
4537K4	7314150224623	1	355
4540-17	7314150125005	1	355
4540-17/K1	7314150225231	1	355
4540-17/K2	7314150225224	1	355
4540-17/K3	7314150225217	1	355
4540-17/K4	7314150225200	1	355
4540-17/S	7314150225248	1	355
4540-25	7314150125012	1	355
4540-25/K1	7314150225279	1	355
4540-25/K2	7314150239238	1	355
4540-25/K3	7314150225262	1	355
4540-25/K4	7314150225255	1	355
4540-25/S	7314150225286	1	355
4541-A	7314151082413	1	355
4541-A/B	7314150224524	1	355
4541-B	7314151082420	1	355
4541-B/B	7314150224531	1	355
4541KA	7314150224548	1	355



4541KB	7314150224555	1	355
4542-A	7314151082451	1	355
4542-A/B	7314150224630	1	355
4542-B	7314151082468	1	355
4542-B/B	7314150224647	1	355
4543-1	7314151082499	1	354
4543-1/S	7314151818623	1	354
4543-10	7314151721466	1	354
4543-1020/B	7314150224715	1	354
4543-12/B	7314150224708	1	354
4543-2	7314151082505	1	354
4543-2/S	7314151818661	1	354
4543-20	7314151721541	1	354
4543-3	7314151721381	1	354
4543-3/B	7314150224739	1	354
4543-3/S	7314151818708	1	354
4543-30	7314151721622	1	354
4543-30/B	7314150224722	1	354
4543K110	7314150224746	1	354
4543K220	7314150224753	1	354
4543K330	7314150224760	1	354
4544-1	7314151844004	1	354
4544-1/B	7314150224845	1	354
4544-10	7314151844042	1	354
4544-10/B	7314150224883	1	355
4544-110/S	7314150224777	1	355
4544-2	7314151844011	1	354
4544-2/B	7314150224852	1	355
4544-20	7314151844059	1	354
4544-20/B	7314150224890	1	355
4544-220/S	7314150224784	1	355
4544-3	7314151844028	1	354
4544-3/B	7314150224869	1	355
4544-30	7314151844066	1	354
4544-30/B	7314150224906	1	355
4544-4	7314151844035	1	354
4544-4/B	7314150224876	1	355
4544-440/S	7314150224791	1	355
4544K110	7314150224807	1	355
4544K220	7314150224814	1	355
4544K330	7314150224821	1	355
4544K440	7314150224838	1	355
4545-1	7314151082543	1	358
4545-2	7314151082550	1	358
4545-3	7314151082567	1	358
4545-4	7314151722272	1	358
4545-5	7314151722357	1	358
4545-N1	7314151722432	1	357
4545-N1/S	7314150224913	1	357
4545-N11	7314150249169	1	357
4545-N2	7314151804947	1	357
4545-N2/S	7314150224920	1	357
4545-N21	7314150249176	1	357
4551-A	7314151082628	1	356
4551-A/S	7314150224937	1	356
4551-B	7314151722784	1	356
4551-B/S	7314150224944	1	356
4551-C	7314151082642	1	356
4551-C/S	7314150224951	1	356
4551-D	7314151082659	1	356
4551-D/S	7314150224968	1	356
4552-1	7314151722944	1	356
4552-1/B	7314150224975	1	356
4552-2	7314151723088	1	356
4552-2/B	7314150224982	1	356
4552-3	7314151723163	1	356
4552-3/B	7314150224999	1	356
4552K1	7314150225002	1	356
4552K2	7314150225019	1	356
4552K3	7314150225026	1	356
4553	7314151830649	1	360
4559-12	7314150113132	1	231
4559-12A JC	7314150223909	1	231
4559-18	7314150024513	8	231
4559-18B JC	7314150113880	1	231
4559-24	7314150024520	6	231
4559-24B JC	7314150113897	1	231
4559-30	7314150024537	5	231
4559-30B JC	7314150113903	1	231
4559-36	7314150024544	3	231
4559-36B JC	7314150113910	1	231
4559-42	7314150024551	2	231
4559-42A JC	7314150208876	1	231
4560-210	7314150178995	1	231
4574	7314151799014	1	354
4577	7314151838348	1	358
4578	7314150222308	1	357
4579	7314150222018	1	358
4580N/7	7314151301361	1	357
4581N-1	7314151724139	1	357
4581NA	7314151301200	1	357
4581NB	7314151301217	1	357
4581NB2	7314151724726	1	357
4581NC	7314151301224	1	357
4582N-1	7314151724214	1	357
4582N-2	7314151724481	1	357



4582NA	7314151301248	1	357
4582NB	7314151301255	1	357
4583N-1	7314151724566	1	357
4583N-2	7314151724641	1	357
4583NA	7314151301279	1	357
4583NB	7314151301286	1	357
4590SHS5	7314150384822	4	358
4591	7314151804039	1	360
4592	7314151804046	1	360
4593	7314151804053	1	360
4594VWT4	7314150403639	5	325
45S/H1.5	7314150218530	1	173
45S/H1.5-2P	7314150261505	50	173
45S/H2	7314150218547	1	173
45S/H2-2P	7314150261512	50	173
45S/H2.5	7314150218554	1	173
45S/H2.5-2P	7314150261529	50	173
45S/H3	7314150218561	1	173
45S/H3-2P	7314150261536	50	173
45S/PH1	7314150218516	1	173
45S/PH1-2P	7314150261482	50	173
45S/PH2	7314150218523	1	173
45S/PH2-2P	7314150261499	50	173
4610-1	7314151724993	1	358
4611-2	7314151725372	1	358
4611-2/B	7314150237500	1	358
4611-2/S	7314150237494	1	358
4611-3	7314150125043	1	358
4611-3/B	7314150237524	1	358
4611-3/S	7314150237517	1	358
4614-1	7314151725457	1	356
4614-1/B	7314150225101	1	356
4614-2	7314151725532	1	356
4614-2/B	7314150225118	1	356
4614K1	7314150225125	1	356
4614K2	7314150225132	1	356
4626-10.0	7314150457670	1	165
4626-4.0	7314150457632	1	165
4626-5.0	7314150457649	1	165
4626-6.0	7314150457656	1	165
4626-8.0	7314150457663	1	165
4629-10.0	7314150465385	1	165
4629-4.0	7314150465347	1	165
4629-5.0	7314150465354	1	165
4629-6.0	7314150465361	1	165
4629-8.0	7314150465378	1	165
4629-SET-5	7314150467204	10	165
4630	7314150216154	1	603
4641-10-120	7314150383085	1	159
4641-10-200	7314150383115	1	159
4641-10-400	7314150383207	1	159
4641-10-600	7314150383221	1	159
4641-11-150	7314150383122	1	159
4641-12-150	7314150383139	1	159
4641-12-200	7314150383146	1	159
4641-12-400	7314150383238	1	159
4641-12-600	7314150383245	1	159
4641-13-150	7314150383153	1	159
4641-14-150	7314150383160	1	159
4641-14-400	7314150383252	1	159
4641-14-600	7314150383269	1	159
4641-16-150	7314150383177	1	159
4641-16-400	7314150383276	1	159
4641-16-600	7314150383283	1	159
4641-18-400	7314150383290	1	159
4641-18-600	7314150383306	1	159
4641-20-400	7314150383313	1	159
4641-20-600	7314150383320	1	159
4641-22-400	7314150383337	1	159
4641-24-400	7314150383344	1	159
4641-25-400	7314150383351	1	159
4641-3-60	7314150382859	1	159
4641-4-75	7314150382866	1	159
4641-5-150	7314150382880	1	159
4641-5-85	7314150382873	1	159
4641-5.5-85	7314150382897	1	159
4641-6-100	7314150383016	1	159
4641-6-150	7314150383023	1	159
4641-6-400	7314150383184	1	159
4641-6.5-100	7314150383030	1	159
4641-7-100	7314150383047	1	159
4641-8-120	7314150383054	1	159
4641-8-200	7314150383061	1	159
4641-8-400	7314150383191	1	159
4641-9-120	7314150383078	1	159
4641-PB	7314150383368	1	159
4643-PB	7314150441679	1	159
4651-10-1000	7314150386413	1	158
4651-10-110	7314150386345	1	158
4651-10-160	7314150386352	1	158
4651-10-210	7314150386369	1	158
4651-10-260	7314150386376	1	158
4651-10-310	7314150386383	1	158
4651-10-450	7314150386390	1	158
4651-10-600	7314150386406	1	158
4651-12-1000	7314150386581	1	158



4651-12-160	7314150386529	1	158
4651-12-210	7314150386536	1	158
4651-12-260	7314150386543	1	158
4651-12-310	7314150386550	1	158
4651-12-450	7314150386567	1	158
4651-12-600	7314150386574	1	158
4651-14-1000	7314150386659	1	158
4651-14-160	7314150386598	1	158
4651-14-210	7314150386604	1	158
4651-14-260	7314150386611	1	158
4651-14-310	7314150386628	1	158
4651-14-450	7314150386635	1	158
4651-14-600	7314150386642	1	158
4651-15-160	7314150386666	1	158
4651-15-260	7314150386673	1	158
4651-15-450	7314150386680	1	158
4651-16-1000	7314150386765	1	158
4651-16-160	7314150386697	1	158
4651-16-210	7314150386710	1	158
4651-16-260	7314150386727	1	158
4651-16-310	7314150386734	1	158
4651-16-450	7314150386741	1	158
4651-16-600	7314150386758	1	158
4651-18-250	7314150386789	1	158
4651-18-450	7314150386796	1	158
4651-20-250	7314150386802	1	158
4651-20-450	7314150386819	1	158
4651-22-250	7314150386826	1	158
4651-22-450	7314150386833	1	158
4651-24-250	7314150386840	1	158
4651-24-450	7314150386857	1	158
4651-25-250	7314150386864	1	158
4651-25-450	7314150386871	1	158
4651-28-250	7314150386888	1	158
4651-28-450	7314150386895	1	158
4651-30-250	7314150386901	1	158
4651-30-450	7314150386918	1	158
4651-32-450	7314150386925	1	158
4651-5-110	7314150385683	1	158
4651-5-160	7314150385690	1	158
4651-5-210	7314150385706	1	158
4651-5-260	7314150385713	1	158
4651-5.5-110	7314150385720	1	158
4651-5.5-160	7314150385737	1	158
4651-6-110	7314150385744	1	158
4651-6-160	7314150385751	1	158
4651-6-210	7314150385768	1	158
4651-6-260	7314150385775	1	158
4651-6-310	7314150385782	1	158
4651-6.5-160	7314150385799	1	158
4651-6.5-210	7314150385805	1	158
4651-6.5-260	7314150385812	1	158
4651-6.5-310	7314150385829	1	158
4651-7-110	7314150385836	1	158
4651-7-160	7314150386253	1	158
4651-8-110	7314150386277	1	158
4651-8-160	7314150386284	1	158
4651-8-210	7314150386291	1	158
4651-8-260	7314150386307	1	158
4651-8-310	7314150386314	1	158
4651-8-460	7314150386321	1	158
4651-9-160	7314150386338	1	158
4652-10-110	7314150385119	1	159
4652-10-160	7314150385126	1	159
4652-10-210	7314150385133	1	159
4652-10-260	7314150385140	1	159
4652-10-310	7314150385164	1	159
4652-10-450	7314150385171	1	159
4652-10-600	7314150385188	1	159
4652-11-160	7314150385195	1	159
4652-11-210	7314150385201	1	159
4652-11-260	7314150385218	1	159
4652-12-1000	7314150385287	1	159
4652-12-160	7314150385225	1	159
4652-12-210	7314150385232	1	159
4652-12-260	7314150385249	1	159
4652-12-310	7314150385256	1	159
4652-12-450	7314150385263	1	159
4652-12-600	7314150385270	1	159
4652-13-160	7314150385294	1	159
4652-13-310	7314150385300	1	159
4652-14-1000	7314150385379	1	159
4652-14-160	7314150385317	1	159
4652-14-210	7314150385324	1	159
4652-14-260	7314150385331	1	159
4652-14-310	7314150385348	1	159
4652-14-450	7314150385355	1	159
4652-14-600	7314150385362	1	159
4652-15-160	7314150385386	1	159
4652-15-260	7314150385393	1	159
4652-16-1000	7314150385478	1	159
4652-16-160	7314150385409	1	159
4652-16-210	7314150385416	1	159
4652-16-260	7314150385423	1	159
4652-16-310	7314150385430	1	159
4652-16-450	7314150385447	1	159





4652-16-600	7314150385454	1	159
4652-16-800	7314150385461	1	159
4652-18-1000	7314150385515	1	159
4652-18-200	7314150385485	1	159
4652-18-300	7314150385492	1	159
4652-18-450	7314150385508	1	159
4652-20-1000	7314150385560	1	159
4652-20-200	7314150385522	1	159
4652-20-300	7314150385539	1	159
4652-20-450	7314150385546	1	159
4652-20-600	7314150385553	1	159
4652-22-1000	7314150385607	1	159
4652-22-250	7314150385577	1	159
4652-22-450	7314150385584	1	159
4652-22-600	7314150385591	1	159
4652-24-250	7314150385614	1	159
4652-24-450	7314150385621	1	159
4652-25-1000	7314150385652	1	159
4652-25-250	7314150385638	1	159
4652-25-450	7314150385645	1	159
4652-26-250	7314150385669	1	159
4652-26-450	7314150385676	1	159
4652-4-110	7314150384365	1	159
4652-4-160	7314150384372	1	159
4652-5-110	7314150384815	1	159
4652-5-160	7314150384839	1	159
4652-5-210	7314150384846	1	159
4652-5,5-110	7314150384853	1	159
4652-5,5-160	7314150384860	1	159
4652-6-110	7314150384877	1	159
4652-6-160	7314150384891	1	159
4652-6-210	7314150384907	1	159
4652-6-260	7314150384969	1	159
4652-6,5-110	7314150384976	1	159
4652-6,5-160	7314150384990	1	159
4652-7-110	7314150385003	1	159
4652-7-160	7314150391981	1	159
4652-8-110	7314150385034	1	159
4652-8-160	7314150385058	1	159
4652-8-210	7314150385065	1	159
4652-8-260	7314150385072	1	159
4652-8-460	7314150385089	1	159
4652-9-160	7314150385096	1	159
4652-9-210	7314150385102	1	159
4655-FLAT-250	7314150387823	1	160
4655-HOLLOW-240	7314150387847	1	160
4655-POINT-250	7314150387816	1	160
4655-SLOT-25032	7314150387885	1	160
4655-TILE-20040	7314150387861	1	160
4655-TILE-25060	7314150387878	1	160
4655-WIDE-20040	7314150387830	1	160
4655-WING-C-250	7314150387854	1	160
4656-12-340	7314150386932	1	158
4656-12-540	7314150387021	1	158
4656-12-690	7314150387045	1	158
4656-14-340	7314150387069	1	158
4656-14-540	7314150387076	1	158
4656-15-340	7314150387083	1	158
4656-15-540	7314150387090	1	158
4656-16-1320	7314150387137	1	158
4656-16-340	7314150387106	1	158
4656-16-540	7314150387113	1	158
4656-16-940	7314150387120	1	158
4656-18-1320	7314150387175	1	158
4656-18-340	7314150387144	1	158
4656-18-540	7314150387151	1	158
4656-18-940	7314150387168	1	158
4656-20-1320	7314150387212	1	158
4656-20-320	7314150387182	1	158
4656-20-520	7314150387199	1	158
4656-20-920	7314150387205	1	158
4656-22-1320	7314150387250	1	158
4656-22-320	7314150387229	1	158
4656-22-520	7314150387236	1	158
4656-22-920	7314150387243	1	158
4656-24-320	7314150387267	1	158
4656-24-520	7314150387274	1	158
4656-25-1320	7314150387311	1	158
4656-25-320	7314150387281	1	158
4656-25-520	7314150387298	1	158
4656-25-920	7314150387304	1	158
4656-26-520	7314150387328	1	158
4656-28-370	7314150387434	1	158
4656-28-570	7314150387458	1	158
4656-28-670	7314150387489	1	158
4656-28-920	7314150387526	1	158
4656-30-370	7314150387540	1	158
4656-30-570	7314150387571	1	158
4656-32-1320	7314150387649	1	158
4656-32-370	7314150387595	1	158
4656-32-570	7314150387618	1	158
4656-32-920	7314150387632	1	158
4656-35-370	7314150387656	1	158
4656-35-570	7314150387663	1	158
4656-35-670	7314150387670	1	158
4656-37-370	7314150387687	1	158



4656-37-570	7314150387694	1	158
4656-37-920	7314150387700	1	158
4656-38-370	7314150387717	1	158
4656-38-570	7314150387724	1	158
4656-40-1320	7314150387762	1	158
4656-40-370	7314150387731	1	158
4656-40-570	7314150387748	1	158
4656-40-920	7314150387755	1	158
4656-45-570	7314150387779	1	158
4656-45-920	7314150387786	1	158
4656-50-570	7314150387793	1	158
4656-52-570	7314150387809	1	158
4659-ASPHALT-40	7314150388080	1	160
4659-BUSHING-24	7314150388097	1	160
4659-FLAT -28	7314150387922	1	160
4659-FLAT -40	7314150387939	1	160
4659-FLAT -60	7314150387946	1	160
4659-HOLLOW-30	7314150387991	1	160
4659-POINT-28	7314150387892	1	160
4659-POINT-40	7314150387908	1	160
4659-POINT-60	7314150387915	1	160
4659-SPADE-40	7314150388073	1	160
4659-TILE-30-5	7314150388042	1	160
4659-TILE-30-8	7314150388059	1	160
4659-WIDE-30-8	7314150387953	1	160
4659-WIDE-35-11	7314150387977	1	160
4659-WIDE-36-5	7314150387984	1	160
4659-WING-C38-3	7314150388011	1	160
466-1000	7314150128327	4	537
466-1000-M	7314150186105	4	537
466-1200	7314150128334	4	537
466-1200-M	7314150186129	4	537
466-1800	7314150128341	4	537
466-2000	7314150129836	4	537
466-250	7314150128655	10	539
466-400	7314150128297	4	537
466-400-M	7314150128358	4	537
466-600	7314150128303	4	537
466-600-M	7314150128365	4	537
466-800	7314150128310	4	537
466-800-M	7314150186082	4	537
466-BE1	7314150215218	12	539
466-LINE	7314150215249	12	539
466-POST	7314150215232	6	539
4724-JT	7311518265847	1	628
4728-JT	7311518265854	1	628
474-125-0.60	7311518029050	10	546
474-125-0.80	7311518029869	10	546
474-150-0.60	7311518029876	10	546
474-150-0.80	7311518029883	10	546
4750-2PP-1	7314153014733	1	461
4750-3PB-1	7314153014719	1	461
4750-3PB-2	7314150187782	1	468
4750-BWC-1	7314153018809	1	462
4750-DHO-3	7314150289530	1	462
4750-DHO-4	7314150303908	1	468
4750-EP-1	7314153014726	1	462
4750-FOLTC-1	7314153019271	1	460
4750-HDB-2	7314150289486	1	461
4750-HDBS-2	7314150289479	1	461
4750-HDLB-1	7314153014757	1	461
4750-HDLB-TAH	7314150303892	1	469
4750-HHO-2	7314153014863	1	469
4750-JU3PB-1	7314153015747	1	461
4750-KNHO-0	7314150289462	1	462
4750-KNHO-1	7314153015839	1	462
4750-KP-1	7314153014771	1	462
4750-LV-1	7314150358052	1	459
4750-LV-2	7314150393800	1	459
4750-MPH-1	7314150291625	1	462
4750-MTHO-TAH	7314150319589	1	468
4750-PSTB-1	7314150340491	1	629
4750-QRFB-1	7314150289455	1	461
4750-ROCO-1	7314153015273	1	462
4750-ROCO-1T52	7314150407743	1	426
4750-SF-1	7314150326082	1	459
4750-SF-2	7314150326099	1	459
4750-TOCST-1	7314153018779	1	460
4750-UP-1	7314153014795	1	461
4750-UP-2	7314150187768	1	468
4750-VDEC	7314150222377	1	460
4750-VMPH-1	7314153014818	1	462
4750BMC10	7314150264032	1	463
4750BMC3	7314150359639	1	463
4750BMC4	7314150426256	1	463
4750BMC5	7314150264001	1	463
4750BMC5.5	7314150326167	1	463
4750BMC6	7314150264018	1	463
4750BMC7	7314150277605	1	463
4750BMC9	7314150264025	1	463
4750BMC9.5	7314150326174	1	463
4750FB1-19A	7314150277612	1	458
4750FB1-19B	7314150277629	4	458
4750FB2-19A	7314150277636	4	459
4750FB2-19TS001	7314150302772	1	442
4750FB2-24A	7314150277643	2	459



4750FB2W-24A	7314150277650	1	459
4750FB2W-TS001	7314150302765	1	442
4750FB3-12	7314150277667	1	459
4750FB4-18	7314150277674	4	459
4750FB4-18TS001	7314150302758	1	464
4750FB5-FG1	7314150401796	1	460
4750FB5-FG2	7314150401819	1	460
4750FB5A	7314150277704	1	460
4750FB5ATS001	7314150302727	1	426
4750FB5B	7314150277698	1	460
4750FB5BFF1	7314150302734	1	426
4750FB5C	7314150277681	8	460
4750FB7-01	7314150465668	60	460
4750FB7-02	7314150465675	60	461
4750FB7ORBG	7314150465682	120	461
4750FB7ORLT	7314150465699	120	461
4750FB8	7314150465651	4	458
4750IB-A4	7314150472819	1	118
4750IB-A5	7314150472826	1	118
4750IB-A6	7314150472833	1	118
4750IB-A7	7314150472840	1	118
4750PTB50	7314150275007	3	463
4750PTB60	7314150275014	3	463
4750PTB65	7314150345809	2	463
4750PTB65TS5	7314150456260	1	426
4750PTBW47	7314150275021	1	463
4750RC01	7314150220151	1	445
4750RC02	7314150220168	1	445
4750RC021	7314150226641	1	445
4750RCHD-AC1	7314150229857	1	446
4750RCHD00	7314150271603	1	445
4750RCHD01	7314150227426	1	444
4750RCHD011	7314150229802	1	444
4750RCHD01AC1	7314150229819	1	446
4750RCHD01AC2	7314150229826	1	446
4750RCHD01FF1	7314150247578	1	436
4750RCHDW01	7314150227433	1	444
4750RCHDW01AC1	7314150229833	1	446
4750RCHDW01AC2	7314150229840	1	446
4750RCHDW01FF1	7314150247561	1	436
4750RCHDW01FF2	7314150249183	1	436
4750RCHDW01FF3	7314150249190	1	422
4750RCHDW01FF4	7314150309580	1	440
4750RCHDW01FF9	7314150345533	1	441
4750RCHDW01RED	7314150407538	1	444
4750RCHDW02	7314150227440	1	444
4750RCHDW02FF1	7314150267422	1	441
4750RCHDW02FF15	7314150347698	1	443
4750RCHDW02FF2	7314150306787	1	444
4750RCHDW02FF4	7314150309559	1	443
4750RCHDW02RED	7314150407545	1	444
4750RCHDW02RF1V	7314150422081	1	422
4750RCHDW10	7314150425587	1	445
4750RCW01	7314150220182	1	445
4750RCW011	7314150226627	1	445
4750RCWD-AC1	7314150277179	1	445
4750RCWD-AC2	7314150277186	1	445
4750RCWD-AC3	7314150277193	1	445
4750RCWD-AC4	7314150277209	1	446
4750RCWD4	7314150277124	1	445
4750RCWD4-OR	7314150409501	1	445
4750RCWD4FF1	7314150302413	1	421
479-08	7311518025441	6	587
479-12	7311518025458	6	587
479-16	7311518025465	6	587
479-20	7314150319862	6	587
479-24	7311518025472	6	587
479-32	7311518025489	6	587
479F-08	7314150441952	6	587
479F-12	7314150441976	6	587
479F-16	7314150441983	6	587
479F-20	7314150441990	6	587
479F-24	7314150442003	6	587
479F-32	7314150442010	6	587
480-08	7311518025496	4	588
480-10	7311518025502	4	588
480-12	7311518025519	4	588
480-14	7311518025526	4	588
480-20	7314150319763	4	588
481-100	7311518005030	6	587
481-1000	7311518005092	6	587
481-1500	7311518025533	6	587
481-200	7311518005047	6	587
481-2000	7314150319855	6	587
481-300	7311518005054	6	587
481-400	7311518005061	6	587
481-500	7311518005078	6	587
481-800	7311518025540	6	587
481F-100	7314150442072	6	587
481F-1000	7314150442133	6	587
481F-1500	7314150442140	4	587
481F-200	7314150442089	6	587
481F-2000	7314150442157	4	587
481F-300	7314150442096	6	587
481F-400	7314150442102	6	587
481F-500	7314150442119	6	587



481F-800	7314150442126	6	587
482-25	7311518025557	6	587
482-28	7311518025564	6	587
482-30	7311518025571	6	587
482-35	7311518025595	6	587
482-40	7311518025601	6	587
482-45	7311518027551	6	587
482F-25	7314150442225	4	588
482F-28	7314150442232	4	588
482F-30	7314150442249	6	588
482F-35	7314150442256	4	588
482F-40	7314150442263	2	588
482F-45	7314150442270	4	588
483-16	7311518024314	6	588
483-20	7311518024321	6	588
483-22	7311518005108	6	588
483-25	7311518005115	6	588
483-28	7311518024284	6	588
483-30	7311518024291	6	588
4830	7314150100057	3	234
4831	7314150103393	3	234
4833	7314150100064	3	235
483F-16	7314150442164	6	588
483F-20	7314150442171	6	588
483F-22	7314150442188	6	588
483F-25	7314150442195	6	588
483F-28	7314150442201	6	588
483F-30	7314150442218	4	588
484-1000	7311518005122	6	588
484-1250	7311518005139	6	588
484-1500	7311518005146	6	588
484-2000	7311518024338	6	588
484F-1000	7314150442027	6	589
484F-1250	7314150442034	6	589
484F-1500	7314150442041	6	589
484F-2000	7314150442058	4	589
485	7311518005153	6	588
485W-650	7314150319770	4	588
485W-750	7314150319787	4	588
486	7311518005160	4	589
486-1800	7314150315307	5	539
486-1800WH	7314150315338	5	539
486-2000	7314150315314	5	539
486-2000WH	7314150315345	5	539
486-2400	7314150315321	5	539
486-2400WH	7314150315352	5	539
486-700	7314150338078	6	589
486F-700	7314150338085	6	589
486W-500	7314150319794	4	589
486W-600	7314150319800	4	589
488-2000	7314150337972	2	589
488-3000	7314150337989	2	589
488-4000	7314150337996	2	589
488-5000	7314150338009	2	589
488-6000	7314150338016	1	589
488F-2000	7314150338023	2	589
488F-3000	7314150338030	2	589
488F-4000	7314150338047	2	589
488F-5000	7314150338054	4	589
488F-6000	7314150338061	2	589
489-1100	7314150133055	1	591
489-1800	7314150133062	1	591
489-2700	7314150133079	1	591
489-3600	7314150133086	1	591
489-4500	7314150133093	1	591
489-5400	7314150133109	1	591
490-3.5	7311518025373	4	588
491-3000	7314150345199	4	591
491-4000	7314150345205	4	591
491-5000	7314150345212	4	591
491-6000	7314150345229	4	591
492-3.5	7311518025380	4	588
493-500	7314150338139	6	590
493-600	7314150338146	6	590
493F-500	7314150338153	6	590
493F-600	7314150338160	6	590
494-600	7311518025397	4	590
495-500	7314150338191	6	590
495-600	7314150338207	6	590
495F-500	7314150338184	6	590
495F-600	7314150338177	1	590
496-1500	7314150315147	5	539
496-1800	7314150315154	5	539
496-SPARE	7314150329304	1	539
4M-10-11	7314151829438	10	56
4M-12-13	7314151829445	10	56
4M-14-15	7314151829476	10	56
4M-16-17	7314151829490	10	56
4M-17-19	7314151829506	10	56
4M-18-19	7314151829513	10	56
4M-20-22	7314151829520	10	56
4M-21-23	7314150205363	5	56
4M-24-26	7314150205370	1	56
4M-24-27	7314151829551	1	56
4M-25-28	7314150205387	1	56
4M-27-29	7314150205394	1	56



4M-30-32



4M-30-32	7314151829575	1	56
4M-6-7	7314151829407	10	56
4M-8-9	7314151829414	10	56
4M/10C	7314150212972	1	56
4M/10T	7314151829605	1	56
4M/12C	7314150212989	1	57
4M/8	7314150180493	1	57
5-600-21-D-1P	7311518189341	10	36
5-610-21-D-1P	7311518189358	1	36
5-630-21-D-1P	7311518189365	1	36
5-670-21-D-1P	7311518189389	1	36
500-12	7314150390977	1	262
500-14	7314150414505	1	262
500-15	7314150390984	1	262
500-16	7314150414512	1	262
500-18	7314150414543	1	262
500-22	7314150414567	1	262
502	7311518130589	5	563
502-SET2	7311518130664	5	563
502-SET6	7311518130633	5	563
5050	7314151083359	1	350
51-12	7311518044565	10	627
51-21	7311518003906	10	627
51-24	7311518003913	10	627
51-30	7311518003920	10	627
51-32	7311518003937	10	627
51-36	7311518003944	10	627
510031	7314150216338	5	207
510033	7314150216345	5	207
510034	7314150216314	10	206
5124-JS-H	7311518219352	4	628
5128-JS-H	7311518219369	4	628
52	7311518276027	12	302
527 D-160	7314150032723	5	228
527 D-200	7314150032730	5	228
527 GC-160	7314150205653	3	228
527 GC-200	7314150205660	3	228
527V-160	7314150126811	2	493
527V-200	7314150126828	2	493
528-700	7311518188993	1	569
528-COM	7311518188986	1	569
529-16-L	7314150198139	4	586
529-16-XL	7314150198146	4	586
529-20-L	7314150198160	4	586
529-20-XL	7314150198153	4	586
529-SK	7314150351350	1	569
529S-16-XL	7314150340330	4	586
529S-20-XL	7314150340347	4	586
541 D-150	7314150032754	5	229
541 D-200	7314150032761	5	229
541 D-250	7314150032778	5	229
5418	7314151084370	1	533
5419/6T	7314151821562	1	533
541D-180	7314150127160	5	229
541D-225	7314150127290	5	229
5463 AMT	7314151085025	5	528
5463 R	7314151085063	5	531
5463-120	7314151085001	5	531
5464 R	7314151085100	5	531
5464-105	7314151085087	5	531
54640	7314150215720	1	180
5465 AMT	7314151085148	5	528
5465 R	7314151085162	5	531
5468-112	7314151085247	5	528
5469 AMI	7314151337803	1	528
5469 B	7314151085322	5	528
5469 BI	7314151085346	5	528
5469 BR	7314151085384	5	528
5469 I	7314151085407	5	528
5469 R	7314151085421	5	528
5469-127	7314151085285	5	528
5470 I-140	7314151085506	5	531
5470 I-160	7314151085520	5	531
5470 R-140	7314151085568	5	531
5470 R-160	7314151085582	5	531
5470-120	7314151085452	5	531
5470-140	7314151085445	5	531
5470-160	7314151085469	5	531
5471 F-120	7314151085681	5	528
5471 F-145	7314151085704	5	528
5471 F-200	7314151085728	5	528
5471 F-250	7314151085742	5	528
5471 F-300	7314151085766	5	528
5471 FI-120	7314151085780	5	528
5471 FI-145	7314151085803	5	528
5471 FI-200	7314151085827	5	528
5471 FR-120	7314151085889	5	528
5471 FR-145	7314151085902	5	528
5473-90	7314151086183	5	531
5475 K	7314151086244	5	528
5475 R	7314151086268	5	528
5476 H	7314151086305	5	531
5479-130	7314151086398	5	528
5484 R	7314151086633	5	531
5488 AM	7314151821166	5	530
5489 AM	7314151821173	5	530



5490 AM	7314151821180	5	530
5493-115	7314151821234	5	531
5515B	7314151086978	25	351
5515GV	7314151481483	1	350
5515L	7314151481568	1	351
5515M	7314151086985	1	351
5515T	7314151589172	25	351
5515T-52	7314153021939	25	351
5516	7314151086992	5	528
5516 I	7314151087029	5	528
5517	7314151573843	5	528
5517 I	7314151573928	5	528
5518	7314151087043	5	528
5521	7314150215713	1	176
5540 AM	7314151821319	5	529
5541 AM	7314151821326	5	529
5543 AM	7314151821340	5	529
5544 AM	7314151821357	5	529
5545 AM	7314151821364	5	529
5546 AM	7314151821371	5	529
5547 AM	7314151821388	5	529
5549 AM	7314151821401	5	529
5550-3.2	7314151475673	10	533
5550-4.5	7314151475758	5	533
5551	7314151378479	1	533
5552	7314151378554	1	533
5553	7314151378639	1	533
5554	7314151378714	1	533
5568/5	7314151821210	1	531
5570/7	7314151473891	1	529
5571-145	7314151472818	5	530
5572-145	7314151473037	5	530
5573-145	7314151473112	5	530
5574-145	7314151473389	5	531
5575-145	7314151473464	5	529
5576-145	7314151473549	5	529
5577-145	7314151574062	5	531
5578-115	7314151547769	5	530
5579-115	7314151547844	5	530
5588 AM	7314151821432	5	530
5589 AM	7314151821449	5	530
5590 AM	7314151821456	5	530
5600/4	7314151436773	1	533
5724-JS	7311518216085	1	628
5728-JS	7311518216092	1	628
5750	7311518280949	1	334
583D	7314150023721	4	573
584D	7314150023745	4	573
585D	7314150104185	4	573
586D	7314150104208	4	573
59/S100BC	7314150337637	1	176
59/S100BC-IP	7314150337644	8	176
59/S10BC	7314150413003	1	173
59/S28-4	7314151847173	1	174
59/S31B	7314150325788	6	175
59/S31B-IP	7314150325795	12	175
59/S35BC	7314150412990	1	174
59/S36BCR	7314150413232	6	203
59/S54BC	7314150337613	10	175
59/S54BC-IP	7314150337620	8	175
59S/0.5-3.0	7314150199815	1	168
59S/0.5-3.0-3P	7314150259205	50	168
59S/0.5-4.0	7314150199822	1	168
59S/0.5-4.0-3P	7314150259212	50	168
59S/0.6-3.5	7314150199839	1	168
59S/0.6-3.5-3P	7314150259229	50	168
59S/0.6-4.5	7314150198801	1	168
59S/0.6-4.5-3P	7314150201600	1	168
59S/0.8-5.5	7314150198849	1	168
59S/0.8-5.5-3P	7314150201624	1	168
59S/1.0-5.5	7314150198863	1	168
59S/1.0-5.5-3P	7314150258963	50	168
59S/1.2-6.5	7314150198887	1	168
59S/1.2-6.5-3P	7314150258970	50	168
59S/1.2-8.0	7314150198900	1	168
59S/1.2-8.0-3P	7314150258987	1	168
59S/1.6-10	7314150199846	1	168
59S/1.6-10-3P	7314150259236	50	168
59S/1.6-9.0	7314150199853	1	168
59S/1.6-9.0-3P	7314150259243	50	168
59S/125PH1	7314150206834	1	172
59S/125PH1-2P	7314150260553	25	172
59S/125PH2	7314150204298	1	172
59S/125PH2-2P	7314150260560	25	172
59S/125PH3	7314150204304	1	172
59S/125PH3-2P	7314150260577	25	172
59S/125PZ1	7314150200733	1	172
59S/125PZ1-2P	7314150260522	25	172
59S/125PZ2	7314150200740	1	172
59S/125PZ2-2P	7314150260539	25	172
59S/125PZ3	7314150200757	1	172
59S/125PZ3-2P	7314150260546	25	172
59S/150T15	7314150200764	1	173
59S/150T15-2P	7314150260584	1	173
59S/150T20	7314150200771	1	173
59S/150T20-2P	7314150260591	1	173



Part Number	Quantity	Price
59S/150T25	1	173
59S/150T25-2P	1	173
59S/150T30	1	173
59S/150T30-2P	1	173
59S/17-1	1	174
59S/17-2	1	174
59S/17-3	1	174
59S/22-1	12	174
59S/22-2	12	174
59S/31-1	12	175
59S/31-2	1	175
59S/31-3	12	175
59S/50/0.6-3.5	1	171
59S/50/0.8-4.0	1	171
59S/50/0.8-5.5	1	171
59S/50/1.0-6.0	1	171
59S/50/1.2-6.5	1	171
59S/50/3.5-2P	50	171
59S/50/4.0-2P	50	171
59S/50/5.5-2P	50	171
59S/50/6.0-2P	1	171
59S/50/6.5-2P	50	171
59S/50H1/16	1	171
59S/50H1/4	1	171
59S/50H1/8	1	171
59S/50H2	1	171
59S/50H2-2P	50	171
59S/50H2.5	1	171
59S/50H2.5-2P	50	171
59S/50H3	1	171
59S/50H3-2P	50	171
59S/50H3/16	1	171
59S/50H3/32	1	171
59S/50H3/8	1	171
59S/50H4	1	171
59S/50H4-2P	50	171
59S/50H5	1	171
59S/50H5-2P	50	171
59S/50H5/16	1	171
59S/50H5/32	1	171
59S/50H5/64	1	171
59S/50H6	1	171
59S/50H6-2P	50	171
59S/50H7/32	1	171
59S/50H7/64	1	171
59S/50H8	1	171
59S/50H8-2P	50	171
59S/50H9/64	1	171
59S/50PH1	1	171
59S/50PH1-2P	1	171
59S/50PH2	1	171
59S/50PH2-2P	1	171
59S/50PH3	1	171
59S/50PH3-2P	1	171
59S/50PZ1	1	171
59S/50PZ1-2P	1	171
59S/50PZ2	1	171
59S/50PZ2-2P	1	171
59S/50PZ3	1	171
59S/50PZ3-2P	1	171
59S/50R1	1	171
59S/50R1-2P	50	171
59S/50R2	1	171
59S/50R2-2P	50	171
59S/50R3	1	171
59S/50R3-2P	50	171
59S/50T10	1	171
59S/50T10-2P	1	171
59S/50T15	1	171
59S/50T15-2P	1	171
59S/50T20	1	171
59S/50T20-2P	1	171
59S/50T25	1	171
59S/50T25-2P	1	171
59S/50T27	1	171
59S/50T30	1	171
59S/50T30-2P	1	171
59S/50T40	1	171
59S/50T40-2P	50	171
59S/50T8	1	171
59S/50T8-2P	50	171
59S/7-1	1	173
59S/7-2	1	173
59S/7-3	1	173
59S/7-4	1	173
59S/70PH1	1	172
59S/70PH1-2P	1	172
59S/70PH2	1	172
59S/70PH2-2P	25	172
59S/70PZ1	1	172
59S/70PZ1-2P	1	172
59S/70PZ2	1	172
59S/70PZ2-2P	1	172
59S/70PZ3	1	172
59S/70PZ3-2P	1	172
59S/70T10	1	172

Part Number	Quantity	Price
59S/70T10-2P	1	172
59S/70T15	1	172
59S/70T15-2P	25	172
59S/70T20	1	172
59S/70T20-2P	1	172
59S/70T25	1	172
59S/70T25-2P	25	172
59S/70T27	1	172
59S/70T27-2P	1	172
59S/70T30	1	172
59S/70T30-2P	1	172
59S/70T40	1	172
59S/70T40-2P	1	172
59S/70TR15	1	172
59S/70TR15-2P	1	172
59S/70TR20	1	172
59S/70TR20-2P	25	172
59S/70TR25	1	172
59S/70TR25-2P	25	172
59S/70TR27	1	172
59S/70TR27-2P	25	172
59S/70TR30	1	172
59S/70TR30-2P	25	172
59S/70TR40	1	172
59S/70TR40-2P	25	172
59S/H1.5	1	170
59S/H1.5-3P	50	170
59S/H1/16	1	170
59S/H1/16-3P	50	170
59S/H1/4	1	170
59S/H1/4-3P	50	170
59S/H1/8	1	170
59S/H1/8-3P	50	170
59S/H10	1	170
59S/H10-3P	25	170
59S/H2	1	170
59S/H2-3P	50	170
59S/H2.5	1	170
59S/H2.5-3P	50	170
59S/H3	1	170
59S/H3-3P	1	170
59S/H3/16	1	170
59S/H3/16-3P	1	170
59S/H3/32	1	170
59S/H3/32-3P	50	170
59S/H3/8	1	170
59S/H3/8-3P	25	170
59S/H3BALL	1	172
59S/H3BALL-2P	1	172
59S/H4	1	170
59S/H4-3P	1	170
59S/H4-IPB	500	170
59S/H4BALL	1	172
59S/H4BALL-2P	1	172
59S/H5	1	170
59S/H5-3P	1	170
59S/H5/16	1	170
59S/H5/16-3P	50	170
59S/H5/32	1	170
59S/H5/32-3P	50	170
59S/H5/64	1	170
59S/H5/64-3P	50	170
59S/H5BALL	1	172
59S/H5BALL-2P	1	172
59S/H6	1	170
59S/H6-3P	1	170
59S/H6BALL	1	172
59S/H6BALL-2P	1	172
59S/H7/32	1	170
59S/H7/32-3P	50	170
59S/H7/64	1	170
59S/H7/64-3P	50	170
59S/H8	1	170
59S/H8-3P	1	170
59S/H8BALL	1	172
59S/H8BALL-2P	1	172
59S/H9/64	1	170
59S/H9/64-3P	1	170
59S/HBALL-3P	1	172
59S/M3	1	170
59S/M3-3P	50	170
59S/M4	1	170
59S/M4-3P	50	170
59S/M5	1	170
59S/M5-3P	50	170
59S/M6	1	170
59S/M6-3P	50	170
59S/M8	1	170
59S/M8-3P	50	170
59S/PH0	1	169
59S/PH0-3P	50	169
59S/PH1	1	169
59S/PH1-30P	1	169
59S/PH1-3P	1	169
59S/PH1-IPB	100	169
59S/PH1-IPB	500	169
7314150260355	1	172
7314150200566	1	172
7314150260362	25	172
7314150200573	1	172
7314150201839	1	172
7314150200580	1	172
7314150260379	25	172
7314150200597	1	172
7314150260386	1	172
7314150200603	1	172
7314150260393	1	172
7314150200610	1	172
7314150260409	1	172
7314150200627	1	172
7314150260416	1	172
7314150200634	1	172
7314150260423	25	172
7314150200641	1	172
7314150260430	25	172
7314150200658	1	172
7314150260447	25	172
7314150200665	1	172
7314150260454	25	172
7314150200672	1	172
7314150260461	25	172
7314150198924	1	170
7314150258994	50	170
7314150204205	1	170
7314150259021	50	170
7314150199266	1	170
7314150259120	50	170
7314150199174	1	170
7314150259069	50	170
7314150199075	1	170
7311518333638	25	170
7314150198955	1	170
7314150259007	50	170
7314150198962	1	170
7314150259014	50	170
7314150198986	1	170
7314150201662	1	170
7314150199228	1	170
7314150259090	1	170
7314150199136	1	170
7314150259045	50	170
7314150204212	1	170
7314150259144	25	170
7314150200689	1	172
7314150260478	1	172
7314150198993	1	170
7314150201679	1	170
7314150225767	500	170
7314150200696	1	172
7314150260485	1	172
7314150199013	1	170
7314150201686	1	170
7314150199273	1	170
7314150259137	50	170
7314150199204	1	170
7314150259083	50	170
7314150199112	1	170
7314150259038	50	170
7314150200702	1	172
7314150260492	1	172
7314150199037	1	170
7314150201693	1	170
7314150200719	1	172
7314150260508	1	172
7314150199242	1	170
7314150259113	50	170
7314150199150	1	170
7314150259052	50	170
7314150199051	1	170
7314150201709	1	170
7314150200726	1	172
7314150260515	1	172
7314150199198	1	170
7314150259076	1	170
7314150201716	1	172
7314150199730	1	170
7314150259151	50	170
7314150199754	1	170
7314150259168	50	170
7314150199778	1	170
7314150259175	50	170
7314150199792	1	170
7314150259182	50	170
7314150199808	1	170
7314150259199	50	170
7314150198177	1	169
7314150258819	50	169
7314150198313	1	169
7314150200801	1	169
7314150201396	1	169
7314150206780	100	169
7314150225743	500	169



# 59S/PH1COMBI-2P



59S/PH1COMBI-2P	7314150215669	1	172
59S/PH2	7314150198320	1	169
59S/PH2-30P	7314150200818	1	169
59S/PH2-3P	7314150201402	1	169
59S/PH2-IP	7314150206797	100	169
59S/PH2-IPB	7314150204038	500	169
59S/PH2COMBI-2P	7314150203604	1	172
59S/PH2G	7314150204182	1	169
59S/PH2G-30P	7314150200832	1	169
59S/PH2G-3P	7314150259250	50	169
59S/PH3	7314150198351	1	169
59S/PH3-30P	7314150200825	1	169
59S/PH3-3P	7314150201419	1	169
59S/PH3-IPB	7314150225750	500	169
59S/PH3COMBI-2P	7314150203611	1	172
59S/PH4	7314150198368	1	169
59S/PH4-3P	7314150258826	25	169
59S/PZ0	7314150198375	1	169
59S/PZ0-3P	7314150258833	50	169
59S/PZ1	7314150198382	1	169
59S/PZ1-30P	7314150200849	1	169
59S/PZ1-3P	7314150201426	1	169
59S/PZ1-IP	7314150206803	100	169
59S/PZ1-IPB	7314150204373	500	169
59S/PZ2	7314150198405	1	169
59S/PZ2-30P	7314150200856	1	169
59S/PZ2-3P	7314150201433	1	169
59S/PZ2-IP	7314150206810	100	169
59S/PZ2-IPB	7314150204380	500	169
59S/PZ3	7314150198429	1	169
59S/PZ3-30P	7314150200863	1	169
59S/PZ3-3P	7314150201440	1	169
59S/PZ3-IPB	7314150225736	500	169
59S/PZ4	7314150198436	1	169
59S/R1	7314150199310	1	170
59S/R1-3P	7314150201631	1	170
59S/R2	7314150199341	1	170
59S/R2-3P	7314150201648	1	170
59S/R3	7314150199365	1	170
59S/R3-3P	7314150201655	1	170
59S/R4	7314150232109	1	170
59S/T10	7314150198528	1	169
59S/T10-30P	7314150200870	1	169
59S/T10-3P	7314150201457	1	169
59S/T10CS	7314150444014	20	169
59S/T15	7314150198535	1	169
59S/T15-30P	7314150200887	1	169
59S/T15-3P	7314150201464	1	169
59S/T15CS	7314150444021	20	169
59S/T20	7314150198542	1	169
59S/T20-30P	7314150200894	1	169
59S/T20-3P	7314150201471	1	169
59S/T20CS	7314150444038	20	169
59S/T25	7314150198566	1	169
59S/T25-30P	7314150200900	1	169
59S/T25-3P	7314150201488	1	169
59S/T25CS	7314150444045	20	169
59S/T27	7314150198580	1	169
59S/T27-3P	7314150201495	1	169
59S/T27CS	7314150444052	20	169
59S/T3	7314150198443	1	169
59S/T3-3P	7314150258840	50	169
59S/T30	7314150198597	1	169
59S/T30-30P	7314150200924	1	169
59S/T30-3P	7314150201501	1	169
59S/T30CS	7314150444069	20	169
59S/T4	7314150198450	1	169
59S/T4-3P	7314150258857	50	169
59S/T40	7314150198610	1	169
59S/T40-30P	7314150200931	1	169
59S/T40-3P	7314150201518	1	169
59S/T40CS	7314150444076	20	169
59S/T45	7314150198641	1	169
59S/T45-3P	7314150258918	50	169
59S/T5	7314150198467	1	169
59S/T5-3P	7314150258864	50	169
59S/T50	7314150198658	1	169
59S/T50-3P	7314150258925	50	169
59S/T6	7314150198474	1	169
59S/T6-3P	7314150258871	50	169
59S/T7	7314150198498	1	169
59S/T7-3P	7314150258888	50	169
59S/T8	7314150198504	1	169
59S/T8-3P	7314150258895	50	169
59S/T9	7314150198511	1	169
59S/T9-3P	7314150258901	50	169
59S/TCS11-1	7314150444083	10	173
59S/TR10	7314150198702	1	169
59S/TR10-3P	7314150201525	1	169
59S/TR15	7314150198719	1	169
59S/TR15-3P	7314150201532	1	169
59S/TR20	7314150198726	1	169
59S/TR20-3P	7314150201549	1	169
59S/TR25	7314150198740	1	169
59S/TR25-3P	7314150201556	1	169
59S/TR27	7314150198757	1	169



59S/TR27-3P	7314150201570	1	169
59S/TR30	7314150198771	1	169
59S/TR30-3P	7314150201587	1	169
59S/TR40	7314150198795	1	169
59S/TR40-3P	7314150201594	1	169
59S/TR7	7314150198672	1	169
59S/TR7-3P	7314150258932	50	169
59S/TR8	7314150198689	1	169
59S/TR8-3P	7314150258949	50	169
59S/TR9	7314150198696	1	169
59S/TR9-3P	7314150258956	50	169
59S/TS-0	7314150199389	1	170
59S/TS-1	7314150199396	1	170
59S/TS-1/4	7314150199594	1	170
59S/TS-10	7314150199570	1	170
59S/TS-2	7314150199419	1	170
59S/TS-3	7314150199433	1	170
59S/TS-4	7314150199457	1	170
59S/TS-5	7314150199518	1	170
59S/TS-6	7314150199532	1	170
59S/TS-8	7314150199556	1	170
59S/TW0	7314150199617	1	170
59S/TW1	7314150199631	1	170
59S/TW2	7314150199655	1	170
59S/TW3	7314150199679	1	170
59S/TW4	7314150199693	1	170
59S/TW5	7314150199716	1	170
6	8412814220048	1	211
6-342-06-2-0	7311518021719	10	32
6-342-06-2-2	7311518244170	5	32
6-342-08-1-0	7311518021726	10	32
6-342-08-1-2	7311518028282	5	32
6-342-08-2-0	7311518021733	10	32
6-342-08-2-2	7311518005375	5	32
6-342-10-1-0	7311518021757	10	32
6-342-10-1-2	7311518005382	5	32
6-342-10-2-0	7311518021764	10	32
6-342-10-2-2	7311518005399	5	32
6-343-08-2-0	7311518021801	10	32
6-343-08-2-2	7311518001070	5	32
6-343-08-3-0	7311518021818	10	32
6-343-10-2-0	7311518021825	10	32
6-343-10-2-2	7311518001094	5	32
6-343-10-3-0	7311518021832	10	32
6-344-08-2-0	7311518021887	10	31
6-344-08-2-2	7311518005344	5	32
6-344-10-2-0	7311518021900	10	31
6-344-10-2-2	7311518005351	5	32
6-345-08-1-2	7311518028312	5	32
6-345-08-2-0	7311518021948	10	32
6-345-08-2-2	7311518005412	5	32
6-345-10-1-2	7311518005429	5	32
6-345-10-2-0	7311518021955	10	32
6-470-08-2-2	7311518242008	5	32
600-3	7314150124787	1	201
600.003.010	8412814600000	1	362
600.005.012	8412814600017	1	362
601000800	8413345202299	1	583
601001000	8413345202305	1	583
601001250	8413345202312	1	583
601001500	8413345202329	1	583
6010H0800	8413345015769	1	584
6010H1000	8413345015776	1	584
6010H1250	8413345015783	1	584
6010H1500	8413345015790	1	584
6010M0800	8413345015806	1	583
6010M1000	8413345116619	1	583
6010M1250	8413345015820	1	583
6010M1500	8413345015837	1	583
602-4-LA	7314150224357	1	201
604-5	7314150124800	1	201
6040M0630	8413345124126	1	584
605-10-PC-AU	7314150186334	1	203
605-6	7314150153770	1	202
605-6-PC	7314150184057	1	203
606-6	7314150124824	1	202
6070H1000	8413345030656	1	583
6070H1250	8413345084833	1	583
6070H1500	8413345030663	1	583
6070H1750	8413345030670	1	583
607201000	8413345030533	1	583
607201250	8413345030540	1	583
607201500	8413345030557	1	583
607201750	8413345030564	1	583
6072M1000	8413345015813	1	583
6072M1500	8413345137454	1	583
6072M1750	8413345030687	1	583
60T/17-1	7314150191529	1	167
60T/31-1	7314150191482	12	167
60T/7-1	7314150191574	1	167
60T/PH1	7314150199488	1	167
60T/PH2	7314150199495	1	167
60T/PH3	7314150199501	1	167
60T/PZ1	7314150199525	1	167
60T/PZ2	7314150199549	1	167
60T/PZ3	7314150199563	1	167

60T/T10	7314150199648	1	167
60T/T15	7314150199662	1	167
60T/T20	7314150199686	1	167
60T/T25	7314150199709	1	167
60T/T27	7314150199723	1	167
60T/T30	7314150199747	1	167
60T/T40	7314150199761	1	167
60T/T7	7314150199587	1	167
60T/T8	7314150199600	1	167
60T/T9	7314150199624	1	167
610-6	7314150124848	1	202
611-10-200	7314150124428	10	200
611-3.5-100	7314150124336	10	200
611-3.5-75	7314150124329	10	200
611-4-100	7314150124350	10	200
611-4-75	7314150124343	10	200
611-5.5-100	7314150124367	10	200
611-5.5-125	7314150124381	10	200
611-6.5-125	7314150124374	10	200
611-6.5-150	7314150124398	10	200
611-6.5-25	7314150124602	10	200
611-8-150	7314150124404	10	200
611-8-175	7314150124411	10	200
612-5	7314150124817	1	201
613-3-100	7314150124442	10	200
613-3-75	7314150124435	10	200
613-3.5-100	7314150124459	10	200
613-4-100	7314150124466	10	200
613-4-125	7314150124473	10	200
613-5.5-150	7314150124497	10	200
613-6.5-150	7314150124503	10	200
615-0-75	7314150124558	10	200
615-1-100	7314150124565	10	200
615-2-125	7314150124572	10	200
615-2-25	7314150124596	10	200
615-3-150	7314150124589	10	200
616-0-75	7314150124510	10	200
616-1-100	7314150124527	10	200
616-2-125	7314150124534	10	200
616-3-150	7314150124541	10	200
618-10-75	7314150124619	10	201
618-15-100	7314150124626	10	201
618-20-100	7314150124633	10	201
618-25-125	7314150124640	10	201
618-27-125	7314150124657	10	201
618-30-150	7314150124664	10	201
618-40-150	7314150124671	10	201
61H/50PH1	7314150200382	1	168
61H/50PH2	7314150200399	1	168
61H/50PH3	7314150200405	1	168
61H/50PZ1	7314150200412	1	168
61H/50PZ2	7314150200429	1	168
61H/50PZ3	7314150200436	1	168
61H/50T10	7314150200443	1	168
61H/50T15	7314150200450	1	168
61H/50T20	7314150200467	1	168
61H/50T25	7314150200474	1	168
61H/50T30	7314150200481	1	168
61H/50T40	7314150200498	1	168
61H/PH1	7314150199006	1	168
61H/PH2	7314150199020	1	168
61H/PH3	7314150199044	1	168
61H/PZ1	7314150199068	1	168
61H/PZ2	7314150199082	1	168
61H/PZ3	7314150199105	1	168
61H/T10	7314150199129	1	168
61H/T15	7314150199143	1	168
61H/T20	7314150199167	1	168
61H/T25	7314150199181	1	168
61H/T30	7314150199211	1	168
61H/T40	7314150199235	1	168
620-6	7314150128594	1	202
622-3P	7314150427727	1	241
6221D	7314150421596	10	240
6221D IP	7314150440368	10	240
6222D	7314150421589	10	240
6222D IP	7314150437702	10	240
6223D	7314150421558	8	240
6223D IP	7314150421794	8	240
6224	7314150421619	4	240
6224D	7314150421565	5	240
6224D IP	7314150421800	5	240
6225D	7314150421572	5	240
6225D IP	7314150421817	5	240
623-3-100	7314150128518	10	491
623-3.5-100	7314150128525	10	491
623-4-100	7314150128532	10	491
623-5.5-125	7314150128549	10	491
623-6.5-150	7314150128556	10	491
625	7311518221614	5	546
625-0-100	7314150128563	10	491
625-1-150	7314150128570	10	491
625-2-175	7314150128587	10	491
625-DROP	7311518221638	10	546
625-PEAR	7311518221621	10	546
625-ROUND	7311518221645	10	546

62TIN/50PH1	7314150200504	1	166
62TIN/50PH2	7314150200511	1	166
62TIN/50PH3	7314150200528	1	166
62TIN/50PZ1	7314150200535	1	166
62TIN/50PZ2	7314150200542	1	166
62TIN/50PZ3	7314150200559	1	166
62TIN/7-1	73141502003505	1	166
62TIN/PH1	7314150199259	1	166
62TIN/PH2	7314150199297	1	166
62TIN/PH3	7314150199303	1	166
62TIN/PZ1	7314150199327	1	166
62TIN/PZ2	7314150199334	1	166
62TIN/PZ3	7314150199358	1	166
62TIN/T10	7314150199372	1	166
62TIN/T15	7314150199402	1	166
62TIN/T20	7314150199426	1	166
62TIN/T25	7314150199440	1	166
62TIN/T30	7314150199464	1	166
62TIN/T40	7314150199471	1	166
63D/50PH1	7314150200351	1	166
63D/50PH2	7314150200368	1	166
63D/50PH3	7314150200375	1	166
63D/50PZ1	7314150200320	1	166
63D/50PZ2	7314150200337	1	166
63D/50PZ3	7314150200344	1	166
63D/7-1	7314150191604	1	166
63D/PH1	7314150198917	1	165
63D/PH2	7314150198931	1	165
63D/PH2G	7314150198979	1	165
63D/PH3	7314150198948	1	165
63D/PZ1	7314150198856	1	165
63D/PZ2	7314150198870	1	165
63D/PZ3	7314150198894	1	165
63D/T10	7314150198665	1	165
63D/T15	7314150198733	1	165
63D/T15-2P	7314150201006	1	165
63D/T20	7314150198764	1	165
63D/T20-2P	7314150201013	1	165
63D/T25	7314150198818	1	165
63D/T25-2P	7314150201020	1	165
63D/T30	7314150198788	1	165
63D/T30-2P	7314150262311	1	165
63D/T40	7314150198832	1	165
63D/T40-2P	7314150262328	1	165
64A/PH1	7314150198481	1	167
64A/PH1-2P	7314150200948	1	167
64A/PH2	7314150198559	1	167
64A/PH2-2P	7314150200955	1	167
64A/PH3	7314150198573	1	167
64A/PH3-2P	7314150200962	1	167
64A/PZ1	7314150198603	1	167
64A/PZ1-2P	7314150200979	1	167
64A/PZ2	7314150198627	1	167
64A/PZ2-2P	7314150200986	1	167
64A/PZ3	7314150198634	1	167
64A/PZ3-2P	7314150200993	1	167
650	7311518221591	5	546
65I/7-1	7314150204113	1	525
65I/PH1	7314150199785	1	525
65I/PH1-2P	7314150207985	1	525
65I/PH2	7314150199884	1	525
65I/PH2-2P	7314150201259	1	525
65I/PH3	7314150199907	1	525
65I/PH3-2P	7314150201266	1	525
65I/PZ1	7314150199921	1	525
65I/PZ1-2P	7314150201273	1	525
65I/PZ2	7314150199945	1	525
65I/PZ2-2P	7314150201280	1	525
65I/PZ3	7314150199969	1	525
65I/PZ3-2P	7314150201297	1	525
65I/T10	7314150199983	1	525
65I/T10-2P	7314150201303	1	525
65I/T15	7314150199990	1	525
65I/T15-2P	7314150201310	1	525
65I/T20	7314150200016	1	525
65I/T20-2P	7314150201327	1	525
65I/T25	7314150200030	1	525
65I/T25-2P	7314150201334	1	525
65I/T30	7314150200054	1	525
65I/T30-2P	7314150201341	1	525
65I/T40	7314150200078	1	525
65I/T40-2P	7314150201358	1	525
665	7311518221607	5	546
6700SM-10	7314151088026	5	66
6700SM-11	7314151088033	5	66
6700SM-12	7314151088040	5	66
6700SM-13	7314151088057	5	66
6700SM-14	7314151088064	5	66
6700SM-4	7314151087944	5	66
6700SM-4.5	7314151087951	5	66
6700SM-5	7314151087968	5	66
6700SM-5.5	7314151087975	5	66
6700SM-6	7314151087982	5	66
6700SM-7	7314151087999	5	66
6700SM-8	7314151088002	5	66
6700SM-9	7314151088019	5	66



# 6700SZ-1/2



6700SZ-1/2	7314151088194	5	66
6700SZ-1/4	7314151088132	5	66
6700SZ-1/8	7314150346349	5	66
6700SZ-11/32	7314151088163	5	66
6700SZ-3/16	7314151088118	5	66
6700SZ-3/8	7314151088170	5	66
6700SZ-5/16	7314151088156	5	66
6700SZ-5/32	7314151808556	5	66
6700SZ-7/16	7314151088187	5	66
6700SZ-7/32	7314151088125	5	66
6700SZ-9/16	7314151088200	5	66
6700SZ-9/32	7314151088149	5	66
6700TORX-E10	7314153011725	5	66
6700TORX-E4	7314153011671	5	66
6700TORX-E5	7314153011688	5	66
6700TORX-E6	7314153011695	5	66
6700TORX-E7	7314153011701	5	66
6700TORX-E8	7314153011718	5	66
6706TE	7314150220199	1	78
6708DMB	7314150220205	1	78
6709-IP10	7314150354498	1	70
6709-IP15	7314150354504	1	70
6709-IP20	7314150354511	1	70
6709-IP25	7314150354528	1	70
6709-IP27	7314150354535	1	70
6709-IP30	7314150354542	1	70
6709-IP40	7314150354559	1	70
6709-IP45	7314150354566	1	70
6709-IP6	7314150460373	1	70
6709-IP7	7314150460366	1	70
6709-IP8	7314150460359	1	70
6709-IP9	7314150460342	1	70
6709F-4.5	7314151830762	5	70
6709F-5.5	7314151830779	5	70
6709F-6.5	7314150220397	5	70
6709F-8	7314151830786	5	70
6709HL	7314150128457	1	69
6709M-10	7314150430833	5	70
6709M-3	7314151830656	5	70
6709M-4	7314151830663	5	70
6709M-5	7314151830670	5	70
6709M-6	7314151830687	5	70
6709M-8	7314151830694	5	70
6709PH-1	7314151830700	5	70
6709PH-2	7314151830717	5	70
6709PH-3	7314151830724	5	70
6709PZ-1	7314151830731	5	70
6709PZ-2	7314151830748	5	70
6709PZ-3	7314151830755	5	70
6709TORX-R-T10	7314153002471	1	70
6709TORX-R-T15	7314153002488	1	70
6709TORX-R-T20	7314153002495	1	70
6709TORX-R-T25	7314153002501	1	70
6709TORX-R-T8	7314153002464	1	70
6709TORX-T10	7314151811679	5	70
6709TORX-T15	7314151811686	5	70
6709TORX-T20	7314151811693	5	70
6709TORX-T25	7314151811709	5	70
6709TORX-T27	7314151811716	5	70
6709TORX-T30	7314151811723	5	70
6709TORX-T40	7314153002457	5	70
6709TORX-T6	7314150460540	5	70
6709TORX-T7	7314150460557	5	70
6709TORX-T8	7314153002440	5	70
6709TORX-T9	7314151811662	5	70
671002600	8413345128971	50	551
671002850	8413345128988	50	551
6711MB	7314150220298	1	78
6712R	7314151838225	1	72
6712RN	7314151838232	1	72
6713MH	7314150220212	1	78
6715GE	7314151831370	1	74
6715GJ	7314151831363	1	75
6715MG	7314151831349	1	73
6715MGS	7314151831332	1	72
6715MZ	7314153003218	1	75
6715PZ	7314151837525	1	74
6717MBP	7314150218806	1	73
6719MHR	7314150218783	1	72
6719SM	7314151820817	1	73
6720NM	7314151088262	1	75
6721NM	7314151088309	1	74
6722M	7314151594411	1	74
6729MHP	7314150218752	1	73
6729MHR	7314150218769	1	73
6729SM	7314153003225	1	76
6729SZ	7314153003232	1	76
6730MBP	7314150218776	1	73
677-10	7314150362486	1	53
677-13	7314150362493	1	53
677-3/8	7314150362509	1	53
677-7	7314150362455	1	53
677-8	7314150362462	1	53
677-9	7314150362479	1	53
679-1/2	7314150363384	1	57
679-10	7314150357345	1	57



679-11	7314150357352	1	57
679-12	7314150357369	1	57
679-13	7314150357376	1	57
679-14	7314150357383	1	57
679-3/8	7314150363360	1	57
679-7	7314150357536	1	57
679-7/16	7314150363377	1	57
679-8	7314150357079	1	57
679-9	7314150357338	1	57
679-9/16	7314150363391	1	57
6821NZ	7314151089269	1	127
6852-5	7314150125463	1	127
6852-5/S17	7314150135875	1	127
6852P-5	7314150416585	1	128
6876N	7314151845575	1	128
6878N	7314151845582	1	128
6880N	7314151845599	1	128
690000160	8413345008068	1	603
690000200	8413345008082	1	603
690000220	8413345008099	1	603
690000250	8413345008105	1	603
690000300	8413345008129	1	603
690000320	8413345008476	1	603
690000350	8413345008136	1	603
690000400	8413345008143	1	603
690000500	8413345008167	1	603
690000630	8413345111065	1	603
69079019P	8413345111089	1	604
690900080	8413345016209	4	604
690900100	8413345016216	4	604
690900120	8413345016223	2	604
690900140	8413345016230	2	604
690900200	8413345016247	1	604
6950	7314151089641	1	71
6950-SPARE	7314150187867	1	71
6950RN	7314151831189	1	71
6950RN-SPARE	7314150209149	1	72
6950SL	7314150197668	1	71
6950SL-SPARE	7314150210251	1	72
6951	7314151089764	1	71
6952N	7314150339846	1	68
6954	7314151089795	1	68
6956	7314151089825	1	68
6958	7314151089849	1	68
6960	7314151089856	1	68
6960-W	7314153010506	1	68
6961	7314151089870	1	68
6962	7314151089894	1	68
6962-W	7314153010520	1	68
6962L	7314151089917	1	68
6963	7314151089931	1	68
6966	7314151089986	1	69
6968	7314150128426	1	69
696EX-01	7314150386192	1	68
696EX-02	7314150386215	1	68
696EX-04	7314150386222	1	68
696EX-06	7314150386239	1	68
696EX-08	7314150386246	1	68
696EX-11	7314150386208	1	68
6972H	7314151215934	5	69
6973A	7314150339495	1	69
6973M	7314150339501	1	69
6973N	7314151845605	1	127
6976N	7314151845612	1	127
6978N	7314151845629	1	127
6M-10-11	7314151832094	10	51
6M-10-13	7314151832117	10	51
6M-12-13	7314151832131	10	51
6M-12-14	7314151832148	10	51
6M-13-14	7314151832155	10	51
6M-13-15	7314151832162	10	51
6M-13-16	7314151832179	10	51
6M-13-17	7314151832186	10	51
6M-14-15	7314151832193	10	51
6M-14-17	7314151832209	10	51
6M-16-17	7314151832216	10	51
6M-16-18	7314151832223	10	51
6M-17-19	7314151832230	10	51
6M-18-19	7314151832247	10	51
6M-19-22	7314151832261	10	51
6M-19-24	7314151832278	10	51
6M-20-22	7314151832285	10	51
6M-21-23	7314151832292	10	51
6M-21-24	7314151838072	10	51
6M-22-24	7314151832308	10	51
6M-24-26	7314151832315	10	51
6M-24-27	7314151832322	10	51
6M-24-30	7314151832339	5	51
6M-25-28	7314151832353	5	51
6M-27-29	7314150189861	5	51
6M-27-30	7314151832360	5	51
6M-27-32	7314151832377	5	51
6M-30-32	7314151832384	5	51
6M-30-36	7314151832407	5	51
6M-32-36	7314151832414	5	51
6M-34-36	7314151832421	1	51

6M-36-41	7314151832438	1	51
6M-38-42	7314151832445	1	51
6M-4-5	7314151832018	10	51
6M-4.5-5.5	7314151832025	10	51
6M-41-46	7314151832452	1	51
6M-46-50	7314151832469	1	51
6M-5-5.5	7314151832032	10	51
6M-5.5-7	7314151832049	10	51
6M-6-7	7314151832056	10	51
6M-7-8	7314151832063	10	51
6M-8-10	7314151832087	10	51
6M-8-9	7314151832070	10	51
6M/10C	7314150212934	1	52
6M/12C	7314150212941	1	53
6M/6C	7314150212910	1	52
6M/8C	7314150212927	1	52
6M/S8	7314151832483	1	52
6M/SH12	7314153013439	1	52
6M/SH8	7314150201365	1	52
6MV-10	7314150120871	5	495
6MV-11	7314150120888	5	495
6MV-12	7314150120895	5	495
6MV-13	7314150120901	5	495
6MV-14	7314150120918	5	495
6MV-15	7314150120925	5	495
6MV-16	7314150120932	5	495
6MV-17	7314150120949	3	495
6MV-18	7314150120956	3	495
6MV-19	7314150120963	3	495
6MV-20	7314150120970	3	495
6MV-21	7314150120987	3	495
6MV-22	7314150120994	3	495
6MV-23	7314150121007	3	495
6MV-24	7314150121014	3	495
6MV-27	7314150121021	2	495
6MV-30	7314150121038	2	495
6MV-32	7314150121052	2	495
6MV-6	7314150120833	5	495
6MV-7	7314150120840	5	495
6MV-8	7314150120857	5	495
6MV-9	7314150120864	5	495
6MV/10T	7314150213023	1	498
6MV/8T	7314150122141	1	498
6Z-1-1.1/8	7314151832674	1	51
6Z-1.1/16-1.1/4	7314151832681	1	51
6Z-1.1/4-1.3/8	7314151832698	1	51
6Z-1/2-9/16	7314151832568	5	51
6Z-1/4-5/16	7314151832520	5	51
6Z-11/16-3/4	7314151832612	5	51
6Z-13/16-7/8	7314151832643	5	51
6Z-15/16-1	7314151832667	5	51
6Z-19/32-11/16	7314151832582	5	51
6Z-25/32-13/16	7314151832636	5	51
6Z-3/4-7/8	7314151832629	5	51
6Z-3/8-7/16	7314151832544	5	51
6Z-5/16-11/32	7314151832537	5	51
6Z-5/8-3/4	7314151832605	5	51
6Z-7/16-1/2	7314151832551	5	51
6Z-7/8-15/16	7314151832650	5	51
6Z-9/16-5/8	7314151832575	5	51
6Z/8C	7314150212958	1	53
700-1-50	7314153017673	5	205
700-1.2-50	7314153017680	5	205
700-1.5-50	7314153017697	5	205
700-1.8-50	7314153017703	5	205
700-2-50	7314153017710	5	205
700-2.5-50	7314153017741	5	205
700-3-100	7314153017772	5	205
700-3-200	7314153017789	5	205
700-3-50	7314153017765	5	205
700-3.5-75	7314153017796	5	205
700-4-250	7314153017819	5	205
700-4-75	7314153017802	5	205
701-0-200	7314153017857	5	205
701-0-50	7314153017840	5	205
701-00-50	7314153017833	5	205
701-1-250	7314153017871	5	205
701-1-75	7314153017864	5	205
702-0-50	7314153017888	5	205
702-1-75	7314153017895	5	205
703-10-50	7314153017963	5	205
703-15-75	7314153017970	5	205
703-20-75	7314153017987	5	205
703-4-50	7314153017901	5	205
703-5-50	7314153017918	5	205
703-6-50	7314153017925	5	205
703-7-50	7314153017932	5	205
703-8-50	7314153017949	5	205
703-9-50	7314153017956	5	205
704-1.5-50	7314153017994	5	205
704-2-50	7314153018007	5	205
704-2.5-50	7314153018014	5	205
704-3-75	7314153018021	5	205
704Z-3/32	7314150137428	5	205
706-1	7314153018045	1	205
706-2	7314153018052	1	206

706-3	7314153018069	1	206
706-4	7314153018076	1	206
706-5	7314153018083	1	206
70S/1.2-8.0	7314150218387	1	176
70S/1.2-8.0-2P	7314150262823	25	176
70S/1.6-10.0	7314150218394	1	176
70S/1.6-10.0-2P	7314150261017	25	176
70S/1.6-9.0	7314150218400	1	176
70S/1.6-9.0-2P	7314150261024	25	176
70S/2.0-12.0	7314150218417	1	176
70S/2.0-12.0-2P	7314150261086	25	176
70S/2.5-14.0	7314150218424	1	176
70S/2.5-14.0-2P	7314150261147	25	176
70S/H10	7314150218486	1	177
70S/H10-2P	7314150261451	25	177
70S/H12	7314150218493	1	177
70S/H12-2P	7314150261468	25	177
70S/H14	7314150218509	1	177
70S/H14-2P	7314150261475	25	177
70S/H4	7314150218431	1	177
70S/H4-2P	7314150261352	25	177
70S/H5	7314150218448	1	177
70S/H5-2P	7314150261406	25	177
70S/H6	7314150218455	1	177
70S/H6-2P	7314150261437	25	177
70S/H7	7314150218462	1	177
70S/H7-2P	7314150261444	25	177
70S/H8	7314150218479	1	177
70S/H8-2P	7314150262847	25	177
70S/PH1	7314150217557	1	176
70S/PH1-2P	7314150260621	25	176
70S/PH2	7314150217564	1	176
70S/PH2-2P	7314150260638	25	176
70S/PH3	7314150217571	1	176
70S/PH3-2P	7314150260645	25	176
70S/PH4	7314150217588	1	176
70S/PH4-2P	7314150260652	25	176
70S/PZ1	7314150217595	1	176
70S/PZ1-2P	7314150260683	25	176
70S/PZ2	7314150217601	1	176
70S/PZ2-2P	7314150260706	25	176
70S/PZ3	7314150217724	1	176
70S/PZ3-2P	7314150260720	25	176
70S/PZ4	7314150217731	1	176
70S/PZ4-2P	7314150260737	25	176
70S/T20	7314150217748	1	176
70S/T20-2P	7314150260744	25	176
70S/T25	7314150217755	1	176
70S/T25-2P	7314150260812	25	176
70S/T27	7314150217762	1	176
70S/T27-2P	7314150260867	1	176
70S/T30	7314150217779	1	176
70S/T30-2P	7314150260881	25	176
70S/T40	7314150217786	1	176
70S/T40-2P	7314150260898	25	176
70S/T45	7314150217793	1	176
70S/T45-2P	7314150260904	25	176
70S/T50	7314150217809	1	176
70S/T50-2P	7314150260911	25	176
70S/T55	7314150217816	1	176
70S/T55-2P	7314150260928	25	176
70S/TS1/4	7314150218349	1	177
70S/TS1/4-2P	7314150260935	25	177
70S/TS10	7314150218356	1	177
70S/TS10-2P	7314150260942	25	177
70S/TS5/16	7314150218363	1	177
70S/TS5/16-2P	7314150260959	25	177
70S/TS8	7314150218370	1	177
70S/TS8-2P	7314150260966	25	177
7106J	7314150339518	1	82
7106S	7314150339525	1	92
7190	7314150052479	1	636
7190 CO	7314150052790	1	636
7191	7314150052509	1	636
7191 CO	7314150052806	1	636
7223	7314150237722	4	239
7223D	7314150421527	8	240
7223D IP	7314150440306	8	240
7223IP	7314150421855	8	239
7224	7311518274733	4	239
7224-622XD-3P	7314150426973	1	241
7224D	7314150421534	4	240
7224D IP	7314150440313	4	240
7224IP	7314150421831	4	239
7224S	7314150421657	4	495
7225	7314150237739	4	239
7225D	7314150421541	4	240
7225D IP	7314150440320	4	240
7225IP	7314150421848	4	239
7280	7314150052523	1	637
7285	7314150052530	1	637
7290	7314150052547	1	638
7291	7314150052554	1	638
7292	7314150052578	1	639
7293	7314150052592	1	638
7372I-2-63	7314151398668	10	211





7372I-2.5-75	7314151399047	10	211
7372I-3-80	7314151341602	10	211
7400SM-10	7314151092955	5	79
7400SM-11	7314151092962	5	79
7400SM-12	7314151092979	5	79
7400SM-13	7314151092986	5	79
7400SM-14	7314151092993	5	79
7400SM-15	7314151093006	5	79
7400SM-16	7314151831127	5	79
7400SM-17	7314151093020	5	79
7400SM-18	7314151831134	5	79
7400SM-19	7314151093044	5	79
7400SM-20	7314153002570	5	79
7400SM-21	7314153002587	5	79
7400SM-22	7314153002594	5	79
7400SM-6	7314151092917	5	78
7400SM-7	7314151092924	5	78
7400SM-8	7314151092931	5	78
7400SM-9	7314151092948	5	78
7400SR/S12	7314153003294	1	88
7400SZ-1/2	7314150385942	1	79
7400SZ-1/4	7314150385959	1	79
7400SZ-11/16	7314150385966	1	79
7400SZ-11/32	7314150385973	1	79
7400SZ-13/16	7314150385980	1	79
7400SZ-3/4	7314150385997	1	79
7400SZ-3/8	7314150386000	1	79
7400SZ-5/16	7314150386017	1	79
7400SZ-5/8	7314150386024	1	79
7400SZ-7/16	7314150386031	1	79
7400SZ-7/8	7314150386048	1	79
7400SZ-9/16	7314150386055	1	79
7400TORX-E10	7314153003058	5	80
7400TORX-E11	7314153003065	5	80
7400TORX-E12	7314153003072	5	80
7400TORX-E14	7314153003089	5	80
7400TORX-E16	7314153003096	5	80
7400TORX-E18	7314153003102	5	80
7400TORX-E8	7314150118243	5	80
7400TORX-ER/S7	7314153003300	1	88
7406ZZ-16	7314153011992	1	301
7406ZZ-21	7314153012005	1	301
7407H	7314151218249	1	108
7408H	7314151218300	1	108
7408MD	7314150220328	1	88
7409BH-10	7314153002112	5	84
7409BH-4	7314153002075	5	84
7409BH-5	7314153002082	1	84
7409BH-6	7314153002099	5	84
7409BH-8	7314153002105	5	84
7409F-10	7314153002143	5	83
7409F-6.5	7314153002129	5	83
7409F-8	7314153002136	5	83
7409H	7314151218355	1	108
7409M-10	7314153001962	5	84
7409M-3	7314153002235	5	84
7409M-4	7314153001900	5	84
7409M-5	7314153001917	5	84
7409M-6	7314153001924	5	84
7409M-7	7314153001931	5	84
7409M-8	7314153001948	5	84
7409MB	7314150220236	1	88
7409MR/S7	7314153003256	1	84
7409PH-1	7314153002150	5	83
7409PH-2	7314153002167	5	83
7409PH-3	7314153002174	5	83
7409TORX-R-T27	7314153001856	5	83
7409TORX-R-T30	7314153001863	5	83
7409TORX-R-T40	7314153001870	5	83
7409TORX-R-T45	7314153001887	5	83
7409TORX-R-T50	7314153001894	5	83
7409TORX-T20	7314150220403	5	83
7409TORX-T25	7314153001771	5	83
7409TORX-T25-L	7314153011237	5	83
7409TORX-T27	7314153001788	5	83
7409TORX-T30	7314153001795	5	83
7409TORX-T30-L	7314153011244	5	83
7409TORX-T40	7314153001801	5	83
7409TORX-T40-L	7314153011251	5	83
7409TORX-T45	7314153001818	5	83
7409TORX-T45-L	7314153011268	5	83
7409TORX-T50	7314153001825	5	83
7409TORX-T50-L	7314153011275	5	83
7409TORX-TRR/S5	7314153003263	1	83
7409Z-1/4	7314150386062	1	84
7409Z-1/8	7314150386079	1	84
7409Z-3/16	7314150386086	1	84
7409Z-3/8	7314150386093	1	84
7409Z-5/32	7314150386109	1	84
7409Z-7/32	7314150386116	1	84
7420RE	7314153014962	1	85
7422MBR	7314150218844	1	86
7422MHR	7314150218868	1	86
7429JDE	7314153003348	1	87
7430GE	7314153014979	1	86
7440ME	7314153014986	1	85



7444SG-M-100	7314151830014	1	58
7444SG-M-105	7314151830021	1	58
7444SG-M-110	7314151830038	1	58
7444SG-M-115	7314151830045	1	58
7444SG-M-120	7314151830052	1	58
7444SG-M-125	7314151830069	1	58
7444SG-M-130	7314151830076	1	58
7444SG-M-135	7314151830083	1	58
7444SG-M-140	7314151830090	1	58
7444SG-M-145	7314151830106	1	58
7444SG-M-150	7314151830113	1	58
7444SG-M-155	7314151830120	1	58
7444SG-M-160	7314150132508	1	58
7444SG-M-165	7314150132515	1	58
7444SG-M-170	7314150132522	1	58
7444SG-M-175	7314150132539	1	58
7444SG-M-24	7314150205400	1	58
7444SG-M-27	7314151829834	1	58
7444SG-M-30	7314151829841	1	58
7444SG-M-32	7314151829858	1	58
7444SG-M-34	7314151838560	1	58
7444SG-M-36	7314151829865	1	58
7444SG-M-38	7314150180936	1	58
7444SG-M-41	7314151829872	1	58
7444SG-M-42	7314151829889	1	58
7444SG-M-46	7314151829896	1	58
7444SG-M-50	7314151829919	1	58
7444SG-M-55	7314151829926	1	58
7444SG-M-60	7314151829933	1	58
7444SG-M-65	7314151829940	1	58
7444SG-M-70	7314151829957	1	58
7444SG-M-75	7314151829964	1	58
7444SG-M-80	7314151829971	1	58
7444SG-M-85	7314151829988	1	58
7444SG-M-90	7314151829995	1	58
7444SG-M-95	7314151830007	1	58
7444SG-Z-1.1/16	7314150132546	1	58
7444SG-Z-1.1/2	7314150132614	1	58
7444SG-Z-1.1/4	7314150132577	1	58
7444SG-Z-1.1/8	7314150132553	1	58
7444SG-Z-1.11/16	7314150132638	1	58
7444SG-Z-1.13/16	7314150132652	1	58
7444SG-Z-1.3/16	7314150132560	1	58
7444SG-Z-1.3/4	7314150132645	1	58
7444SG-Z-1.3/8	7314150132591	1	58
7444SG-Z-1.5/16	7314150132584	1	58
7444SG-Z-1.5/8	7314150132621	1	58
7444SG-Z-1.7/16	7314150132607	1	58
7444SG-Z-1.7/8	7314150132669	1	58
7444SG-Z-2	7314150132676	1	58
7444SG-Z-2.1/16	7314150132683	1	58
7444SG-Z-2.1/4	7314150132713	1	58
7444SG-Z-2.1/8	7314150132690	1	58
7444SG-Z-2.3/16	7314150132706	1	58
7444SG-Z-2.3/4	7314150132768	1	58
7444SG-Z-2.3/8	7314150132720	1	58
7444SG-Z-2.5/8	7314150132751	1	58
7444SG-Z-2.9/16	7314150132744	1	58
7444SG-Z-3	7314150132775	1	58
7444SG-Z-3.1/2	7314150132805	1	58
7444SG-Z-3.1/8	7314150132782	1	58
7444SG-Z-3.3/4	7314150132812	1	58
7444SG-Z-3.3/8	7314150132799	1	58
7444SG-Z-3.7/8	7314150132829	1	58
7444SG-Z-4	7314150132836	1	58
7444SG-Z-4.1/2	7314150132850	1	58
7444SG-Z-4.1/8	7314150132843	1	58
7454-140	7314150119547	1	124
7454-1400	7314150119592	1	124
7454-1400E	7314150119615	1	124
7454-18	7314150119516	1	124
7454-240	7314150119554	1	124
7454-3	7314150119493	1	124
7454-35	7314150119523	1	124
7454-480	7314150119578	1	124
7454-70	7314150119530	1	124
7454-800	7314150119585	1	124
7454-800E	7314150119608	1	124
7454-9	7314150119509	1	124
7455-100	7314150125111	1	122
7455-1000	7314150368303	1	122
7455-100A	7314150340156	1	122
7455-15	7314150119646	1	122
7455-1500	7314150125166	1	122
7455-20	7314150125074	1	122
7455-200	7314150125128	1	122
7455-25	7314150125081	1	122
7455-2500	7314150125173	1	122
7455-300	7314150125104	1	122
7455-340	7314150125135	1	122
7455-5	7314150119639	1	122
7455-500	7314150125142	1	122
7455-60	7314150125098	1	122
7455-800	7314150125159	1	122
7456-80LB	7314150119783	1	122
7465-100	7314150340200	1	122



7465-15	7314150340170	1	122
7465-1500	7314150340248	1	122
7465-200	7314150340217	1	122
7465-30	7314150340187	1	122
7465-340	7314150340224	1	122
7465-5	7314150340163	1	122
7465-60	7314150340194	1	122
7465-800	7314150340231	1	122
747-1	7314150362899	1	54
747-1.1/16	7314150362905	1	54
747-1.1/2	7314150362974	1	54
747-1.1/4	7314150362936	1	54
747-1.1/8	7314150362912	1	54
747-1.11/16	7314150363001	1	54
747-1.13/16	7314150363025	1	54
747-1.15/16	7314150363049	1	54
747-1.3/16	7314150362929	1	54
747-1.3/4	7314150363018	1	54
747-1.3/8	7314150362950	1	54
747-1.5/16	7314150362943	1	54
747-1.5/8	7314150362998	1	54
747-1.7/16	7314150362967	1	54
747-1.7/8	7314150363032	1	54
747-1.9/16	7314150362981	1	54
747-1/2	7314150362813	1	54
747-10	7314150362516	1	54
747-11	7314150362523	1	54
747-11/16	7314150362844	1	54
747-12	7314150362530	1	54
747-13	7314150362547	1	54
747-13/16	7314150362868	1	54
747-14	7314150362554	1	54
747-15	7314150362561	1	54
747-15/16	7314150362882	1	54
747-16	7314150362578	1	54
747-17	7314150362585	1	54
747-18	7314150362592	1	54
747-19	7314150362608	1	54
747-2	7314150363056	1	54
747-2.1/16	7314150363063	1	54
747-2.1/2	7314150363131	1	54
747-2.1/4	7314150363094	1	54
747-2.1/8	7314150363070	1	54
747-2.3/16	7314150364893	1	54
747-2.3/4	7314150363162	1	54
747-2.3/8	7314150363117	1	54
747-2.5/16	7314150363100	1	54
747-2.5/8	7314150363155	1	54
747-2.7/16	7314150363124	1	54
747-2.7/8	7314150363179	1	54
747-2.9/16	7314150363148	1	54
747-20	7314150362615	1	54
747-21	7314150362622	1	54
747-22	7314150362639	1	54
747-23	7314150362646	1	54
747-24	7314150362653	1	54
747-25	7314150362660	1	54
747-26	7314150362677	1	54
747-27	7314150362684	1	54
747-28	7314150362691	1	54
747-3/4	7314150362851	1	54
747-3/8	7314150362790	1	54
747-30	7314150362707	1	54
747-32	7314150362714	1	54
747-34	7314150362721	1	54
747-36	7314150362738	1	54
747-40	7314150362745	1	54
747-41	7314150362752	1	54
747-42	7314150362769	1	54
747-46	7314150362776	1	54
747-5/8	7314150362837	1	54
747-50	7314150362783	1	54
747-7/16	7314150362806	1	54
747-7/8	7314150362875	1	54
747-9/16	7314150362820	1	54
749-1	7314150363506	1	57
749-1.1/16	7314150363513	1	57
749-1.1/2	7314150363582	1	57
749-1.1/4	7314150363544	1	57
749-1.1/8	7314150363520	1	57
749-1.11/16	7314150363612	1	57
749-1.13/16	7314150363636	1	57
749-1.15/16	7314150363650	1	57
749-1.3/16	7314150363537	1	57
749-1.3/4	7314150363629	1	57
749-1.3/8	7314150363568	1	57
749-1.5/16	7314150363551	1	57
749-1.5/8	7314150363605	1	57
749-1.7/16	7314150363575	1	57
749-1.7/8	7314150363643	1	57
749-1.9/16	7314150363599	1	57
749-1/2	7314150363421	1	57
749-11/16	7314150363452	1	57
749-13/16	7314150363476	1	57
749-15	7314150357543	1	57
749-15/16	7314150363490	1	57



749-16	7314150357550	1	57
749-17	7314150357567	1	57
749-18	7314150357574	1	57
749-19	7314150357581	1	57
749-2	7314150363667	1	57
749-2.1/4	7314150363698	1	57
749-2.1/8	7314150363674	1	57
749-2.3/16	7314150363681	1	57
749-2.3/4	7314150363728	1	57
749-2.3/8	7314150363704	1	57
749-2.5/8	7314150363711	1	57
749-20	7314150357598	1	57
749-21	7314150357604	1	57
749-22	7314150357611	1	57
749-23	7314150357628	1	57
749-24	7314150357635	1	57
749-25	7314150357642	1	57
749-26	7314150357659	1	57
749-27	7314150357666	1	57
749-3.1/8	7314150363735	1	57
749-3/4	7314150363469	1	57
749-3/8	7314150363407	1	57
749-5/8	7314150363445	1	57
749-7/16	7314150363414	1	57
749-7/8	7314150363483	1	57
749-9/16	7314150363438	1	57
7490	7314150052646	1	638
7490 CO	7314150052875	1	638
74P14-200	7314150416318	1	125
74P14-300	7314150416325	1	125
74P14-400	7314150416332	1	125
74P9-100	7314150416301	1	125
74P9-20	7314150416288	1	125
74P9-60	7314150416295	1	125
74PR-100	7314150416189	1	125
74PR-100A	7314150416196	1	125
74PR-20	7314150416158	1	124
74PR-200	7314150416202	1	125
74PR-300	7314150416219	1	125
74PR-400	7314150416226	1	125
74PR-60	7314150416165	1	125
74PR-60A	7314150416172	1	125
74PS-100	7314150416257	1	125
74PS-20	7314150416233	1	125
74PS-200	7314150416264	1	125
74PS-300	7314150416271	1	125
74PS-60	7314150416240	1	125
74S/H10	7314150218622	1	177
74S/H10-2P	7314150261635	25	177
74S/H12	7314150218639	1	177
74S/H12-2P	7314150261659	25	177
74S/H14	7314150218646	1	177
74S/H14-2P	7314150261666	1	177
74S/H17	7314150218653	1	177
74S/H17-2P	7314150261673	25	177
74S/H4	7314150218578	1	177
74S/H4-2P	7314150261543	25	177
74S/H5	7314150218585	1	177
74S/H5-2P	7314150261550	25	177
74S/H6	7314150218592	1	177
74S/H6-2P	7314150261567	25	177
74S/H7	7314150218608	1	177
74S/H7-2P	7314150261574	25	177
74S/H8	7314150218615	1	177
74S/H8-2P	7314150261611	25	177
74W14-200	7314150415700	1	123
74W14-300	7314150415717	1	123
74W14-400	7314150415724	1	123
74W9-100	7314150415687	1	123
74W9-15	7314150415656	1	123
74W9-200	7314150415694	1	123
74W9-25	7314150415663	1	123
74W9-50	7314150415670	1	123
74WR-100	7314150415540	1	123
74WR-15	7314150415519	1	123
74WR-200	7314150415557	1	123
74WR-25	7314150415526	1	123
74WR-300	7314150415564	1	123
74WR-340	7314150415571	1	123
74WR-400	7314150415588	1	123
74WR-50	7314150415533	1	123
74WS-100	7314150415625	1	123
74WS-15	7314150415595	1	123
74WS-200	7314150415632	1	123
74WS-25	7314150415601	1	123
74WS-300	7314150415649	1	123
74WS-50	7314150415618	1	123
7590	7314150052660	1	638
7590 CO	7314150052882	1	638
75EXT	7314150415311	1	126
75P1-1500	7314150415298	1	125
75P3-1000	7314150415281	1	125
75P3-650	7314150415267	1	125
75P3-800	7314150415274	1	125
75PS-650	7314150415328	1	126
75R1-1500	7314150415236	1	121



# 75R3-1000



75R3-1000	7314150415229	1	121
75R3-650	7314150415205	1	121
75R3-800	7314150415212	1	121
75S-650	7314150415243	1	121
76R3-1000	7314150422128	1	123
76R3-600	7314150423118	1	123
76R3-800	7314150422111	1	123
76S-600	7314150423125	1	123
7710	7314151551445	1	83
7710-SO/1	7314151809744	1	85
7750	7314151096427	1	82
7750-SPARE	7314150187874	1	84
7750RN	7314151831240	1	82
7750RN-SPARE	7314150209361	1	84
7750SL	7314150197675	1	82
7750SL-SPARE	7314150210268	1	85
7751	7314150386949	10	84
7752	7314151096533	1	80
7754	7314151096557	1	80
7755-3/8	7314153002372	1	82
7755-SO/1	7314153010728	1	84
7757	7314151096588	1	81
7758	7314151096595	1	80
7759	7314151096601	1	81
7760	7314151096618	1	81
7760-W	7314150107155	1	81
7761	7314151096632	1	81
7761-W	7314150107162	1	81
7762	7314151096649	1	81
7764	7314151096670	1	81
7765	7314151096687	1	69
7766	7314151096694	1	81
7767	7314153003577	1	69
7768	7314150128433	1	81
776EX-01	7314150386130	1	81
776EX-03	7314150386154	1	81
776EX-04	7314150386161	1	81
776EX-06	7314150386178	1	81
776EX-08	7314150386185	1	81
776EX-11	7314150386147	1	81
7800DM-10	7314151096991	1	89
7800DM-11	7314151097011	1	89
7800DM-12	7314151097035	1	89
7800DM-13	7314151097059	1	89
7800DM-14	7314151097073	1	89
7800DM-15	7314151097097	1	89
7800DM-16	7314151097110	1	89
7800DM-17	7314151097134	1	89
7800DM-18	7314151097158	1	89
7800DM-19	7314151097172	1	89
7800DM-20	7314151097196	1	89
7800DM-21	7314151097219	1	89
7800DM-22	7314151097233	1	89
7800DM-23	7314151097257	1	89
7800DM-24	7314151097271	1	89
7800DM-25	7314151097295	1	89
7800DM-26	7314151097318	1	89
7800DM-27	7314151097332	1	89
7800DM-28	7314151097356	1	89
7800DM-29	7314151097363	1	89
7800DM-30	7314151097370	1	89
7800DM-31	7314150464548	1	89
7800DM-32	7314151097387	1	89
7800DM-33	7314150169351	1	89
7800DM-34	7314150169405	1	89
7800DM-36	7314151097400	1	89
7800DM-8	7314151830854	1	89
7800DM-9	7314151830861	1	89
7800DMV-10	7314150121656	10	496
7800DMV-11	7314150121663	10	496
7800DMV-12	7314150121670	10	496
7800DMV-13	7314150121687	10	496
7800DMV-14	7314150121694	10	496
7800DMV-15	7314150121700	10	496
7800DMV-16	7314150121717	10	496
7800DMV-17	7314150121724	10	496
7800DMV-18	7314150121731	10	496
7800DMV-19	7314150121748	10	496
7800DMV-20	7314150121755	10	496
7800DMV-21	7314150121762	10	496
7800DMV-22	7314150121779	10	496
7800DMV-24	7314150121786	5	496
7800DMV-27	7314150121793	5	496
7800DMV-30	7314150121809	5	496
7800DMV-32	7314150121816	5	496
7800DMV-8	7314150121649	10	496
7800DZ-1	7314151097561	1	90
7800DZ-1.1/16	7314151097578	1	90
7800DZ-1.1/2	7314150464562	1	90
7800DZ-1.1/4	7314151097608	1	90
7800DZ-1.1/8	7314151097585	1	90
7800DZ-1.3/16	7314151097592	1	90
7800DZ-1.3/8	7314150464586	1	90
7800DZ-1.5/16	7314150166077	1	90
7800DZ-1.7/16	7314150464609	1	90
7800DZ-1/2	7314151097455	1	90



7800DZ-11/16	7314151097493	1	90
7800DZ-11/32	7314150465712	1	90
7800DZ-13/16	7314151097523	1	90
7800DZ-13/32	7314150464623	1	90
7800DZ-15/16	7314151097554	1	90
7800DZ-19/32	7314151097479	1	90
7800DZ-25/32	7314151097516	1	90
7800DZ-3/4	7314151097509	1	90
7800DZ-3/8	7314151097431	1	90
7800DZ-5/16	7314150464647	1	90
7800DZ-5/8	7314151097486	1	90
7800DZ-7/16	7314151097448	1	90
7800DZ-7/8	7314151097530	1	90
7800DZ-9/16	7314151097462	1	90
7800SM-10	7314151097851	1	88
7800SM-11	7314151097868	1	88
7800SM-12	7314151097875	10	89
7800SM-13	7314151097882	1	89
7800SM-14	7314151097899	1	89
7800SM-15	7314151097905	1	89
7800SM-16	7314151097912	1	89
7800SM-17	7314151097929	1	89
7800SM-18	7314151097936	1	89
7800SM-19	7314151097943	1	89
7800SM-20	7314150166206	1	89
7800SM-21	7314151097967	1	89
7800SM-22	7314151097974	1	89
7800SM-23	7314151097981	1	89
7800SM-24	7314151097998	1	89
7800SM-25	7314151098001	1	89
7800SM-26	7314151830823	1	89
7800SM-27	7314151098025	1	89
7800SM-28	7314151830830	1	89
7800SM-29	7314150166213	1	89
7800SM-30	7314151098056	1	89
7800SM-32	7314151098063	1	89
7800SM-33	7314150167319	1	89
7800SM-34	7314153011305	1	89
7800SM-36	7314151098087	1	89
7800SM-8	7314151830793	1	88
7800SM-9	7314151830809	1	88
7800TORX-E10	7314150166084	1	90
7800TORX-E11	7314150220359	1	90
7800TORX-E12	7314153011800	1	90
7800TORX-E14	7314153011756	1	90
7800TORX-E16	7314153011763	1	90
7800TORX-E18	7314153011770	1	90
7800TORX-E20	7314153011787	1	90
7800TORX-E24	7314153011794	1	90
7800TORX-E8	7314150166091	1	90
7805DM-10	7314151822101	1	90
7805DM-12	7314151098452	1	90
7805DM-13	7314151098469	1	90
7805DM-14	7314151098476	1	90
7805DM-15	7314151098483	1	90
7805DM-16	7314151098490	1	90
7805DM-17	7314151098506	1	90
7805DM-18	7314151098513	1	90
7805DM-19	7314151098520	1	90
7805DM-21	7314151098544	1	90
7805DM-22	7314151098551	1	90
7805DM-23	7314150313532	1	90
7805DM-24	7314151098568	1	90
7805DM-26	7314151098582	1	90
7805DM-27	7314151098599	1	90
7805DM-30	7314151098605	1	90
7805DM-32	7314150220281	1	90
7805DZ-1	7314150357758	1	90
7805DZ-1.1/16	7314150357765	1	90
7805DZ-1.1/2	7314150357833	1	90
7805DZ-1.1/4	7314150357796	1	90
7805DZ-1.1/8	7314150357772	1	90
7805DZ-1.3/16	7314150357789	1	90
7805DZ-1.3/8	7314150357819	1	90
7805DZ-1.5/16	7314150357802	1	90
7805DZ-1.7/16	7314150357826	1	90
7805DZ-11/16	7314150357703	1	90
7805DZ-13/16	7314150357727	1	90
7805DZ-15/16	7314150357741	1	90
7805DZ-3/4	7314150357710	1	90
7805DZ-5/8	7314150357697	1	90
7805DZ-7/8	7314150357734	1	90
7805SM-10	7314153011312	1	89
7805SM-12	7314153011329	1	89
7805SM-13	7314153011336	1	89
7805SM-14	7314153011343	1	89
7805SM-15	7314153011350	1	89
7805SM-16	7314153011367	1	89
7805SM-17	7314153011374	1	89
7805SM-18	7314153011381	1	89
7805SM-19	7314153011398	1	89
7805SM-20	7314153011404	1	89
7805SM-21	7314153011411	1	89
7805SM-22	7314153011428	1	89
7805SM-23	7314153011435	1	89
7805SM-24	7314153011442	1	89





7805SM-25	7314153011459	1	89
7805SM-26	7314153011466	1	89
7805SM-27	7314153011473	1	89
7805SM-28	7314153011480	1	89
7805SM-29	7314153011497	1	89
7805SM-30	7314153011503	1	89
7805SM-32	7314153011527	1	89
7805SZ-1.1/2	7314150357987	1	89
7805SZ-1.1/4	7314150357949	1	89
7805SZ-1.3/16	7314150357932	1	89
7805SZ-1.3/8	7314150357963	1	89
7805SZ-1.5/16	7314150357956	1	89
7805SZ-1.7/16	7314150357970	1	89
7805ZZ-16	7314151822767	1	301
7805ZZ-21	7314151347338	1	301
7806	7314153012012	1	308
7806MD	7314150220335	1	101
7807	7314153012029	1	300
7807H	7314151232764	1	111
7807TE	7314150313792	1	101
7808H	7314151232771	1	111
7808HM	7314150220434	1	93
7809F-10	7314151830892	5	92
7809F-8	7314151830885	5	92
7809H	7314151232788	1	111
7809HL	7314150128464	1	92
7809M-10	7314151815608	1	93
7809M-10-140	7314151831011	1	93
7809M-12	7314151815615	1	93
7809M-14	7314151815622	1	93
7809M-17	7314151831028	1	93
7809M-19	7314151831035	1	93
7809M-4	7314150214600	1	93
7809M-5	7314151815561	1	93
7809M-5-100	7314150313761	1	93
7809M-5-180	7314151830922	1	93
7809M-6	7314151815578	1	93
7809M-6-100	7314150313778	1	93
7809M-6-140	7314151830946	1	93
7809M-7	7314151815585	1	93
7809M-7-100	7314151830960	1	93
7809M-8	7314151815592	1	93
7809M-8-120	7314151830984	1	93
7809M-9	7314151830991	1	93
7809M/10	7314151831448	1	96
7809PH-2	7314151830908	1	92
7809PH-3	7314151830915	1	92
7809PH-4	7314153003423	1	92
7809PZ-2	7314153003430	1	92
7809PZ-3	7314153003447	1	92
7809TO	7314150220465	1	93
7809TORX-T20	7314151811730	1	93
7809TORX-T25	7314151811747	1	93
7809TORX-T27	7314151811754	1	93
7809TORX-T30	7314151811761	1	93
7809TORX-T40	7314151811778	1	93
7809TORX-T40-120	7314150220564	5	93
7809TORX-T45	7314151811785	1	93
7809TORX-T45-120	7314150220557	1	93
7809TORX-T50	7314151811792	1	93
7809TORX-T50-100	7314150220540	5	93
7809TORX-T55	7314151811808	1	93
7809TORX-T55-140	7314150220533	5	93
7809TORX-T60	7314151811815	1	93
7809TORX-T70-140	7314150220526	5	93
7809TORX/10	7314151831455	1	96
7809XZN-10	7314151831080	1	94
7809XZN-10-100	7314151831097	1	94
7809XZN-12	7314151831103	1	94
7809XZN-12-100	7314151831110	1	94
7809XZN-14	7314153004574	1	94
7809XZN-14-100	7314153004567	1	94
7809XZN-16	7314150220458	1	94
7809XZN-18	7314150314058	1	94
7809XZN-6	7314150214617	1	94
7809XZN-8	7314151831066	1	94
7809XZN-8-100	7314151831073	1	94
7809Z-1/2	7314153003515	1	93
7809Z-1/4	7314153003478	1	93
7809Z-17/32	7314150313785	1	93
7809Z-19/32	7314153003546	1	93
7809Z-3/16	7314153003461	1	93
7809Z-3/8	7314153003492	1	93
7809Z-5/16	7314153003485	1	93
7809Z-5/8	7314153003553	1	93
7809Z-7/16	7314153003508	1	93
7809Z-9/16	7314153003539	1	93
7809Z/10	7314153003560	1	96
7810MB	7314150220380	1	101
7810MH	7314150220373	1	101
7811DMV	7314150122134	1	499
7814DS	7314150318964	1	96
7814DST	7314150319022	1	98
7817DZS	7314150319008	1	98
7818DS	7314150318971	1	96
7818DST	7314150319039	1	98



7818MHR	7314150218912	1	97
7818SST	7314150319046	1	98
7819DRN	7314151831547	1	97
7819SRE	7314151837921	1	96
782-U	7311518276447	1	303
7823	7314150218141	16	177
7823DET	7314150319084	1	99
7823DZS	7314150319015	1	98
7823SE	7314150318988	1	97
7825DST	7314150319060	1	99
7825MBP	7314150218929	1	97
7825MHP	7314150218943	1	97
7825SST	7314150319053	1	99
7827DST	7314150319077	1	99
783	7311518276034	1	303
7835 G-160	7314150050253	5	237
7847SS	7314150318995	1	98
7851-G	7314150124909	1	126
7851-M	7314150124893	1	126
7865	7311518276720	1	177
787-1.1/16	7314150363186	1	54
787-1.1/2	7314150363254	1	54
787-1.1/4	7314150363216	1	54
787-1.1/8	7314150363193	1	54
787-1.11/16	7314150363278	1	54
787-1.13/16	7314150363292	1	54
787-1.3/16	7314150363209	1	54
787-1.3/4	7314150363285	1	54
787-1.3/8	7314150363230	1	54
787-1.5/16	7314150363223	1	54
787-1.5/8	7314150363261	1	54
787-1.7/16	7314150363247	1	54
787-1.7/8	7314150363308	1	54
787-2	7314150363315	1	54
787-2.1/4	7314150363346	1	54
787-2.1/8	7314150363322	1	54
787-2.3/16	7314150363339	1	54
787-2.3/8	7314150363353	1	54
78802B	7314150391769	1	209
7888DM	7314151820923	1	97
789-1.1/2	7314150363896	1	58
789-1.1/4	7314150363858	1	58
789-1.1/8	7314150363841	1	58
789-1.13/16	7314150363933	1	58
789-1.3/4	7314150363926	1	58
789-1.3/8	7314150363872	1	58
789-1.5/16	7314150363865	1	58
789-1.5/8	7314150363919	1	58
789-1.7/16	7314150363889	1	58
789-1.9/16	7314150363902	1	58
789-2	7314150363940	1	58
789-2.1/4	7314150363957	1	58
789-2.3/8	7314150363971	1	58
789-2.5/16	7314150363964	1	58
789-28	7314150363742	1	58
789-30	7314150363759	1	58
789-32	7314150357673	1	58
789-34	7314150363766	1	58
789-36	7314150363773	1	58
789-38	7314150363780	1	58
789-40	7314150363797	1	58
789-41	7314150363803	1	58
789-42	7314150363810	1	58
789-46	7314150363827	1	58
789-50	7314150363834	1	58
7890	7314150052691	1	638
7890 CO	7314150052899	1	638
7891	7314150052714	1	638
7891 CO	7314150052905	1	638
7892	7314150052738	1	638
7893	7314150052769	1	638
790450A	7314150214716	1	255
790455A	7314150214709	1	255
7993M0170	8413345115353	1	116
7993M0190	8413345115377	1	116
7993M0220	8413345115391	1	116
7993M0270	8413345115414	1	116
7993S0050	8413345115070	1	111
7993S0060	8413345115094	1	111
7993S0080	8413345115117	1	111
7993S0100	8413345115131	1	111
7993S0120	8413345115155	1	111
7993S0140	8413345115179	1	111
7993S0170	8413345115193	1	111
7993S0190	8413345115216	1	111
7993T0120	8413345115230	1	114
7993T0140	8413345115254	1	114
7993T0170	8413345115278	1	114
7993T0190	8413345115292	1	114
7993T0220	8413345115315	1	114
7993T0240	8413345115339	1	114
7994S0300	8413345129305	1	111
7994S0400	8413345129312	1	111
7994S0450	8413345129329	1	111
7994S0500	8413345129336	1	111
7994S0550	8413345129343	1	111



# 7994S0600



7994S0600	8413345129350	1	111
8010SL-2P	7314150243853	1	492
8020-2P	7314150246601	1	189
8030-2P	7314150246618	1	189
8040-2P	7314150246625	1	189
8040L-2P	7314150246670	1	189
8040SL-2P	7314150243877	1	492
8045LVDE	7314151509163	10	209
8045VDE	7314151317256	10	209
8050SL-2P	7314150243884	1	492
8052	7314151318406	5	210
806-1-1	7311518003760	6	208
806-1-2	7314150183258	6	208
806-1-3	7314150183265	6	208
8060B0080	8413345018104	1	259
8060B0100	8413345018111	1	259
8060B0120	8413345018128	1	259
8060B0140	8413345018135	1	259
8060B0180	8413345018142	1	259
8060B0240	8413345018159	1	259
8060B0360	8413345018166	1	259
8060T0080	8413345018173	1	259
8060T0100	8413345018180	1	259
8060T0120	8413345018197	1	259
8060T0140	8413345018203	1	259
8060T0180	8413345018210	1	259
8060T0240	8413345018227	1	259
8060T0360	8413345018234	1	259
8069	7314150007028	5	41
8069 C	7314150007035	5	41
8069 C IP	7314150101634	5	41
8069 IP	7314150007042	50	41
8069-1	7314150239511	1	41
8069-2	7314150238590	1	41
8070	7314150007110	5	41
8070 C	7314150007127	5	41
8070 C IP	7314150101641	5	41
8070 IP	7314150007134	40	41
8070-1	7314150239528	1	41
8070-2	7314150238606	1	41
8070V	7314150121519	2	495
8070VL	7314150213511	1	495
8071	7314150007202	5	41
8071 C	7314150007219	5	41
8071 C IP	7314150101658	5	41
8071 IP	7314150007226	50	41
8071-1	7314150239535	1	41
8071-2	7314150238613	1	41
8071V	7314150121526	2	495
8071VL	7314150213535	1	495
8071VLT	7314150121564	1	495
8072	7314150007288	5	41
8072 C	7314150007295	5	41
8072 C IP	7314150101665	5	41
8072 IP	7314150007301	30	41
8072-1	7314150239542	1	41
8072-2	7314150238620	1	41
8072V	7314150121533	2	495
8072VL	7314150213542	1	495
8072VLT	7314150121571	1	495
8073	7314150007363	5	41
8073 C	7314150007370	5	41
8073 C IP	7314150101672	5	41
8073 IP	7314150007387	20	41
8073-1	7314150239559	1	41
8073-2	7314150238637	1	41
8073V	7314150121540	2	495
8073VL	7314150213559	1	495
8073VLT	7314150121588	1	495
8074	7314150007448	3	41
8074 C	7314150007455	3	41
8074 C IP	7314150101689	3	41
8074 IP	7314150007462	20	41
8074-1	7314150239566	1	41
8074-2	7314150238644	1	41
8074V	7314150121557	2	495
8075	7314150007523	3	41
8075 C	7314150007530	3	41
8075 C IP	7314150101696	3	41
8075 IP	7314150007547	10	41
8075-1	7314150239573	1	41
8075-2	7314150238651	1	41
808050	7314153017642	50	203
808050A	7314150127306	1	209
808050L	7314150128075	25	203
808050L-SP1	7314150129218	1	203
808050P	7314150128105	50	204
808050P-25	7314150165179	10	204
808050S	7314150128082	25	204
808050S-18	7314150128921	30	204
808050S-22	7314150128938	30	204
808050TORX	7314150127313	50	209
808050TS	7314150128099	1	204
808060	7314150243822	1	491
808061	7314150243839	5	491
808062	7314150243846	5	491



8100B0100	7314150263011	1	259
8100B0140	7314150263028	1	259
8100B0180	7314150263042	1	259
8100B0240	8413345018296	1	259
8100B0360	8413345099660	1	259
8100B0480	7314150263110	1	259
8100F0100	8413345131735	1	259
8100F0140	7314150255030	1	259
8100F0180	7314150263059	1	259
8100F0240	7314150263066	1	259
8100F0360	8413345135849	1	259
8100F0480	7314150263134	1	259
8100T0100	7314150263073	1	259
8100T0140	8413345018333	1	259
8100T0180	7314150263080	1	259
8100T0240	7314150263097	1	259
8100T0360	7314150263103	1	259
8110-1/2	7314151808853	1	95
8110-SO/1	7314151809751	1	95
8110H-1/2	7314153015860	1	95
8120-1/2	7314150384884	12	94
8120-1/4	7314150384921	20	71
8120-3/8	7314150384914	10	83
813	7314150055852	1	639
8130	7314150050918	1	636
8131	7314150050925	1	636
8131 CO	7314150051519	1	636
8132	7314150050932	1	636
8140	7314150050949	1	636
8140 CO	7314150051533	1	636
8141	7314150050987	1	636
8141 CO	7314150051557	1	636
8142	7314150051007	1	636
8142 CO	7314150051564	1	636
8143	7314150051021	1	636
8144	7314150051045	1	636
8144 CO	7314150051601	1	636
8145	7314150051052	1	636
8146	7314150051076	1	636
8147	7314150051083	1	636
8148	7314150051090	1	636
8148 CO	7314150051656	1	636
8149	7314150051106	1	636
8150	7314150051113	1	636
8150 CO	7314150051670	1	636
8150 J	7314150051137	1	636
8150-1/2	7314151105006	1	94
8150-1/2-SPARE	7314150187881	1	95
8150-1/2V	7314150121601	1	496
8150RN-1/2	7314151831202	1	94
8150RN-1/2-SPARE	7314150209378	1	95
8150SL	7314150197682	1	94
8150SL-SPARE	7314150210275	1	95
8151	7314150051199	1	636
8151 CO	7314150051694	1	636
8151-1/2	7314151105112	1	95
8152	7314150052097	1	636
8152-1/2	7314151105129	1	90
8153	7314150051205	1	636
8154	7314150052103	1	636
8154 CO	7314150052233	1	636
8154-1/2V	7314150121595	1	496
8154-11	7314150469161	1	91
8155	7314150052110	1	636
8155-1/2	7314151827595	1	94
8155-SO/1	7314153000811	1	95
8156	7314150051212	1	636
8157	7314150052127	1	636
8157-10	7314150467273	20	91
8157-15	7314150469222	1	91
8157-24	7314150469246	10	91
8157-36	7314150469260	10	91
8158	7314150052134	1	636
8158-SO/1	7314150111039	1	95
8159-W	7314150107186	1	91
8160	7314150051229	1	636
8160 CO	7314150051724	1	636
8160 J	7314150051250	1	636
8160-1/2V	7314150121618	1	497
8160-10	7314150469185	10	91
8160-3	7314150469208	1	91
8160-5	7314150469284	10	91
8160-B	7314150182565	1	91
8160-W	7314150107193	1	91
8161	7314150051328	1	636
8161 CO	7314150051748	1	636
8162	7314150051335	1	636
8162-1/2V	7314150121625	1	497
8162-W	7314150107209	10	91
8163	7314150051342	1	636
8163 CO	7314150051762	1	636
8164	7314150052141	1	636
8164-1/2	7314151105266	1	81
8165	7314150052158	1	636
8165 CO	7314150052288	1	636
8166	7314150459377	10	91
8167	7314153003584	1	82



8167-1/2	7314150181094	1	91
8168	7314150128440	1	91
8171	7314150469307	10	91
8172	7314150469321	10	92
8193-1/2	7314151831219	1	94
8194-1/2	7314151831226	1	95
8195-KEY	7314150389810	50	91
8195-R	7314150389780	1	94
8195-SET	7314150389797	5	94
8195-SQ	7314150389803	25	95
8211	7314150101030	1	637
8220SL-2P	7314150243860	1	492
8223	7314150112685	4	239
8223 IP	7314150113149	4	239
8224	7314150000012	4	239
8224 IP	7314150101757	4	239
8224CIP	7314150103607	4	239
8225	7314150000029	4	239
8225 IP	7314150101764	4	239
8225CIP	7314150103614	4	239
8226	7314150115853	1	239
8231	7311518266509	4	239
8231 IP	7311518270285	4	239
8242-2P	7314150243686	1	189
8242L-2P	7314150246687	1	189
8247	7314150051397	1	637
8247 CO	7314150051809	1	637
8248	7314150051427	1	637
8248 CO	7314150051823	1	637
8252-2P	7314150243693	1	189
8252L-2P	7314150246694	1	189
8252XL-1P	7314150265985	1	190
833AJ-4	7311518286927	1	584
833AJ-5	7311518286934	1	584
833AJ-6	7311518286941	1	584
833J-4	7311518286965	1	584
833J-5	7311518286972	1	584
833J-6	7311518286989	1	584
833PJ-4	7311518286897	1	583
833PJ-5	7311518286903	1	583
833PJ-67	7311518286910	1	583
833SB-4	7311518286859	1	584
833SB-5	7311518286866	1	584
833SB-6	7311518286873	1	584
833SB-7	7311518286880	1	584
834V-2	7314150124992	1	583
834V-4	7311518286811	1	583
834V-5	7311518286828	1	583
834V-6	7311518286835	1	583
834V-7	7311518286842	1	583
84-PODGER	7314150307494	1	41
850-1	7311518292737	10	546
8501-10	7311518004828	1	152
8501-10F	7311518220945	1	152
8501-12	7311518004842	1	152
8501-12F	7311518220952	1	152
8501-13	7311518004859	1	152
8501-136-10-24C	7314150371471	1	152
8501-136-20-24C	7314150371488	1	152
8501-13F	7311518220969	1	152
8501-15	7311518004873	1	152
8501-150-10-24C	7314150403004	1	152
8501-15F	7311518220976	1	152
8501-16	7311518004880	1	152
8501-160-20-24C	7314150403011	1	152
8501-160-20-48XF	7314150402892	1	152
8501-165-20-24C	7314150403028	1	152
8501-165-20-48XF	7314150402908	1	152
8501-16F	7311518220983	1	152
8501-16SW	7314150258642	1	152
8501-17	7311518004897	1	152
8501-17F	7311518220990	1	152
8501-17S	7311518221027	1	152
8501-184-16-24	7314150402946	1	152
8501-184-16-40	7314150402953	1	152
8501-184-20-24C	7314150403042	1	152
8501-18S	7311518221034	1	152
8501-18SW	7311518221058	1	152
8501-190-30-24C	7314150403059	1	152
8501-190-30-60XF	7314150402960	1	152
8501-2	7311518004743	1	152
8501-210-30-48SW	7314150403066	1	152
8501-210-30-60XF	7314150402977	1	152
8501-216-60SW	7314150359448	1	152
8501-22	7311518178888	1	152
8501-22F	7311518221003	1	152
8501-23	7311518004958	1	152
8501-230-30-60XF	7314150402984	1	152
8501-235-30-60XF	7314150402991	1	152
8501-23F	7311518018887	1	152
8501-260-24SW	7314150359479	1	152
8501-260-30-80S	7314150403097	1	152
8501-260-40SW	7314150359462	1	152
8501-260-60SW	7314150359455	1	152
8501-28	7311518018894	1	152
8501-28F	7311518221010	1	152



8501-28S	7311518221041	1	152
8501-28SW	7311518221065	1	152
8501-28XF	7311518281946	1	152
8501-3	7311518004750	1	152
8501-30	7311518237479	1	152
8501-305-30-40SW	7314150403073	1	152
8501-305-30-60SW	7314150403080	1	152
8501-305-30-96S	7314150403103	1	152
8501-30F	7311518237462	1	152
8501-30S	7311518282240	1	152
8501-30SW	7311518282196	1	152
8501-30XF	7311518281984	1	152
8501-31	7311518237455	1	152
8501-31F	7311518237448	1	152
8501-4	7311518008079	1	152
8501-40	7311518282042	1	152
8501-4F	7311518220914	1	152
8501-4XF	7311518281786	1	152
8501-5	7311518004774	1	152
8501-5F	7311518220921	1	152
8501-7	7311518004798	1	152
8501-7F	7311518220938	1	152
8510SL-2P	7314150245758	1	492
8520SL-2P	7314150245765	1	492
86	7314150005376	1	41
86-1	7314150254996	1	41
86-2	7314150255009	1	41
8600-2P	7314150246564	1	189
8610-2P	7314150243648	1	189
8610L-2P	7314150246700	1	190
8610SL-2P	7314150243891	1	492
8620-2P	7314150243662	1	189
8620L-2P	7314150246717	1	190
8620SL-2P	7314150243907	1	492
8620XL-1P	7314150265947	1	190
8630-2P	7314150246571	1	189
8630XL-1P	7314150265961	1	190
864000010	8413345137638	1	551
864000020	7314150330171	1	551
864002450	8413345129022	50	551
864100010	8413345137621	1	551
864102400	8413345129015	50	551
865-1	7311518292744	10	546
869102500	8413345083669	6	573
869103000	8413345116640	6	573
869203000	8413345137508	6	573
87	7314150005406	3	41
87-1	7314150255016	1	41
87-2	7314150255023	1	41
8703-2P	7314150246632	1	189
8704-2P	7314150246649	1	189
8705-2P	7314150246656	1	189
8706-2P	7314150246663	1	189
8710SL-2P	7314150245772	1	492
8720SL-2P	7314150245789	1	492
874002000	8413345024938	5	598
874002500	8413345024945	5	598
874003000	8413345024952	5	598
874003500	8413345024969	5	598
874004000	8413345024976	5	598
874005000	8413345024983	5	598
874102000	8413345080989	6	599
874102500	8413345081009	5	599
874103000	8413345081023	5	599
874103500	8413345081047	4	599
874104000	8413345081061	5	599
874602000	8413345024990	5	599
874602500	8413345025003	5	599
874603000	8413345025065	5	599
874603500	8413345025072	5	599
874604000	8413345025089	5	599
876002000	8413345025119	10	599
876002500	8413345025126	5	599
877002400	8413345025140	8	600
8800-2P	7314150246588	1	189
8810-2P	7314150243655	1	189
8810L-2P	7314150246724	1	190
8810SL-2P	7314150243914	1	492
8820-2P	7314150243679	1	189
8820L-2P	7314150246731	1	190
8820SL-2P	7314150243921	1	492
8820XL-1P	7314150265954	1	190
8821MB	7314150220571	1	104
8830-2P	7314150246595	1	189
8830XL-1P	7314150265978	1	190
8840M	7314151105495	1	104
8845DM	7314151105525	1	104
8845NM	7314151810955	1	104
8900DM-19	7314151105730	1	102
8900DM-21	7314150166367	5	102
8900DM-22	7314151105754	1	102
8900DM-23	7314150166374	1	102
8900DM-24	7314151105778	1	102
8900DM-25	7314151105785	1	102
8900DM-26	7314150219797	1	102
8900DM-27	7314151105822	1	102



**8900DM-28**

8900DM-28	7314151105846	1	102
8900DM-29	7314150219803	1	102
8900DM-30	7314151105884	1	102
8900DM-32	7314151105891	1	102
8900DM-33	7314150166398	1	102
8900DM-34	7314151838478	1	102
8900DM-35	7314150219810	1	102
8900DM-36	7314151105914	1	102
8900DM-37	7314150166404	1	102
8900DM-38	7314150219827	1	102
8900DM-40	7314150166411	1	102
8900DM-41	7314151105938	1	102
8900DM-42	7314150166428	1	102
8900DM-46	7314151105952	1	102
8900DM-47	7314150166435	1	102
8900DM-50	7314151105969	1	102
8900DM-52	7314150166442	1	102
8900DM-54	7314150166459	3	102
8900DM-55	7314151105983	1	102
8900DM-56	7314150166466	1	102
8900DM-60	7314151106003	1	102
8900DZ-1	7314151106058	1	102
8900DZ-1.1/16	7314151106065	1	102
8900DZ-1.1/2	7314151106133	1	102
8900DZ-1.1/4	7314151106096	1	102
8900DZ-1.1/8	7314151106072	1	102
8900DZ-1.11/16	7314150166282	1	102
8900DZ-1.13/16	7314151106188	1	102
8900DZ-1.3/16	7314151106089	1	102
8900DZ-1.3/4	7314151106171	1	102
8900DZ-1.3/8	7314151106119	1	102
8900DZ-1.5/16	7314151106102	1	102
8900DZ-1.5/8	7314151106157	1	102
8900DZ-1.7/16	7314151106126	1	102
8900DZ-1.7/8	7314151106195	1	102
8900DZ-1.9/16	7314150166299	1	102
8900DZ-13/16	7314150166305	1	102
8900DZ-15/16	7314151106034	1	102
8900DZ-2	7314151106201	1	102
8900DZ-2.1/16	7314150166312	1	102
8900DZ-2.1/4	7314150166329	1	102
8900DZ-2.1/8	7314150166336	1	102
8900DZ-2.3/16	7314150358670	1	102
8900DZ-2.3/8	7314150166350	1	102
8900DZ-3/4	7314150166381	1	102
8900DZ-31/32	7314150358663	1	102
8900DZ-7/8	7314150166473	1	102
8900SM-19	7314150166633	1	101
8900SM-22	7314151810795	1	101
8900SM-23	7314150219834	1	101
8900SM-24	7314151810801	1	101
8900SM-26	7314150219841	1	101
8900SM-27	7314151810818	1	101
8900SM-28	7314150166657	1	101
8900SM-29	7314150219858	1	101
8900SM-30	7314151810825	1	101
8900SM-32	7314151810832	1	101
8900SM-33	7314150166671	1	101
8900SM-34	7314151838461	1	101
8900SM-35	7314150166688	1	101
8900SM-36	7314151810849	1	101
8900SM-38	7314151810856	1	101
8900SM-41	7314151810863	1	101
8900SM-42	7314150219865	1	101
8900SM-46	7314151810870	1	101
8900SM-50	7314151810887	1	101
8900SM-55	7314151810894	1	101
8900SM-60	7314151810900	1	101
8900SZ-1	7314150166480	1	101
8900SZ-1.1/16	7314150166497	1	101
8900SZ-1.1/2	7314150166503	1	101
8900SZ-1.1/4	7314150166510	1	101
8900SZ-1.1/8	7314150166527	1	101
8900SZ-1.13/16	7314150166534	1	101
8900SZ-1.3/4	7314150166541	1	101
8900SZ-1.3/8	7314150166558	1	101
8900SZ-1.5/16	7314150166565	1	101
8900SZ-1.5/8	7314150166572	1	101
8900SZ-1.7/16	7314150166589	1	101
8900SZ-1.7/8	7314150166596	1	101
8900SZ-1.9/16	7314150166602	1	101
8900SZ-13/16	7314150166619	1	101
8900SZ-15/16	7314150166626	1	101
8900SZ-3/4	7314150166664	1	101
8900SZ-7/8	7314150166695	1	101
89049TM-1000	7314150415403	1	135
8905-TM	7314150125470	1	135
8910-2P	7314150243709	1	189
8910SL-2P	7314150243938	1	492
8915-2P	7314150243716	1	189
8915L-2P	7314150258765	1	190
8915SL-2P	7314150243945	1	492
8920-2P	7314150243723	1	189
8920L-2P	7314150258772	1	190
8920SL-2P	7314150243952	1	492
89222CR-1000	7314150415441	1	135



8925-2P	7314150243730	1	189
8925L-2P	7314150258789	1	190
8925SL-2P	7314150243969	1	492
8927-2P	7314150243747	1	189
8927L-2P	7314150263516	1	190
8930-2P	7314150243754	1	189
8930L-2P	7314150258796	1	190
8930SL-2P	7314150243976	1	492
8940-2P	7314150243761	1	189
894M-10	7314151833039	10	54
894M-100	7314151833305	1	54
894M-105	7314151833312	1	54
894M-11	7314151833046	10	54
894M-110	7314151833329	1	54
894M-115	7314151833336	1	54
894M-12	7314151833053	1	54
894M-120	7314151833343	10	54
894M-125	7314150132478	1	54
894M-13	7314151833060	10	54
894M-130	7314150132485	1	54
894M-135	7314150132492	1	54
894M-14	7314151833077	10	54
894M-15	7314151833084	10	54
894M-16	7314150139569	10	54
894M-17	7314151833091	10	54
894M-19	7314151833107	10	54
894M-21	7314150223220	5	54
894M-22	7314151833114	5	54
894M-24	7314151833121	5	54
894M-27	7314151833138	5	54
894M-30	7314151833145	5	54
894M-32	7314151833152	5	54
894M-34	7314150139583	1	54
894M-36	7314151833169	5	54
894M-38	7314151833176	1	54
894M-41	7314151833183	1	54
894M-46	7314151833190	1	54
894M-50	7314151833206	1	54
894M-55	7314151833213	1	54
894M-60	7314151833220	1	54
894M-65	7314151833237	1	54
894M-7	7314151833008	10	54
894M-70	7314151833244	1	54
894M-75	7314151833251	1	54
894M-8	7314151833015	10	54
894M-80	7314151833268	1	54
894M-85	7314151833275	1	54
894M-9	7314151833022	10	54
894M-90	7314151833282	1	54
894M-95	7314151833299	1	54
8950N	7314151810931	1	103
8950N/A	7314151810948	1	103
8950NA-SO/2	7314151816605	1	104
8951	7314151106782	1	104
8951-M	7314150124916	1	126
8952N	7314150180196	1	103
8952N/A	7314150180202	1	103
8952N/B	7314150180219	1	102
8953	7314151106799	1	102
8954	7314151106805	1	102
8954A	7314151106812	1	102
8955N	7314150434114	1	103
8955N-SPARE	7314150434121	1	104
8955N/A	7314150434053	1	103
8955N/B	7314150434176	5	103
8958	7314151106829	1	102
8958A	7314151106836	1	102
895M-10-11	7314151832742	10	52
895M-10-13	7314151832759	10	52
895M-13-17	7314151832803	10	52
895M-17-19	7314151832827	10	52
895M-19-22	7314151832834	10	52
895M-19-24	7314151832841	5	52
895M-22-24	7314151832858	5	52
895M-24-27	7314151832865	5	52
895M-24-30	7314151832872	5	52
895M-27-32	7314151832889	5	52
895M-30-32	7314151832896	5	52
895M-30-36	7314151832902	1	52
895M-32-36	7314151832919	1	52
895M-36-41	7314151832926	1	52
895M-41-46	7314151832933	1	52
895M-46-50	7314151832940	1	52
895M-50-55	7314151832957	1	52
895M-55-60	7314151832964	1	52
895M-6-7	7314151832711	10	52
895M-65-70	7314151832971	1	52
895M-8-10	7314151832735	10	52
895M-8-9	7314151832728	10	52
8961	7314151106850	1	103
8962	7314151106867	1	103
8963	7314150181087	1	103
8965	7314151106881	1	103
8966	7314151106898	1	103
8967	7314153003591	1	92
8967/S3	7314153003607	1	69



9-12-51/3806-KP	7311518044558	5	627
9-462-14-0-0	7311518020873	5	36
9-463-14-0-0	7311518327750	1	36
9-467-00-0-0	7311518020897	1	37
9-469-00-0-0	7311518020903	1	37
9-484-3.2-10	7311518193348	10	37
9-484-3.2-1P	7311518193522	10	37
9-484-5.2-10	7311518193355	10	37
9-484-5.2-1P	7311518193331	10	37
9-485-04-10	7314150271672	10	37
9-485-04-1P	7314150271665	10	37
9-485-05-10	7314150271696	10	37
9-485-05-1P	7314150271689	10	37
9-485-06-10	7311518193508	10	37
9-485-06-1P	7311518193492	20	37
9-485-09-10	7311518193386	10	37
9-485-09-1P	7311518193362	20	37
9-485-13-10	7311518193393	10	37
9-485-13-1P	7311518193379	1	37
9-486-04-10	7311518193430	10	38
9-486-04-1P	7311518193409	10	38
9-486-05-10	7311518193461	10	38
9-486-05-1P	7311518193447	20	38
9-486-07-10	7311518249373	10	38
9-486-07-1P	7311518249359	20	38
9-486-08-10	7311518270933	10	38
9-486-C-10	7311518209599	10	37
9-486-C-1P	7311518209605	10	37
9-488-02-10	7311518194772	10	36
900T-020-100	7314153018106	5	207
900T-025-100	7314153018113	5	207
900T-030-100	7314153018120	5	207
900T-040-150	7314153018137	5	207
900T-050-150	7314153018144	5	207
900T-060-200	7314153018151	5	207
900T-080-200	7314153018168	5	207
900T-100-200	7314153018175	5	207
901T-006-100	7314153018182	5	207
901T-007-100	7314153018199	5	207
901T-008-100	7314153018205	5	207
901T-009-100	7314153018212	5	207
901T-010-100	7314153018229	5	207
901T-015-150	7314153018236	5	207
901T-020-150	7314153018243	5	207
901T-025-150	7314153018250	5	207
901T-027-150	7314153018267	5	207
901T-030-200	7314153018274	5	207
901T-040-200	7314153018281	5	207
901T-045-200	7314153018298	5	207
901T-050-200	7314153018304	5	207
9029	7314153010612	5	40
9029 C	7314153010629	5	40
9029-1	7314150239580	1	41
9029-2	7314150238668	1	41
9029-T	7314150189076	5	40
9029T-1	7314150312139	1	41
902T-050-150	7314153018311	5	207
902T-055-150	7314153018328	5	207
902T-060-150	7314153018335	5	207
902T-070-175	7314153018342	5	207
902T-080-175	7314153018359	5	207
902T-090-175	7314153018366	5	207
902T-100-175	7314153018373	5	207
902T-110-175	7314153018380	5	207
902T-120-175	7314153018397	5	207
902T-130-175	7314153018403	5	207
9031	7314150110988	5	40
9031 C	7314150113507	5	40
9031 P-1	7314150266302	1	41
9031-1	7314150239597	1	41
9031-8224	7314150321193	3	249
9031-T	7314150131648	5	40
9031P	7314150187539	5	40
9031T-1	7314150312146	1	41
9033	7314150181414	5	40
9033-1	7314150353804	1	41
9035	7314150181421	5	40
9035-1	7314150353811	1	41
903T-1	7314153018410	1	208
903T-2	7314153018427	1	208
903T-3	7314153018434	1	208
9045-B-200	7311518012175	6	541
9045-B-250	7311518012182	6	541
9045-B-300	7311518012199	6	541
9045-B-400	7311518178123	1	541
9048-200	7314150138159	10	542
9048-250	7314150138166	10	542
9048-300	7314150138173	10	542
9048-350	7314150180349	10	542
9048-400	7314150138180	10	542
904T-060-150	7314153019837	5	209
905T-060-100	7314153019844	5	208
9070	7314150100170	5	40
9070 P	7314150103416	5	40
9070 P-1	7314150239610	1	41
9070 PC	7314150103423	5	40



9070C	7314150100187	5	40
9071	7314150100194	5	40
9071 P	7314150103430	5	40
9071 P-1	7314150239627	1	41
9071 PC	7314150103447	5	40
9071C	7314150100200	5	40
9072	7314150055609	5	40
9072 C	7314150055616	5	40
9072 P	7314150056354	5	40
9072 P-1	7314150239634	1	41
9072 PC	7314150056361	5	40
9073	7314150101702	5	40
9073 C	7314150101719	3	40
9073 P	7314150101726	5	40
9073 P-1	7314150239641	1	41
9073 PC	7314150101733	3	40
91-023-5P	7311518032593	1	150
91-027-5P	7311518032616	1	150
91-143-5P	7311518032630	1	150
91-148-5P	7311518032654	1	150
91-223-5P	7311518032661	1	150
91-226-5P	7311518032685	1	150
91-233-5P	7311518260057	1	150
91-243-5P	7311518032692	1	150
91-2PW-5P	7311518260163	1	150
91-3PM-5P	7311518260156	1	150
91-412-5P	7311518260040	1	150
91-433-5P	7311518260101	1	150
91-434-5P	7311518260026	1	150
91-443-5P	7311518032722	1	150
91-444-5P	7311518260033	1	150
91-4PWM-5P	7311518260170	1	150
91-502-5P	7311518032746	1	150
91-517-5P	7311518032777	1	150
91-522-5P	7311518032784	1	150
91-611-5P	7311518260071	1	150
91-612-5P	7311518032814	1	150
91-622-5P	7311518260088	1	150
91-623-5P	7311518260064	1	150
91-7V1-5P	7311518260118	1	150
91-METAL-10P	7314150449477	50	150
91-MIXED-10P	7314150449491	50	150
91-WOOD-10P	7314150449446	50	150
91C	7314150182381	5	42
9210	7311518278182	1	632
9210-1	7311518278212	1	632
9210-10	7311518278229	1	632
9210-1060177	7311518295424	1	633
9210-1060238	7311518295394	20	633
9210-1230219	7311518295387	20	633
9210-1230235	7311518295325	1	632
9210-1320281	7311518295431	10	633
9210-1640142	7311518295356	1	632
9210-1690148	7311518295332	1	632
9210-1700118	7311518295363	1	632
9210-1710266	7311518295417	1	633
9210-1720100	7311518295295	1	632
9210-1730107	7311518295349	10	632
9210-1770106	7311518295370	10	632
9210-1830137	7311518295400	1	633
9210-20	7311518278236	1	632
92C	7314150182398	5	42
93C	7314150182404	5	42
94C	7314150182411	5	42
9500DZ-1.13/16	7314150227501	1	105
9500DZ-1.5/8	7314150227495	1	105
9500DZ-1.7/8	7314150227518	1	105
9500DZ-2	7314150227525	1	105
9500DZ-2.1/2	7314150227570	1	105
9500DZ-2.1/4	7314150227556	1	105
9500DZ-2.1/8	7314150227532	1	105
9500DZ-2.15/16	7314150227617	1	105
9500DZ-2.3/16	7314150227549	1	105
9500DZ-2.3/4	7314150227600	1	105
9500DZ-2.3/8	7314150227563	1	105
9500DZ-2.5/8	7314150227594	1	105
9500DZ-2.9/16	7314150227587	1	105
9500DZ-3	7314150227624	1	105
9500DZ-3.1/8	7314150227631	1	105
9500SM-41	7314153013699	1	105
9500SM-46	7314153013705	1	105
9500SM-50	7314153013712	1	105
9500SM-54	7314153013729	1	105
9500SM-55	7314153013736	1	105
9500SM-58	7314153013743	1	105
9500SM-60	7314153013750	1	105
9500SM-63	7314153013767	1	105
9500SM-65	7314153013774	1	105
9500SM-67	7314153013781	1	105
9500SM-70	7314153013798	1	105
9500SM-71	7314153013804	1	105
9500SM-75	7314153013811	1	105
9500SM-77	7314153013828	1	105
9500SM-80	7314153013835	1	105
9500SM-82	7314153013842	1	105
9505-3400	7314150125517	1	135



9505-TM



9505-TM	7314150125487	1	135
95155B-3000	7314150415410	1	135
9525-10	7311518031817	1	165
9525-3400	7314150125524	1	135
9525-7	7311518031800	1	165
9525CR-4000	7314150415465	1	135
9526B-4500	7314150415427	1	135
9527CR-2000	7314150415458	1	135
9528-MD-15-45	7311518007447	10	164
9528-MD-22-76	7311518041441	10	164
9540DZ	7314150414048	1	106
9540DZL	7314150414055	1	106
9540MB	7314153014108	1	106
9540MBL	7314153014115	1	106
9550N	7314150424160	1	106
9550N-SPARE	7314150424153	1	106
9550N/A	7314150424146	1	106
9550N/B	7314150424788	1	106
9555	7314153014047	1	105
9555AB	7314153014061	1	105
956	7314150025190	1	568
9560AB	7314153014078	1	105
9563AB	7314153014085	1	105
9564	7314151107543	1	103
9565AB	7314153014092	1	106
9566A	7314150220618	1	105
9570C	7314150191215	5	42
9572	7314150178599	5	42
9572-200	7311518004231	6	542
9572-250	7311518004248	6	542
9573	7314150178605	5	42
9574-200	7314150138197	10	542
9574-250	7314150138203	10	542
9574-300	7314150180356	10	542
9575-250	7314150185894	6	542
95C	7314150182428	1	42
960100010	8413345031073	1	458
960100020	8413345031080	1	458
960100030	8413345031097	1	458
960100050	8413345031103	1	458
960100060	8413345031110	1	458
9625-6.35QC	7314150441716	1	165
9625-9500	7314150125555	1	135
96255CR-7000	7314150415489	1	135
9626-10	7314150388844	1	163
9626-11	7314150388851	1	163
9626-12	7314150388868	1	163
9626-13	7314150388875	1	163
9626-14	7314150388882	1	163
9626-15	7314150444526	1	163
9626-16	7314150388899	1	163
9626-18	7314150388905	1	163
9626-20	7314150388912	1	163
9626-22	7314150388929	1	163
9626-23	7314150388936	1	163
9626-24	7314150388943	1	163
9626-25	7314150388950	1	163
9626-26	7314153024237	1	163
9626-28	7314150388967	1	163
9626-30	7314150388974	1	163
9626-32	7314150388981	1	163
9626-35	7314150444533	1	163
9626-6	7314150388806	1	163
9626-7	7314150388813	1	163
9626-8	7314150388820	1	163
9626-9	7314150388837	1	163
9627-10-460	7314150389018	1	163
9627-12-460	7314150389025	1	163
9627-14-460	7314150389032	1	163
9627-16-460	7314150389049	1	163
9627-18-460	7314150389056	1	163
9627-20-460	7314150389063	1	163
9627-22-460	7314150389070	1	163
9627-24-460	7314150389087	1	163
9627-26-460	7314150389094	1	163
9627-28-460	7314150389100	1	163
9627-30-460	7314150389117	1	163
9627-32-460	7314150389124	1	163
9627-6-460	7314150388998	1	163
9627-8-460	7314150389001	1	163
9629-10	7314150388479	1	164
9629-12	7314150388486	1	164
9629-13	7314150440238	1	164
9629-14	7314150388493	1	164
9629-16	7314150388509	1	164
9629-17	7314150440245	1	164
9629-18	7314150388516	1	164
9629-19	7314150440252	1	164
9629-20	7314150388523	1	164
9629-22	7314150388530	1	164
9629-24	7314150388547	1	164
9629-25	7314150388554	1	164
9629-26	7314150388561	1	164
9629-28	7314150388578	1	164
9629-30	7314150388585	1	164
9629-32	7314150388592	1	164



9629-35	7314150440269	1	164
9629-36	7314150388608	1	164
9629-38	7314150388615	1	164
9629-40	7314150388622	1	164
9629-6	7314150388417	1	164
9629-8	7314150388462	1	164
9629-SET-8	7314150441648	1	164
9631-10-400	7314150388684	30	164
9631-12-400	7314150388691	1	164
9631-14-400	7314150388707	1	164
9631-16-400	7314150388714	1	164
9631-18-400	7314150388721	1	164
9631-20-400	7314150388738	1	164
9631-22-400	7314150388745	1	164
9631-24-400	7314150388752	1	164
9631-25-400	7314150432066	1	164
9631-28-400	7314150388776	1	164
9631-30-400	7314150388783	1	164
9631-32-400	7314150388790	1	164
9631-35-400	7314150447596	1	164
9631-6-400	7314150388646	1	164
9631-8-400	7314150388677	1	164
9646-10	7314150388264	1	164
9646-10-250	7314150388387	1	164
9646-11	7314150388288	1	164
9646-12	7314150388295	1	164
9646-12-250	7314150388400	1	164
9646-13	7314150388301	1	164
9646-14	7314150388318	1	164
9646-15	7314150388325	1	164
9646-16	7314150388332	1	164
9646-18	7314150388349	1	164
9646-20	7314150388356	1	164
9646-3	7314150388189	1	164
9646-4	7314150388202	1	164
9646-5	7314150388219	1	164
9646-6	7314150388226	1	164
9646-6-250	7314150388363	1	164
9646-7	7314150388233	1	164
9646-8	7314150388240	1	164
9646-8-250	7314150388370	1	164
9646-9	7314150388257	1	164
9646-SET-5	7314150441686	1	164
9646-SET-8	7314150441693	1	164
96C	7314150134120	1	42
97-1	7314150366637	1	131
97-1/2	7314150366545	1	131
97-1/4	7314150366507	1	131
97-10	7314150366286	1	131
97-11	7314150366293	1	131
97-11/16	7314150366583	1	131
97-12	7314150366309	1	131
97-13	7314150366316	1	131
97-13/16	7314150366606	1	131
97-14	7314150366323	1	131
97-15	7314150366330	1	131
97-15/16	7314150366620	1	131
97-16	7314150366347	1	131
97-17	7314150366354	1	131
97-17/32	7314150366552	1	131
97-18	7314150366361	1	131
97-19	7314150366378	1	131
97-21	7314150366385	1	131
97-22	7314150349722	1	131
97-24	7314150357048	1	131
97-27	7314150366392	1	131
97-3/4	7314150366590	1	131
97-3/8	7314150366521	1	131
97-30	7314150366408	1	131
97-32	7314150366415	1	131
97-5/16	7314150366514	1	131
97-5/8	7314150366576	1	131
97-7	7314150366255	1	131
97-7/16	7314150366538	1	131
97-7/8	7314150366613	1	131
97-8	7314150366262	1	131
97-9	7314150366279	1	131
97-9/16	7314150366569	1	131
9710-10-175	7314151785789	5	210
9710-3.5-75	7314151785192	10	210
9710-5.5-100	7314151785352	10	210
9710-6.5-125	7314151785437	10	210
9710-8-150	7314151785512	5	210
9710/S6	7314151802301	1	210
9715-14-250	7314153010148	5	211
9733	7314150103256	1	248
9778-1	7314151793524	10	210
9778-2	7314151793531	10	210
9778-3	7314151793548	5	210
9778PZD-1	7314151823535	10	210
9778PZD-2	7314151823542	10	210
97C	7314150128211	1	42
98-1/2	7314150367481	1	132
98-1/4	7314150367443	1	132
98-10	7314150367320	1	132
98-11	7314150367337	1	132



98-11/16	7314150367511	1	132
98-12	7314150367344	1	132
98-13	7314150367351	1	132
98-13/16	7314150367535	1	132
98-14	7314150367368	1	132
98-15	7314150367375	1	132
98-16	7314150367382	1	132
98-17	7314150367399	1	132
98-18	7314150367405	1	132
98-19	7314150367412	1	132
98-21	7314150367429	1	132
98-22	7314150367436	1	132
98-3/4	7314150367528	1	132
98-3/8	7314150367467	1	132
98-5/16	7314150367450	1	132
98-5/8	7314150367504	1	132
98-7	7314150367290	1	132
98-7/16	7314150367474	1	132
98-7/8	7314150367542	1	132
98-8	7314150367306	1	132
98-9	7314150367313	1	132
98-9/16	7314150367498	1	132
981001100	7314150219902	1	432
982000170	7314150219926	1	464
982000320	7314150219919	1	422
982000350	7314150219933	1	426
983000320	7314150219940	1	425
983100320	7314150219964	1	425
984010320	7314150219971	1	426
98505	7314150216321	5	207
9853	7314150103287	1	249
9854	7314150111831	1	646
9854W	7314150112760	1	646
9855	7314150111848	1	646
9855W	7314150112777	1	646
9856	7314150111855	1	646
9857	7314150114283	1	646
9858	7314150111862	1	646
9858W	7314150112784	1	646
9859	7314150113057	1	646
9873	7314150058082	1	249
9883	7314150043293	1	567
9897	7314150058068	1	249
99-1/2	7314150368150	1	133
99-10	7314150368013	1	132
99-11	7314150368020	1	132
99-11/16	7314150368181	1	133
99-12	7314150368037	1	132
99-13	7314150368044	1	132
99-14	7314150368051	1	132
99-16	7314150368068	1	132
99-17	7314150368075	1	133
99-18	7314150368082	1	133
99-19	7314150368099	1	133
99-21	7314150368105	1	133
99-22	7314150368112	1	133
99-24	7314150368129	1	133
99-3/4	7314150368198	1	133
99-3/8	7314150368136	1	133
99-5/8	7314150368174	1	133
99-7/16	7314150368143	1	133
99-9/16	7314150368167	1	133
9938	7314150056491	1	243
9A-14	7314150368204	1	129
9B-1/4	7314150366071	1	130
9B-5/16	7314150366088	1	130
9F-1/2	7314150366194	1	131
9F-1/4	7314150366170	1	130
9F-3/8	7314150366187	1	130
9P-1/2	7314150366057	1	130
9P-1/4	7314150366033	1	130
9P-3/8	7314150366040	1	130
9Q-1/2	7314150366019	1	130
9Q-1/4	7314150365999	1	130
9Q-3/8	7314150366002	1	130
9R-1/2	7314150365913	1	130
9R-1/4	7314150365890	1	130
9R-3/8	7314150365906	1	130
9T-1/2	7314150366118	1	130
9T-1/4	7314150366095	1	130
9T-3/8	7314150366101	1	130
9W	7314150354399	1	129
A0313C03	7311518023713	1	153
A0313F03	7311518023690	1	153
A0313F03E	7311518212780	1	153
A0313M03	7311518023706	1	153
A0313M03E	7311518192150	1	153
A0313M03X	7311518182038	1	153
A0313M03XE	7311518181475	1	153
A0313M03XE-60	7311518184513	1	153
A0313M03XE-80	7311518201357	1	153
A0320M03X	7311518197773	1	156
A0408F03D	7311518197926	1	156
A0610F06D	7311518197933	1	156
A0613M03X	7311518197872	1	153
A0616AL06E	7311518181802	1	155



A0616C06	7311518023782	1	153
A0616F06	7311518023720	1	153
A0616M06	7311518023737	1	153
A0616M06DE	7311518212629	1	153
A0616M06E	7311518023751	1	153
A0616M06X	7311518023768	1	153
A0616M06XE	7311518181468	1	153
A0625M06X	7311518197780	1	156
A0810F06D	7311518197957	1	156
A0820C06	7311518023850	1	153
A0820F06	7311518023799	1	153
A0820F06E	7311518212803	1	153
A0820M06	7311518023805	1	153
A0820M06E	7311518023829	1	153
A0820M06X	7311518023836	1	153
A0820M06XE	7311518181994	1	153
A1020C06	7311518023928	1	153
A1020F06	7311518023867	1	153
A1020M06	7311518023874	1	153
A1020M06E	7311518023898	1	153
A1020M06X	7311518023904	1	153
A1020M06XE	7311518182007	1	153
A1040M06X	7311518233129	1	153
A1050M06X	7311518233136	1	153
A1225AL06E	7311518187620	1	155
A1225AL08E	7311518181819	1	155
A1225C06	7311518023997	1	153
A1225C08	7311518100544	1	153
A1225F06	7311518023935	1	153
A1225F06E	7311518212810	1	153
A1225F08	7311518024000	1	153
A1225M06	7311518023942	1	153
A1225M06DE	7311518212636	1	153
A1225M06E	7311518023966	1	153
A1225M06X	7311518023973	1	153
A1225M06XE	7311518182014	1	153
A1225M08	7311518100506	1	153
A1225M08E	7311518100520	1	153
A1225M08X	7311518187989	1	153
A1225M08XE	7311518192174	1	153
A1625C06	7311518192204	1	153
A1625C08	7311518100612	1	153
A1625F06	7311518192198	1	153
A1625F08	7311518100551	1	153
A1625M06	7311518192181	1	153
A1625M06X	7311518187361	1	153
A1625M06XE	7311518187354	1	153
A1625M08	7311518100568	1	153
A1625M08E	7311518100582	1	153
A1625M08X	7311518100599	1	153
A1625M08XE	7311518182021	1	153
A6700DM-10	7314151821722	5	67
A6700DM-11	7314151821739	5	67
A6700DM-12	7314151821746	5	67
A6700DM-13	7314151821753	5	67
A6700DM-14	7314151821760	5	67
A6700DM-5	7314150220632	5	67
A6700DM-5.5	7314151821678	5	67
A6700DM-6	7314151821685	5	67
A6700DM-7	7314151821692	5	67
A6700DM-8	7314151821708	5	67
A6700DM-9	7314151821715	5	67
A6700DZ-1/2	7314151751883	5	67
A6700DZ-1/4	7314151751371	5	67
A6700DZ-11/32	7314151819842	5	67
A6700DZ-3/16	7314151751029	5	67
A6700DZ-3/8	7314151751616	5	67
A6700DZ-5/16	7314151751531	5	67
A6700DZ-7/16	7314151819859	5	67
A6700DZ-7/32	7314151751296	5	67
A6700DZ-9/16	7314151751968	5	67
A6700DZ-9/32	7314151751456	5	67
A6709M-2.5	7314151753740	1	71
A6709M-3	7314151753825	1	71
A6709M-4	7314151754129	1	71
A6709M-5	7314151754471	1	71
A6709M-6	7314151754556	1	71
A6709Z-1/8	7314151755447	1	71
A6709Z-3/16	7314151755874	1	71
A6709Z-5/32	7314151755799	1	71
A6709Z-9/64	7314151755522	1	71
A6710DM-10	7314151756765	1	68
A6710DM-11	7314151756840	1	68
A6710DM-12	7314151756925	1	68
A6710DM-13	7314151757069	1	68
A6710DM-14	7314151757144	1	68
A6710DM-5.5	7314151756178	1	68
A6710DM-6	7314151756253	1	68
A6710DM-7	7314151756338	1	68
A6710DM-8	7314151756413	1	68
A6710DM-9	7314151756680	1	68
A6710DZ-1/2	7314151820466	1	68
A6710DZ-1/4	7314151757229	1	68
A6710DZ-11/32	7314151757571	1	68
A6710DZ-3/16	7314151820435	1	68
A6710DZ-3/8	7314151757656	1	68



# A6710DZ-5/16



A6710DZ-5/16	7314151757496	1	68
A6710DZ-7/16	7314151757731	1	68
A6710DZ-7/32	7314151820442	1	68
A6710DZ-9/16	7314151820473	1	68
A6710DZ-9/32	7314151820459	1	68
A6716DM	7314151820824	1	72
A6716DZ	7314151820831	1	75
A6718DZ	7314150312450	1	75
A6800DM-10	7314151821845	1	67
A6800DM-11	7314151821852	1	67
A6800DM-12	7314151821869	1	67
A6800DM-13	7314151821876	1	67
A6800DM-14	7314151821883	1	67
A6800DM-4	7314151821777	1	67
A6800DM-5	7314151821784	1	67
A6800DM-5.5	7314151821791	1	67
A6800DM-6	7314151821807	1	67
A6800DM-7	7314151821814	1	67
A6800DM-8	7314151821821	1	67
A6800DM-9	7314151821838	1	67
A6800DZ-1/2	7314151758899	1	67
A6800DZ-1/4	7314151758387	1	67
A6800DZ-11/32	7314151803872	1	67
A6800DZ-3/16	7314151758035	1	67
A6800DZ-3/8	7314151758622	1	67
A6800DZ-5/16	7314151758547	1	67
A6800DZ-7/16	7314151803889	1	67
A6800DZ-7/32	7314151758110	1	67
A6800DZ-9/16	7314151758974	1	67
A6800DZ-9/32	7314151758462	1	67
A6800SM-10	7314150360147	1	67
A6800SM-11	7314150360154	1	67
A6800SM-12	7314150360161	1	67
A6800SM-13	7314150360178	1	67
A6800SM-14	7314150360185	1	67
A6800SM-15	7314150360192	1	67
A6800SM-4	7314150360208	1	67
A6800SM-4.5	7314150360215	1	67
A6800SM-5	7314150360222	1	67
A6800SM-6	7314150360239	1	67
A6800SM-7	7314150360246	1	67
A6800SM-8	7314150360253	1	67
A6800SM-9	7314150360260	1	67
A6800SZ-1/8	7314150360277	1	67
A6800SZ-5/32	7314150360284	1	67
A7400DM-10	7314151819972	5	79
A7400DM-11	7314151819989	5	79
A7400DM-12	7314151819996	5	79
A7400DM-13	7314151820008	5	79
A7400DM-14	7314151820015	5	79
A7400DM-15	7314151820022	5	79
A7400DM-16	7314151820039	5	79
A7400DM-17	7314151820046	5	79
A7400DM-18	7314151820053	5	79
A7400DM-19	7314151820060	5	79
A7400DM-20	7314151820077	5	79
A7400DM-21	7314151820084	5	79
A7400DM-22	7314151820091	5	79
A7400DM-24	7314150386123	5	79
A7400DM-6	7314150118212	5	79
A7400DM-7	7314150118229	5	79
A7400DM-8	7314150118236	5	79
A7400DM-9	7314151819965	5	79
A7400DZ-1/2	7314151759780	5	79
A7400DZ-1/4	7314151759193	5	79
A7400DZ-11/16	7314151819897	5	79
A7400DZ-13/16	7314151819910	5	79
A7400DZ-17/32	7314151819866	5	79
A7400DZ-19/32	7314151819873	5	79
A7400DZ-3/4	7314151819903	5	79
A7400DZ-3/8	7314151759438	5	79
A7400DZ-5/16	7314151759278	5	79
A7400DZ-5/8	7314151819880	5	79
A7400DZ-7/16	7314151759513	5	79
A7400DZ-7/8	7314151819927	5	79
A7400DZ-9/16	7314151759865	5	79
A7402DM-10	7314151820138	1	80
A7402DM-11	7314151820145	1	80
A7402DM-12	7314151820152	1	80
A7402DM-13	7314151820169	1	80
A7402DM-14	7314151820176	1	80
A7402DM-15	7314151820183	1	80
A7402DM-16	7314151820190	1	80
A7402DM-17	7314151820206	1	80
A7402DM-18	7314151820213	1	80
A7402DM-19	7314151820220	1	80
A7402DM-21	7314150385881	1	80
A7402DM-7	7314150220243	1	80
A7402DM-8	7314150220250	1	80
A7402DM-9	7314150220267	1	80
A7402DZ-1/2	7314151760526	1	80
A7402DZ-1/4	7314151759940	1	80
A7402DZ-11/16	7314151820114	1	80
A7402DZ-13/16	7314153003027	1	80
A7402DZ-19/32	7314153003041	1	80
A7402DZ-3/4	7314151820121	1	80



A7402DZ-3/8	7314151760366	1	80
A7402DZ-5/16	7314151760014	1	80
A7402DZ-5/8	7314151820107	1	80
A7402DZ-7/16	7314151760441	1	80
A7402DZ-7/8	7314153003034	1	80
A7402DZ-9/16	7314151760793	1	80
A7410DZ-1/2	7314153006301	1	79
A7410DZ-11/16	7314153006332	1	79
A7410DZ-3/4	7314153006349	1	79
A7410DZ-3/8	7314153006288	1	79
A7410DZ-5/16	7314153006271	1	79
A7410DZ-5/8	7314153006325	1	79
A7410DZ-7/16	7314153006295	1	79
A7410DZ-9/16	7314153006318	1	79
A7435DME	7314153015006	1	86
A7440DME	7314153015419	1	86
A7440DZE	7314153014993	1	86
A7535DZE	7314153015013	1	87
ADJUST 9031/29	7314150302925	3	40
AP-234-F	7311518289027	2	622
AP-3M	7311518152062	1	621
AP-5M	7311518152079	1	621
APB260	7314150389162	10	606
APB360	7314150389186	10	606
AS-1200	7314150321520	3	542
AS-C33-JT-F	7314150341672	15	629
AS-C36-JT-M	7311518337490	15	629
AS-C39-JT-C	7314150341542	15	629
AS-C45-JT-C	7314150341559	15	629
ASP-1200	7311518347123	1	621
ASP-1500G	7311518347109	1	621
ASP-1850	7311518337124	1	621
ASP-1850G	7311518337131	1	621
ASP-AS	7311518337377	4	621
ASP-AS-C33-JT-F	7314150341665	5	622
ASP-AS-C36-JT-M	7314150340590	5	622
ASP-AS-C39-JT-C	7314150341535	5	622
ASP-AS-C45-JT-C	7314150341566	2	622
ASP-AS-HOOK	7311518337582	4	621
ASP-ATP	7311518337384	4	621
ASP3740-C36JTM	7314150341818	1	623
ASP3740-C39JTC	7314150353347	1	623
ASP3740-C45JTC	7314150353354	1	623
ASP3740-P3437	7314150341801	1	622
ATP-110-210	7311518337575	1	621
ATP-200-350	7311518347062	1	621
ATP-200-500	7311518347055	1	621
ATP-230-410	7311518337599	2	622
B141.007.075	7314150278404	5	195
B141.008.075	7314150278411	5	195
B141.009.075	7314150278428	5	195
B141.010.075	7314150278435	5	195
B141.015.100	7314150278442	5	195
B141.020.100	7314150278459	5	195
B141.025.125	7314150278466	5	195
B141.027.125	7314150278473	5	195
B141.030.150	7314150278480	5	195
B141.040.150	7314150278497	5	195
B142.000.075	7314150278718	10	490
B142.001.080	7314150278725	10	490
B142.001.150	7314150343188	10	490
B142.002.100	7314150278732	10	490
B142.002.175	7314150343195	10	490
B142.003.150	7314150278749	10	490
B143.020.100	7314150278510	5	196
B143.025.100	7314150278503	10	196
B143.030.100	7314150278527	10	196
B143.040.100	7314150278534	10	196
B143.050.100	7314150278541	10	196
B143.060.125	7314150278558	10	196
B143.080.150	7314150278565	5	196
B144.001.100	7314150278787	5	196
B144.002.125	7314150278794	5	196
B144.003.150	7314150278800	5	196
B145.006.100	7314150278756	5	196
B146.006.100	7314150278763	5	196
B147.001.400	7314150285594	1	361
B147.003.400	7314150285600	1	361
B148.001.080	7314150314522	10	490
B148.002.100	7314150314539	10	490
B149.001.080	7314150314546	10	490
B149.002.100	7314150314553	10	490
B150.010.100	7314150343126	10	490
B150.015.125	7314150343133	10	490
B150.020.125	7314150343140	10	490
B150.025.150	7314150343157	10	490
B190.040.075	7314150277810	10	193
B190.040.100	7314150277827	10	193
B190.055.100	7314150277834	10	193
B190.055.125	7314150277841	10	193
B190.065.125	7314150277858	10	193
B190.065.150	7314150277865	10	193
B190.080.150	7314150277872	10	193
B190.080.175	7314150277889	10	193
B190.100.200	7314150277896	10	193
B190.120.250	7314150277902	10	193





B190.140.250	7314150277919	10	193
B191.025.075	7314150277926	10	194
B191.030.075	7314150277933	10	194
B191.030.100	7314150277940	10	194
B191.030.200	7314150277957	10	194
B191.035.100	7314150277964	10	194
B191.040.100	7314150277971	10	194
B191.040.125	7314150277988	10	194
B191.040.250	7314150277995	10	194
B191.055.125	7314150278008	10	194
B191.055.150	7314150278015	10	194
B191.055.300	7314150278022	10	194
B191.065.150	7314150278039	10	194
B191.065.300	7314150278046	10	194
B192.000.075	7314150278084	10	194
B192.000.200	7314150278091	10	194
B192.001.100	7314150278107	10	194
B192.001.250	7314150278114	10	194
B192.002.125	7314150278121	10	194
B192.002.150	7314150442720	10	194
B192.002.300	7314150278138	10	194
B192.003.150	7314150278145	10	194
B192.004.200	7314150278169	10	194
B193.000.075	7314150278190	10	195
B193.001.100	7314150278206	10	195
B193.002.125	7314150278213	10	195
B193.003.150	7314150278220	10	195
B193.004.200	7314150278237	10	195
B194.004.075	7314150278268	10	195
B194.005.075	7314150278275	10	195
B194.006.075	7314150278282	10	195
B194.007.075	7314150278299	10	195
B194.008.075	7314150278305	10	195
B194.009.075	7314150278312	10	195
B194.010.075	7314150278329	10	195
B194.015.100	7314150278336	10	195
B194.020.100	7314150278343	10	195
B194.025.125	7314150278350	10	195
B194.027.125	7314150278367	10	195
B194.030.150	7314150278374	10	195
B194.040.150	7314150278381	10	195
B194.045.150	7314150278398	5	195
B195.001.025	7314150278176	10	194
B195.002.025	7314150278183	10	194
B195.006.050	7314150289493	5	196
B195.040.025	7314150278053	10	194
B195.050.025	7314150278060	10	194
B195.060.025	7314150278077	10	194
B195.901.025	7314150278244	10	195
B195.902.025	7314150278251	10	195
B196.025.075	7314150278589	10	489
B196.030.100	7314150278572	10	489
B196.035.100	7314150278596	10	489
B196.040.100	7314150278602	10	489
B196.055.125	7314150278619	10	489
B196.065.150	7314150278626	10	489
B196.080.175	7314150278633	10	489
B196.100.200	7314150278640	10	489
B196.120.200	7314150278657	10	489
B197.000.075	7314150278664	10	489
B197.001.080	7314150278671	10	489
B197.001.150	7314150343164	10	489
B197.002.100	7314150278688	10	489
B197.002.175	7314150343171	10	489
B197.003.150	7314150278695	10	489
B197.004.200	7314150278701	10	489
B198.040.125	7314150278817	5	196
B198.045.125	7314150278824	5	196
B198.050.150	7314150278831	5	196
B198.055.150	7314150281268	5	196
B198.060.150	7314150281763	5	196
B198.060.150F	7314150281770	5	196
B198.070.150	7314150281787	5	196
B198.070.150F	7314150281794	5	196
B198.080.150	7314150281800	5	196
B198.080.150F	7314150281817	5	196
B198.090.150	7314150281824	5	196
B198.100.150	7314150281831	5	196
B198.110.150	7314150281848	5	196
B198.120.150	7314150281855	5	197
B198.130.150	7314150281862	5	197
B198.140.150	7314150281879	5	197
B199.055.125	7314150281886	5	490
B199.060.125	7314150281893	5	490
B199.070.125	7314150281909	5	490
B199.080.125	7314150281916	5	490
B199.090.125	7314150281923	5	490
B199.100.125	7314150281930	5	490
B199.110.125	7314150281947	5	490
B199.120.125	7314150287741	5	490
B199.130.125	7314150287772	5	490
B219.002	7314150289301	1	197
B219.004	7314150283248	1	197
B219.005	7314150283255	1	197
B219.006	7314150283293	1	198
B219.007	7314150283323	1	198



B219.008	7314150283347	1	199
B219.010	7314150283354	1	200
B219.012	7314150327768	1	197
B219.015	7314150283262	1	197
B219.016	7314150283309	1	198
B219.017	7314150283330	1	199
B219.025	7314150283279	1	198
B219.026	7314150283316	1	198
B219.027	7314150399833	1	199
B219.035	7314150283286	1	198
B219.110	7314150392667	1	199
B219.210	7314150438969	1	199
B220.002	7314150289295	1	490
B220.005	7314150283361	1	490
B220.007	7314150283385	1	491
B220.012	7314150314614	1	490
B220.015	7314150283378	1	491
B220.017	7314150283392	1	491
B220.027	7314150283408	1	491
B400.002	8412814119441	1	602
B400.003	8412814119458	1	602
B400.004	8412814119465	1	602
B400.005	8412814119472	1	602
B400.006	8412814119489	1	602
B400.007	8412814119496	1	602
B400.008	8412814119502	1	602
B400.009	8412814119519	1	602
B400.010	8412814119526	1	602
B400.011	8412814119533	1	602
B400.012	8412814119540	1	602
B400.013	8412814119557	1	602
B400.014	8412814119564	1	602
B400.015	8412814119571	1	602
B400.016	8412814119588	1	602
B400.017	8412814119595	1	602
B400.018	8412814119601	1	602
B400.019	8412814119618	1	602
B400.020	8412814119625	1	602
B400.021	8412814119632	1	602
B400.022	8412814119649	1	602
B400.023	8412814119656	1	602
B400.024	8412814119663	1	602
B400.025	8412814119670	1	602
B400.026	8412814119687	1	602
B400.027	8412814119694	1	602
B400.028	8412814119700	1	602
B400.029	8412814119717	1	602
B400.030	8412814119724	1	602
B400.031	8412814119731	1	602
B400.032	8412814119748	1	602
B400.033	8412814119755	1	602
B400.034	8412814119762	1	602
B400.035	8412814119779	1	602
B400.036	8412814119786	1	602
B400.037	8412814119793	1	602
B400.038	8412814119809	1	602
B400.039	8412814119816	1	602
B400.040	8412814119823	1	602
B400.041	8412814119830	1	602
B400.042	8412814119847	1	602
B400.043	8412814119854	1	602
B400.044	8412814119861	1	602
B400.045	8412814119878	1	602
B400.046	8412814119885	1	602
B400.047	8412814119892	1	602
B400.048	8412814119908	1	602
B400.049	8412814119915	1	602
B400.050	8412814119922	1	602
B705.1/4.125	7314150281978	5	209
BAC007	7314150242337	1	297
BAHCO-1MW-1	7314150428045	1	420
BB10	7314150240586	1	329
BB1200A	7314150170173	1	328
BBA12-1200	7314150254330	1	327
BBA1224-1700	7314150254347	1	327
BBA1224-3200	7314150341955	1	328
BBACCC12V	7314150430772	1	332
BBBC2A	7314150181520	1	332
BBBC4A	7314150181537	1	332
BBBCAB-AUZ	7314150183944	1	332
BBBCAB-EU	7314150186648	1	332
BBBCAB-UK	7314150183937	1	332
BBC420	7314150243235	1	329
BBC620	7314150243242	1	329
BBCE12-10	7314150330263	1	329
BBCE12-15S	7314150406722	2	329
BBCE12-3	7314150330249	2	328
BBCE12-6	7314150330256	2	328
BBCE12-F100	7314150344710	1	329
BBCE24-10	7314150330287	2	329
BBCE612-2	7314150330195	2	328
BBCEC1	7314150335459	1	331
BBCEC2	7314150337460	1	332
BBCECER1	7314150335466	1	332
BBCECER2	7314150337484	1	332
BBH12-1200	7314150360734	1	327





BBJL1630	7314150244898	5	328
BBJL2535	7314150209453	1	328
BBJL3545	7314150209460	1	328
BBL12-40001	7314150335381	1	328
BBL12-40002	7314150335398	1	328
BBL12-40003	7314150335404	1	331
BBL12-40004	7314150335411	1	331
BBL12-40005	7314150335428	1	331
BBL12-40006	7314150335435	1	331
BBL12-40007	7314150335442	1	332
BBL800A	7314150255863	1	328
BBR100	7314150345922	1	315
BBR110	7314150170562	1	315
BBR150I	7314150439119	24	318
BBR201P6	7314150205752	8	317
BBR201P64014	7314150237852	1	317
BBR201P64016	7314150237753	1	317
BBR201P64018	7314150237760	1	317
BBR201P67814	7314150237777	1	317
BBR201P67816	7314150237784	1	317
BBR201P67818	7314150237791	1	317
BBR202P4	7314150205769	1	318
BBR202P410	7314150207688	1	318
BBR202P414	7314150207695	1	318
BBR202P419	7314150207701	1	318
BBR202P455	7314150231393	1	318
BBR203P9	7314150208081	1	317
BBR203P920	7314150231102	1	317
BBR203P925	7314150231119	1	317
BBR203P927	7314150231126	1	317
BBR203P930	7314150231133	1	317
BBR203P940	7314150231140	1	317
BBR203P945	7314150231157	1	317
BBR203P950	7314150231164	1	317
BBR203P955	7314150231171	1	317
BBR203P960	7314150231188	1	317
BBR204	7314150430635	6	318
BBR210P3	7314150206056	1	318
BBR300P50	7314150269624	1	317
BBR320	7314150169887	1	317
BBR350	7314150169900	1	315
BBR400	7314150345939	1	316
BBR405	7314150435807	20	317
BBR410	7314150345946	24	317
BBR420	7314150403394	50	316
BBR501011	7314150438143	50	315
BBR50121314	7314150438150	50	315
BBR6131	7314150239443	1	318
BBR6135	7314150239450	1	318
BBRAS14	7314150416943	4	315
BBRAS14-01	7314150418060	1	316
BBRAS14-02	7314150418077	1	316
BBRAS14-03	7314150418084	1	316
BBRAS14-04	7314150418091	1	316
BBRAS14-05	7314150418107	1	316
BBRAS14-06	7314150418114	1	316
BBRAS14-07	7314150418121	1	316
BBRAS14-08	7314150418138	1	316
BBRAS14-09	7314150418145	1	316
BBRAS14-10	7314150418152	1	316
BBRAS14-11	7314150418169	1	316
BBRAS14-12	7314150418176	1	316
BBRAS14-13	7314150418183	1	316
BBRAS14-14	7314150418190	1	316
BBRBB12	7314150371297	1	315
BBRFBM1	7314150384938	12	318
BBRPTG1	7314150412617	10	316
BBRS210P	7314150206070	1	318
BBRS210P2	7314150206063	1	318
BBS075	7314150249824	12	336
BBS100	7314150169870	1	339
BBS10001	7314150207183	1	339
BBS10002	7314150207190	1	339
BBS10003	7314150207206	1	339
BBS10004	7314150207213	1	339
BBS10005	7314150207220	1	339
BBS100057	7314150186655	1	339
BBS10006	7314150207237	1	339
BBS10007	7314150207244	1	339
BBS10008	7314150207251	1	339
BBS10009	7314150207268	1	339
BBS10010	7314150207275	1	339
BBS101	7314150243525	1	336
BBS102	7314150243518	1	336
BBS103	7314150243488	1	336
BBS10450	7314150243501	1	336
BBS105	7314150250868	1	336
BBS106	7314150243495	1	336
BBS107	7314150250875	1	336
BBS108	7314150250882	1	337
BBS12SH	7314150243563	1	337
BBS150	7314150169849	1	336
BBS150R	7314150244959	1	336
BBS150S	7314150244973	1	336
BBS150T	7314150244966	1	336
BBS165	7314150205615	10	337



BBS165SP4	7314150205622	50	337
BBS170P13	7314150205608	1	337
BBS170P131	7314150231843	1	337
BBS170P132	7314150231850	1	337
BBS170P133	7314150231867	1	337
BBS170P134	7314150231874	1	337
BBS170P135	7314150231881	1	337
BBS170P136	7314150231898	1	337
BBS170P137	7314150231904	1	337
BBS170P138	7314150231911	1	337
BBS170P139	7314150231928	1	337
BBS200	7314150239498	1	339
BBS20P12	7314150169856	1	339
BBS210	7314150215362	1	339
BBS210U06	7314150217656	1	339
BBS210U08	7314150217663	1	339
BBS210UA06	7314150217670	1	339
BBS210UA08	7314150217687	1	339
BBS210V06	7314150217632	1	339
BBS210V08	7314150217649	1	339
BBS210W06	7314150218738	1	339
BBS210W08	7314150218745	1	339
BBS3BH1	7314150356843	1	335
BBS3BH1-VP	7314150355501	40	335
BBS3UH	7314150242351	1	335
BBS50	7314150169863	1	334
BBS702026	7314150187416	15	332
BBS702028	7314150187423	1	332
BBSDA	7314150247127	1	338
BBSDC	7314150247158	6	338
BBSDD	7314150247165	1	338
BBSDH	7314150247141	1	338
BBSDHR	7314150249299	1	338
BBSDT	7314150247134	6	338
BBSDW	7314150247110	6	338
BBSH1F	7314150247189	1	337
BBSH1M	7314150247196	1	337
BBSH2C	7314150247202	1	337
BBSH2CA	7314150247219	12	337
BBSH2CP	7314150247226	6	337
BBSH2F	7314150247172	6	337
BBSH3CF	7314150247240	6	338
BBSH3CF30	7314150247264	6	338
BBSH3FS	7314150247257	6	338
BBSH3MF	7314150247233	1	338
BBSHWH1	7314150328932	1	338
BBSNL4FX001	7314150187492	1	332
BBS51	7314150247288	1	339
BBS52	7314150247271	8	339
BBS52L	7314150247295	1	339
BBT20	7314150166961	1	329
BBT60	7314150327799	12	329
BBT80	7314150327805	6	329
BCL31B1	7314150389704	1	283
BCL31C1	7314150389742	1	283
BCL31D1	7314150389582	1	281
BCL31D1K1	7314150400843	1	281
BCL31IS1	7314150389599	1	281
BCL31IS1K1	7314150400836	1	281
BCL31IW1	7314150389551	1	280
BCL31IW1K1	7314150400829	1	280
BCL31R1	7314150389568	1	280
BCL31R1K1	7314150400850	1	281
BCL31SD1	7314150389575	1	281
BCL31SD1K1	7314150402656	1	281
BCL32B1	7314150389711	1	283
BCL32DG1	7314150389605	1	282
BCL32DG1K1	7314150402670	1	282
BCL32G1	7314150389629	1	283
BCL32G1K1	7314150400911	1	282
BCL32IW1	7314150389643	1	280
BCL32IW1K1	7314150402663	1	280
BCL32RS1	7314150389636	1	282
BCL32RS1K1	7314150400904	1	282
BCL32SP1	7314150389612	1	282
BCL32SP1K1	7314150400898	1	282
BCL33AP1	7314150389650	1	282
BCL33AP1K1	7314150402687	1	282
BCL33B1	7314150389728	1	283
BCL33B3	7314150389735	1	283
BCL33C1	7314150389759	1	283
BCL33C2	7314150389766	1	283
BCL33D1	7314150389681	1	281
BCL33D1K1	7314150400881	1	281
BCL33IW1	7314150389667	1	280
BCL33IW1K1	7314150400867	1	280
BCL33IW2	7314150389674	1	280
BCL33IW2K1	7314150400874	1	280
BE-3529	7314151847845	1	533
BE-6400M-4	7314153011145	5	186
BE-6400M-5	7314153011169	5	186
BE-6400M-5.5	7314153011176	5	186
BE-6400M-7	7314153011190	5	186
BE-6902	7314150242641	5	184
BE-6903	7314150242665	5	184
BE-6925	7314150242658	5	184



BE-6990-IP10	7314151846763	1	128
BE-6990-IP10-KL	7314151847531	10	129
BE-6990-IP15	7314151846770	1	128
BE-6990-IP15-KL	7314151847548	10	129
BE-6990-IP6	7314151846725	1	128
BE-6990-IP6-KL	7314151847494	10	128
BE-6990-IP7	7314151846732	1	128
BE-6990-IP7-KL	7314151847500	10	128
BE-6990-IP8	7314151846749	1	128
BE-6990-IP8-KL	7314151847517	10	128
BE-6990-IP9	7314151846756	1	128
BE-6990-IP9-KL	7314151847524	10	129
BE-6990-IPSET	7314153019356	1	128
BE-6990TX-T10KL	7314151847760	10	128
BE-6990TX-T15KL	7314151847777	10	128
BE-6990TX-T6-KL	7314151847722	10	128
BE-6990TX-T7-KL	7314151847739	10	128
BE-6990TX-T8-KL	7314151847746	10	128
BE-6990TX-T9-KL	7314151847753	10	128
BE-7515	7314150242528	5	184
BE-7520	7314150242535	5	184
BE-7525	7314150242542	5	184
BE-7527	7314150242559	5	184
BE-7530	7314150242566	5	184
BE-7540	7314150242573	5	184
BE-7606	7314151839017	5	186
BE-7607	7314151839024	5	186
BE-7608	7314151839031	5	186
BE-7675	7314150123896	1	221
BE-7715	7314150242580	5	184
BE-7720	7314150242597	5	184
BE-7725	7314150242603	5	184
BE-7727	7314150242610	5	184
BE-7730	7314150242627	5	184
BE-7740	7314150242634	5	184
BE-7803	7314151838867	5	186
BE-7804	7314151838881	5	186
BE-7805	7314151838904	5	186
BE-7806	7314151838928	5	186
BE-7806S	7314150242986	5	487
BE-7807	7314151838935	5	186
BE-7807S	7314150242993	5	487
BE-7808	7314151838942	5	186
BE-7808S	7314150243006	5	487
BE-7809	7314151838959	5	186
BE-7809S	7314150243013	5	487
BE-7810	7314151838966	5	186
BE-7810S	7314150243020	5	487
BE-7811	7314151838973	5	186
BE-7812	7314151838980	5	186
BE-7813	7314151838997	5	186
BE-7814	7314151839000	5	186
BE-7835	7314151838874	5	186
BE-7845	7314151838898	5	186
BE-7855	7314151838911	5	186
BE-7855S	7314150242979	5	487
BE-7907	7314153010964	5	184
BE-7908	7314153010971	5	184
BE-7909	7314153010988	5	184
BE-7910	7314151838799	5	184
BE-7915	7314151838805	5	184
BE-7920	7314151838812	5	184
BE-7925	7314151838829	5	184
BE-7927	7314151838836	5	184
BE-7930	7314151838843	5	184
BE-7940	7314151838850	5	184
BE-8002	7314150242825	5	182
BE-8010	7314150010615	5	182
BE-8010S	7314150033058	5	486
BE-8020	7314150010639	5	182
BE-8020I	7314150270316	5	524
BE-8020L	7314151838591	5	182
BE-8022	7314150242474	5	182
BE-8030	7314150010653	5	182
BE-8030I	7314150270330	5	524
BE-8040	7314150010677	5	182
BE-8040I	7314150270347	5	524
BE-8040S	7314150033089	5	486
BE-8040SL	7314150304578	10	486
BE-8050S	7314150033096	5	486
BE-8050SL	7314150304592	10	486
BE-8065S	7314150033119	5	486
BE-8080-1	7314153010995	5	185
BE-8080-10	7314153011060	5	185
BE-8080-2	7314153011008	5	185
BE-8080-3	7314153011015	5	185
BE-8080-4	7314153011022	5	185
BE-8080-5	7314153011039	5	185
BE-8080-6	7314153011046	5	185
BE-8080-8	7314153011053	5	185
BE-8135TB	7314150275052	10	192
BE-8145TB	7314150275076	10	192
BE-8150	7314150010707	5	182
BE-8150TB	7314150275113	10	192
BE-8155	7314150010721	5	182
BE-8155TB	7314150275090	5	192



BE-8158	7314153010858	5	182
BE-8159	7314153010865	5	182
BE-8160	7314150010745	5	182
BE-8210	7314151838584	5	182
BE-8220	7314150047741	5	182
BE-8220S	7314150048243	5	486
BE-8220SL	7314150304530	10	486
BE-8225	7314150242443	5	182
BE-8230	7314150047758	5	182
BE-8230S	7314150048250	5	486
BE-8230SL	7314150304554	10	486
BE-8235	7314150242450	5	182
BE-8240	7314150047765	5	182
BE-8241	7314150242467	5	182
BE-8241I	7314150270866	5	524
BE-8242	7314153010803	5	182
BE-8250	7314150047772	5	182
BE-8250L	7314151838607	5	182
BE-8251	7314150242481	5	182
BE-8252	7314153010810	5	182
BE-8252I	7314150270361	5	524
BE-8255	7314150047789	5	182
BE-8255S	7314150048281	5	486
BE-8255SL	7314150304615	10	486
BE-8256	7314153010827	5	182
BE-8256TB	7314150275137	10	192
BE-8257	7314153010834	5	182
BE-8258	7314153010841	5	182
BE-8258S	7314150242818	5	486
BE-8258TB	7314150275151	10	192
BE-8259S	7314150242832	5	486
BE-8260	7314150047796	5	182
BE-8262TB	7314150275526	10	192
BE-8330	7314151838614	5	182
BE-8340	7314151838621	5	182
BE-8350	7314151838638	5	182
BE-8355	7314151838652	5	182
BE-8360	7314151838676	5	182
BE-8450	7314151838645	5	182
BE-8455	7314151838669	5	182
BE-8510S	7314150126507	5	486
BE-8510SL	7314150304813	10	487
BE-8520S	7314150126514	5	486
BE-8520SL	7314150304837	10	487
BE-8571	7314150244652	1	191
BE-8572	7314150244669	1	191
BE-8573	7314150244676	1	191
BE-8574	7314150258666	1	191
BE-8575	7314150244638	1	188
BE-8576	7314150245741	1	192
BE-8577	7314151839048	5	188
BE-8600	7314150010769	5	182
BE-8600I	7314150270378	5	524
BE-8600S	7314150033126	5	486
BE-8601	7314151838706	5	183
BE-8602	7314151838713	5	183
BE-8605	7314150242498	5	182
BE-8608	7314150242504	5	182
BE-8610	7314150010776	5	182
BE-8610I	7314150270392	5	524
BE-8610L	7314151838683	5	183
BE-8610S	7314150033133	5	486
BE-8610SL	7314150304639	10	487
BE-8610TB	7314150275199	10	192
BE-8611	7311518292317	5	182
BE-8611S	7314150414703	5	486
BE-8612S	7314150242856	5	486
BE-8620	7314150010783	5	183
BE-8620I	7314150270408	5	524
BE-8620L	7314151838690	5	183
BE-8620S	7314150033140	5	486
BE-8620SL	7314150304653	10	487
BE-8620TB	7314150275212	10	192
BE-8621	7311518292324	5	183
BE-8621S	7314150242863	5	486
BE-8622	7314150242511	5	183
BE-8622S	7314150242870	5	486
BE-8623	7314153010872	5	183
BE-8623I	7314150270415	5	524
BE-8623TB	7314150275236	10	192
BE-8624	7314153010889	5	183
BE-8624TB	7314150275250	10	192
BE-8628	7314153010896	5	183
BE-8629	7314153010902	5	183
BE-8630	7314150010790	5	183
BE-8630S	7314150033157	5	486
BE-8640	7314150010806	5	183
BE-8640S	7314150033164	5	486
BE-8675	7314150123872	1	220
BE-8700-1/4	7314150242689	5	185
BE-8700-3/16	7314150242696	5	185
BE-8700-3/8	7314150242702	5	185
BE-8700-5/16	7314150242719	5	185
BE-8700-5/32	7314150242726	5	185
BE-8700-7/32	7314150242733	5	185
BE-8700-7/64	7314150275878	5	185





BE-8702	7314151838768	5	184
BE-8703	7314150027651	5	184
BE-8703S	7314151839130	5	486
BE-8704	7314150027668	5	184
BE-8704S	7314151839147	5	486
BE-8705	7314150027675	5	184
BE-8705S	7314151839154	5	486
BE-8706	7314150027682	5	184
BE-8706S	7314151839161	5	486
BE-8708	7314150027699	5	185
BE-8708S	7314151839178	5	486
BE-8710	7314150027705	5	185
BE-8710S	7314150126521	5	486
BE-8710SL	7314150304851	10	487
BE-8715	7314150242672	5	184
BE-8720S	7314150126538	5	486
BE-8720SL	7314150304875	10	487
BE-8725	7314151838775	5	184
BE-8725S	7314151839123	5	486
BE-8800	7314150042012	5	183
BE-8800I	7314150270422	5	524
BE-8800S	7314151839055	5	486
BE-8801	7314151838744	5	183
BE-8802	7314151838751	5	183
BE-8810	7314150010813	5	183
BE-8810I	7314150270439	5	524
BE-8810L	7314151838720	5	183
BE-8810S	7314150048298	5	486
BE-8810SL	7314150304677	10	487
BE-8810TB	7314150275274	10	192
BE-8811	7311518292331	5	183
BE-8811S	7314150414710	5	486
BE-8812S	7314150242894	5	486
BE-8820	7314150010820	5	183
BE-8820I	7314150270446	5	524
BE-8820L	7314151838737	5	183
BE-8820S	7314150048304	5	486
BE-8820SL	7314150304691	10	487
BE-8820TB	7314150275298	10	192
BE-8821	7311518292348	5	183
BE-8821S	7314150242900	5	486
BE-8822S	7314150242917	5	486
BE-8823	7314153010919	5	183
BE-8823I	7314150270453	5	524
BE-8823TB	7314150275311	10	192
BE-8824	7314153010926	5	183
BE-8824TB	7314150275335	10	192
BE-8828	7314153010933	5	183
BE-8829	7314153010940	5	183
BE-8830	7314150010837	5	183
BE-8830S	7314150048311	5	486
BE-8840	7314150010844	5	183
BE-8840S	7314151839062	5	486
BE-8865	7314150010851	5	182
BE-8870	7314150010875	5	182
BE-8880	7314150010899	5	182
BE-8890	7314150010905	5	182
BE-8904	7314153010957	5	184
BE-8905	7314153010049	5	184
BE-8905S	7314150242924	5	486
BE-8906	7314150027729	5	184
BE-8906S	7314150242931	5	486
BE-8907	7314150027736	5	184
BE-8907S	7314150242948	5	486
BE-8908	7314150027743	5	184
BE-8908S	7314150242955	5	486
BE-8909	7314150027750	5	184
BE-8909S	7314150242962	5	486
BE-8910	7314150027767	5	184
BE-8910I	7314150270460	5	524
BE-8910S	7314151839079	5	486
BE-8910SL	7314150304714	5	487
BE-8910TB	7314150275359	5	192
BE-8915	7314150027774	5	184
BE-8915I	7314150270477	5	524
BE-8915S	7314151839086	5	486
BE-8915SL	7314150304738	5	487
BE-8915TB	7314150275373	5	192
BE-8920	7314150027781	5	184
BE-8920I	7314150270484	5	524
BE-8920S	7314151839093	5	486
BE-8920SL	7314150304752	5	487
BE-8920TB	7314150275397	5	192
BE-8925	7314150027798	5	184
BE-8925I	7314150270491	5	524
BE-8925S	7314151839109	5	486
BE-8925SL	7314150304776	5	487
BE-8925TB	7314150275410	5	192
BE-8927	7314150027804	5	184
BE-8927TB	7314150275434	5	192
BE-8930	7314150027811	5	184
BE-8930S	7314151839116	5	486
BE-8930SL	7314150304790	5	487
BE-8930TB	7314150275458	5	192
BE-8940	7314150027828	5	184
BE-8940TB	7314150275472	5	192



BE-8945	7314151838782	5	184
BE-8975	7314150056576	6	219
BE-8975B	7314150188741	6	219
BE-8976B	7314150216369	6	220
BE-8980	7314153010681	5	186
BE-8985	7314153010698	5	185
BE-8986	7314150267026	5	185
BE-9001	7311518269005	5	185
BE-9002	7311518269012	5	185
BE-9003	7311518269029	5	185
BE-9100	7314150242757	5	185
BE-9101	7314150242764	5	185
BE-9102	7314150242771	5	185
BE-9103	7314150242788	5	185
BE-9104	7314150242795	5	185
BE-9105	7314150242801	5	185
BE-9575	7314150123841	1	219
BE-9578	7314150123803	1	216
BE-9585	7314150123858	1	219
BE-9586	7314150216000	1	217
BE-9588	7314150123810	1	217
BE-9675	7314150123889	1	220
BE-9676	7314150216017	1	218
BE-9678	7314150123827	1	218
BE-9688	7314150123834	1	218
BE-9765	7314150055128	3	217
BE-9770	7314150027712	3	218
BE-9770I	7314150276332	20	525
BE-9775	7314150056330	3	218
BE-9776	7314150056545	6	216
BE-9776B	7314150216352	6	218
BE-9777	7314150056552	6	217
BE-9777B	7314150188734	6	216
BE-9778	7314150123780	1	214
BE-9780	7314150033386	3	218
BE-9785	7314150056347	3	218
BE-9785I	7314150276349	1	524
BE-9786I	7314150314485	1	525
BE-9787	7314150056569	6	217
BE-9871	7314150234707	1	187
BE-9871SL	7314150470792	1	488
BE-9872SL	7314150470785	1	488
BE-9875	7314150314447	1	188
BE-9876S	7314150315000	1	487
BE-9877	7314150320745	1	188
BE-9878	7314150186259	1	215
BE-9878SL	7314150321018	1	488
BE-9879	7314150383474	1	188
BE-9880	7314150238569	3	218
BE-9880SL	7314150337651	1	488
BE-9881	7314150043279	1	186
BE-9881I	7314150270507	1	524
BE-9881S	7314151839307	1	488
BE-9881SL	7314150304899	1	488
BE-9881TB	7314150275502	1	193
BE-9882	7314151839284	1	187
BE-9882I	7314150270514	1	524
BE-9882S	7314151839314	1	488
BE-9882SL	7314150304912	1	488
BE-9882TB	7314150275496	1	193
BE-9884	7314150243068	1	187
BE-9884S	7314150236602	1	489
BE-9885	7314150048465	1	186
BE-9885S	7314150126491	1	489
BE-9885TB	7314150275519	1	193
BE-9886	7314150048472	1	187
BE-9887S	7314150244744	1	489
BE-9888S	7314153006158	1	489
BE-9889S	7314150244751	1	489
BE-9890S	7314150237715	1	489
BE-9890SL	7314150315086	1	487
BE-9891SL	7314150321506	1	487
BE-9894SL	7314150321490	1	488
BE100	7314150177912	1	289
BE1100	7314150205929	8	303
BE110001	7314150230228	1	303
BE110014	7314150230204	1	304
BE110015	7314150230211	1	304
BE1100AC1	7314150230266	1	304
BE1100AC2	7314150333394	1	304
BE1200P6	7314150205516	1	290
BE1200P6AC1	7314150205523	1	290
BE1205	7314150205554	1	298
BE1210P11	7314150209101	1	289
BE1210P1101	7314150269822	1	289
BE1210P1102	7314150269839	1	289
BE1210P1103	7314150269846	1	289
BE1210P9AC1	7314150205547	1	289
BE1300	7314150205578	1	299
BE1300SH	7314150205585	10	299
BE1305P450	7314150206032	1	299
BE1305P450WS01	7314150269228	1	300
BE1305P450WS02	7314150269235	1	300
BE1305P450WS03	7314150269242	1	300
BE1305P450WS04	7314150269327	1	300
BE1305P450WS05	7314150269334	1	300



BE1305P450WS06	7314150269341	1	300
BE1305P450WS07	7314150269358	1	300
BE1305P450WS08	7314150269365	1	300
BE1305P450WS09	7314150269372	1	300
BE1305P450WS10	7314150269310	1	300
BE1305P450WS11	7314150269389	1	300
BE1305P450WS12	7314150269396	1	300
BE1305P450WS13	7314150269402	1	300
BE1305P450WS14	7314150269419	1	300
BE1305P450WS15	7314150269426	1	300
BE1310DNS	7314150403240	12	299
BE1310P4	7314150205707	1	298
BE1310P425	7314150233649	1	298
BE1310P427	7314150233656	1	298
BE1310P429	7314150233663	1	298
BE1310P430	7314150233670	1	298
BE1311P13	7314150235414	1	297
BE1312DNS	7314150450596	12	299
BE1315P7	7314150205776	1	298
BE1315P71	7314150230273	1	298
BE1315P72	7314150230280	1	298
BE1315P73	7314150230297	1	298
BE1315P74	7314150230303	1	298
BE1315P75	7314150230310	1	298
BE1315P76	7314150230327	1	298
BE1315P77	7314150230334	1	298
BE1320S17	7314150415366	10	298
BE13ZL11	7314150239733	1	300
BE1FFWF	7314150403325	12	293
BE1FLD1	7314150250745	1	292
BE1FLD2	7314150250752	1	292
BE1FLD3	7314150250769	1	292
BE1FLDS	7314150250783	1	292
BE1FTW	7314150251209	1	292
BE1GP5	7314150170043	1	298
BE1GP5-T	7314150170050	10	298
BE1GP510	7314150207732	1	288
BE1GP512	7314150207749	1	288
BE1GP514	7314150207756	1	288
BE1GP58	7314150207718	1	288
BE1GP59	7314150207725	1	288
BE1P	7314150170067	1	301
BE1SP14L	7314150170074	1	302
BE1SP1F	7314150435777	12	301
BE1T14	7314150167630	1	302
BE1T16	7314150167647	1	302
BE1T21	7314150167654	1	302
BE1TH-10	7314150343980	5	309
BE1TH-12	7314150343997	5	309
BE1TH-14	7314150344000	5	309
BE1TH-2	7314150343874	10	309
BE1TH-2.5	7314150343881	10	309
BE1TH-3	7314150343898	10	309
BE1TH-3.5	7314150343904	10	309
BE1TH-4	7314150343911	10	309
BE1TH-4.5	7314150343928	10	309
BE1TH-5	7314150343935	10	309
BE1TH-6	7314150343942	10	309
BE1TH-7	7314150343959	10	309
BE1TH-8	7314150343966	10	309
BE1TH-9	7314150343973	10	309
BE1TH-S5	7314150457502	1	308
BE1TH-S6	7314150344017	30	309
BE1TS-10	7314150344062	10	310
BE1TS-11	7314150344079	10	310
BE1TS-12	7314150344086	10	310
BE1TS-13	7314150344093	10	310
BE1TS-14	7314150344109	10	310
BE1TS-15	7314150344116	10	310
BE1TS-16	7314150344123	10	310
BE1TS-17	7314150344130	10	310
BE1TS-18	7314150344147	10	310
BE1TS-19	7314150344154	10	310
BE1TS-20	7314150344161	8	310
BE1TS-21	7314150344178	8	310
BE1TS-22	7314150344185	8	310
BE1TS-24	7314150344192	8	310
BE1TS-6	7314150344024	10	310
BE1TS-7	7314150344031	10	310
BE1TS-8	7314150344048	10	310
BE1TS-9	7314150344055	10	310
BE1TS-S7	7314150344208	1	310
BE200	7314150165148	1	350
BE200CAB250SH10	7314150165452	1	350
BE200CAB250SH25	7314150165469	1	350
BE200CAB250SH3	7314150165445	1	350
BE200CAB40F1	7314150165391	1	350
BE200CAB55F1	7314150165407	1	350
BE200CAB55F3	7314150165414	1	350
BE200CAB58SR1	7314150165421	1	350
BE200CAB58SR3	7314150165438	1	350
BE200CAB80SR1	7314150165384	1	350
BE200CAB80SR3	7314150165476	1	350
BE200MAG4	7314150245192	1	350
BE200MAG5	7314150165513	1	350
BE200MAG80	7314150165551	1	350



BE200MIR4035	7314150245161	1	350
BE200MIR4045	7314150245178	1	350
BE200MIR4055	7314150245185	1	350
BE200MIR5535	7314150165483	1	350
BE200MIR5545	7314150165490	1	350
BE200MIR5555	7314150165506	1	350
BE200MIR8035	7314150165520	1	350
BE200MIR8045	7314150165537	1	350
BE200MIR8055	7314150165544	1	350
BE210	7314150165155	1	350
BE220	7314150170005	1	350
BE230	7314150182633	1	296
BE239	7314150243143	1	295
BE240	7314150239917	1	295
BE240-CAT	7314150289417	1	296
BE250	7314150169924	1	300
BE251	7314150239429	1	300
BE251200	7314150249343	1	324
BE2512005	7314150249350	1	324
BE2512008	7314150249367	1	324
BE253	7314150250806	1	299
BE2541	7314150251797	1	290
BE2542	7314150251803	1	299
BE254A	7314150446070	1	307
BE254A-01	7314150453405	1	307
BE256-155	7314150205875	1	299
BE256-178	7314150205882	1	299
BE256-250	7314150205899	1	299
BE256M	7314150205851	1	286
BE256P3	7314150205868	1	299
BE257	7314150205844	8	297
BE25710	7314150230549	1	297
BE25718	7314150230532	1	297
BE2572	7314150230556	1	297
BE2576	7314150230525	1	297
BE258	7314150251780	1	296
BE301	7314150430871	2	325
BE301CM	7314150430888	50	326
BE301CM-01	7314150430956	20	326
BE301CM-02	7314150430963	20	326
BE310	7314150205943	8	326
BE400P24	7314150205806	1	304
BE400P2401	7314150230600	1	286
BE400P2402	7314150230617	1	286
BE400P2403	7314150230624	1	287
BE400P2404	7314150230631	1	301
BE400P2405	7314150230648	1	287
BE400P2406	7314150230655	1	287
BE400P2407	7314150230662	1	287
BE400P2408	7314150230679	1	302
BE400P2409	7314150230686	1	287
BE400P241	7314150230563	1	297
BE400P2410	7314150230693	1	287
BE400P2411	7314150230709	1	302
BE400P2412	7314150230716	1	302
BE400P2413	7314150230723	1	303
BE400P2414	7314150230730	1	303
BE400P2415	7314150230747	1	303
BE400P2416	7314150230754	1	303
BE400P2417	7314150230761	1	303
BE400P2418	7314150230778	1	304
BE400P2419	7314150230785	1	304
BE400P242	7314150230570	1	306
BE400P2420	7314150237647	1	298
BE400P243	7314150230587	1	286
BE400P244	7314150230594	1	301
BE401	7314150240593	1	296
BE410	7314150205813	4	289
BE4101	7314150230792	1	289
BE5008	7314150239344	1	300
BE5008-10	7314150239269	1	300
BE5008-15	7314150239276	1	300
BE5008-20	7314150239283	1	300
BE5008-25	7314150239290	1	300
BE5008-27	7314150239306	1	300
BE5008-30	7314150239313	1	300
BE5008-40	7314150239320	1	300
BE5008-45	7314150239337	1	300
BE500P24	7314150169955	1	296
BE500P2401	7314150209569	1	296
BE500P2402	7314150209682	1	296
BE500P2403	7314150209736	1	296
BE500P2404	7314150209729	1	296
BE500P2405	7314150209613	1	296
BE500P2406	7314150209804	1	296
BE500P2407	7314150209781	1	296
BE500P2408	7314150209743	1	296
BE500P2409	7314150209750	1	296
BE500P2410	7314150209637	1	296
BE500P2411	7314150209644	1	296
BE500P2412	7314150209699	1	296
BE500P2413	7314150209705	1	296
BE500P2414	7314150209798	1	296
BE500P2415	7314150209675	1	296
BE500P2416	7314150209620	1	296
BE500P2417	7314150209583	1	296



**BE500P2418**

BE500P2418	7314150209576	1	296
BE500P2419	7314150209767	1	296
BE500P2420	7314150209590	1	296
BE500P2421	7314150209606	1	296
BE500P2422	7314150209774	1	296
BE500P2423	7314150209668	1	296
BE500P2424	7314150209712	1	296
BE501101	7314150274499	1	286
BE501102	7314150274505	1	286
BE501203	7314150274529	1	286
BE501204	7314150274536	1	287
BE502101	7314150274543	1	287
BE502102	7314150274550	1	288
BE502103	7314150274567	1	288
BE502104	7314150384952	8	286
BE502106	7314150403370	10	287
BE502204	7314150274574	1	288
BE5032	7314150189885	1	304
BE503201	7314150274581	1	288
BE5032H10EL	7314150220953	1	306
BE5032H14	7314150220960	1	305
BE5032M14	7314150220977	1	305
BE5032SQ10	7314150220991	1	304
BE5032SQ8	7314150220984	1	304
BE5032T55EL	7314150220946	1	306
BE504102	7314150274666	1	288
BE504201	7314150274369	1	289
BE5049	7314150169931	5	304
BE504901	7314150184576	1	305
BE504902	7314150184583	1	306
BE5049H10	7314150184705	1	305
BE5049H10L	7314150184712	1	306
BE5049H12	7314150184729	1	305
BE5049H12L	7314150184736	1	306
BE5049H4	7314150184590	1	305
BE5049H4L	7314150184606	1	306
BE5049H5	7314150184613	1	305
BE5049H5L	7314150184620	1	306
BE5049H6	7314150184637	1	305
BE5049H6L	7314150184651	1	306
BE5049H7	7314150184668	1	305
BE5049H7L	7314150184675	1	306
BE5049H8	7314150184682	1	305
BE5049H8L	7314150184699	1	306
BE5049M10	7314150184804	1	305
BE5049M10L	7314150184811	1	306
BE5049M12	7314150184828	1	305
BE5049M12L	7314150184835	1	306
BE5049M5	7314150184743	1	305
BE5049M5L	7314150184750	1	306
BE5049M6	7314150184767	1	305
BE5049M6L	7314150184774	1	306
BE5049M8	7314150184781	1	305
BE5049M8L	7314150184798	1	306
BE5049T	7314150325474	1	306
BE5049T20	7314150216048	1	305
BE5049T20H	7314150184842	1	305
BE5049T20HL	7314150184859	1	306
BE5049T20L	7314150221011	1	306
BE5049T25	7314150216055	1	305
BE5049T25H	7314150184866	1	305
BE5049T25HL	7314150184873	1	306
BE5049T25L	7314150221028	1	306
BE5049T27	7314150216062	1	305
BE5049T27H	7314150184880	1	305
BE5049T27HL	7314150184897	1	306
BE5049T27L	7314150221035	1	306
BE5049T30	7314150216079	1	305
BE5049T30H	7314150184903	1	305
BE5049T30HL	7314150184910	1	306
BE5049T30HXL	7314150184927	1	306
BE5049T30L	7314150221042	1	306
BE5049T40	7314150216086	1	305
BE5049T40H	7314150184934	1	305
BE5049T40HL	7314150184941	1	306
BE5049T40HXL	7314150185092	1	306
BE5049T40L	7314150221059	1	306
BE5049T45	7314150216093	1	305
BE5049T45H	7314150184958	1	305
BE5049T45HL	7314150184965	1	306
BE5049T45HXL	7314150184972	1	306
BE5049T45L	7314150216123	1	306
BE5049T50	7314150216109	1	305
BE5049T50H	7314150184989	1	305
BE5049T50HL	7314150184996	1	306
BE5049T50L	7314150221066	1	306
BE5049T55	7314150216116	1	305
BE5049T55H	7314150185009	1	305
BE5049T55HL	7314150185016	1	306
BE5049T55L	7314150221073	1	306
BE5049T60	7314150221004	1	305
BE5049T60H	7314150185023	1	305
BE5049T60HL	7314150185030	1	306
BE5049T70HL	7314150185047	1	306
BE5049T80HL	7314150186532	1	306
BE505101	7314150274598	1	289



BE505102	7314150274604	1	289
BE505203	7314150274611	1	290
BE505204	7314150274628	1	290
BE506101	7314150274376	1	290
BE506102	7314150274635	1	290
BE506103	7314150274642	1	291
BE506204	7314150274659	1	291
BE507101	7314150274673	1	291
BE507102	7314150274680	1	291
BE507203	7314150274697	1	291
BE508101	7314150274765	1	292
BE508202	7314150274772	1	292
BE508203	7314150274703	1	292
BE508204	7314150274710	1	293
BE509101	7314150274727	1	293
BE509102	7314150274734	1	293
BE509103	7314150274383	1	293
BE509104	7314150274741	1	293
BE509205	7314150274390	1	293
BE509206	7314150274406	1	294
BE509207	7314150274758	1	294
BE5100	7314150205646	1	295
BE5101	7314150205721	1	305
BE510101	7314150274420	1	294
BE510102	7314150274437	1	294
BE510125	7314150230877	1	307
BE510127	7314150230884	1	307
BE510130	7314150230891	1	307
BE510140	7314150230907	1	307
BE510145	7314150230914	1	307
BE510150	7314150230921	1	307
BE510155	7314150230938	1	307
BE510160	7314150230945	1	307
BE5102	7314150205738	1	301
BE510203	7314150274789	1	294
BE510210	7314150231003	1	301
BE510211	7314150231010	1	301
BE510212	7314150231027	1	301
BE510213	7314150231034	1	301
BE51025	7314150230952	1	301
BE51026	7314150230969	1	301
BE51027	7314150230976	1	301
BE51028	7314150230983	1	301
BE51029	7314150230990	1	301
BE5103	7314150205745	1	302
BE510304	7314150274444	1	294
BE510310	7314150231072	1	302
BE510312	7314150231089	1	302
BE510314	7314150231096	1	302
BE51035	7314150231041	1	302
BE51036	7314150231058	1	302
BE51038	7314150231065	1	302
BE51101	7314150274451	1	294
BE51102	7314150274468	1	295
BE511203	7314150274796	1	295
BE512201	7314150274475	1	297
BE513201	7314150274802	1	295
BE5150P27	7314150205790	1	307
BE5150P271	7314150230808	1	307
BE5150P272	7314150230815	1	307
BE5150P273	7314150230822	1	307
BE5200	7314150205905	1	305
BE52001	7314150230433	1	305
BE52002	7314150230440	1	305
BE52003	7314150230457	1	305
BE523106	7314150178391	1	295
BE530001	7314150205912	1	305
BE5350	7314150206049	5	300
BE5350C1	7314150230389	1	300
BE5350C2	7314150230396	1	300
BE5350C3	7314150230402	1	300
BE5350C4	7314150230419	1	300
BE5350C5	7314150230426	1	300
BE5400P	7314150245086	1	307
BE5401D	7314150245062	1	301
BE5500	7314150403233	25	297
BE61110	7314150167449	1	309
BE61110-1	7314150167463	100	309
BE61155	7314150167456	1	309
BE61155-1	7314150167470	1	309
BE62110	7314150403332	10	309
BE62155	7314150403349	10	309
BE6217	7314150169702	1	311
BE621701	7314150232642	1	312
BE621702	7314150232659	1	312
BE621703	7314150232666	1	312
BE621704	7314150232673	1	312
BE621705	7314150232680	1	312
BE621706	7314150232697	1	312
BE621707	7314150232703	1	312
BE621708	7314150232710	1	312
BE621709	7314150232727	1	312
BE621710	7314150232734	1	312
BE621711	7314150232741	1	312
BE621712	7314150232758	1	312
BE621713	7314150232765	1	312

BE621714	7314150232772	1	312
BE621715	7314150232789	1	312
BE621716	7314150232796	1	312
BE621717	7314150232802	1	312
BE630	7314150169580	3	310
BE63010015F	7314150232598	25	311
BE63010615F	7314150232604	1	311
BE63010815F	7314150232611	1	311
BE63010818F	7314150232628	1	311
BE630246F	7314150169597	50	311
BE6302712F	7314150412846	5	311
BE630276F	7314150169603	50	311
BE630326F	7314150169610	50	311
BE630366F	7314150169627	100	311
BE630386F	7314150169634	50	311
BE63064514F1	7314150340095	1	311
BE63064514F2	7314150340101	1	311
BE6306514F	7314150232123	12	310
BE630656714F	7314150232130	12	310
BE63066514F	7314150169641	25	311
BE630666F	7314150232116	1	310
BE6306814F	7314150232154	1	310
BE6307314F	7314150232161	1	310
BE6307414F	7314150370108	10	311
BE6307415F	7314150232178	1	310
BE630747615F	7314150232307	12	310
BE630757715F	7314150232321	1	310
BE6307612F	7314150232345	12	310
BE6307614F	7314150232369	12	310
BE6307630F	7314150232437	1	310
BE630768F	7314150232468	1	310
BE6307815F	7314150232475	1	310
BE6308015F	7314150232482	1	310
BE630808215F	7314150232499	1	311
BE6308616F	7314150232505	1	311
BE6308618F	7314150232512	1	311
BE6309015F	7314150232529	1	311
BE6309210F	7314150232536	1	311
BE6309315F	7314150232543	1	311
BE6309336F	7314150232550	1	311
BE6309345F	7314150232567	1	311
BE6309515F	7314150232574	1	311
BE6309618F	7314150232581	1	311
BE64350	7314150169672	1	309
BE64350CH	7314150169696	1	309
BE64520	7314150169665	1	309
BE64520CH	7314150169689	1	309
BE65F65120	7314150169658	12	310
BE65R106160	7314150170036	1	310
BE65R65120	7314150170012	1	310
BE65R80120	7314150170029	1	310
BE66152	7314150247639	6	310
BE66152I	7314150247646	8	310
BE6701VAG	7314150333875	1	311
BE68	7314150237876	1	311
BE6810	7314150237869	1	311
BE6810Z	7314150430765	12	311
BE6FCP	7314150438907	30	308
BE6OF108	7314150434572	50	309
BE6OFW	7314150435784	5	309
BE700	7314150206087	1	307
BE700BP2	7314150206100	1	307
BE700SP15	7314150206094	1	307
BE74-55100	7314150169733	1	305
BE74-57125	7314150169511	1	307
BE74-57125L	7314150169535	1	307
BE74-80120	7314150169740	1	305
BE74-90175	7314150169528	1	307
BE76101	7314150240005	1	307
BE76105	7314150239412	1	306
BE762	7314150384983	12	299
BE800P12	7314150205677	1	297
BELMS12	7314150239214	25	331
BELMS12OBDL	7314150340323	8	327
BELP1224	7314150177882	1	331
BELS12	7314150170579	1	331
BELT10	7314150170623	1	308
BELT1213	7314150170616	1	330
BELT127	7314150177899	1	330
BELT2415	7314150170609	1	330
BELT247N	7314150170586	1	330
BELT247S	7314150170593	1	330
BELTKEY	7314150177875	1	330
BELTRP16	7314150169917	1	330
BELTRP1601	7314150231935	1	330
BELTRP1602	7314150231942	1	331
BELTRP1603	7314150231959	1	331
BELTRP1604	7314150231966	1	331
BELTRP1605	7314150231973	1	331
BELTRP1606	7314150231980	1	331
BELTRP1607	7314150231997	1	331
BELTRP1608	7314150232000	1	331
BELTRP1609	7314150232017	1	331
BELTRP1610	7314150232024	1	331
BELTRP1611	7314150232031	1	331
BELTRP1612	7314150232048	1	331

BELTRP1613	7314150232062	1	331
BELTRP1614	7314150232079	1	331
BELTRP1615	7314150232086	1	331
BELTRP1616	7314150232093	1	331
BFRL11	7314150306534	1	348
BGIS125	7314150416431	20	330
BH110000A	7314150272709	1	343
BH110000A-02	7314150273669	1	342
BH110000A-04	7314150273683	1	341
BH110000A-EXT	7314150291946	1	343
BH11500	7314150178797	1	342
BH11500-01	7314150182220	1	346
BH11500-02	7314150182237	1	342
BH12000	7314150178803	1	342
BH13000	7314150178810	1	342
BH13000-02	7314150182244	1	342
BH13000L	7314150301980	1	342
BH13000L-01	7314150301997	1	346
BH13000QA	7314150403295	1	342
BH15000A	7314150272693	1	342
BH15000A-01	7314150273515	1	346
BH15000A-02	7314150273522	1	342
BH15000A-04	7314150273546	1	341
BH15000A-EXT	7314150291939	1	343
BH1A1500	7314150257706	1	341
BH1A1500-01	7314150265268	1	341
BH1A1500-04	7314150265299	1	346
BH1A1500A	7314150460946	1	341
BH1A2500	7314150170555	1	341
BH1A2500-01	7314150226832	1	341
BH1A2500-03	7314150226856	1	342
BH1A2500-04	7314150226863	1	346
BH1A2500A	7314150460953	1	341
BH1CB1000	7314150243204	1	342
BH1CD680	7314150330379	1	345
BH1CD680ST	7314150330386	1	346
BH1EU3000	7314150245000	1	341
BH1EU3000-01	7314150250004	1	342
BH1EU3000-03	7314150249893	1	341
BH1EU3000-08	7314150249947	1	346
BH1M1000	7314150237845	1	342
BH1S45	7314150292295	1	343
BH1S45-01	7314150311194	1	346
BH1S45-03	7314150311217	1	342
BH230	7314150264070	1	343
BH23015	7314150178759	1	344
BH23015C	7314150178742	1	344
BH2402010	7314150178766	1	344
BH2604020	7314150178773	1	344
BH2AC1	7314150213474	1	344
BH2AC2	7314150213481	1	344
BH2AC60-140	7314150168958	1	344
BH2AC60V110	7314150178933	1	344
BH33000	7314150178674	1	344
BH36000	7314150178681	1	344
BH3A10000	7314150234660	1	344
BH3A3000	7314150234646	1	344
BH3A5000	7314150234653	1	344
BH3AL2500	7314150302420	1	344
BH3HD12000	7314150170500	1	345
BH3HD16000	7314150170524	1	345
BH3HD20000A	7314150337668	1	345
BH3HD8000	7314150170494	2	345
BH3SQ15000	7314150234684	2	345
BH3SQ7000	7314150234677	2	345
BH410	7314150178711	1	341
BH415	7314150178728	2	341
BH42	7314150178698	1	341
BH420	7314150178735	1	341
BH430	7314150178780	2	341
BH45	7314150178704	1	341
BH4S12	7314150237920	3	341
BH4S2	7314150237883	6	341
BH4S20	7314150237937	1	341
BH4S4	7314150237890	6	341
BH4S6	7314150237906	4	341
BH4S8	7314150237913	4	341
BH5DP1000QA	7314150270224	1	345
BH5SP500QA	7314150270217	1	345
BH5US1000	7314150243174	1	345
BH6AC1-680A	7314150433544	1	346
BH6FC1000	7314150178650	1	346
BH6FC2000	7314150234639	1	346
BH6PC600	7314150234622	1	346
BH7100A	7314150345908	1	333
BH7100SG	7314150299782	1	333
BH715	7314150237555	1	333
BH715-13	7314150239191	1	333
BH720	7314150235650	1	333
BH720-22	7314150236961	1	333
BH720SG	7314150238477	1	333
BH730	7314150235667	1	333
BH730SG	7314150238484	1	333
BH750	7314150235674	1	333
BH750SG	7314150238491	1	333
BH8AC1-500	7314150170463	1	341



# BH8AC2-500



BH8AC2-500	7314150412532	1	308
BH8AC3-1500	7314150292264	1	346
BH8AC3-600	7314150351893	1	346
BH8BC1	7314150242276	1	340
BH8BC2	7314150242283	1	340
BH8BC3	7314150242290	10	340
BH8BC4	7314150242306	6	340
BH8BC5	7314150242313	6	340
BH8PR10000	7314150178957	1	340
BH8PR4000	7314150178940	1	340
BH9BJ22SLH	7314150246946	1	343
BH9BJ22SSH	7314150247462	1	343
BH9BJ23SLH	7314150246953	1	343
BH9BJ23SSH	7314150246960	1	343
BH9BJ260	7314150247509	1	343
BH9BJ280	7314150247516	1	343
BHVG15-250	7314150403745	12	346
BHVIS06100	7314150167753	1	322
BHVIS06105	7314150167760	1	322
BHVIS0670	7314150167692	1	322
BHVIS0677	7314150167708	1	322
BHVIS0680	7314150167715	1	322
BHVIS0685	7314150167722	1	322
BHVIS0690	7314150167739	1	322
BHVIS0695	7314150167746	1	322
BHVIS08100	7314150165711	1	322
BHVIS08115	7314150165728	1	322
BHVIS0895	7314150165704	1	322
BHVIS109BPW12	7314150165759	1	322
BHVIS111BPW12	7314150165735	1	323
BHVIS120BPW16	7314150165742	1	322
BHVIS1265	7314150167685	1	322
BHVIS80BPW12	7314150165766	1	323
BHVIS95BPW9	7314150243334	1	323
BKE850901N	7314150449705	10	221
BL1FM	7314150242344	1	351
BLBT100	7314150179015	1	335
BLBT100AC1	7314150179022	1	335
BLCR230FR	7314150247356	1	348
BLCR230SC	7314150247349	1	348
BLCR24VCL	7314150247370	1	348
BLCR24VLL	7314150247387	1	348
BLCR400E	7314150247363	1	348
BLCRSC1	7314150247530	1	348
BLCRSC2	7314150247547	1	348
BLE300	7314150227648	1	334
BLE301	7314150227662	1	334
BLE302	7314150227679	1	334
BLE304	7314150249572	1	334
BLE305	7314150339341	1	334
BL5128	7314150246847	20	348
BLT550	7314150243556	10	296
BLTFC1	7314150246434	20	348
BLTI3P	7314150247608	18	348
BLTS10	7314150246427	20	348
BLTS7P	7314150246410	58	348
BLUVF	7314150247622	1	297
BMD150	7314150242238	1	334
BMMTRMS1	7314150274024	1	330
BMR240	7314150242245	1	334
BOD101	7314150205967	1	312
BOD1016	7314150169979	1	314
BOD101NWS	7314150269099	1	312
BOD101T	7314150269150	1	314
BOD102	7314150205974	1	312
BOD102NWS	7314150269105	1	312
BOD102T	7314150269167	1	314
BOD103	7314150205981	1	312
BOD103NWS	7314150269112	1	312
BOD103T	7314150269174	1	314
BOD104	7314150205998	1	312
BOD104NWS	7314150269129	1	312
BOD104T	7314150269181	1	314
BOD105	7314150206001	1	312
BOD105NWS	7314150269136	1	312
BOD105T	7314150269198	1	314
BOD106	7314150206018	1	312
BOD106NWS	7314150269143	1	312
BOD106T	7314150269204	1	314
BOD10P64	7314150205950	1	312
BOD2008	7314150169986	1	314
BOD2FS	7314150351879	20	314
BOD301200	7314150169993	1	314
BOD4200	7314150169436	1	310
BOD4500	7314150169443	1	310
BOD54-1	7314150239467	1	315
BOD54-2	7314150239474	1	315
BOD54-3	7314150239481	1	315
BOD5400	7314150169450	1	315
BOD5450	7314150169474	1	315
BOD5HD400	7314150169467	1	314
BOD60	7314150169481	1	314
BOD6080P12	7314150235407	1	313
BOD6080P12-01	7314150235438	1	313
BOD6080P12-02	7314150235445	1	313
BOD6080P12-03	7314150235452	1	313



BOD6080P12-04	7314150235469	1	313
BOD6080P12-05	7314150235476	1	313
BOD6080P12-06	7314150235490	1	313
BOD6080P12-07	7314150235506	1	313
BOD6080P12-08	7314150235513	1	313
BOD6080P12-09	7314150235520	1	313
BOD6080P12-10	7314150235537	1	314
BOD6080P12-11	7314150235544	1	314
BOD70	7314150169498	1	314
BOD8901	7314150169016	1	312
BOD8901AC1	7314150178490	1	313
BOD8902	7314150169023	1	312
BOD8903A	7314150265374	1	312
BP-40	7314150453085	1	569
BP110	7314150135011	1	270
BP111E	7314150235872	12	270
BP115	7314150134991	1	269
BP117	7314150184309	1	269
BP117EH	7314150184316	1	270
BP118	7314150235834	1	269
BP125A	7314150427291	6	275
BP127	7314150137565	1	270
BP127P	7314150427277	1	271
BP204	7314150184286	1	272
BP20410320	7314150185948	1	272
BP20410800	7314150185955	1	272
BP20425180	7314150185924	1	272
BP20425220	7314150185931	1	272
BP204K	7314150184293	1	271
BP204PAD	7314150185917	1	272
BP212	7314150134601	1	272
BP215A	7314150341849	10	276
BP218	7314150170272	1	276
BP219	7314150235889	1	276
BP219L	7314150235896	1	276
BP219V	7314150307197	1	276
BP219XL	7314150427192	10	276
BP222	7314150137572	1	272
BP233	7314150134748	1	274
BP254	7314150137633	1	277
BP255	7314150137640	1	277
BP255T	7314150427307	1	277
BP255T-1	7314150427314	1	277
BP277K	7314150427284	8	275
BP420M	7314150134618	1	269
BP421M	7314150134625	1	269
BP422M	7314150134632	1	269
BP423M	7314150134649	1	270
BP424M	7314150134656	1	270
BP430M	7314150134663	1	270
BP431M	7314150134670	1	270
BP432M	7314150134687	1	270
BP433M	7314150134694	1	270
BP434M	7314150135837	1	270
BP500	7314150137992	1	277
BP51137	7314150134724	1	272
BP601	7314150134526	1	272
BP60102	7314150426669	1	272
BP610	7314150134595	1	272
BP700	7314150134458	20	268
BP704	7314150427130	1	266
BP721	7314150427185	1	268
BP799	7314150134502	1	276
BP79912	7314150134717	1	276
BP809	7314150235841	1	273
BP80950	7314150275564	1	273
BP810	7314150235858	1	273
BP811	7314150235865	1	274
BP814	7314150184262	10	266
BP814A	7314150304349	10	266
BP815	7314150134311	1	266
BP815K1	7314150181957	1	266
BP815K2	7314150181964	1	266
BP817	7314150134106	1	267
BP820	7314150134465	1	269
BP821	7314150134472	1	269
BP822	7314150134984	1	269
BP822E	7314150184279	10	269
BP823	7314150135004	1	270
BP824	7314150134489	1	274
BP825	7314150134496	1	273
BP826	7314150137459	1	273
BP827	7314150137442	1	274
BP828	7314150427260	1	274
BP830CISB	7314150439799	1	271
BP830ESB	7314150439751	1	271
BP830EWSB	7314150439768	1	271
BP830K	7314150427208	4	271
BP830MISB	7314150439782	1	271
BP830SBA	7314150439805	1	271
BP830SSB	7314150439775	1	271
BP830SW	7314150439744	1	271
BP901	7314150336012	1	268
BP901L	7314150336029	1	268
BP905L	7314150336234	2	268
BP905P	7314150336210	2	268



BP905S	7314150336227	2	268
BP909NE	7314150187980	1	275
BP909NF	7314150187973	1	275
BP909TE	7314150187942	1	275
BP909TF	7314150187911	1	275
BP909TH	7314150187959	1	275
BP909TSP	7314150187966	1	275
BP909TTP	7314150187935	1	275
BP909TWF	7314150187928	1	275
BP910	7314150427246	5	275
BP91BL	7314150192779	1	269
BP91BS	7314150192786	1	269
BPA823	7314150427161	1	273
BPGG3515	7314150134823	1	274
BPGG3525A	7314150134830	1	274
BPGG3525B	7314150134847	1	274
BPBG5725	7314150134861	1	274
BPBG9057	7314150134878	1	274
BPBK30	7314150134854	1	274
BPBL00900	7314150358335	5	335
BPBL30900	7314150360451	5	335
BPBL70600	7314150360468	5	335
BPBL90600	7314150358366	5	335
BPBLS4	7314150360475	2	335
BPBSC156	7314150134816	1	274
BPBU18	7314150134755	1	274
BPBU24	7314150134762	1	274
BPBU36	7314150134779	1	274
BPBU60	7314150134786	1	274
BPBU90	7314150134793	1	274
BPC813	7314150296408	10	266
BPC813K1	7314150331253	1	266
BPC814	7314150296392	10	267
BPC815	7314150296385	1	267
BPC815K1	7314150331208	1	267
BPC815K2	7314150331215	1	267
BPC815K3	7314150331222	1	267
BPC815K4	7314150331239	1	267
BPC815K6	7314150331284	1	267
BPC816	7314150296415	10	266
BPC817	7314150296422	4	267
BPC817K1	7314150331260	1	268
BPC817K2	7314150331277	1	268
BPC823	7314150427147	1	273
BPC825	7314150427154	1	273
BPCVB1	7314150384792	6	324
BPG824	7314150427253	10	274
BPH1010A	7314150330010	1	277
BPH1010B	7314150341757	1	277
BPH1310A	7314150330003	1	277
BPHRC1015	7314150247400	1	277
BPHRC1020	7314150247417	1	278
BPHRC1316	7314150247455	1	278
BPHRC815	7314150247394	1	277
BPHRO1315	7314150247431	1	278
BPHRSC	7314150247448	1	278
BPHVLP01	7314150138937	1	276
BPHVLP0112	7314150165872	1	276
BPHVLP0114	7314150165889	1	276
BPHVLP0117	7314150165896	1	276
BPHVLP0120	7314150165902	1	276
BPM917BOOT	7314150281664	1	268
BPM91MK1	7314150186938	1	268
BPM91MK2	7314150186945	1	268
BPN010	7314150219728	1	277
BPN21201	7314150134731	1	273
BPN22201	7314150138074	1	273
BPN251	7314150137589	1	277
BPOC15	7314150360673	12	307
BPQCF14	7314150138920	10	278
BPR821	7314150427178	1	269
BPSJ	7314150427239	1	278
BPSJL	7314150439812	1	278
BS1000	7314150170081	1	327
BS100001	7314150232819	1	327
BS100002	7314150232826	1	327
BS100003	7314150232833	1	327
BS100004	7314150232840	1	327
BS100005	7314150232857	1	327
BS100006	7314150232864	1	327
BS100007	7314150232871	1	327
BS100008	7314150232888	1	327
BS100009	7314150232895	1	327
BS100010	7314150232901	1	327
BS100011	7314150232918	1	327
BS100012	7314150232925	1	327
BS100013	7314150232932	1	327
BS100014	7314150232949	1	327
BS100015	7314150232956	1	327
BS100016	7314150232963	1	327
BS100017	7314150232970	1	327
BS100018	7314150232987	1	327
BS100019	7314150232994	1	327
BS100020	7314150233007	1	327
BS100021	7314150233014	1	327
BS100022	7314150233021	1	327

BS100023	7314150233038	1	327
BS100024	7314150233045	1	327
BS100025	7314150233052	1	327
BS100026	7314150233069	1	327
BS100027	7314150233076	1	327
BS100028	7314150233083	1	327
BS100029	7314150233090	1	327
BS100030	7314150233106	1	327
BS100031	7314150233113	1	327
BS100032	7314150233120	1	327
BS100033	7314150233137	1	327
BS100034	7314150233144	1	327
BS100035	7314150233151	1	327
BS100036	7314150233168	1	327
BS100037	7314150233175	1	327
BS100038	7314150233182	1	327
BS100039	7314150233199	1	327
BS100PSA1	7314150249282	1	325
BS10AC2	7314150182343	1	327
BS10MEC	7314150178834	1	326
BS15	7314150206117	1	326
BS15125	7314150231775	1	326
BS15125C	7314150231812	1	326
BS15160	7314150231782	1	326
BS15160C	7314150231829	1	326
BS15212	7314150231799	1	326
BS15212C	7314150231836	1	326
BS1550	7314150231805	1	326
BS20	7314150205592	1	326
BS20/S10	7314153009319	1	45
BS25	7314150416103	1	326
BS30AC1	7314150383504	1	327
BS30PG	7314150436644	1	326
BS40VAG	7314150430642	20	325
BS45BMW	7314150430659	20	324
BS52	7314150329212	1	324
BS5228341	7314150329229	1	324
BS5234401	7314150329236	1	324
BS5239451	7314150329243	1	324
BS54	7314150243341	1	319
BS56	7314150430826	6	324
BS618	7314150242368	1	325
BS623	7314150242375	1	325
BSSHE3	7314150251858	1	323
BT10P3	7314150205639	1	335
BT10P325	7314150231706	40	335
BT10P330	7314150231713	1	335
BT10P338	7314150231720	1	335
BT15P5	7314150205837	1	322
BT15P524	7314150231737	1	322
BT15P530	7314150231744	1	322
BT15P532	7314150231751	1	322
BT15P536	7314150342129	1	322
BT20P26	7314150205820	1	325
BT20P49	7314150385041	1	325
BTL-3-13	7314150333349	12	536
BTL-6-13	7314150333356	12	536
BTR-3-13	7314150333332	12	536
BTR-6-13	7314150333363	12	536
BUC100	7314150169962	1	309
BUC110	7314150206025	1	309
BUC50	7314150182329	1	308
BUCKET 1446	7314150436446	75	578
BUCPE	7314150243259	1	308
BUCPE3SDH	7314153024183	1	308
BUCPE3SH	73141502443471	1	308
BUCPEF	7314150244942	1	308
BUCPEF1	7314150245116	1	308
BWB14	7314150170166	2	325
BWB1418S4	7314150365593	6	333
BWB1922S4	7314150365609	6	333
BWBB	7314150407828	200	319
BWC1	7314150365586	25	321
BWHEHS	7314150251841	1	323
BWHEP	7314150251834	1	323
BWHEPS	7314150264087	1	323
BWHEPSH8	7314150264889	1	323
BWHEPSH8	7314150264896	1	323
BWHPJ12	7314150403257	4	325
BWHTRS12	7314150384808	15	320
BWMSP15	7314150239740	1	359
BWMSP1501	7314150239757	1	360
BWMSP1502	7314150239764	1	360
BWMSP1503	7314150239771	1	360
BWMSP1504	7314150239788	1	360
BWMSP1505	7314150239795	1	360
BWMSP1506	7314150239801	1	360
BWMSP1507	7314153024176	1	360
BWMSP1508	7314150239818	1	360
BWMSP1509	7314150239825	1	360
BWMSP1510	7314150239832	1	360
BWMSP1511	7314150239849	1	360
BWMSP1512	7314150239856	1	360
BWMSP1513	7314150239863	1	360
BWMSP1514	7314150239870	1	360
BWMSP1515	7314150239887	1	360





BWP150	7314150170159	1	321
BWSH5	7314150251810	2	323
BWSH51	7314150251827	1	324
BWSH8	7314150255191	1	323
BWSHK21	7314150403271	25	319
BWSMB15	7314150365074	25	319
BWSMB17	7314150329656	1	319
BWSS12P3	7314150170128	20	318
BWSS12P317	7314150203451	1	319
BWSS12P317L	7314150330065	1	319
BWSS12P319	7314150203468	1	319
BWSS12P319L	7314150330072	1	319
BWSS12P321	7314150203475	1	319
BWSS12P321L	7314150330089	1	319
BWSS12P3L	7314150330096	1	319
BWSS12P5	7314150170135	1	319
BWSS12P522	7314150203482	1	319
BWSS12P524	7314150203499	1	319
BWTB12P100	7314150329830	1	321
BWTB12P110	7314150329847	1	321
BWTB12P120	7314150329854	1	321
BWTB12P135	7314150329861	1	321
BWTB12P150	7314150329878	1	321
BWTB12P160	7314150329885	1	321
BWTB12P175	7314150329892	1	321
BWTB12P190	7314150329908	1	321
BWTB12P200	7314150329915	1	321
BWTB12P5	7314150329991	1	321
BWTB12P90	7314150329823	1	321
BWTDG1	7314150403400	50	322
BWTPG1	7314150351886	10	322
BWTPMSS4C	7314150347100	25	322
BWTPMSS9	7314150347124	8	322
BWTSP16	7314150170296	1	320
BWTSP1608	7314150203284	1	320
BWTSP1610	7314150203291	1	320
BWTSP1611	7314150203307	1	320
BWTSP1612	7314150203314	1	320
BWTSP1613	7314150203321	1	320
BWTSP1614	7314150203338	1	320
BWTSP1616	7314150203345	1	320
BWTSP1617	7314150203352	1	320
BWTSP1618	7314150203369	1	320
BWTSP1619	7314150203376	1	320
BWTSP1621	7314150203383	1	320
BWTSP1622	7314150203390	1	320
BWTSP1624	7314150203406	1	320
BWTSP1627	7314150203413	1	320
BWTSP317L	7314150335480	1	320
BWTSP319L	7314150335497	1	320
BWTSP321L	7314150335503	1	320
BWTSP3L	7314150335473	1	320
BWTSP6	7314150240043	1	320
BWTSP617	7314150242399	1	320
BWTSP619	7314150242405	1	320
BWTSP621	7314150242412	1	320
BWTSP622	7314150242429	1	320
BWTSP624	7314150242436	1	320
BWTSP7	7314150170302	1	320
BWTSP732	7314150203420	1	320
BWTSP736	7314150203437	1	320
BWTSP741	7314150203444	1	320
BWTVCTT355	7314150347179	1	322
BWXW1	7314150167661	1	318
BWXW2	7314150167678	1	318
BWXW3	7314150214624	1	318
BWXW4	7314150214631	1	318
BZWTB0132450	7314150165674	1	321
BZWTB0132600	7314150165681	1	321
BZWTB0133600	7314150165698	1	321
C0313C03	7311518100643	1	153
C0313F03	7311518100629	1	153
C0313M03	7311518100636	1	153
C0313M03X	7311518182045	1	153
C0613M03X	7311518197889	1	153
C0616AL06	7311518181826	1	156
C0616C06	7311518100698	1	153
C0616F06	7311518100650	1	153
C0616M03X	7311518204679	1	153
C0616M06	7311518100667	1	153
C0616M06D	7311518215262	1	153
C0616M06X	7311518100681	1	153
C0820C06	7311518100742	1	153
C0820F06	7311518100704	1	153
C0820M06	7311518100711	1	153
C0820M06X	7311518100735	1	153
C1020C06	7311518100797	1	153
C1020F06	7311518100759	1	153
C1020M06	7311518100766	1	153
C1020M06X	7311518100780	1	153
C1225AL06	7311518187637	1	156
C1225AL08	7311518181833	1	156
C1225C06	7311518100841	1	153
C1225C08	7311518100889	1	153
C1225F06	7311518100803	1	153
C1225F08	7311518100858	1	153



C1225M06	7311518100810	1	153
C1225M06X	7311518100834	1	153
C1225M08	7311518100865	1	153
C1225M08X	7311518187996	1	153
C1625C06	7311518192273	1	153
C1625C08	7311518100933	1	153
C1625F06	7311518192259	1	153
C1625F08	7311518100896	1	153
C1625M06	7311518192266	1	153
C1625M06X	7311518187378	1	153
C1625M08	7311518100902	1	153
C1625M08X	7311518100926	1	153
C3140	7314150393312	10	226
C3140IP	7314150391158	10	226
C3230	7314150393329	10	229
C3230IP	7314150391189	10	229
C3330	7314150393336	10	226
C3330IP	7314150391196	10	226
C3330R	7314150393343	10	226
C3330R IP	7314150391202	10	226
C3340R	7314150393350	10	226
C3340R IP	7314150391219	10	226
C3430	7314150393367	10	237
C3430IP	7314150391226	10	237
C3530	7314150393374	10	239
C3530IP	7314150391233	10	239
C3630	7314150393381	10	234
C3630IP	7314150391240	10	234
C3640	7314150393398	10	234
C3640IP	7314150391257	10	234
C3745	7314150393404	10	235
C3745IP	7314150391264	10	235
C3790	7314150393411	10	236
C3790IP	7314150391271	10	236
C3830	7314150393428	10	234
C3830IP	7314150391288	10	234
C3840	7314150393435	10	234
C3840IP	7314150391295	10	234
C3901/3	7314150392797	1	248
C3902/3	7314150399604	1	249
CFP250	7314150400669	6	606
CFW250	7314150400683	6	606
CHALK-BLUE	7314150128686	6	540
CHALK-RED	7314150128709	6	540
CHALK-WHITE	7314150179671	6	540
CHALK-YELLOW	7314150128693	6	540
CL-1221	7314150127122	6	540
CL-1221-SET	7314150188574	4	540
CL-1331	7314150347728	48	539
CL-1331-SET	7314150360741	16	540
CL-1441	7314150347735	36	539
CL-1441-SET	7314150360758	16	540
CLIPS-1/2	7314153003201	25	92
CLIPS-1/4	7314153003188	25	69
CLIPS-3/8	7314153003195	25	82
CR B 01	7314150215409	5	246
CR B 02	7314150215416	5	246
CR B 03	7314150215423	5	246
CR B 05	7314150215454	2	246
CR B 06	7314150215461	2	246
CR L 01	7314150215911	1	248
CR L 02	7314150215928	1	248
CR L 03	7314150215935	1	248
CR W 01	7314150215492	1	246
CR W 02	7314150215508	1	247
CR W 03	7314150215515	1	247
CR W 04	7314150215522	1	247
CR W 05	7314150215539	1	247
CR W 06	7314150215546	1	247
CR W 07	7314150215553	1	247
CS150	7314150125241	12	542
CS300	7314150125258	12	542
CS400	7314150125265	12	542
CUC-0.4-360	7314150342075	4	594
CUC-0.8-600	7314150342099	4	594
D-DD/S20	7311518280345	4	112
D/S10	7311518280307	6	112
D/S14	7311518280314	6	111
D0303C03	7311518100964	1	153
D0303F03	7311518100940	1	153
D0303M03	7311518100957	1	153
D0303M03X	7311518182052	1	153
D0605M03X	7311518197896	1	153
D0606C06	7311518043872	1	153
D0606F06	7311518100971	1	153
D0606M06	7311518100988	1	153
D0606M06X	7311518101008	1	153
D0807C06	7311518043933	1	153
D0807F06	7311518043889	1	153
D0807M06	7311518043896	1	153
D0807M06X	7311518043919	1	153
D1009C06	7311518035310	1	153
D1009F06	7311518043926	1	153
D1009M06	7311518035280	1	153
D1009M06X	7311518035297	1	153
D1211AL06	7311518187644	1	156



D1211AL08	7311518181840	1	156
D1211C06	7311518035365	1	153
D1211F06	7311518035327	1	153
D1211F06D	7311518266424	1	153
D1211M06	7311518035334	1	153
D1211M06X	7311518035358	1	153
D1614C06	7311518192341	1	153
D1614C08	7311518035419	1	153
D1614F06	7311518192334	1	153
D1614F08	7311518035372	1	153
D1614M06	7311518192327	1	153
D1614M06X	7311518187385	1	153
D1614M08	7311518035389	1	153
D1614M08X	7311518035402	1	153
DD/S10	7311518280321	6	112
DD/S14	7311518280338	4	112
DOW 175-1	7314152202728	1	258
DOW 175-11/2	7314152202995	1	258
DOW 175-2	7314152203022	1	258
DOW 175-3	7314152203299	1	258
DOW 176-1	7314152206047	1	259
DOW 176-11/2	7314152206122	1	259
DOW 176-2	7314152206399	1	259
DOW 177-1/2-1	7314152816383	1	259
DOW 177-11/2	7314152816468	1	259
DOW 177-2	7314152816543	1	259
E0308C03	7311518035440	1	154
E0308F03	7311518035426	1	154
E0308M03	7311518035433	1	154
E0308M03X	7311518192372	1	154
E0614C06	7311518035495	1	154
E0614F06	7311518035457	1	154
E0614M06	7311518035464	1	154
E0816C06	7311518035549	1	154
E0816F06	7311518035501	1	154
E0816M06	7311518035518	1	154
E0816M06X	7311518035532	1	154
E1018C06	7311518035594	1	154
E1018F06	7311518035556	1	154
E1018M06	7311518035563	1	154
E1018M06X	7311518035587	1	154
E1222C06	7311518035648	1	154
E1222C08	7311518035686	1	154
E1222F06	7311518035600	1	154
E1222F08	7311518035655	1	154
E1222M06	7311518035617	1	154
E1222M06X	7311518035631	1	154
E1222M08	7311518172558	1	154
E1222M08X	7311518199302	1	154
E1625C06	7311518192464	1	154
E1625C08	7311518035730	1	154
E1625F06	7311518192457	1	154
E1625F08	7311518035693	1	154
E1625M06	7311518192440	1	154
E1625M06X	7311518187392	1	154
E1625M08	7311518035709	1	154
E1625M08X	7311518035723	1	154
EX-14-TEN-C	7311518298333	10	560
EX-14-VEN-C	7311518298340	10	560
EX-16-GNP-C	7311518298685	10	558
EX-19-XT9-C	7311518298302	10	559
EX-20-LAM-C	7311518298326	10	560
EX-20-XT11-C	7311518298319	10	560
EX-22-PLS-C	7311518298357	10	558
EX-22-U7	7311518300890	10	559
EX-22-XT7-C	7311518298289	10	561
EX-22-XT9-C	7311518298296	10	559
EX-24-XT7-C	7311518298272	10	561
EX-244P-22	7311518298456	10	561
EX-LL	7311518298494	4	562
EX-NPP-22	7311518324162	10	559
EX-RL	7311518298487	4	562
EX-RM	7311518298470	4	562
F0313C03	7311518035761	1	154
F0313F03	7311518035747	1	154
F0313M03	7311518035754	1	154
F0313M03X	7311518192495	1	154
F0612C04	7311518192525	1	154
F0612F04	7311518192518	1	154
F0612M04	7311518035778	1	154
F0612M04X	7311518188474	1	154
F0613M03X	7311518196608	1	154
F0618AL06	7311518181857	1	156
F0618C06	7311518035822	1	154
F0618F06	7311518035785	1	154
F0618M06	7311518035792	1	154
F0618M06X	7311518035815	1	154
F0820C06	7311518035877	1	154
F0820F06	7311518035846	1	154
F0820M06	7311518035839	1	154
F0820M06X	7311518035860	1	154
F1020C06	7311518035921	1	154
F1020F06	7311518035884	1	154
F1020M06	7311518035891	1	154
F1020M06X	7311518035914	1	154
F1225AL06	7311518187651	1	156



F1225AL08	7311518181864	1	156
F1225C06	7311518035969	1	154
F1225C08	7311518036010	1	154
F1225F06	7311518035938	1	154
F1225F08	7311518035976	1	154
F1225M06	7311518035945	1	154
F1225M06X	7311518036003	1	154
F1225M08	7311518035983	1	154
F1225M08X	7311518192563	1	154
F1625C06	7311518192594	1	154
F1625C08	7311518036065	1	154
F1625F06	7311518192587	1	154
F1625F08	7311518036027	1	154
F1625M06	7311518192570	1	154
F1625M06X	7311518187408	1	154
F1625M08	7311518036034	1	154
F1625M08X	7311518036058	1	154
FCP-1.8-810	7311518123970	4	594
FCP-2.3-860	7311518123994	2	594
FCS-1000	7314150321551	6	542
FCS-600	7314150321537	6	542
FCS-800	7314150321544	6	542
FF1A01	7314150228560	1	392
FF1A02	7314150228591	1	401
FF1A03	7314150228607	1	407
FF1A04	7314150227778	1	401
FF1A05	7314150227808	1	392
FF1A06	7314150227822	1	407
FF1A07	7314150227846	1	408
FF1A08	7314150227976	1	392
FF1A09	7314150227990	1	401
FF1A10	7314150228010	1	389
FF1A1001	7314150286478	1	389
FF1A1002	7314150286461	1	389
FF1A1003	7314150286485	1	389
FF1A1004	7314150286454	1	400
FF1A1005	7314150286591	1	389
FF1A1006	7314150286645	1	390
FF1A1007	7314150286621	1	390
FF1A1008	7314150309443	1	390
FF1A1010	7314150320660	1	400
FF1A1011	7314150339068	1	400
FF1A102	7314150334841	1	405
FF1A104	7314150334865	1	401
FF1A106	7314150335541	1	393
FF1A11	7314150228034	1	405
FF1A110	7314150335619	1	408
FF1A112	7314150335572	1	402
FF1A114	7314150335633	1	408
FF1A115	7314150335640	1	408
FF1A117	7314150335701	1	408
FF1A118	7314150335732	1	405
FF1A119	7314150335749	1	408
FF1A12	7314150228058	1	409
FF1A121	7314150335718	1	409
FF1A124	7314150335725	1	409
FF1A127	7314150336395	1	409
FF1A128	7314150336586	1	409
FF1A129	7314150336593	1	409
FF1A13	7314150228072	1	393
FF1A130	7314150336661	1	393
FF1A131	7314150336678	1	410
FF1A132	7314150336685	1	410
FF1A133	7314150336692	1	400
FF1A134	7314150336708	1	402
FF1A135	7314150336715	1	402
FF1A136	7314150336722	1	410
FF1A137	7314150336739	1	394
FF1A138	7314150336746	1	410
FF1A139	7314150336753	1	400
FF1A14	7314150228089	1	402
FF1A141	7314150336777	1	405
FF1A142	7314150338573	1	394
FF1A143	7314150338580	1	410
FF1A145	7314150338603	1	405
FF1A146	7314150338610	1	394
FF1A147	7314150338627	1	411
FF1A15	7314150228096	1	406
FF1A153	7314150350445	1	398
FF1A154	7314150350476	1	417
FF1A16	7314150228102	1	411
FF1A164	7314150350957	1	417
FF1A165	7314150350964	1	398
FF1A166	7314150350971	1	391
FF1A167	7314150350988	1	417
FF1A168	7314150350995	1	417
FF1A169	7314150351008	1	417
FF1A17	7314150228119	1	390
FF1A170	7314150351800	1	405
FF1A18	7314150228126	1	411
FF1A189	7314150405961	1	417
FF1A19	7314150254354	1	402
FF1A194	7314150431496	1	398
FF1A195LM	7314150455850	1	398
FF1A196LM	7314150455874	1	398
FF1A197LM	7314150455881	1	418



# FF1A198LM



FF1A198LM	7314150455898	1	404
FF1A199LM	7314150455904	1	404
FF1A20	7314150254361	1	402
FF1A200LM	7314150455928	1	407
FF1A201LM	7314150455935	1	391
FF1A202LM	7314150455966	1	401
FF1A203LM	7314150455973	1	401
FF1A204LM	7314150455980	1	418
FF1A205LM	7314150455997	1	418
FF1A206LM	7314150456000	1	398
FF1A207LM	7314150456017	1	399
FF1A208LM	7314150456024	1	418
FF1A209LM	7314150456031	1	404
FF1A21	7314150254378	1	390
FF1A210LM	7314150456062	1	418
FF1A211LM	7314150456079	1	401
FF1A212LM	7314150456086	1	418
FF1A213	7314150437283	1	399
FF1A214LM	7314150456093	1	399
FF1A215LM	7314150456109	1	419
FF1A216LM	7314150456123	1	419
FF1A218LM	7314150456130	1	399
FF1A219LM	7314150456147	1	399
FF1A22	7314150254385	1	394
FF1A220LM	7314150456154	1	404
FF1A221LM	7314150456161	1	419
FF1A222LM	7314150456178	1	419
FF1A223LM	7314150456185	1	407
FF1A224LM	7314150456192	1	419
FF1A225LM	7314150456208	1	419
FF1A229	7314150461448	1	400
FF1A23	7314150254392	1	411
FF1A230	7314150461455	1	420
FF1A2301	7314150286508	1	394
FF1A24	7314150254408	1	411
FF1A25	7314150254415	1	395
FF1A2501	7314150286492	1	395
FF1A2503	7314150320677	1	395
FF1A26	7314150254422	1	412
FF1A27	7314150254439	1	390
FF1A28	7314150254446	1	412
FF1A3001	7314150286515	1	402
FF1A3002	7314150289264	1	403
FF1A3003	7314150286522	1	403
FF1A3004	7314150286676	1	403
FF1A3005	7314150286638	1	403
FF1A35	7314150264124	1	412
FF1A36	7314150265862	1	412
FF1A37	7314150265855	1	396
FF1A39	7314150266920	1	396
FF1A40	7314150266951	1	391
FF1A4001	7314150286713	1	406
FF1A4002	7314150286560	1	406
FF1A4003	7314150286706	1	406
FF1A41	7314150266982	1	412
FF1A48	7314150271801	1	404
FF1A49	7314150271818	1	391
FF1A50	7314150271825	1	406
FF1A5001	7314150286430	1	391
FF1A5002	7314150286447	1	403
FF1A5003	7314150286690	1	396
FF1A5004	7314150286539	1	396
FF1A5005	7314150286546	1	396
FF1A5006	7314150286683	1	403
FF1A5007	7314150286553	1	412
FF1A5008	7314150286607	1	413
FF1A5009	7314150286669	1	413
FF1A5010	7314150286584	1	413
FF1A5011	7314150286614	1	413
FF1A5012	7314150286652	1	413
FF1A5013	7314150286577	1	397
FF1A5015	7314150307401	1	414
FF1A5017	7314150307425	1	414
FF1A5019	7314150309436	1	414
FF1A5021	7314150309467	1	414
FF1A5022	7314150309474	1	414
FF1A5023	7314150309498	1	415
FF1A5024	7314150309504	1	415
FF1A5027	7314150320684	1	403
FF1A5028	7314150320691	1	415
FF1A5029	7314150320707	1	415
FF1A5030	7314150320714	1	415
FF1A5031	7314150320721	1	415
FF1A5032	7314150320738	1	397
FF1A5036	7314150339037	1	416
FF1A5037	7314150339044	1	416
FF1A5038	7314150339051	1	416
FF1A51	7314150271832	1	406
FF1A53	7314150271856	1	416
FF1A54	7314150288786	1	397
FF1A55	7314150299720	1	397
FF1A56	7314150299737	1	404
FF1A59	7314150306442	1	397
FF1A65	7314150313389	1	404
FF1A66	7314150313396	1	416
FF1A67	7314150313402	1	416



FF1A68	7314150313419	1	407
FF1A70	7314150320189	1	397
FF1A71	7314150320196	1	400
FF1A72	7314150320202	1	416
FF1A82	7314150334070	1	420
FF1ASET-AUTO-M1	7314150438259	1	434
FF1ASET-AUTO-M2	7314150438327	1	434
FF1ASET-AUTO-M3	7314150438334	1	434
FF1ASET-AUTO-M4	7314150438341	1	434
FF1ASET-AUTO-M5	7314150438358	1	434
FF1ASET-AUTO-M6	7314150438365	1	435
FF1ASET-AUTO1	7314150254453	1	435
FF1ASET-AUTO13	7314150447701	1	435
FF1ASET-AUTO2	7314150254460	1	435
FF1ASET-AUTO3	7314150254477	1	435
FF1ASET-AUTO6	7314150319909	1	436
FF1ASET-MAX	7314150255308	1	428
FF1ASET-MRO2	7314150336623	1	442
FF1ASET-MRO3	7314150336630	1	442
FF1ASET-MRO4	7314150336647	1	442
FF1ASET-MRO5	7314150336654	1	443
FF1ASET-XLARGE	7314150436965	1	427
FF1B01LM	7314150455416	1	423
FF1B02LM	7314150455447	1	423
FF1B03LM	7314150455454	1	423
FF1B04LM	7314150455478	1	424
FF1B05LM	7314150455515	1	424
FF1B06LM	7314150455522	1	424
FF1B07LM	7314150455614	1	424
FF1B08LM	7314150455645	1	424
FF1B09LM	7314150455669	1	425
FF1B10LM	7314150455706	1	425
FF1B11LM	7314150455713	1	425
FF1BSET-MONSTER	7314150436835	1	427
FF1E1001	7314150285839	1	372
FF1E1002	7314150285761	1	372
FF1E1003	7314150285853	1	372
FF1E1004	7314150285754	1	372
FF1E1005	7314150285785	1	372
FF1E1006	7314150285778	1	372
FF1E1007	7314150285792	1	372
FF1E1008	7314150285822	1	372
FF1E1009	7314150285808	1	372
FF1E1009EH	7314150352579	1	380
FF1E1010	7314150285815	1	373
FF1E1011	7314150285846	1	373
FF1E1012EH	7314150352562	1	380
FF1E1013EH	7314150352586	1	380
FF1E2001	7314150285945	1	373
FF1E2002	7314150285921	1	373
FF1E2003	7314150286072	1	373
FF1E2004	7314150285952	1	373
FF1E2005	7314150285976	1	374
FF1E2006	7314150285914	1	374
FF1E2007	7314150285907	1	374
FF1E2008	7314150285860	1	374
FF1E2009EH	7314150352593	1	380
FF1E2010EH	7314150352654	1	380
FF1E2011EH	7314150373802	1	382
FF1E2101	7314150285877	1	374
FF1E2102	7314150286058	1	374
FF1E2103	7314150286089	1	375
FF1E2104	7314150285990	1	375
FF1E2105	7314150286041	1	375
FF1E2106EH	7314150352623	1	380
FF1E2107EH	7314150352661	1	380
FF1E2201	7314150286010	1	375
FF1E2202	7314150285891	1	375
FF1E2203	7314150285884	1	375
FF1E2204	7314150285983	1	376
FF1E2205	7314150285938	1	376
FF1E2206	7314150286034	1	376
FF1E2207	7314150285969	1	376
FF1E2208	7314150286027	1	376
FF1E2209	7314150286096	1	376
FF1E2210	7314150286065	1	377
FF1E2211	7314150339006	1	377
FF1E2212	7314150339013	1	377
FF1E2213	7314150339020	1	377
FF1E2214EH	7314150352647	1	380
FF1E2215EH	7314150352678	1	381
FF1E2216EH	7314150373833	1	382
FF1E2501	7314150286003	1	377
FF1E2502	7314150338993	1	377
FF1E2503EH	7314150352685	1	381
FF1E2504EH	7314150374106	1	382
FF1E2505EH	7314150373826	1	382
FF1E3001	7314150286119	1	378
FF1E3002	7314150286102	1	378
FF1E3003	7314150286157	1	378
FF1E3004	7314150286133	1	378
FF1E3005	7314150286126	1	378
FF1E3006	7314150286140	1	378
FF1E3007	7314150286164	1	378
FF1E3008	7314150286171	1	378
FF1E3009EH	7314150352722	1	381



FF1E3010EH	7314150352739	1	381
FF1E3011EH	7314150352753	1	381
FF1E4001	7314150285747	1	379
FF1E4002	7314150285730	1	379
FF1E4003EH	7314150352692	1	381
FF1E4004EH	7314150352708	1	381
FF1E4005EH	7314150352807	1	381
FF1E4006EH	7314150352814	1	382
FF1E5001	7314150285716	1	379
FF1E5002	7314150285709	1	379
FF1E5003	7314150285723	1	379
FF1E5004	7314150338931	1	379
FF1E5005	7314150338948	1	377
FF1E5006	7314150338955	1	377
FF1E5007	7314150338962	1	379
FF1E5008	7314150338979	1	379
FF1E5009	7314150338986	1	378
FF1E5010EH	7314150352746	1	381
FF1E5011EH	7314150352777	1	382
FF1E5013EH	7314150352821	1	382
FF1E5014EH	7314150373864	1	382
FF1E5015EH	7314150373871	1	383
FF1E5016EH	7314150373888	1	382
FF1F1001	7314150286270	1	383
FF1F1002	7314150286287	1	383
FF1F1003	7314150286294	1	383
FF1F1004	7314150286263	1	383
FF1F1005	7314150286300	1	383
FF1F1006	7314150286249	1	383
FF1F1007	7314150286256	1	384
FF1F1008	7314150339129	1	384
FF1F1009	7314150339136	1	384
FF1F2001	7314150286317	1	384
FF1F2002	7314150339143	1	384
FF1F2101	7314150286331	1	384
FF1F2102	7314150339105	1	384
FF1F2103	7314150339112	1	385
FF1F2201	7314150286324	1	385
FF1F2202	7314150339150	1	385
FF1F2203	7314150339167	1	385
FF1F3001	7314150286348	1	385
FF1F3002	7314150286379	1	385
FF1F3003	7314150286409	1	386
FF1F3004	7314150286386	1	386
FF1F3005	7314150286362	1	386
FF1F3006	7314150286355	1	386
FF1F3007	7314150286393	1	386
FF1F3008	7314150286423	1	386
FF1F3009	7314150286416	1	386
FF1F3010	7314150339082	1	386
FF1F3011	7314150339099	1	386
FF1F4001	7314150286195	1	387
FF1F4002	7314150286201	1	387
FF1F4003	7314150286225	1	387
FF1F4004	7314150286232	1	387
FF1F4005	7314150286218	1	387
FF1F5001	7314150286188	1	387
FF1F5002	7314150339174	1	387
FF1F5003	7314150339181	1	388
FF1F5004	7314150339198	1	385
FF1F5005	7314150339204	1	388
FF1F5006	7314150339211	1	388
FF1F5007	7314150339228	1	388
FF1F5008	7314150339235	1	388
FF1F5009	7314150339242	1	388
FF1F5010	7314150339259	1	388
FF1F5011	7314150339266	1	388
FF1F5012	7314150339273	1	389
FF1F5013	7314150339280	1	385
FF2A07	7314150228201	1	446
FF2A08	7314150228225	1	447
FF2A09	7314150228249	1	447
FF2A10	7314150228263	1	450
FF2B01	7314150233441	1	447
FF2B02	7314150233465	1	447
FF2B03	7314150233489	1	447
FF2B04	7314150233502	1	448
FF2B05	7314150233526	1	448
FF2B06	7314150233540	1	448
FF2B07	7314150229420	1	448
FF2B08	7314150229451	1	448
FF2B09	7314150229482	1	448
FF2B10	7314150229505	1	449
FF2B11	7314150229529	1	449
FF2B12	7314150229543	1	449
FF2B13	7314150229567	1	449
FF2B14	7314150229581	1	449
FF2B15	7314150229604	1	450
FF2B16	7314150229628	1	450
FF2C01	7314150327287	1	450
FF3A01	7314150228300	1	428
FF3A02	7314150228324	1	428
FF3A03	7314150228348	1	429
FF3A04	7314150228362	1	429
FF3A05	7314150228386	1	429
FF3A06	7314150228416	1	429



FF3A07	7314150228430	1	429
FF3A08	7314150228454	1	430
FF3A09	7314150228478	1	430
FF3A10	7314150228492	1	430
FF3A11	7314150228515	1	430
FF3A12	7314150228539	1	430
FF3A13	7314150228614	1	431
FF3A14	7314150228638	1	431
FF3A15	7314150228652	1	431
FF3A16	7314150228676	1	431
FF3A17	7314150228690	1	431
FFSS-1.5-900FG	7311518275884	4	594
FGS-1.0-600	7311518123796	4	594
FGS-1.25-700	7311518123802	4	594
FGS-1.25-700-WB	7314150398720	4	594
FGS-1.6-810	7311518123819	4	594
FGS-1.6-810-WB	7314150399086	4	594
FGS-1.8-810	7311518123826	4	594
FM10	7311518010881	5	33
FM12	7314150273249	5	33
FP-3M	7311518168612	1	621
FS-5	7311518266455	10	626
FS-7.5	7311518266479	10	626
FS-8	7311518266462	10	626
G0313C03	7311518036096	1	154
G0313F03	7311518036072	1	154
G0313M03	7311518036089	1	154
G0313M03X	7311518182069	1	154
G0613M03X	7311518196592	1	154
G0618C06	7311518036140	1	154
G0618F06	7311518036102	1	154
G0618M06	7311518036119	1	154
G0618M06X	7311518036133	1	154
G0645M4.9X	7311518195380	1	156
G0820C06	7311518172572	1	154
G0820F06	7311518036157	1	154
G0820M06	7311518036164	1	154
G0820M06X	7311518036188	1	154
G0845M6.6X	7311518195403	1	156
G1020C06	7311518036249	1	154
G1020F06	7311518036201	1	154
G1020M06	7311518036218	1	154
G1020M06X	7311518036232	1	154
G1050M8.3X	7311518195397	1	156
G1225C06	7311518036348	1	154
G1225C08	7311518036386	1	154
G1225F06	7311518036300	1	154
G1225F08	7311518036355	1	154
G1225M06	7311518036317	1	154
G1225M06X	7311518036331	1	154
G1225M08	7311518036362	1	154
G1225M08X	7311518188009	1	154
G1625C06	7311518192662	1	154
G1625C08	7311518036430	1	154
G1625F06	7311518192655	1	154
G1625F08	7311518036393	1	154
G1625M06	7311518192648	1	154
G1625M06X	7311518187415	1	154
G1625M08	7311518036409	1	154
G1625M08X	7311518036423	1	154
GL008-10	7314150167050	5	484
GL008-8	7314150167043	5	484
GL010-10	7314150167098	5	484
GL010-8	7314150167081	5	484
GL012-10	7314150167104	5	484
GL012-8	7314150167111	5	484
GS-180-F	7311518275488	6	625
GS-76	7311518010782	8	625
H0613M03X	7311518196615	1	154
H1025C06	7311518182328	1	154
H1025F06	7311518182335	1	154
H1025M06	7311518182304	1	154
H1025M06X	7311518182311	1	154
H1025M08	7311518273439	1	154
H1232M06	7311518182076	1	154
H1232M06X	7311518181758	1	154
H1635C06	7311518192754	1	154
H1635C08	7311518192785	1	154
H1635F06	7311518192747	1	154
H1635F08	7311518192778	1	154
H1635M06	7311518192730	1	154
H1635M06X	7311518187422	1	154
H1635M08	7311518182083	1	154
H1635M08X	7311518182090	1	154
HFGPS-0.7-400FG	7311518275877	4	594
HGPS-0.6-360	7311518123680	10	594
HGPS-0.6-360-WB	7314150398690	4	594
HGPS-0.8-380	7311518123697	4	594
HGPS-0.8-380-WB	7314150398812	4	594
HGPS-1.0-400	7311518123703	4	594
HGPS-1.0-400-WB	7314150398713	4	594
HFRM10	7311518010898	5	33
HS6000	7314150113781	1	639
HSSG-A0616M	7311518023379	1	156
HSSG-A0616M-S	7311518022501	1	156
HSSG-A1020M	7311518023386	1	156



# HSSG-A1020M-S



HSSG-A1020M-S	7311518022518	1	156
HSSG-A1225EC	7311518023409	1	156
HSSG-A1225EC-S	7311518022532	1	156
HSSG-A1225M	7311518023393	1	156
HSSG-A1225M-S	7311518022525	1	156
HSSG-C0616M	7311518023423	1	156
HSSG-C0616M-S	7311518022556	1	157
HSSG-C1020M	7311518023430	1	156
HSSG-C1020M-S	7311518022563	1	157
HSSG-C1225EC	7311518023454	1	156
HSSG-C1225EC-S	7311518022587	1	157
HSSG-C1225M	7311518023447	1	156
HSSG-C1225M-S	7311518022570	1	157
HSSG-D0606M	7311518023461	1	157
HSSG-D0606M-S	7311518022594	1	157
HSSG-D0807M	7311518023478	1	157
HSSG-D0807M-S	7311518022600	1	157
HSSG-D1009M	7311518023485	1	157
HSSG-D1009M-S	7311518022617	1	157
HSSG-D1211EC	7311518023508	1	157
HSSG-D1211EC-S	7311518022631	1	157
HSSG-D1211M	7311518023492	1	157
HSSG-D1211M-S	7311518022624	1	157
HSSG-E0614M	7311518023522	1	157
HSSG-E1222EC	7311518023546	1	157
HSSG-E1222EC-S	7311518022679	1	157
HSSG-E1222M	7311518023539	1	157
HSSG-E1222M-S	7311518022662	1	157
HSSG-F0618M	7311518023560	1	157
HSSG-F0618M-S	7311518022693	1	157
HSSG-F1225M	7311518023577	1	157
HSSG-F1225M-S	7311518022709	1	157
HSSG-G0618M	7311518023591	1	157
HSSG-G0618M-S	7311518022716	1	157
HSSG-G0645MX	7311518195496	1	156
HSSG-G1220M	7311518023607	1	157
HSSG-G1220M-S	7311518022723	1	157
HSSG-G1225EC	7311518023621	1	157
HSSG-G1225M	7311518023614	1	157
HSSG-G1225M-S	7311518022730	1	157
HSSG-M0618M	7311518023638	1	158
HSSG-M0618M-S	7311518022754	1	158
HSSG-M1227M	7311518023645	1	158
HSSG-M1227M-S	7311518022761	1	158
HUS-0.6-380	7311518123659	4	594
HUS-0.8-500	7311518123666	4	594
HUS-1.0-650	7311518123673	4	594
IZO-D-135	7314151845827	1	120
IZO-D-200	7314151846831	1	120
IZO-D-30	7314151846824	1	120
IZO-D-340	7314151846848	1	120
IZO-DR-810	7314151846817	1	120
J0604C06	7311518036515	1	154
J0604F06	7311518036492	1	154
J0604M06	7311518036508	1	154
J1010C06	7311518036553	1	155
J1010F06	7311518036522	1	154
J1010M06	7311518172473	1	154
J1212M06	7311518036577	1	155
J1616C06	7311518192822	1	155
J1616C08	7311518036638	1	155
J1616F06	7311518192815	1	155
J1616F08	7311518036607	1	155
J1616M06	7311518187439	1	155
J1616M08	7311518036614	1	155
JLB.M.20N	8412814119977	1	603
JLB.M.30N	8412814119984	1	603
JLBM50M53PA	7314150255061	1	603
K-AP-1	7311518030117	10	625
K-GP-1	7311518030131	10	625
K0602C06	7311518036669	1	155
K0602F06	7311518036645	1	155
K0602M06	7311518036652	1	155
K1008C06	7311518036706	1	155
K1008F06	7311518036676	1	155
K1008M06	7311518036683	1	155
K1210C06	7311518036744	1	155
K1210F06	7311518036713	1	155
K1210M06	7311518036720	1	155
K1612C06	7311518193973	1	155
K1612C08	7311518036782	1	155
K1612F06	7311518193966	1	155
K1612F08	7311518036751	1	155
K1612M06	7311518193959	1	155
K1612M08	7311518036768	1	155
K172	7314150384396	1	108
K18NF-2	7314151347161	5	177
K18PH-2M5	7314153019646	5	177
K18PH-2M6	7314150274871	5	177
K19PZD-2M5	7314151693237	1	178
K19PZD-2NF	7314151586157	1	178
K20TORX-T25	7314151825799	10	178
K560F-1	7314151825492	5	107
K560F-2	7314151825324	5	108
K560F-3	7314151825331	5	108
K560F-4	7314151825348	5	111



K560F-5	7314151825355	5	111
K560F-6	7314151825362	5	114
K560F-7	7314151825379	5	116
K560F-8	7314151825508	5	116
K560F-9	7314151846688	5	117
K66100-1/4	7314150204540	1	180
K66100-1/4-1P	7314150260201	25	180
K66100-3/8	7314150204564	1	180
K66100-3/8-1P	7314150260249	25	180
K6625-1/4	7314150204496	1	179
K6625-1/4-1P	7314150260140	1	179
K6638-3/8	7314150204557	1	179
K6638-3/8-1P	7314150260164	25	179
K6650-1/2	7314150204519	1	179
K6650-1/2-1P	7314150260188	1	179
K6650-1/4	7314150204526	1	179
K6650-1/4-1P	7314150204533	1	179
K6650-3/8	7314150204502	1	179
K6650-3/8-1P	7314150260225	1	179
K6660-QR-1P	7314150204571	1	180
K6701M-10	7314151778149	1	107
K6701M-11	7314151778224	1	107
K6701M-12	7314151811891	1	107
K6701M-13	7314151778491	1	107
K6701M-14	7314151844172	1	107
K6701M-6	7314151813260	1	107
K6701M-7	7314151777920	1	107
K6701M-8	7314151778064	1	107
K6701M-9	7314151815110	1	107
K6750-1/4	7314150204663	1	178
K6750-10	7314150204700	1	178
K6750-13	7314150204823	1	178
K6750-3/8	7314150204656	1	178
K6750-6	7314150204670	1	178
K6750-7	7314150204687	1	178
K6750-8	7314150204694	1	178
K6964C	7314151215170	1	108
K7401M-10	7314151780128	1	107
K7401M-11	7314151780395	1	107
K7401M-12	7314151811907	1	107
K7401M-13	7314151780470	1	107
K7401M-14	7314151780555	1	107
K7401M-15	7314151812140	1	107
K7401M-16	7314151780630	1	107
K7401M-17	7314151780715	1	107
K7401M-18	7314151812157	1	107
K7401M-19	7314151812164	1	107
K7401M-20	7314151844271	1	107
K7401M-21	7314151845216	1	107
K7401M-22	7314151845223	1	107
K7401M-24	7314151844295	1	107
K7401M-7	7314151812126	1	107
K7401M-8	7314151780043	1	107
K7401M-9	7314151812133	1	107
K7401M10	7314150389919	1	109
K7401TORX-E-S7	7314150343324	1	109
K7401TORX-E10	7314151844448	1	108
K7401TORX-E12	7314151844455	1	108
K7401TORX-E14	7314151844462	1	108
K7401TORX-E5	7314151844400	1	108
K7401TORX-E6	7314151844417	1	108
K7401TORX-E7	7314151844424	1	108
K7401TORX-E8	7314151844431	1	108
K7401Z-1/2	7314150384402	1	107
K7401Z-11/16	7314150384419	1	107
K7401Z-13/16	7314150384426	1	107
K7401Z-3/4	7314150384433	1	107
K7401Z-3/8	7314150384440	1	107
K7401Z-5/8	7314150384457	1	107
K7401Z-7/16	7314150384464	1	107
K7401Z-7/8	7314150384471	1	107
K7401Z-9/16	7314150384488	1	107
K7406M-10	7314151844479	1	108
K7406M-13	7314151844486	1	108
K7406M-17	7314151844493	1	108
K7760C-1	7314151222369	1	108
K7760C-2	7314151222376	1	108
K7764D	7314151222475	1	110
K7767S	7314151222512	1	108
K7800M-10	7314150326297	1	109
K7800M-11	7314150326303	1	109
K7800M-12	7314150326310	1	109
K7800M-13	7314150326327	1	109
K7800M-14	7314150326334	1	109
K7800M-15	7314150326341	1	109
K7800M-16	7314150326358	1	109
K7800M-17	7314150326365	1	109
K7800M-18	7314150326372	1	109
K7800M-19	7314150326389	1	109
K7800M-21	7314150326396	1	109
K7800M-22	7314150326402	1	109
K7800M-24	7314150326419	1	109
K7800M13	7314150437221	1	111
K7801M-10	7314151778576	1	109
K7801M-11	7314151778651	1	109
K7801M-12	7314151815790	1	109



K7801M-13	7314151778736	1	109
K7801M-14	7314151778811	1	109
K7801M-15	7314151815806	1	109
K7801M-16	7314151779030	1	109
K7801M-17	7314151779115	1	109
K7801M-18	7314151779382	1	109
K7801M-19	7314151779467	1	109
K7801M-20	7314151844509	1	109
K7801M-21	7314151779542	1	109
K7801M-22	7314151779627	1	109
K7801M-23	7314151844516	1	109
K7801M-24	7314151779894	1	109
K7801M-25	7314151844523	1	109
K7801M-26	7314151844530	1	109
K7801M-27	7314151779979	1	109
K7801M-28	7314150430154	1	109
K7801M-29	7314150430161	1	109
K7801M-30	7314151811914	1	109
K7801M-32	7314151825157	15	109
K7801M-34	7314151844547	1	109
K7801M-36	7314151844554	1	109
K7801M-8	7314151845230	1	109
K7801M-9	7314151845247	1	109
K7801TORX-E10	7314151811587	1	110
K7801TORX-E12	7314151811594	1	110
K7801TORX-E14	7314151811600	1	110
K7801TORX-E16	7314151811617	1	110
K7801TORX-E18	7314151811624	1	110
K7801TORX-E20	7314151811631	1	110
K7801TORX-E24	7314151811648	1	110
K7801VM-17	7314151781521	1	109
K7801VM-19	7314151781798	1	109
K7801VM-22	7314151781873	1	109
K7801VM-24	7314151781958	1	109
K7801VM/S4	7314151799090	1	111
K7801Z-1	7314151844639	1	110
K7801Z-1.1/16	7314151844646	1	110
K7801Z-1.1/2	7314150137701	5	110
K7801Z-1.1/4	7314151844660	1	110
K7801Z-1.1/8	7314151844653	1	110
K7801Z-1.3/8	7314150137688	5	110
K7801Z-1.5/16	7314150137671	5	110
K7801Z-1.7/16	7314150137695	5	110
K7801Z-1/2	7314151822620	1	110
K7801Z-11/16	7314151844592	1	110
K7801Z-13/16	7314151844608	1	110
K7801Z-15/16	7314151844622	1	110
K7801Z-3/4	7314151822668	1	110
K7801Z-3/8	7314151822606	1	110
K7801Z-5/8	7314151844585	1	110
K7801Z-7/16	7314151844561	1	110
K7801Z-7/8	7314151844615	1	110
K7801Z-9/16	7314151822637	1	110
K7801Z/10	7314150165018	1	112
K7806M-10	7314151844677	1	110
K7806M-11	7314151844684	1	110
K7806M-12	7314151844691	1	110
K7806M-13	7314151805944	1	110
K7806M-14	7314151844707	1	110
K7806M-15	7314150330683	1	110
K7806M-16	7314151844714	1	110
K7806M-17	7314151805951	1	110
K7806M-18	7314151844721	1	110
K7806M-19	7314151805968	1	110
K7806M-21	7314151823597	1	110
K7806M-22	7314151805975	1	110
K7806M-23	7314151844738	1	110
K7806M-24	7314151805982	1	110
K7806M-27	7314151805999	1	110
K7806M-30	7314151844578	1	110
K7806M-32	7314150220304	1	110
K7806M-36	7314150220311	1	110
K7806M/S4	7314151813222	1	111
K7806Z-1	7314150137817	5	110
K7806Z-1.1/16	7314150137824	5	110
K7806Z-1.1/2	7314150137886	5	110
K7806Z-1.1/4	7314150137848	5	110
K7806Z-1.1/8	7314150137831	5	110
K7806Z-1.3/8	7314150137862	5	110
K7806Z-1.5/16	7314150137855	5	110
K7806Z-1.7/16	7314150137879	5	110
K7806Z-1/2	7314150137749	10	110
K7806Z-11/16	7314150137770	5	110
K7806Z-13/16	7314150137794	5	110
K7806Z-15/16	7314150137718	5	110
K7806Z-3/4	7314150137787	5	110
K7806Z-3/8	7314150137725	10	110
K7806Z-5/8	7314150137763	5	110
K7806Z-7/16	7314150137732	10	110
K7806Z-7/8	7314150137800	5	110
K7806Z-9/16	7314150137756	10	110
K7806Z/10	7314150165025	1	112
K8160D-1	7314151237400	1	110
K8160D-2	7314151237417	1	110
K8160D-3	7314151237424	1	110
K8164C	7314151237523	1	108



K8164F	7314151237554	1	113
K8167S	7314151237592	1	110
K8901M-17	7314151803155	1	113
K8901M-18	7314151844189	1	113
K8901M-19	7314151803162	1	113
K8901M-21	7314151803179	1	113
K8901M-22	7314151803186	1	113
K8901M-23	7314151803193	1	113
K8901M-24	7314151803209	1	113
K8901M-27	7314151803216	1	113
K8901M-28	7314151803223	1	113
K8901M-29	7314151803230	1	113
K8901M-30	7314151803247	1	113
K8901M-32	7314151803254	1	113
K8901M-33	7314151803261	1	113
K8901M-34	7314151803278	1	113
K8901M-36	7314151803285	1	113
K8901M-38	7314151803292	1	113
K8901M-41	7314151803308	1	113
K8901M-46	7314151803315	1	113
K8901M-50	7314151846398	1	113
K8901M-55	7314151846404	1	113
K8901M-60	7314151846411	1	113
K8901M/8	7314150165032	1	114
K8901Z-1	7314151844752	1	113
K8901Z-1.1/16	7314151844769	1	113
K8901Z-1.1/2	7314151844820	1	113
K8901Z-1.1/4	7314151844783	1	113
K8901Z-1.1/8	7314151844776	1	113
K8901Z-1.11/16	7314150130269	1	113
K8901Z-1.13/16	7314150130276	1	113
K8901Z-1.15/16	7314150130290	1	113
K8901Z-1.3/16	7314150130245	1	113
K8901Z-1.3/4	7314151844844	1	113
K8901Z-1.3/8	7314151844806	1	113
K8901Z-1.5/16	7314151844790	1	113
K8901Z-1.5/8	7314151844837	1	113
K8901Z-1.7/16	7314151844813	1	113
K8901Z-1.7/8	7314150130283	1	113
K8901Z-1.9/16	7314150130252	1	113
K8901Z-11/16	7314150130238	1	113
K8901Z-13/16	7314151844226	1	113
K8901Z-15/16	7314151844745	1	113
K8901Z-2	7314150130306	1	113
K8901Z-2.1/16	7314150130313	1	113
K8901Z-2.1/4	7314150130344	1	113
K8901Z-2.3/16	7314150130337	1	113
K8901Z-2.3/8	7314150130351	1	113
K8901Z-3/4	7314151844202	1	113
K8901Z-7/8	7314151844301	1	113
K8901Z/18	7314150436514	1	114
K8901Z/8	7314150165049	1	114
K8906M-17	7314151803056	1	113
K8906M-19	7314151803063	1	113
K8906M-21	7314151844851	1	113
K8906M-22	7314151803070	1	113
K8906M-24	7314151803087	1	113
K8906M-27	7314151803094	1	113
K8906M-30	7314151803117	1	113
K8906M-32	7314151803124	1	113
K8906M-33	7314151844868	1	113
K8906M-34	7314151844875	1	113
K8906M-36	7314151803148	1	113
K8906M-41	7314151845254	1	113
K8906M-46	7314150220601	1	113
K8906M/8	7314150165056	1	114
K8906Z-1	7314150130436	1	113
K8906Z-1.1/16	7314150130443	1	113
K8906Z-1.1/2	7314150130511	1	113
K8906Z-1.1/4	7314150130474	1	113
K8906Z-1.1/8	7314150130450	1	113
K8906Z-1.3/4	7314150130559	1	113
K8906Z-1.3/8	7314150130498	1	113
K8906Z-1.5/16	7314150130481	1	113
K8906Z-1.5/8	7314150130535	1	113
K8906Z-1.7/16	7314150130504	1	113
K8906Z-13/16	7314150130405	1	113
K8906Z-15/16	7314150130429	1	113
K8906Z-2	7314150130580	1	113
K8906Z-3/4	7314150130399	1	113
K8906Z-7/8	7314150130412	1	113
K8906Z/8	7314150165063	1	115
K8909H-5	7314151619343	1	114
K8909ML-12	7314151232863	1	116
K8909ML-14	7314151232870	1	116
K8909ML-17	7314151232887	1	116
K8960F-2	7314151268138	1	113
K8960F-3	7314151268145	1	113
K8960F-4	7314150220625	10	113
K8964D	7314151268237	1	110
K8964G	7314151268268	1	116
K8967S	7314151268329	1	113
K9501M-22	7314151844882	1	115
K9501M-24	7314151802677	1	115
K9501M-27	7314151802684	1	115
K9501M-30	7314151802714	1	115



# K9501M-32



K9501M-32	7314151802721	1	115
K9501M-33	7314151802738	1	115
K9501M-34	7314151802745	1	115
K9501M-36	7314151802752	1	115
K9501M-38	7314151802769	1	115
K9501M-41	7314151802776	1	115
K9501M-42	7314151802783	1	115
K9501M-46	7314151802790	1	115
K9501M-50	7314151802806	1	115
K9501M-55	7314151802813	1	115
K9501M-60	7314151802820	1	115
K9501M-65	7314151802837	1	115
K9501M-70	7314151802844	1	115
K9501M-75	7314151802851	1	115
K9501M-80	7314151802868	1	115
K9501M-85	7314150352197	1	115
K9501Z-1	7314151844912	1	115
K9501Z-1.1/16	7314150130634	1	115
K9501Z-1.1/2	7314151844943	1	115
K9501Z-1.1/4	7314151844929	1	115
K9501Z-1.1/8	7314150130641	1	115
K9501Z-1.11/16	7314150130696	1	115
K9501Z-1.13/16	7314151844967	1	115
K9501Z-1.15/16	7314150130719	1	115
K9501Z-1.3/16	7314150130658	1	115
K9501Z-1.3/4	7314150130702	1	115
K9501Z-1.3/8	7314150130672	1	115
K9501Z-1.5/16	7314150130665	1	115
K9501Z-1.5/8	7314151844950	1	115
K9501Z-1.7/16	7314151844936	1	115
K9501Z-1.7/8	7314151844974	1	115
K9501Z-1.9/16	7314150130689	1	115
K9501Z-2	7314150130726	1	115
K9501Z-2.1/4	7314150130764	1	115
K9501Z-2.1/8	7314150130740	1	115
K9501Z-2.3/16	7314150130757	1	115
K9501Z-2.3/4	7314150130832	1	115
K9501Z-2.5/16	7314150130771	1	115
K9501Z-2.9/16	7314150130801	1	115
K9506M-22	7314151844998	1	115
K9506M-24	7314151802530	1	115
K9506M-27	7314151802547	1	115
K9506M-30	7314151802554	1	115
K9506M-32	7314151802561	1	115
K9506M-33	7314151802578	1	115
K9506M-34	7314151845018	1	115
K9506M-36	7314151802585	1	115
K9506M-38	7314151802592	1	115
K9506M-41	7314151802608	1	115
K9506M-46	7314151802615	1	115
K9506M-50	7314151802622	1	115
K9506M-55	7314151802639	1	115
K9506M-60	7314151802646	1	115
K9506Z-1	7314150131686	1	115
K9506Z-1.1/16	7314150131693	1	115
K9506Z-1.1/2	7314150131761	1	115
K9506Z-1.1/4	7314150131723	1	115
K9506Z-1.13/16	7314150131808	1	115
K9506Z-1.3/16	7314150131716	1	115
K9506Z-1.5/8	7314150131785	1	115
K9506Z-1.7/16	7314150131754	1	115
K9506Z-1.7/8	7314150131815	1	115
K9509H5	7314151619428	1	116
K9509ML-19	7314151618964	1	116
K9509ML-22	7314151619183	1	116
K9509ML-24	7314151619268	1	116
K9560G-0	7314150240012	1	115
K9560G-1	7314151285944	1	115
K9560G-2	7314151285951	1	115
K9560G-3	7314151285968	1	115
K9560G-4	7314150133970	1	115
K9560G-5	7314150133987	1	115
K9564F	7314151286026	1	113
K9567S	7314151286095	1	115
K9598H	7314150133956	1	117
K9801M-100	7314151845162	1	116
K9801M-105	7314151845179	1	116
K9801M-110	7314151845186	1	116
K9801M-115	7314151845193	1	116
K9801M-120	7314151845209	1	116
K9801M-125	7314150167159	1	116
K9801M-130	7314150167166	1	116
K9801M-135	7314150167173	1	116
K9801M-140	7314150167180	1	116
K9801M-145	7314150167197	1	116
K9801M-150	7314150167203	1	116
K9801M-155	7314150167210	1	116
K9801M-46	7314151845056	1	116
K9801M-50	7314151845063	1	116
K9801M-55	7314151845070	1	116
K9801M-60	7314151845087	1	116
K9801M-65	7314151845094	1	116
K9801M-70	7314151845100	1	116
K9801M-75	7314151845117	1	116
K9801M-80	7314151845124	1	116
K9801M-85	7314151845131	1	116



K9801M-90	7314151845148	1	116
K9801M-95	7314151845155	1	116
K9801Z-1.1/2	7314150131976	1	116
K9801Z-1.11/16	7314150132003	1	116
K9801Z-1.13/16	7314150132027	1	116
K9801Z-1.15/16	7314150132041	1	116
K9801Z-1.3/4	7314150132010	1	116
K9801Z-1.3/8	7314150131952	1	116
K9801Z-1.5/8	7314150131990	1	116
K9801Z-1.7/16	7314150131969	1	116
K9801Z-1.7/8	7314150132034	1	116
K9801Z-1.9/16	7314150131983	1	116
K9801Z-2	7314150132058	1	116
K9801Z-2.1/16	7314150132065	1	116
K9801Z-2.1/2	7314150132133	1	116
K9801Z-2.1/4	7314150132096	1	116
K9801Z-2.1/8	7314150132072	1	116
K9801Z-2.11/16	7314150132164	1	116
K9801Z-2.13/16	7314150132188	1	116
K9801Z-2.15/16	7314150132201	1	116
K9801Z-2.3/16	7314150132089	1	116
K9801Z-2.3/4	7314150132171	1	116
K9801Z-2.3/8	7314150132119	1	116
K9801Z-2.5/16	7314150132102	1	116
K9801Z-2.5/8	7314150132157	1	116
K9801Z-2.7/16	7314150132126	1	116
K9801Z-2.7/8	7314150132195	1	116
K9801Z-2.9/16	7314150132140	1	116
K9801Z-3	7314150132218	1	116
K9801Z-3.1/16	7314150132225	1	116
K9801Z-3.1/2	7314150132287	1	116
K9801Z-3.1/4	7314150132249	1	116
K9801Z-3.1/8	7314150132232	1	116
K9801Z-3.11/16	7314150132317	1	116
K9801Z-3.13/16	7314150132331	1	117
K9801Z-3.15/16	7314150132355	1	117
K9801Z-3.3/4	7314150132324	1	116
K9801Z-3.3/8	7314150132263	1	116
K9801Z-3.5/16	7314150132256	1	116
K9801Z-3.5/8	7314150132300	1	116
K9801Z-3.7/16	7314150132270	1	116
K9801Z-3.7/8	7314150132348	1	117
K9801Z-3.9/16	7314150132294	1	116
K9801Z-4	7314150132362	1	117
K9801Z-4.1/16	7314150132379	1	117
K9801Z-4.1/2	7314150132430	1	117
K9801Z-4.1/4	7314150132393	1	117
K9801Z-4.1/8	7314150132386	1	117
K9801Z-4.3/4	7314150132454	1	117
K9801Z-4.3/8	7314150132416	1	117
K9801Z-4.5/16	7314150132409	1	117
K9801Z-4.5/8	7314150132447	1	117
K9801Z-4.7/16	7314150132423	1	117
K9806M-100	7314150131105	1	117
K9806M-105	7314150131112	1	117
K9806M-110	7314150131129	1	117
K9806M-115	7314150131136	1	117
K9806M-120	7314150131143	1	117
K9806M-41	7314150130986	1	117
K9806M-46	7314150130993	1	117
K9806M-50	7314150131006	1	117
K9806M-55	7314150131013	1	117
K9806M-60	7314150131020	1	117
K9806M-65	7314150131037	1	117
K9806M-70	7314150131044	1	117
K9806M-75	7314150131051	1	117
K9806M-80	7314150131068	1	117
K9806M-85	7314150131075	1	117
K9806M-90	7314150131082	1	117
K9806M-95	7314150131099	1	117
K9806Z-1.1/2	7314150131174	1	117
K9806Z-1.11/16	7314150131198	1	117
K9806Z-1.3/8	7314150131150	1	117
K9806Z-1.5/8	7314150131181	1	117
K9806Z-1.7/16	7314150131167	1	117
K9806Z-2	7314150131204	1	117
K9806Z-2.1/16	7314150131211	1	117
K9806Z-2.1/2	7314150131273	1	117
K9806Z-2.1/4	7314150131235	1	117
K9806Z-2.11/16	7314150131303	1	117
K9806Z-2.13/16	7314150131327	1	117
K9806Z-2.15/16	7314150131341	1	117
K9806Z-2.3/16	7314150131228	1	117
K9806Z-2.3/4	7314150131310	1	117
K9806Z-2.3/8	7314150131259	1	117
K9806Z-2.5/16	7314150131242	1	117
K9806Z-2.5/8	7314150131297	1	117
K9806Z-2.7/16	7314150131266	1	117
K9806Z-2.7/8	7314150131334	1	117
K9806Z-2.9/16	7314150131280	1	117
K9806Z-3	7314150131358	1	117
K9806Z-3.1/16	7314150131365	1	117
K9806Z-3.1/2	7314150131433	1	117
K9806Z-3.1/4	7314150131396	1	117
K9806Z-3.1/8	7314150131372	1	117
K9806Z-3.11/16	7314150131464	1	117





K9806Z-3.13/16	7314150131488	1	117
K9806Z-3.15/16	7314150131501	1	117
K9806Z-3.3/16	7314150131389	1	117
K9806Z-3.3/4	7314150131471	1	117
K9806Z-3.3/8	7314150131419	1	117
K9806Z-3.5/16	7314150131402	1	117
K9806Z-3.5/8	7314150131457	1	117
K9806Z-3.7/16	7314150131426	1	117
K9806Z-3.7/8	7314150131495	1	117
K9806Z-3.9/16	7314150131440	1	117
K9806Z-4	7314150131518	1	117
K9806Z-4.1/16	7314150131525	1	117
K9806Z-4.1/2	7314150131570	1	117
K9806Z-4.1/4	7314150131549	1	117
K9806Z-4.1/8	7314150131532	1	117
K9806Z-4.3/4	7314150131594	1	117
K9806Z-4.3/8	7314150131563	1	117
K9806Z-4.5/16	7314150131556	1	117
K9806Z-4.5/8	7314150131587	1	117
K9860H-1	7314150133994	1	117
K9860H-2	7314150134007	1	117
K9860H-3	7314150134014	1	117
K9867S	7314150133932	1	117
K9895G	7314150133949	1	116
K9899H	7314150166763	1	117
K9998H	7314150133963	1	117
KB09-01	7314150196968	5	576
KB18-01	7314150196944	5	576
KBFU-01	7314150196913	5	576
KBGH-5P-DISPEN	7314150296729	20	576
KBGR-5P-DISPEN	7314150296774	20	576
KBGU-100P	7314150213405	1	576
KBGU-10P-DISPEN	7314150262984	20	576
KBGU-5P-DISPEN	7314150296705	20	576
KBRU-01	7314150196876	5	575
KBSK-01	7314150196999	5	577
KBSU-01	7314150197002	5	578
KBTU-01	7314150196982	5	577
KBWS-01	7314150225972	10	580
KCB753	7314150204915	1	179
KE18-01	7314150196937	5	575
KEFU-01	7314150196906	5	575
KERU-01	7314150196869	5	575
KG09-01	7314150196975	5	576
KG09-01-3P	7314150213962	10	576
KG18-01	7314150196951	5	577
KGAU-01	7314150223893	5	577
KGFU-01	7314150196920	5	576
KGRU-01	7314150196883	5	575
KGRU-02	7314150196890	5	575
KGSU-01	7314150197019	5	578
KHU-01	7314150268955	4	577
KM1/4-5/16-1P	7314150275953	50	179
KM100-SH	7314150215690	1	178
KM653	7314151786915	1	178
KM653-1P	7314151840709	25	178
KM653-QR	7314150115983	1	178
KM653-QR-1P	7314151848507	50	178
KM653-SF	7314150204984	1	179
KM6701M-10	7314151844264	1	107
KM6701M-7	7314151844240	1	107
KM6701M-8	7314151844257	1	107
KM6750-1/4	7314150204595	1	178
KM6750-10	7314150204649	20	178
KM6750-11	7314150302628	1	178
KM6750-13	7314150204632	1	178
KM6750-3/8	7314150204588	1	178
KM6750-6	7314150204601	1	178
KM6750-7	7314150204618	1	178
KM6750-8	7314150204625	1	178
KM753-QR-1P	7314150204830	1	178
KMR150	7314150204960	1	179
KMR150-1P	7314150204977	1	179
KMR653	7314150204922	1	179
KMR653-1P	7314150204939	1	179
KMR753	7314150204946	20	179
KMR753-1P	7314150204953	1	179
KMT753-QR-1P	7314150391523	50	178
KMU-01	7314150197026	5	575
KR653	7314150204885	1	178
KR653-1P	7314150206263	25	178
KRSS-01	7314150214938	10	580
KS7401M-10	7314150384495	1	108
KS7401M-11	7314150384501	1	108
KS7401M-12	7314150384518	1	108
KS7401M-13	7314150384525	1	108
KS7401M-14	7314150384532	1	108
KS7401M-15	7314150384549	1	108
KS7401M-16	7314150384556	1	108
KS7401M-17	7314150384563	1	108
KS7401M-18	7314150384570	1	108
KS7401M-19	7314150384587	1	108
KS7401M-22	7314150384594	1	108
KS7401M-9	7314150384600	1	108
KSBG09-10DISPEN	7314150262991	20	577
KSBG18-10DISPEN	7314150263004	20	577



KSR753	7314150204892	1	525
KSR753-1P	7314150204908	1	525
KUBG09-5DISPEN	7314150296828	20	577
KUBG09-5P	7314150213450	60	577
KUBG18-5DISPEN	7314150296835	20	577
KUBG18-5P	7314150213443	20	577
L1020C06	7311518182113	1	155
L1020F06	7311518182106	1	155
L1020M06	7311518133665	1	155
L1020M06X	7311518136369	1	155
L1225F06	7311518192860	1	155
L1225M06	7311518132774	1	155
L1225M06X	7311518136857	1	155
L1230AL06	7311518187668	1	156
L1230AL08	7311518181871	1	156
L1230C06	7311518182120	1	155
L1230F06	7311518182137	1	155
L1230M06	7311518182168	1	155
L1230M06X	7311518182175	1	155
L1630C06	7311518192938	1	155
L1630C08	7311518182144	1	155
L1630F06	7311518192921	1	155
L1630F08	7311518182151	1	155
L1630M06	7311518192914	1	155
L1630M06X	7311518187446	1	155
L1630M08	7311518182205	1	155
L1630M08X	7311518136833	1	155
LAP-KNIFE	7311518216443	10	628
LS-6160-23	7311518041304	1	630
LS-COIN 19 CM	7311518031077	4	596
LS-COIN 26 CM	7311518333041	2	596
LS-COMBINESS	7311518041366	1	629
LS-MASSE-4	7311518012014	2	595
LS-MASSE-4FG	7311518275891	2	595
LS-MASSE-TR-4FG	7311518281106	2	595
LS-MERLIN-2.5	7311518012069	2	595
LS-MERLIN-2.5FG	7311518281113	2	595
LS-NATURAL	7311518224622	1	629
LS-PIERRE CORINDON	7311518000977	1	629
LS-PIERRE-FAUX	7311518000938	1	630
LS-TRIANGLE	7311518224653	1	629
LST-30111	7314150337262	5	610
LST-32011	7314150337279	5	610
LST-40311	7314150337309	5	611
LST-41312	7314150337293	5	611
LST-42312	7314150337286	5	611
LST-50123	7314150337248	5	610
LST-51121	7314150337231	5	610
LST-52102	7314150337347	5	610
LST-52121	7314150337224	5	610
LST-61121	7314150337187	5	610
LST-63102	7314150337330	5	610
LST-70120	7314150337255	5	610
LST-72324	7314150337163	5	610
LST-73524	7314150337170	5	610
LST-99102	7314150337354	4	610
LT-STEEL-30	7314150138012	5	537
LT-STEEL-50	7314150138029	5	537
LTB-10	7314150120048	6	537
LTB-20	7314150120062	6	537
LTB-30	7314150120086	6	537
LTG-10	7314150119981	6	537
LTG-20	7314150120000	6	537
LTG-30	7314150120024	6	537
LTS-100	7314150120147	5	537
LTS-100-E	7314150120154	5	537
LTS-30	7314150120109	5	537
LTS-30-E	7314150120116	5	537
LTS-50	7314150120123	5	537
LTS-50-E	7314150120130	5	537
LUB-2015	7311518335427	6	630
M0310C03	7311518036812	1	155
M0310F03	7311518036799	1	155
M0310M03	7311518036805	1	155
M0310M03X	7311518197063	1	155
M0613M03X	7311518196622	1	155
M0618C06	7311518036867	1	155
M0618F06	7311518036829	1	155
M0618M06	7311518036836	1	155
M0618M06X	7311518036850	1	155
M1022C06	7311518036911	1	155
M1022F06	7311518036874	1	155
M1022M06	7311518036881	1	155
M1022M06D	7311518210762	1	155
M1022M06X	7311518036904	1	155
M1227C06	7311518036966	1	155
M1227C08	7311518192983	1	155
M1227F06	7311518036935	1	155
M1227F08	7311518036973	1	155
M1227M06	7311518036928	1	155
M1227M06X	7311518036959	1	155
M1227M08	7311518036980	1	155
M1227M08X	7311518192990	1	155
M1630C06	7311518193034	1	155
M1630C08	7311518037093	1	155
M1630F06	7311518193027	1	155



# M1630F08



M1630F08	7311518037055	1	155
M1630M06	7311518193010	1	155
M1630M06X	7311518187453	1	155
M1630M08	7311518037062	1	155
M1630M08X	7311518037086	1	155
M227L	7311518160883	4	573
M227R	7311518160869	4	573
M330	7311518160906	4	573
M526	7311518160982	4	573
M6376	7311518196486	1	574
M6376-SH	7311518199296	1	574
M676	7311518161088	1	574
M676-SH	7311518211875	1	574
M780	7314151826215	1	211
M781	7314153016218	5	211
M926	7311518161071	1	574
M926-SH	7314150107537	1	574
MA225	7311518161057	4	572
MA225L	7311518161033	4	572
MA225R	7311518161040	4	572
MA311	7314150181568	10	572
MA321	7314150181551	10	572
MA325	7311518161064	4	572
MA351	7314150181582	10	572
MA361	7314150181575	10	572
MA401	7314150167593	10	572
MA411	7314150167609	10	572
MA421	7314150167616	10	572
MA431	7314150181544	1	572
MA500-1A	7314150458882	1	647
MA500-2A	7314150458899	1	647
MA500-3A	7314150456925	1	647
MAM50M	7314150215300	1	126
MCP-2.5-810	7311518124052	2	594
MES-3.0-900	7311518123864	2	595
MES-3.5-900	7311518123871	2	595
MES-3.5-900FG	7311518281120	2	595
MK5	7314150224333	1	62
MK9	7314150224326	1	63
MONSTER	7314150437405	1	420
MR126	7311518161019	4	573
MR227L	7311518161002	4	574
MR227R	7311518160999	4	574
MR340	7311518197537	2	573
MR726	7311518161026	4	574
MT-TS-3	7314150194995	12	536
MTB-3-16	7314150119066	6	536
MTB-3-16-M	7314150119073	6	536
MTB-3-16-M-E	7314150119141	6	536
MTB-5-25	7314150119080	6	536
MTB-5-25-C1	7314150119127	6	536
MTB-5-25-M	7314150119097	6	536
MTB-5-25-M-E	7314150119158	6	536
MTB-8-25	7314150125418	6	536
MTB-8-25-M	7314150127078	6	536
MTB-8-25-M-E	7314150127085	6	536
MTC-3-13	7314150321322	6	536
MTC-3-13-C1	7314150330843	6	536
MTC-5-16	7314150321339	6	536
MTC-5-16-C1	7314150330850	6	536
MTG-3-16	7314150118984	12	536
MTG-3-16-E	7314150119028	12	536
MTG-5-19	7314150118991	12	536
MTG-5-19-E	7314150119035	12	536
MTG-8-25	7314150330348	4	536
MTG-8-25-E	7314150390809	4	536
MTS-5-25	7314150119233	6	536
MTS-5-25-E	7314150119271	6	536
MTS-8-25	7314150119257	6	536
MTS-8-25-E	7314150119295	6	536
MTT051	7314150270521	6	580
MTT121	7314150213290	8	580
MTT151	7314150120703	6	580
MW-150	7314150125685	2	537
MW-250	7314150125678	2	537
N0306C03	7311518193065	1	155
N0306F03	7311518193058	1	155
N0306M03	7311518182212	1	155
N0306M03E	7311518182229	1	155
N0607C06	7311518193089	1	155
N0607F06	7311518193072	1	155
N0607M06	7311518182236	1	155
N0607M06E	7311518182243	1	155
N1213C06	7311518193102	1	155
N1213F06	7311518193096	1	155
N1213M06	7311518134570	1	155
N1213M06E	7311518182250	1	155
N1213M06X	7311518237172	1	155
N1613C06	7311518193133	1	155
N1613C08	7311518193157	1	155
N1613F06	7311518193126	1	155
N1613F08	7311518193140	1	155
N1613M06	7311518136000	1	155
N1613M06E	7311518193119	1	155
N1613M06X	7311518204525	1	155
N1613M08	7311518182267	1	155



N1613M08E	7311518182274	1	155
NP-12-COM	7311518264277	4	558
NP-12-TEN	7311518263959	10	561
NP-12-VEN	7311518264260	10	561
NP-16-U7/8-HP	7311518241773	4	559
NP-19-U7/8-HP	7311518241452	10	559
NP-22-F7/8-HP	7311518035204	10	559
NP-22-U7/8-HP	7311518034399	10	559
NS001-150	7314150316069	1	502
NS001-200	7314150316076	1	502
NS001-250	7314150316083	1	502
NS001-300	7314150316090	1	502
NS001-375	7314150325108	1	502
NS001-450	7314150325115	1	502
NS001-600	7314150325122	1	502
NS001-900	7314150325139	1	502
NS002-10	7314150284719	10	502
NS002-11	7314150292592	5	502
NS002-12	7314150292608	5	502
NS002-13	7314150284726	10	502
NS002-14	7314150284733	5	502
NS002-15	7314150292615	5	502
NS002-16	7314150292622	5	502
NS002-17	7314150284740	10	502
NS002-18	7314150292639	5	502
NS002-19	7314150284757	10	502
NS002-20	7314150292646	5	502
NS002-21	7314150292653	5	502
NS002-22	7314150292660	10	502
NS002-23	7314150292677	5	502
NS002-24	7314150292684	10	502
NS002-25	7314150292691	5	502
NS002-26	7314150292707	5	502
NS002-27	7314150284764	5	502
NS002-28	7314150292714	5	502
NS002-29	7314150292721	10	502
NS002-30	7314150292738	10	502
NS002-31	7314150292745	5	502
NS002-32	7314150284771	5	502
NS002-33	7314150292752	5	502
NS002-34	7314150292769	5	502
NS002-35	7314150292776	5	502
NS002-36	7314150284788	5	502
NS002-38	7314150292783	5	502
NS002-40	7314150292790	5	502
NS002-41	7314150292806	5	502
NS002-42	7314150292813	5	502
NS002-46	7314150292820	5	502
NS002-50	7314150292837	5	502
NS002-52	7314150292844	5	502
NS002-55	7314150292851	5	502
NS002-6	7314150292554	5	502
NS002-60	7314150292868	1	502
NS002-65	7314150292875	1	502
NS002-7	7314150292561	5	502
NS002-70	7314150292882	1	502
NS002-75	7314150292899	1	502
NS002-8	7314150292578	5	502
NS002-80	7314150292905	1	502
NS002-9	7314150292585	5	502
NS006-0607	7314150292912	1	503
NS006-0608	7314150292929	1	503
NS006-0708	7314150292936	1	503
NS006-0709	7314150292943	1	503
NS006-0809	7314150292967	1	503
NS006-0810	7314150292950	1	503
NS006-0910	7314150292974	1	503
NS006-0911	7314150292981	1	503
NS006-1011	7314150292998	1	503
NS006-1012	7314150293001	1	503
NS006-1013	7314150293018	1	503
NS006-1014	7314150293025	1	503
NS006-1113	7314150293032	1	503
NS006-1114	7314150293049	1	503
NS006-1213	7314150293056	1	503
NS006-1214	7314150293063	1	503
NS006-1315	7314150293070	1	503
NS006-1415	7314150293087	1	503
NS006-1416	7314150293094	1	503
NS006-1417	7314150293100	1	503
NS006-1617	7314150293117	1	503
NS006-1618	7314150293124	1	503
NS006-1719	7314150293131	1	503
NS006-1722	7314150293148	1	503
NS006-1819	7314150293155	1	503
NS006-1820	7314150293162	1	503
NS006-1920	7314150293179	1	503
NS006-1922	7314150293186	1	503
NS006-1924	7314150293193	1	503
NS006-2022	7314150293209	1	503
NS006-2122	7314150293216	1	503
NS006-2123	7314150293223	1	503
NS006-2223	7314150293230	1	503
NS006-2224	7314150293247	1	503
NS006-2227	7314150293254	1	503
NS006-2326	7314150293261	1	503



NS006-2425	7314150293278	1	503
NS006-2426	7314150293285	1	503
NS006-2427	7314150293292	1	503
NS006-2430	7314150293308	1	503
NS006-2528	7314150293315	1	503
NS006-2629	7314150293322	1	503
NS006-2729	7314150293339	1	503
NS006-2730	7314150293346	1	503
NS006-2732	7314150293353	1	503
NS006-2830	7314150293360	1	503
NS006-3031	7314150293377	1	503
NS006-3032	7314150293384	1	503
NS006-3034	7314150293391	1	503
NS006-3036	7314150293407	1	503
NS006-3234	7314150293414	1	503
NS006-3235	7314150293421	1	503
NS006-3236	7314150293438	1	503
NS006-3335	7314150293445	1	503
NS006-3436	7314150293452	1	503
NS006-3536	7314150293469	1	503
NS006-3638	7314150293476	1	503
NS006-3641	7314150293483	1	503
NS006-3642	7314150293490	1	503
NS006-4146	7314150293506	1	503
NS006-4650	7314150293513	1	503
NS006-5052	7314150293520	1	503
NS006-5055	7314150293537	1	503
NS006-5060	7314150293544	1	503
NS006-5062	7314150293551	1	503
NS006-5560	7314150293568	1	503
NS006-6065	7314150293575	1	503
NS006-6570	7314150293582	1	503
NS010-0607	7314150293599	1	503
NS010-0709	7314150293605	1	503
NS010-0809	7314150293612	1	503
NS010-0911	7314150293629	1	503
NS010-1011	7314150293636	1	503
NS010-1012	7314150293643	1	503
NS010-1214	7314150293650	1	503
NS010-1315	7314150293667	1	503
NS010-1417	7314150293674	1	503
NS010-1618	7314150293681	1	503
NS010-1719	7314150293698	1	503
NS010-1722	7314150293704	1	503
NS010-1819	7314150293711	1	503
NS010-1921	7314150293728	1	503
NS010-1922	7314150293735	1	503
NS010-2022	7314150293742	1	503
NS010-2123	7314150293759	1	503
NS010-2224	7314150293766	1	503
NS010-2427	7314150293773	1	503
NS010-2528	7314150293780	1	503
NS010-2628	7314150293797	1	503
NS010-2730	7314150293803	1	503
NS010-2732	7314150293810	1	503
NS010-3032	7314150293827	1	503
NS010-3036	7314150293834	1	503
NS010-3236	7314150293841	1	503
NS010-3641	7314150293858	1	503
NS010-4146	7314150293865	1	503
NS010-4650	7314150293872	1	503
NS011-0607	7314150317271	1	504
NS011-0809	7314150317288	1	504
NS011-1011	7314150317295	1	504
NS011-1213	7314150317301	1	504
NS011-1415	7314150317318	1	504
NS011-1617	7314150317325	1	504
NS011-1819	7314150317332	1	504
NS011-2022	7314150317349	1	504
NS011-2123	7314150317356	1	504
NS011-2426	7314150317363	1	504
NS011-2528	7314150317370	1	504
NS011-2729	7314150317387	1	504
NS011-3032	7314150317394	1	504
NS100-100	7314150294305	1	504
NS100-105	7314150294312	1	504
NS100-110	7314150294329	1	504
NS100-115	7314150294336	1	504
NS100-120	7314150294343	1	504
NS100-17	7314150293889	1	504
NS100-19	7314150293896	1	504
NS100-22	7314150293902	1	504
NS100-24	7314150293919	1	504
NS100-25	7314150293926	1	504
NS100-27	7314150293933	1	504
NS100-28	7314150293940	1	504
NS100-29	7314150293957	1	504
NS100-30	7314150293964	1	504
NS100-32	7314150293971	1	504
NS100-33	7314150293988	1	504
NS100-34	7314150293995	1	504
NS100-35	7314150294008	1	504
NS100-36	7314150294015	1	504
NS100-37	7314150294022	1	504
NS100-38	7314150294039	1	504
NS100-41	7314150294046	1	504

NS100-42	7314150294053	1	504
NS100-45	7314150294060	1	504
NS100-46	7314150294077	1	504
NS100-47	7314150294084	1	504
NS100-50	7314150294091	1	504
NS100-52	7314150294107	1	504
NS100-54	7314150294114	1	504
NS100-55	7314150294121	1	504
NS100-56	7314150294138	1	504
NS100-58	7314150294145	1	504
NS100-60	7314150294152	1	504
NS100-63	7314150294169	1	504
NS100-65	7314150294176	1	504
NS100-67	7314150294183	1	504
NS100-70	7314150294190	1	504
NS100-71	7314150294206	1	504
NS100-75	7314150294213	1	504
NS100-77	7314150294220	1	504
NS100-80	7314150294237	1	504
NS100-82	7314150294244	1	504
NS100-85	7314150294251	1	504
NS100-88	7314150294268	1	504
NS100-90	7314150294275	1	504
NS100-94	7314150294282	1	504
NS100-95	7314150294299	1	504
NS104-100	7314150294947	1	505
NS104-105	7314150294954	1	505
NS104-110	7314150294961	1	505
NS104-115	7314150294978	1	505
NS104-120	7314150294985	1	505
NS104-17	7314150294350	1	505
NS104-19	7314150294367	1	505
NS104-20	7314150294374	1	505
NS104-22	7314150294381	1	505
NS104-24	7314150284795	1	505
NS104-25	7314150294398	1	505
NS104-26	7314150294404	1	505
NS104-27	7314150284801	1	505
NS104-28	7314150294411	1	505
NS104-29	7314150294428	1	505
NS104-30	7314150284818	1	505
NS104-31	7314150294435	1	505
NS104-32	7314150284825	1	505
NS104-33	7314150294442	1	505
NS104-34	7314150294459	1	505
NS104-35	7314150294466	1	505
NS104-36	7314150284832	1	505
NS104-37	7314150294473	1	505
NS104-38	7314150294480	1	505
NS104-39	7314150294497	1	505
NS104-40	7314150294503	1	505
NS104-41	7314150284849	1	505
NS104-42	7314150294510	1	505
NS104-43	7314150294527	1	505
NS104-44	7314150294534	1	505
NS104-45	7314150294541	1	505
NS104-46	7314150284856	1	505
NS104-47	7314150294558	1	505
NS104-48	7314150294565	1	505
NS104-49	7314150294572	1	505
NS104-50	7314150284863	1	505
NS104-51	7314150294589	1	505
NS104-52	7314150294596	1	505
NS104-53	7314150294602	1	505
NS104-54	7314150294619	1	505
NS104-55	7314150284870	1	505
NS104-56	7314150294626	1	505
NS104-57	7314150294633	1	505
NS104-58	7314150294640	1	505
NS104-59	7314150294657	1	505
NS104-60	7314150284887	1	505
NS104-61	7314150294664	1	505
NS104-62	7314150294671	1	505
NS104-63	7314150294688	1	505
NS104-64	7314150294695	1	505
NS104-65	7314150294701	1	505
NS104-66	7314150294718	1	505
NS104-67	7314150294725	1	505
NS104-68	7314150294732	1	505
NS104-69	7314150294749	1	505
NS104-70	7314150284894	1	505
NS104-71	7314150294756	1	505
NS104-72	7314150294763	1	505
NS104-73	7314150294770	1	505
NS104-74	7314150294787	1	505
NS104-75	7314150284900	1	505
NS104-76	7314150294794	1	505
NS104-77	7314150294800	1	505
NS104-78	7314150294817	1	505
NS104-79	7314150294824	1	505
NS104-80	7314150284917	1	505
NS104-81	7314150294831	1	505
NS104-82	7314150294848	1	505
NS104-83	7314150294855	1	505
NS104-84	7314150294862	1	505
NS104-85	7314150284924	1	505





NS104-86	7314150294879	1	505
NS104-87	7314150294886	1	505
NS104-88	7314150294893	1	505
NS104-89	7314150294909	1	505
NS104-90	7314150284931	1	505
NS104-92	7314150294916	1	505
NS104-94	7314150294923	1	505
NS104-95	7314150284948	1	505
NS104-98	7314150294930	1	505
NS106-100	7314150295418	1	506
NS106-104	7314150295425	1	506
NS106-108	7314150295432	1	506
NS106-112	7314150295449	1	506
NS106-114	7314150295456	1	506
NS106-116	7314150295463	1	506
NS106-120	7314150295470	1	506
NS106-124	7314150295487	1	506
NS106-126	7314150295494	1	506
NS106-128	7314150295500	1	506
NS106-132	7314150295517	1	506
NS106-136	7314150295524	1	506
NS106-138	7314150295531	1	506
NS106-144	7314150295548	1	506
NS106-146	7314150295555	1	506
NS106-150	7314150295562	1	506
NS106-156	7314150295579	1	506
NS106-158	7314150295586	1	506
NS106-20	7314150294992	1	506
NS106-22	7314150295005	1	506
NS106-24	7314150295012	1	506
NS106-25	7314150295029	1	506
NS106-26	7314150295036	1	506
NS106-28	7314150295043	1	506
NS106-30	7314150295050	1	506
NS106-32	7314150295067	1	506
NS106-34	7314150295074	1	506
NS106-36	7314150295081	1	506
NS106-38	7314150295098	1	506
NS106-40	7314150295104	1	506
NS106-42	7314150295111	1	506
NS106-44	7314150295128	1	506
NS106-45	7314150295135	1	506
NS106-46	7314150295142	1	506
NS106-48	7314150295159	1	506
NS106-50	7314150295166	1	506
NS106-52	7314150295173	1	506
NS106-54	7314150295180	1	506
NS106-56	7314150295197	1	506
NS106-58	7314150295203	1	506
NS106-60	7314150295210	1	506
NS106-62	7314150295227	1	506
NS106-64	7314150295234	1	506
NS106-66	7314150295241	1	506
NS106-68	7314150295258	1	506
NS106-70	7314150295265	1	506
NS106-71	7314150295272	1	506
NS106-72	7314150295289	1	506
NS106-74	7314150295296	1	506
NS106-76	7314150295302	1	506
NS106-78	7314150295319	1	506
NS106-80	7314150295326	1	506
NS106-82	7314150295333	1	506
NS106-84	7314150295340	1	506
NS106-88	7314150295357	1	506
NS106-90	7314150295364	1	506
NS106-92	7314150295371	1	506
NS106-94	7314150295388	1	506
NS106-96	7314150295395	1	506
NS106-98	7314150295401	1	506
NS200-1200	7314150295661	1	506
NS200-200	7314150295593	1	506
NS200-250	7314150295609	1	506
NS200-300	7314150295616	1	506
NS200-350	7314150295623	1	506
NS200-450	7314150295630	1	506
NS200-600	7314150295647	1	506
NS200-900	7314150295654	1	506
NS202-350	7314150299690	1	507
NS203-200	7314150359509	1	507
NS203-215	7314150359516	1	507
NS203-290	7314150359523	1	507
NS203-400	7314150359530	1	507
NS203-490	7314150359547	1	507
NS203-800	7314150359554	1	507
NS204-30	7314150295685	1	507
NS204-32	7314150295692	1	507
NS204-35	7314150295708	1	507
NS204-40	7314150295715	1	507
NS204-45	7314150295722	1	507
NS204-48	7314150295739	1	507
NS204-50	7314150295746	1	507
NS204-55	7314150295753	1	507
NS204-60	7314150295760	1	507
NS204-65	7314150295777	1	507
NS204-70	7314150295784	1	507
NS204-75	7314150295791	1	507



NS204-80	7314150295807	1	507
NS204-85	7314150295814	1	507
NS204-90	7314150295821	1	507
NS220-06	7314150347216	1	507
NS220-07	7314150347223	1	507
NS220-08	7314150347230	1	507
NS220-09	7314150347247	1	507
NS220-10	7314150347254	1	507
NS220-11	7314150347261	1	507
NS220-12	7314150347278	1	507
NS220-13	7314150347285	1	507
NS220-14	7314150347292	1	507
NS220-15	7314150347308	1	507
NS220-16	7314150347315	1	507
NS220-17	7314150347322	1	507
NS220-18	7314150347339	1	507
NS220-19	7314150347346	1	507
NS220-20	7314150347353	1	507
NS220-21	7314150347360	1	507
NS220-22	7314150347377	1	507
NS220-23	7314150347384	1	507
NS220-24	7314150347391	1	507
NS220-25	7314150347407	1	507
NS220-26	7314150347414	1	507
NS220-27	7314150347421	1	507
NS220-28	7314150347438	1	507
NS220-29	7314150347445	1	507
NS220-30	7314150347452	1	507
NS220-32	7314150347469	1	507
NS224-17	7314150355525	1	508
NS224-18	7314150355532	1	508
NS224-19	7314150355549	1	508
NS224-21	7314150355556	1	508
NS224-22	7314150355563	1	508
NS224-23	7314150355570	1	508
NS224-24	7314150355587	1	508
NS224-26	7314150355594	1	508
NS224-27	7314150355617	1	508
NS224-28	7314150355624	1	508
NS224-29	7314150355631	1	508
NS224-30	7314150355648	1	508
NS224-32	7314150355655	1	508
NS224-34	7314150355662	1	508
NS224-36	7314150355679	1	508
NS224-38	7314150355686	1	508
NS224-41	7314150355693	1	508
NS224-46	7314150355709	1	508
NS224-50	7314150355716	1	508
NS228-22	7314150355914	1	508
NS228-24	7314150355921	1	508
NS228-26	7314150355938	1	508
NS228-27	7314150355945	1	508
NS228-28	7314150355952	1	508
NS228-29	7314150355969	1	508
NS228-30	7314150355976	1	508
NS228-31	7314150355983	1	508
NS228-32	7314150355990	1	508
NS228-34	7314150356003	1	508
NS228-36	7314150356010	1	508
NS228-38	7314150356027	1	508
NS228-41	7314150356034	1	508
NS228-46	7314150356041	1	508
NS228-50	7314150356058	1	508
NS228-55	7314150356065	1	508
NS228-60	7314150356072	1	508
NS228-65	7314150356089	1	508
NS228-70	7314150356096	1	508
NS228-75	7314150356102	1	508
NS228-80	7314150356119	1	508
NS232-16-24	7314150356331	1	509
NS232-24-16	7314150356355	1	509
NS232-24-32	7314150356348	1	509
NS232-32-24	7314150356362	1	509
NS234-16-100	7314150356416	1	509
NS234-16-200	7314150356423	1	509
NS234-16-250	7314150356430	1	509
NS234-24-200	7314150356447	1	509
NS234-32-250	7314150356454	1	509
NS236-16	7314150356522	1	509
NS236-24	7314150356539	1	509
NS236-32	7314150356515	1	509
NS238-16-250	7314150356577	1	509
NS238-24-250	7314150356584	1	509
NS238-32-300	7314150356591	1	509
NS240-16-230	7314150356737	1	509
NS242-16	7314150356638	1	510
NS242-24	7314150356645	1	510
NS242-32	7314150356652	1	510
NS243-16-400	7314150356690	1	510
NS247-26	7314150356751	1	510
NS248-16-52	7314150356713	1	510
NS300-10-200	7314150317783	1	511
NS300-10-300	7314150316205	1	511
NS300-11-250	7314150317790	1	511
NS300-11-300	7314150317806	1	511
NS300-11-350	7314150316212	1	511



NS300-12-400	7314150325153	1	511
NS300-13-450	7314150325160	1	511
NS300-3-50	7314150317677	1	511
NS300-3-75	7314150317684	1	511
NS300-4-75	7314150317691	1	511
NS300-4.5-100	7314150316175	1	511
NS300-4.5-50	7314150317707	1	511
NS300-5-100	7314150317721	1	511
NS300-5-75	7314150317714	1	511
NS300-6-100	7314150316182	1	511
NS300-6-125	7314150317738	1	511
NS300-6-150	7314150317745	1	511
NS300-7-150	7314150317752	1	511
NS300-8-150	7314150316199	1	511
NS300-8-200	7314150317769	1	511
NS300-9-250	7314150317776	1	511
NS301-10-200	7314150317882	1	511
NS301-10-300	7314150317899	1	511
NS301-3-50	7314150317813	1	511
NS301-4-100	7314150317820	1	511
NS301-4-150	7314150317837	1	511
NS301-5-100	7314150317844	1	511
NS301-5-200	7314150317851	1	511
NS301-6-100	7314150317868	1	511
NS301-8-150	7314150317875	1	511
NS302-0-50	7314150316229	1	511
NS302-1-100	7314150316236	1	511
NS302-2-125	7314150316243	1	511
NS302-3-150	7314150316250	1	511
NS302-4-300	7314150316267	1	511
NS304-0-50	7314150316274	1	511
NS304-1-100	7314150316281	1	511
NS304-2-125	7314150316298	1	511
NS304-3-150	7314150316304	1	511
NS304-4-300	7314150316311	1	511
NS320-10	7314150318162	1	512
NS320-2	7314150318087	1	512
NS320-3	7314150318094	1	512
NS320-4	7314150318100	1	512
NS320-5	7314150318117	1	512
NS320-6	7314150318124	1	512
NS320-7	7314150318131	1	512
NS320-8	7314150318148	1	512
NS320-9	7314150318155	1	512
NS400-160	7314150316106	1	512
NS400-180	7314150316113	1	512
NS400-200	7314150316120	1	512
NS402-160	7314150316137	1	512
NS402-200	7314150325177	1	512
NS403-160	7314150318209	1	512
NS403-180	7314150318193	1	512
NS404-160	7314150318216	1	513
NS405-160	7314150318247	1	513
NS406-160	7314150316144	1	513
NS406-180	7314150318261	1	513
NS406-200	7314150316151	1	513
NS407-160	7314150318278	1	513
NS408-250	7314150316168	1	513
NS408-300	7314150318292	1	513
NS411-200	7314150318322	1	513
NS412-200	7314150318339	1	512
NS413-180	7314150318384	1	514
NS413-200	7314150318377	1	514
NS500-1000-FB	7314150296019	1	515
NS500-1500-FB	7314150296026	1	515
NS500-2000	7314150291847	1	514
NS500-2000-FB	7314150284955	1	515
NS500-2500	7314150291854	1	514
NS500-2500-FB	7314150284962	1	515
NS500-3000	7314150291861	1	514
NS500-3000-FB	7314150284979	1	515
NS500-3500-FB	7314150284986	1	515
NS500-4000	7314150291878	1	514
NS502-1000-FB	7314150284993	1	514
NS502-10000-FB	7314150285068	1	514
NS502-12000-FB	7314150318407	1	514
NS502-1500-FB	7314150318438	1	514
NS502-2000-FB	7314150285006	1	514
NS502-2500-FB	7314150285013	1	514
NS502-3000-FB	7314150285020	1	514
NS502-450-FB	7314150296033	1	514
NS502-4500-FB	7314150285037	1	514
NS502-5000-FB	7314150285044	1	514
NS502-6800-FB	7314150318445	1	514
NS502-8000-FB	7314150285051	1	514
NS504-100-FB	7314150296040	1	514
NS504-1000-FB	7314150285099	1	514
NS504-1500-FB	7314150285105	1	514
NS504-200-FB	7314150296057	1	514
NS504-2000-FB	7314150285112	1	514
NS504-300-FB	7314150296064	1	514
NS504-500-FB	7314150285075	1	514
NS504-800-FB	7314150285082	1	514
NS506-300	7314150285129	1	514
NS506-300-FB	7314150318469	1	515
NS506-450	7314150285136	1	514



NS506-450-FB	7314150318476	1	515
NS506-700	7314150296071	1	514
NS506-700-FB	7314150285143	1	515
NS506-900	7314150296088	1	514
NS506-900-FB	7314150285150	1	515
NS508-500-FB	7314150318544	1	514
NS508-700-FB	7314150318537	1	514
NS512-200-FB	7314150318568	1	514
NS512-400-FB	7314150318575	1	514
NS512-600-FB	7314150318582	1	514
NS512-900-FB	7314150318599	1	514
NS600-100-50	7314150296101	1	516
NS600-135-50	7314150296118	1	516
NS600-150-25	7314150296125	1	516
NS600-150-30	7314150301676	1	516
NS600-150-40	7314150296132	1	516
NS600-150-50	7314150296149	1	516
NS600-180-13	7314150296156	1	516
NS600-180-32	7314150285167	1	516
NS600-180-50	7314150285174	1	516
NS600-200-20	7314150296163	1	516
NS600-200-30	7314150296170	1	516
NS600-200-40	7314150296187	1	516
NS600-200-50	7314150301782	1	516
NS600-230-40	7314150296194	1	516
NS600-250-40	7314150296200	1	516
NS600-300-50	7314150296217	1	516
NS600-80-13	7314150296095	1	516
NS602-460	7314150285181	1	516
NS602-600	7314150285198	1	516
NS602-760	7314150296224	1	516
NS602-900	7314150296231	1	516
NS604-150	7314150296248	1	516
NS604-200	7314150285204	1	516
NS604-300	7314150285211	1	516
NS606-150	7314150285228	1	516
NS606-200	7314150285235	1	516
NS606-250	7314150285242	1	516
NS606-300	7314150285259	1	516
NS606-400	7314150285266	1	516
NS608-100	7314150285273	1	517
NS700-300	7314150325184	1	517
NS702-200	7314150325191	1	517
NS704-225	7314150325207	1	517
NS706-50	7314150325214	1	518
NS706-80	7314150325221	1	518
NS708-360	7314150325238	1	518
NS710-450	7314150325245	1	518
NS800-1100	7314150296323	1	518
NS800-1700	7314150285280	1	518
NS800-2000	7314150296330	1	518
NS802-290	7314150285297	1	518
NS804-290	7314150296347	1	519
NS810-100	7314150318728	1	519
NS810-150	7314150318711	1	519
NS810-200	7314150318704	1	519
NS810-350	7314150318698	1	519
NSB001-150	7314150292509	1	502
NSB001-200	7314150284689	1	502
NSB001-250	7314150284696	1	502
NSB001-300	7314150284702	1	502
NSB001-375	7314150292516	1	502
NSB001-450	7314150292523	1	502
NSB001-600	7314150292530	1	502
NSB001-900	7314150292547	1	502
NSB002-10	7314150316366	5	502
NSB002-11	7314150316373	5	502
NSB002-12	7314150316380	5	502
NSB002-13	7314150316397	5	502
NSB002-14	7314150316403	5	502
NSB002-15	7314150316410	5	502
NSB002-16	7314150316427	5	502
NSB002-17	7314150316434	5	502
NSB002-18	7314150316441	5	502
NSB002-19	7314150316458	5	502
NSB002-20	7314150316465	5	502
NSB002-21	7314150316472	5	502
NSB002-22	7314150316489	5	502
NSB002-23	7314150316496	5	502
NSB002-24	7314150316502	5	502
NSB002-25	7314150316519	5	502
NSB002-26	7314150316526	5	502
NSB002-27	7314150316533	5	502
NSB002-28	7314150316540	5	502
NSB002-29	7314150316557	5	502
NSB002-30	7314150316564	5	502
NSB002-31	7314150321728	1	502
NSB002-32	7314150316571	10	502
NSB002-33	7314150321735	1	502
NSB002-34	7314150321742	1	502
NSB002-35	7314150321759	1	502
NSB002-36	7314150321766	1	502
NSB002-38	7314150321773	1	502
NSB002-40	7314150321780	1	502
NSB002-41	7314150321797	1	502
NSB002-42	7314150321803	1	502





NSB002-46	7314150321810	1	502
NSB002-50	7314150321827	1	502
NSB002-52	7314150321834	1	502
NSB002-55	7314150321841	1	502
NSB002-6	7314150316328	5	502
NSB002-60	7314150321858	1	502
NSB002-65	7314150321865	1	502
NSB002-7	7314150316335	5	502
NSB002-70	7314150321872	1	502
NSB002-75	7314150321889	1	502
NSB002-8	7314150316342	5	502
NSB002-80	7314150321896	1	502
NSB002-9	7314150316359	5	502
NSB006-0607	7314150316588	1	503
NSB006-0608	7314150321926	1	503
NSB006-0708	7314150321933	1	503
NSB006-0709	7314150321940	1	503
NSB006-0809	7314150316595	1	503
NSB006-0810	7314150321957	1	503
NSB006-0910	7314150321964	1	503
NSB006-0911	7314150321971	1	503
NSB006-1011	7314150316601	1	503
NSB006-1012	7314150322015	1	503
NSB006-1013	7314150322022	1	503
NSB006-1014	7314150322039	1	503
NSB006-1113	7314150322046	1	503
NSB006-1114	7314150322053	1	503
NSB006-1213	7314150316618	1	503
NSB006-1214	7314150322060	1	503
NSB006-1315	7314150322077	1	503
NSB006-1415	7314150316625	1	503
NSB006-1416	7314150322084	1	503
NSB006-1417	7314150322091	1	503
NSB006-1617	7314150316632	1	503
NSB006-1618	7314150322107	1	503
NSB006-1719	7314150322114	1	503
NSB006-1722	7314150322121	1	503
NSB006-1819	7314150316649	1	503
NSB006-1820	7314150322138	1	503
NSB006-1920	7314150322145	1	503
NSB006-1922	7314150322152	1	503
NSB006-1924	7314150322169	1	503
NSB006-2022	7314150316656	1	503
NSB006-2122	7314150322176	1	503
NSB006-2123	7314150316663	1	503
NSB006-2223	7314150322183	1	503
NSB006-2224	7314150322190	1	503
NSB006-2227	7314150322206	1	503
NSB006-2326	7314150322213	1	503
NSB006-2425	7314150322220	1	503
NSB006-2426	7314150316670	1	503
NSB006-2427	7314150322237	1	503
NSB006-2430	7314150322244	1	503
NSB006-2528	7314150316687	1	503
NSB006-2629	7314150322251	1	503
NSB006-2729	7314150316694	1	503
NSB006-2730	7314150322336	1	503
NSB006-2732	7314150322343	1	503
NSB006-2830	7314150322350	1	503
NSB006-3031	7314150322367	1	503
NSB006-3032	7314150316700	1	503
NSB006-3034	7314150322374	1	503
NSB006-3036	7314150322381	1	503
NSB006-3234	7314150322398	1	503
NSB006-3235	7314150322404	1	503
NSB006-3236	7314150322411	1	503
NSB006-3335	7314150322428	1	503
NSB006-3436	7314150322435	1	503
NSB006-3536	7314150322442	1	503
NSB006-3638	7314150322459	1	503
NSB006-3641	7314150322466	1	503
NSB006-3642	7314150322473	1	503
NSB006-4146	7314150322480	1	503
NSB006-4650	7314150322497	1	503
NSB006-5052	7314150322503	1	503
NSB006-5055	7314150322510	1	503
NSB006-5060	7314150322527	1	503
NSB006-5062	7314150322534	1	503
NSB006-5560	7314150322558	1	503
NSB006-6065	7314150322565	1	503
NSB006-6570	7314150322572	1	503
NSB010-0607	7314150322589	1	504
NSB010-0709	7314150322596	1	504
NSB010-0809	7314150322602	1	504
NSB010-0911	7314150322619	1	504
NSB010-1011	7314150322626	1	504
NSB010-1012	7314150322633	1	504
NSB010-1214	7314150322640	1	504
NSB010-1315	7314150322657	1	504
NSB010-1417	7314150322664	1	504
NSB010-1618	7314150322671	1	504
NSB010-1719	7314150322688	1	504
NSB010-1722	7314150322695	1	504
NSB010-1819	7314150322718	1	504
NSB010-1921	7314150322725	1	504
NSB010-1922	7314150322732	1	504



NSB010-2022	7314150322749	1	504
NSB010-2123	7314150322756	1	504
NSB010-2224	7314150322763	1	504
NSB010-2427	7314150322770	1	504
NSB010-2528	7314150322787	1	504
NSB010-2628	7314150322794	1	504
NSB010-2730	7314150322800	1	504
NSB010-2732	7314150322817	1	504
NSB010-3032	7314150322824	1	504
NSB010-3036	7314150322831	1	504
NSB010-3236	7314150322848	1	504
NSB010-3641	7314150322855	1	504
NSB010-4146	7314150322862	1	504
NSB010-4650	7314150322879	1	504
NSB011-0607	7314150317400	1	504
NSB011-0809	7314150317417	1	504
NSB011-1011	7314150317424	1	504
NSB011-1213	7314150317431	1	504
NSB011-1415	7314150317448	1	504
NSB011-1617	7314150317455	1	504
NSB011-1819	7314150317462	1	504
NSB011-2022	7314150317479	1	504
NSB011-2123	7314150317486	1	504
NSB011-2426	7314150317493	1	504
NSB011-2528	7314150317509	1	504
NSB011-2729	7314150317516	1	504
NSB011-3032	7314150317523	1	504
NSB100-100	7314150323302	1	505
NSB100-105	7314150323319	1	505
NSB100-110	7314150323326	1	505
NSB100-115	7314150323333	1	505
NSB100-120	7314150323340	1	505
NSB100-17	7314150322886	1	504
NSB100-19	7314150322893	1	504
NSB100-22	7314150322909	1	504
NSB100-24	7314150322916	1	504
NSB100-25	7314150322923	1	504
NSB100-27	7314150322930	1	504
NSB100-28	7314150322947	1	504
NSB100-29	7314150322954	1	504
NSB100-30	7314150322961	1	504
NSB100-32	7314150322978	1	504
NSB100-33	7314150322985	1	504
NSB100-34	7314150322992	1	504
NSB100-35	7314150323005	1	504
NSB100-36	7314150323012	1	504
NSB100-37	7314150323029	1	504
NSB100-38	7314150323036	1	504
NSB100-41	7314150323043	1	504
NSB100-42	7314150323050	1	504
NSB100-45	7314150323067	1	504
NSB100-46	7314150323074	1	504
NSB100-47	7314150323081	1	504
NSB100-50	7314150323098	1	504
NSB100-52	7314150323104	1	504
NSB100-54	7314150323111	1	504
NSB100-55	7314150323128	1	504
NSB100-56	7314150323135	1	504
NSB100-58	7314150323142	1	504
NSB100-60	7314150323159	1	504
NSB100-63	7314150323166	1	505
NSB100-65	7314150323173	1	505
NSB100-67	7314150323180	1	505
NSB100-70	7314150323197	1	505
NSB100-71	7314150323203	1	505
NSB100-75	7314150323210	1	505
NSB100-77	7314150323227	1	505
NSB100-80	7314150323234	1	505
NSB100-82	7314150323241	1	505
NSB100-85	7314150323258	1	505
NSB100-88	7314150323265	1	505
NSB100-90	7314150323272	1	505
NSB100-94	7314150323289	1	505
NSB100-95	7314150323296	1	505
NSB104-100	7314150316885	1	505
NSB104-105	7314150316892	1	505
NSB104-110	7314150316908	1	505
NSB104-115	7314150323937	1	505
NSB104-120	7314150316915	1	505
NSB104-17	7314150323357	1	505
NSB104-19	7314150323364	1	505
NSB104-20	7314150323371	1	505
NSB104-22	7314150323388	1	505
NSB104-24	7314150316717	1	505
NSB104-25	7314150323395	1	505
NSB104-26	7314150323401	1	505
NSB104-27	7314150316724	1	505
NSB104-28	7314150323418	1	505
NSB104-29	7314150323425	1	505
NSB104-30	7314150316731	1	505
NSB104-31	7314150323432	1	505
NSB104-32	7314150316748	1	505
NSB104-33	7314150323449	1	505
NSB104-34	7314150323456	1	505
NSB104-35	7314150323463	1	505
NSB104-36	7314150316755	1	505



NSB104-37	7314150323470	1	505
NSB104-38	7314150323487	1	505
NSB104-39	7314150323494	1	505
NSB104-40	7314150323500	1	505
NSB104-41	7314150316762	1	505
NSB104-42	7314150323517	1	505
NSB104-43	7314150323524	1	505
NSB104-44	7314150323531	1	505
NSB104-45	7314150323548	1	505
NSB104-46	7314150316779	1	505
NSB104-47	7314150323555	1	505
NSB104-48	7314150323562	1	505
NSB104-49	7314150323579	1	505
NSB104-50	7314150316786	1	505
NSB104-51	7314150323586	1	505
NSB104-52	7314150323593	1	505
NSB104-53	7314150323609	1	505
NSB104-54	7314150323616	1	505
NSB104-55	7314150316793	1	505
NSB104-56	7314150323623	1	505
NSB104-57	7314150323630	1	505
NSB104-58	7314150323647	1	505
NSB104-59	7314150323654	1	505
NSB104-60	7314150316809	1	505
NSB104-61	7314150323661	1	505
NSB104-62	7314150323678	1	505
NSB104-63	7314150323685	1	505
NSB104-64	7314150323692	1	505
NSB104-65	7314150316816	1	505
NSB104-66	7314150323708	1	505
NSB104-67	7314150323715	1	505
NSB104-68	7314150323722	1	505
NSB104-69	7314150323739	1	505
NSB104-70	7314150316823	1	505
NSB104-71	7314150323746	1	505
NSB104-72	7314150323753	1	505
NSB104-73	7314150323760	1	505
NSB104-74	7314150323777	1	505
NSB104-75	7314150316830	1	505
NSB104-76	7314150323784	1	505
NSB104-77	7314150323791	1	505
NSB104-78	7314150323807	1	505
NSB104-79	7314150323814	1	505
NSB104-80	7314150316847	1	505
NSB104-81	7314150323821	1	505
NSB104-82	7314150323838	1	505
NSB104-83	7314150323845	1	505
NSB104-84	7314150323852	1	505
NSB104-85	7314150316854	1	505
NSB104-86	7314150323869	1	505
NSB104-87	7314150323876	1	505
NSB104-88	7314150323883	1	505
NSB104-89	7314150323890	1	505
NSB104-90	7314150316861	1	505
NSB104-92	7314150323906	1	505
NSB104-94	7314150323913	1	505
NSB104-95	7314150316878	1	505
NSB104-98	7314150323920	1	505
NSB106-100	7314150324361	1	506
NSB106-104	7314150324378	1	506
NSB106-108	7314150324385	1	506
NSB106-112	7314150324392	1	506
NSB106-114	7314150324408	1	506
NSB106-116	7314150324415	1	506
NSB106-120	7314150324422	1	506
NSB106-124	7314150324439	1	506
NSB106-126	7314150324446	1	506
NSB106-128	7314150324453	1	506
NSB106-132	7314150324460	1	506
NSB106-136	7314150324477	1	506
NSB106-138	7314150324484	1	506
NSB106-144	7314150324491	1	506
NSB106-146	7314150324507	1	506
NSB106-150	7314150324514	1	506
NSB106-156	7314150324521	1	506
NSB106-158	7314150324538	1	506
NSB106-20	7314150323944	1	506
NSB106-22	7314150323951	1	506
NSB106-24	7314150323968	1	506
NSB106-25	7314150323975	1	506
NSB106-26	7314150323982	1	506
NSB106-28	7314150323999	1	506
NSB106-30	7314150324002	1	506
NSB106-32	7314150324019	1	506
NSB106-34	7314150324026	1	506
NSB106-36	7314150324033	1	506
NSB106-38	7314150324040	1	506
NSB106-40	7314150324057	1	506
NSB106-42	7314150324064	1	506
NSB106-44	7314150324071	1	506
NSB106-45	7314150324088	1	506
NSB106-46	7314150324095	1	506
NSB106-48	7314150324101	1	506
NSB106-50	7314150324118	1	506
NSB106-52	7314150324125	1	506
NSB106-54	7314150324132	1	506



NSB106-56	7314150324149	1	506
NSB106-58	7314150324156	1	506
NSB106-60	7314150324163	1	506
NSB106-62	7314150324170	1	506
NSB106-64	7314150324187	1	506
NSB106-66	7314150324194	1	506
NSB106-68	7314150324200	1	506
NSB106-70	7314150324217	1	506
NSB106-71	7314150324224	1	506
NSB106-72	7314150324231	1	506
NSB106-74	7314150324248	1	506
NSB106-76	7314150324255	1	506
NSB106-78	7314150324262	1	506
NSB106-80	7314150324279	1	506
NSB106-82	7314150324286	1	506
NSB106-84	7314150324293	1	506
NSB106-88	7314150324309	1	506
NSB106-90	7314150324316	1	506
NSB106-92	7314150324323	1	506
NSB106-94	7314150324330	1	506
NSB106-96	7314150324347	1	506
NSB106-98	7314150324354	1	506
NSB200-1200	7314150324613	1	506
NSB200-200	7314150324545	1	506
NSB200-250	7314150324552	1	506
NSB200-300	7314150324569	1	506
NSB200-350	7314150324576	1	506
NSB200-450	7314150324583	1	506
NSB200-600	7314150324590	1	506
NSB200-900	7314150324606	1	507
NSB202-350	7314150324620	1	507
NSB203-200	7314150359561	1	507
NSB203-215	7314150359578	1	507
NSB203-290	7314150359585	1	507
NSB203-400	7314150359592	1	507
NSB203-490	7314150359608	1	507
NSB203-800	7314150359615	1	507
NSB204-30	7314150324637	1	507
NSB204-32	7314150324644	1	507
NSB204-35	7314150324651	1	507
NSB204-40	7314150324668	1	507
NSB204-45	7314150324675	1	507
NSB204-48	7314150324682	1	507
NSB204-50	7314150324699	1	507
NSB204-55	7314150324705	1	507
NSB204-60	7314150324712	1	507
NSB204-65	7314150324729	1	507
NSB204-70	7314150324736	1	507
NSB204-75	7314150324743	1	507
NSB204-80	7314150324750	1	507
NSB204-85	7314150324767	1	507
NSB204-90	7314150324774	1	507
NSB220-06	7314150354023	1	508
NSB220-07	7314150354030	1	508
NSB220-08	7314150354047	1	508
NSB220-09	7314150354054	1	508
NSB220-10	7314150354061	1	508
NSB220-11	7314150354078	1	508
NSB220-12	7314150354085	1	508
NSB220-13	7314150354092	1	508
NSB220-14	7314150354108	1	508
NSB220-15	7314150354115	1	508
NSB220-16	7314150354122	1	508
NSB220-17	7314150354139	1	508
NSB220-18	7314150354146	1	508
NSB220-19	7314150354153	1	508
NSB220-20	7314150354160	1	508
NSB220-21	7314150354177	1	508
NSB220-22	7314150354184	1	508
NSB220-23	7314150354191	1	508
NSB220-24	7314150354207	1	508
NSB220-25	7314150354214	1	508
NSB220-26	7314150354221	1	508
NSB220-27	7314150354238	1	508
NSB220-28	7314150354245	1	508
NSB220-29	7314150354252	1	508
NSB220-30	7314150354269	1	508
NSB220-32	7314150354276	1	508
NSB224-17	7314150355723	1	508
NSB224-18	7314150355730	1	508
NSB224-19	7314150355747	1	508
NSB224-21	7314150355754	1	508
NSB224-22	7314150355761	1	508
NSB224-23	7314150355778	1	508
NSB224-24	7314150355785	1	508
NSB224-26	7314150355792	1	508
NSB224-27	7314150355808	1	508
NSB224-28	7314150355815	1	508
NSB224-29	7314150355822	1	508
NSB224-30	7314150355839	1	508
NSB224-32	7314150355846	1	508
NSB224-34	7314150355853	1	508
NSB224-36	7314150355860	1	508
NSB224-38	7314150355877	1	508
NSB224-41	7314150355884	1	508
NSB224-46	7314150355891	1	508





NSB224-50	7314150355907	1	508
NSB228-22	7314150356126	1	508
NSB228-24	7314150356133	1	508
NSB228-26	7314150356140	1	508
NSB228-27	7314150356157	1	508
NSB228-28	7314150356164	1	508
NSB228-29	7314150356171	1	508
NSB228-30	7314150356188	1	508
NSB228-31	7314150356195	1	508
NSB228-32	7314150356201	1	508
NSB228-34	7314150356218	1	508
NSB228-36	7314150356225	1	508
NSB228-38	7314150356232	1	508
NSB228-41	7314150356249	1	508
NSB228-46	7314150356256	1	508
NSB228-50	7314150356263	1	508
NSB228-55	7314150356270	1	508
NSB228-60	7314150356287	1	508
NSB228-65	7314150356294	1	508
NSB228-70	7314150356300	1	508
NSB228-75	7314150356317	1	508
NSB228-80	7314150356324	1	508
NSB232-16-24	7314150356379	1	509
NSB232-24-16	7314150356393	1	509
NSB232-24-32	7314150356386	1	509
NSB232-32-24	7314150356409	1	509
NSB234-16-100	7314150356461	1	509
NSB234-16-200	7314150356478	1	509
NSB234-16-250	7314150356485	1	509
NSB234-24-200	7314150356492	1	509
NSB234-32-250	7314150356508	1	509
NSB236-16	7314150356553	1	509
NSB236-24	7314150356546	1	509
NSB236-32	7314150356560	1	509
NSB238-16-250	7314150356621	1	509
NSB238-24-250	7314150356614	1	509
NSB238-32-300	7314150356607	1	509
NSB240-16-230	7314150356744	1	510
NSB242-16	7314150356669	1	510
NSB242-24	7314150356676	1	510
NSB242-32	7314150356683	1	510
NSB243-16-400	7314150356706	1	510
NSB247-26	7314150356768	1	510
NSB248-16-52	7314150356720	1	510
NSB300-10-200	7314150317646	1	511
NSB300-10-300	7314150295845	1	511
NSB300-11-250	7314150317653	1	511
NSB300-11-300	7314150317660	1	511
NSB300-11-350	7314150295852	1	511
NSB300-12-400	7314150295869	1	511
NSB300-13-450	7314150295876	1	511
NSB300-3-50	7314150317530	1	511
NSB300-3-75	7314150317547	1	511
NSB300-4-75	7314150317554	1	511
NSB300-4.5-100	7314150295838	1	511
NSB300-4.5-50	7314150317561	1	511
NSB300-5-100	7314150317585	1	511
NSB300-5-75	7314150317578	1	511
NSB300-6-100	7314150285327	1	511
NSB300-6-125	7314150317592	1	511
NSB300-6-150	7314150317608	1	511
NSB300-7-150	7314150317615	1	511
NSB300-8-150	7314150285334	1	511
NSB300-8-200	7314150317622	1	511
NSB300-9-250	7314150317639	1	511
NSB301-10-200	7314150317974	1	511
NSB301-10-300	7314150317981	1	511
NSB301-3-50	7314150317905	1	511
NSB301-4-100	7314150317912	1	511
NSB301-4-150	7314150317929	1	511
NSB301-5-100	7314150317936	1	511
NSB301-5-200	7314150317943	1	511
NSB301-6-100	7314150317950	1	511
NSB301-8-150	7314150317967	1	511
NSB302-0-50	7314150295883	1	511
NSB302-1-100	7314150285341	1	511
NSB302-2-125	7314150285358	1	511
NSB302-3-150	7314150295890	1	511
NSB302-4-300	7314150295906	1	511
NSB304-0-50	7314150295913	1	512
NSB304-1-100	7314150295920	1	512
NSB304-2-125	7314150295937	1	512
NSB304-3-150	7314150295944	1	512
NSB304-4-300	7314150295951	1	512
NSB320-10	7314150318070	1	512
NSB320-2	7314150317998	1	512
NSB320-3	7314150318001	1	512
NSB320-4	7314150318018	1	512
NSB320-5	7314150318025	1	512
NSB320-6	7314150318032	1	512
NSB320-7	7314150318049	1	512
NSB320-8	7314150318056	1	512
NSB320-9	7314150318063	1	512
NSB400-160	7314150295968	1	512
NSB400-180	7314150285365	1	512
NSB400-200	7314150295975	1	512



NSB402-160	7314150295982	1	512
NSB402-200	7314150285372	1	512
NSB403-160	7314150318179	1	513
NSB403-180	7314150318186	1	513
NSB404-160	7314150318223	1	513
NSB405-160	7314150318230	1	513
NSB406-160	7314150295999	1	513
NSB406-180	7314150318254	1	513
NSB406-200	7314150296002	1	513
NSB407-160	7314150318285	1	513
NSB408-250	7314150285389	1	513
NSB408-300	7314150318308	1	513
NSB411-200	7314150318315	1	514
NSB412-200	7314150318346	1	512
NSB413-180	7314150318353	1	514
NSB413-200	7314150318360	1	514
NSB500-1000-FB	7314150324828	1	515
NSB500-1500-FB	7314150324835	1	515
NSB500-2000	7314150324781	1	515
NSB500-2000-FB	7314150324842	1	515
NSB500-2500	7314150324798	1	515
NSB500-2500-FB	7314150324859	1	515
NSB500-3000	7314150324804	1	515
NSB500-3000-FB	7314150324866	1	515
NSB500-3500-FB	7314150324873	1	515
NSB500-4000	7314150324811	1	515
NSB502-1000-FB	7314150316922	1	515
NSB502-10000-FB	7314150316991	1	515
NSB502-12000-FB	7314150318414	1	515
NSB502-1500-FB	7314150318421	1	515
NSB502-2000-FB	7314150316939	1	515
NSB502-2500-FB	7314150316946	1	515
NSB502-3000-FB	7314150316953	1	515
NSB502-450-FB	7314150324880	1	515
NSB502-4500-FB	7314150316960	1	515
NSB502-5000-FB	7314150316977	1	515
NSB502-6800-FB	7314150318452	1	515
NSB502-8000-FB	7314150316984	1	515
NSB504-100-FB	7314150317004	1	515
NSB504-1000-FB	7314150317059	1	515
NSB504-1500-FB	7314150317066	1	515
NSB504-200-FB	7314150317011	1	515
NSB504-2000-FB	7314150317073	1	515
NSB504-300-FB	7314150317028	1	515
NSB504-500-FB	7314150317035	1	515
NSB504-800-FB	7314150317042	1	515
NSB506-300	7314150324897	1	515
NSB506-300-FB	7314150318490	1	516
NSB506-450	7314150324903	1	515
NSB506-450-FB	7314150318483	1	516
NSB506-700	7314150324910	1	516
NSB506-700-FB	7314150317080	1	515
NSB506-900	7314150324927	1	515
NSB506-900-FB	7314150317097	1	516
NSB508-500-FB	7314150318513	1	515
NSB508-700-FB	7314150318520	1	515
NSB512-200-FB	7314150318643	1	515
NSB512-400-FB	7314150318636	1	515
NSB512-600-FB	7314150318629	1	515
NSB512-900-FB	7314150318605	1	515
NSB600-100-50	7314150317110	1	516
NSB600-135-50	7314150317127	1	516
NSB600-150-25	7314150317134	1	516
NSB600-150-30	7314150317141	1	516
NSB600-150-40	7314150317158	1	516
NSB600-150-50	7314150317165	1	516
NSB600-180-13	7314150317172	1	516
NSB600-180-32	7314150317189	1	516
NSB600-180-50	7314150317196	1	516
NSB600-200-20	7314150317202	1	516
NSB600-200-30	7314150317219	1	516
NSB600-200-40	7314150317226	1	516
NSB600-200-50	7314150317233	1	516
NSB600-230-40	7314150317240	1	516
NSB600-250-40	7314150317257	1	516
NSB600-300-50	7314150317264	1	516
NSB600-80-13	7314150317103	1	516
NSB602-460	7314150324934	1	516
NSB602-600	7314150324941	1	516
NSB602-760	7314150324958	1	516
NSB602-900	7314150324965	1	516
NSB604-150	7314150324972	1	516
NSB604-200	7314150324989	1	516
NSB604-300	7314150324996	1	516
NSB606-150	7314150325009	1	517
NSB606-200	7314150325016	1	517
NSB606-250	7314150325023	1	517
NSB606-300	7314150325030	1	517
NSB606-400	7314150325047	1	517
NSB608-100	7314150325054	1	517
NSB700-300	7314150296255	1	517
NSB702-200	7314150296262	1	517
NSB704-225	7314150296279	1	517
NSB706-50	7314150296286	1	518
NSB706-80	7314150296293	1	518
NSB708-360	7314150296309	1	518





NSB710-450	7314150296316	1	518
NSB800-1100	7314150325061	1	518
NSB800-1700	7314150325078	1	518
NSB800-2000	7314150325085	1	518
NSB802-290	7314150325092	1	519
NSB810-100	7314150318650	1	519
NSB810-150	7314150318667	1	519
NSB810-200	7314150318674	1	519
NSB810-350	7314150318681	1	519
P-HB	7314150125272	25	540
P-MEC	7314150374342	24	541
P-MEC-LEAD	7314150374359	12	541
P1-20	7311518044572	5	615
P1-23	7311518332501	5	615
P108-20-F	7311518275518	2	615
P108-23-F	7311518275525	2	615
P11	7311518009076	6	625
P110-20-F	7311518275532	2	615
P110-23-F	7311518275549	2	615
P114-SL-40	7311518301149	2	618
P114-SL-50	7311518301156	2	618
P114-SL-60	7311518301163	2	618
P116-SL-40	7311518301101	2	619
P116-SL-50	7311518301118	2	619
P116-SL-60	7311518301125	2	619
P116-SL-70	7311518301132	2	619
P121-18-F	7311518275662	6	616
P121-20-F	7311518275631	6	616
P121-23-F	7311518275648	6	616
P123-19-BULK15	7311518226251	15	618
P123-19-BULK30	7311518218218	30	618
P123-19-BULK56	7311518240202	56	618
P126-19-F	7311518275297	6	616
P126-22-F	7311518275303	6	616
P127-19-BULK30	7311518199333	30	618
P128-19	7311518160814	6	618
P128-19-BULK30	7311518172329	30	618
P129-19-BULK30	7311518172336	30	618
P130-F	7311518333980	6	619
P134	7311518346775	2	622
P134-BULK	7311518346829	2	622
P138-22-F	7311518301279	6	615
P140-F	7311518275372	6	619
P16-40	7311518013479	2	619
P16-40W	7311518043049	2	619
P16-50-F	7311518301286	2	619
P16-60-F	7311518276461	2	619
P160-SL-60	7311518301170	2	619
P160-SL-75	7311518301187	1	619
P160-SL-90	7311518301194	1	619
P173-SL-85	7311518334703	1	619
P19-80-F	7311518275365	1	619
P20	7311518009281	6	625
P241	7311518008956	5	612
P262	7311518299286	10	611
P263	7311518299262	10	611
P264	7311518299279	10	611
P266	7311518299293	10	612
P267	7311518299309	10	611
P268	7311518299316	10	611
P269	7311518299323	10	612
P270	7311518299330	10	612
P272	7311518299354	5	611
P274	7311518299347	5	612
P276	7311518299361	5	612
P277	7311518299378	5	611
P278	7311518299385	5	611
P280-SL-60	7311518346508	2	619
P280-SL-80	7311518301330	2	619
P3-20-F	7311518275259	2	615
P3-23-F	7311518275266	2	615
P34-27A-F	7311518275464	2	622
P34-37	7311518002787	2	622
P39-22	7311518337988	2	616
P5-20-F	7311518275273	2	615
P5-23-F	7311518275280	2	615
P51-F	7311518275426	2	624
P51-SL	7311518301217	2	624
P51H-SL	7311518301224	2	624
P52-SL-20	7311518347307	2	624
P54-SL-20	7311518301248	2	624
P54-SL-25	7311518301231	2	624
P54H-SL-20	7311518301262	2	624
P54H-SL-25	7311518301255	2	624
P57-25-F	7311518301293	4	624
P57-25-W-F	7311518301309	4	624
P59-25-F	7311518275655	6	625
P6160	7314150115075	1	636
P64-20	7311518288174	6	616
P64-20-BULK12	7311518288204	12	616
P74	7311518124076	1	625
P75	7311518124083	1	625
PAGS-2.0	7311518327835	1	595
PAGS-2.0-900FG	7311518292355	1	595
PBB-8	7314150399376	8	540
PBS-700	7314150341689	6	540



PC-10-DTF	7311518263560	10	562
PC-10-DTL	7311518263553	10	562
PC-10-DTR	7311518263546	10	562
PC-11-19-PS	7311518285548	4	562
PC-11-19-PS-B	7311518285555	10	562
PC-12-14-PS	7311518285562	4	562
PC-12-14-PS-B	7311518285579	10	562
PC-12-COM	7311518263454	4	558
PC-12-TEN	7311518263447	4	561
PC-12-VEN	7311518263430	4	561
PC-15-GNP	7311518263407	4	558
PC-15-TBX	7311518263423	4	561
PC-16-DECO	7311518264987	4	558
PC-16-FILE-U7	7311518263461	4	559
PC-19-FILE-U7	7311518263478	4	559
PC-19-GT7	7311518263362	4	559
PC-19-GT9	7311518263379	4	561
PC-20-LAM	7311518258290	4	560
PC-20-PRC	7311518264291	4	561
PC-22-FILE-U7	7311518263485	4	559
PC-22-GT7	7311518263393	4	559
PC-22-GT9	7311518263409	4	561
PC-22-INS	7314150154500	4	559
PC-22-PLC	7314150276318	4	558
PC-24-FILE-U7	7311518263492	4	559
PC-24-PLS	7311518263508	4	558
PC-24-TIM	7311518263515	4	561
PC-6-DRY	7311518282004	6	558
PC-9-9/17-PS	7311518285586	4	562
PC-9-9/17-PS-B	7311518285593	10	562
PENCIL-200-DISP	7314150125227	1	540
PG-01-F	7311518329334	6	616
PG-03-L	7311518242855	2	616
PG-12-BULK15	7311518334628	15	616
PG-12-F	7311518328122	10	616
PG-18-45-F	7311518299033	2	620
PG-18-60-F	7311518288853	2	619
PG-19-F	7311518295936	2	620
PG-56-F	7311518288938	2	624
PG-57-F	7311518295943	2	624
PG-72	7311518242534	4	627
PG-L2-F	7311518269746	2	616
PG-M2-F	7311518269715	2	616
PG-R-M2-F	7311518269722	2	616
PG-S1-F	7311518327743	2	616
PH-6604-1P	7311518152819	15	37
PH-6604-25	7311518141134	25	37
PROF-H	7311518158439	2	630
PROF-LOPP	7311518288549	1	630
PROF-SEC	7311518288532	1	630
PROF-TL	7311518335991	4	462
PS501-1	7314150338283	1	647
PS501-2	7314150112432	1	647
PS501-3	7314150338290	1	647
PS501-4	7314150338306	1	647
PU-10	7314150016181	5	46
PU-11	7314150016204	5	46
PU-12	7314150016228	5	46
PU-13	7314150016242	5	46
PU-14	7314150016266	5	46
PU-15	7314150016280	5	46
PU-16	7314150016303	5	46
PU-17	7314150016327	5	46
PU-18	7314150016341	5	46
PU-19	7314150016365	5	46
PU-20	7314150016389	3	46
PU-21	7314150016402	3	46
PU-22	7314150016426	3	46
PU-23	7314150016440	3	46
PU-24	7314150016464	3	46
PU-25	7314150016488	1	46
PU-26	7314150016501	1	46
PU-27	7314150016525	1	46
PU-28	7314150016549	1	46
PU-29	7314150016563	1	46
PU-30	7314150016587	1	46
PU-32	7314150016600	1	46
PU-36	7314150016631	1	46
PU-42	7314151839369	1	46
PU-6	7314150016105	5	46
PU-7	7314150016129	5	46
PU-8	7314150016143	5	46
PU-9	7314150016167	5	46
PX-L2	7311518233853	2	614
PX-L3	7311518233860	2	614
PX-M1	7311518233815	2	614
PX-M2	7311518233822	2	614
PX-M2-L	7311518240714	2	614
PX-M3	7311518233839	2	614
PX-S1	7311518233785	2	614
PX-S2	7311518233792	2	614
PXR-L1	7311518233907	2	614
PXR-L2	7311518233914	2	614
PXR-M1	7311518233877	2	614
PXR-M2	7311518233884	2	614
PXR-M2-L	7311518240738	2	614



**PXR-M3**



PXR-M3	7311518233891	2	614
PXR-S1	7311518240677	2	614
PXR-S2	7311518240684	2	614
PXR-S2-L	7311518346799	2	614
QC-115A	7314150460007	10	582
QC-115A-2P	7314150460021	10	582
QC-150A	7314150460045	6	582
QC-150A-2P	7314150460069	6	582
QC-300A	7314150401925	6	582
QC-300A-2P	7314150460090	6	582
QCB-1250	7314150135981	8	582
QCB-150	7314150135912	6	582
QCB-300	7314150135936	6	582
QCB-450	7314150135950	6	582
QCB-600	7314150135967	4	582
QCB-900	7314150135974	4	582
QCG-150	7314150135899	6	582
QCG-300	7314150135905	6	582
R1068	7311518044398	1	617
R1069P	7311518219574	12	617
R1071	7311518222918	14	618
R1075-BULK50	7311518220495	50	618
R1080P	7311518282479	1	618
R112PG	7311518010058	1	617
R113PG	7311518044374	30	617
R114PG	7311518010065	1	617
R114V	7311518042660	25	620
R114V-BULK28	7311518177539	28	620
R115V	7311518243210	8	620
R115V-BULK14	7311518288341	14	620
R116V	7311518010164	1	620
R116V-BULK36	7311518159924	36	620
R116VP	7311518042721	25	620
R119V	7311518029487	1	620
R122PG	7311518010072	30	617
R123PG	7311518044381	30	617
R124PG	7311518010089	30	617
R1269P-BULK50	7311518240820	50	615
R133PG	7311518328252	1	623
R137E	7311518011574	30	622
R142P	7311518010126	24	617
R143PV	7311518010133	1	620
R143PVCB	7311518255633	1	620
R144PV	7311518291075	24	620
R146VC	7311518046545	22	625
R146VS	7311518046538	24	620
R146VS-BULK50	7311518159955	50	620
R147V	7311518044909	24	625
R157H	7311518338824	24	617
R1601	7311518044640	1	618
R160A	7311518201821	1	620
R160A-BULK28	7311518337216	28	620
R166V	7311518328085	22	620
R16V	7311518254513	1	620
R16V-BULK14	7311518288334	14	620
R171P	7311518226534	1	617
R172A	7311518235413	1	620
R180V	7311518042677	20	620
R181P	7311518296087	1	620
R201P	7311518219536	1	617
R201P-BULK80	7311518225209	80	617
R202P	7311518219550	1	617
R211P	7311518234027	1	614
R211P-BULK80	7311518252212	80	614
R214SL	7311518301392	1	620
R214V	7311518042745	1	620
R214V-BULK28	7311518177553	28	620
R215V	7311518243227	1	620
R216SL	7311518301408	8	620
R221P	7311518229412	1	616
R221P-BULK50	7311518240653	50	616
R223P	7311518237554	1	617
R223P-BULK80	7311518240646	80	617
R224P	7311518338220	40	617
R239P	7311518219567	1	617
R260A	7311518201814	16	620
R272H	7311518258016	1	620
R300P	7311518234034	1	614
R303P	7311518234157	1	614
R310-0	7314151829797	1	59
R310-1	7314151829803	1	59
R310-2	7314151829810	1	59
R310-3	7314151829827	1	59
R312V	7311518235420	1	620
R315V	7311518243234	1	620
R318V	7311518029500	1	620
R328V	7311518296056	22	620
R337E	7311518011598	1	623
R341P	7311518011529	12	617
R372H	7311518235406	1	620
R373A	7311518334710	25	620
R403P	7311518234164	1	614
R415V	7311518243241	1	620
R419V	7311518042936	1	620
R427AE	7311518176068	18	623
R430V	7311518243265	1	620



R437E	7311518011611	18	623
R438P	7311518229429	1	617
R438P-BULK50	7311518240660	50	617
R439P	7311518338244	1	617
R440V	7311518254544	22	620
R444V	7311518243340	22	625
R463P	7311518223908	1	617
R474P	7311518011536	1	617
R478P	7311518275600	1	618
R480P	7311518282486	1	618
R500P	7311518234041	40	614
R503P	7311518234171	1	614
R515VS	7311518046514	22	625
R516V	7311518200824	22	625
R519V	7311518029517	1	620
R600P	7311518240783	1	614
R603P	7311518240790	1	614
R615V	7311518010119	1	620
R619V	7311518029494	1	620
R660V	7311518210281	24	620
R6725MK	7314151088354	1	76
R6725ZK	7314151784898	1	76
R680V	7311518042752	1	620
R6810M-10	7314150195152	5	66
R6810M-3,4	7314150195077	5	66
R6810M-4	7314150195084	5	66
R6810M-4,5	7314150195091	5	66
R6810M-5	7314150195107	5	66
R6810M-6	7314150195114	5	66
R6810M-7	7314150195121	1	66
R6810M-8	7314150195138	5	66
R6810M-9	7314150195145	5	66
R6810Z-1/4	7314150429448	1	66
R6810Z-3/16	7314150429387	1	66
R6810Z-3/8	7314150429394	1	66
R6810Z-5/16	7314150429400	1	66
R6810Z-7/32	7314150429417	1	66
R6950	7314151089658	1	71
R6964A	7314150195176	5	66
R6967	7314150195169	5	66
R716VCB	7311518255497	40	620
R772V	7311518301385	14	620
R773V	7311518324414	1	620
R801P	7311518234126	1	614
R802P	7311518234133	1	614
R803P	7311518234140	1	614
R804P	7311518240806	1	614
R811P	7311518234058	1	614
R812P	7311518234065	1	614
R813P	7311518234072	1	614
R815P	7311518240752	1	614
R900P	7311518234188	1	614
R901P	7311518234195	30	614
R902P	7311518234201	24	614
R903P	7311518234218	1	615
R904P	7311518234225	1	615
R905P	7311518234232	1	615
R905P-BULK50	7311518252250	50	615
R906P	7311518234249	1	615
R906P-BULK50	7311518252267	50	615
R907P	7311518234256	1	615
RAIL-187	7314153003621	3	69
RAIL-264	7314153003638	3	69
RAIL-340	7314153003645	3	69
RAUNI	7311518339289	6	621
RCAM30	7311518346959	20	623
RCAM36	7311518346973	20	623
RT821P	7311518242237	1	614
RT822P	7311518234102	1	614
RT823P	7311518234119	6	614
RT824P	7311518240776	1	614
RT825P	7311518347147	6	614
RX 01	7314150103263	1	639
RX 7490	7314150103195	1	638
RX 7590	7314150103201	1	638
RX 7890	7314150103218	1	638
RX 7891	7314150103225	1	638
RX 7892	7314150103232	1	639
RX 7893	7314150103249	1	639
RX 8130	7314150103003	1	637
RX 8131	7314150103010	1	637
RX 8132	7314150103027	1	637
RX 8140	7314150103034	1	637
RX 8141	7314150103041	1	637
RX 8142	7314150103058	1	637
RX 8143	7314150103065	1	636
RX 8144	7314150103072	1	636
RX 8145	7314150103089	1	636
RX 8146	7314150103096	1	636
RX 8147	7314150103102	1	636
RX 8148	7314150103119	1	636
RX 8149	7314150103126	1	637
RX 8150	7314150103133	1	637
RX 8151	7314150103140	1	637
RX 8152	7314150103157	1	637
RX 8160	7314150111534	1	637



RX 8161	7314150111541	1	637
RX 8162	7314150111558	1	637
RX 8211	7314150103188	1	637
RX 8247	7314150103164	1	637
RX 8248	7314150103171	1	637
S0810L	7314150256594	20	76
S10/SH11	7314153013408	1	53
S10/SH6	7314153013309	1	53
S103	7314150257119	2	100
S103-CASE	7314150321261	1	118
S106	7314150103997	2	77
S106-CASE	7314150214686	1	118
S108	7314150122257	2	100
S108-CASE	7314150349319	1	118
S1214L	7314150256600	10	87
S137	7314150450503	2	78
S138	7314150195022	2	78
S138-CASE	7314150349296	1	118
S140T	7314150125203	1	88
S140T-R	7314150136353	10	88
S160	7314150104031	6	77
S160-CASE	7314150136209	1	118
S160AF	7314150137510	6	77
S1612L	7314150256617	4	99
S18HEX	7314150412457	4	100
S18TORX	7314150412464	4	100
S20/SH12	7314153013378	1	45
S20/SH6	7314153013316	1	44
S240	7314150104017	4	100
S240AF	7314150111077	4	100
S290	7314153000859	6	77
S290-CASE	7314150126385	1	118
S330	7314150104024	6	87
S330-CASE	7314150136223	1	118
S330AF	7314150137503	6	87
S330L	7314150256587	4	87
S330L-CASE	7311518337674	1	118
S380	7314150168934	4	87
S400	7314150111053	2	100
S400-CASE	7314150187300	1	118
S410	7314153019370	2	78
S410-CASE	7314150321223	1	118
S460	7314150111060	6	77
S460-CASE	7314150321209	1	118
S4RM-12-15	7314150179954	1	50
S4RM-16-19	7314150179961	1	50
S4RM-21-27	7314150179978	1	50
S4RM-30-36	7314150179985	1	50
S4RM-4-7	7314150179930	1	50
S4RM-8-11	7314150179947	1	50
S4RM/3T	7314150117406	20	50
S4RM/4T	7314150179916	1	50
S4RM/5T	7314150179923	1	50
S530T	7314150169122	4	88
S560	7314150122264	4	100
S560-CASE	7314150321216	1	118
S800	7314150165599	2	78
S800-CASE	7314150321230	1	118
S81MIX	7314150180127	2	100
S81MIX-CASE	7314150321247	1	118
S87+7	7314150103980	2	77
S87+7-CASE	7314150126392	1	118
S910	7314150104000	2	77
S910-CASE	7314150137961	1	118
S910AF	7314150137541	2	77
S93	7314150129805	1	102
S95	7314150409167	2	101
S9HEX	7314150412433	10	99
S9TORX	7314150412440	10	99
SB-2058/S26	7314151849498	1	176
SB-2444	7314150189250	1	578
SB-2448	7314150136056	12	568
SB-2449	7314150194049	10	568
SB-3732-2-125	7314151847869	60	602
SB-3732-2.5-125	7314151847876	60	602
SB-3732-3.2-125	7314151847883	60	602
SB-3732-4-125	7314151847890	1	602
SB-3734N-10-150	7314151848101	1	601
SB-3734N-2-150	7314151847968	1	601
SB-3734N-3-150	7314151847975	1	601
SB-3734N-4-150	7314151847982	60	601
SB-3734N-5-150	7314151847999	1	601
SB-3734N-6-150	7314151848071	60	601
SB-3734N-7-150	7314151848088	1	601
SB-3734N-8-150	7314151848095	1	601
SB-3735N-2-100	7314151847906	600	600
SB-3735N-4-120	7314151847913	60	600
SB-3735N-5-120	7314151847920	1	600
SB-3735N-6-150	7314151847937	1	600
SB-3735N-8-150	7314151847944	1	600
SB-3740-125	7314150115990	5	598
SB-3740-150	7314150116003	5	598
SB-3740-175	7314150116010	5	598
SB-3740-200	7314150116027	5	598
SB-3740-250	7314150116034	5	598
SB-3740-300	7314150116041	5	598



SB-9526/S6	7314150154234	20	164
SB111M-10	7314151839864	1	42
SB111M-11	7314151839871	1	42
SB111M-12	7314151839888	1	42
SB111M-13	7314151839895	1	42
SB111M-14	7314151839901	1	42
SB111M-15	7314151839918	1	42
SB111M-16	7314151839925	1	42
SB111M-17	7314151839932	1	42
SB111M-18	7314151839949	1	42
SB111M-19	7314151839956	1	42
SB111M-20	7314151839963	1	42
SB111M-21	7314151839970	1	42
SB111M-22	7314151839987	1	42
SB111M-23	7314151839994	1	42
SB111M-24	7314151840006	1	42
SB111M-25	7314151840013	1	42
SB111M-26	7314151840020	1	42
SB111M-27	7314151840037	1	42
SB111M-28	7314150432103	1	42
SB111M-29	7314151840051	1	42
SB111M-30	7314151840068	1	42
SB111M-32	7314151840075	1	42
SB111M-5.5	7314151839819	1	42
SB111M-6	7314151839826	1	42
SB111M-7	7314151839833	1	42
SB111M-8	7314151839840	1	42
SB111M-9	7314151839857	1	42
SB141.007.075	7314150282753	1	195
SB141.008.075	7314150282760	1	195
SB141.009.075	7314150282777	1	195
SB141.010.075	7314150282784	1	195
SB141.015.100	7314150282791	1	195
SB141.020.100	7314150282807	1	195
SB141.025.125	7314150282814	1	195
SB141.027.125	7314150282821	1	195
SB141.030.150	7314150282838	1	195
SB141.040.150	7314150282845	1	195
SB142.000.075	7314150282579	1	490
SB142.001.080	7314150282586	1	490
SB142.002.100	7314150282593	1	490
SB142.003.150	7314150282609	1	490
SB143.020.100	7314150282852	1	196
SB143.025.100	7314150282869	1	196
SB143.030.100	7314150282876	1	196
SB143.040.100	7314150282883	1	196
SB143.050.100	7314150282890	1	196
SB143.060.125	7314150282906	1	196
SB143.080.150	7314150282913	1	196
SB144.001.100	7314150282951	1	196
SB144.002.125	7314150282968	1	196
SB144.003.150	7314150282975	1	196
SB145.006.100	7314150282920	1	196
SB146.006.100	7314150282937	1	196
SB147.001.400	7314150285617	1	361
SB147.003.400	7314150285624	1	361
SB148.001.080	7314150314577	1	490
SB148.002.100	7314150314584	1	490
SB149.001.080	7314150314591	1	490
SB149.002.100	7314150314607	1	490
SB150.010.100	7314150343492	1	490
SB150.015.125	7314150343515	1	490
SB150.020.125	7314150343577	1	490
SB150.025.150	7314150343584	1	490
SB190.040.075	7314150281985	1	193
SB190.040.100	7314150282098	1	193
SB190.055.100	7314150281992	1	193
SB190.055.125	7314150282005	1	193
SB190.065.125	7314150282012	1	193
SB190.065.150	7314150282029	1	193
SB190.080.150	7314150282036	1	193
SB190.080.175	7314150282043	1	193
SB190.100.200	7314150282050	1	193
SB190.120.250	7314150282067	1	193
SB190.140.250	7314150282074	1	193
SB191.025.075	7314150282081	1	194
SB191.030.075	7314150282104	1	194
SB191.030.100	7314150282111	1	194
SB191.030.200	7314150282128	1	194
SB191.035.100	7314150282135	1	194
SB191.040.100	7314150282142	1	194
SB191.040.125	7314150282159	1	194
SB191.040.250	7314150282166	1	194
SB191.055.125	7314150282173	1	194
SB191.055.150	7314150282180	1	194
SB191.055.300	7314150282197	1	194
SB191.065.150	7314150282203	1	194
SB191.065.300	7314150282210	1	194
SB192.000.075	7314150282357	1	194
SB192.000.200	7314150282364	1	194
SB192.001.100	7314150282371	1	194
SB192.001.250	7314150282388	1	194
SB192.002.125	7314150282395	1	194
SB192.002.300	7314150282401	1	194
SB192.003.150	7314150282418	1	194
SB192.004.200	7314150282425	1	194





SB193.000.075	7314150282456	1	195
SB193.001.100	7314150282463	1	195
SB193.002.125	7314150282470	1	195
SB193.003.150	7314150282487	1	195
SB193.004.200	7314150282494	1	195
SB194.004.075	7314150282616	1	195
SB194.005.075	7314150282623	1	195
SB194.006.075	7314150282630	1	195
SB194.007.075	7314150282647	1	195
SB194.008.075	7314150282654	1	195
SB194.009.075	7314150282661	1	195
SB194.010.075	7314150282678	1	195
SB194.015.100	7314150282685	1	195
SB194.020.100	7314150282692	1	195
SB194.025.125	7314150282708	1	195
SB194.027.125	7314150282715	1	195
SB194.030.150	7314150282722	1	195
SB194.040.150	7314150282739	1	195
SB194.045.150	7314150282746	1	195
SB195.001.025	7314150282432	1	194
SB195.002.025	7314150282449	1	194
SB195.006.050	7314150289516	1	196
SB195.040.025	7314150282227	1	194
SB195.050.025	7314150282234	1	194
SB195.060.025	7314150282241	1	194
SB195.901.025	7314150282500	1	195
SB195.902.025	7314150282517	1	195
SB1952M-10	7314150105205	1	46
SB1952M-12	7314150105229	1	46
SB1952M-13	7314150105236	1	46
SB1952M-14	7314150105243	1	46
SB1952M-17	7314150105274	1	46
SB1952M-19	7314150105298	1	46
SB1952M-24	7314150105342	1	46
SB1952M-7	7314150105441	1	46
SB1952M-8	7314150105458	1	46
SB196.025.075	7314150282258	1	489
SB196.030.100	7314150282265	1	489
SB196.035.100	7314150282272	1	489
SB196.040.100	7314150282289	1	489
SB196.055.125	7314150282296	1	489
SB196.065.150	7314150282302	1	489
SB196.080.175	7314150282326	1	489
SB196.100.200	7314150282333	1	489
SB196.120.200	7314150282340	1	489
SB197.000.075	7314150282524	1	489
SB197.001.080	7314150282531	1	489
SB197.002.100	7314150282548	1	489
SB197.003.150	7314150282555	1	489
SB197.004.200	7314150282562	1	489
SB198.040.125	7314150282982	1	197
SB198.045.125	7314150282999	1	197
SB198.050.150	7314150283002	1	197
SB198.055.150	7314150283019	1	197
SB198.060.150	7314150283026	1	197
SB198.060.150F	7314150283033	1	197
SB198.070.150	7314150283040	1	197
SB198.070.150F	7314150283057	1	197
SB198.080.150	7314150283064	1	197
SB198.080.150F	7314150283071	1	197
SB198.090.150	7314150283088	1	197
SB198.100.150	7314150283095	1	197
SB198.110.150	7314150283101	1	197
SB198.120.150	7314150283118	1	197
SB198.130.150	7314150283125	1	197
SB198.140.150	7314150283132	1	197
SB199.055.125	7314150283149	1	490
SB199.060.125	7314150283156	1	490
SB199.070.125	7314150283163	1	490
SB199.080.125	7314150283170	1	490
SB199.090.125	7314150283187	1	490
SB199.100.125	7314150283194	1	490
SB199.110.125	7314150283200	1	490
SB199.120.125	7314150287765	1	490
SB199.130.125	7314150287796	1	490
SB2446-EL	7314150312207	10	579
SB27M-10-11	7314150180851	10	61
SB27M-12-13	7314150180868	10	61
SB27M-14-15	7314150180875	10	61
SB27M-16-17	7314150180882	10	61
SB27M-18-19	7314150180899	10	61
SB27M-20-22	7314150180905	10	61
SB27M-21-23	7314150180912	5	61
SB27M-24-26	7314150180929	5	61
SB27M-6-7	7314150180837	10	61
SB27M-8-9	7314150180844	10	61
SB3654BM-15	7314150270897	5	599
SB3654BM-20	7314150270903	5	599
SB3734BM-10	7314150271092	5	604
SB3734BM-3	7314150270996	5	604
SB3734BM-4	7314150271016	5	604
SB3734BM-5	7314150271030	5	604
SB3734BM-6	7314150271054	5	604
SB3734BM-8	7314150271078	5	604
SB3755BM-4	7314150270934	1	604
SB3755BM-6	7314150270958	5	604



SB6700SM-10	7314150104383	1	66
SB6700SM-11	7314150104390	1	66
SB6700SM-12	7314150104406	1	66
SB6700SM-13	7314150104413	1	66
SB6700SM-14	7314150104420	1	66
SB6700SM-4	7314150104307	1	66
SB6700SM-4.5	7314150104314	1	66
SB6700SM-5	7314150104321	1	66
SB6700SM-5.5	7314150104338	1	66
SB6700SM-6	7314150104345	1	66
SB6700SM-7	7314150104352	1	66
SB6700SM-8	7314150104369	1	66
SB6700SM-9	7314150104376	1	66
SB6700SZ-1/2	7314150240609	1	66
SB6700SZ-1/4	7314150240616	1	66
SB6700SZ-1/8	7314150412495	5	66
SB6700SZ-11/32	7314150240623	1	66
SB6700SZ-3/16	7314150240630	1	66
SB6700SZ-3/8	7314150240647	1	66
SB6700SZ-5/16	7314150240654	1	66
SB6700SZ-5/32	7314150240661	1	66
SB6700SZ-7/16	7314150240678	1	66
SB6700SZ-7/32	7314150240685	1	66
SB6700SZ-9/16	7314150240692	1	66
SB6700SZ-9/32	7314150240708	1	66
SB6700TORX-E10	7314150240715	1	66
SB6700TORX-E4	7314150240722	1	66
SB6700TORX-E5	7314150240739	1	66
SB6700TORX-E6	7314150240746	1	66
SB6700TORX-E7	7314150240753	1	66
SB6700TORX-E8	7314150240760	1	66
SB6709F-4.5	7314150240777	1	70
SB6709F-5.5	7314150240784	1	70
SB6709F-6.5	7314150240791	1	70
SB6709F-8	7314150240807	1	70
SB6709M-3	7314150240814	1	70
SB6709M-4	7314150240821	1	70
SB6709M-5	7314150240838	1	70
SB6709M-6	7314150240845	1	70
SB6709M-8	7314150240852	1	70
SB6709PH-1	7314150240869	1	70
SB6709PH-2	7314150240876	1	70
SB6709PH-3	7314150240883	1	70
SB6709PZ-1	7314150240890	1	70
SB6709PZ-2	7314150240906	1	70
SB6709PZ-3	7314150240913	1	70
SB6709TORX-R-T10	7314150240975	1	70
SB6709TORX-R-T15	7314150240937	1	70
SB6709TORX-R-T20	7314150240944	1	70
SB6709TORX-R-T25	7314150240951	1	70
SB6709TORX-R-T8	7314150240968	1	70
SB6709TORX-T10	7314150240982	1	70
SB6709TORX-T15	7314150240999	1	70
SB6709TORX-T20	7314150241002	1	70
SB6709TORX-T25	7314150241019	1	70
SB6709TORX-T27	7314150241026	1	70
SB6709TORX-T30	7314150241033	1	70
SB6709TORX-T40	7314150241040	1	70
SB6709TORX-T8	7314150241057	1	70
SB6709TORX-T9	7314150241064	1	70
SB6950	7314150104987	1	71
SB6950RN	7314150104994	1	71
SB6954	7314150250158	10	68
SB6956	7314150241071	1	68
SB6958	7314150240296	1	68
SB6960	7314150104925	1	68
SB6961	7314150104932	1	68
SB6962	7314150104949	1	68
SB6962L	7314150254743	1	68
SB6963	7314150241088	1	68
SB6966	7314150241095	1	69
SB6M-10-11	7314150105731	1	51
SB6M-12-13	7314150105762	1	51
SB6M-14-15	7314150105823	1	51
SB6M-16-17	7314150105847	1	51
SB6M-17-19	7314150189830	1	51
SB6M-18-19	7314150105878	1	51
SB6M-20-22	7314150105915	1	51
SB6M-21-23	7314150105922	1	51
SB6M-22-24	7314150105946	1	51
SB6M-24-26	7314150105953	1	51
SB6M-24-27	7314150105960	1	51
SB6M-25-28	7314150189847	1	51
SB6M-27-29	7314150189854	1	51
SB6M-30-32	7314150106011	1	51
SB6M-4-5	7314150106042	1	51
SB6M-6-7	7314150106073	1	51
SB6M-8-9	7314150106103	1	51
SB705.1/4.125	7314150283231	1	209
SB7400SM-10	7314150241190	1	79
SB7400SM-11	7314150241118	1	79
SB7400SM-12	7314150241125	1	79
SB7400SM-13	7314150241132	1	79
SB7400SM-14	7314150241149	1	79
SB7400SM-15	7314150241156	1	79
SB7400SM-16	7314150241170	1	79



SB7400SM-17	7314150241187	1	79
SB7400SM-18	7314150241194	1	79
SB7400SM-19	7314150241200	1	79
SB7400SM-20	7314150241217	1	79
SB7400SM-21	7314150241224	1	79
SB7400SM-22	7314150241231	1	79
SB7400SM-6	7314150241248	1	79
SB7400SM-7	7314150241255	1	79
SB7400SM-8	7314150241262	1	79
SB7400SM-9	7314150241279	1	79
SB7400TORX-E10	7314150241286	1	80
SB7400TORX-E11	7314150241293	1	80
SB7400TORX-E12	7314150241309	1	80
SB7400TORX-E14	7314150241316	1	80
SB7400TORX-E16	7314150241323	1	80
SB7400TORX-E18	7314150241330	1	80
SB7400TORX-E8	7314150241347	1	80
SB7409BH-10	7314150241354	1	84
SB7409BH-4	7314150241361	1	84
SB7409BH-5	7314150241378	1	84
SB7409BH-6	7314150241385	1	84
SB7409BH-8	7314150241392	1	84
SB7409F-10	7314150241408	1	83
SB7409F-6.5	7314150241415	1	83
SB7409F-8	7314150241422	1	83
SB7409M-10	7314150241439	1	84
SB7409M-3	7314150241446	1	84
SB7409M-4	7314150241453	1	84
SB7409M-5	7314150241460	1	84
SB7409M-6	7314150241477	1	84
SB7409M-7	7314150241484	1	84
SB7409M-8	7314150241491	1	84
SB7409PH-1	7314150241507	1	83
SB7409PH-2	7314150241514	1	83
SB7409PH-3	7314150241521	1	83
SB7409TORX-R-T27	7314150241538	1	83
SB7409TORX-R-T30	7314150241545	1	83
SB7409TORX-R-T40	7314150241552	1	83
SB7409TORX-R-T45	7314150241569	1	83
SB7409TORX-R-T50	7314150241576	1	83
SB7409TORX-T20	7314150241583	1	83
SB7409TORX-T25	7314150241590	1	83
SB7409TORX-T25-L	7314150241606	1	83
SB7409TORX-T27	7314150241613	1	83
SB7409TORX-T30	7314150241620	1	83
SB7409TORX-T30-L	7314150241637	1	83
SB7409TORX-T40	7314150241644	1	83
SB7409TORX-T40-L	7314150241651	1	83
SB7409TORX-T45	7314150241668	1	83
SB7409TORX-T45-L	7314150241675	1	83
SB7409TORX-T50	7314150241682	1	83
SB7409TORX-T50-L	7314150241699	1	83
SB7750	7314150187850	1	82
SB7750RN	7314153003966	1	82
SB7754	7314150250165	1	80
SB7755-3/8	7314153010100	1	82
SB7757	7314150254842	1	81
SB7758	7314150240302	1	80
SB7759	7314150254859	1	81
SB7760	7314153003980	1	81
SB7761	7314150241705	1	81
SB7762	7314153004000	1	81
SB7764	7314150241729	1	81
SB7765	7314150241736	1	69
SB7766	7314150241743	1	81
SB7767	7314150254897	1	69
SB7800DM-10	7314150104451	1	89
SB7800DM-11	7314150104468	1	89
SB7800DM-12	7314150104475	1	89
SB7800DM-13	7314150104482	1	89
SB7800DM-14	7314150104499	1	89
SB7800DM-15	7314150104505	1	89
SB7800DM-16	7314150104512	1	89
SB7800DM-17	7314150104529	1	89
SB7800DM-18	7314150104536	1	89
SB7800DM-19	7314150104543	1	89
SB7800DM-20	7314150104550	1	89
SB7800DM-21	7314150104567	1	89
SB7800DM-22	7314150104574	1	89
SB7800DM-23	7314150104581	1	89
SB7800DM-24	7314150104598	1	89
SB7800DM-25	7314150104604	1	89
SB7800DM-26	7314150104611	1	89
SB7800DM-27	7314150104628	1	89
SB7800DM-28	7314150104635	1	89
SB7800DM-29	7314150104642	1	89
SB7800DM-30	7314150104659	1	89
SB7800DM-32	7314150104666	1	89
SB7800DM-33	7314150240319	1	89
SB7800DM-34	7314150327607	1	89
SB7800DM-36	7314150104673	1	89
SB7800DM-8	7314150104437	1	89
SB7800DM-9	7314150104444	1	89
SB7800DZ-1	7314150234912	1	90
SB7800DZ-1.1/16	7314150240326	1	90
SB7800DZ-1.1/4	7314150240333	1	90



SB7800DZ-1.1/8	7314150240340	1	90
SB7800DZ-1.3/16	7314150240357	1	90
SB7800DZ-1.5/16	7314150240364	1	90
SB7800DZ-1/2	7314150234899	1	90
SB7800DZ-11/16	7314150234929	1	90
SB7800DZ-13/16	7314150234936	1	90
SB7800DZ-15/16	7314150234943	1	90
SB7800DZ-19/32	7314150240371	1	90
SB7800DZ-25/32	7314150240388	1	90
SB7800DZ-3/4	7314150234950	1	90
SB7800DZ-3/8	7314150234967	1	90
SB7800DZ-5/8	7314150234974	1	90
SB7800DZ-7/16	7314150234981	1	90
SB7800DZ-7/8	7314150234998	1	90
SB7800DZ-9/16	7314150235001	1	90
SB7800SM-10	7314150104703	1	89
SB7800SM-11	7314150104710	1	89
SB7800SM-12	7314150104727	1	89
SB7800SM-13	7314150104734	1	89
SB7800SM-14	7314150104741	1	89
SB7800SM-15	7314150104758	1	89
SB7800SM-16	7314150104765	1	89
SB7800SM-17	7314150104772	1	89
SB7800SM-18	7314150104789	1	89
SB7800SM-19	7314150104796	1	89
SB7800SM-20	7314150240395	1	89
SB7800SM-21	7314150104819	1	89
SB7800SM-22	7314150104826	1	89
SB7800SM-23	7314150104833	1	89
SB7800SM-24	7314150104840	1	89
SB7800SM-25	7314150104857	1	89
SB7800SM-26	7314150104864	1	89
SB7800SM-27	7314150104871	1	89
SB7800SM-28	7314150104888	1	89
SB7800SM-29	7314150240401	1	89
SB7800SM-30	7314150104895	1	89
SB7800SM-32	7314150104901	1	89
SB7800SM-33	7314150240418	1	89
SB7800SM-34	7314150235018	1	89
SB7800SM-36	7314150235025	1	89
SB7800SM-8	7314150104680	1	89
SB7800SM-9	7314150104697	1	89
SB7800TORX-E10	7314150240104	1	90
SB7800TORX-E11	7314150240111	1	90
SB7800TORX-E12	7314150240128	1	90
SB7800TORX-E14	7314150240135	1	90
SB7800TORX-E16	7314150240142	1	90
SB7800TORX-E18	7314150240159	1	90
SB7800TORX-E20	7314150240166	1	90
SB7800TORX-E24	7314150240173	1	90
SB7800TORX-E8	7314150240180	1	90
SB7805DM-10	7314150234851	1	90
SB7805DM-12	7314150234868	1	90
SB7805DM-13	7314150235032	1	90
SB7805DM-14	7314150235049	1	90
SB7805DM-15	7314150235056	1	90
SB7805DM-16	7314150235063	1	90
SB7805DM-17	7314150235070	1	90
SB7805DM-18	7314150235087	1	90
SB7805DM-19	7314150235094	1	90
SB7805DM-21	7314150235100	1	90
SB7805DM-22	7314150235117	1	90
SB7805DM-23	7314150327614	1	90
SB7805DM-24	7314150235124	1	90
SB7805DM-26	7314150240197	1	90
SB7805DM-27	7314150235131	1	90
SB7805DM-30	7314150235148	1	90
SB7805DM-32	7314150240203	1	90
SB7805SM-10	7314150235155	1	89
SB7805SM-12	7314150235162	1	89
SB7805SM-13	7314150235179	1	89
SB7805SM-14	7314150235193	1	89
SB7805SM-15	7314150235216	1	89
SB7805SM-16	7314150240210	1	89
SB7805SM-17	7314150235223	1	89
SB7805SM-18	7314150235230	1	89
SB7805SM-19	7314150235247	1	89
SB7805SM-21	7314150235254	1	89
SB7805SM-22	7314150235261	1	89
SB7805SM-23	7314150240234	1	89
SB7805SM-24	7314150235278	1	89
SB7805SM-26	7314150240258	1	89
SB7805SM-27	7314150235285	1	89
SB7805SM-30	7314150235292	1	89
SB7805SM-32	7314150235308	1	89
SB7809M-10	7314153004185	1	93
SB7809M-10-140	7314153004192	1	93
SB7809M-12	7314153004208	1	93
SB7809M-14	7314153004215	1	93
SB7809M-17	7314153004222	1	93
SB7809M-19	7314153004239	1	93
SB7809M-4	7314150313952	1	93
SB7809M-5	7314153004109	1	93
SB7809M-5-100	7314150313969	1	93
SB7809M-5-180	7314153004116	1	93
SB7809M-6	7314153004123	1	93





SB7809M-6-100	7314150313976	1	93
SB7809M-6-140	7314153013231	1	93
SB7809M-7	7314153004130	1	93
SB7809M-7-100	7314153004147	1	93
SB7809M-8	7314153004154	1	93
SB7809M-8-120	7314153004161	1	93
SB7809M-9	7314153004178	1	93
SB7809TORX-T20	7314153004017	1	93
SB7809TORX-T25	7314153004024	1	93
SB7809TORX-T27	7314153004031	1	93
SB7809TORX-T30	7314153004048	1	93
SB7809TORX-T40	7314153004055	1	93
SB7809TORX-T45	7314153004062	1	93
SB7809TORX-T50	7314153004079	1	93
SB7809TORX-T55	7314153004086	1	93
SB7809TORX-T60	7314153004093	1	93
SB8110-1/2	7314153004246	1	95
SB8150-1/2	7314150105014	1	94
SB8150RN-1/2	7314150105007	1	94
SB8154-11	7314150472178	1	91
SB8155-1/2	7314150105021	1	94
SB8157-10	7314150474073	1	91
SB8157-15	7314150472468	1	91
SB8157-24	7314150474080	1	91
SB8157-36	7314150474097	1	91
SB8160-10	7314150472185	1	91
SB8160-3	7314150472192	1	91
SB8160-5	7314150472208	1	91
SB8166	7314150472154	1	91
SB8171	7314150479016	1	91
SB8172	7314150479023	1	92
SBA6700DM-10	7314150235575	1	67
SBA6700DM-11	7314150241750	1	67
SBA6700DM-12	7314150241767	1	67
SBA6700DM-13	7314150241774	1	67
SBA6700DM-14	7314150241781	1	67
SBA6700DM-5	7314150255054	1	67
SBA6700DM-5.5	7314150241798	1	67
SBA6700DM-6	7314150241804	1	67
SBA6700DM-7	7314150241811	1	67
SBA6700DM-8	7314150241828	1	67
SBA6700DM-9	7314150241835	1	67
SBA6700DZ-1/2	7314150241842	1	67
SBA6700DZ-1/4	7314150241859	1	67
SBA6700DZ-11/32	7314150241866	1	67
SBA6700DZ-3/16	7314150241873	1	67
SBA6700DZ-3/8	7314150241880	1	67
SBA6700DZ-5/16	7314150241897	1	67
SBA6700DZ-7/16	7314150241903	1	67
SBA6700DZ-7/32	7314150241910	1	67
SBA6700DZ-9/16	7314150241927	1	67
SBA6700DZ-9/32	7314150241934	1	67
SBA6709M-2.5	7314150254835	1	71
SBA6709M-3	7314150254828	1	71
SBA6709M-4	7314150254811	1	71
SBA6709M-5	7314150254804	1	71
SBA6709M-6	7314150254798	1	71
SBA6709Z-1/8	7314150254781	1	71
SBA6709Z-3/16	7314150254774	1	71
SBA6709Z-5/32	7314150254767	1	71
SBA6709Z-9/64	7314150254750	1	71
SBA6800DM-10	7314150250172	1	67
SBA6800DM-11	7314150250189	1	67
SBA6800DM-12	7314150250196	1	67
SBA6800DM-13	7314150250202	1	67
SBA6800DM-14	7314150250219	1	67
SBA6800DM-4	7314150250226	1	67
SBA6800DM-5	7314150250233	1	67
SBA6800DM-5.5	7314150250240	1	67
SBA6800DM-6	7314150250257	1	67
SBA6800DM-7	7314150250264	1	67
SBA6800DM-8	7314150250271	1	67
SBA6800DM-9	7314150250288	1	67
SBA6800DZ-1/2	7314150250295	1	67
SBA6800DZ-1/4	7314150250301	1	67
SBA6800DZ-11/32	7314150250318	1	67
SBA6800DZ-3/16	7314150250325	1	67
SBA6800DZ-3/8	7314150250332	1	67
SBA6800DZ-5/16	7314150250349	1	67
SBA6800DZ-7/16	7314150250356	1	67
SBA6800DZ-7/32	7314150250363	1	67
SBA6800DZ-9/16	7314150250370	1	67
SBA6800DZ-9/32	7314150250387	1	67
SBA7400DM-10	7314150241941	1	79
SBA7400DM-11	7314150241958	1	79
SBA7400DM-12	7314150241965	1	79
SBA7400DM-13	7314150241972	1	79
SBA7400DM-14	7314150241989	1	79
SBA7400DM-15	7314150241996	1	79
SBA7400DM-16	7314150242009	1	79
SBA7400DM-17	7314150242016	1	79
SBA7400DM-18	7314150242023	1	79
SBA7400DM-19	7314150242030	1	79
SBA7400DM-20	7314150242047	1	79
SBA7400DM-21	7314150242054	1	79
SBA7400DM-22	7314150242061	1	79



SBA7400DM-6	7314150242078	1	79
SBA7400DM-7	7314150242085	1	79
SBA7400DM-8	7314150242092	1	79
SBA7400DM-9	7314150242108	1	79
SBA7400DZ-1/2	7314150254705	1	79
SBA7400DZ-1/4	7314150242115	1	79
SBA7400DZ-11/16	7314150242122	1	79
SBA7400DZ-13/16	7314150242139	1	79
SBA7400DZ-17/32	7314150242146	1	79
SBA7400DZ-19/32	7314150242153	1	79
SBA7400DZ-3/4	7314150242160	1	79
SBA7400DZ-3/8	7314150242177	1	79
SBA7400DZ-5/16	7314150242184	1	79
SBA7400DZ-5/8	7314150242191	1	79
SBA7400DZ-7/16	7314150242207	1	79
SBA7400DZ-7/8	7314150242214	1	79
SBA7400DZ-9/16	7314150242221	1	79
SBA7402DM-10	7314150250394	1	80
SBA7402DM-11	7314150250400	1	80
SBA7402DM-12	7314150250417	1	80
SBA7402DM-13	7314150250424	1	80
SBA7402DM-14	7314150250431	1	80
SBA7402DM-15	7314150250448	1	80
SBA7402DM-16	7314150250455	1	80
SBA7402DM-17	7314150250462	1	80
SBA7402DM-18	7314150250479	1	80
SBA7402DM-19	7314150250486	1	80
SBA7402DM-7	7314150250493	1	80
SBA7402DM-8	7314150250509	1	80
SBA7402DM-9	7314150250516	1	80
SBA7402DZ-1/2	7314150250523	1	80
SBA7402DZ-1/4	7314150250530	1	80
SBA7402DZ-11/16	7314150250547	1	80
SBA7402DZ-13/16	7314150250554	1	80
SBA7402DZ-19/32	7314150250561	1	80
SBA7402DZ-3/4	7314150250578	1	80
SBA7402DZ-3/8	7314150250585	1	80
SBA7402DZ-5/16	7314150250592	1	80
SBA7402DZ-5/8	7314150250608	1	80
SBA7402DZ-7/16	7314150250615	1	80
SBA7402DZ-7/8	7314150250622	1	80
SBA7402DZ-9/16	7314150250639	1	80
SBC110-65	7314150456246	1	569
SBE-8135TB	7314150320424	1	192
SBE-8145TB	7314150320431	1	192
SBE-8150TB	7314150320448	1	192
SBE-8155TB	7314150320455	1	192
SBE-8610TB	7314150320493	1	192
SBE-8620TB	7314150320509	1	192
SBE-8810TB	7314150320530	1	192
SBE-8820TB	7314150320547	1	192
SBE-8915TB	7314150320585	1	192
SBE-8920TB	7314150320592	1	192
SBE-8925TB	7314150320608	1	193
SBE-8930TB	7314150320623	1	193
SBE-8940TB	7314150320639	1	193
SBK6701M-10	7314150445233	1	107
SBK6701M-11	7314150445240	1	107
SBK6701M-12	7314150445264	1	107
SBK6701M-13	7314150445271	1	107
SBK6701M-14	7314150445288	1	107
SBK6701M-6	7314150445196	1	107
SBK6701M-7	7314150445202	1	107
SBK6701M-8	7314150445219	1	107
SBK6701M-9	7314150445226	1	107
SBK7401M-10	7314150445325	1	107
SBK7401M-11	7314150445332	1	107
SBK7401M-12	7314150445349	1	107
SBK7401M-13	7314150445356	1	107
SBK7401M-14	7314150445363	1	107
SBK7401M-15	7314150445370	1	107
SBK7401M-16	7314150445387	1	107
SBK7401M-17	7314150445394	1	107
SBK7401M-18	7314150445400	1	107
SBK7401M-19	7314150445417	1	107
SBK7401M-20	7314150445424	1	107
SBK7401M-21	7314150445431	1	107
SBK7401M-22	7314150445448	1	107
SBK7401M-24	7314150445455	1	107
SBK7401M-7	7314150445295	1	107
SBK7401M-8	7314150445301	1	107
SBK7401M-9	7314150445318	1	107
SBK7801M-10	7314150445486	1	109
SBK7801M-11	7314150445493	1	109
SBK7801M-12	7314150445509	1	109
SBK7801M-13	7314150445516	1	109
SBK7801M-14	7314150445523	1	109
SBK7801M-15	7314150445530	1	109
SBK7801M-16	7314150445547	1	109
SBK7801M-17	7314150445554	1	109
SBK7801M-18	7314150445561	1	109
SBK7801M-19	7314150445578	1	109
SBK7801M-20	7314150445585	1	109
SBK7801M-21	7314150445592	1	109
SBK7801M-22	7314150445608	1	109
SBK7801M-23	7314150445615	1	109



SBK7801M-24	7314150445622	1	109
SBK7801M-25	7314150445639	1	109
SBK7801M-26	7314150445646	1	109
SBK7801M-27	7314150445653	1	109
SBK7801M-28	7314150450763	1	109
SBK7801M-29	7314150450770	1	109
SBK7801M-30	7314150445660	1	109
SBK7801M-32	7314150445677	1	109
SBK7801M-34	7314150445684	1	109
SBK7801M-36	7314150445691	1	109
SBK7801M-8	7314150445462	1	109
SBK7801M-9	7314150445479	1	109
SBS20-10	7314153009142	1	43
SBS20-11	7314153009159	1	43
SBS20-12	7314153009166	1	43
SBS20-13	7314153009173	1	43
SBS20-14	7314153009180	1	43
SBS20-15	7314153009197	1	43
SBS20-16	7314153009203	1	43
SBS20-17	7314153009210	1	43
SBS20-18	7314153009227	1	43
SBS20-19	7314153009234	1	43
SBS20-20	7314153009241	1	43
SBS20-21	7314153009258	1	43
SBS20-22	7314153009265	1	43
SBS20-24	7314153009272	1	43
SBS20-27	7314153009289	1	43
SBS20-30	7314153009296	1	43
SBS20-32	7314153009302	1	43
SBS20-6	7314153009104	1	43
SBS20-7	7314153009111	1	43
SBS20-8	7314153009128	1	43
SBS20-9	7314153009135	1	43
SBS61	7314153009661	1	71
SBS61S	7314150179886	1	71
SBS705	7314153012968	1	80
SBS71-16	7314150127245	1	302
SBS71-21	7314150127252	1	302
SBS750	7314153012883	10	82
SBS780	7314150125197	1	82
SBS81	7314153009937	5	94
SBS82	7314153009944	1	94
SBS87	7314153009968	1	91
SBS87S	7314153009951	1	91
SBSL25	7314153015853	5	76
SC127	7314150121984	10	574
SC127S	7314150121991	10	574
SC127V	7314150121847	5	497
SC140	7314150122004	10	575
SC140C	7314150122011	10	575
SC150NG	7314150122028	10	575
SC150NGV	7314150121854	5	497
SC2RM-13-17	7314150265350	10	118
SC2RM-15-17	7314150265367	10	118
SC2RM-19-22	7314150181384	5	118
SC2RM-27-30	7314150265343	1	118
SC335M-17	7314150344314	1	54
SC335M-19	7314150344321	1	54
SC335M-22	7314150344338	1	54
SC335M-24	7314150344345	1	54
SC335M-27	7314150344352	1	54
SC335M-30	7314150344369	1	54
SC335M-32	7314150344376	1	54
SC335M-36	7314150344383	1	54
SC335M-41	7314150344390	1	54
SC335M-46	7314150344406	1	54
SCB140	7314150297351	10	574
SCB140G	7314150297368	10	574
SCRAPER-SET2	7311518228613	1	546
SE-15-24	7311518029838	5	626
SE-15-30	7311518029821	5	626
SE-15-30-23	7311518029845	5	626
SE-15-32	7311518249168	5	626
SE-15-36	7311518141202	5	626
SE-15-36-23	7311518258276	5	626
SE-16-21	7311518029807	5	626
SE-16-21-23	7311518273934	5	626
SH-407	7314150389827	1	590
SH-427-700	7314150349074	10	590
SH-428-700	7314150349081	10	590
SH-485W	7314150358021	1	588
SH-485W-PLATES	7314150358038	1	588
SH-486-493-495	7314150349098	10	590
SH-486F493F495F	7314150349104	10	590
SH-486W	7314150358014	1	589
SH-488-2000	7314150346912	10	590
SH-488-34	7314150349036	10	590
SH-488-56	7314150349043	10	590
SH-488F-2000	7314150346950	10	590
SH-488F-34	7314150349050	10	590
SH-488F-56	7314150349067	10	590
SH-491-34	7314150374298	12	590
SH-491-56	7314150374304	12	590
SH-FCP-860	7311518324421	1	595
SH-FCS-810	7311518140540	1	595
SH-FCS-860	7311518140557	1	595



SH-FGS-1.8-810	7311518327828	1	595
SH-FGS-600	7311518140649	1	595
SH-FGS-700	7311518140656	12	595
SH-FGS-800	7311518140663	1	595
SH-HFGPS-400FG	7311518282301	1	595
SH-HGPS-360	7311518140618	12	595
SH-HGPS-380	7311518140625	1	595
SH-HGPS-400	7311518207618	1	595
SH-HUS-380	7311518140502	1	595
SH-HUS-500	7311518140519	1	595
SH-HUS-650	7311518140526	1	595
SH-MCS-800	7311518140595	1	595
SH-MES-900	7311518140601	12	595
SH-MES-900FG	7311518282318	12	595
SH-MES-F-900	7311518141554	12	595
SH-PAGS-900	7311518327866	1	595
SH-PAGS-900FG	7311518326944	1	595
SH-SUS-800	7311518140809	12	595
SHARP-INS	7314150197897	100	563
SHARP-X	7311518264895	10	629
SHARP-X-DISP	7311518264901	1	629
SL24	7314150128389	1	76
SL25	7314153013422	20	76
SL25AF	7314150180141	1	76
SL25L	7314150256570	10	77
SL34	7314150409181	6	88
SL65	7314150444137	6	74
SL79	7314150444144	4	85
SL91	7314150444151	4	85
SLX 17	7314153015785	1	105
SLX 17AF	7314150137558	1	105
SLX17-CASE	7314150321254	1	118
SP120	7314150312474	1	92
SP120XL	7314150313594	1	92
SPAR-CASE-A4	7314150263523	1	118
SPAR-CASE-A5	7314150263530	1	118
SPAR-CASE-A6	7314150263547	1	118
SPAR-CASE-A7	7314150263554	1	118
SQZ-MINI	7314150186280	24	577
SQZ-MINI-BLADE	7314150190348	1	577
SQZ150003	7314153013477	6	575
SQZ150003-HSBL	7314153015389	6	576
SQZ150003-SBL	7314153015372	1	576
SR1000-E	7314150302918	20	541
SR1000-MM	7314150302857	20	541
SR150-E	7314150302864	12	541
SR150-MM	7314150302819	12	541
SR200-E	7314150302871	12	541
SR200-MM	7314150302826	12	541
SR300-E	7314150302888	12	541
SR300-MM	7314150302833	12	541
SR600-E	7314150302901	20	541
SR600-MM	7314150302840	20	541
SS001-100	7314150404384	1	522
SS001-150	7314150404377	1	522
SS001-200	7314150404391	1	522
SS001-250	7314150404407	1	522
SS001-300	7314150404414	1	522
SS001-375	7314150404421	1	522
SS001-450	7314150404438	1	522
SS001-600	7314150404445	1	522
SS002-10	7314150404483	1	522
SS002-11	7314150404490	1	522
SS002-12	7314150404506	1	522
SS002-13	7314150404513	1	522
SS002-14	7314150404520	1	522
SS002-15	7314150404537	1	522
SS002-16	7314150404551	1	522
SS002-17	7314150404568	1	522
SS002-19	7314150404575	1	522
SS002-21	7314150404582	1	522
SS002-22	7314150404599	1	522
SS002-24	7314150404605	1	522
SS002-27	7314150404612	1	522
SS002-32	7314150404629	1	522
SS002-6	7314150404469	1	522
SS002-6-2	7314150407903	1	522
SS002-8	7314150404476	1	522
SS002-9-2	7314150407910	1	522
SS003-10	7314150404643	1	522
SS003-11	7314150404650	1	522
SS003-12	7314150404667	1	522
SS003-14	7314150404681	1	522
SS003-16	7314150404704	1	522
SS003-18	7314150404711	1	522
SS003-20	7314150404728	1	522
SS003-22	7314150404735	1	522
SS003-24	7314150404742	1	522
SS003-25	7314150404759	1	522
SS003-26	7314150404766	1	522
SS003-28	7314150404773	1	522
SS003-30	7314150404780	1	522
SS003-8	7314150404636	1	522
SS011-0507	7314150404797	1	522
SS011-0607	7314150404803	1	522
SS011-0809	7314150404810	1	522





SS011-0810	7314150404827	1	522
SS011-0911	7314150404834	1	522
SS011-1012	7314150404858	1	522
SS011-11-3	7314150419142	1	523
SS011-1214	7314150404865	1	522
SS011-1417	7314150404872	1	522
SS011-1618	7314150404889	1	522
SS011-1719	7314150404896	1	522
SS011-1722	7314150404902	1	522
SS011-2224	7314150404919	1	522
SS011-2427	7314150404926	1	522
SS011-2430	7314150404940	1	522
SS011-3032	7314150404957	1	522
SS011-9-3	7314150419135	1	523
SS210-10	7314150405343	1	523
SS210-11	7314150405350	1	523
SS210-12	7314150405367	1	523
SS210-13	7314150405374	1	523
SS210-14	7314150405381	1	523
SS210-4	7314150405268	1	523
SS210-4.5	7314150405275	1	523
SS210-5	7314150405282	1	523
SS210-5.5	7314150405299	1	523
SS210-6	7314150405305	1	523
SS210-7	7314150405312	1	523
SS210-8	7314150405329	1	523
SS210-9	7314150405336	1	523
SS220-10	7314150404995	1	523
SS220-11	7314150405008	1	523
SS220-12	7314150405022	1	523
SS220-13	7314150405039	1	523
SS220-14	7314150405053	1	523
SS220-15	7314150405060	1	523
SS220-16	7314150405077	1	523
SS220-17	7314150405084	1	523
SS220-18	7314150405091	1	523
SS220-19	7314150405114	1	523
SS220-20	7314150405121	1	523
SS220-21	7314150405138	1	523
SS220-22	7314150405145	1	523
SS220-23	7314150405152	1	523
SS220-24	7314150405176	1	523
SS220-25	7314150405183	1	523
SS220-26	7314150405190	1	523
SS220-27	7314150405206	1	523
SS220-28	7314150405213	1	523
SS220-29	7314150405220	1	523
SS220-30	7314150405237	1	523
SS220-31	7314150405244	1	523
SS220-32	7314150405251	1	523
SS220-8	7314150404964	1	523
SS220-9	7314150404988	1	523
SS224-17	7314150405398	1	523
SS224-19	7314150405404	1	523
SS224-22	7314150405411	1	523
SS224-24	7314150405428	1	523
SS224-27	7314150405435	1	523
SS224-30	7314150405442	1	523
SS224-32	7314150405459	1	523
SS224-34	7314150405466	1	523
SS224-36	7314150405473	1	523
SS224-41	7314150405480	1	523
SS224-46	7314150405497	1	523
SS224-50	7314150405503	1	523
SS224-55	7314150405510	1	523
SS224-60	7314150405527	1	523
SS224-65	7314150405534	1	523
SS234-16-100	7314150405572	1	523
SS234-16-200	7314150405589	1	523
SS234-16-250	7314150405602	1	523
SS234-24-100	7314150405619	1	523
SS234-24-200	7314150405626	1	523
SS234-24-250	7314150405633	1	523
SS236-08-80	7314150405718	1	523
SS236-16-80	7314150405701	1	523
SS236-24-110	7314150405725	1	523
SS238-08-250	7314150405657	1	524
SS238-16-250	7314150405640	1	524
SS238-24-350	7314150405664	1	524
SS242-08-200	7314150405558	1	524
SS242-16-245	7314150405541	1	524
SS242-24-320	7314150405565	1	524
SS243-08	7314150405688	1	524
SS243-16	7314150405671	1	524
SS243-24	7314150405695	1	524
SS324-1.5	7314150405732	1	525
SS324-10	7314150405824	1	525
SS324-2	7314150405749	1	525
SS324-2.5	7314150405756	1	525
SS324-3	7314150405763	1	525
SS324-4	7314150405770	1	525
SS324-5	7314150405787	1	525
SS324-6	7314150405794	1	525
SS324-8	7314150405817	1	525
SS325-10	7314150405886	1	525
SS325-12	7314150405879	1	525



SS325-2.5	7314150405909	1	525
SS325-3	7314150405862	1	525
SS325-3.5	7314150405923	1	525
SS325-4	7314150405848	1	525
SS325-4.5	7314150405930	1	525
SS325-5	7314150405893	1	525
SS325-6	7314150405855	1	525
SS325-7	7314150405916	1	525
SS325-8	7314150405831	1	525
SS400-160	7314150405978	1	526
SS400-180	7314150405985	1	526
SS400-200	7314150405992	1	526
SS402-160	7314150406005	1	526
SS402-200	7314150406012	1	526
SS406-160	7314150406029	1	526
SS406-200	7314150406036	1	526
SS410-250	7314150406043	1	526
SS410-300	7314150406050	1	526
SS412-200	7314150406067	1	526
SS415-225	7314150406074	1	526
SS502-1000-FB	7314150406081	1	526
SS502-1500-FB	7314150406098	1	526
SS502-2000-FB	7314150406104	1	526
SS502-2500-FB	7314150406111	1	526
SS502-3000-FB	7314150406128	1	526
SS502-3600-FB	7314150406135	1	526
SS506-1100-FB	7314150406197	1	526
SS506-200-FB	7314150406142	1	526
SS506-300-FB	7314150406159	1	526
SS506-500-FB	7314150406166	1	526
SS506-700-FB	7314150406173	1	526
SS506-900-FB	7314150406180	1	526
SS603-15-500	7314150406203	1	526
SS603-19-500	7314150406210	1	526
SS603-20-500	7314150406227	1	526
SS603-23-500	7314150406234	1	526
SS603-23-800	7314150406258	1	526
SS603-25-600	7314150406241	1	526
SS603-30-1000	7314150406265	1	526
SS610-16-160	7314150406272	1	526
SS610-18-200	7314150406289	1	526
SS610-24-300	7314150406296	1	526
SS610-25-400	7314150406302	1	526
SS610-30-500	7314150406319	1	526
SUC-0.7-450	7314150342082	4	595
SUC-0.9-600	7314150342105	4	595
SUC-1.0-710	7314150342068	4	595
SUC-1.7-800	7314150342051	4	595
SUP-20-LAM	7311518258351	4	590
SUS-2.0-800	7311518123451	4	594
SW65	7314150442898	6	74
SW79	7314150442904	4	85
SW91	7314150442942	4	85
TAH08-10	7314150305087	1	471
TAH08-11	7314150305094	1	471
TAH08-12	7314150305100	1	471
TAH08-13	7314150305117	1	471
TAH08-5.5	7314150305032	1	471
TAH08-6	7314150305049	1	471
TAH08-7	7314150305056	1	471
TAH08-8	7314150305063	1	471
TAH08-9	7314150305070	1	471
TAH08-H3	7314150305124	1	471
TAH08-H4	7314150305131	1	471
TAH08-H5	7314150305148	1	471
TAH08-H6	7314150305155	1	471
TAH08-H8	7314150305162	1	471
TAH08-PH1	7314150305179	1	471
TAH08-PH2	7314150305186	1	471
TAH08-PH3	7314150305193	1	471
TAH08-T10	7314150305223	1	472
TAH08-T15	7314150305230	1	472
TAH08-T20	7314150305247	1	472
TAH08-T25	7314150305254	1	472
TAH08-T27	7314150305261	1	472
TAH08-T30	7314150305278	1	472
TAH08-T40	7314150305285	1	472
TAH08-T8	7314150305209	1	472
TAH08-T9	7314150305216	1	472
TAH1-110-08-1-2	7314150437825	1	479
TAH1-143-12-1-2	7314150307548	1	479
TAH1-160-08-1-2	7314150437818	1	479
TAH1-170-08-1-2	7314150437801	1	479
TAH1-210-06-2-2	7314150307555	1	479
TAH1-210-08-1-2	7314150437795	1	479
TAH1-230-06-2-2	7314150307562	1	479
TAH1-230-08-1-2	7314150437788	1	479
TAH111M-10	7314150308538	1	469
TAH111M-11	7314150308545	1	469
TAH111M-12	7314150308552	1	469
TAH111M-13	7314150308569	1	469
TAH111M-14	7314150308576	1	469
TAH111M-15	7314150308583	1	469
TAH111M-16	7314150308590	1	469
TAH111M-17	7314150308606	1	469
TAH111M-18	7314150308613	1	469





TAH111M-19	7314150308620	1	469
TAH111M-20	7314150308637	1	469
TAH111M-21	7314150308644	1	469
TAH111M-22	7314150308651	1	469
TAH111M-23	7314150308668	1	469
TAH111M-24	7314150308675	1	469
TAH111M-25	7314150399611	1	469
TAH111M-27	7314150308682	1	469
TAH111M-30	7314150308699	1	469
TAH111M-32	7314150308705	1	469
TAH111M-34	7314150308712	1	469
TAH111M-36	7314150308729	1	469
TAH111M-41	7314150308736	1	469
TAH111M-46	7314150308743	1	469
TAH111M-50	7314150308750	1	469
TAH111M-55	7314150411573	1	469
TAH111M-6	7314150308491	1	469
TAH111M-7	7314150308507	1	469
TAH111M-8	7314150308514	1	469
TAH111M-85	7314150362356	1	469
TAH111M-9	7314150308521	1	469
TAH111Z-1	7314150343362	1	469
TAH111Z-1.1/16	7314150343379	1	469
TAH111Z-1.1/2	7314150431830	1	469
TAH111Z-1.1/4	7314150343386	1	469
TAH111Z-1.1/8	7314150343393	1	469
TAH111Z-1.11/16	7314150431854	1	469
TAH111Z-1.13/16	7314150431878	1	469
TAH111Z-1.3/4	7314150431861	1	469
TAH111Z-1.3/8	7314150431816	1	469
TAH111Z-1.5/16	7314150343409	1	469
TAH111Z-1.5/8	7314150431847	1	469
TAH111Z-1.7/16	7314150431823	1	469
TAH111Z-1.7/8	7314150431885	1	469
TAH111Z-1/2	7314150343461	1	469
TAH111Z-1/4	7314150343508	1	469
TAH111Z-11/16	7314150343522	1	469
TAH111Z-13/16	7314150343539	1	469
TAH111Z-15/16	7314150343546	1	469
TAH111Z-2	7314150431892	1	469
TAH111Z-2.1/2	7314150431922	1	469
TAH111Z-2.1/4	7314150431915	1	469
TAH111Z-2.1/8	7314150431908	1	469
TAH111Z-2.3/4	7314150431946	1	469
TAH111Z-2.3/8	7314150413959	1	469
TAH111Z-2.5/8	7314150431939	1	469
TAH111Z-2.7/8	7314150431953	1	469
TAH111Z-3	7314150431960	1	469
TAH111Z-3/4	7314150343553	1	469
TAH111Z-3/8	7314150343560	1	469
TAH111Z-5/16	7314150343591	1	469
TAH111Z-5/8	7314150343607	1	469
TAH111Z-7/16	7314150343614	1	469
TAH111Z-7/8	7314150343621	1	469
TAH111Z-9/16	7314150343638	1	469
TAH1150-1/2H/P	7314150307760	1	482
TAH1177-SCRIBE	7314150307777	1	482
TAH140	7314150344475	1	471
TAH141	7314150339433	1	471
TAH1410	7314150344543	1	471
TAH142	7314150339440	1	471
TAH1420	7314150344550	1	471
TAH143	7314150344482	1	471
TAH1544	7314150307746	1	483
TAH16-H10	7314150306176	1	473
TAH16-H12	7314150306183	1	473
TAH16-H14	7314150306190	1	473
TAH16-H17	7314150306206	1	473
TAH16-H19	7314150306213	1	473
TAH16-H4	7314150306121	1	472
TAH16-H5	7314150306138	1	472
TAH16-H6	7314150306145	1	473
TAH16-H7	7314150306152	1	473
TAH16-H8	7314150306169	1	473
TAH16-T30	7314150306220	1	473
TAH16-T40	7314150306237	1	473
TAH16-T45	7314150306244	1	473
TAH16-T50	7314150306251	1	473
TAH16-T55	7314150306268	1	473
TAH16-T60	7314150306275	1	473
TAH16B-1	7314150306077	1	472
TAH16B-1.1/16	7314150306084	1	472
TAH16B-1.1/4	7314150306107	1	472
TAH16B-1.1/8	7314150306114	1	472
TAH16B-1/2	7314150305995	1	472
TAH16B-10	7314150305629	1	472
TAH16B-11	7314150305636	1	472
TAH16B-11/16	7314150306022	1	472
TAH16B-12	7314150305643	1	472
TAH16B-13	7314150305650	1	472
TAH16B-13/16	7314150306046	1	472
TAH16B-14	7314150305667	1	472
TAH16B-15	7314150305674	1	472
TAH16B-15/16	7314150306060	1	472
TAH16B-16	7314150305698	1	472
TAH16B-17	7314150305704	1	472



TAH16B-18	7314150305711	1	472
TAH16B-19	7314150305728	1	472
TAH16B-21	7314150305735	1	472
TAH16B-22	7314150305742	1	472
TAH16B-24	7314150305759	1	472
TAH16B-25	7314150305766	1	472
TAH16B-27	7314150305773	1	472
TAH16B-3/4	7314150306039	1	472
TAH16B-30	7314150305780	1	472
TAH16B-32	7314150305797	1	472
TAH16B-5/8	7314150306015	1	472
TAH16B-7/8	7314150306053	1	472
TAH16B-8	7314150305612	1	472
TAH16B-9/16	7314150306008	1	472
TAH16BM/22	7314150422357	1	473
TAH16BZ/17	7314150422340	1	473
TAH16H-1/2	7314150306329	1	473
TAH16H-1/4	7314150306282	1	473
TAH16H-3/8	7314150306305	1	473
TAH16H-5/16	7314150306299	1	473
TAH16H-5/8	7314150306343	1	473
TAH16H-7/16	7314150306312	1	473
TAH16H-9/16	7314150306336	1	473
TAH1949M-10-11	7314150308866	1	470
TAH1949M-12-14	7314150308873	1	470
TAH1949M-14-17	7314150308880	1	470
TAH1949M-19-22	7314150308897	1	470
TAH1949M-24-27	7314150308903	1	470
TAH1949M-8-9	7314150308859	1	470
TAH1995M-10	7314150432219	1	476
TAH1995M-12	7314150432226	1	476
TAH1995M-8	7314150432202	1	476
TAH1995Z-1/2	7314150415007	1	476
TAH1RM-10	7314150414338	1	470
TAH1RM-11	7314150424306	1	470
TAH1RM-12	7314150424313	1	470
TAH1RM-13	7314150414345	1	470
TAH1RM-14	7314150424320	1	470
TAH1RM-15	7314150424337	1	470
TAH1RM-16	7314150414352	1	470
TAH1RM-17	7314150352210	1	470
TAH1RM-18	7314150414369	1	470
TAH1RM-19	7314150352227	1	470
TAH1RM-21	7314150424344	1	470
TAH1RM-22	7314150424351	1	470
TAH1RM-24	7314150352234	1	470
TAH1RM-27	7314150424368	1	470
TAH1RM-30	7314150352241	1	470
TAH1RM-32	7314150424375	1	470
TAH1RM-6	7314150424269	1	470
TAH1RM-7	7314150424276	1	470
TAH1RM-8	7314150424283	1	470
TAH1RM-9	7314150424290	1	470
TAH2047-0.8-4	7314150308088	1	476
TAH2047PR-1-2	7314150308095	1	476
TAH2101G-125	7314150344581	1	476
TAH2101G-125C	7314150344598	1	476
TAH2101G-140	7314150307869	1	476
TAH2101G-140C	7314150344611	1	476
TAH2101G-160	7314150307876	1	476
TAH2101G-160C	7314150344635	1	476
TAH2101G-180	7314150345106	1	476
TAH2101G-180C	7314150344666	1	476
TAH21HDG-200	7314150345649	1	477
TAH21HDG-200C	7314150345656	1	477
TAH223G-150	7314150411597	1	477
TAH225-PLUS	7314150319978	1	479
TAH2427G-200	7314150307883	1	477
TAH2430G-160	7314150413942	1	477
TAH2430G-200	7314150307906	1	477
TAH2484-30	7314150307968	1	481
TAH2487	7314150320028	1	483
TAH24B-27	7314150309306	1	473
TAH24B-30	7314150309313	1	473
TAH24B-32	7314150309320	1	473
TAH24B-36	7314150309337	1	473
TAH24B-38	7314150309344	1	473
TAH24B-41	7314150309351	1	473
TAH24B-46	7314150309368	1	473
TAH24B-50	7314150309375	1	473
TAH2509	7314150307753	1	482
TAH2535F2	7314150307784	1	482
TAH2628G-160	7314150307913	1	477
TAH2628G-180	7314150307920	1	477
TAH2628G-200	7314150432363	1	477
TAH2633/S4	7314150415014	1	483
TAH2800-180	7314150424559	1	477
TAH2820EF2	7314150307708	1	479
TAH2855	7314150307937	1	477
TAH2900-180	7314150424566	1	478
TAH2951-250	7314150432400	1	478
TAH2953-140	7314150415731	1	477
TAH2953-300	7314150415748	1	477
TAH2958-200	7314150320219	1	478
TAH2958-250	7314150307944	1	478
TAH2970G-200	7314150343331	1	478



# TAH29M-10



TAH29M-10	7314150414413	1	470
TAH29M-11	7314150414420	1	470
TAH29M-12	7314150424382	1	470
TAH29M-13	7314150414437	1	470
TAH29M-14	7314150424399	1	470
TAH29M-15	7314150424405	1	470
TAH29M-16	7314150424412	1	470
TAH29M-17	7314150414444	1	470
TAH29M-18	7314150424429	1	470
TAH29M-19	7314150424436	1	470
TAH29M-20	7314150424443	1	470
TAH29M-21	7314150414451	1	470
TAH29M-22	7314150424450	1	470
TAH29M-23	7314150424467	1	470
TAH29M-24	7314150424474	1	470
TAH29M-25	7314150424481	1	470
TAH29M-26	7314150424498	1	470
TAH29M-27	7314150424504	1	470
TAH29M-28	7314150424511	1	470
TAH29M-29	7314150424528	1	470
TAH29M-30	7314150424535	1	470
TAH29M-32	7314150424542	1	470
TAH29M-6	7314150414376	1	470
TAH29M-7	7314150414383	1	470
TAH29M-8	7314150414390	1	470
TAH29M-9	7314150414406	1	470
TAH2M-10-11	7314150427772	1	470
TAH2M-12-13	7314150427789	1	470
TAH2M-14-15	7314150427796	1	470
TAH2M-16-17	7314150427802	1	470
TAH2M-18-19	7314150427819	1	470
TAH2M-6-7	7314150427758	1	470
TAH2M-8-9	7314150427765	1	470
TAH317	7314150319985	1	478
TAH320	7314150319992	1	478
TAH325	7314150320004	1	478
TAH3625PU-50	7314150307579	1	480
TAH3625W-35	7314150307609	1	480
TAH3640-250-C	7314150307975	1	481
TAH3681-11	7314150415038	1	481
TAH3681-16	7314150415045	1	481
TAH3681-20	7314150415052	1	481
TAH3683	7314150352258	1	481
TAH3734BM-10	7314150308057	1	481
TAH3734BM-2	7314150343348	1	481
TAH3734BM-3	7314150307982	1	481
TAH3734BM-4	7314150308019	1	481
TAH3734BM-5	7314150308026	1	481
TAH3734BM-6	7314150308033	1	481
TAH3734BM-8	7314150308040	1	481
TAH3739-300	7314150373925	1	481
TAH3755BM-4	7314150308064	1	481
TAH380-10	7314150307845	1	471
TAH380-14	7314150320172	1	471
TAH380-18	7314150307852	1	471
TAH380-24	7314150343317	1	471
TAH396-JT	7314150373932	1	478
TAH420SH-80-160	7314150411610	1	483
TAH440007000	7314150343355	1	481
TAH466-250	7314150307791	1	482
TAH479-16	7314150307586	1	480
TAH479-32	7314150307593	1	480
TAH481-300	7314150307616	1	480
TAH484-1000	7314150373918	1	480
TAH484-1500	7314150307623	1	480
TAH484-2000	7314150319916	1	480
TAH485	7314150459902	1	481
TAH486F-700	7314150370658	1	481
TAH489-1100	7314150307647	1	480
TAH489-1800	7314150343294	1	480
TAH489-2700	7314150319923	1	480
TAH489-3600	7314150307654	1	480
TAH489-4500	7314150427567	1	480
TAH489-5400	7314150319930	1	480
TAH489-6300	7314150427581	1	480
TAH490-1100	7314150427475	1	480
TAH490-700	7314150427529	1	480
TAH490-900	7314150427536	1	480
TAH52	7314150339730	1	480
TAH6950	7314150309054	1	472
TAH6956-1	7314150309061	1	472
TAH6958B-1	7314150309078	1	471
TAH6960	7314150305315	1	471
TAH6961	7314150305322	1	471
TAH6962	7314150305339	1	471
TAH6962L	7314150305346	1	471
TAH6966	7314150305353	1	471
TAH6M-10-11	7314150370665	1	470
TAH6M-12-13	7314150370672	1	470
TAH6M-14-15	7314150400393	1	470
TAH6M-16-17	7314150400409	1	470
TAH6M-17-19	7314150370689	1	470
TAH6M-18-19	7314150400416	1	470
TAH6M-20-22	7314150400423	1	470
TAH6M-24-27	7314150400430	1	470
TAH6M-30-32	7314150400447	1	470



TAH6M-6-7	7314150427741	1	470
TAH6M-8-9	7314150400386	1	470
TAH700-1.5-50	7314150432301	1	474
TAH700-1.8-50	7314150432318	1	474
TAH700-2.5-50	7314150432325	1	474
TAH700-3-100	7314150432332	1	474
TAH701-0-50	7314150432349	1	474
TAH701-00-50	7314150432356	1	474
TAH703-10-50	7314150432288	1	475
TAH703-15-75	7314150432295	1	475
TAH703-6-50	7314150432240	1	475
TAH703-7-50	7314150432257	1	475
TAH703-8-50	7314150432264	1	475
TAH703-9-50	7314150432271	1	475
TAH7435-100	7314150327249	1	483
TAH7444SG-M-36	7314150308934	1	470
TAH7444SG-M-41	7314150308941	1	470
TAH7444SG-M-46	7314150308958	1	470
TAH7444SG-M-50	7314150308965	1	470
TAH7444SG-M-55	7314150308972	1	470
TAH7445-100A-1	7314150327546	1	483
TAH7452-2	7314150302543	1	483
TAH7455-300-1	7314150309412	1	483
TAH782-U	7314150339747	1	480
TAH7852-1	7314150302550	1	483
TAH8069	7314150383603	1	469
TAH8069C	7314150383610	1	469
TAH8070	7314150347025	1	469
TAH8070C	7314150383627	1	469
TAH8071	7314150347032	1	469
TAH8071C	7314150383634	1	469
TAH8072	7314150307487	1	469
TAH8072C	7314150383641	1	469
TAH8073	7314150319831	1	469
TAH8073C	7314150383658	1	469
TAH8074	7314150319848	1	469
TAH8074C	7314150383665	1	469
TAH8075	7314150307500	1	469
TAH8075C	7314150383672	1	469
TAH8150-1/2	7314150309283	1	473
TAH8158B-1	7314150309290	1	472
TAH8160	7314150306367	1	472
TAH8162	7314150306374	1	472
TAH8166	7314150306381	1	472
TAH8224	7314150307951	1	478
TAH84-PODGER	7314150312221	1	469
TAH868700000	7314150374571	1	480
TAH8950N/A	7314150309382	1	474
TAH8953	7314150309399	1	474
TAH8961	7314150309405	1	473
TAH9045-B-250	7314150411634	1	482
TAH9048-250	7314150411627	1	482
TAH9070	7314150307517	1	469
TAH9072	7314150307524	1	469
TAHBE-8020L	7314150308101	1	474
TAHBE-8030	7314150308118	1	474
TAHBE-8040	7314150308125	1	474
TAHBE-8040S	7314150308132	1	475
TAHBE-8050S	7314150308149	1	475
TAHBE-8155	7314150308156	1	474
TAHBE-8220S	7314150308163	1	475
TAHBE-8241	7314150308217	1	474
TAHBE-8252	7314150308224	1	474
TAHBE-8255S	7314150320226	1	475
TAHBE-8257	7314150308231	1	474
TAHBE-8258	7314150308248	1	474
TAHBE-8260	7314150308255	1	474
TAHBE-8350	7314150308262	1	474
TAHBE-8602	7314150308279	1	475
TAHBE-8610	7314150308286	1	474
TAHBE-8610S	7314150308293	1	475
TAHBE-8611	7314150308309	1	474
TAHBE-8620	7314150308316	1	474
TAHBE-8620L	7314150308323	1	474
TAHBE-8620S	7314150308330	1	475
TAHBE-8623	7314150308347	1	474
TAHBE-8624	7314150308354	1	474
TAHBE-8630	7314150308361	1	474
TAHBE-8630S	7314150320233	1	475
TAHBE-8640S	7314150320240	1	475
TAHBE-8810	7314150308378	1	475
TAHBE-8820	7314150308385	1	475
TAHBE-8820SL	7314150347827	1	475
TAHBE-8830	7314150308392	1	475
TAHBE-8880	7314150432196	1	474
TAHBE-8910	7314150343713	1	475
TAHBE-8910S	7314150343799	1	475
TAHBE-8915	7314150343744	1	475
TAHBE-8915S	7314150343805	1	475
TAHBE-8920	7314150343751	1	475
TAHBE-8920S	7314150343812	1	475
TAHBE-8925	7314150343768	1	475
TAHBE-8925S	7314150343829	1	475
TAHBE-8930	7314150343775	1	475
TAHBE-8930S	7314150343836	1	475
TAHBE-9776	7314150432233	1	476



TAHBE-9777B	7314150307685	1	476
TAHBE-9787	7314150307692	1	476
TAHBE64520	7314150307821	1	483
TAHBFRL11	7314150307739	1	484
TAHBOD5400	7314150339457	1	484
TAHBOD5450	7314150339464	1	484
TAHCRW01	7314150432370	1	477
TAHCS300	7314150411603	1	482
TAHLTS-30	7314150432387	1	482
TAHMK5	7314150411580	1	470
TAHPINRELEASER	7314150307838	1	476
TAHSC2RM-13-17	7314150339792	1	473
TAHSC2RM-15-17	7314150339785	1	473
TAHSC2RM-19-22	7314150339761	1	473
TAHSC2RM-27-30	7314150339778	1	473
TAHSCB140G	7314150308071	1	479
TAHSR300-MM	7314150415021	1	482
TAHWBB600	7314150440429	1	481
TAHWBB700	7314150440436	1	481
TAM12135	7314150215331	1	126
TAM12200	7314150215348	1	126
TAM12340	7314150215355	1	126
TAM1430	7314150215317	1	126
TAM38135	7314150215324	1	126
TAS14H007	7314150423187	1	127
TAS14H09	7314150423200	1	127
TAS14S007	7314150423194	1	127
TAS14S09	7314150423217	1	127
TAW12340	7314150274963	1	120
TAW1412M	7314150423156	1	120
TAW1430M	7314150422289	1	120
TAW14340	7314150340842	1	120
TAW24800	7314150368297	1	120
TAW34800	7314150285471	1	120
TAW38135	7314150274956	1	120
TAW912M	7314150423163	1	120
TAW9135	7314150340859	1	120
TAW930M	731415042319	1	120
TAWM12340	7314150274925	1	121
TAWM1412M	7314150423149	1	121
TAWM1430M	7314150422265	1	121
TAWM14340	7314150340835	1	121
TAWM24800	7314150368280	1	121
TAWM34800	7314150274932	1	121
TAWM38135	7314150274918	1	121
TAWM912M	7314150423132	1	121
TAWM9135	7314150340828	1	121
TAWM930M	7314150422241	1	121
TEA003	7314150422180	1	129
TEA010	7314150422197	1	129
TEA030	7314150465781	1	129
TEA065	7314150472246	1	129
TEA1100	7314150423170	1	129
TEA2100	7314150465972	1	129
TEA350	7314150422210	1	129
TL 0-SA	7314150109593	1	640
TL 00-SA	7314150109579	1	640
TL 00-SA-ET	7311518279219	1	639
TL 00-SA-SL	7314150115228	5	642
TL 00B-SA	7314150109555	1	640
TL 00CFR-SA	7314150115402	1	644
TL 00D-SA	7314150109562	1	640
TL 009-SA	7314150109586	1	640
TL 1-SA	7314150109647	1	640
TL 1-SA-SL	7314150115235	5	642
TL 10G-SA	7314150109609	1	640
TL 124-SA	7314150110018	1	643
TL 15AP	7314150109630	1	640
TL 2-SA	7314150110117	1	640
TL 2-SA-SL	7314150115242	5	642
TL 231-SA	7314150110087	1	643
TL 249 ACF	7314150115174	1	644
TL 249CFR-SA	7314150115143	1	644
TL 259 ACF	7314150115167	1	644
TL 259 CFR-SA	7314150115150	1	644
TL 269CF-SA	7314150110735	1	644
TL 2A ACF	7314150115457	1	644
TL 2A-SA	7314150110100	1	640
TL 2A-SA-SL	7314150115259	5	642
TL 2AB-SA	7314150110094	1	640
TL 2ACFR-SA	7314150115419	1	644
TL 2AX-SA	7314150110025	1	642
TL 3-SA	7314150110162	1	641
TL 3-SA-ET	7311518279356	1	639
TL 3-SA-SL	7314150115266	5	642
TL 3C-SA	7314150110148	1	640
TL 3C-SA-SL	7314150115273	5	642
TL 3C-TA	7314150110155	1	641
TL 4-SA	7314150110186	1	641
TL 4-SA-SL	7314150115280	5	642
TL 475-SA	7314150110032	1	643
TL 5-SA	7314150110247	1	641
TL 5-SA-SL	7314150115297	5	642
TL 5-TA	7314150110254	1	641
TL 51S-SA	7314150110209	1	641
TL 577-SA	7314150110421	1	643



TL 578-SA	7314150110438	1	643
TL 582-SA	7314150110452	1	643
TL 5A-SA	7314150110216	1	641
TL 5A-SA-SL	7314150115303	5	642
TL 5ACF	7314150115464	1	645
TL 5B-SA	7314150110223	1	641
TL 5CFR-SA	7314150115426	1	644
TL 648-SA	7314150110049	1	643
TL 649-SA	7314150110063	1	643
TL 65A-SA	7314150110278	1	641
TL 7-SA	7314150110292	1	641
TL 7-SA-SL	7314150115310	5	642
TL 7A-SA	7314150110285	1	641
TL 7A-SA-SL	7314150115327	5	642
TL 7ACF	7314150115471	1	645
TL 7CFR-SA	7314150115433	1	644
TL AA-S	7314150110544	1	644
TL AA-SA	7314150110551	1	644
TL AA-SA-SL	7314150115334	5	643
TL AC-SA-SL	7314150115341	5	643
TL MM-SA-SL	7314150115365	5	643
TL SM 103-SA	7314150110773	1	645
TL SM 104-SA	7314150110780	1	645
TL SM 105-SA	7314150110797	1	645
TL SM 107-SA	7314150110810	1	645
TL SM 108-SA	7314150110827	1	645
TL SM 109-SA	7314150110834	1	645
TL SM 110-SA	7314150110841	1	645
TL SM 111-SA	7314150110858	1	645
TL SM 115-SA	7314150110896	1	645
TL SM 117-SA	7314150110919	1	645
TL SS-SA	7314150109937	1	641
TL SS-SA-SL	7314150115358	5	643
TRX 8180	7314150112272	1	639
TSS120	7314150347063	1	127
TSS600	7314150346417	1	127
W-S-1.5	7311518140816	4	596
W-S-2.0	7311518140823	4	596
W-S-2.5	7311518140830	4	596
W-T-2.0	7311518140847	4	596
WBB1000	7314150431502	4	606
WBB1200	7314150431519	4	606
WBB1500	7314150431526	1	606
WBB400	7314150315215	10	606
WBB500	7314150315222	10	606
WBB600	7314150315239	10	606
WBB700	7314150315246	6	606
WBB800	7314150340972	6	606
WBF380	7314150315253	12	606
WBMF190	7314150315260	24	606
WBP-3P-3FMM	7314150444335	1	606
WBP-3P-6FMM	7314150453115	1	607
WBP-3P-963	7314150444328	1	607
WBP-3P-96F	7314150453108	1	607
WBP300	7314150315161	20	606
WBP500	7314150315178	12	606
WBP625	7314150315185	12	606
WBP710	7314150315192	10	606
WBP900	7314150315208	6	606
WC-HOL	7314150333158	1	569
WPCU2S	7314150422517	1	136
WPTC-100	7314150422487	1	136
WPTC-15	7314150422456	1	136
WPTC-200	7314150422494	1	136
WPTC-25	7314150422463	1	136
WPTC-300	7314150422500	1	136
WPTC-5	7314150422449	1	136
WPTC-60	7314150422470	1	136
WPTC-AT	7314150440221	1	136
WR1	7314150167425	50	541
WR1-MM	7314150220069	50	541
WR2	7314150167432	25	541
WR2-12	7314150185627	25	541
WR2-MM	7314150220038	25	541
XLARGE	7314150437412	1	420
ZHVIDEOBAT	8414909180244	1	350
ZHVIDEOCHA	8414909180237	1	350











# Indications

## Argentina

A.M. de Justo 1750 3° A  
C1107AFJ - Capital Federal  
Buenos Aires  
Tel : +54 (11) 4313-1004  
Fax : +54 (11) 4893-3553

## Australia

SNA E Australia  
43 Enterprise Circuit  
Prestons NSW 2170  
Tel: +61 (0) 2 8738 1400  
Fax: +61 (0) 2 8783 0684

## Беларусь

220075, Минск,  
ул. Селицкого, 8а  
Tel.: +375 17 389 79 00  
Fax: +375 17 389 79 51

## Belgium

SNA Tools Belgium BVBA  
De Kleetlaan 12A Pegasus Park  
1831 DIEGEM  
Tel: +32 (0)2 726 03 03  
Fax: +32 (0)2 726 04 36

## Chile

Av. Americo Vespuccio 2760-D  
Conchali - Santiago - Chile  
Tel.: + 56 2 623 0203  
Fax.: + 56 2 623 5395

## Česká republika

SNA Europe [Czech republic] s.r.o.  
Holadnská 2/4  
639 00 Brno  
Tel.: +420 537 022 520  
Fax: +420 537 022 200

## Danmark

Vallensbækvej 40,  
2605 Brøndby  
Tel: +45 4363 0330  
Fax: +45 4396 2456

## Deutschland

Willetstraße 10  
40822 Mettmann  
Tel: +49 (0) 2104 8 33 83 0  
Fax: +49 (0) 2104 833 83 79 99

## España

c/ Hilanderas, 1  
(P.O. Box / Apdo de Correos nº 5)  
C.P. 20303 Irún  
Tel: +34 902 235 100 / +34 943 649 111  
Fax: +34 943 649 120

## Ελλάδα

Λ. Βουλιαγμένης 604Γ  
167 77 Ελληνικό, Αθήνα  
Τηλ: +30 210 9914263  
Fax: +30 210 9914587

## France

ZAC de l'Hoire  
20 rue Charles Lacretelle  
CS 60101  
49072 Beaucouzé cedex  
Tél: +33 (0) 2 41 22 98 40  
Fax: +33 (0) 2 41 22 98 50

## International Sales Group

Antigua Carretera de Altube Km 5,5  
P.O.Box 307  
01080 VITORIA (Spain)  
Tel.: +34 945269711  
Fax: +34 945165040

## Italia

Via Villapizzone 26  
20156 Milano  
Tel: +39 02 302 416 1  
info.it@snaeurope.com

## Казахстан

050000, Алматы,  
ул. Шевченко 1656/72г, оф. 217  
Тел/факс : +7 727 323 63 39

## Nederland

SNA Europe [Benelux] BV  
Vossenbeemd 113  
5705 CL Helmond  
Tel: +31 (0) 492 58 23 82  
Fax: +31(0) 492 58 23 20

## New Zealand

Unit 3/25 Highbrook Drive  
East Tamaki  
Auckland  
Tel: +64 9-273 46 50  
Fax: + 64-9-273-2453

## Norge

Postboks 800  
1306 Sandvika  
Tel: +47 40 49 66 00  
info.no@snaeurope.com

## Österreich

Vienna, Nineteen  
Mooslackengasse 17  
A-1190 Wien  
Tel: +49 (0) 2104 8 33 83 0  
Fax +49 (0) 2104 833 83 79 99

## Polska

ul. Marynarska 15  
02-674 Warszawa  
Tel.: +48 (0) 22 6070510  
Fax.: +48 (0) 22 6070521

## Российская Федерация

141407, Московская область, г.  
Химки, ул.Панфилова, вл.21, стр.1  
Тел: +7(495) 2215851  
Факс: +7(495) 2215851 (доб.3413)

## Portugal

SNA Europe [Industries] LDA  
R. Maria Julia M. Ramos - Junqueira  
4480-254 Vila Do Conde  
Tel. +351 252 650 131  
Fax. +351 252 650 160

## Slovenská republika

SNA Europe s.r.o.  
Karadžičova 8/A  
821 08 Bratislava  
Tel.: +421 (0)2 5939 6124  
Fax: +421 (0)2 5939 6217

## Suomi

SNA Europe (Finland) Oy  
PL 6580  
00002 HELSINKI  
Tel: +358 207 433 510  
Fax: +358 207 433 525

## Sverige

Box 83  
SE-745 22 Enköping  
Tel: +46 (0) 171-47 82 00  
Fax: +46 (0) 171-47 82 38

## Schweiz / Suisse

Willetstraße 10  
D-40822 Mettmann  
Deutschland  
Tel: +49 (0) 2104 8 33 83 0  
Fax +49 (0) 2104 833 83 79 99

## Türkiye

Girne Mah. Maltepe Küçük San. Sitesi  
F Blok No:19 Maltepe  
Istanbul  
Tel: +90 (0) 216 367 10 21  
Fax: +90 (0) 216 367 11 71

## Україна

Україна, 02140, м. Київ  
вул. Єлизавети Чавдар, 9, офіс «А»  
Tel: +38 044 220 45 58  
Fax: +38 044 220 45 58

## United Kingdom

Moorhead Way, Bramley,  
Rotherham, South Yorkshire S66 1YY  
Tel: +44 (0) 1709 731731  
Fax: +44 (0) 1709 731741



## Catalogue 2021: Garantie des produits

1. Tous les outils à main sont garantis à vie ; une garantie contre les défauts/vices de matériaux sur la durée de vie normale de l'outil en question. La durée de vie est définie comme l'espace de temps durant lequel un outil peut être utilisé dans le cadre d'un usage normal et dans de bonnes conditions.

2. Les gammes d'outils de mesure, outils électriques et pneumatiques SNA Europe sont à exclure du premier paragraphe. Chacune de ces gammes possède une carte de garantie distincte fournie avec le produit et couvrant des conditions de garanties spécifiques. Les produits sont conçus et fabriqués pour un usage professionnel. La période de garantie est d'un an (12 mois) pour l'usage professionnel et de deux ans (24 mois) pour l'usage privé. La période de garantie débute à la date d'achat. Cette date peut être vérifiée grâce à la facture ou tout autre document ayant une valeur légale.

3. Les produits défectueux seront réparés, remplacés ou échangés. SNA Europe ne prend pas en charge les frais de transports pour les produits réparés, remplacés, ou échangés.

4. Tout produit ayant été mal utilisé et/ou entretenu ou ayant été soumis à un usage inapproprié ou encore ayant subi des modifications non autorisées, n'est pas couvert par la garantie.

5. Une réclamation de garantie doit être présentée dans la période de garantie. Ce qui exige la soumission ou l'expédition de l'outil complet en question avec la vérification des documents de vente, qui doit valider la date d'achat et la désignation du produit, auprès du détaillant ou du distributeur.

6. Le remplacement ou la réparation du produit devra être effectué dans les plus brefs délais. A réception du produit remplacé ou réparé, le client est appelé à valider la conformité. Les remplacements et réparations effectués sous garantie n'entraînent pas le prolongement ou le renouvellement de la période de garantie de l'outil.

**SNA Europe**



Le présent catalogue contient un assortiment de nos produits actuels.  
Les changements apportés à cet assortiment de produits, ainsi qu'à leur forme,  
conception et désignation finale ont lieu constamment.  
Nous ne publierons pas automatiquement des informations propres à ce genre  
de changements.

Nous avons tenu à reproduire les illustrations et les dessins avec le plus d'exactitude possible.  
Toutefois, pour les besoins du catalogue, il se peut qu'il subsiste une différence par rapport aux  
produits concernés, ainsi qu'à leurs caractéristiques techniques.

Les indications des poids doivent s'entendre comme des poids nets approximatifs,  
et servent uniquement à faciliter les calculs du fret et des frais postaux.

Ce catalogue prime sur toute autre liste de caractéristiques techniques et d'assortiments.

La propriété intellectuelle figurant dans ce catalogue est la propriété de SNA Europe.

Tout extrait, réimpression ou copie de son contenu peut avoir lieu avec notre permission.

# 2021





# B A H C O

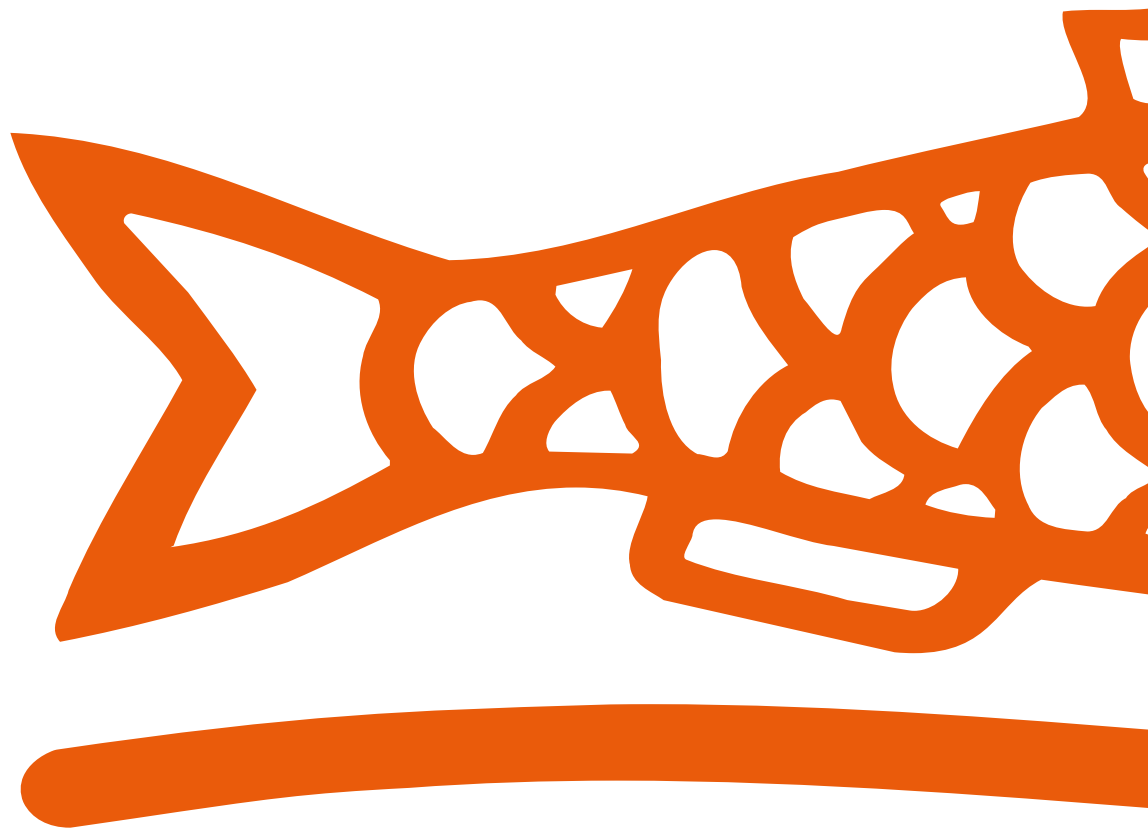

M-FRE-CAT-21



7 314150 478590

Suivez-nous:



[www.bahco.com](http://www.bahco.com)

